

12528

COOL MACHINES

K'NEX®

BAJA

DESERT RACER

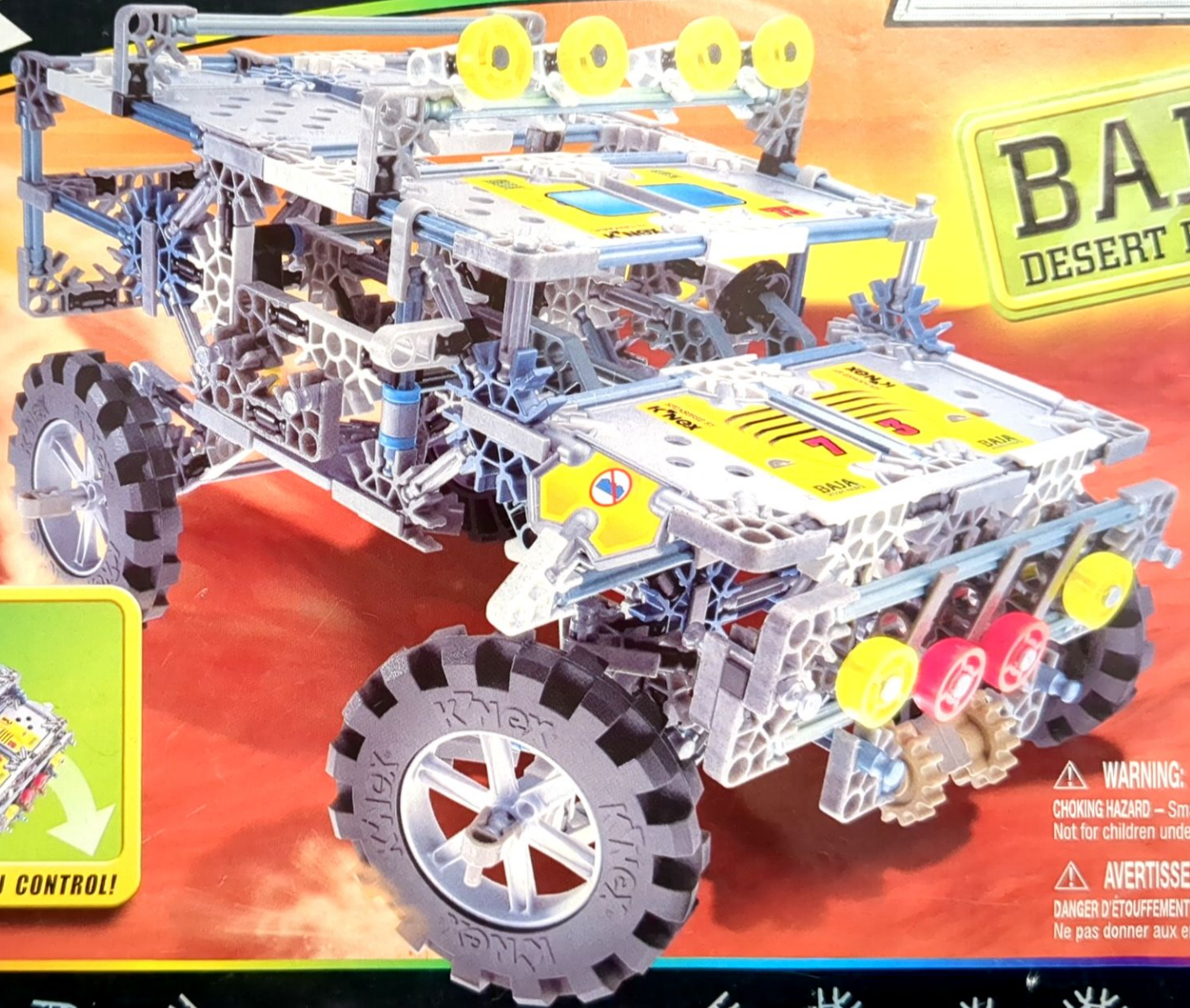

TOUGH SUSPENSION!



STEERING YOU CONTROL!



WARNING:
 CHOKING HAZARD - Small Parts.
 Not for children under 3 years.

AVERTISSEMENT:
 DANGER D'ÉTOUFFEMENT - Pièces de petite taille.
 Ne pas donner aux enfants de moins de 3 ans.

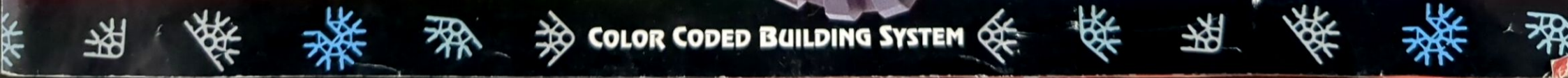

COLOR CODED BUILDING SYSTEM

BAJA DESERT RACER

CONTENTS

Welcome	2
Building with K'NEX	3
Parts Checklist	4
Other Cool Machines	4
Building Instructions:	
BAJA	5
SAHARA	16
RAIDER	26
Sticker Placement	38
French Language	38

Welcome to the real automotive sport of Baja Racing! Baja racing (that's pronounced "Ba-Ha") is a grueling desert race where drivers and their souped-up trucks sprint around mountains, over huge boulders and through shallow desert creeks in a fight to the finish line!

With this set you can build 3 tough "Baja-style" racing trucks that can tackle any terrain you push 'em through! Each one features tough suspension and a steerin' stick that let's you steer clear of rough terrain!



Just follow these simple directions to build the model of your choice, and then create an obstacle course using pillows, books, and anything else you can get your hands on. Now try pushin' and steerin' your model through the course... You can do it!

Building with K'NEX

1



Hi! I'm your K'NEX mechanic. When you see me in the instructions, you'll want to pay close attention to the details being pointed out.

Movin' On

The faded colors tell you this section is already built. You'll want to connect the new section to the place where the arrows are pointing. This piece will be in full color.

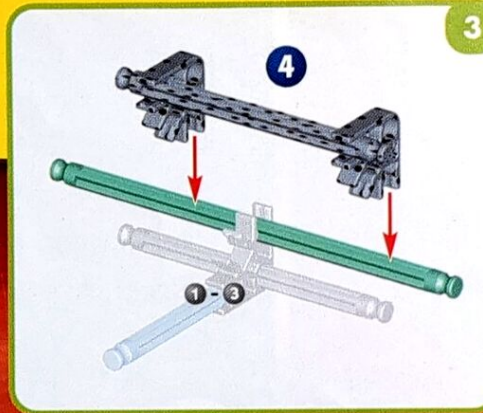

Ready, Set, Build

To begin your model, find the  and follow the numbers. Each piece has its own shape and color. Just look at the picture, find the pieces in your set that match what you see, and snap them together. Try to hold your model in the same direction as in the picture so you'll attach your pieces to the right place.

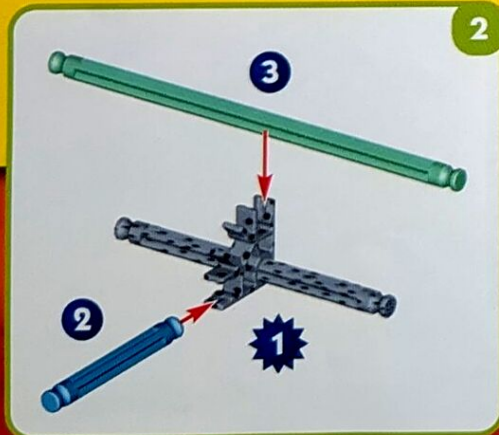

Spacers

There are places in your model where you need to add blue and silver Spacers. Be sure to use the right color and count them carefully.

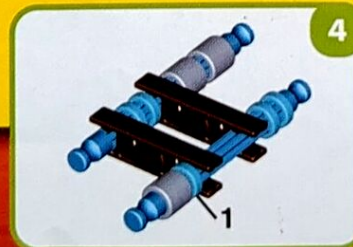

Shocks

K'NEX Shock Absorbers come in two pieces. Push them together until you hear a "click".



Connectors

There are blue and silver Connectors with special long slots. They slide together as you see in the pictures. Push the parts together until you hear a "click".

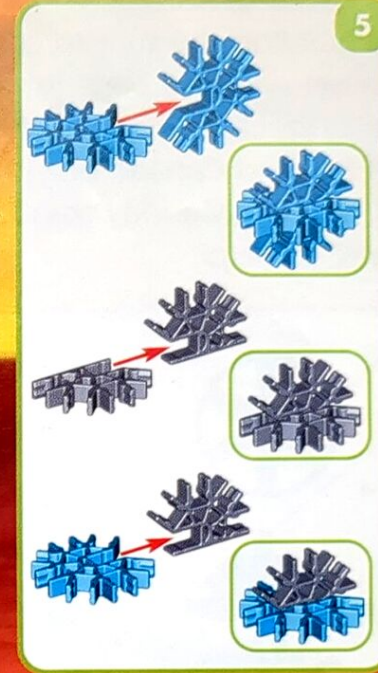

PARTS CHECKLIST

Before you start building, be sure to compare the parts in your set with the parts listed below. If anything is missing, call our Kid K'NEX hotline: 1-800-KID-KNEX (US and Canada only) from 8:30 am to 5:00 pm EST, Monday through Friday. Call us, we're here to help!

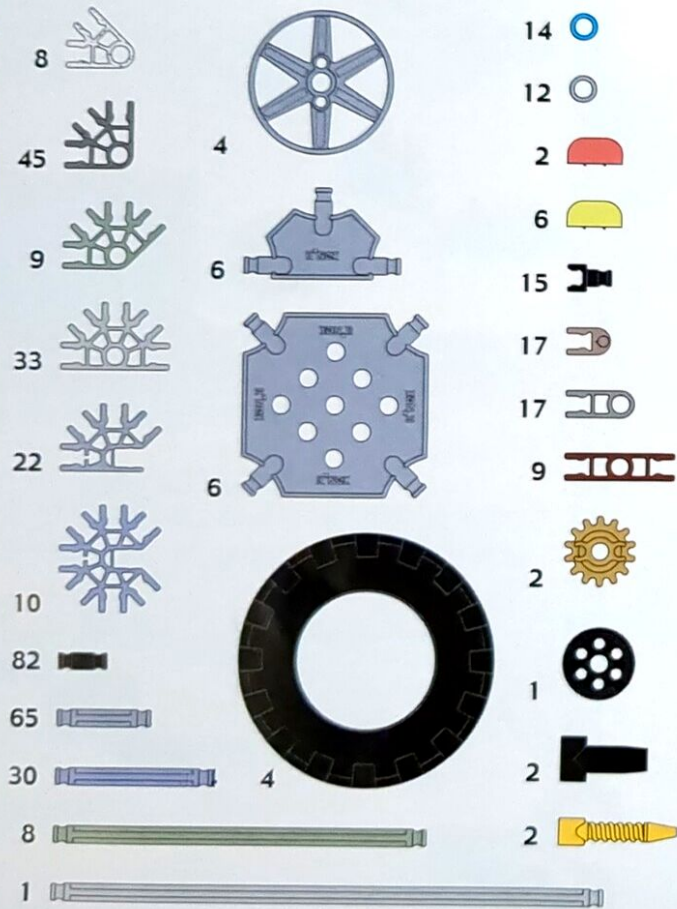

Check out these other



SPIRIT OF AMERICA

Build sleek replicas of Craig Breedlove's "Spirit of America" jet-powered cars! Comes with a Pull-out Poster included inside!



FORMULA RACERS

Build an awesome replica of a Formula-one racecar! With track hugging tires, rack and pinion steering, and piston poppin' engine, Formula Racers is ready to put the pedal to the metal!

Baja

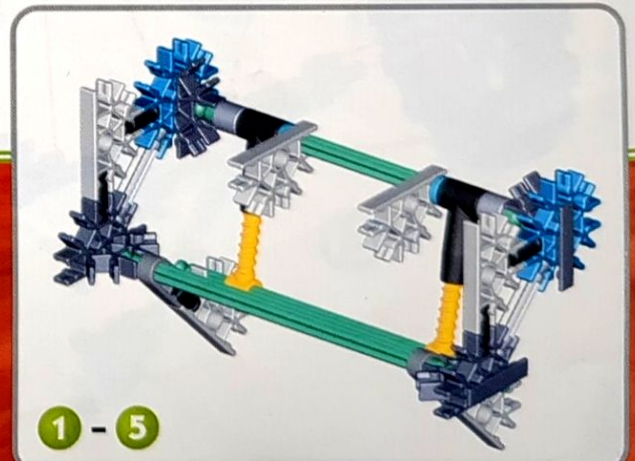
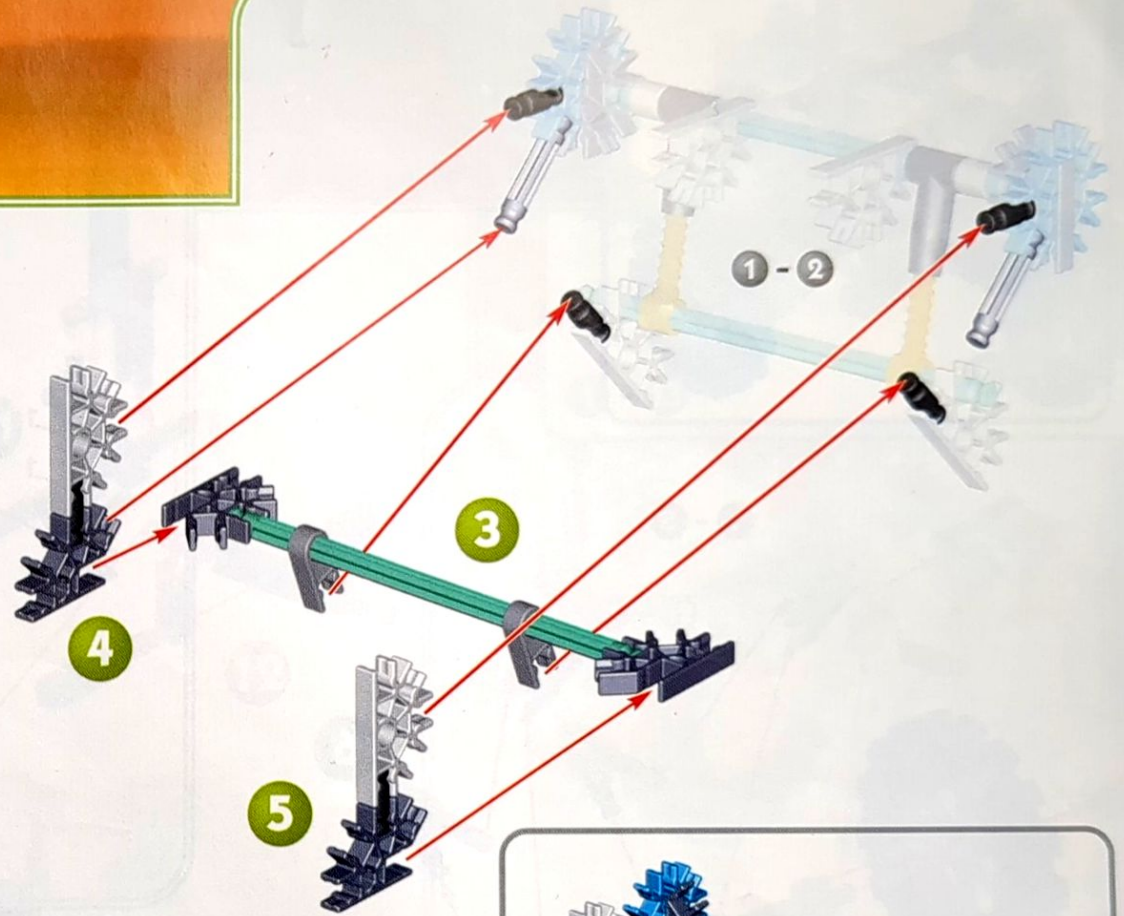
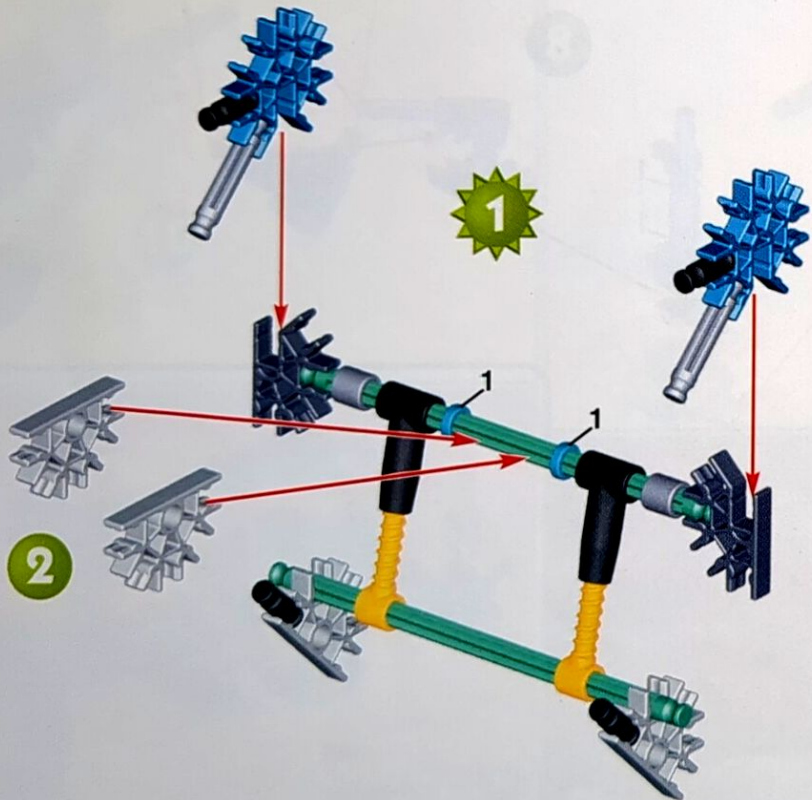
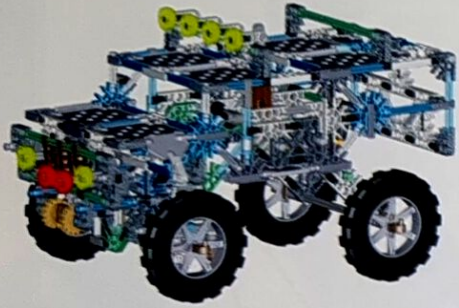

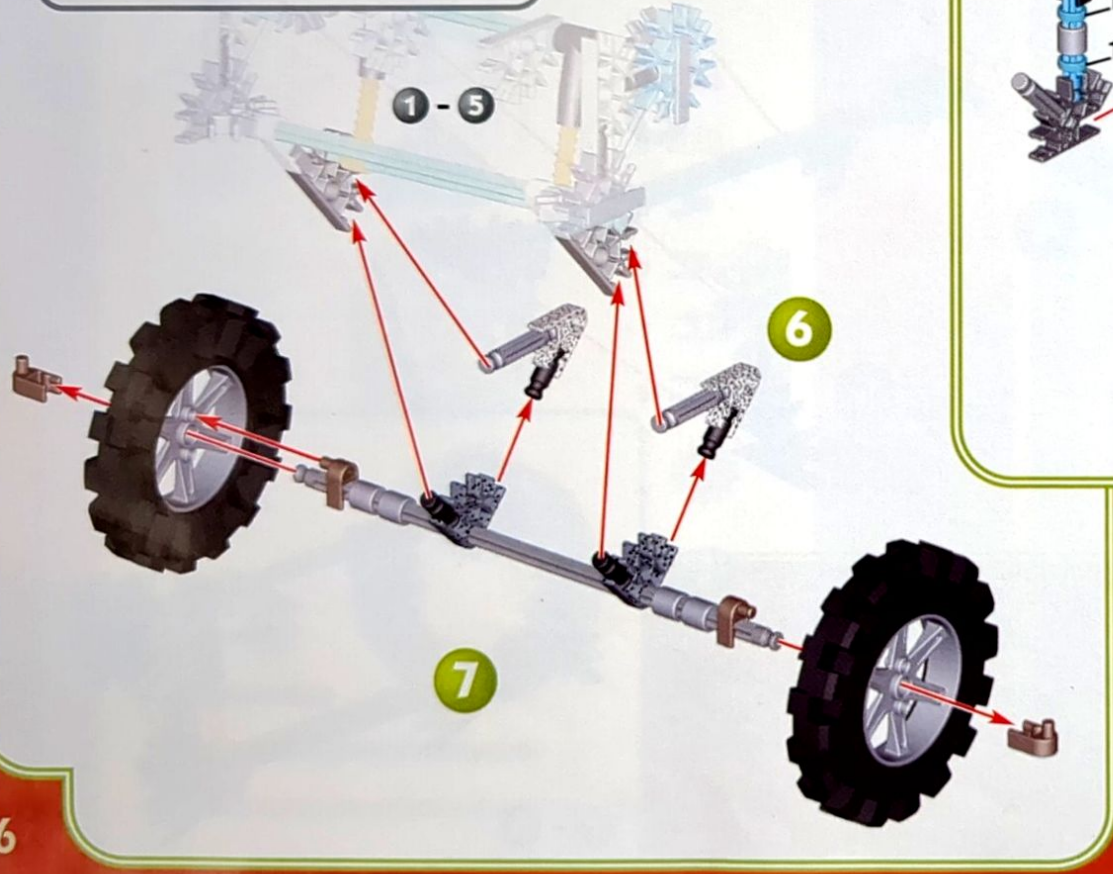
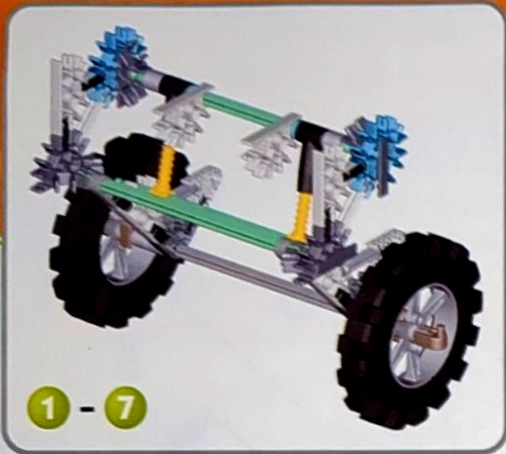

6

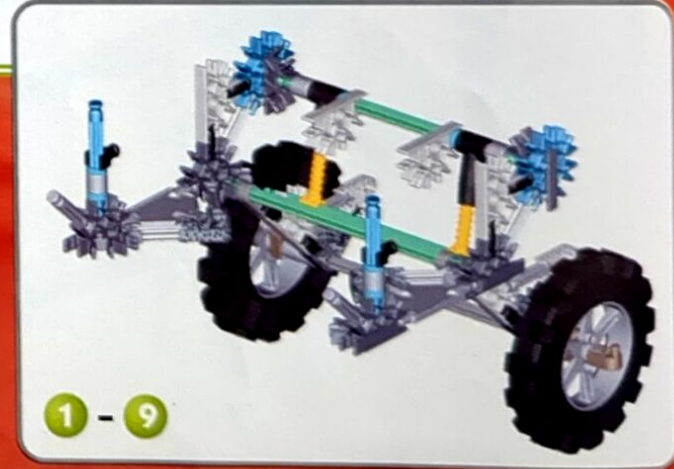
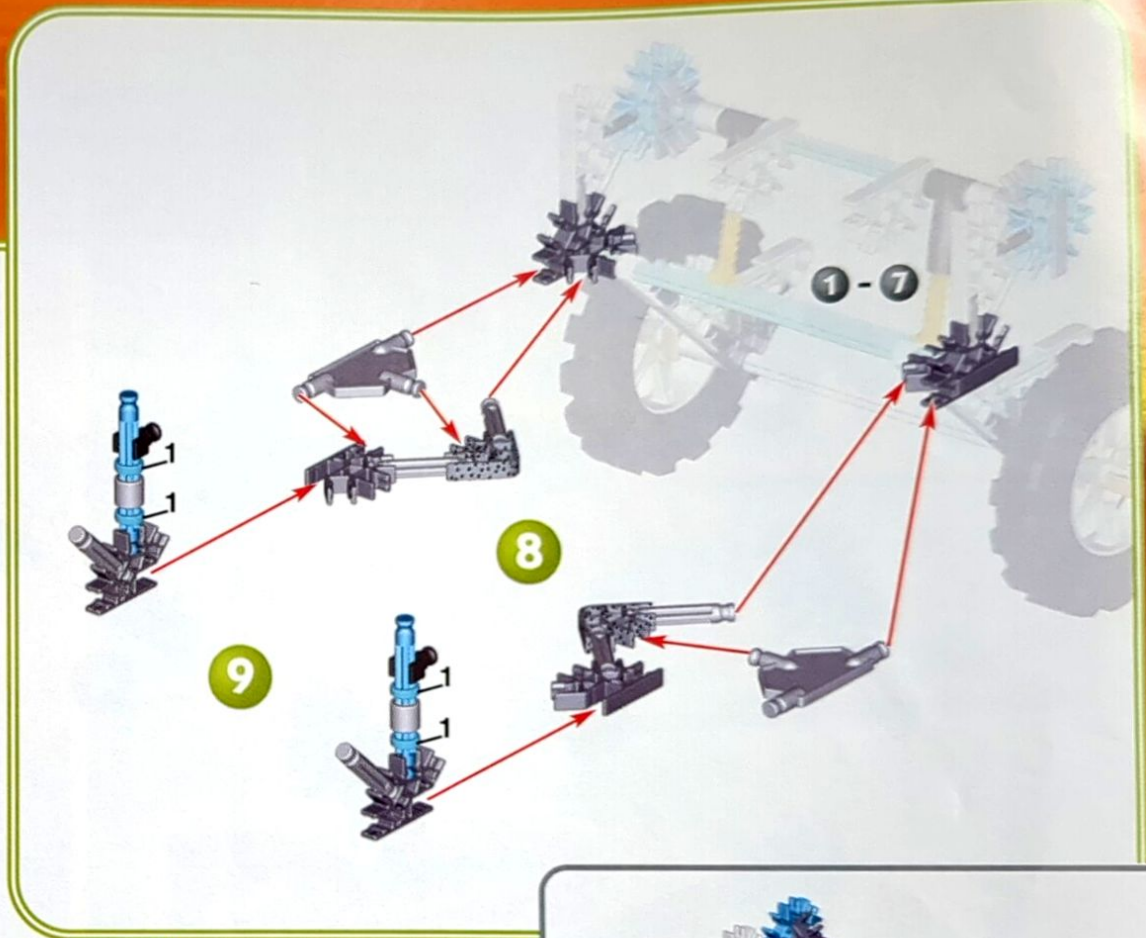

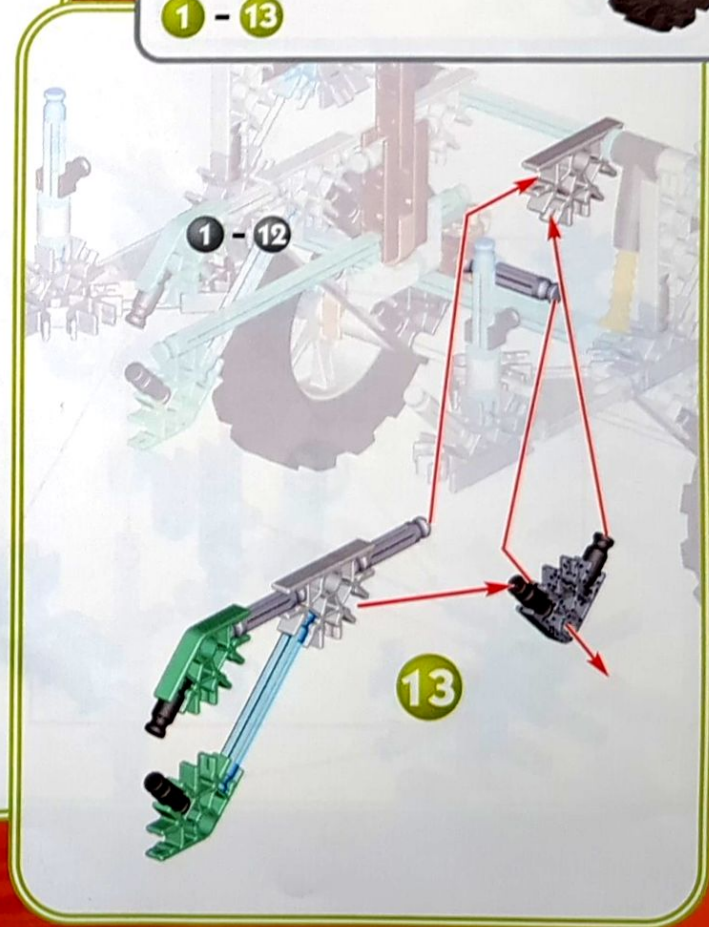
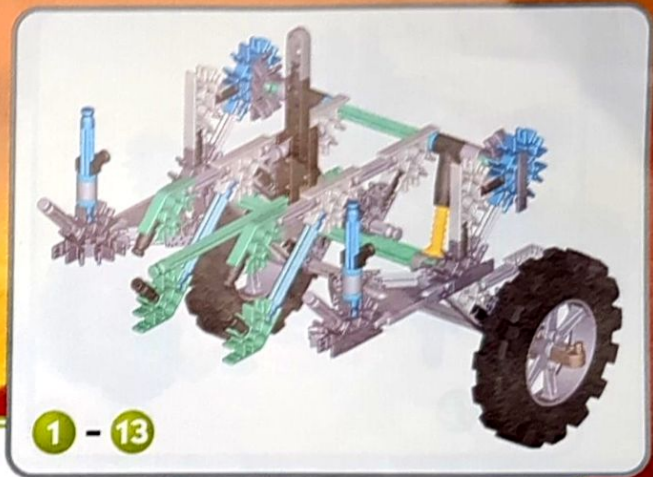
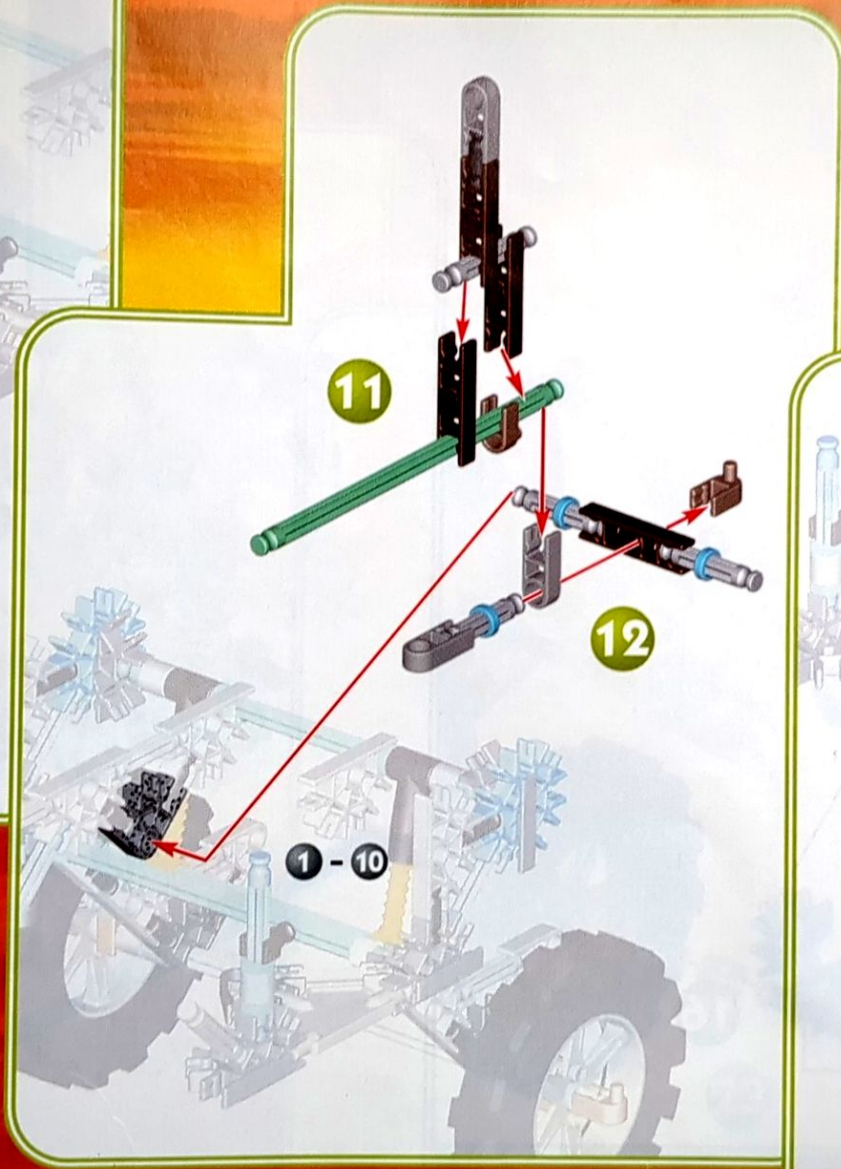
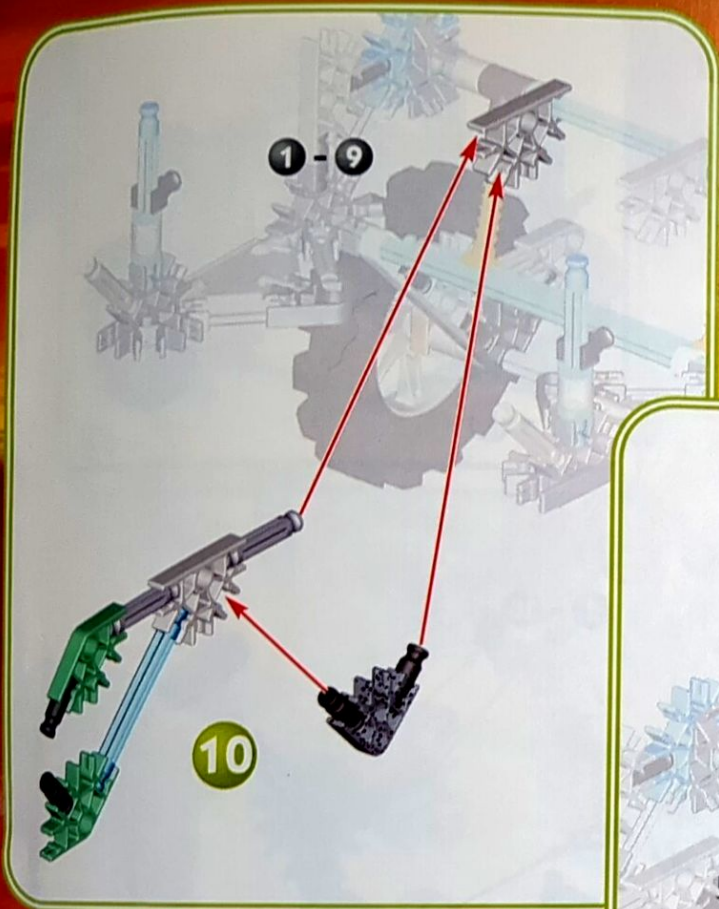

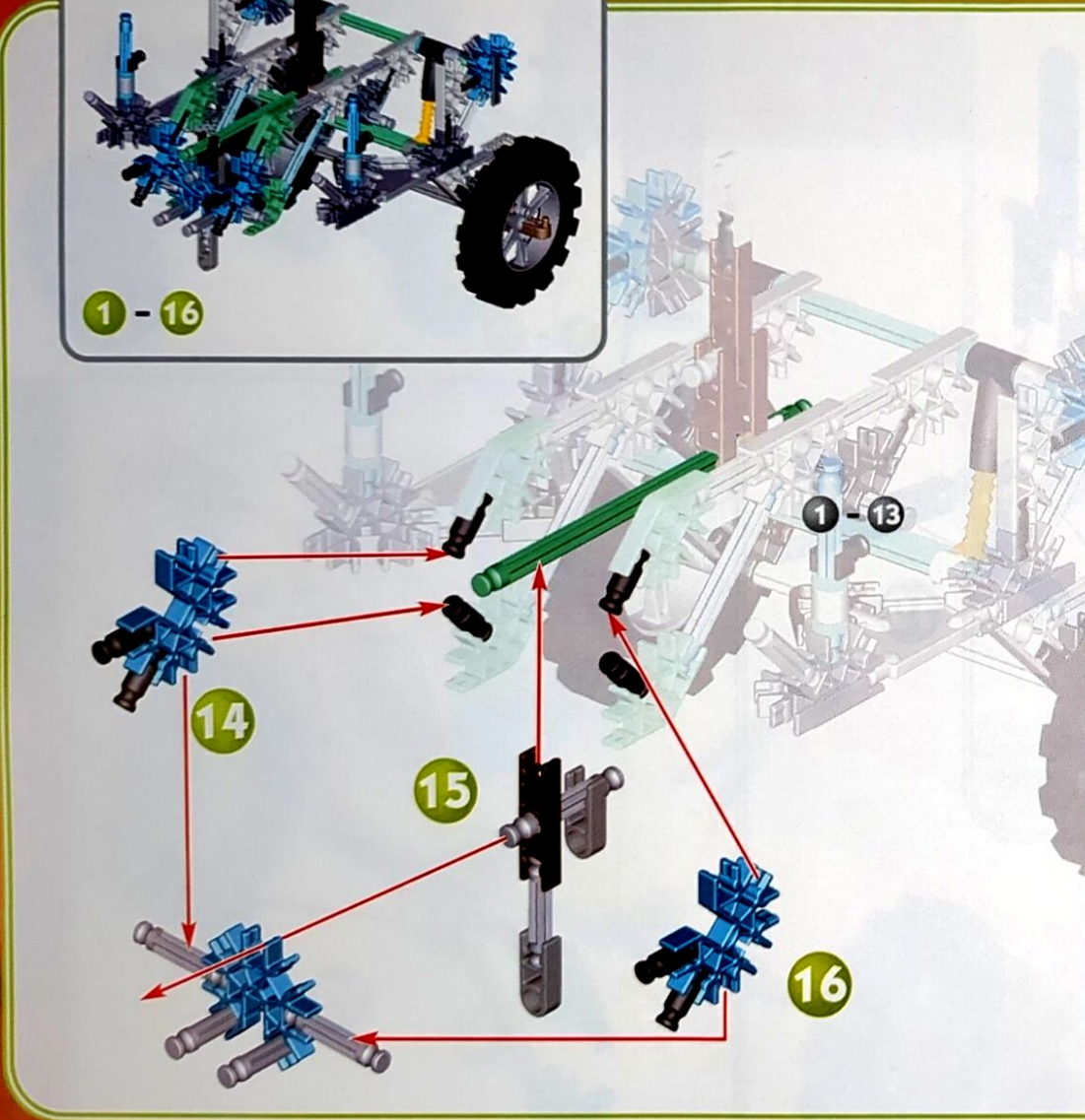
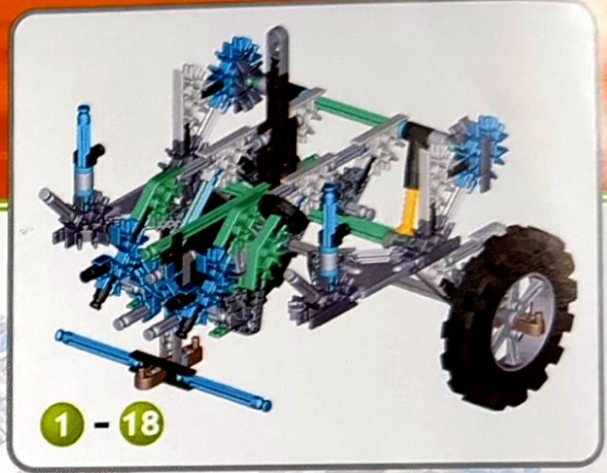

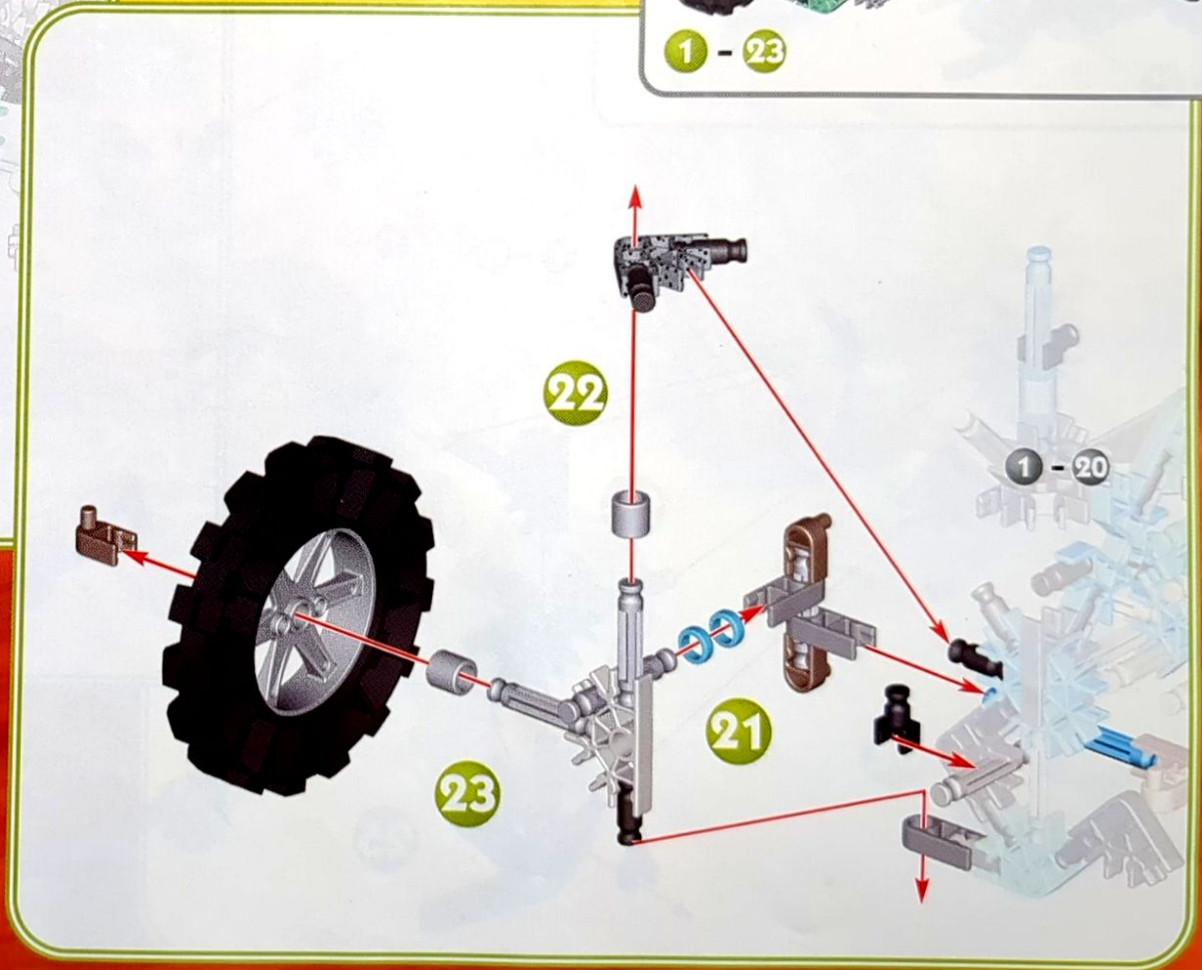
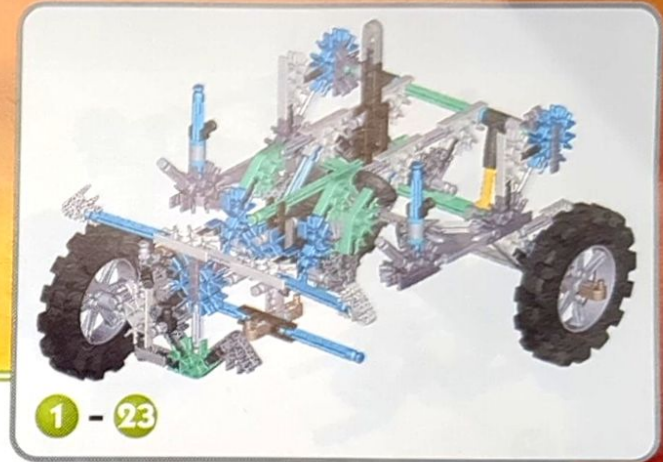
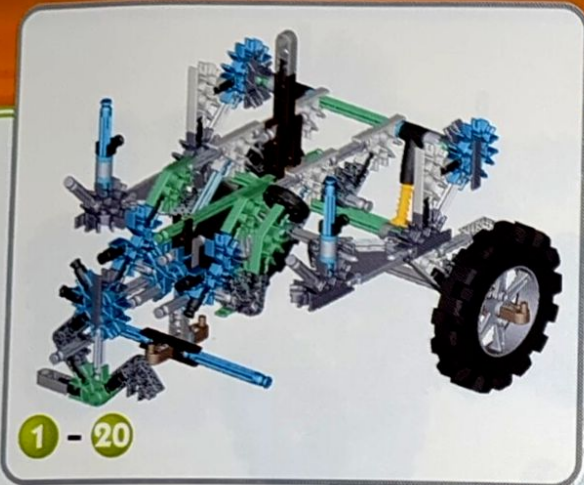

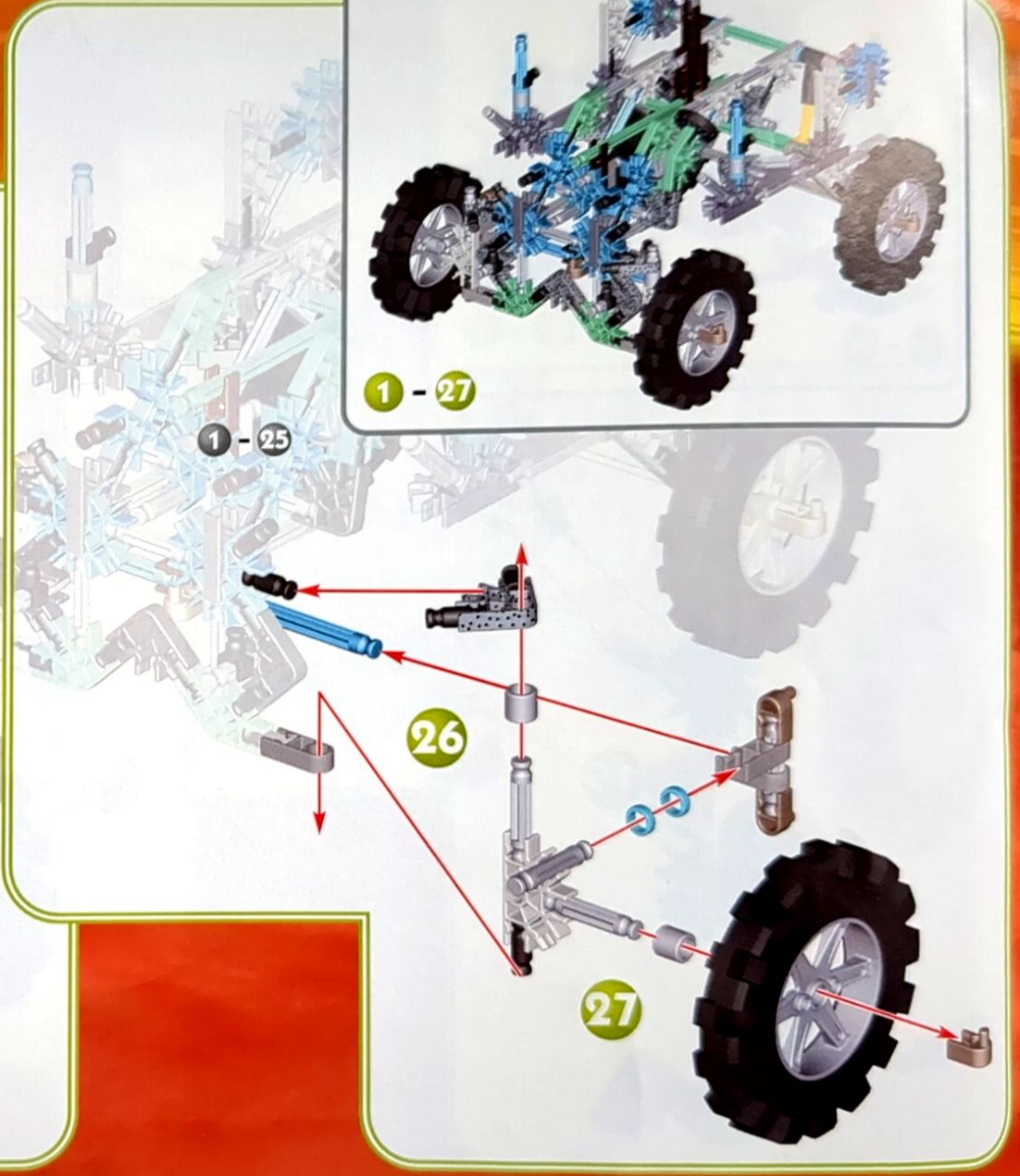
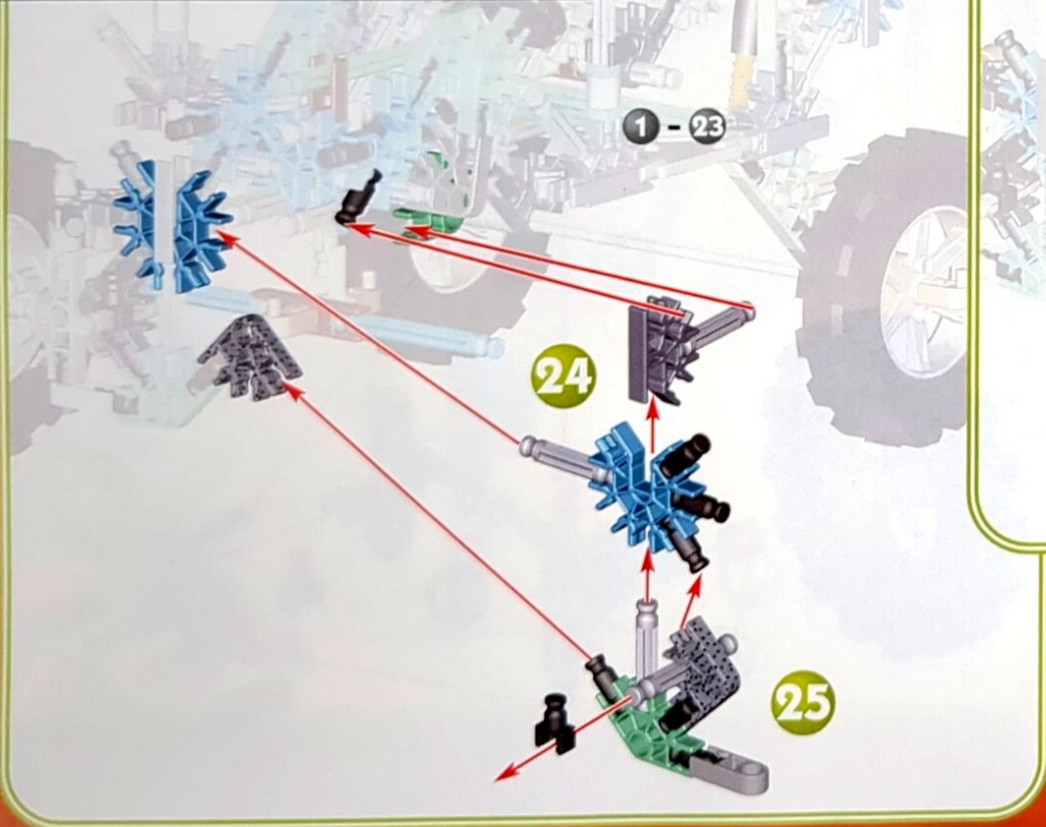
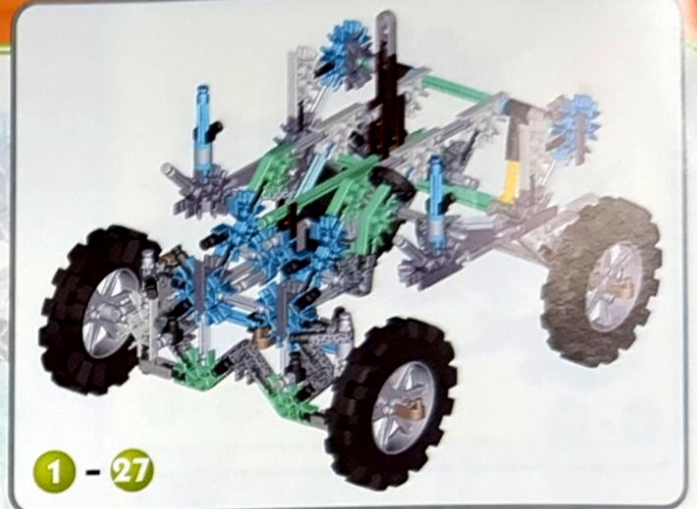
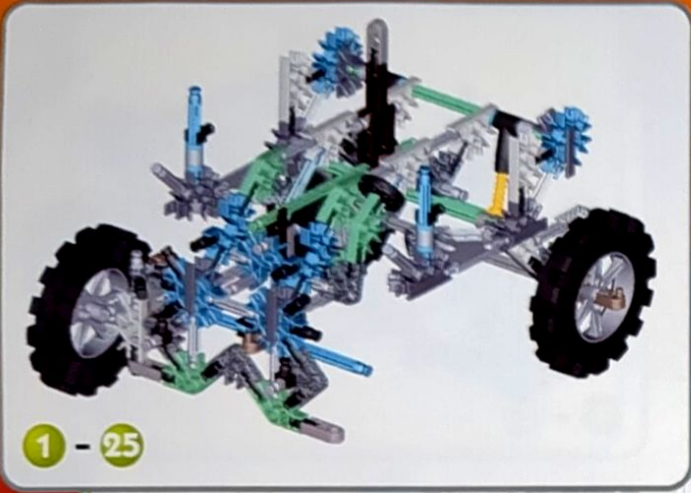

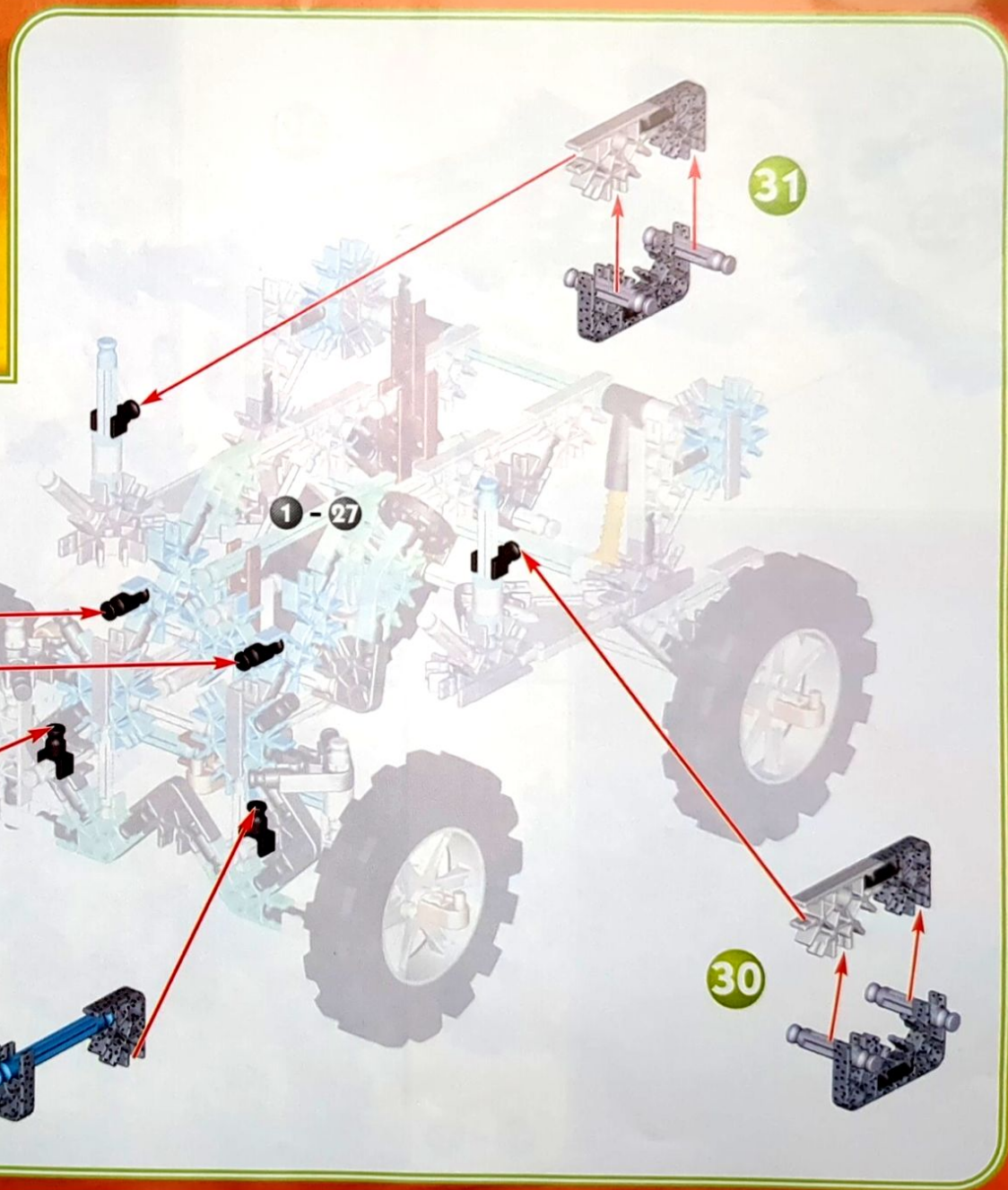

29

28

30

31

1 - 27

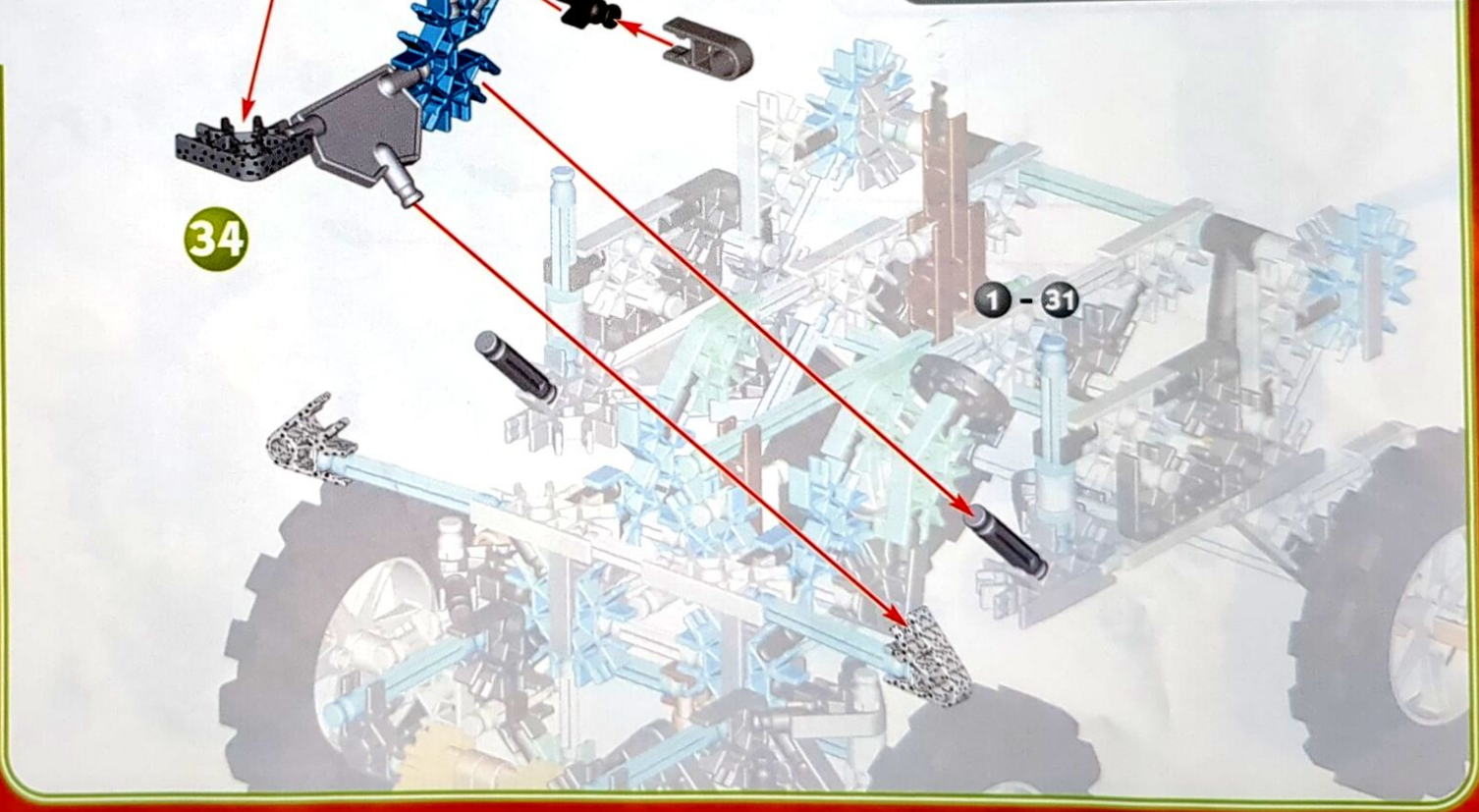
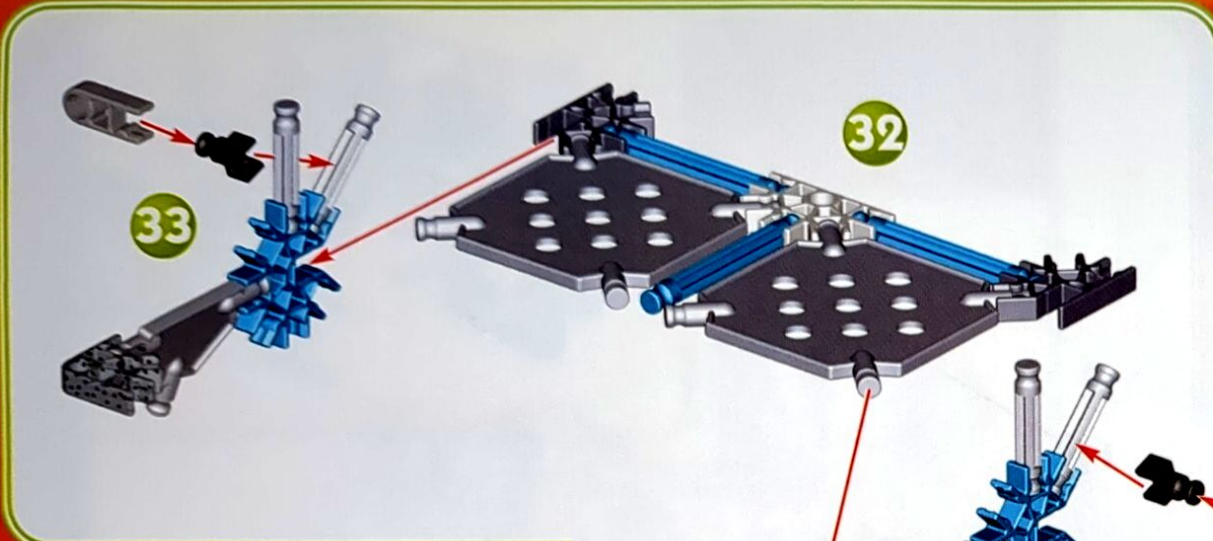



35

1 - 34

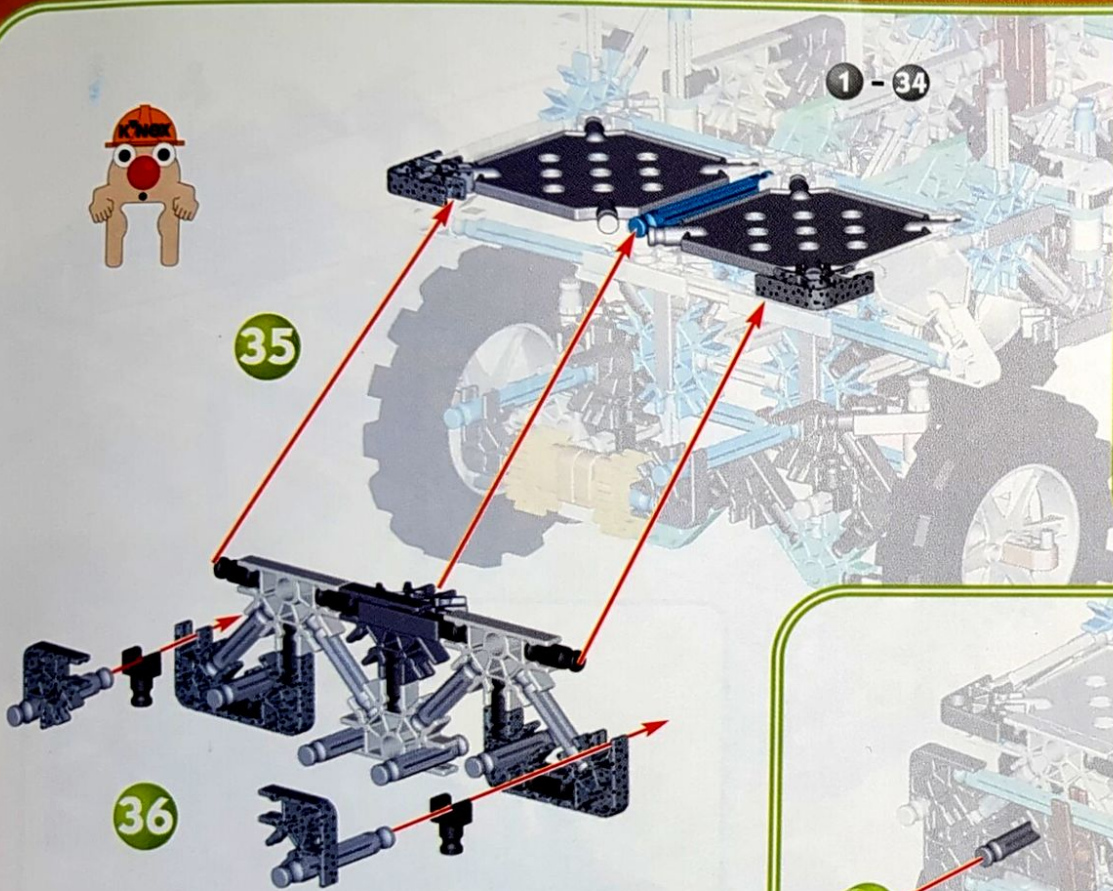

36

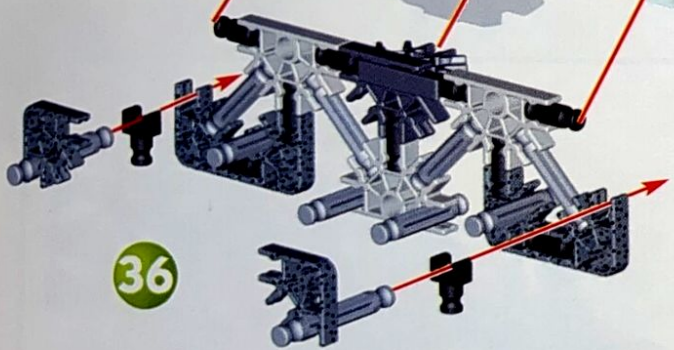

1 - 36

37

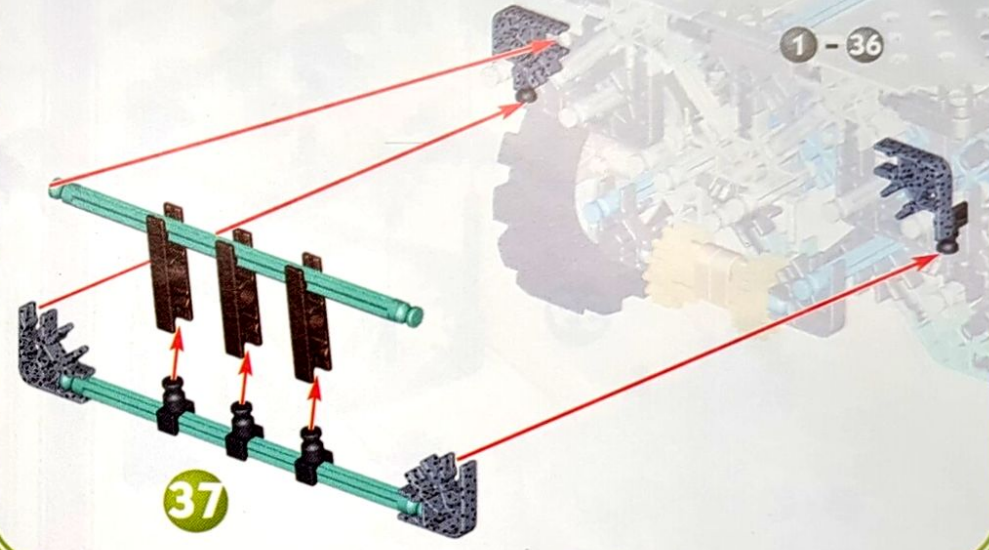

1 - 37

38

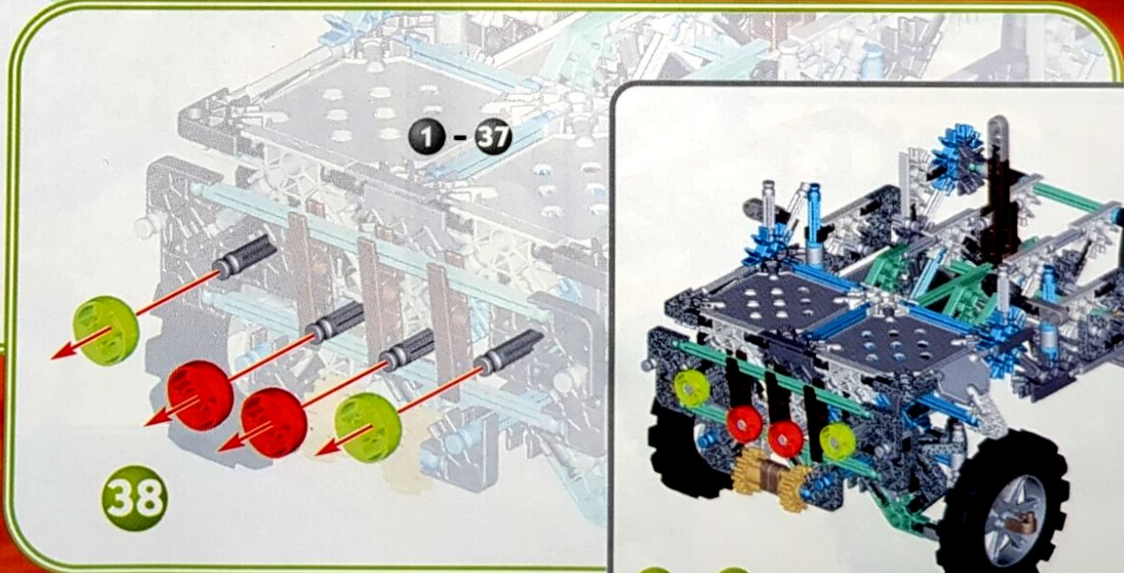

1 - 38



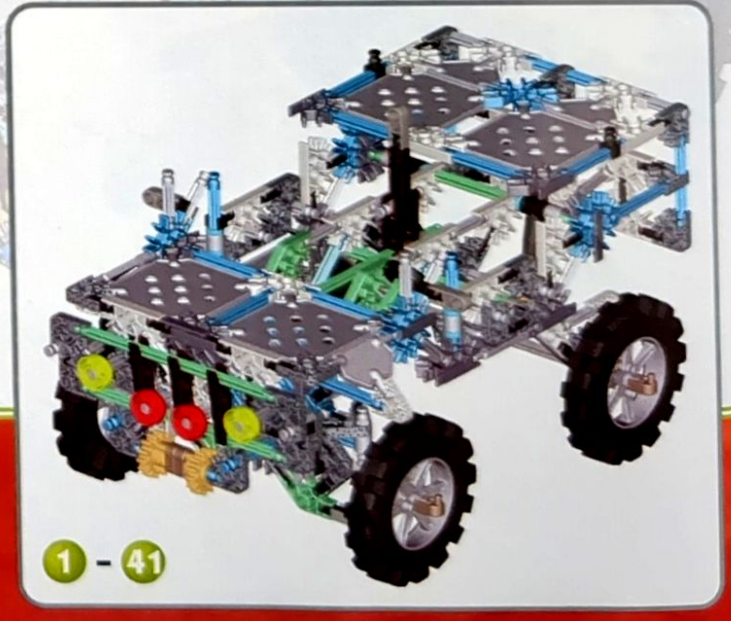
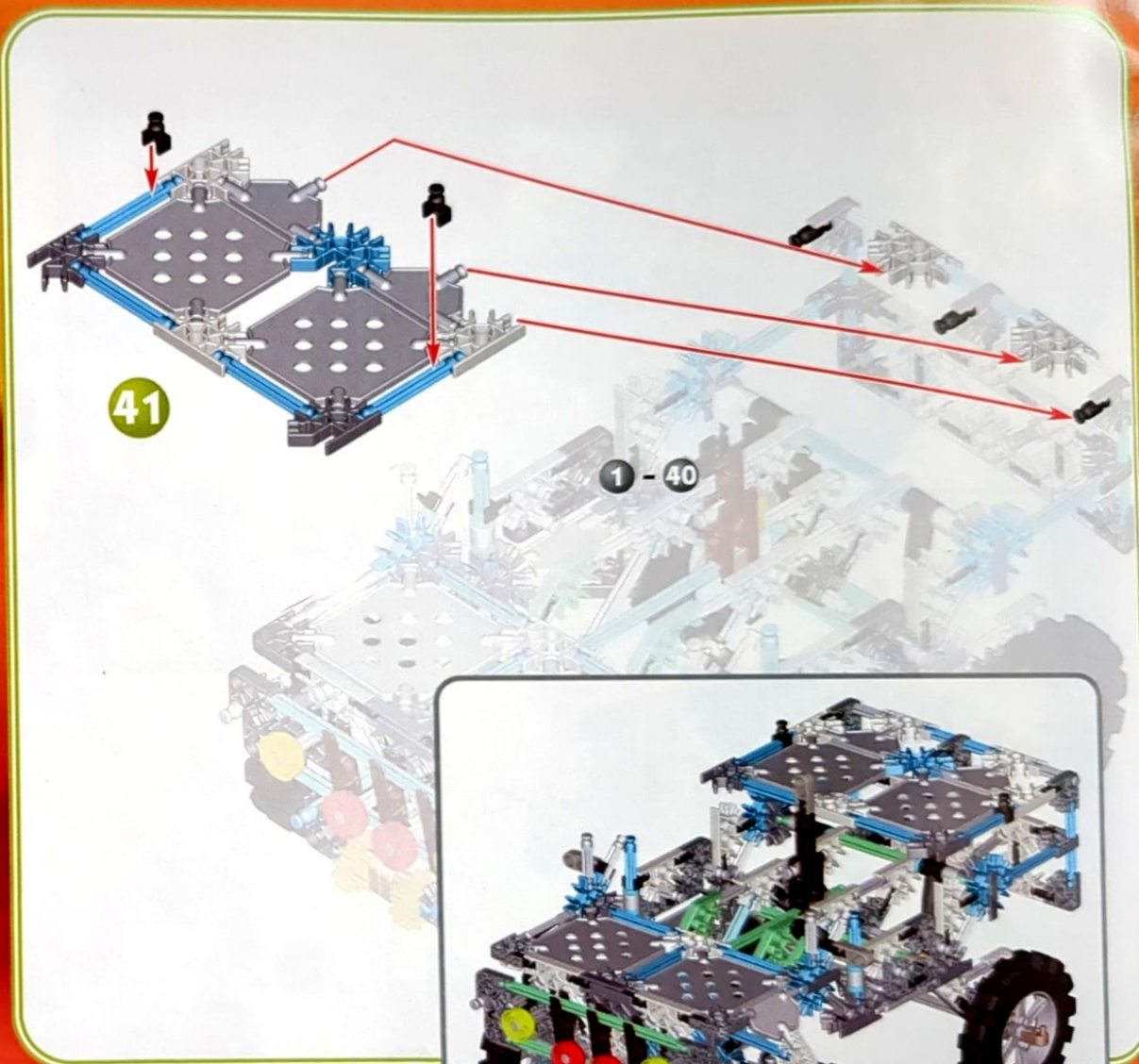
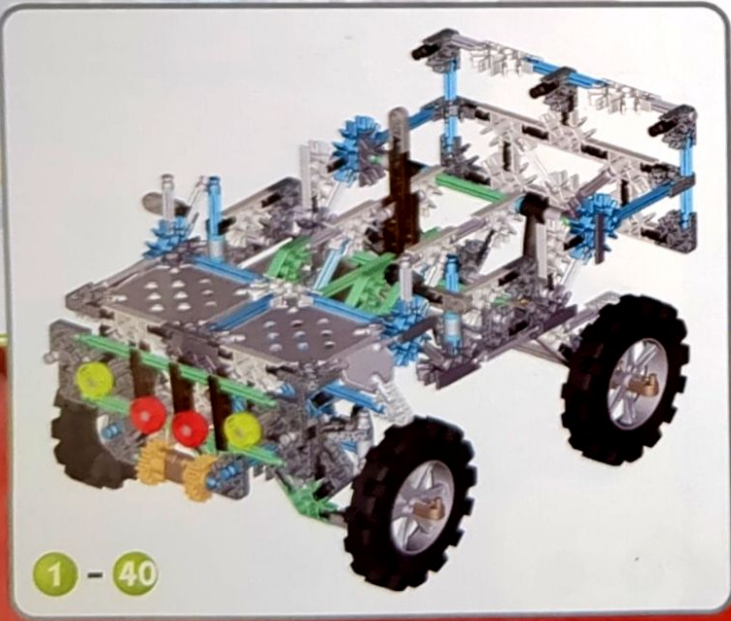
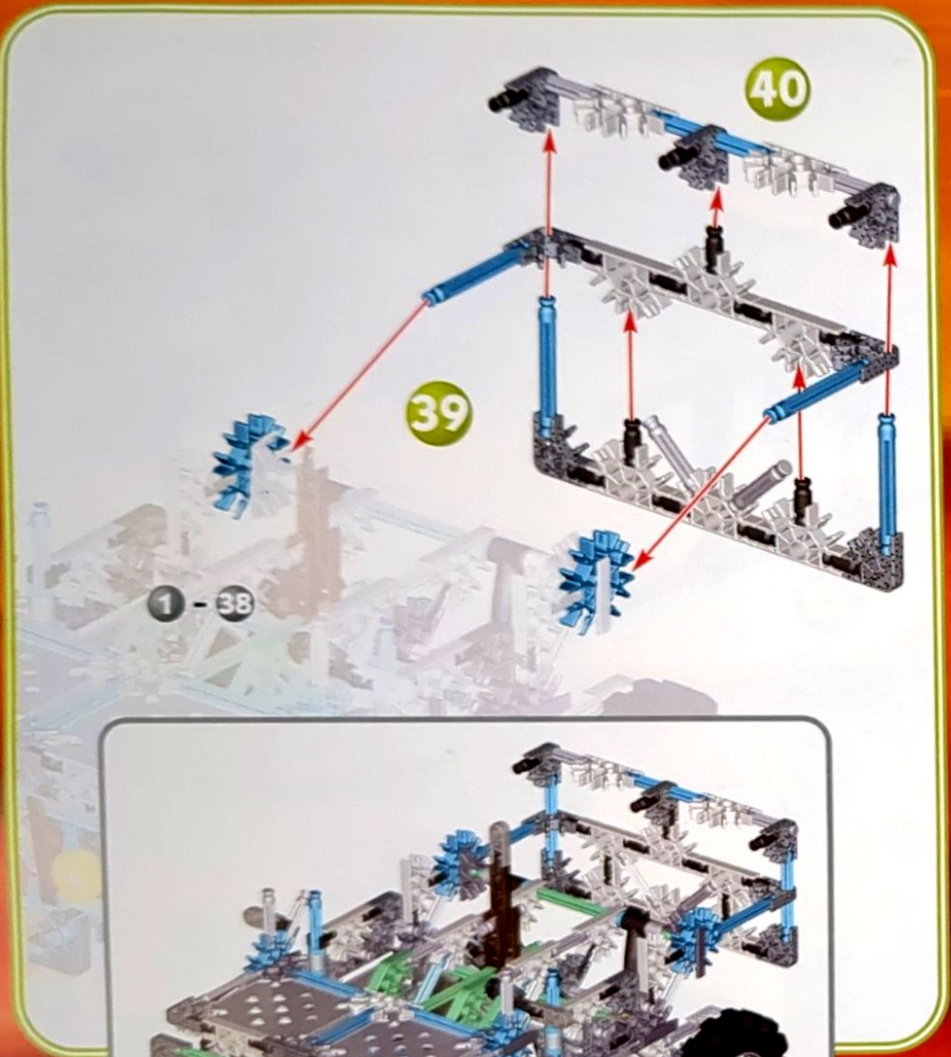

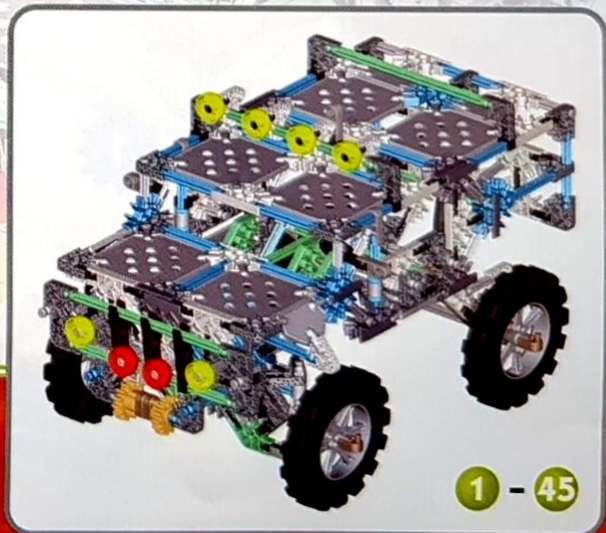
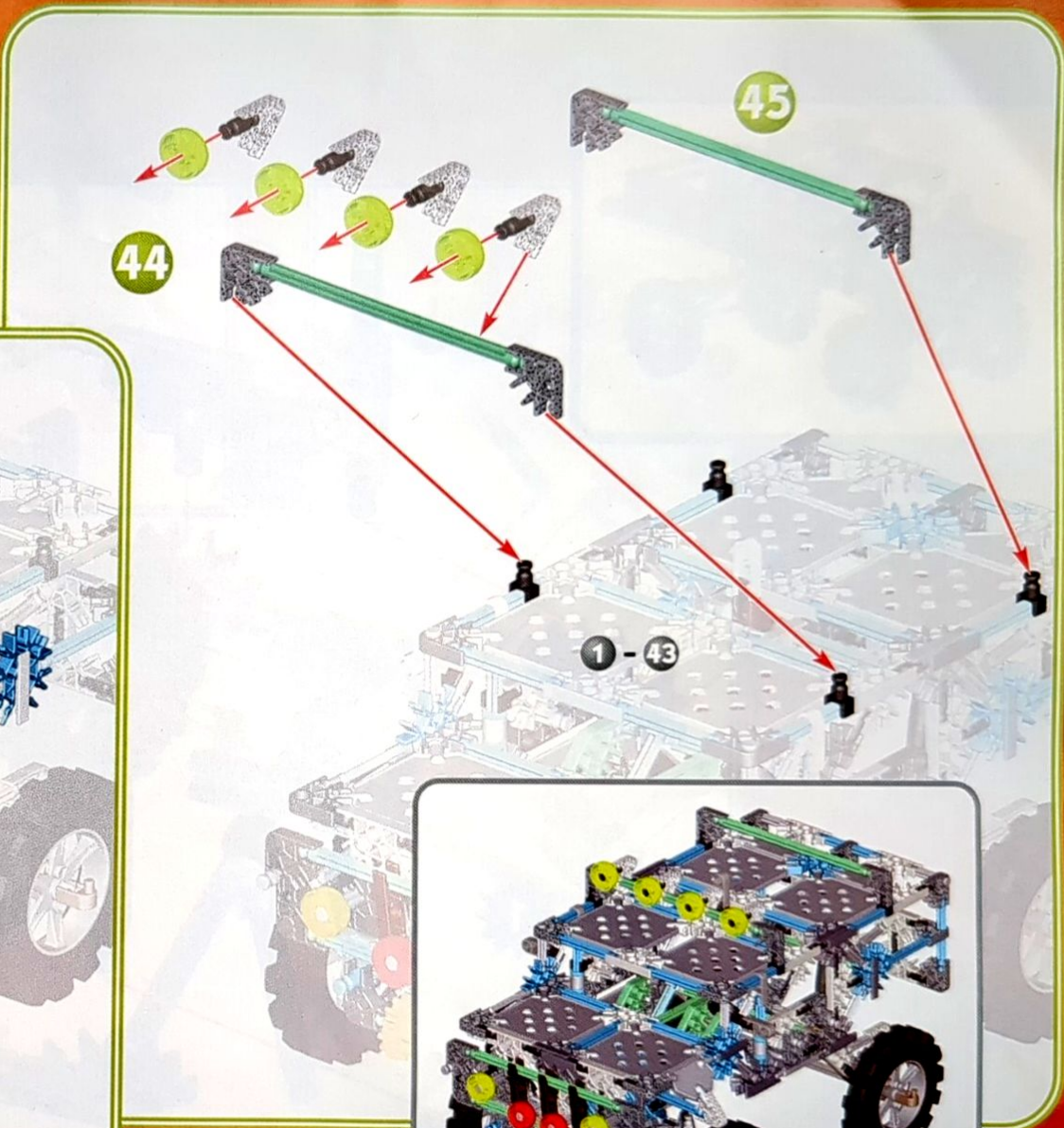
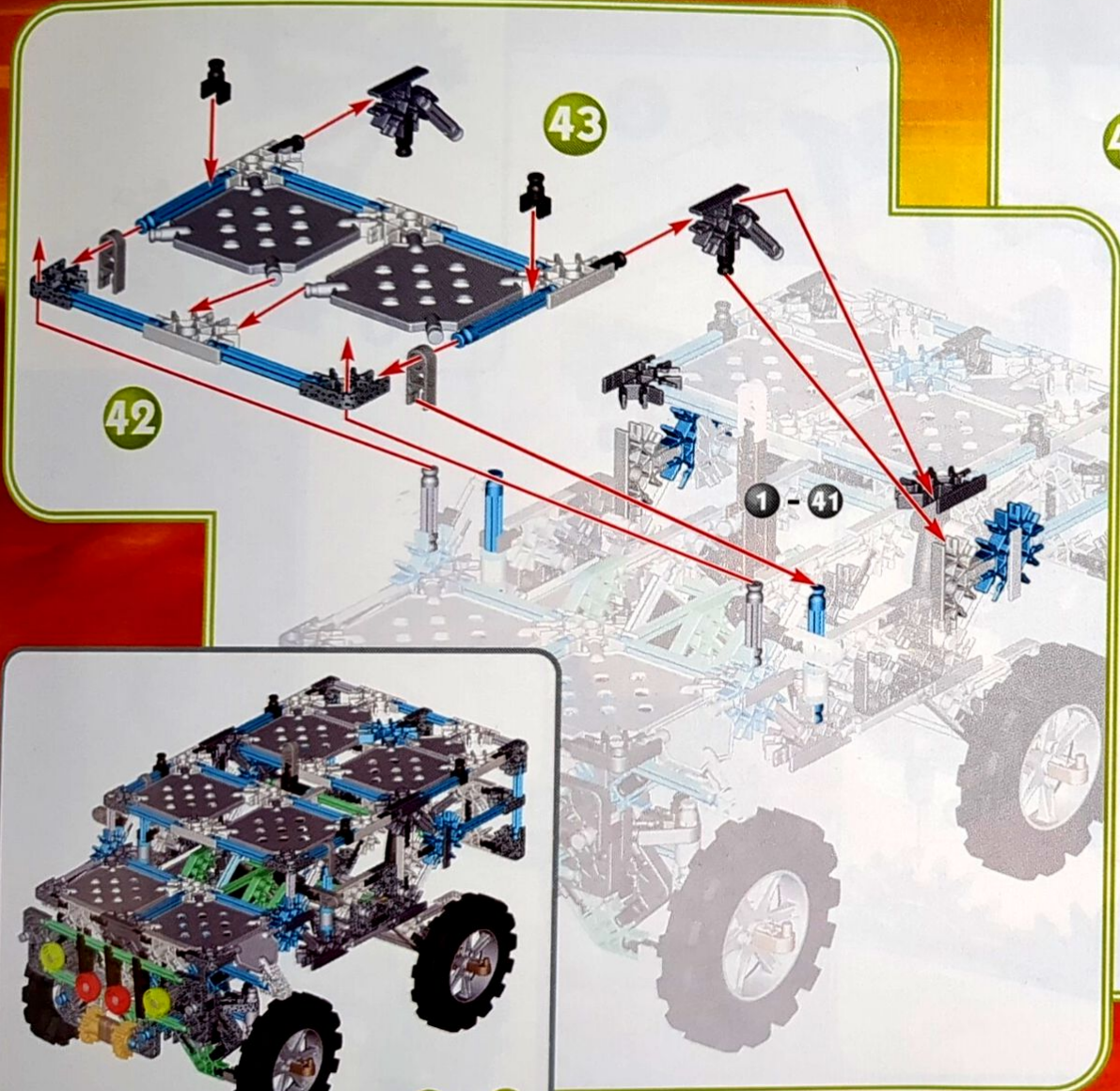

Sahara

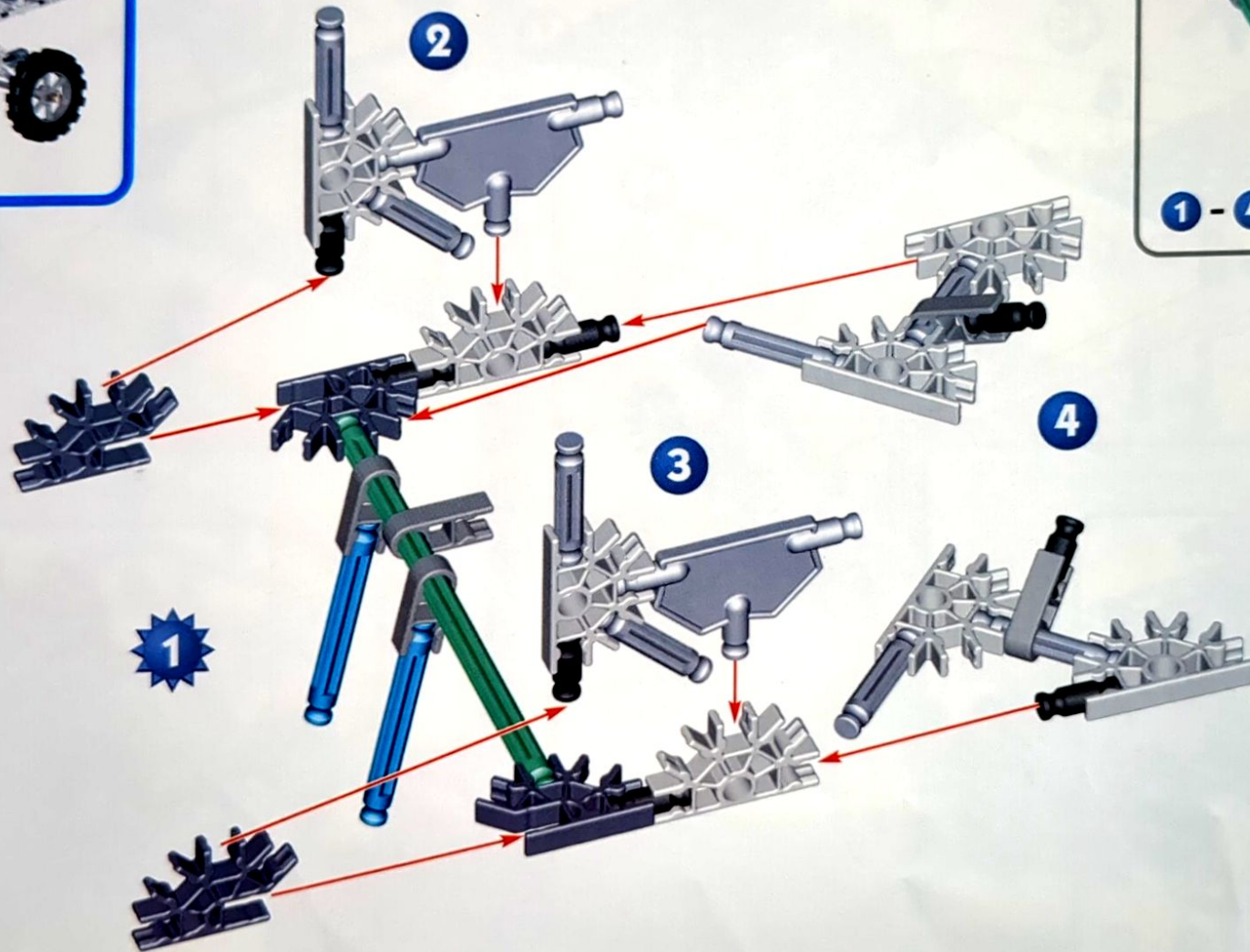
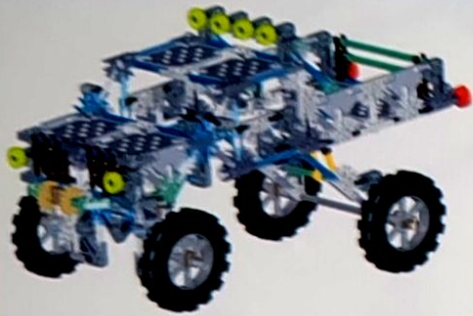

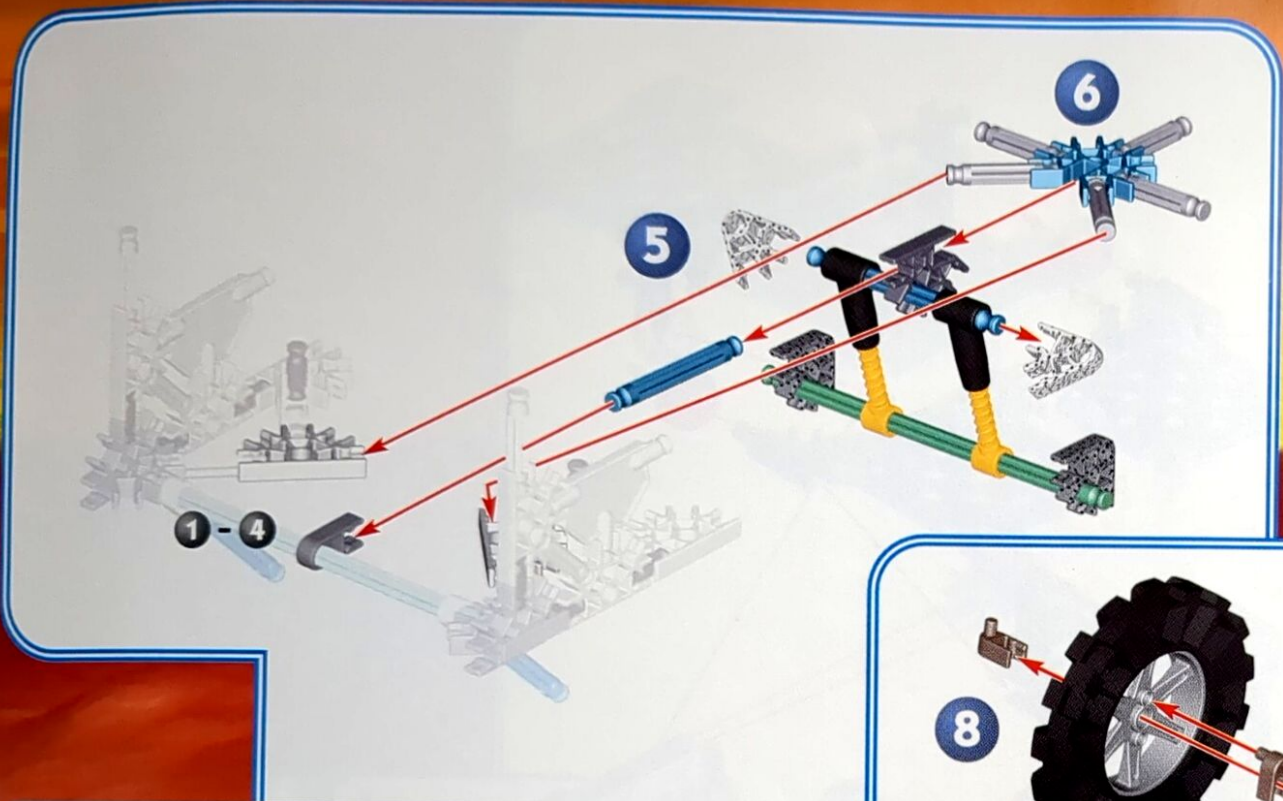

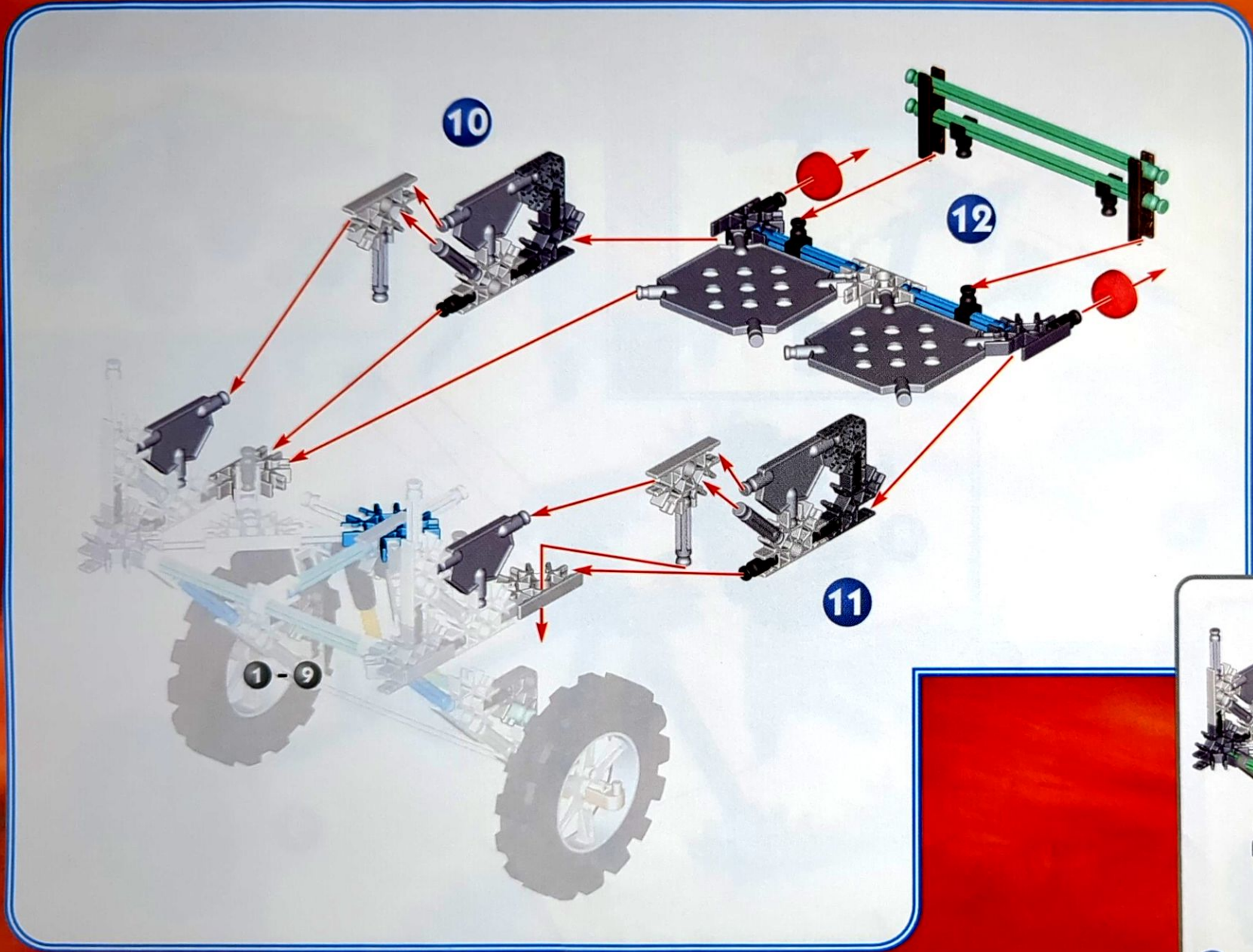

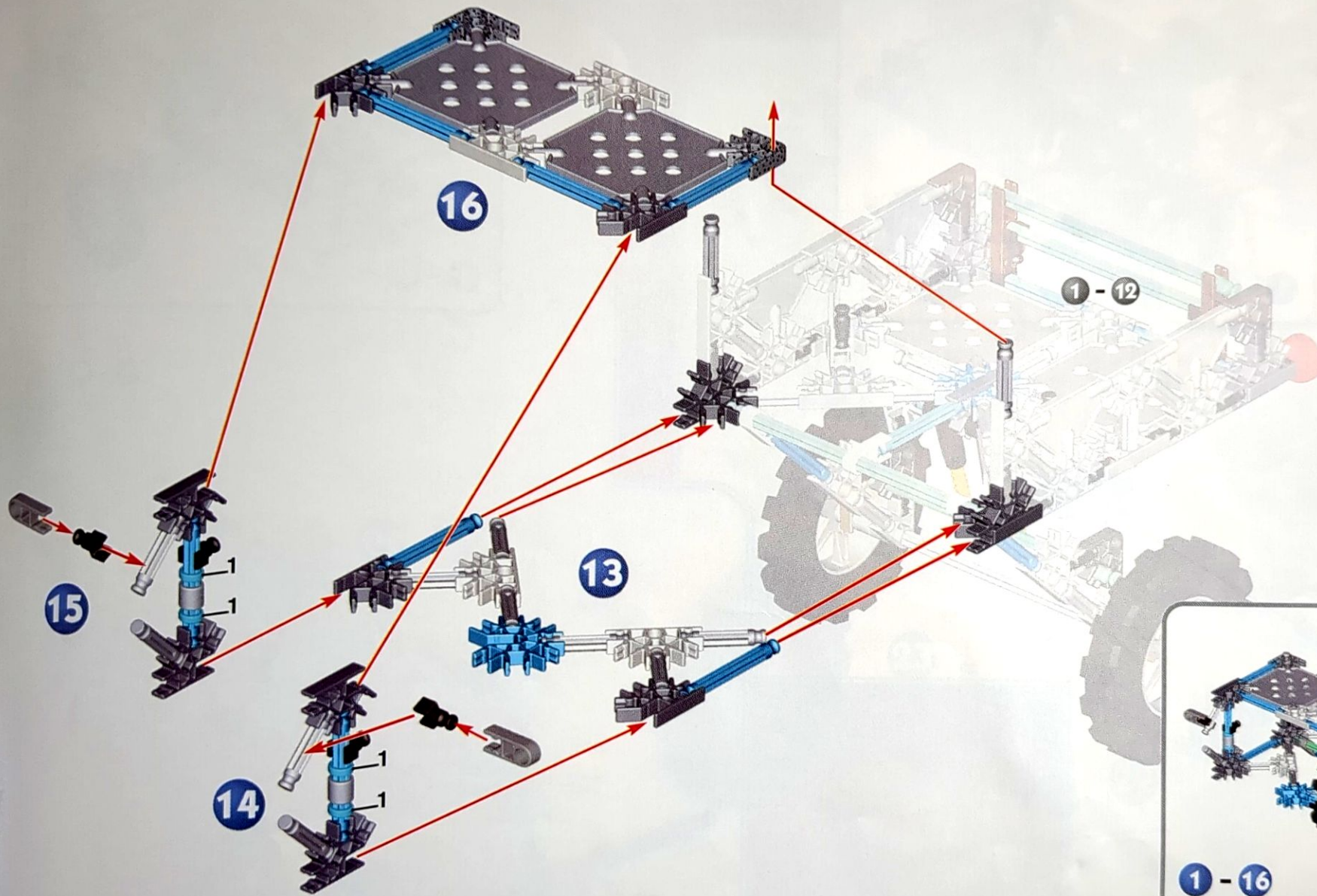

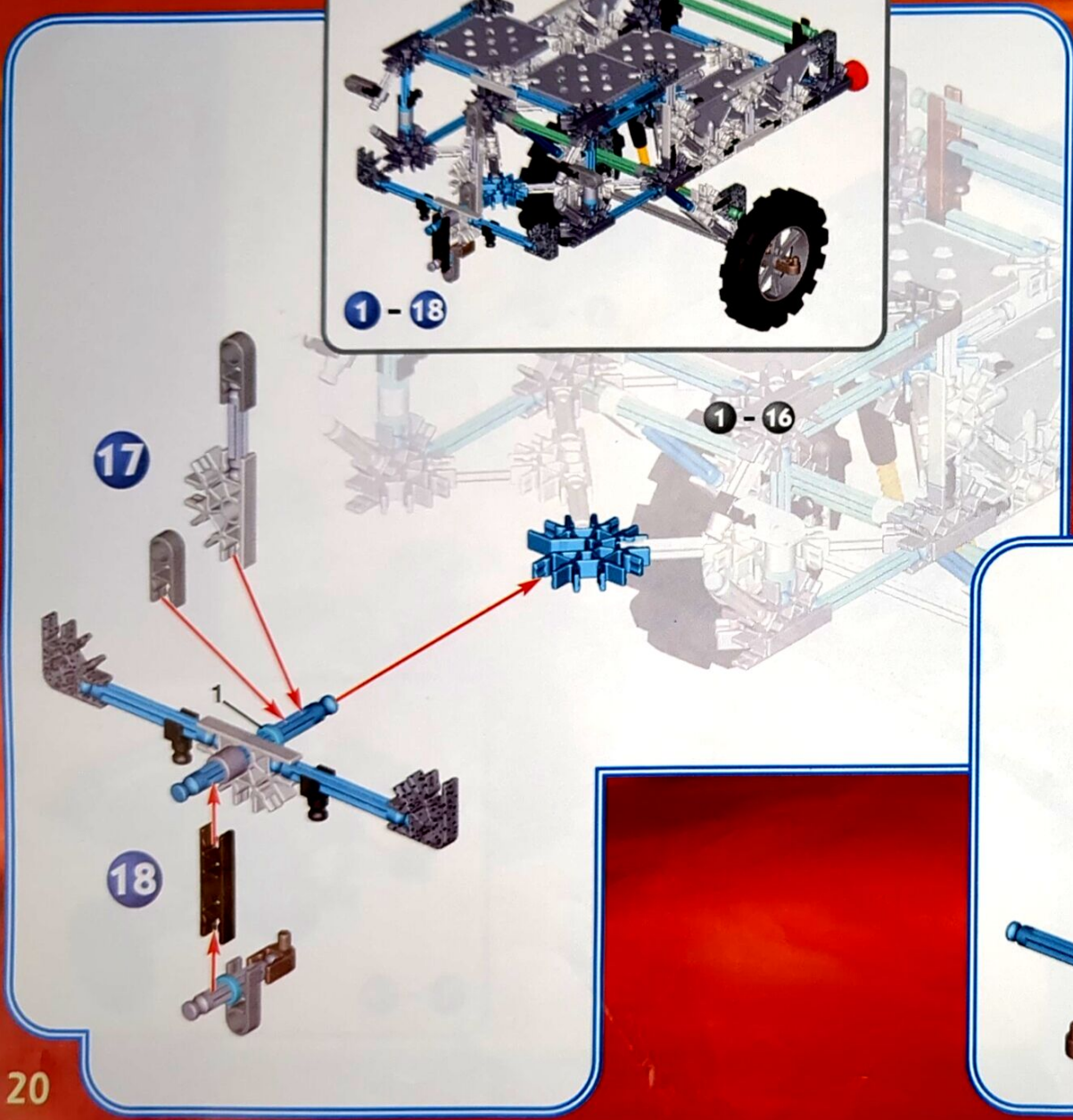
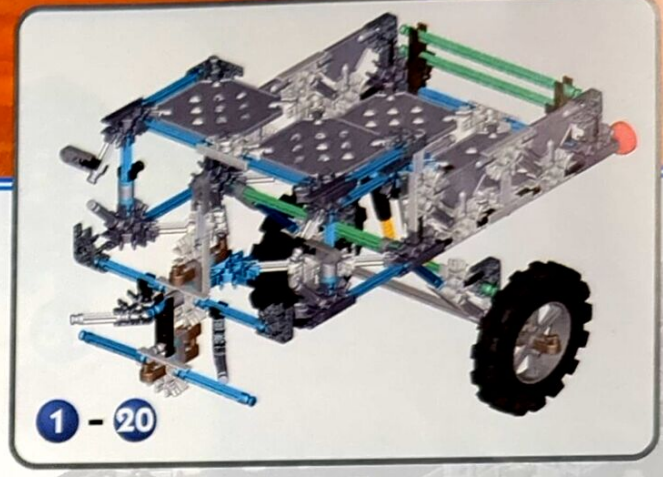

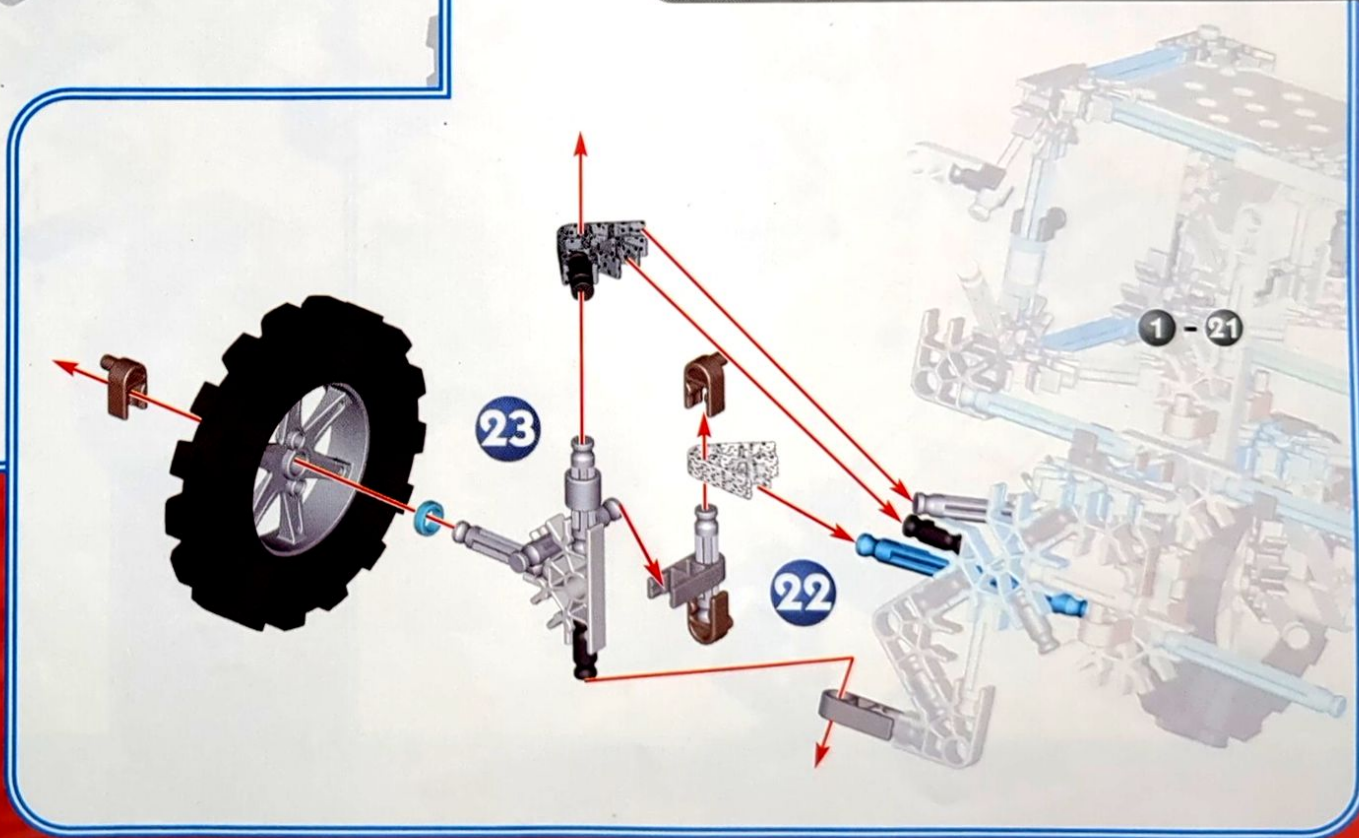
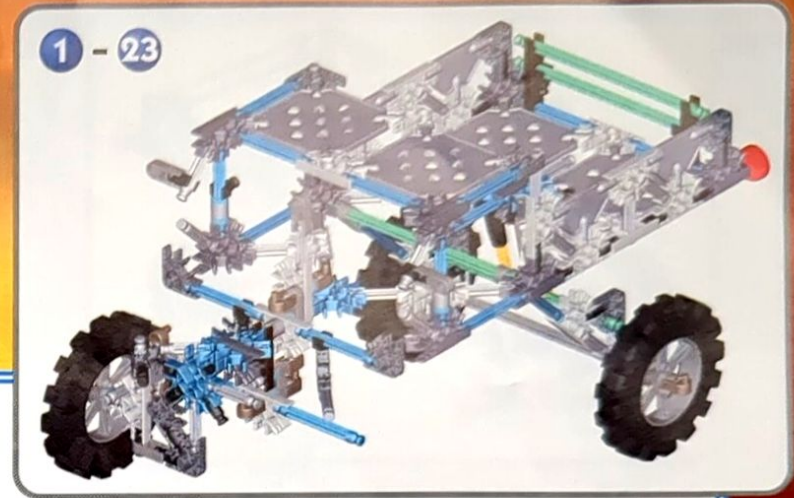
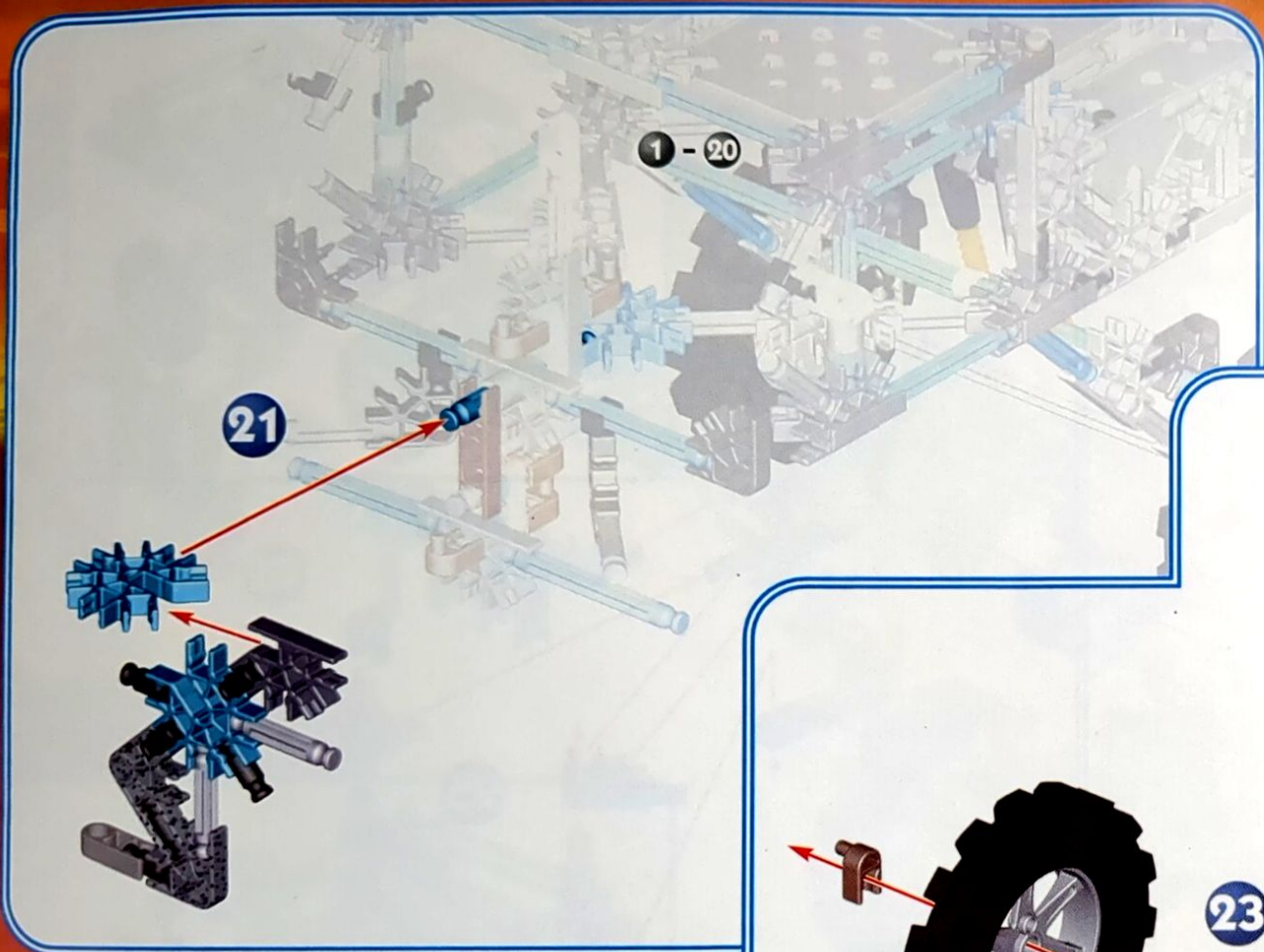

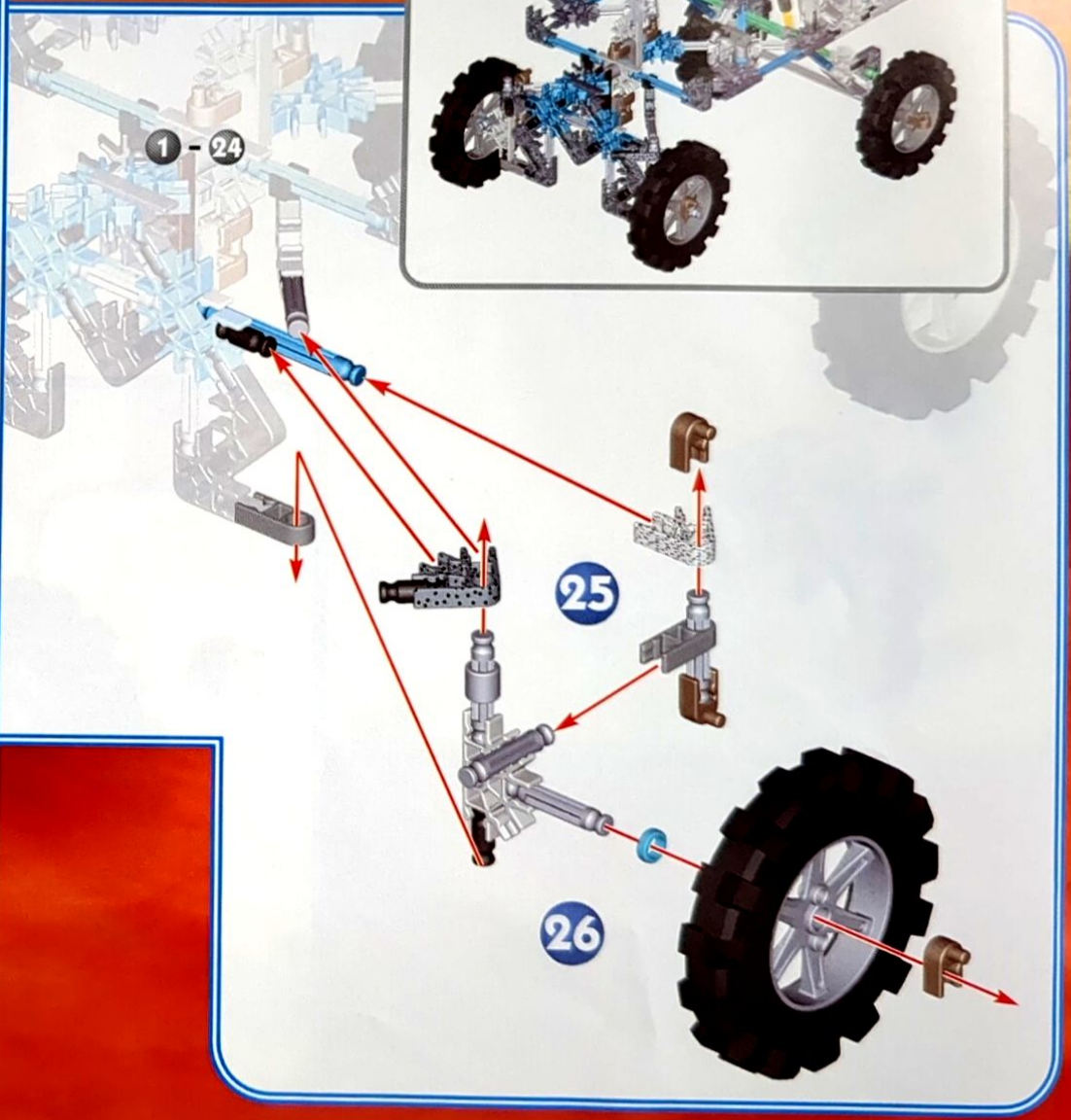
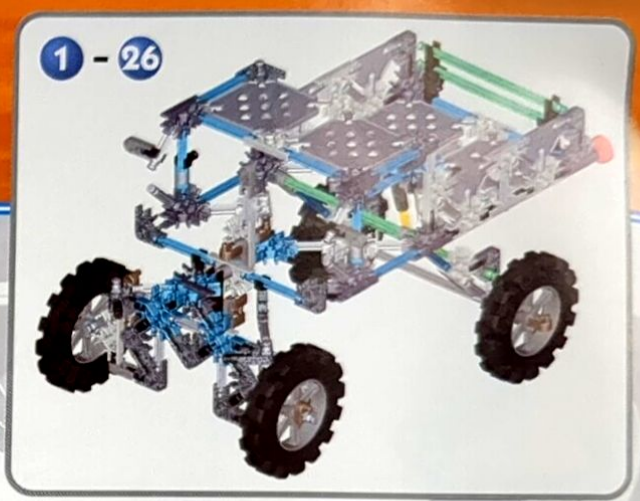
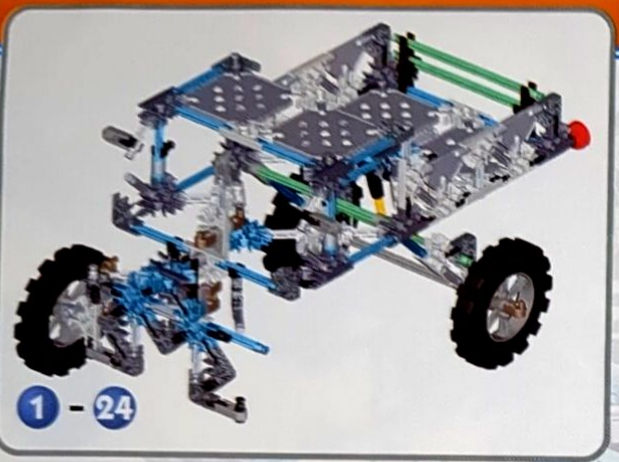

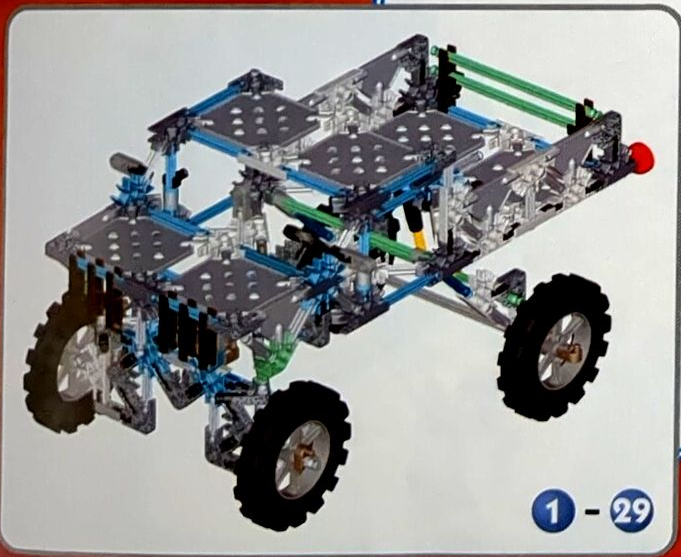
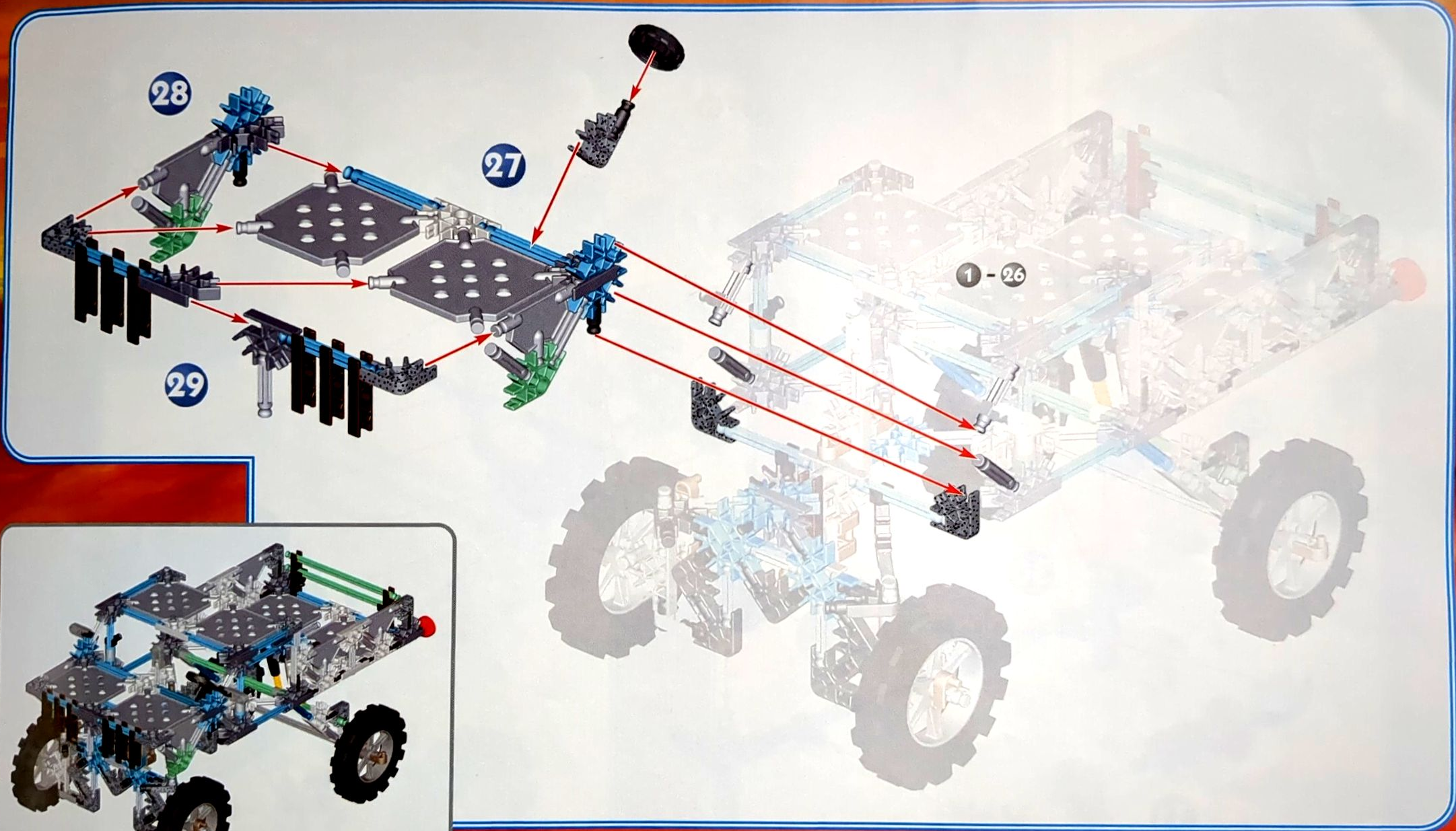

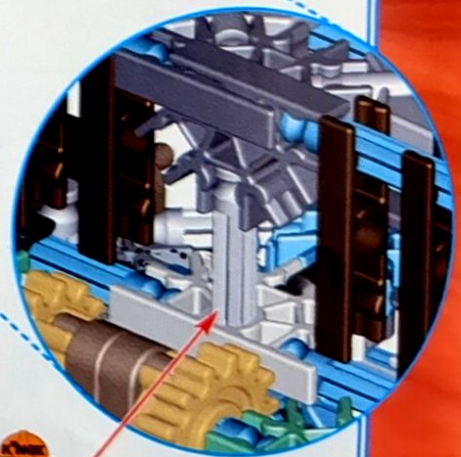
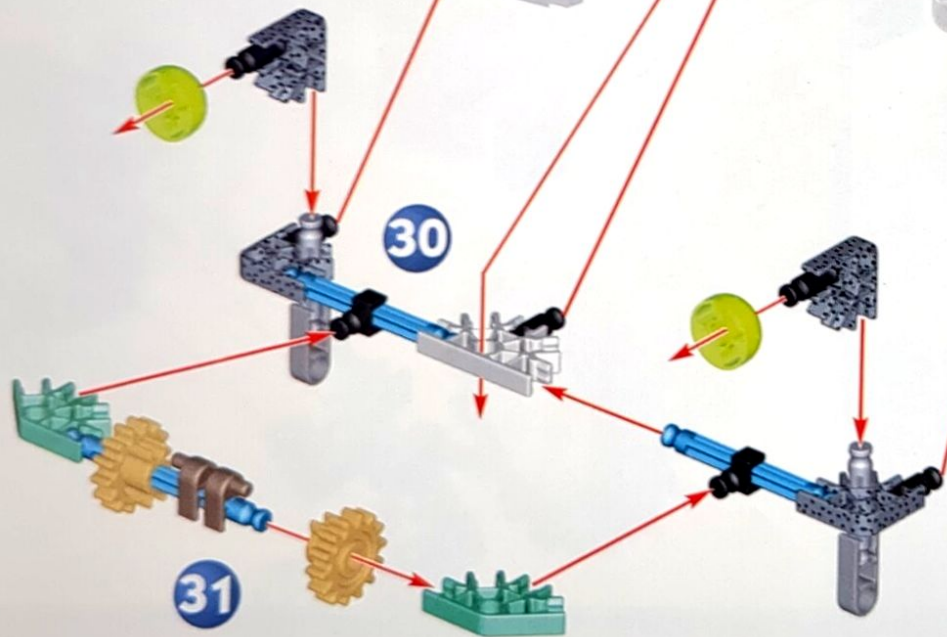
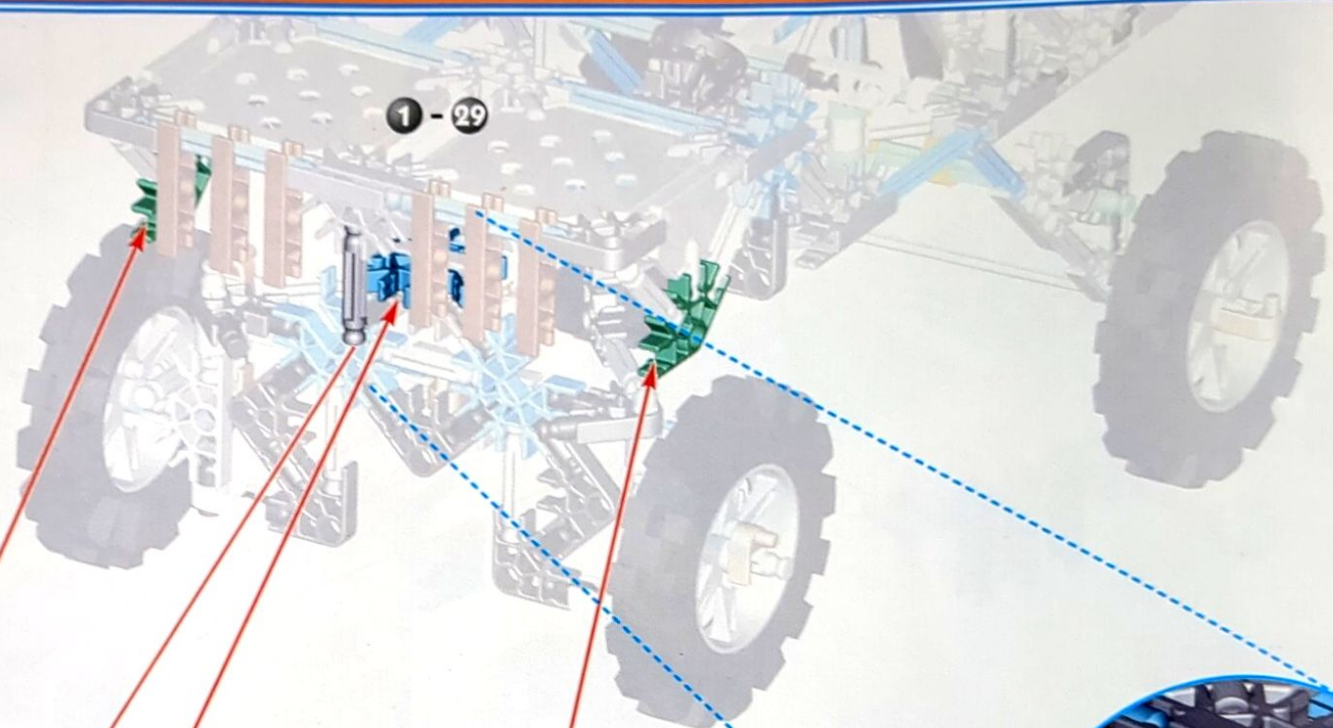
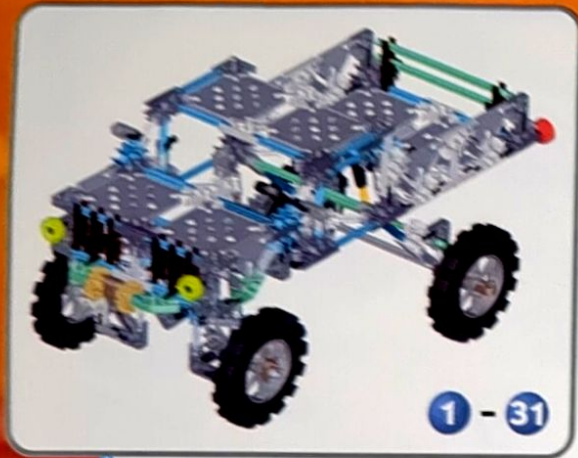

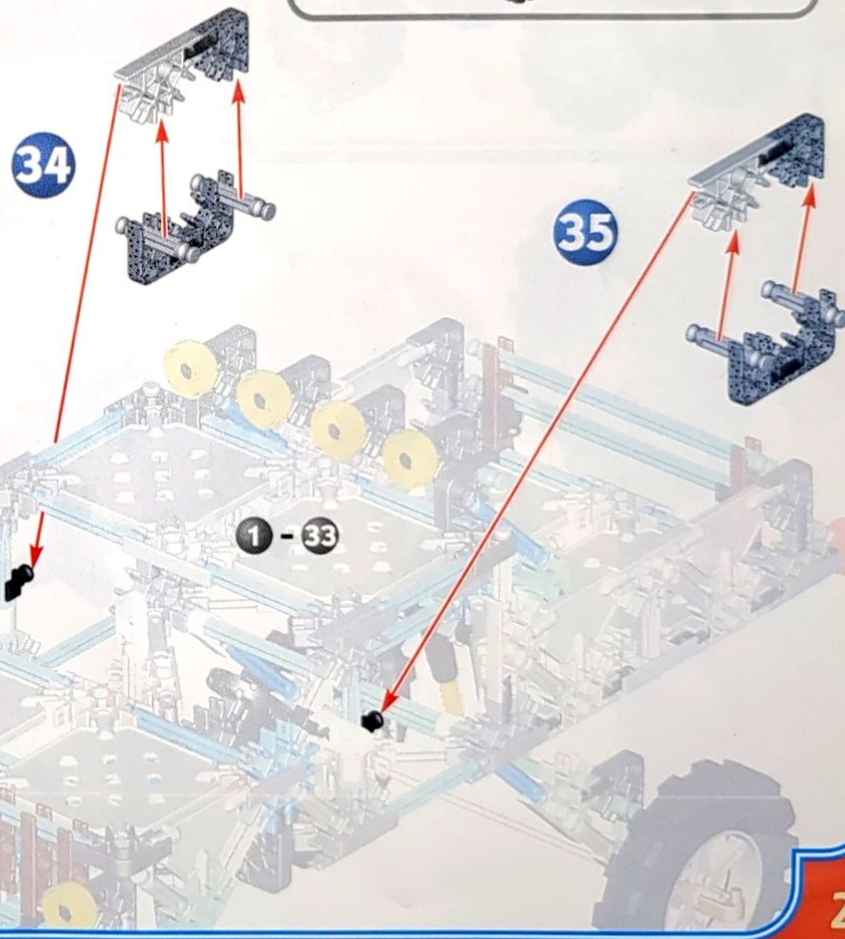
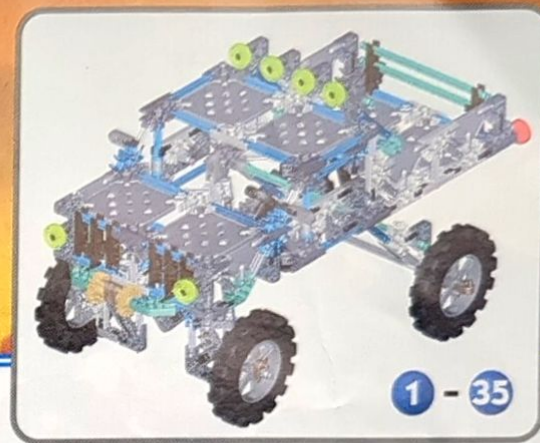
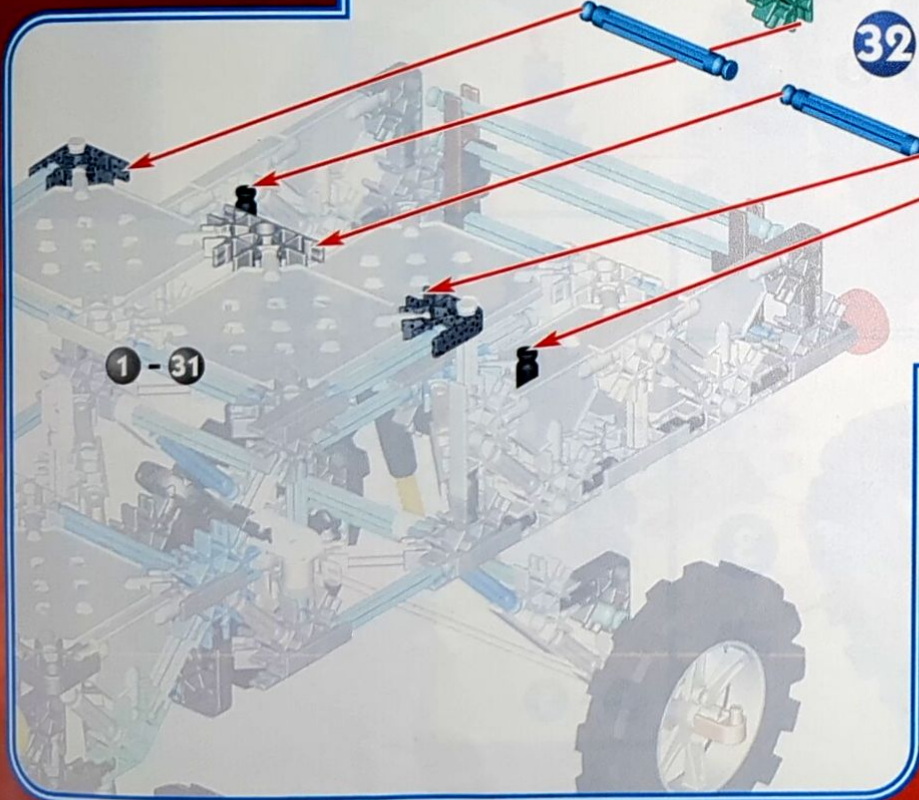
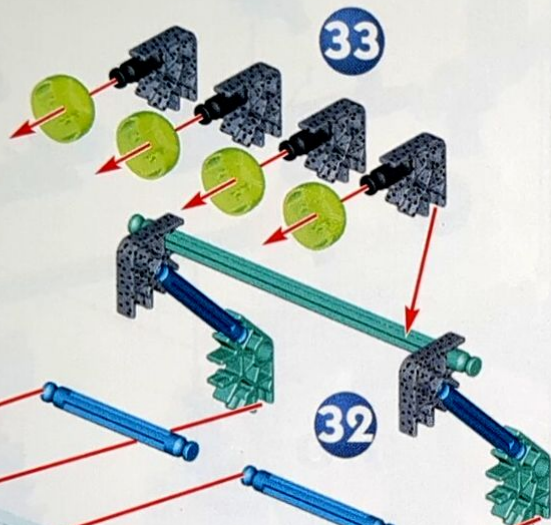

Raider

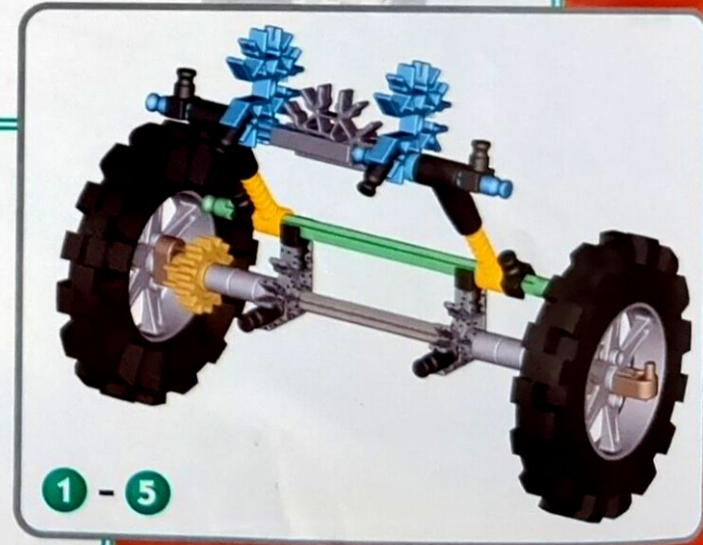
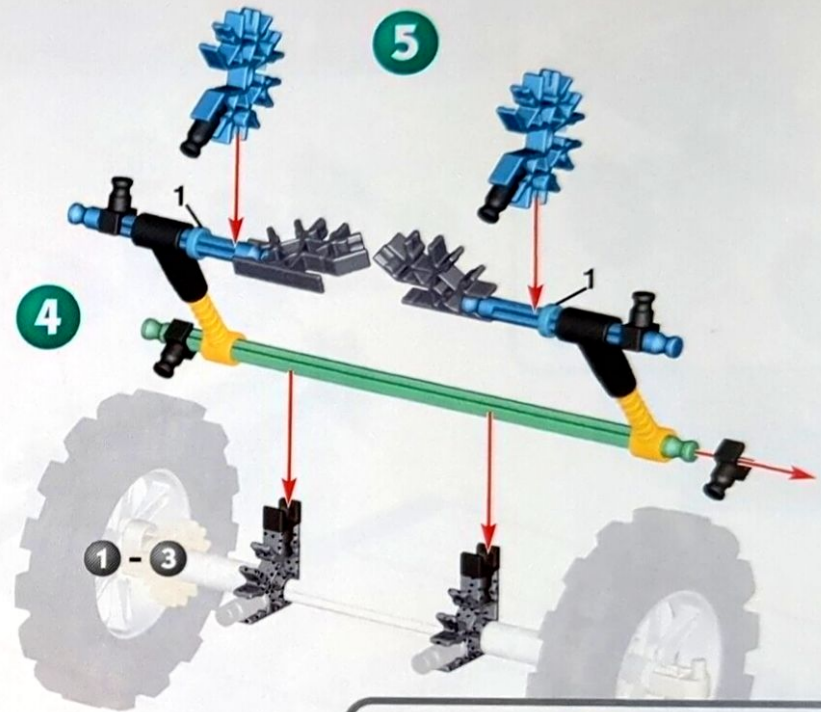
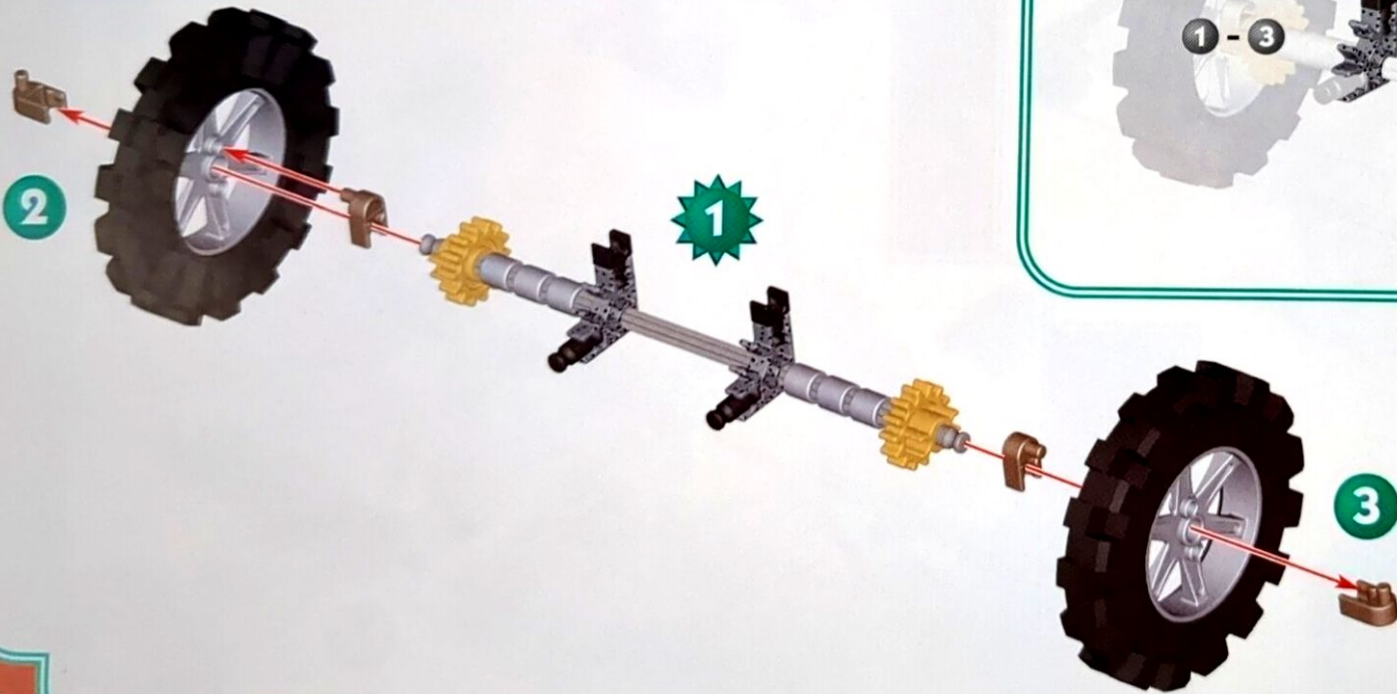

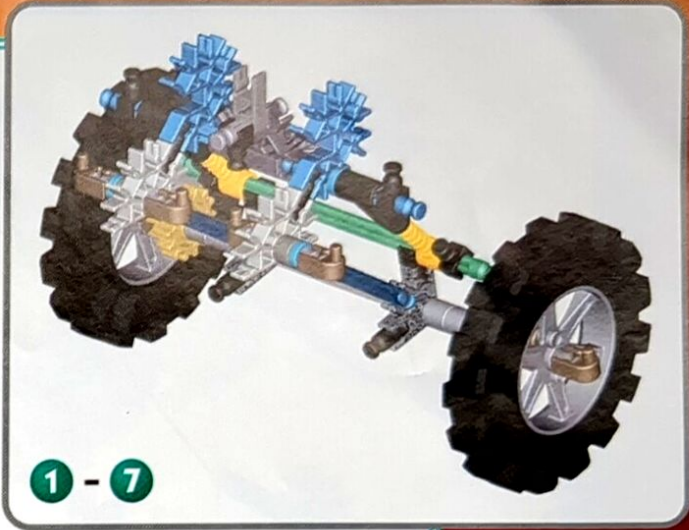
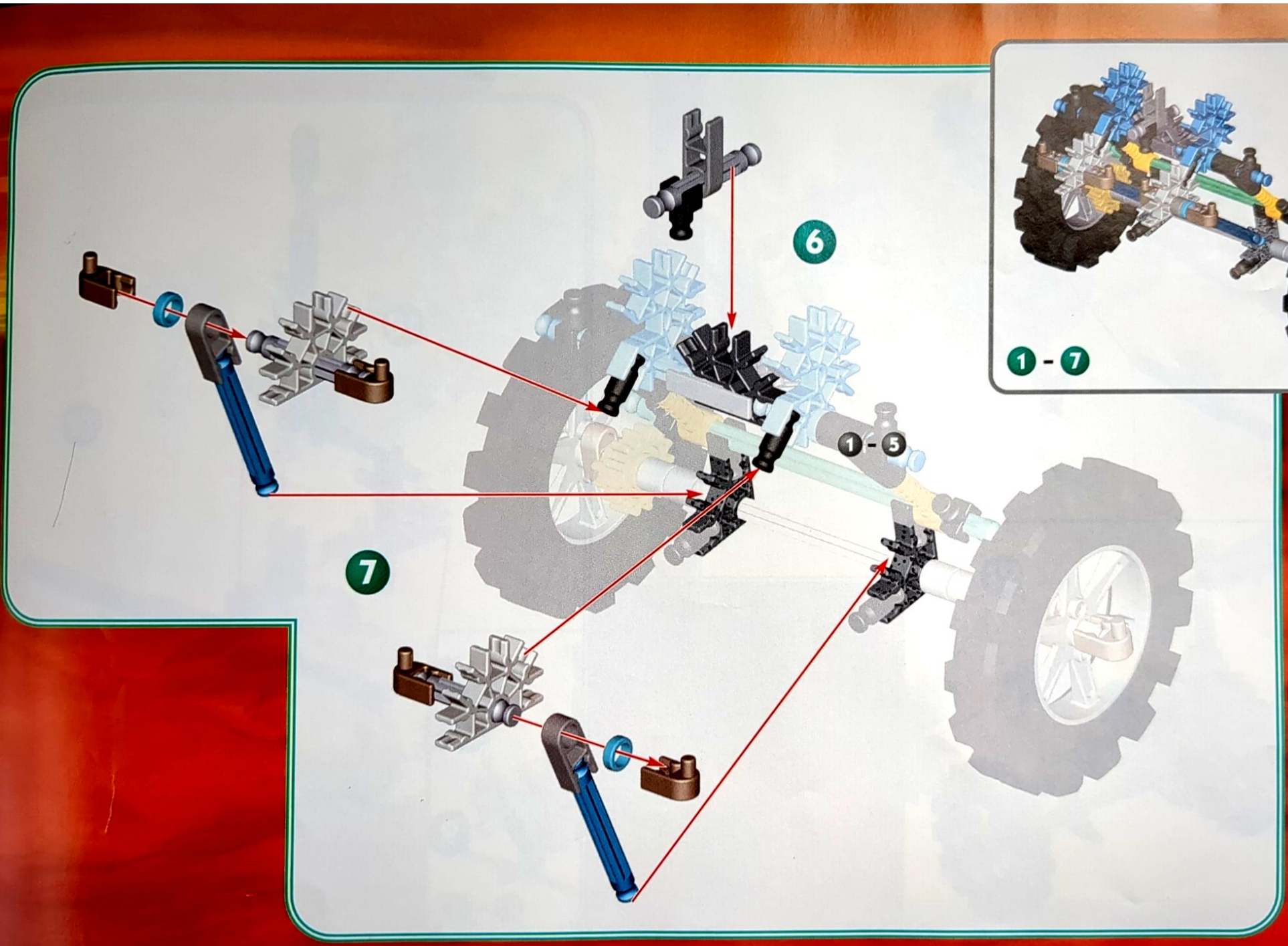

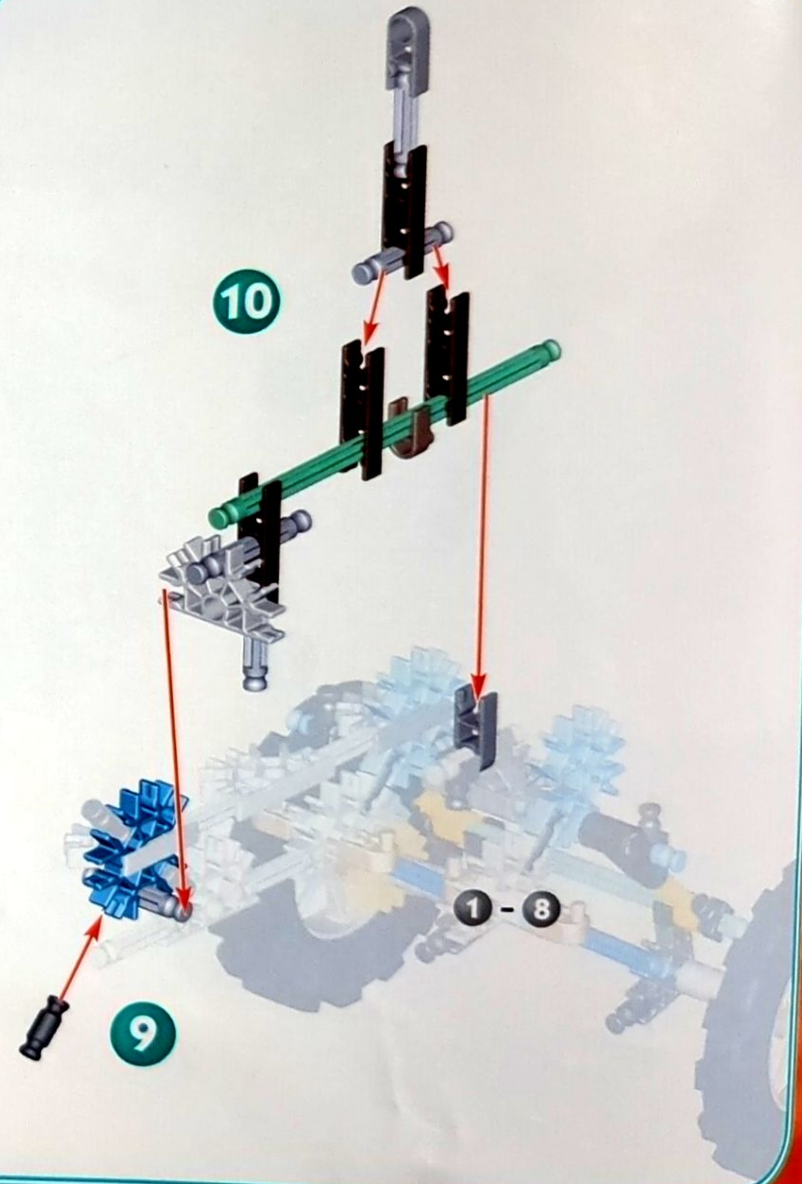
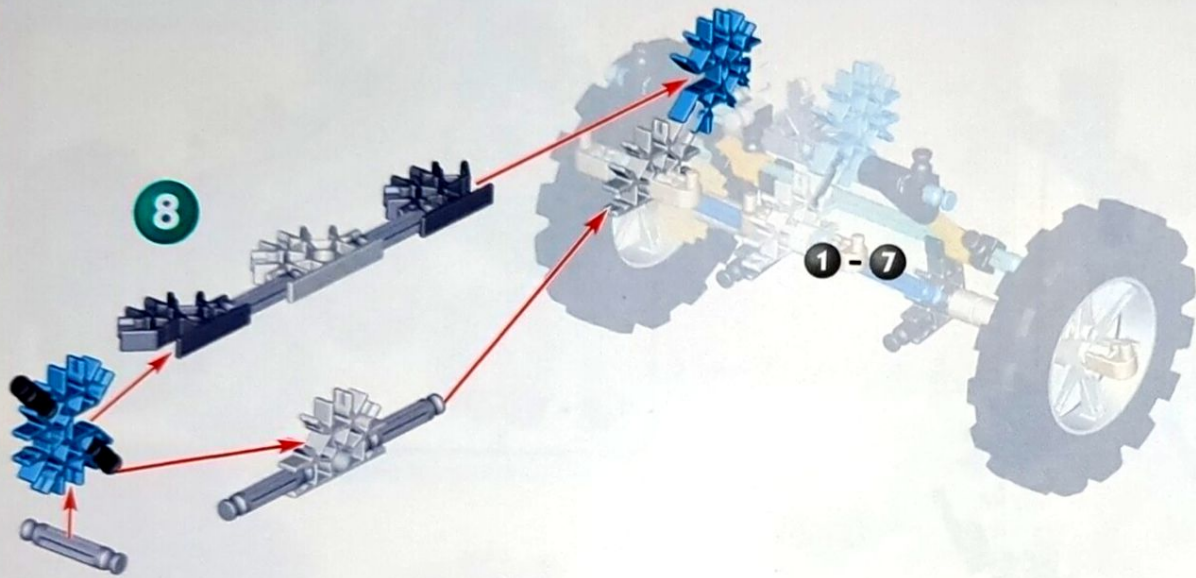

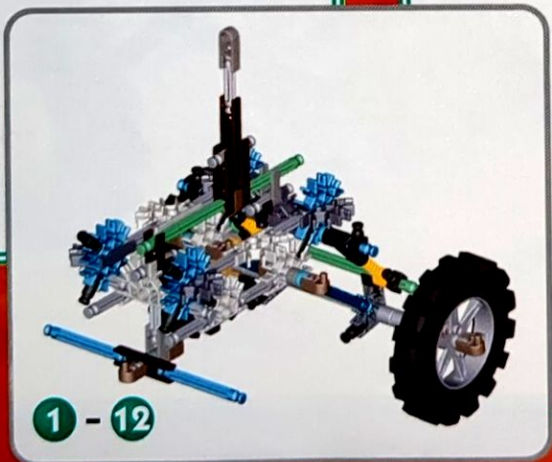
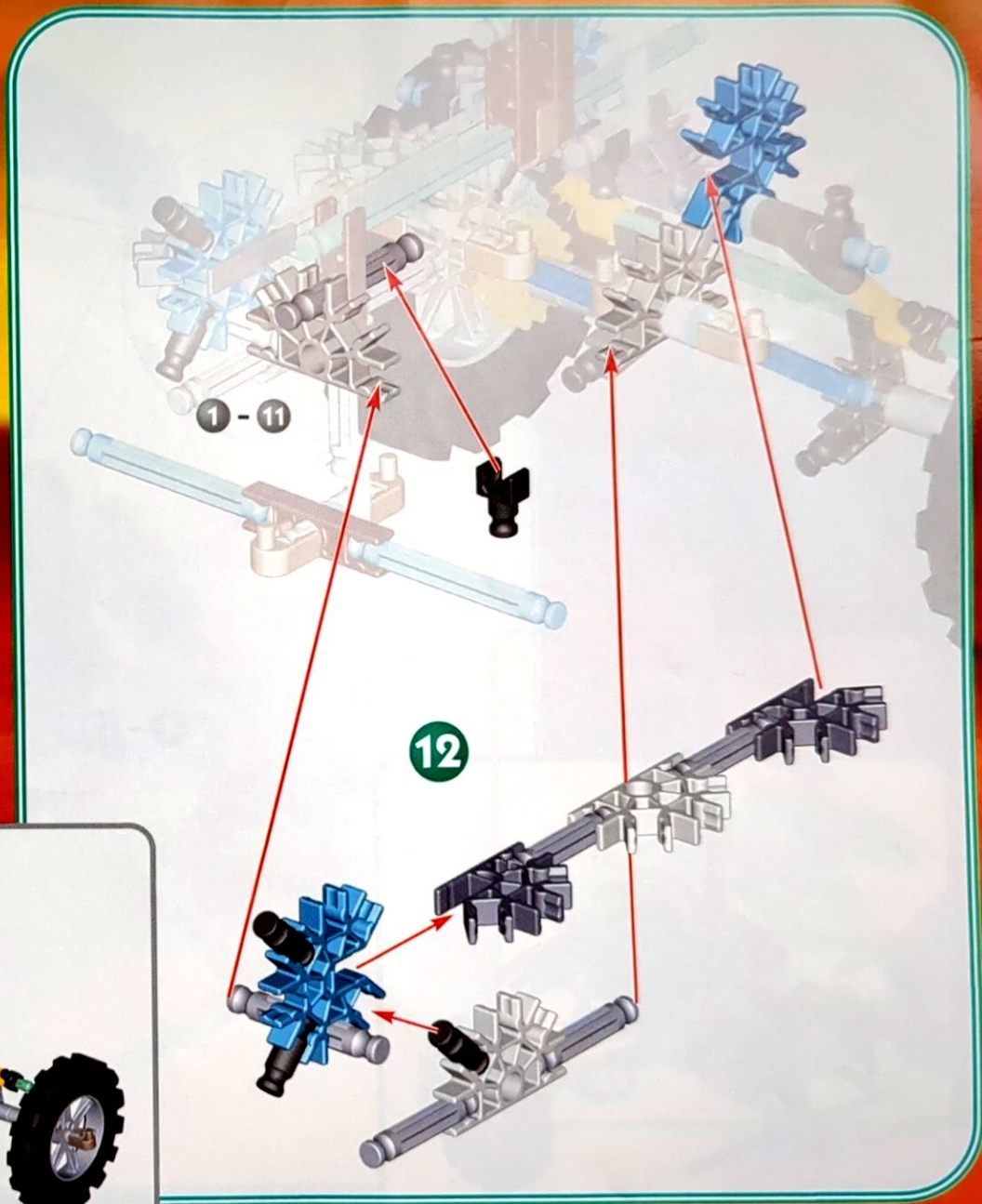

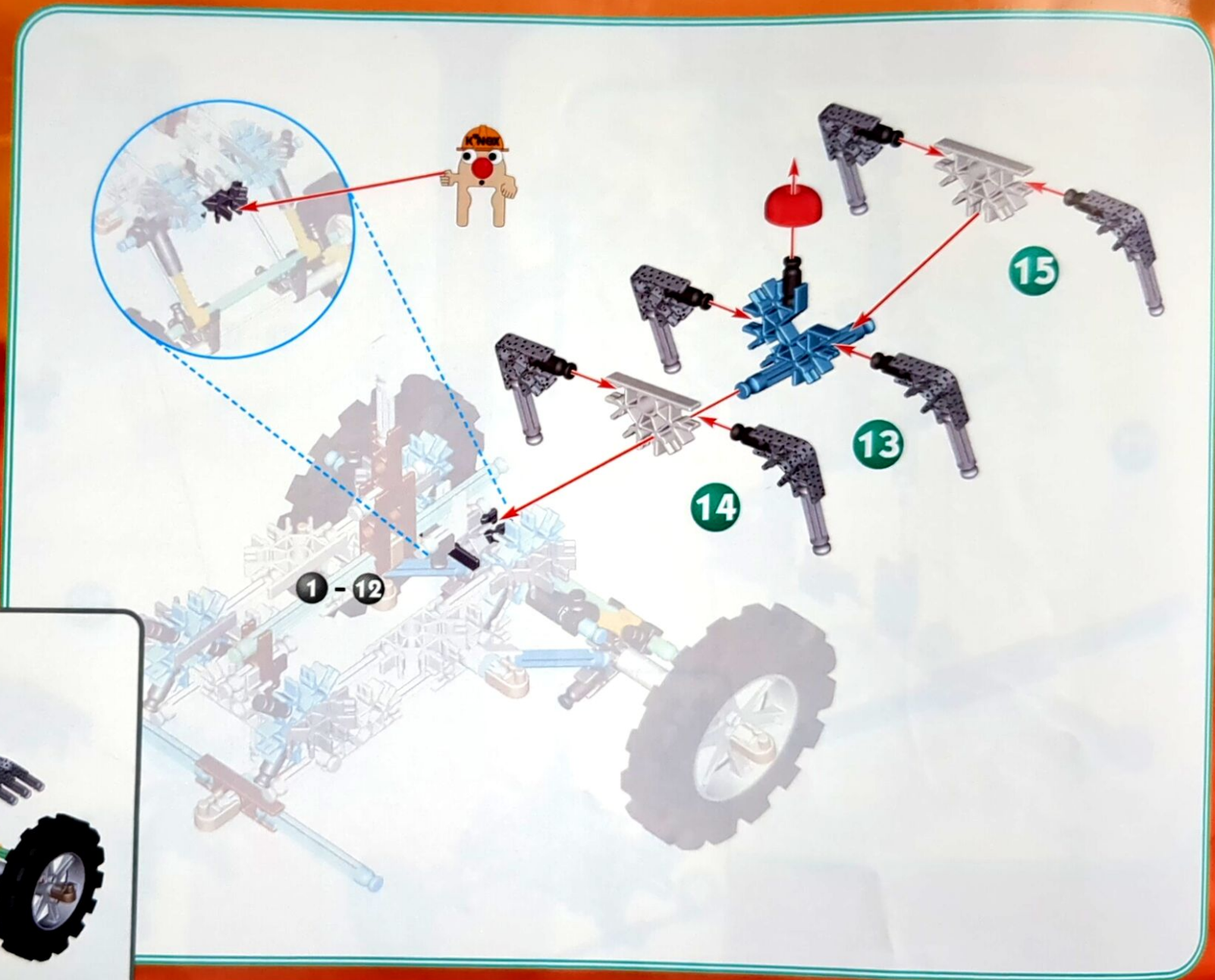

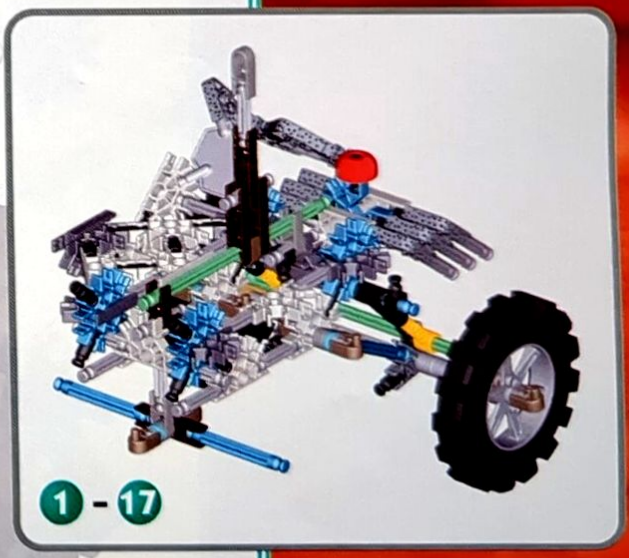
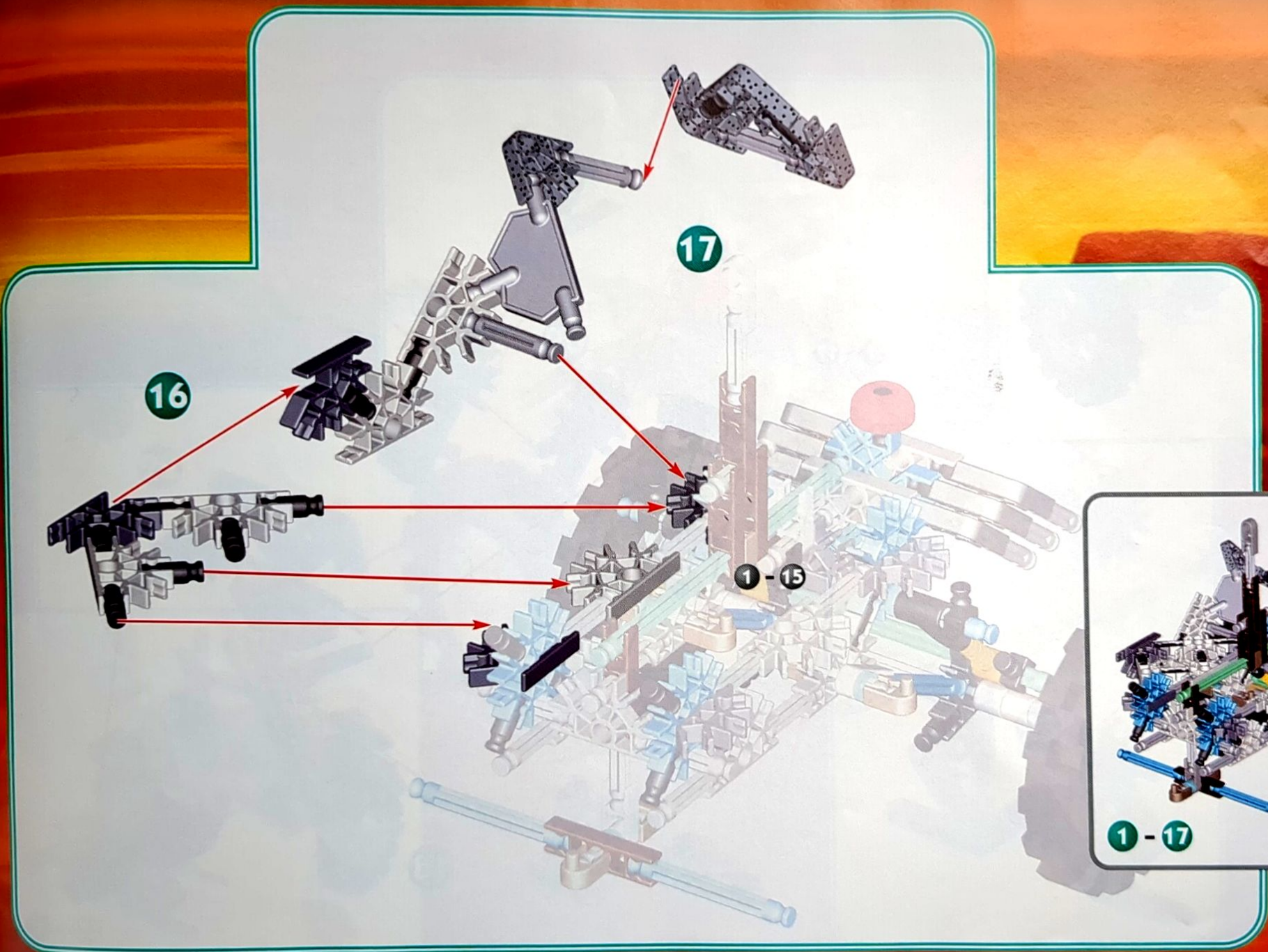

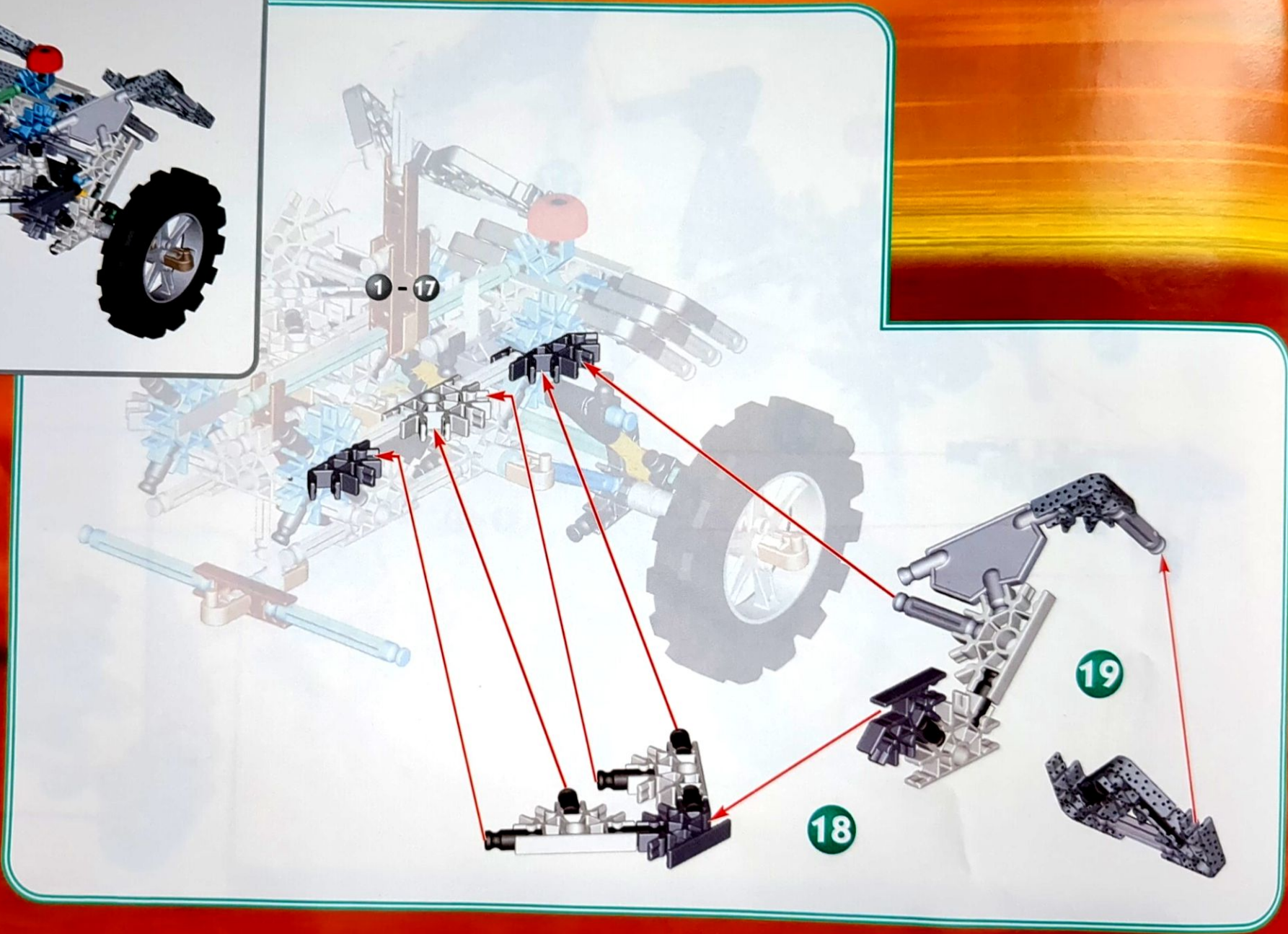
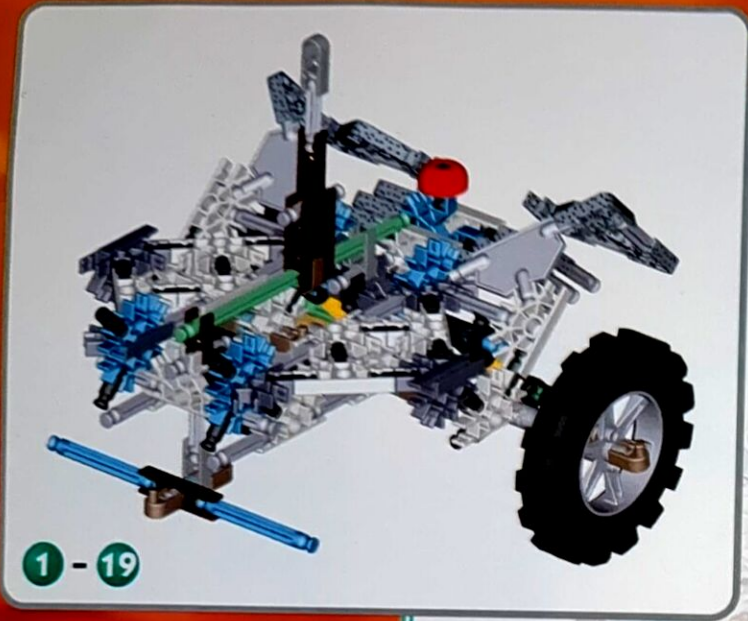

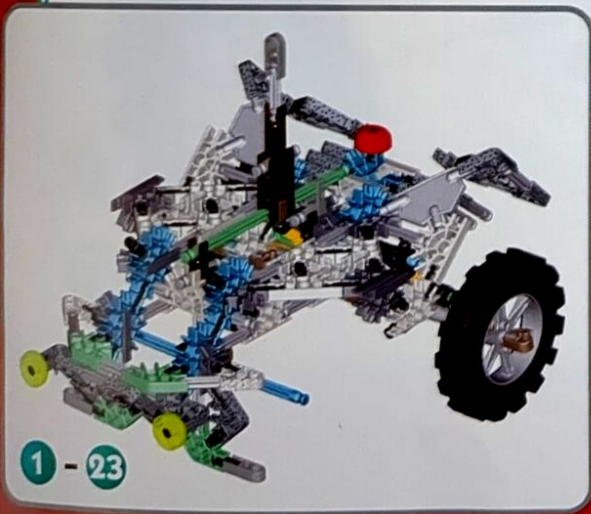
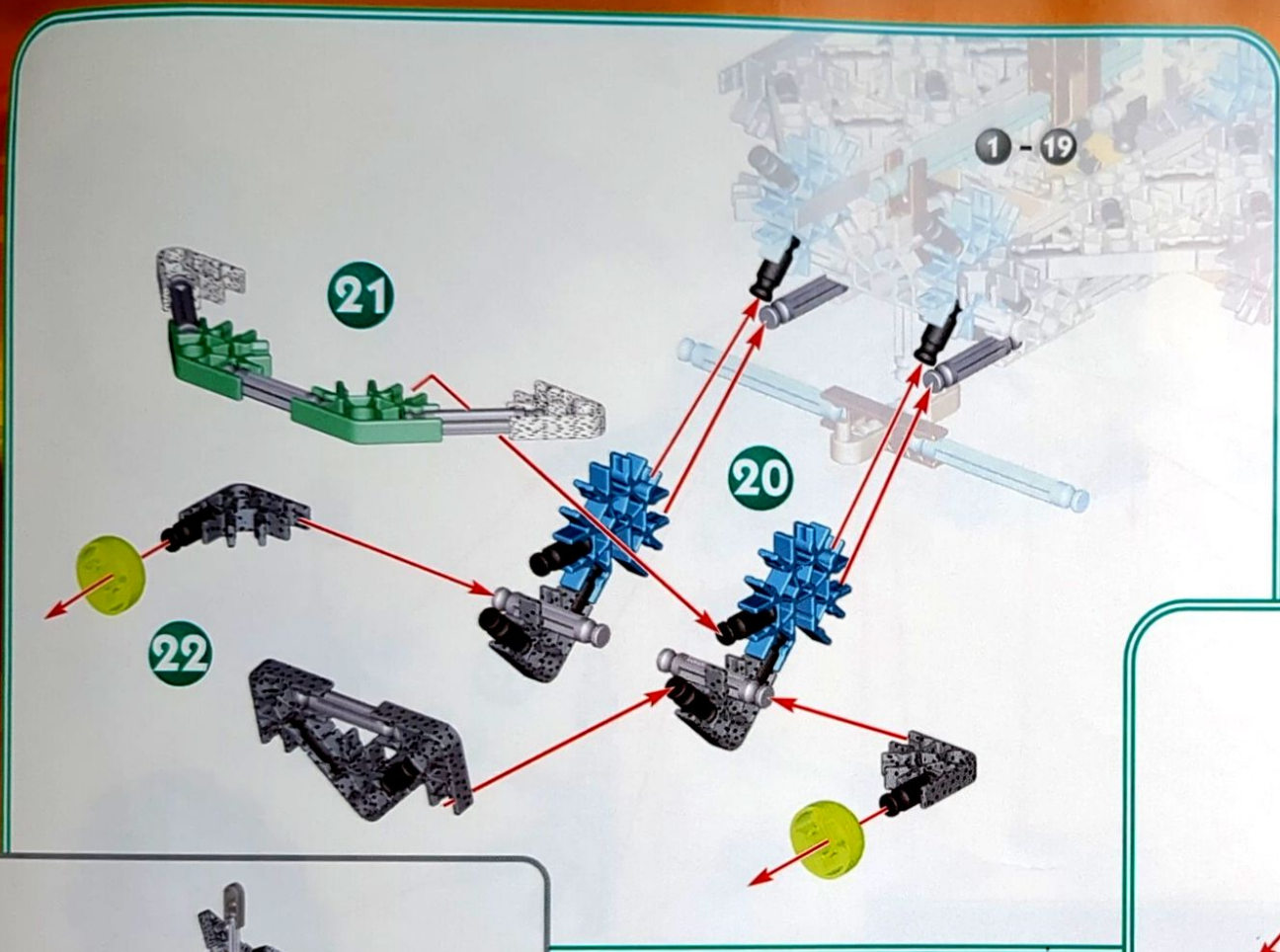

25

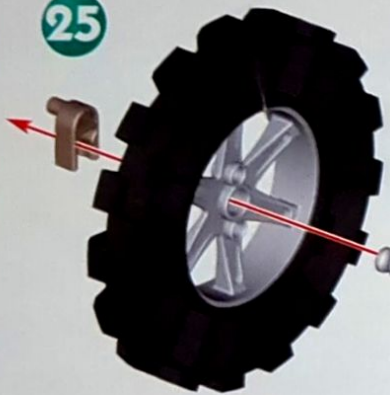

24

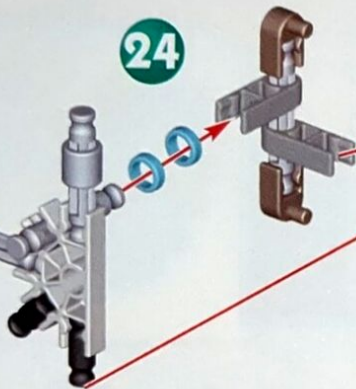

1 - 23

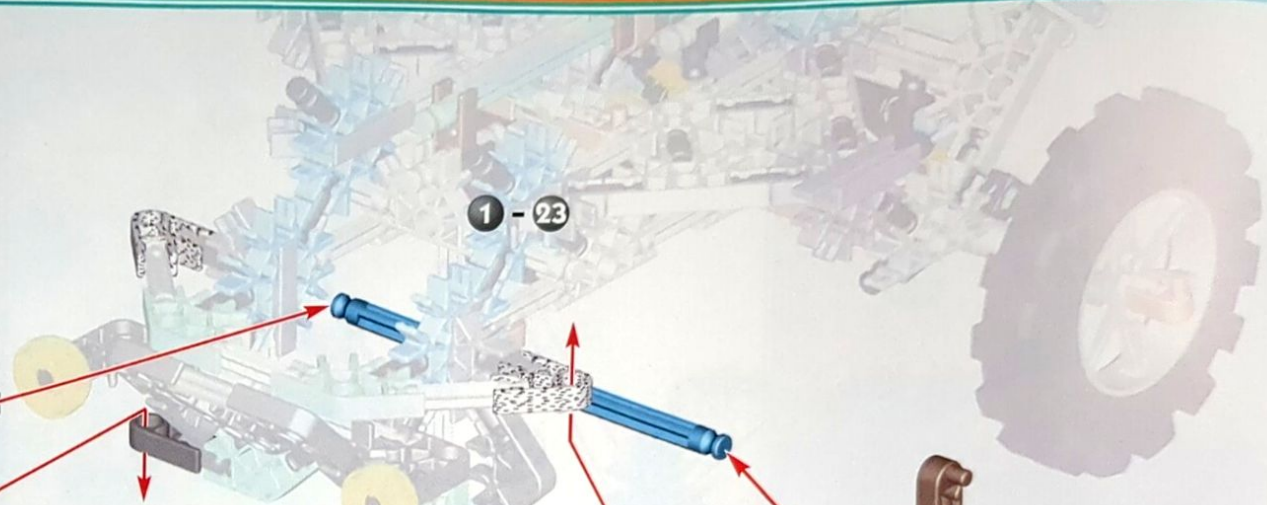

26

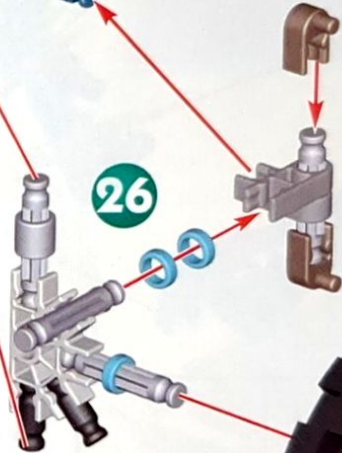

27

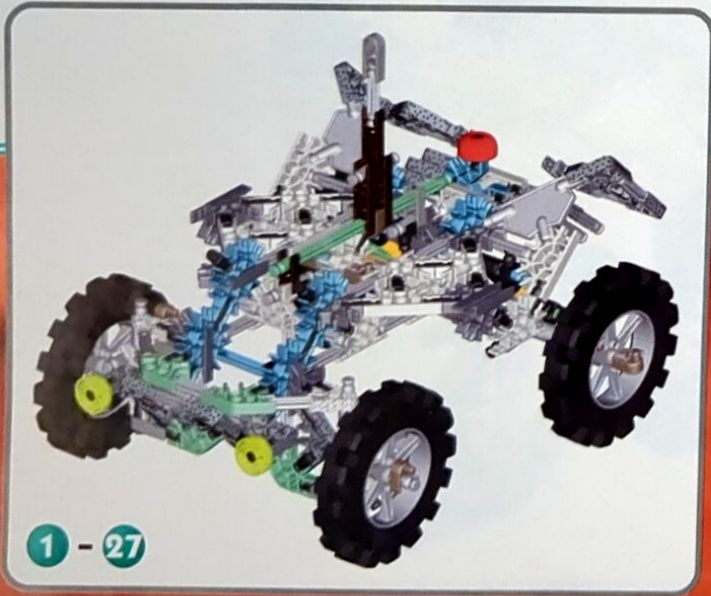

1 - 27

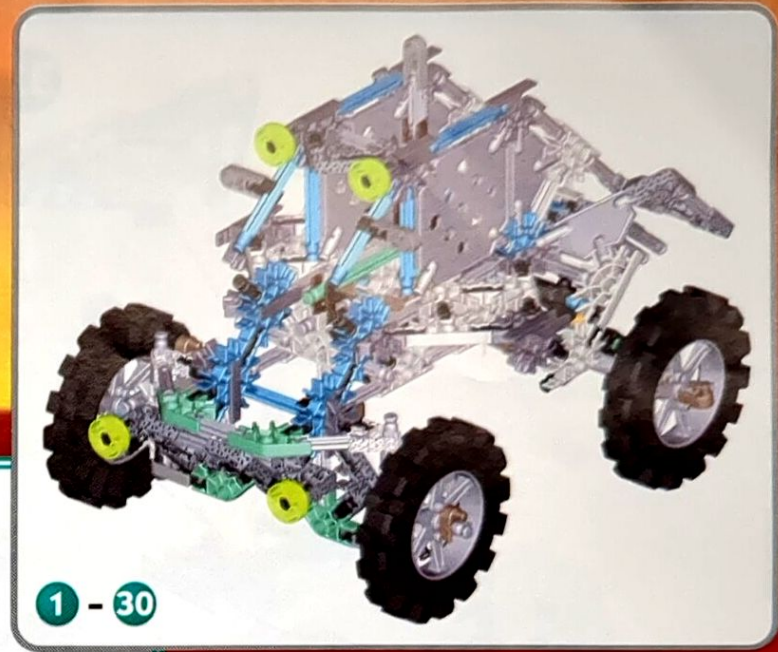
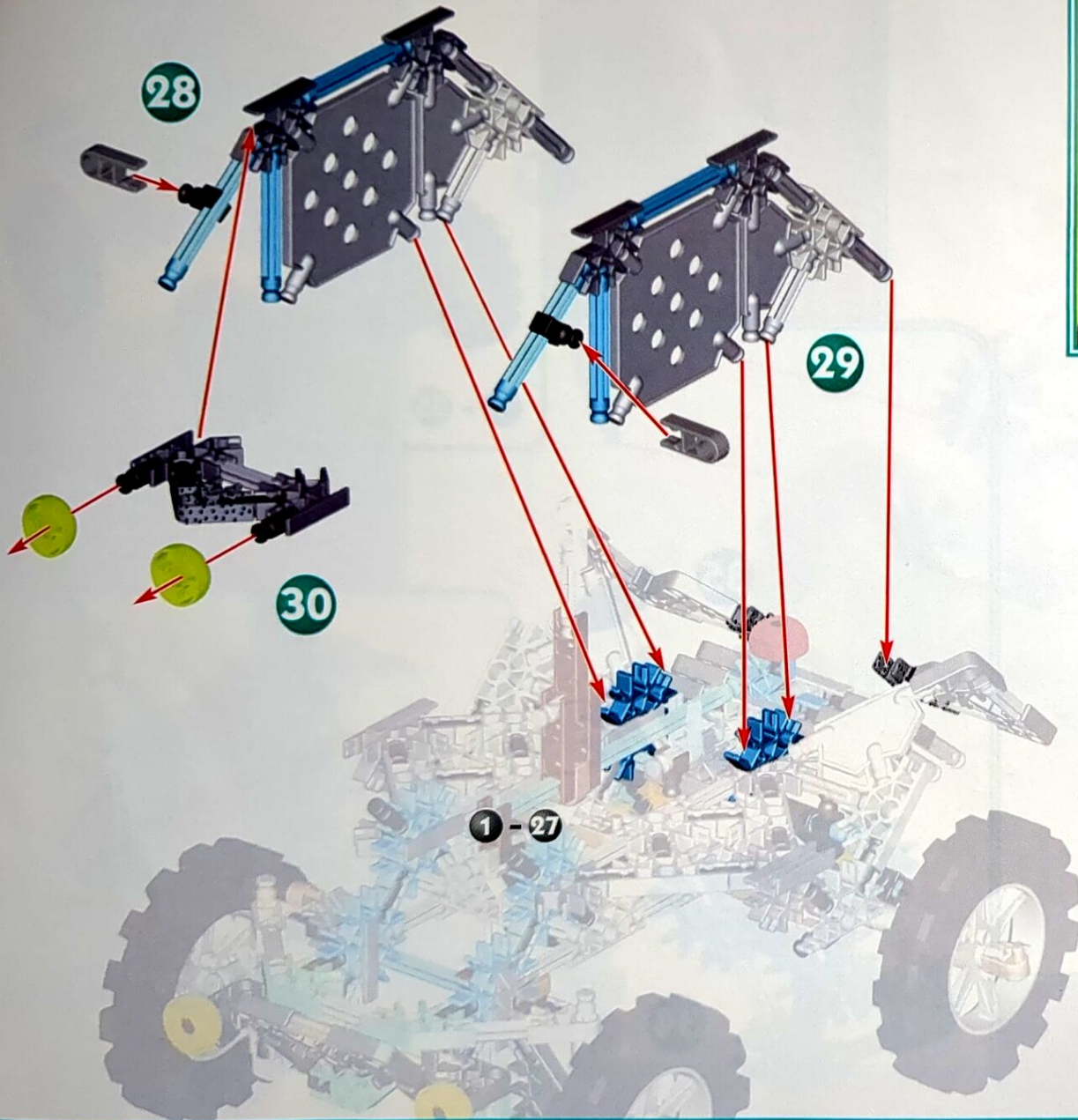

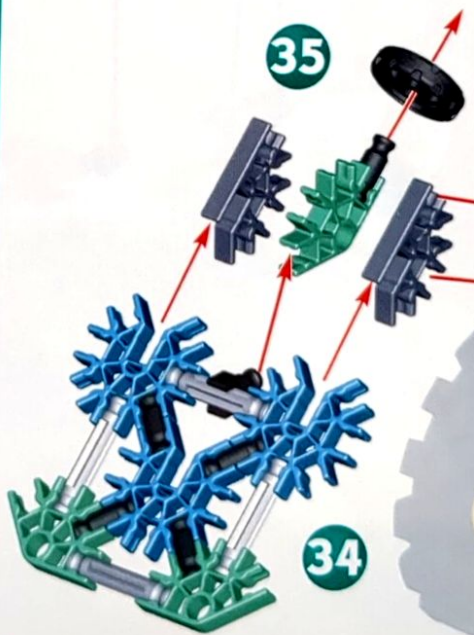
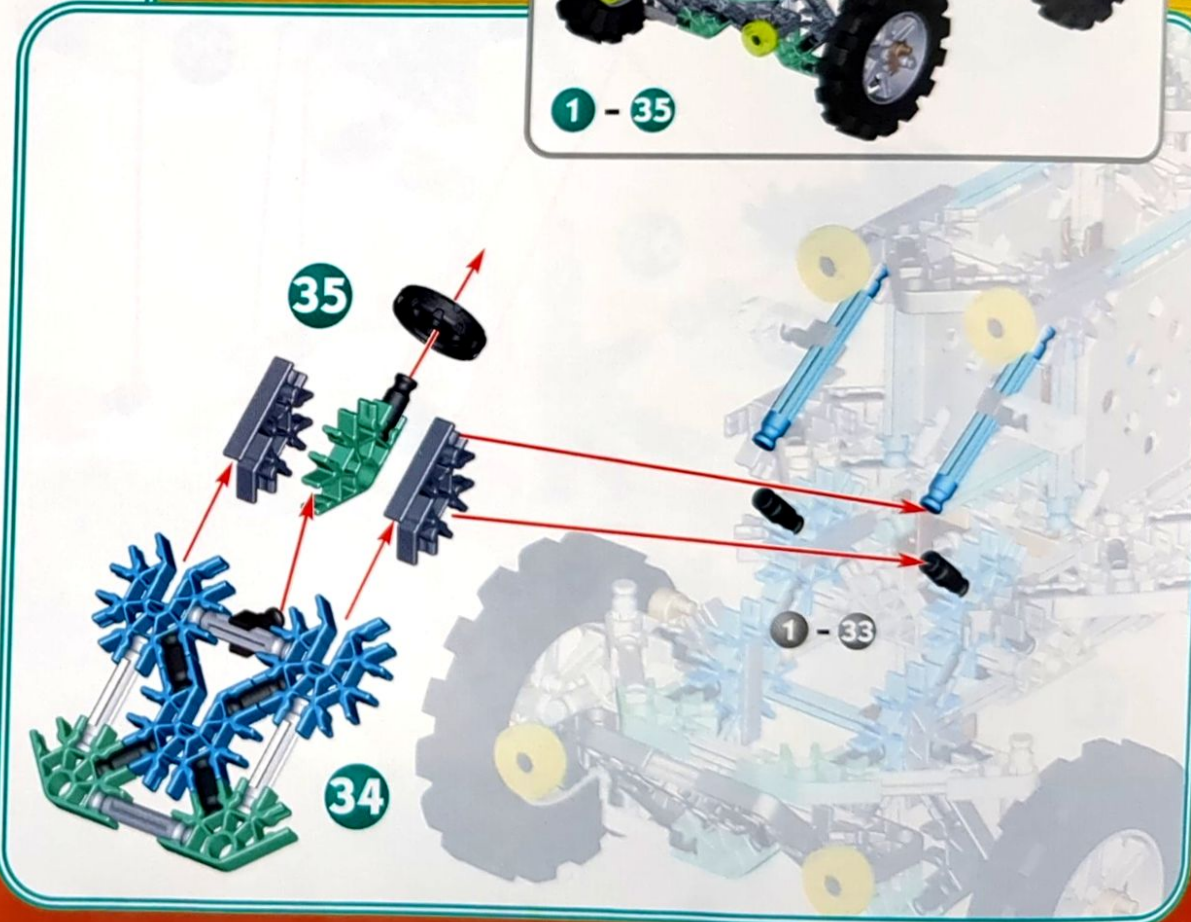
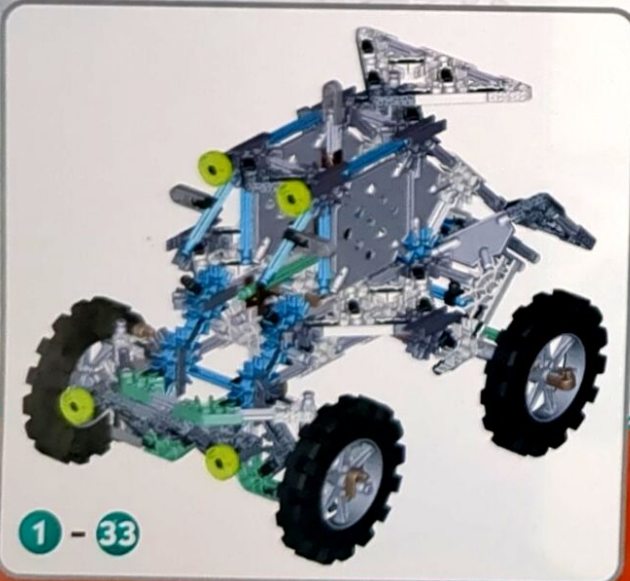
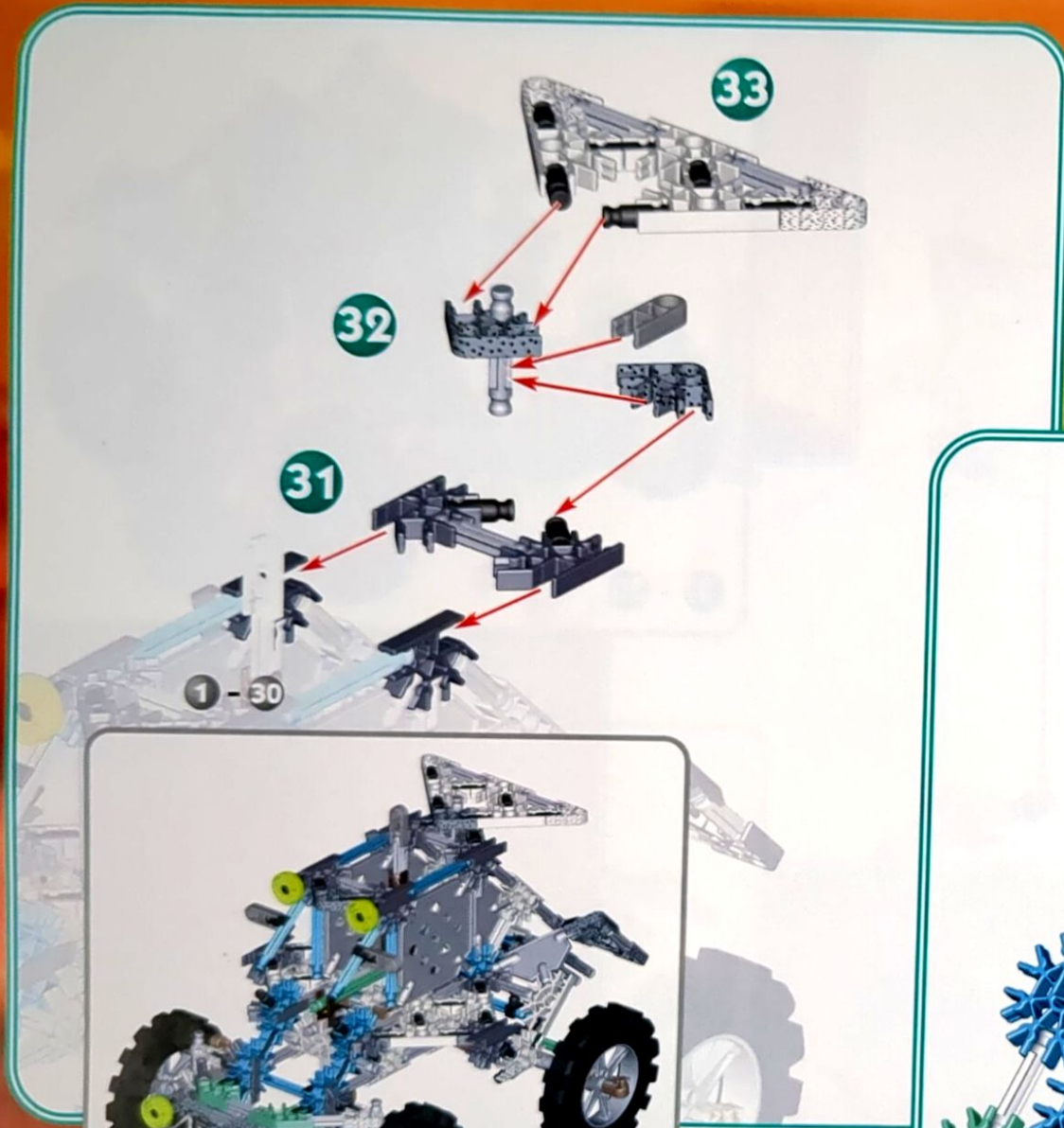

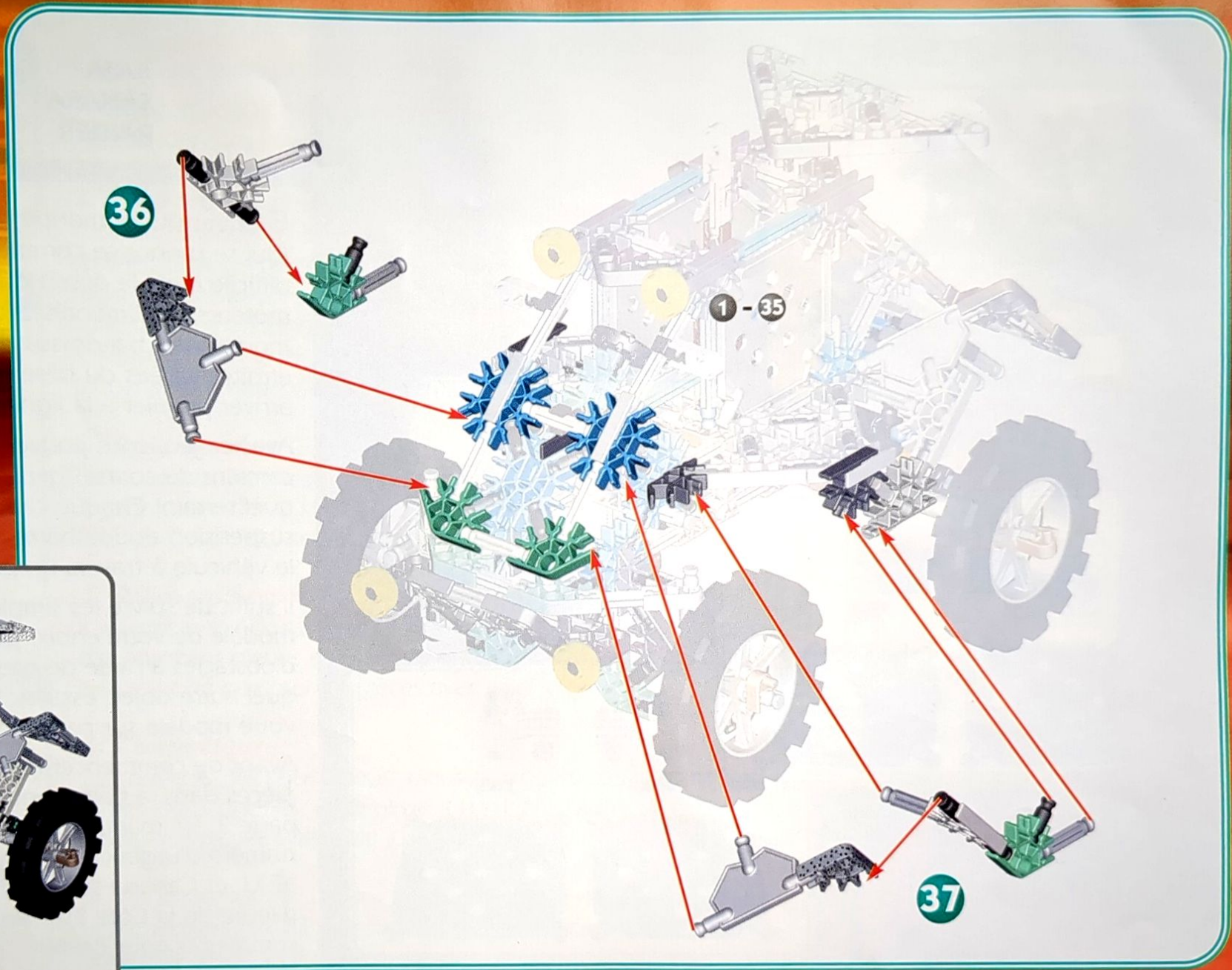

Sticker Placement

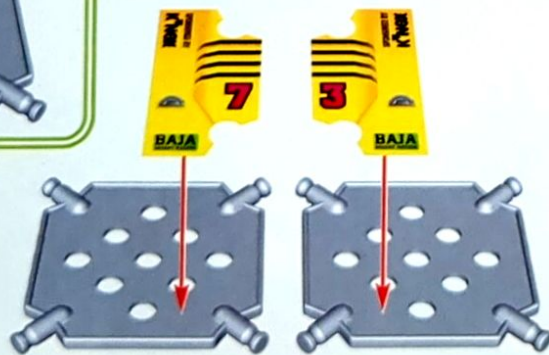
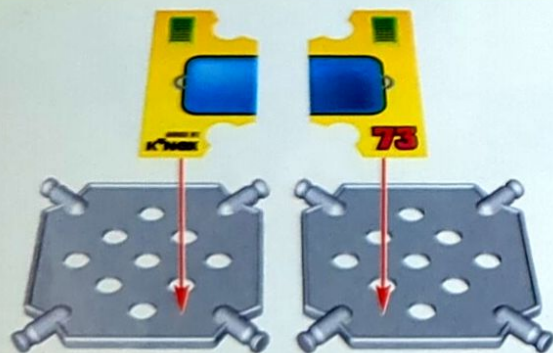
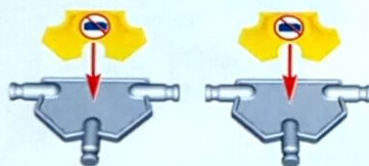
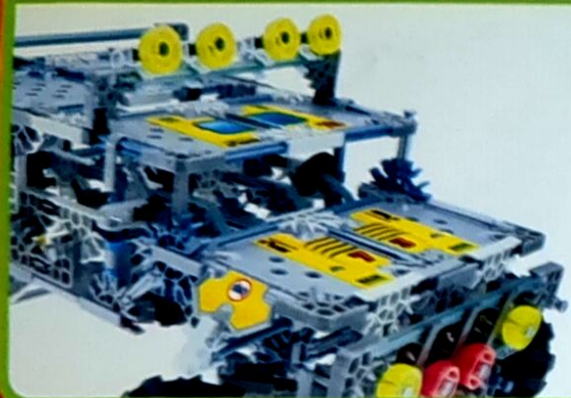

CONTENU

BAJA	5
SAHARA	16
RAIDER	26

Bienvenue au monde de Baja Racing. La course Baja (qui se prononce comme "Baha") est une course très difficile dans le désert durant laquelle des camions à moteurs suralimentés circulent à grande vitesse dans les montagnes, par-dessus des roches plates et dans les étroites vallées du désert dans la cadre d'une lutte par arriver premier à la ligne d'arrivée!

Avec ce jeu, vous pouvez construire et monter 3 robustes camions de course "genre Baja" pour affronter n'importe quel terrain! Chaque camion comporte une solide suspension et une barre de conduite pour manoeuvrer le véhicule à travers un parcours difficile!

Il suffit de suivre les simples consignes pour monter le modèle de votre choix, puis, de créer un parcours d'obstacles à l'aide de coussins, de livres et de n'importe quel autre objet. Essayez maintenant de manoeuvrer votre modèle sur ce parcours ... Vous en êtes capable!

Avant de commencer le montage, compare d'abord les pièces dans la boîte avec les pièces énumérées à la page 3. S'il manque quelque chose, appelle notre numéro d'urgence Kid K'NEX: 1-800-KID-KNEX (É.-U. et Canada seulement) entre 8h30 et 17 heures (Heure de la Côte Est), de lundi à vendredi. Nous sommes là pour t'aider!



1

Comment construire et monter avec K'NEX

1. Bonjour! Je suis ton camarade de montage K'NEX. Lorsque tu me vois dans les instructions, fais très attention aux détails indiqués.

2. Prépare-toi à construire

Pour commencer le modèle, trouve le numéro **1** et suis les chiffres. Chaque pièce a sa propre forme et couleur. Il suffit de regarder l'illustration, de trouver les pièces dans ton jeu qui correspondent à ce que tu vois et de les enclencher. Essaie de tenir le modèle dans le même sens que dans l'illustration. Ainsi, tes pièces seront attachées correctement.

3. Continuation

Les couleurs affaiblies indiquent que cette partie est déjà montée. Tu dois raccorder la nouvelle partie à l'endroit indiqué par les flèches. Ces pièces seront en pleine couleur.

4. Pièces d'écartement

Il y a des endroits dans ton modèle où tu dois ajouter des pièces d'écartement bleues et argentées. Assure-toi d'utiliser la couleur exacte et de compter les pièces avec soin.

5. Connecteurs

Tu trouveras des connecteurs bleus et argents comportant des fentes extra-longues. Ils se glissent l'un dans l'autre tel qu'illustré. Pousse les pièces ensemble jusqu'à ce que tu entendes un "déclat".

6. Amortisseurs

Les amortisseurs K'NEX viennent en deux pièces. Poussez-les ensemble jusqu'à ce que vous entendiez un "déclat".

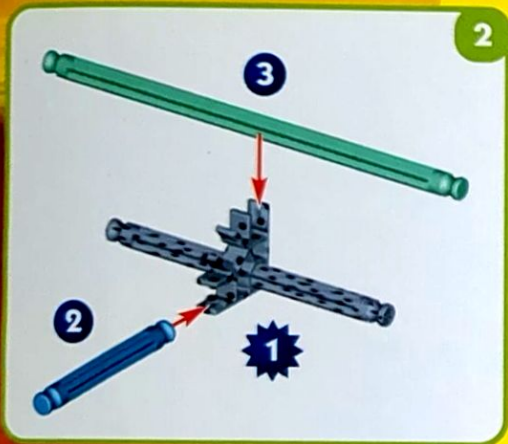

2

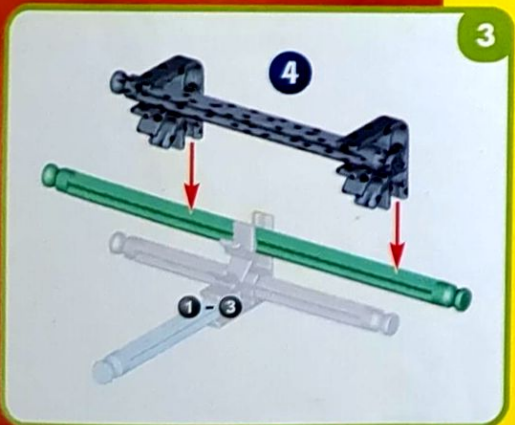

3

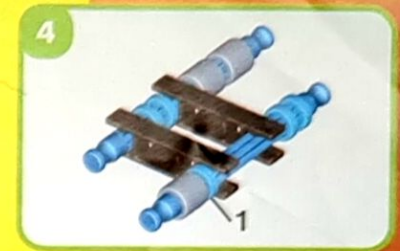

4

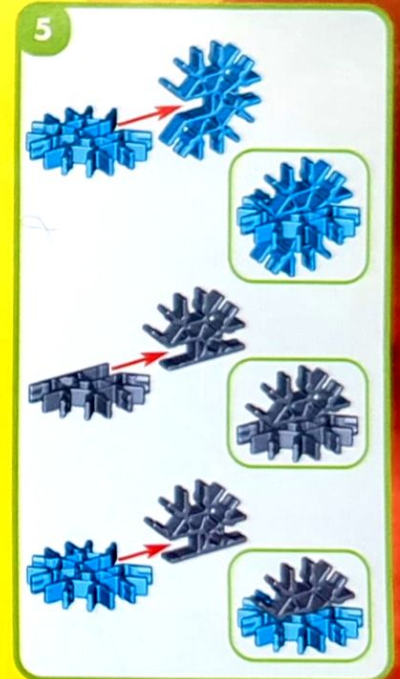

5



6

K'NEX[®]

COOL MACHINES[™]

BAJA
DESERT RACER

ALSO BUILDS
SAHARA

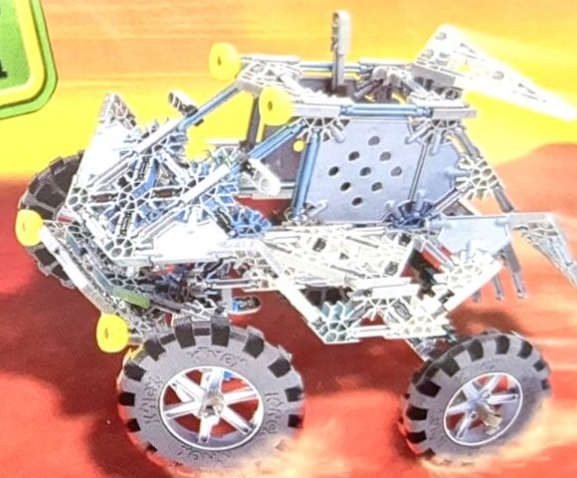
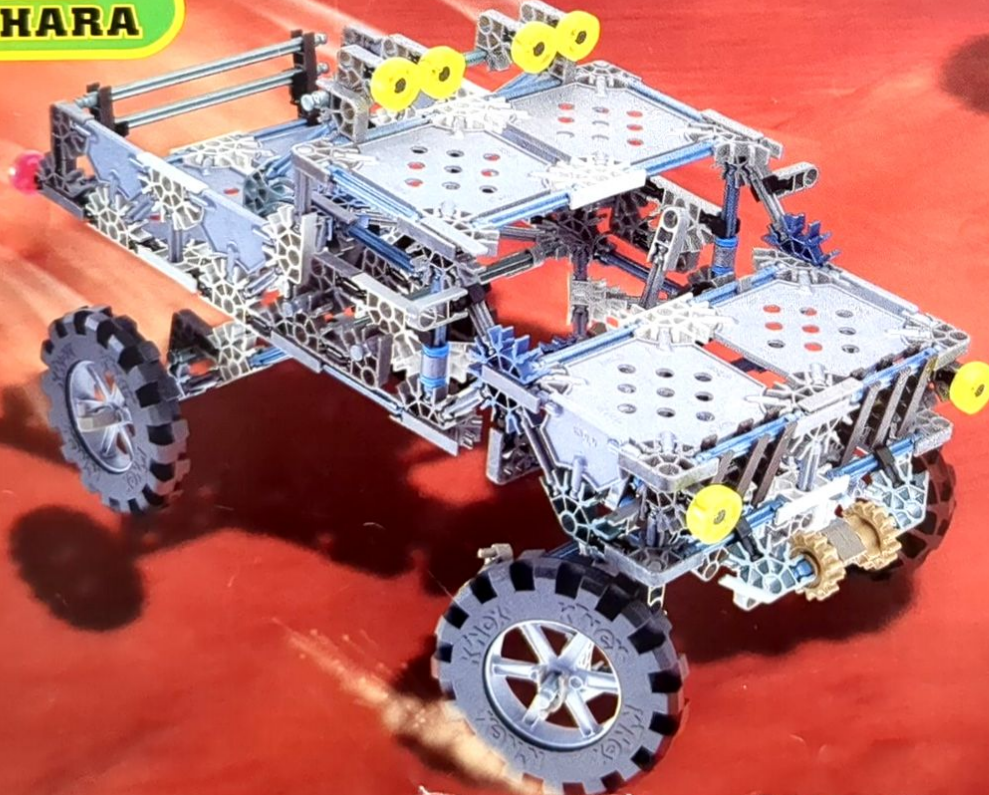

ALSO BUILDS
RAIDER

Colors and product may vary.

Le produit et les couleurs peuvent varier.

K'NEX is a registered trademark of K'NEX Industries, Inc.

K'NEX est une marque déposée de K'NEX Industries, Inc.

Manufactured under U.S. Patents: *Fabrique sous brevets américains* 5,061,219; 5,137,486; 5,199,919; 5,238,438; 5,346,420; 5,350,331; 5,368,514; 5,421,762; 5,423,707; 5,427,559; 5,518,435; D383,509; D388,475; D389,203; D391,843; D391,921; D392,555. Other U.S. and foreign patents pending. *Autres brevets américains et étrangers en instance.*

Conforms to the Requirements of ASTM Standard Consumer Safety Specification on Toy Safety, F963-96a.

Conforme aux spécifications de sécurité du consommateur sur la sécurité des jouets de la norme ASTM F963-96a.

Questions? Call us
at 1-800-KID-KNEX
(USA/Canada only)
www.knex.com

©2000 K'NEX Industries, Inc.
P.O. Box 700
Hatfield, PA 19440-0700



Made in the U.S.A.
Fabrique aux Etats-Unis

93168-V1-11/00