

K'NEX[®]
Building Worlds Kids Love[®]

**DUAL
CROSS**
BUILDING SET

**DOUBLE
ARBALÈTE**
JEU DE CONSTRUCTION

K'FORCE[™]
BUILD AND BLAST



**FIRES UP TO
75 ft!**
**TIRE À PLUS DE
22m! ****

**BUILDS
CONSTRUIT LES***

6



WARNING:

Do not aim at eyes or face. TO AVOID INJURY: Use only foam darts designed for this product. Do not modify foam dart or Blaster Chamber.



ATTENTION :

Ne pas viser les yeux ni le visage. POUR ÉVITER TOUTE BLESSURE : Utiliser uniquement les fléchettes en mousse conçues pour ce produit. Ne pas modifier les fléchettes en mousse ou la chambre du blaster.

8+

47526



DUAL CROSS
BUILDING SET
DOUBLE
ARBALÈTE
JEU DE CONSTRUCTION



(EN) To be used under direct supervision of an adult. Read instructions before using toy. Always wear appropriate eyewear (not included).

WARNING: CHOKING HAZARD – Small parts. Not for children under 5 years.

WARNING: Do not aim at eyes or face. TO AVOID INJURY: Use only foam darts designed for this product. Do not modify foam dart or Blaster Chamber.

Never look down the barrel of the blaster with naked eye if charged or loaded. Do not fire at point blank range. Do not shoot at people not wearing appropriate eyewear. Do not shoot or aim at animals. Do not store blaster charged and loaded. Be aware darts can change direction when hitting objects. If target pieces separate, rebuild before using again. Keep this information for future reference.

(FR) À utiliser sous la surveillance directe d'un adulte. Lire les instructions avant d'utiliser le jouet. Toujours porter des lunettes de protection appropriées (pas inclus).

ATTENTION : RISQUE D'ÉTOUFFEMENT – Pièces de petite taille. Ne convient pas aux enfants de moins de 5 ans.

ATTENTION : Ne pas viser les yeux ni le visage. POUR ÉVITER TOUTE BLESSURE : Utiliser uniquement les fléchettes en mousse conçues pour ce produit. Ne pas modifier les fléchettes en mousse ou la chambre du blaster.

Ne jamais regarder dans le canon de l'arme chargée sans porter de lunettes de protection. Ne pas tirer à bout portant. Ne pas tirer sur des personnes ne portant pas de lunettes de protection appropriées. Ne pas tirer sur les animaux et ne pas pointer l'arme dans leur direction. Ne pas ranger l'arme chargée. Attention, les fléchettes peuvent changer de direction en ricochant sur des objets. Si des pièces de la cible se séparent, la remonter avant de l'utiliser à nouveau. Garde précieusement cette notice pour t'y référer ultérieurement.



BUILDING BASICS
ESENCIALES DE CONSTRUCCIÓN

Start Building

To begin your model, find the **1** and follow the numbers. Each piece has its own shape and color. Just look at the pictures, find the pieces in your set that match and then connect them together. Try to face your model in the same direction as the instructions while you build. The arrows show you where the parts connect, but not all connections points have arrows. Faded colors show you the section is already built.

Démarrer La Construction

Pour commencer le modèle, trouver l'étape numéro **1** trouver les numéros. Chaque pièce a sa propre forme et sa propre couleur. Regarder les illustrations, trouve les pièces qui correspondent à l'illustration et les assembler. Pour vous faciliter la tâche, orienter le modèle dans le même sens que les instructions. Les flèches indiquent où les pièces s'assemblent, mais les points de raccordement n'ont pas tous des flèches. Les pièces de couleur délavées sont celles déjà assemblées.



Spacers

There are places in your model where you need to use spacers. Be sure to use the correct color and number of spacers shown in the instructions.

Espaceurs

Il y a des endroits sur le modèle où des espaceurs sont nécessaires. S'assurer d'utiliser la bonne couleur et le nombre d'espaceurs indiqué sur les instructions.

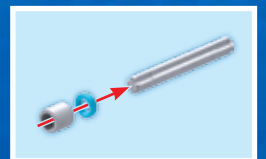

Connectors

You can slide these special connectors together. Push tightly until you hear a "click". Pay close attention to the instructions and position them horizontally or vertically exactly as they are shown.

Connecteurs

Vous pouvez assembler ces connecteurs tout à fait uniques en les faisant glisser l'un dans l'autre. Pousser fort jusqu'au « clic ». Lire les instructions attentivement et les positionner horizontalement ou verticalement, en suivant exactement les illustrations.

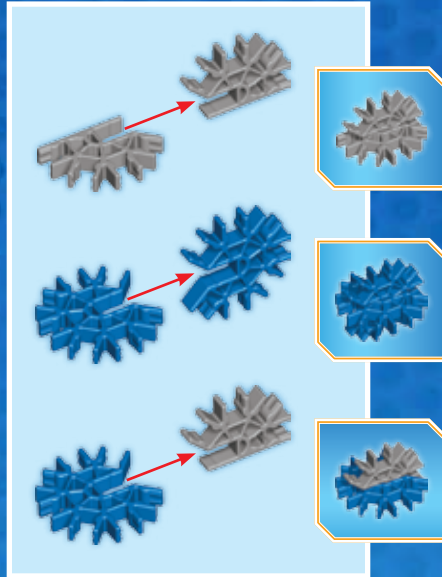

Flexi-Rod

A Flexi-rod is a rod that you bend to make curves. It will be easier to attach to your model if you bend it back and forth first.

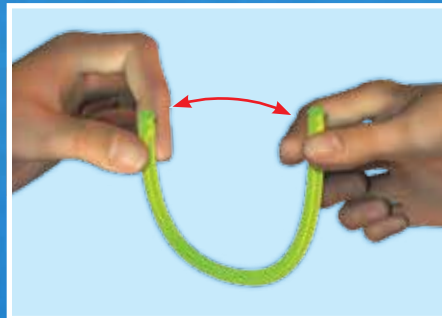

Tiges Flexibles

Un Tiges Flexibles est une tige que tu peux courber pour faire des courbes. Elle pourra être attachée plus aisément à ton modèle si tu la plies en avant et en arrière plusieurs fois.

Buildable Target

Cut out the targets on the back of the box. You can find targets to print and instruction for the model at knex.com/instructions and enter the code **47526**.



Cible Constructible

Découper les cibles à l'arrière de la boîte. Vous pouvez trouver des cibles à l'imprimer et les instructions pour le modèle à knex.com/instructions et entrez le code **47526**.

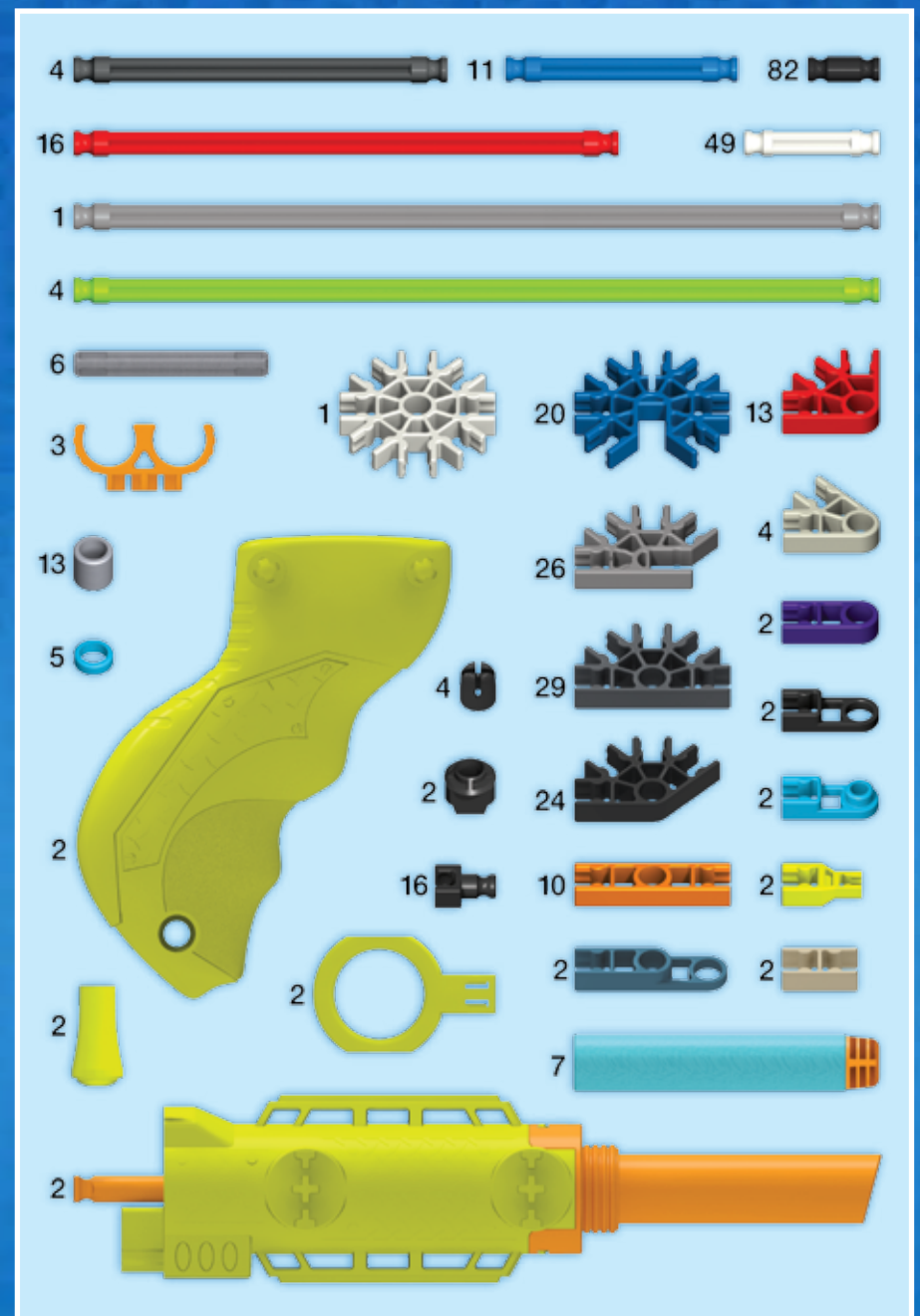

Parts List

Before you start building, be sure to compare the parts in your set with the parts list here. If anything is missing, call or write to us using the information on the back cover. We are here to help you!

Liste Es Pièces

Avant de commencer à construire, assure-toi de comparer les pièces dans ta boîte à la liste de pièces fournie ici. S'il manque quelque chose, téléphone-nous ou écris-nous en te servant des informations figurant au verso de la notice. Nous sommes là pour t'aider !

- 6
- 3
- 1
- 1
- 1
- 1

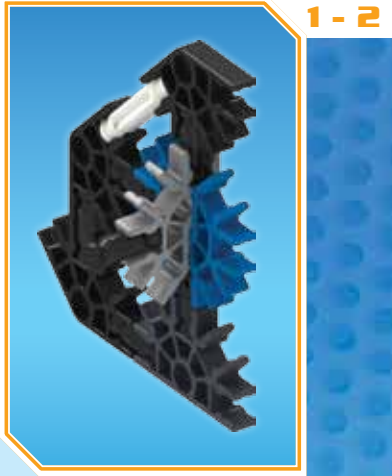

1-2

1

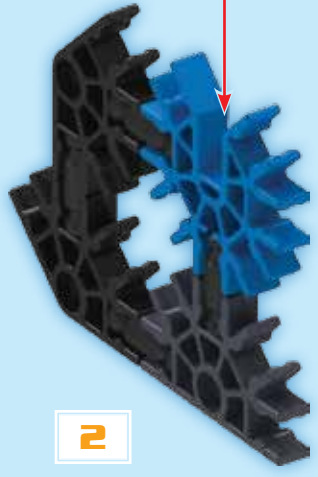
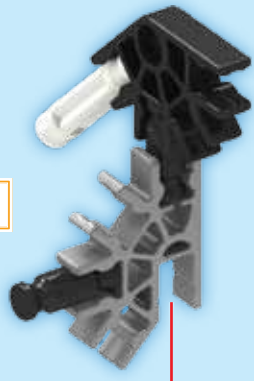

2

- 1
- 3
- 1

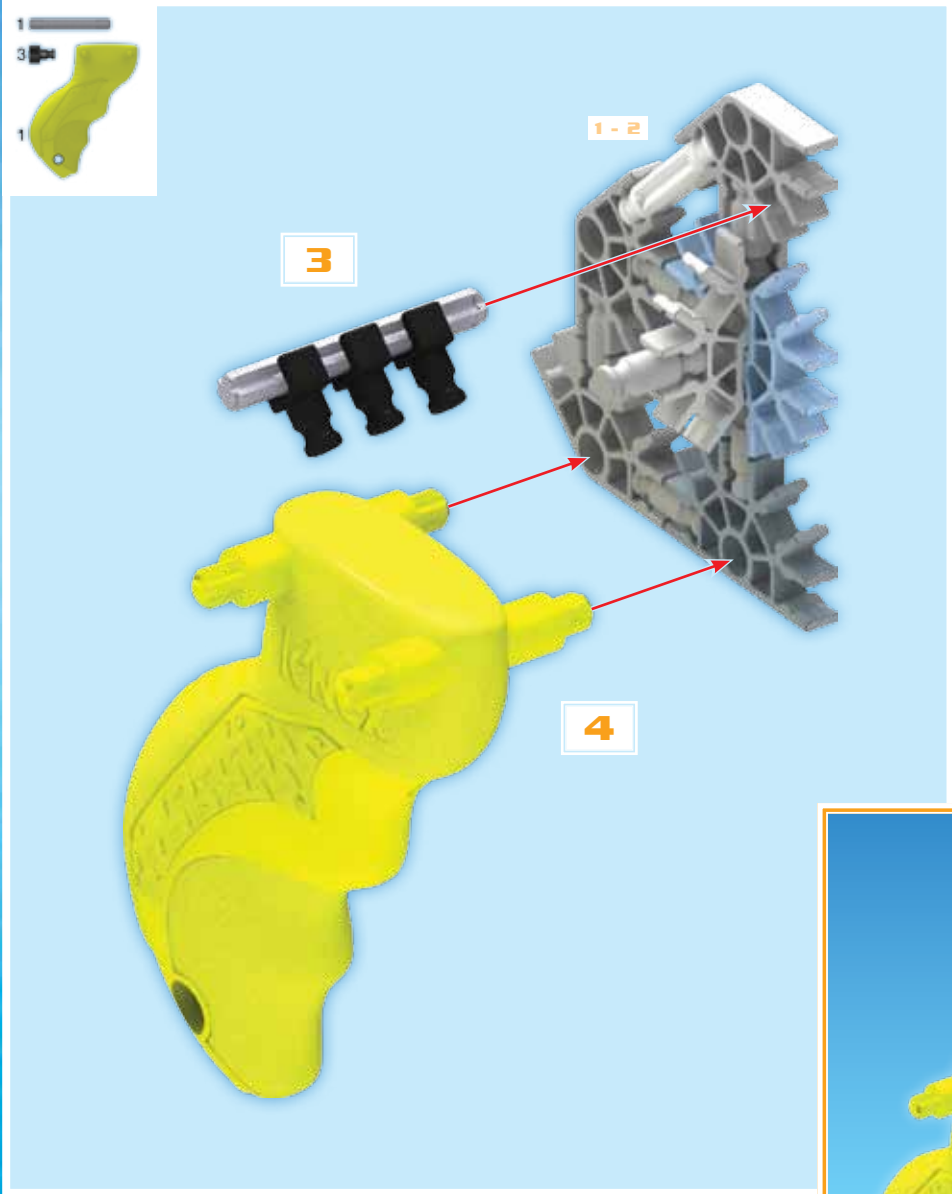

3

1-2

4



1-4

- 3
- 1
- 5
- 1
- 2

5-6



5



6

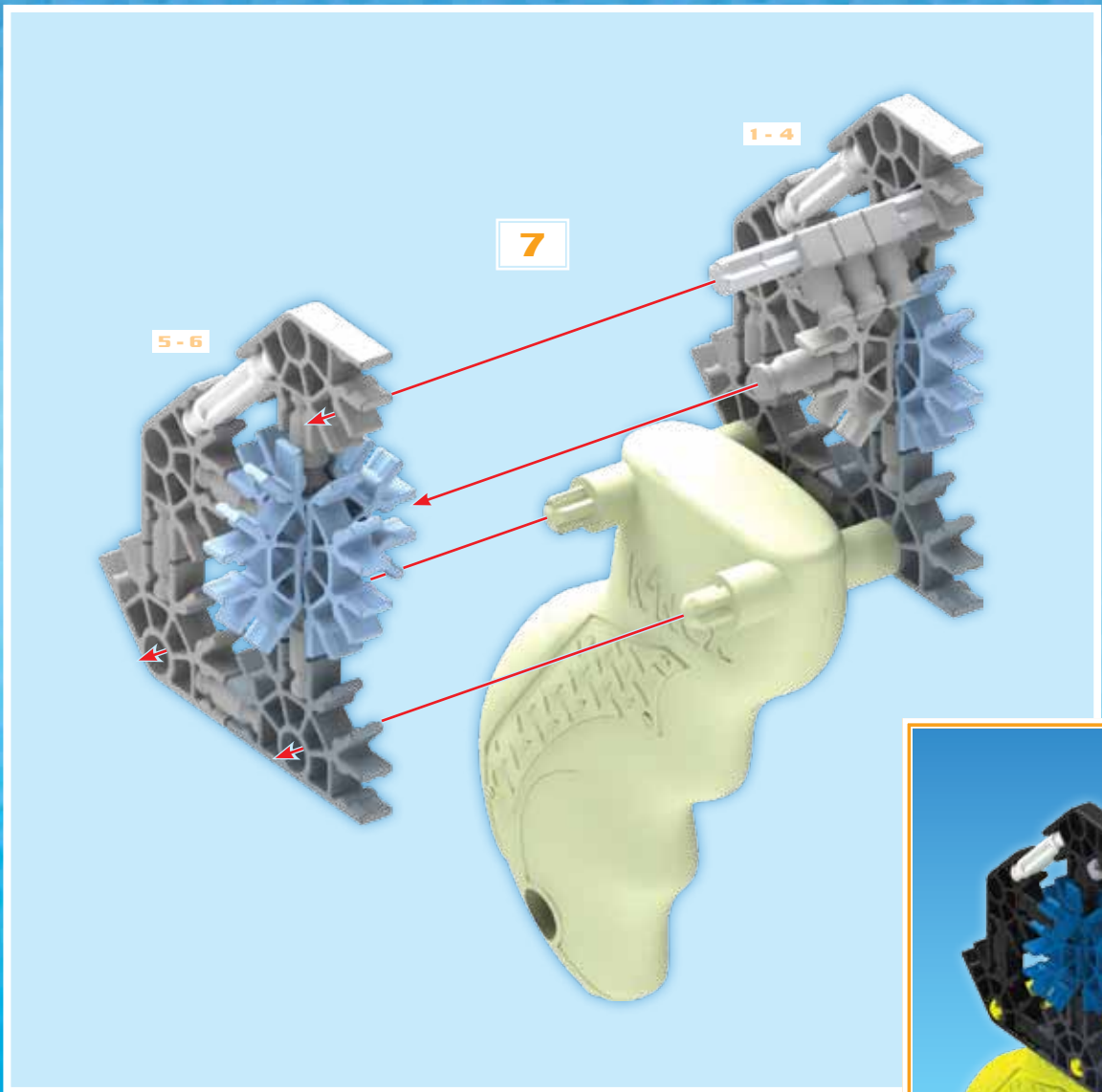
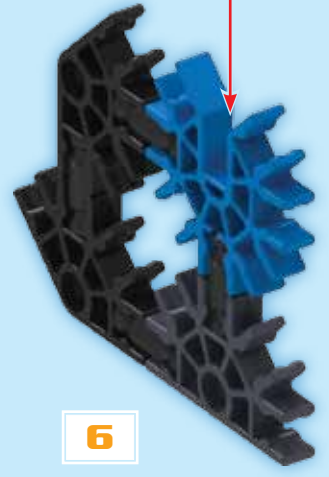

7

5-6

1-4

1-7

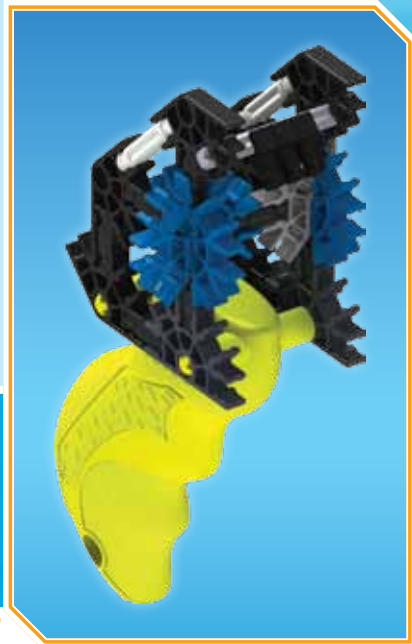

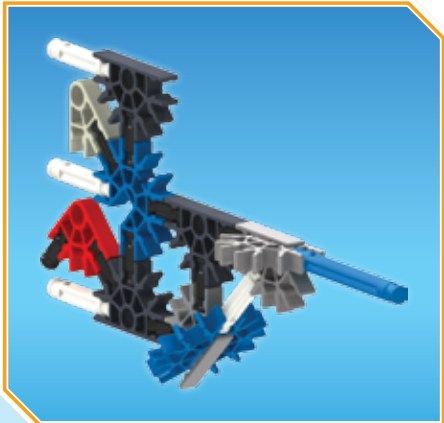
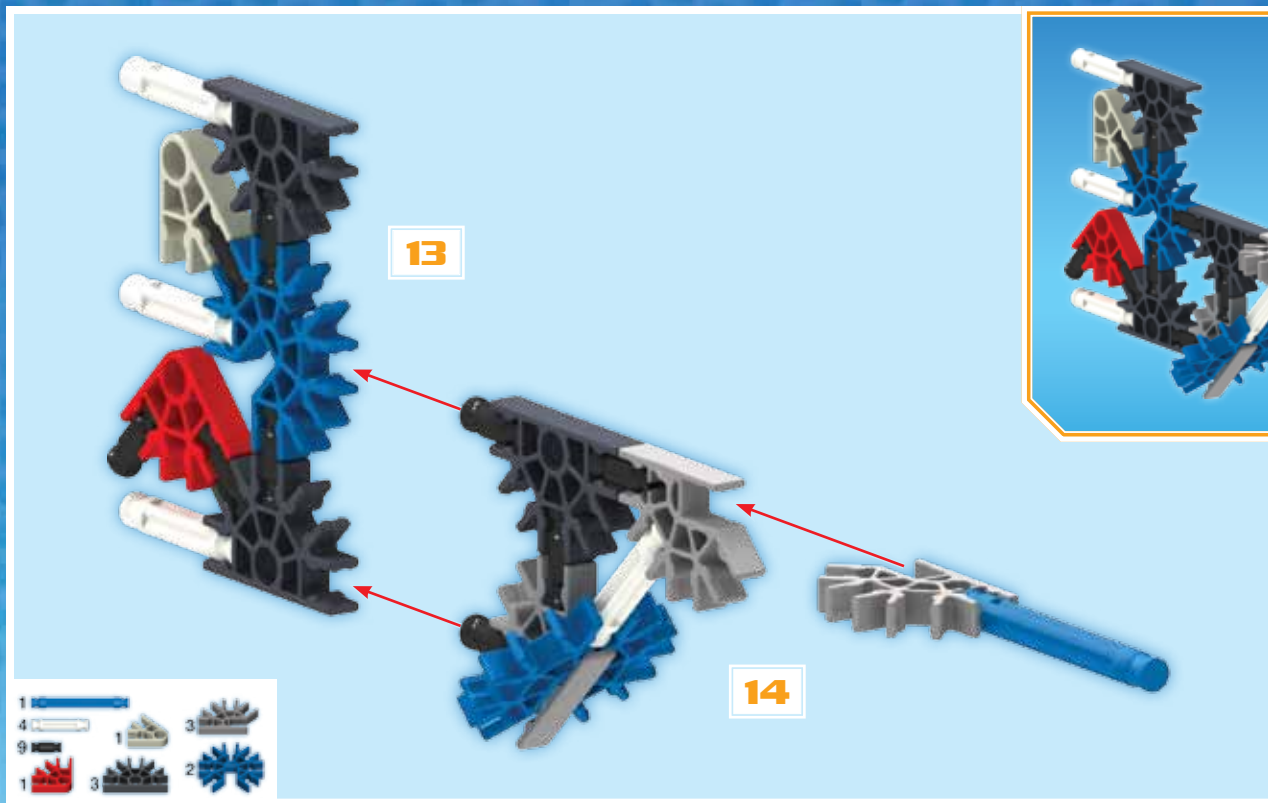

13-14

- 1
- 4
- 9
- 1
- 3
- 2

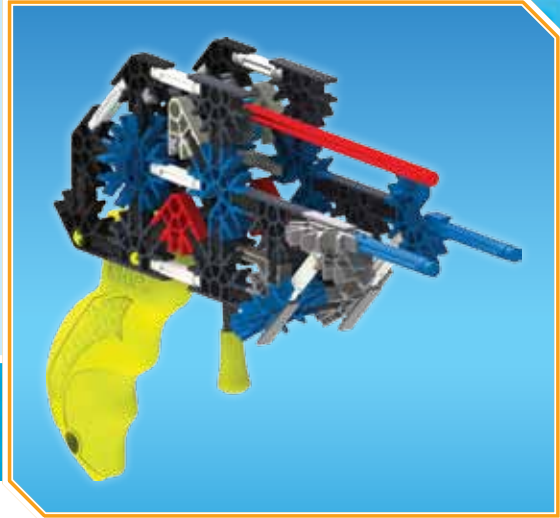
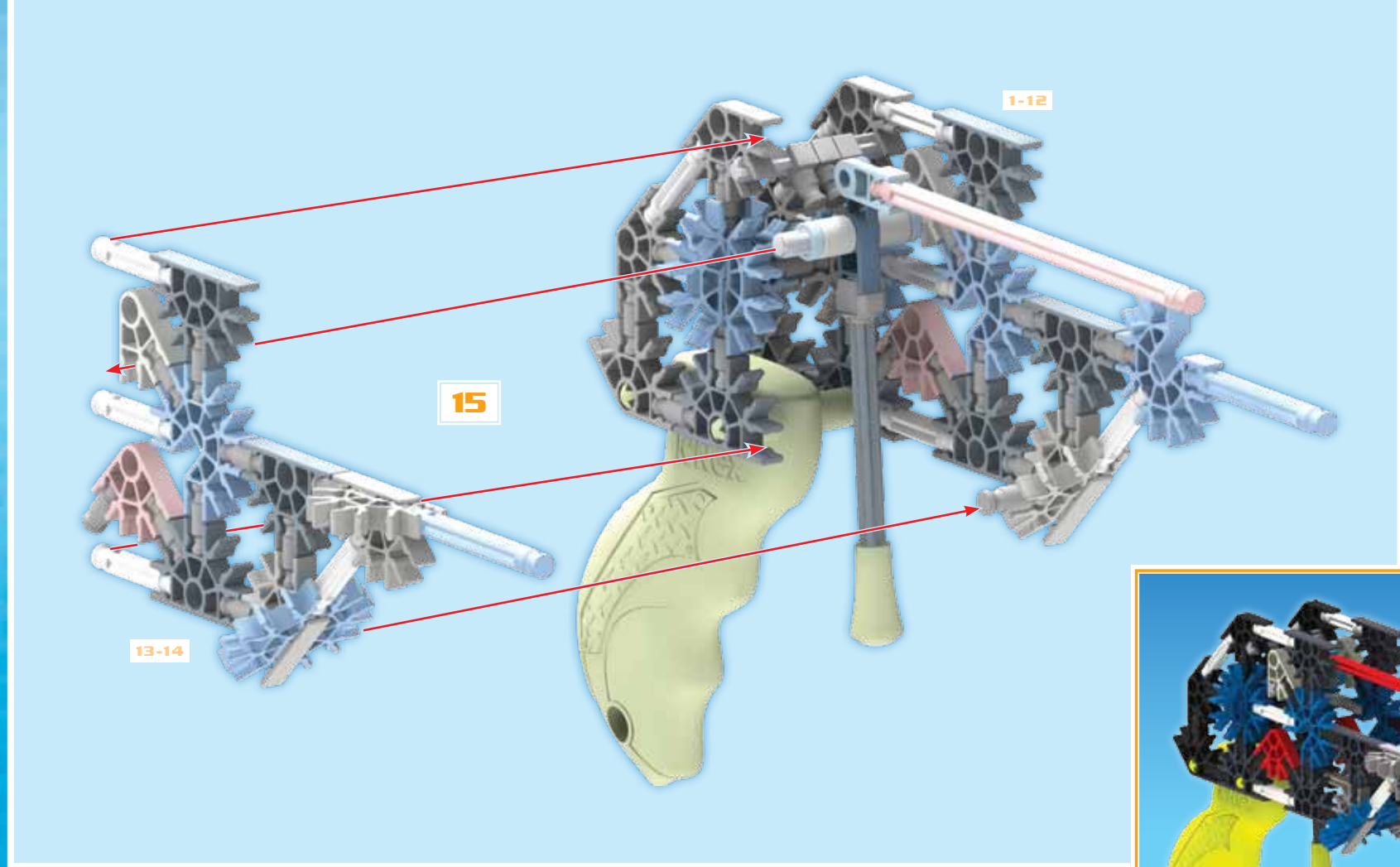

1-15

1-18

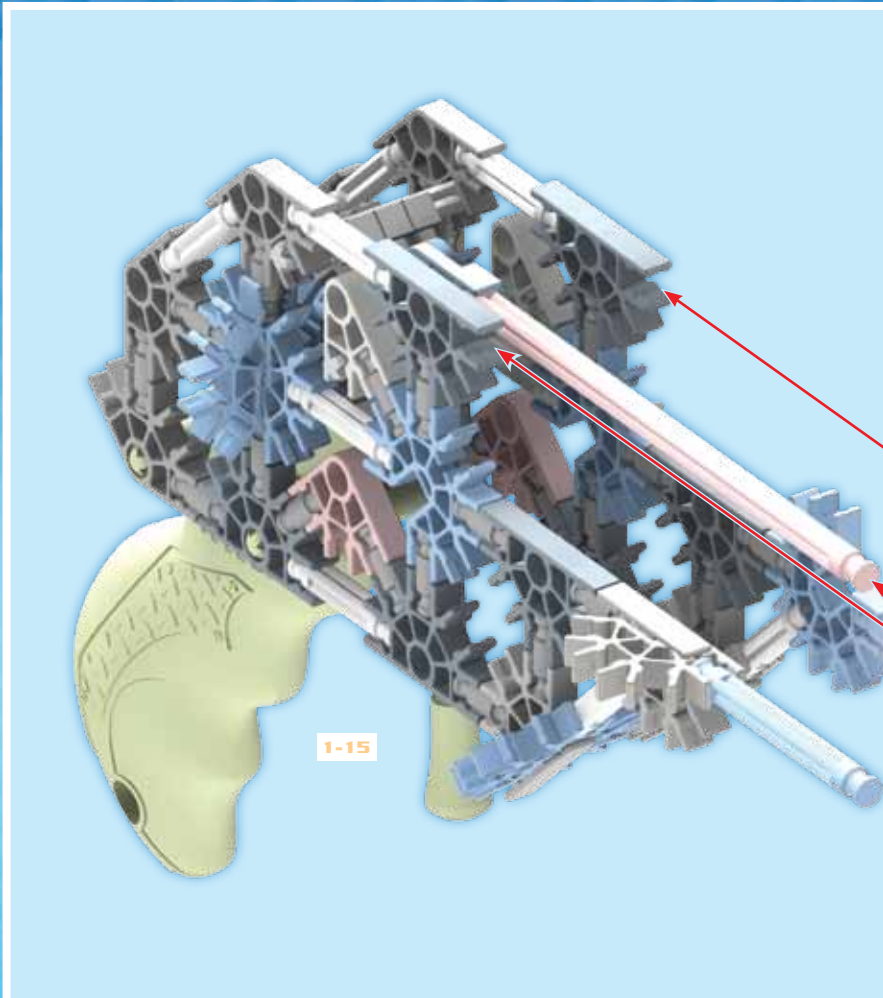
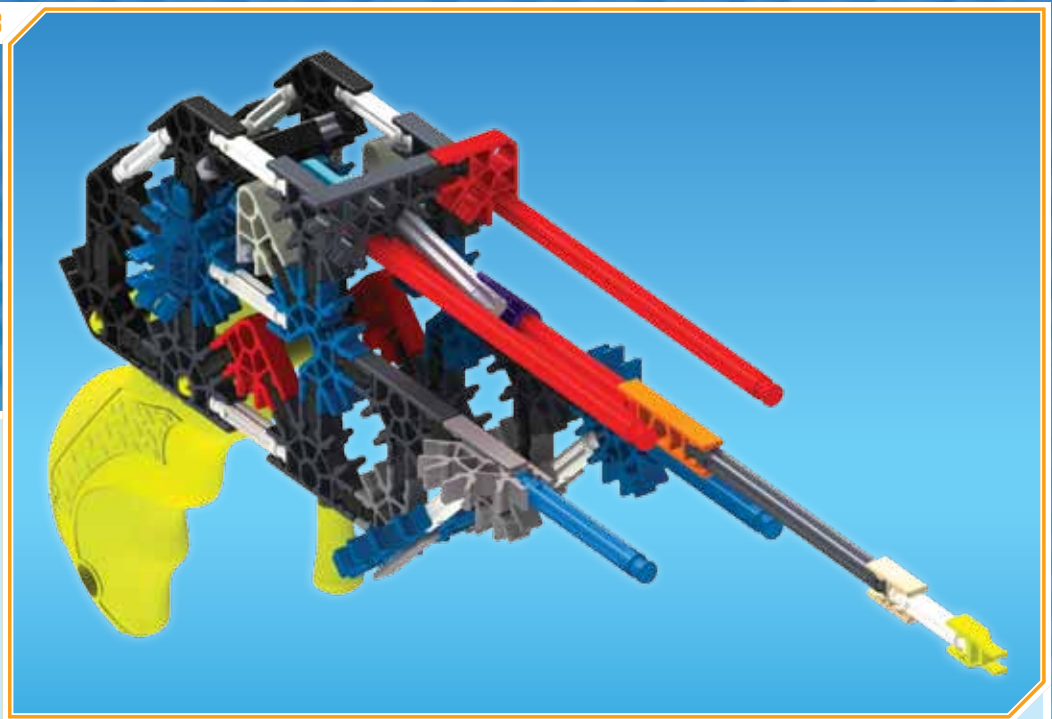

17

16

18



- 1 [Grey Axle]
- 1 [Yellow Gear]
- 1 [Red Beam]
- 1 [Blue Beam]
- 1 [Black Gear]
- 1 [Red Gear]
- 1 [Black Gear]

16

1-19

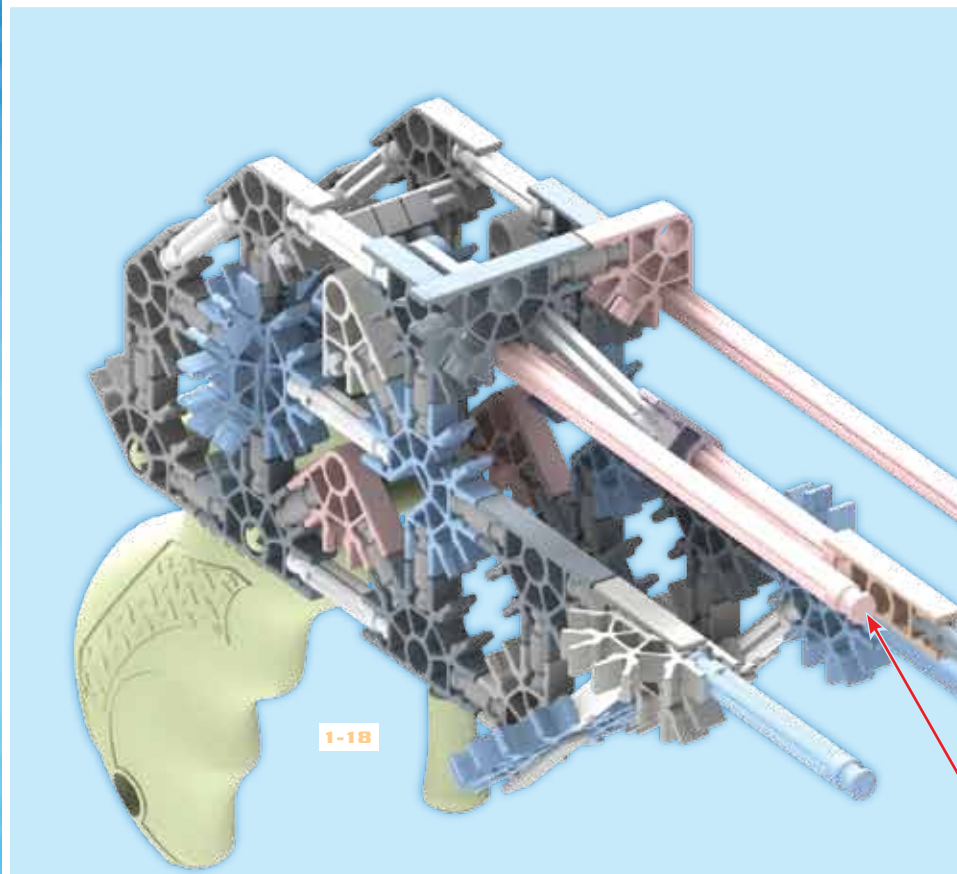
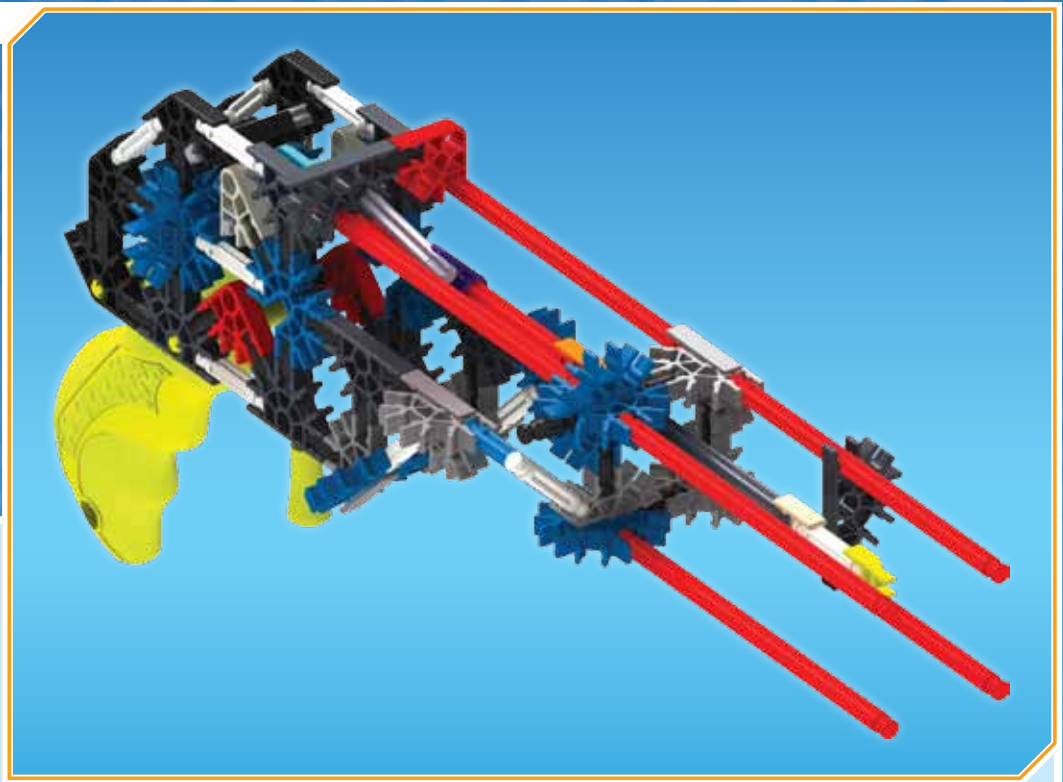

1-18

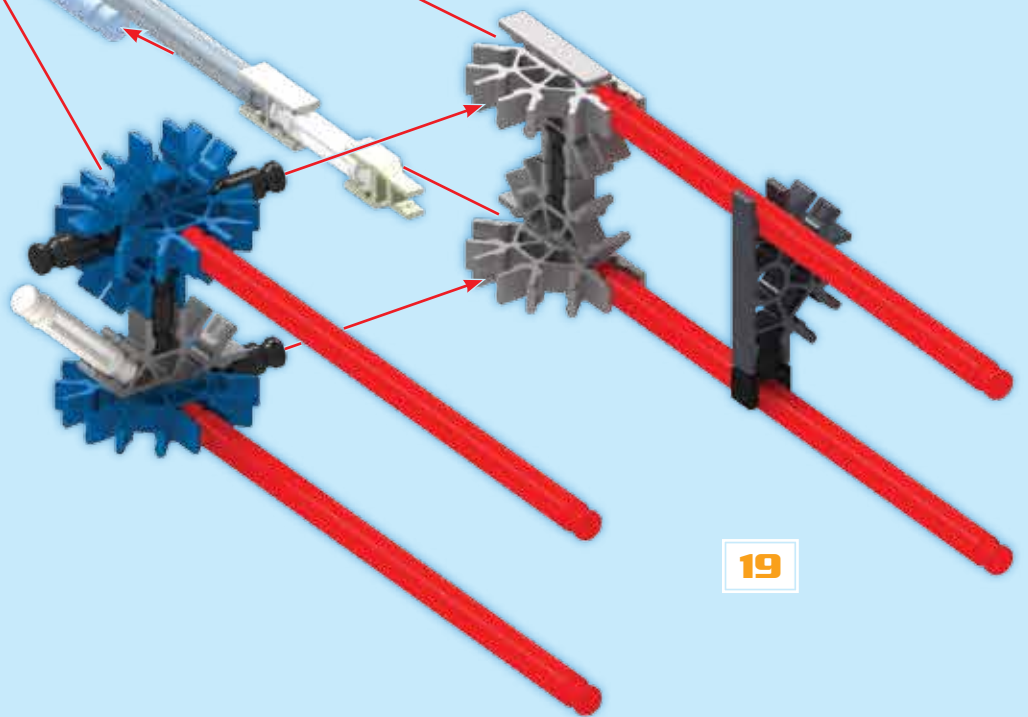

19



1-23

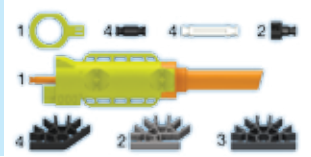
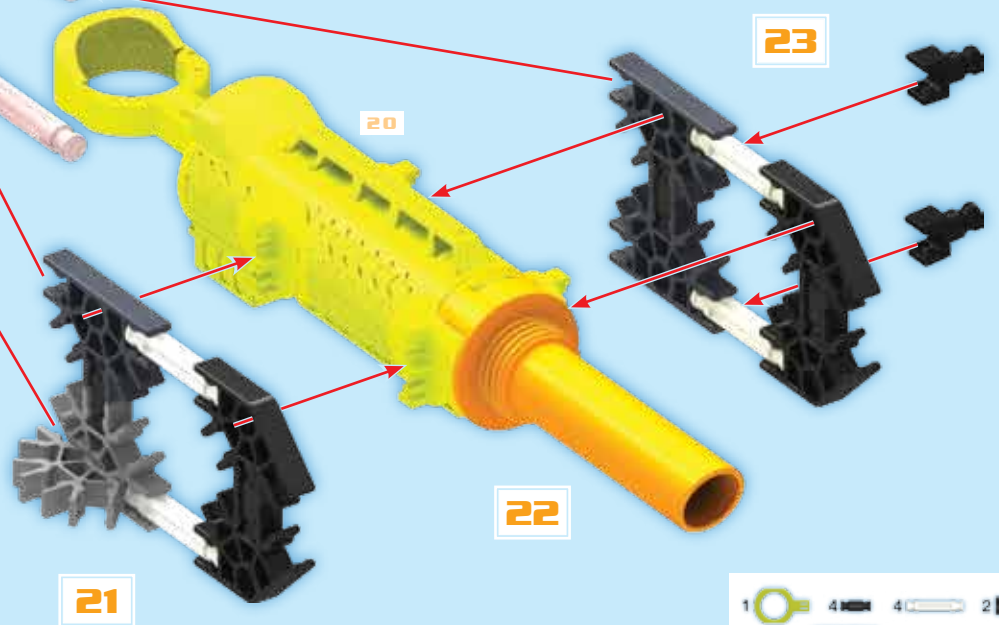
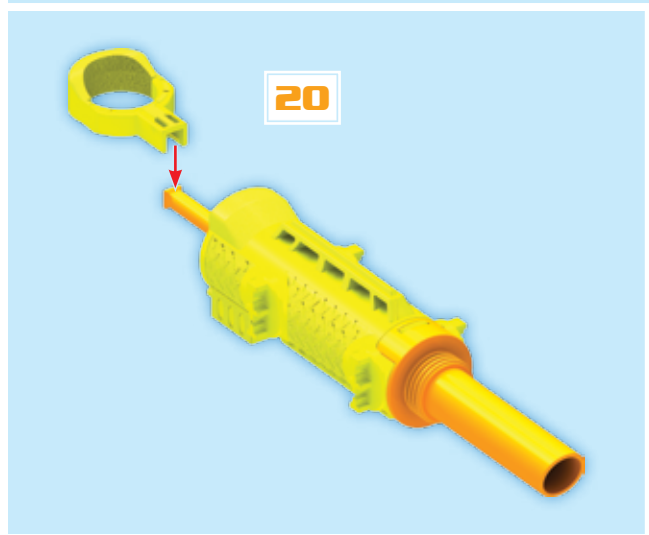
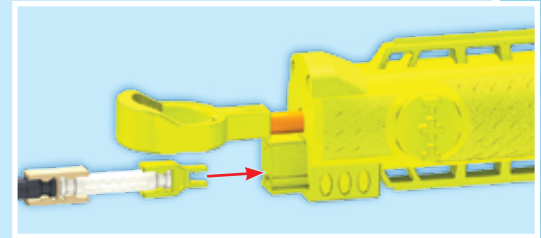
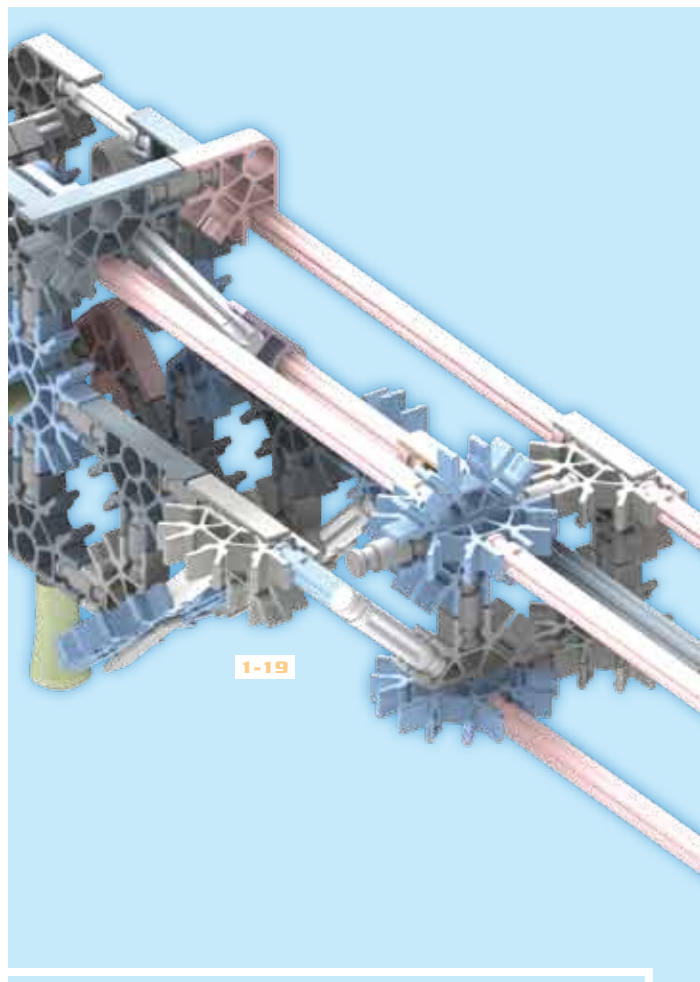
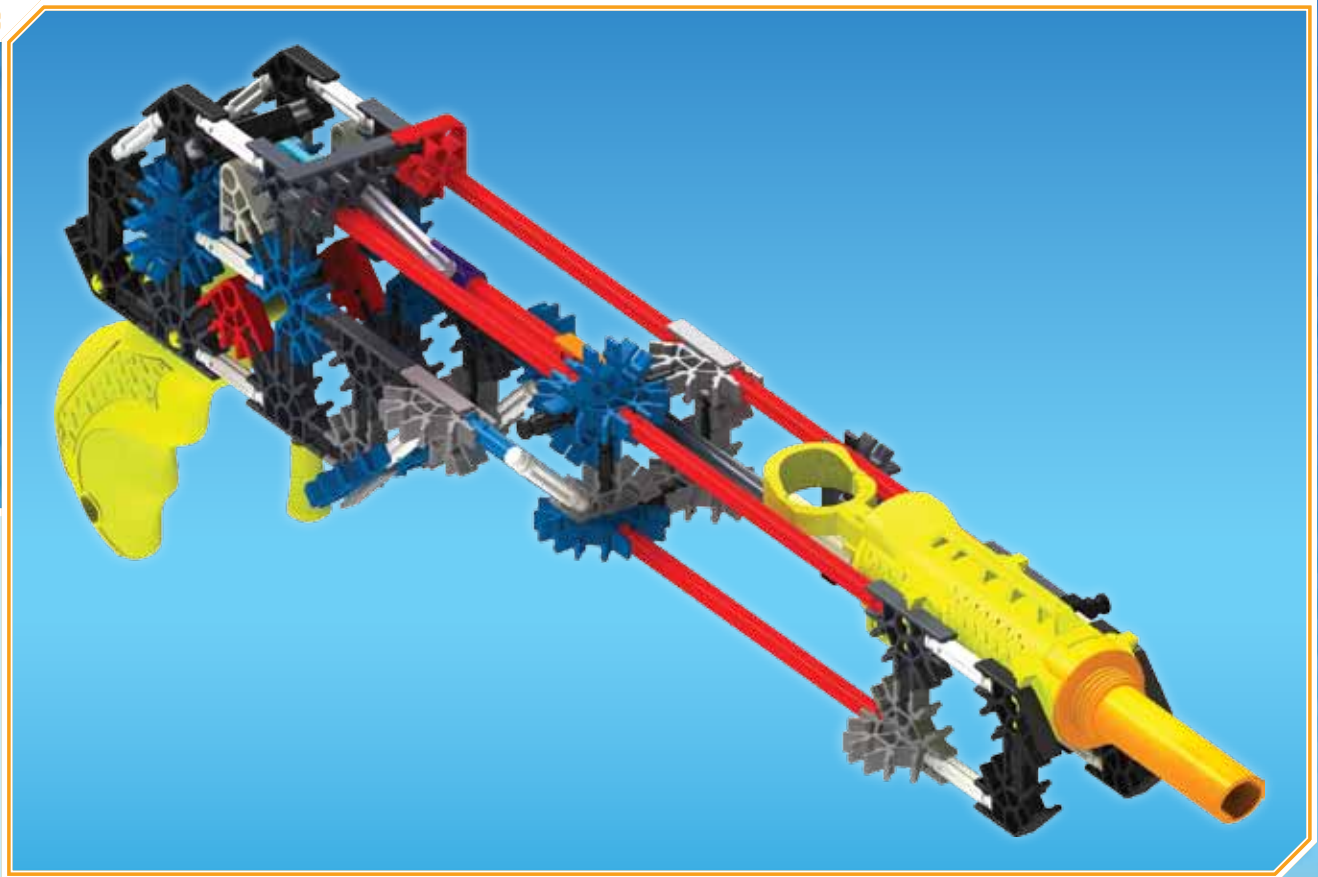

1-24

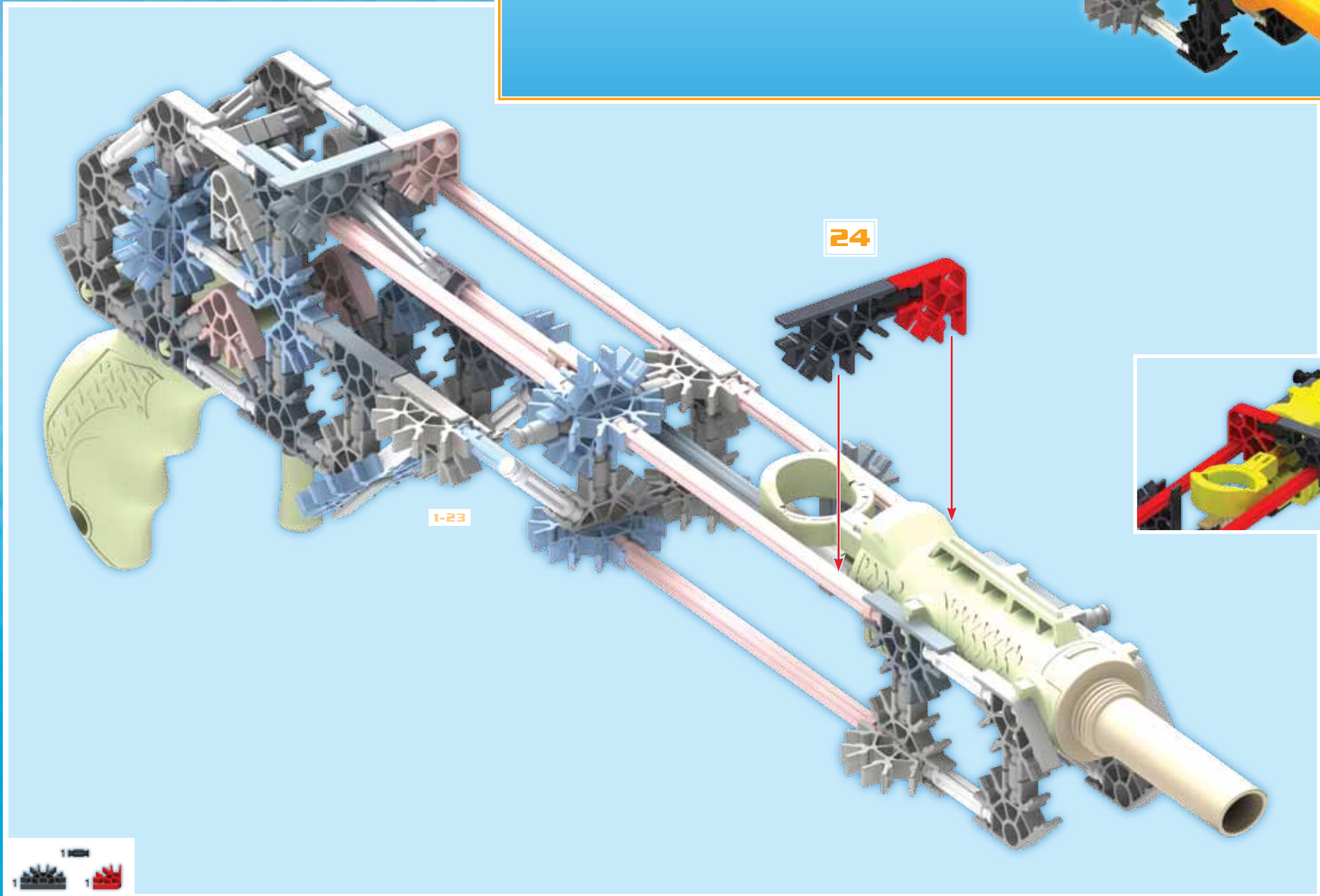
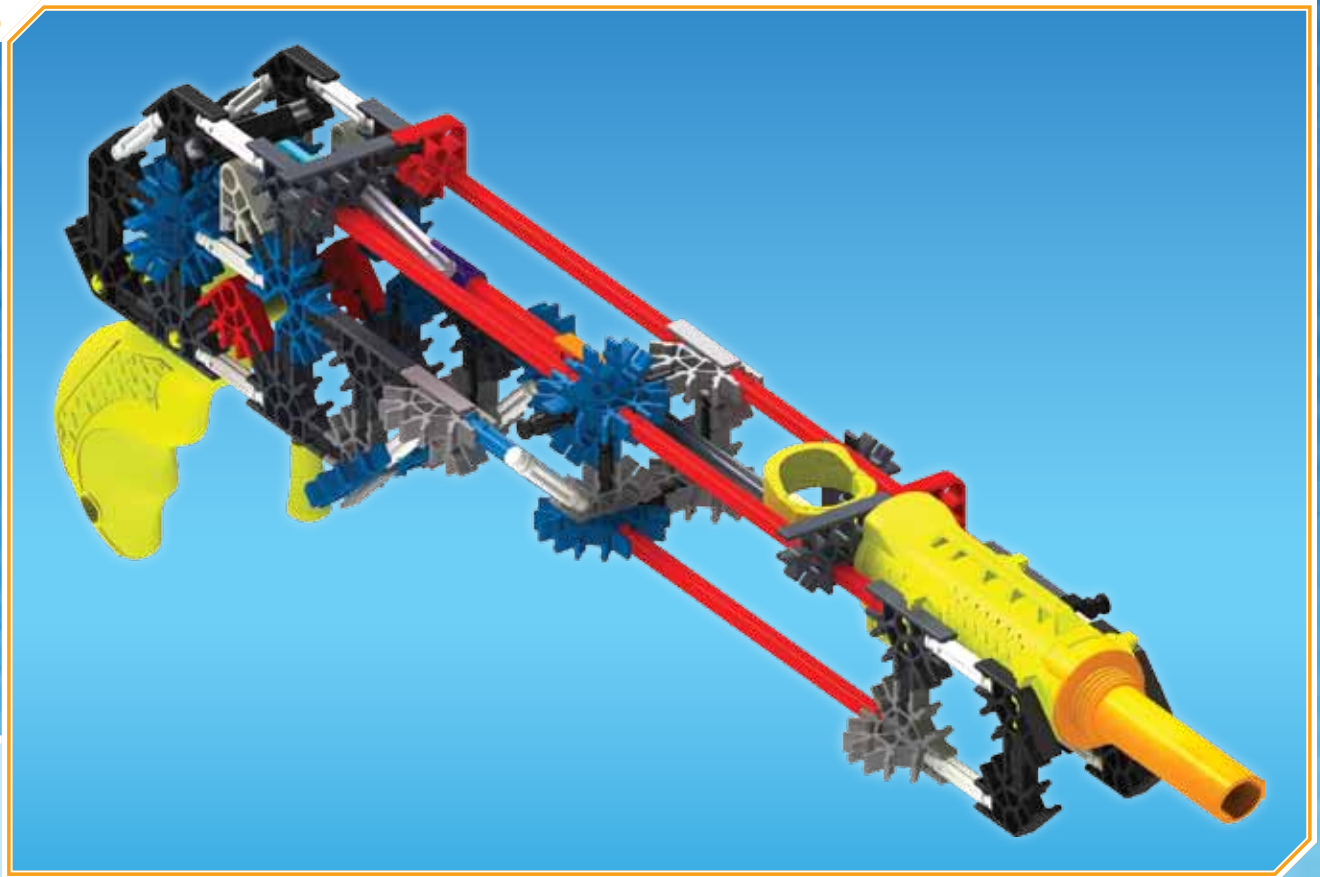

- 3
- 1
- 6
- 1
- 2

25-26

25

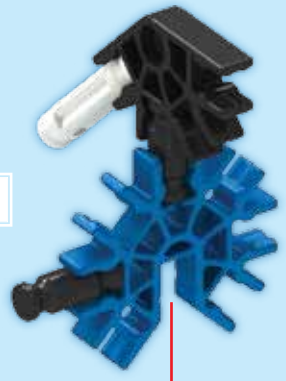

26

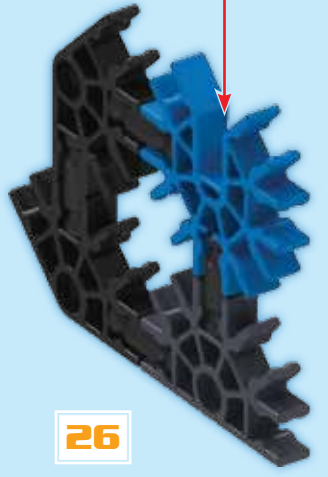

- 1
- 3
- 1

27



25-26

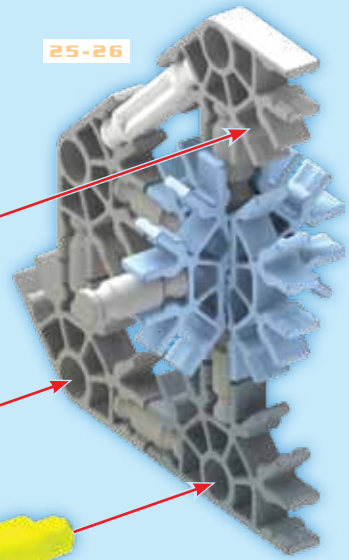

28



25-28

- 5
- 3
- 1
- 1
- 1
- 1

29-30



29



30

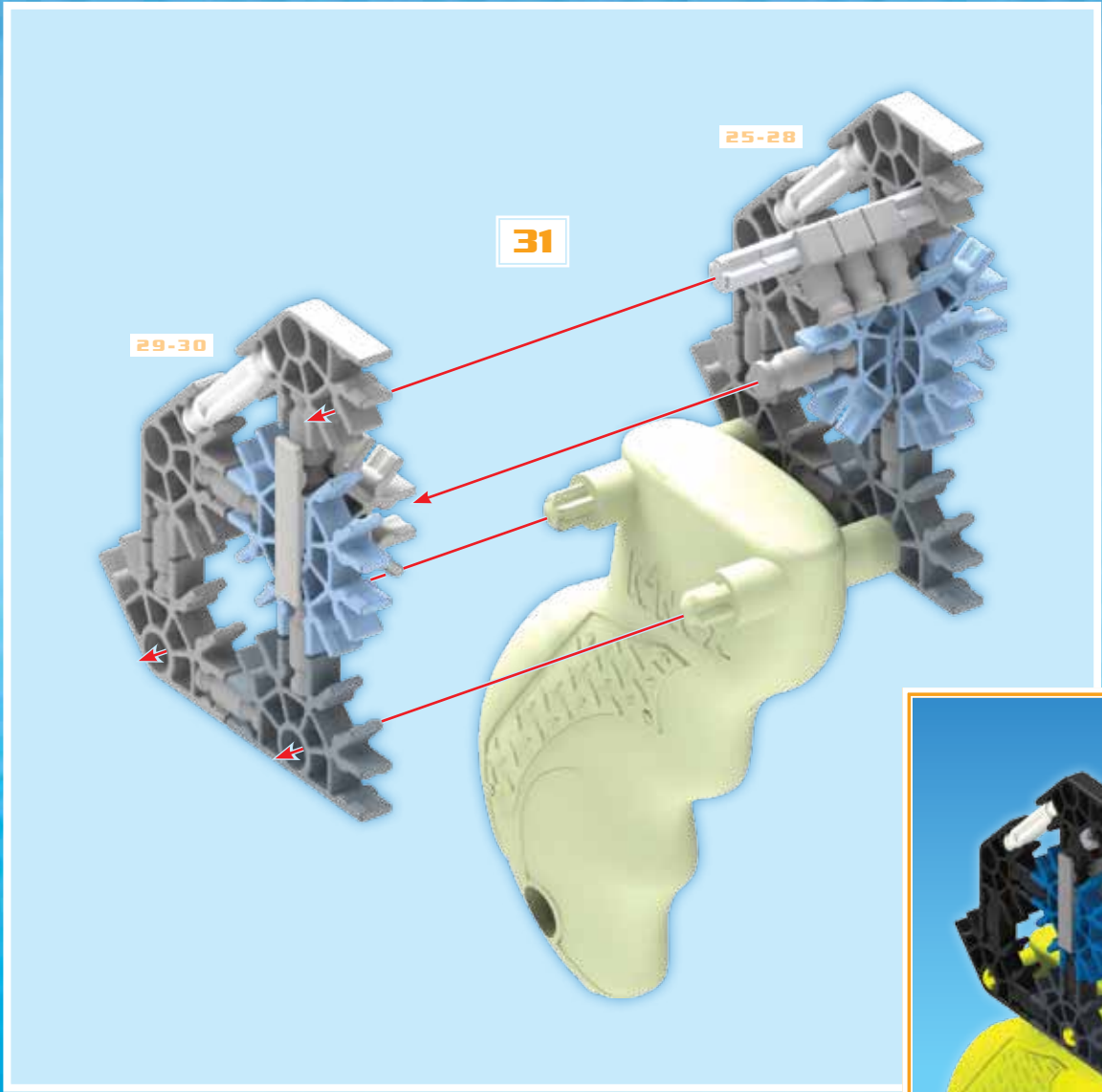
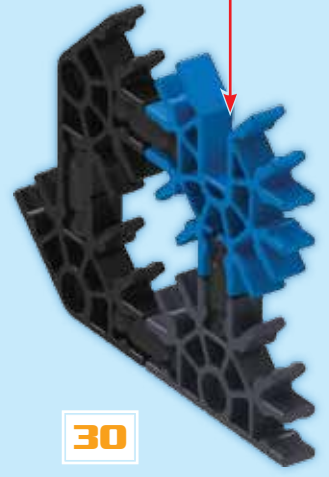

31

25-28

29-30

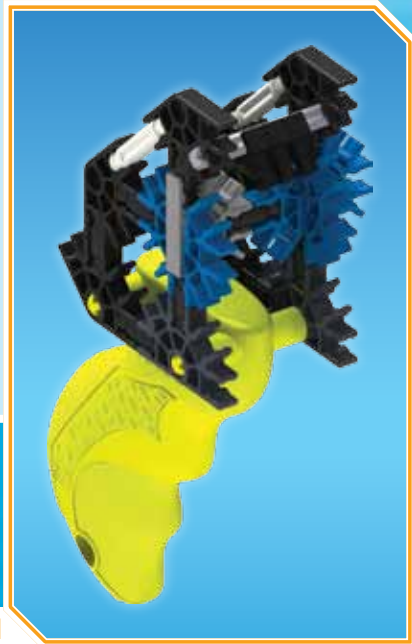

25-31

- 1
- 4
- 10
- 1
- 3
- 1
- 3
- 2

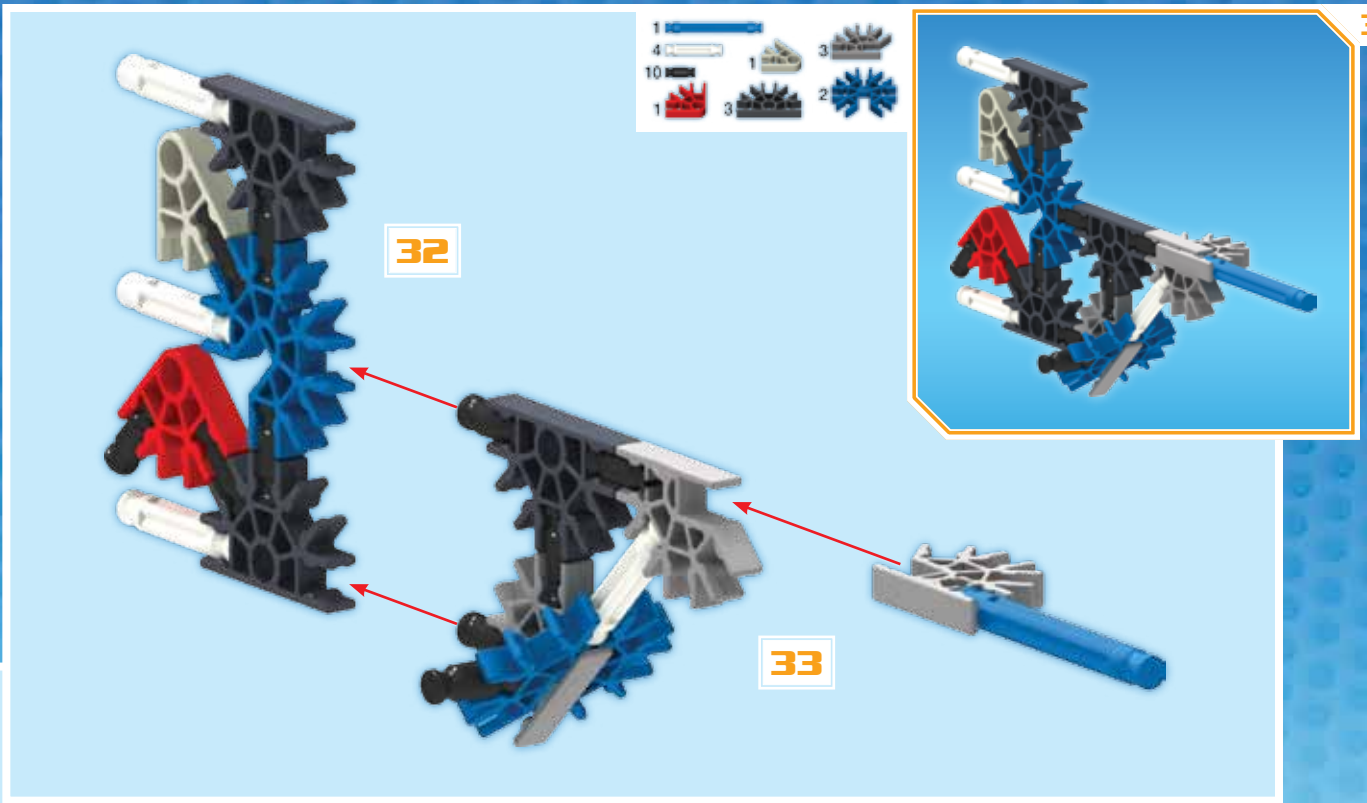

- 1
- 1
- 1
- 1
- 2
- 2
- 1
- 1
- 1

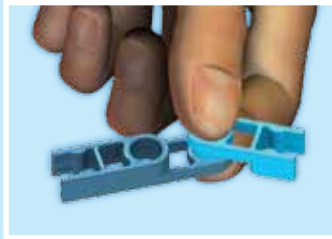
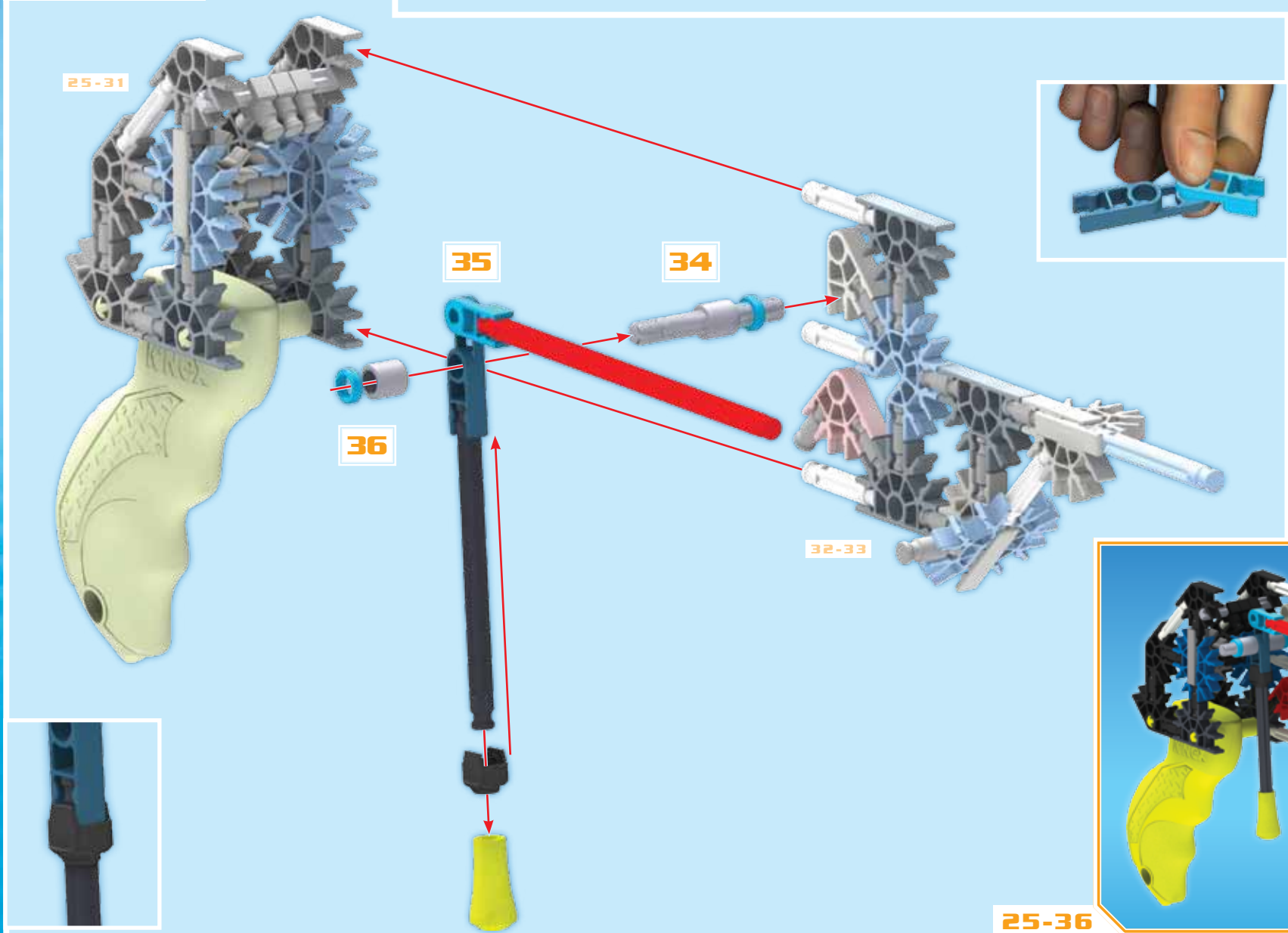

37-38

- 1 [grey axle]
- 4 [grey axle]
- 9 [grey axle]
- 1 [red gear]
- 1 [grey gear]
- 3 [grey gear]
- 2 [grey gear]
- 2 [blue gear]

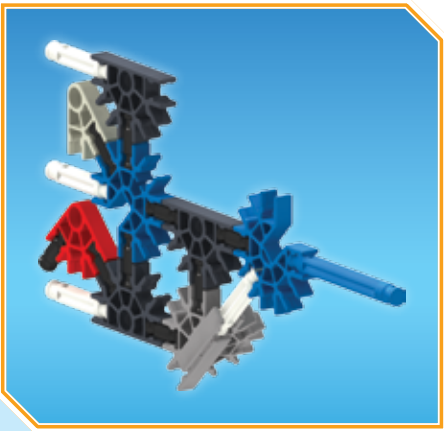

37

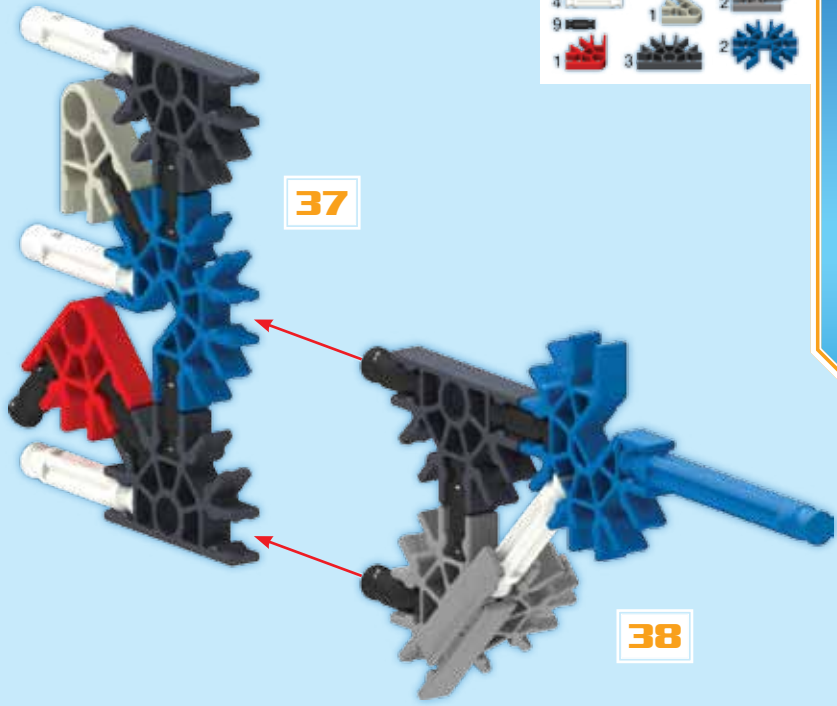

38

25-36

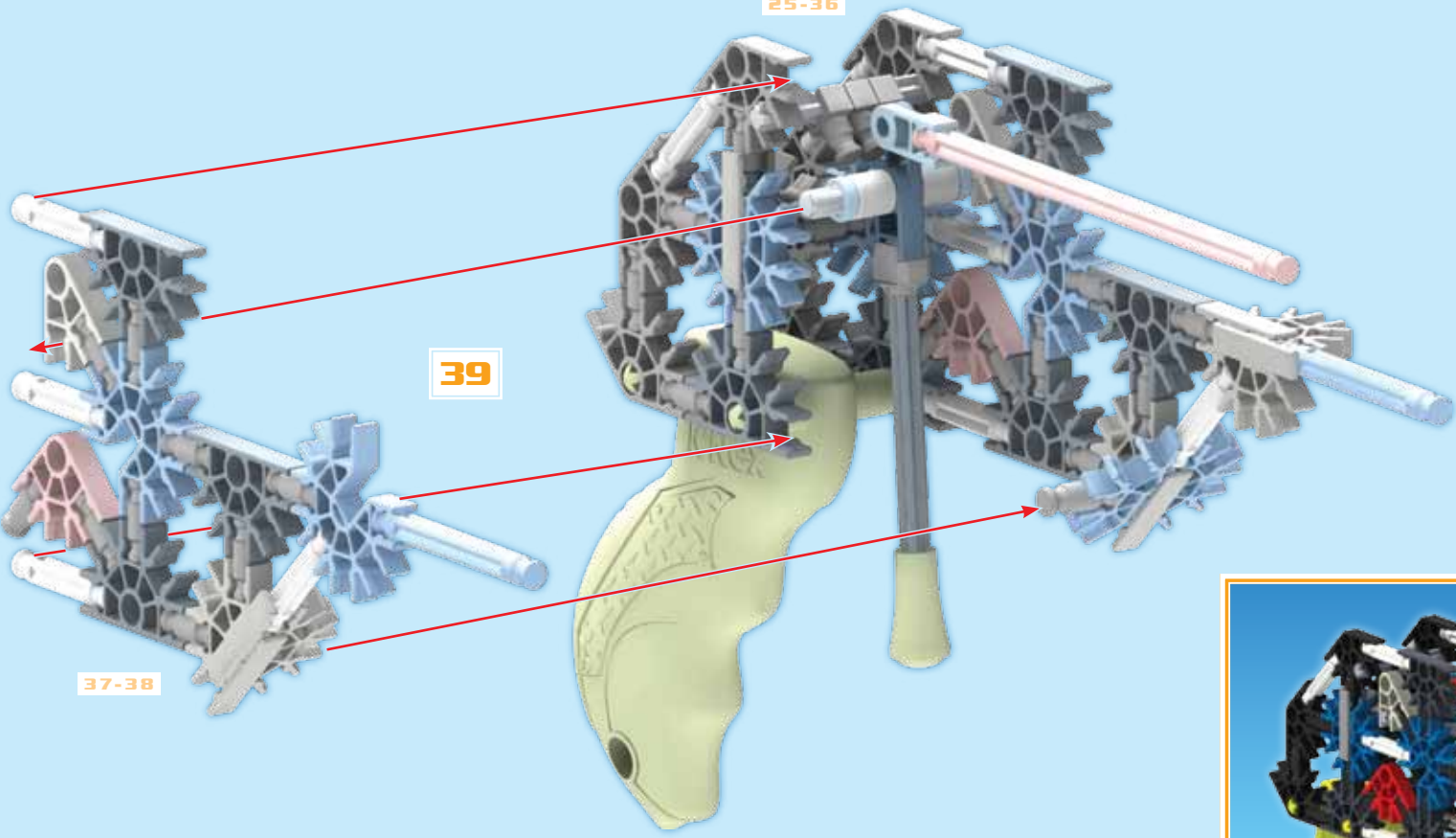

39

37-38



25-39

25-42

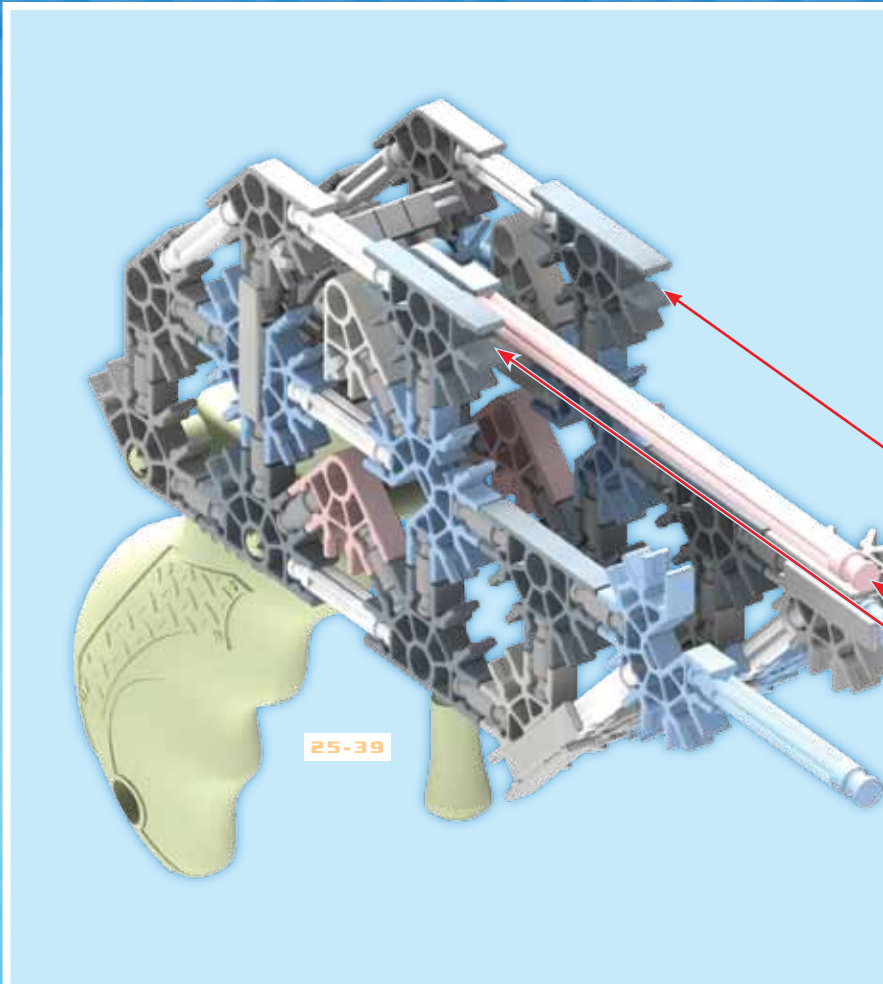

25-39

41

40



42



40



40

- 1 1
- 1 1
- 1 1

- 2
- 1 1
- 1 1 1

25-43

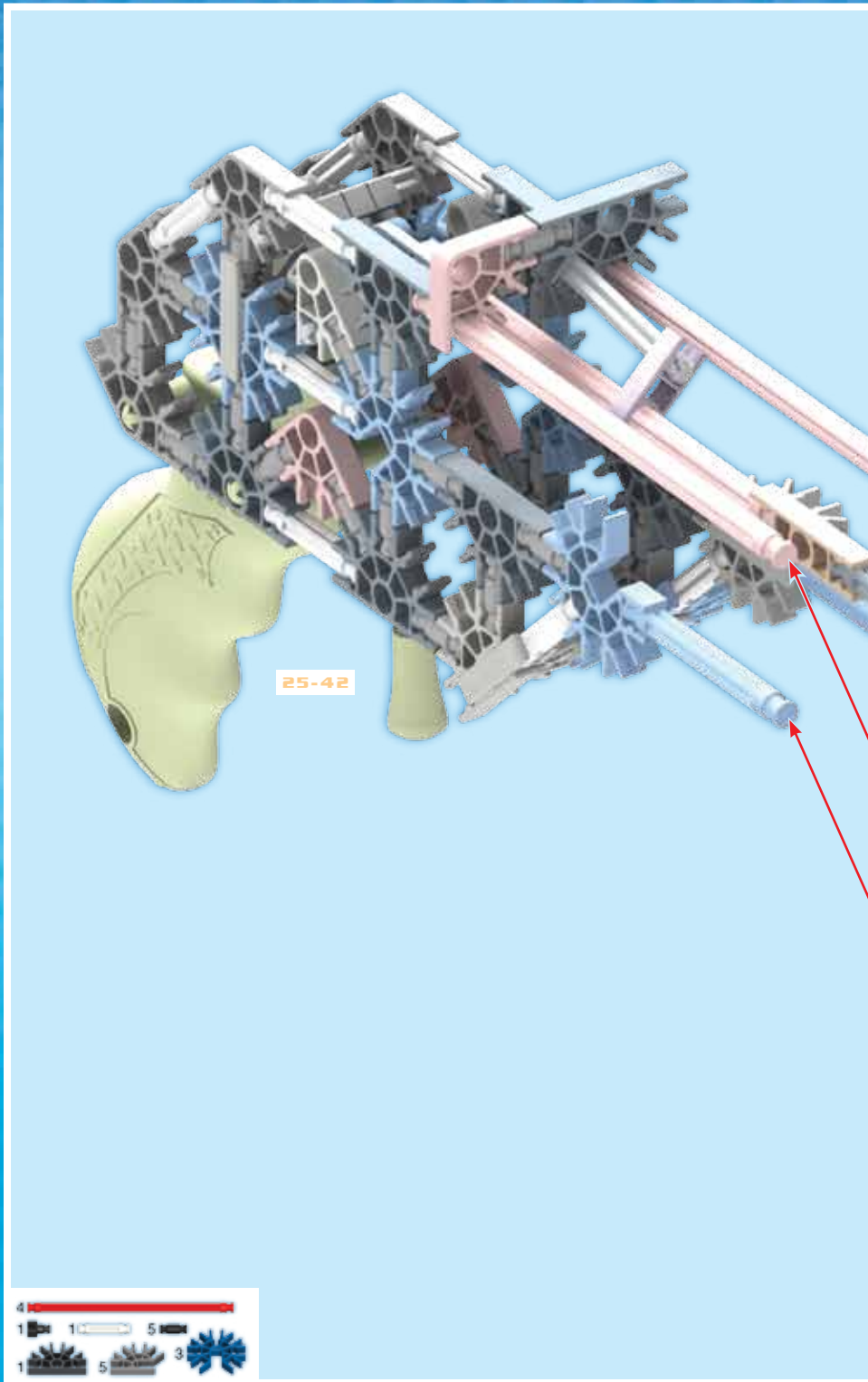
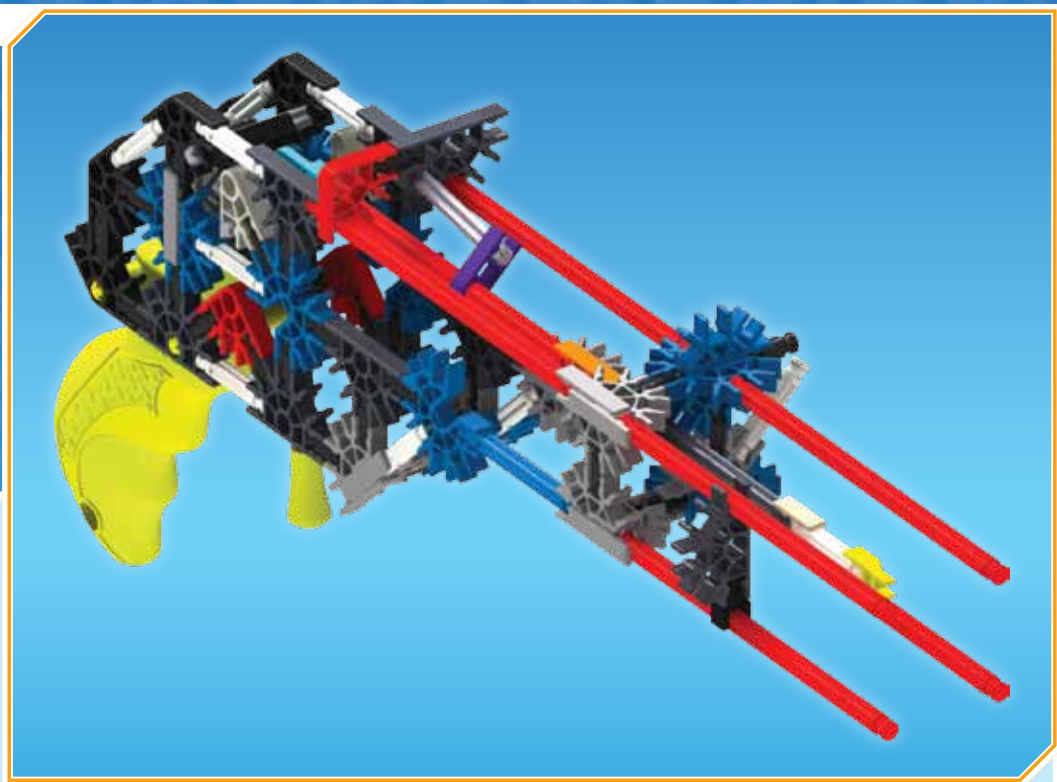

43

25-47

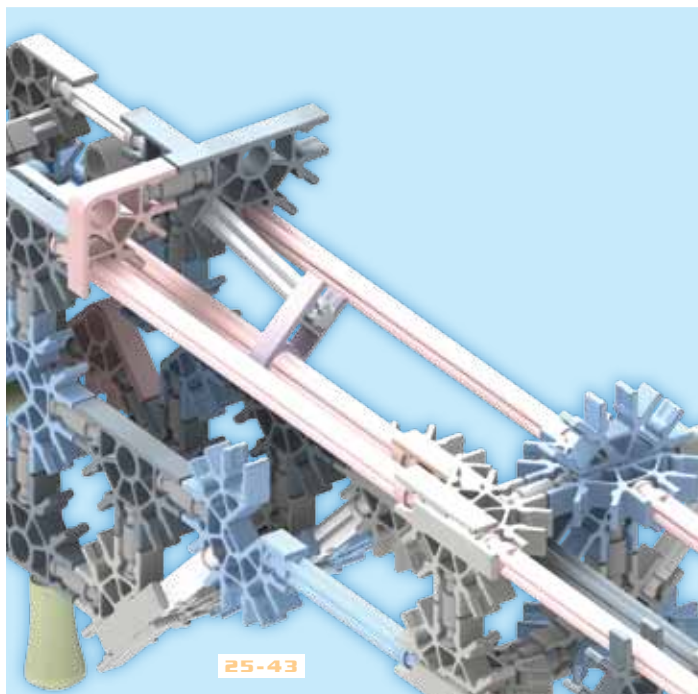
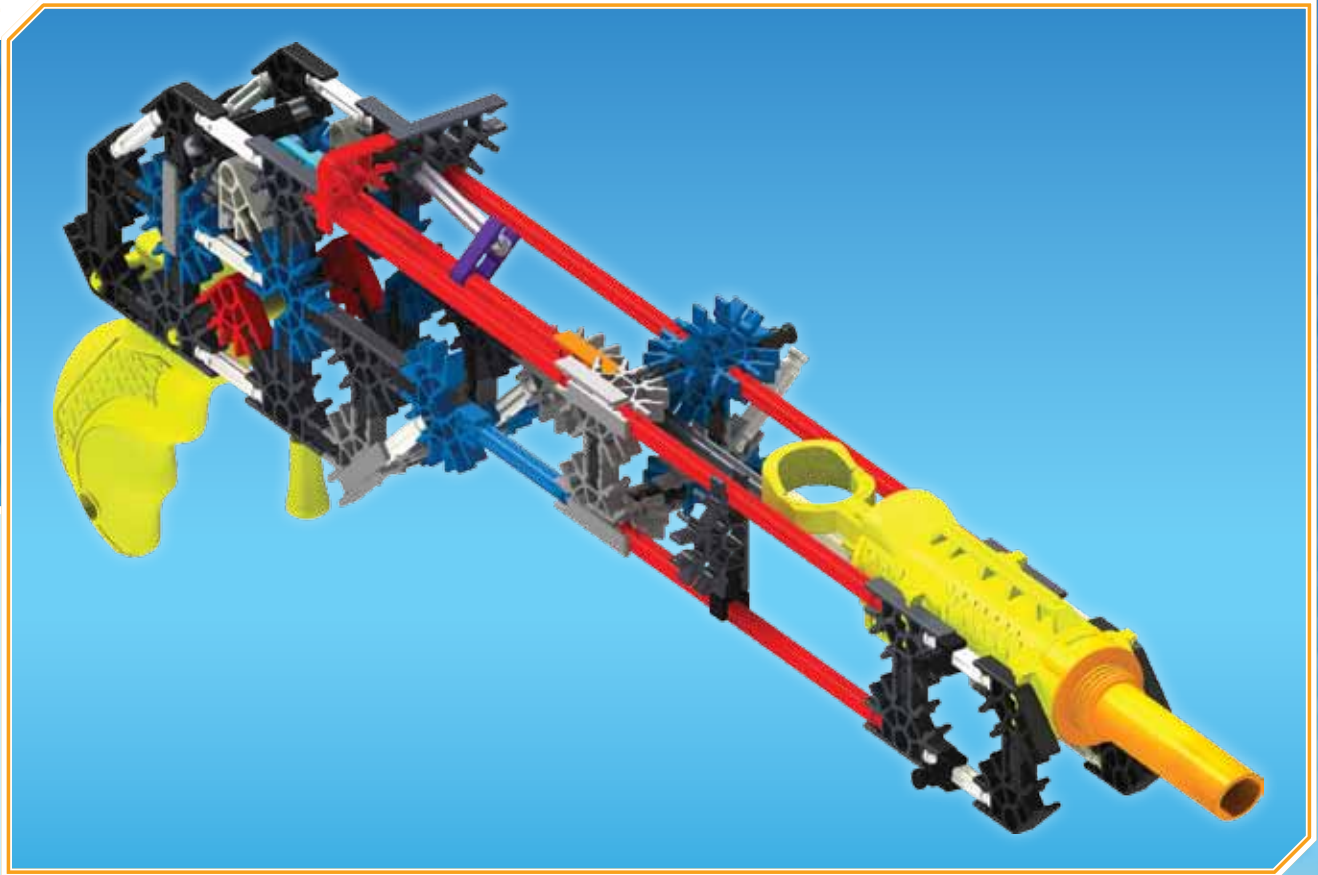

25-43

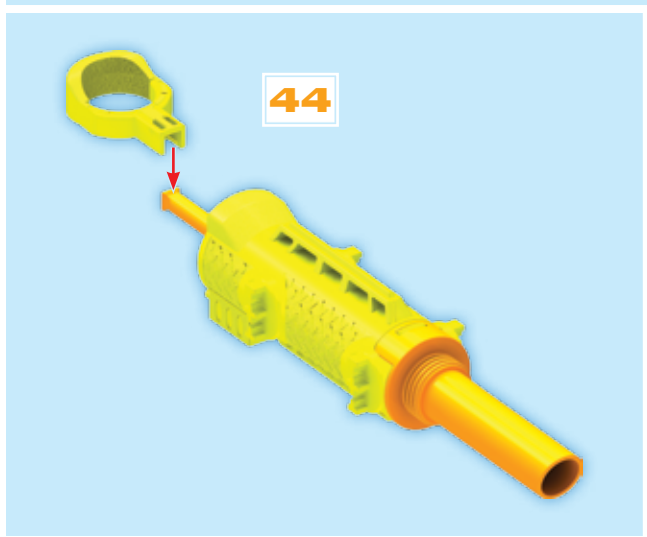
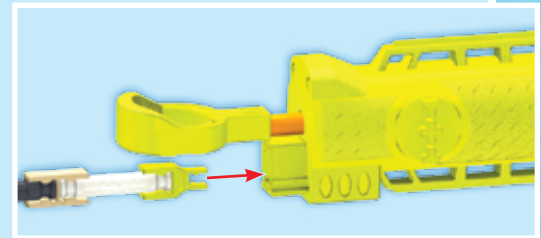

44

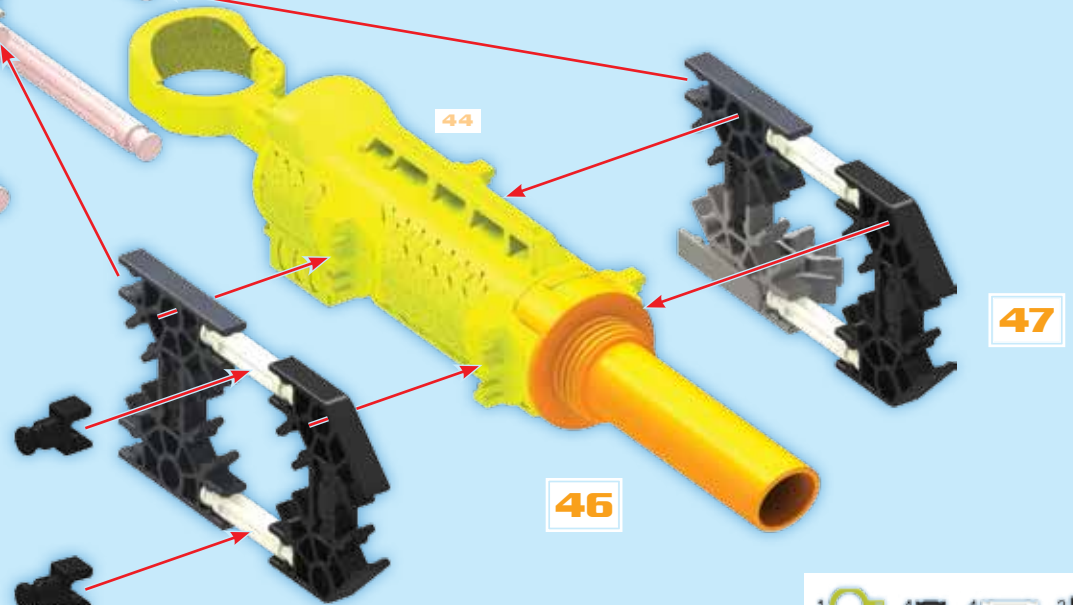

44

47

46

45

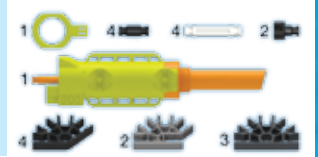

1 4 4 2
 1 1
 4 2 3

25-48

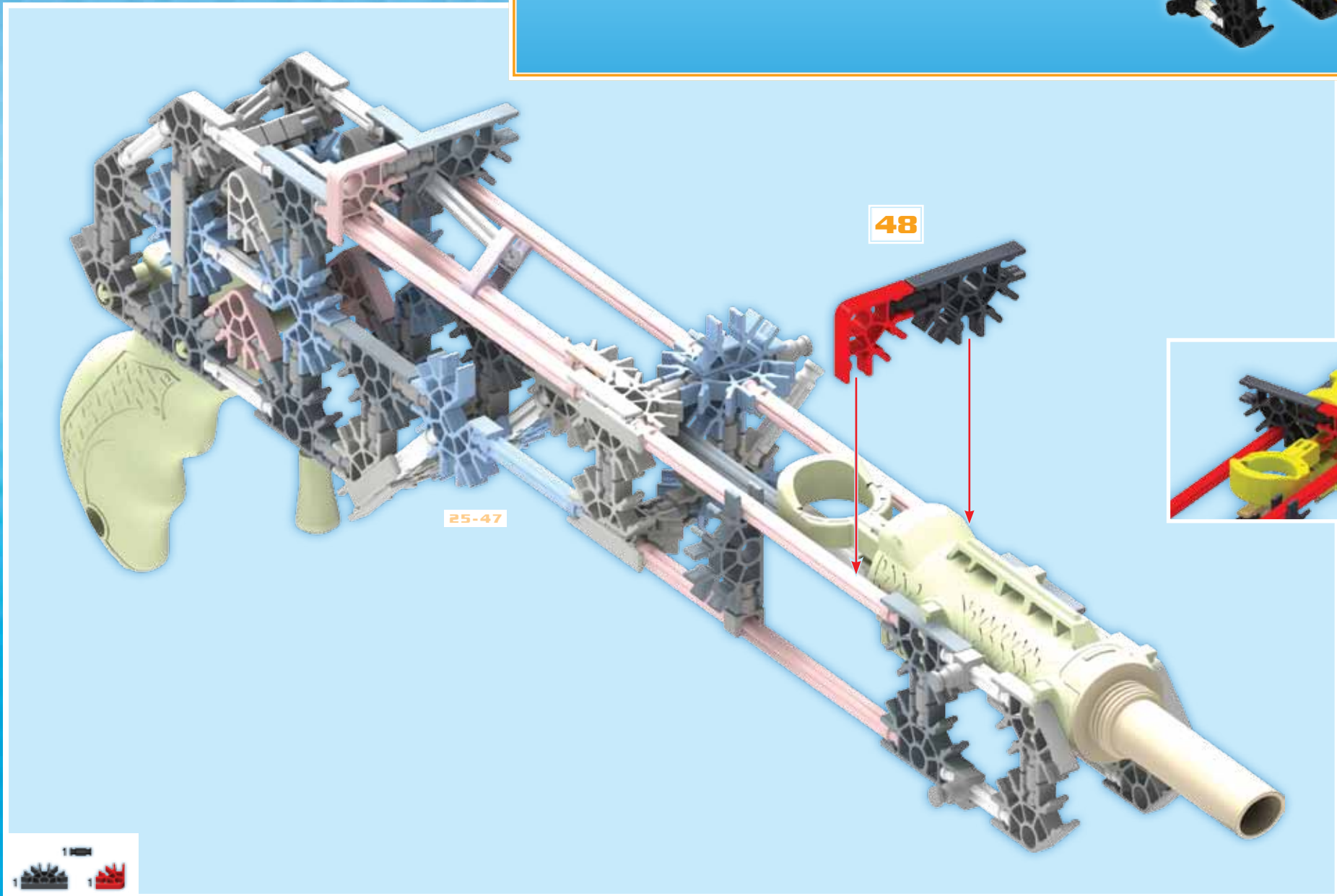
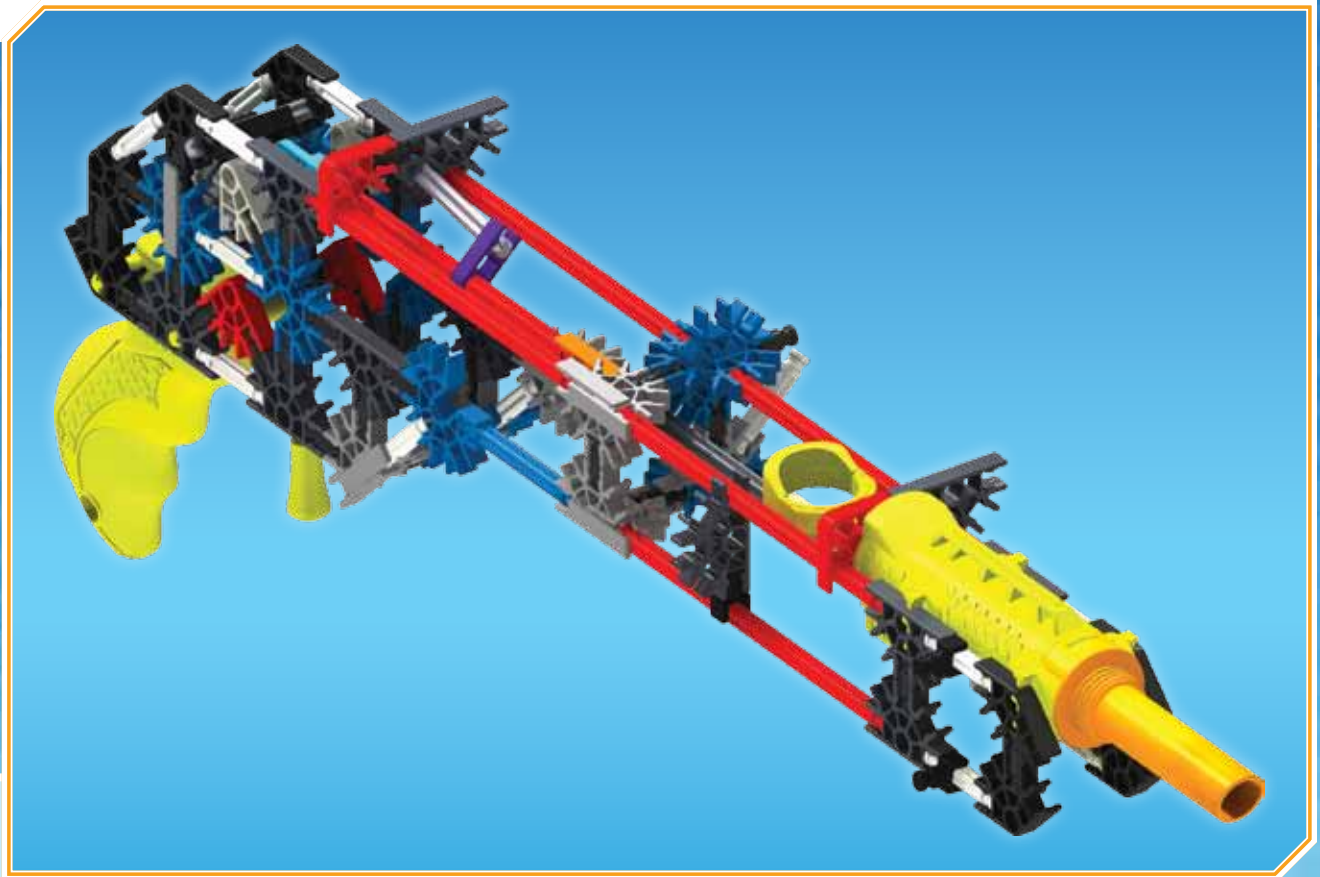

1-55

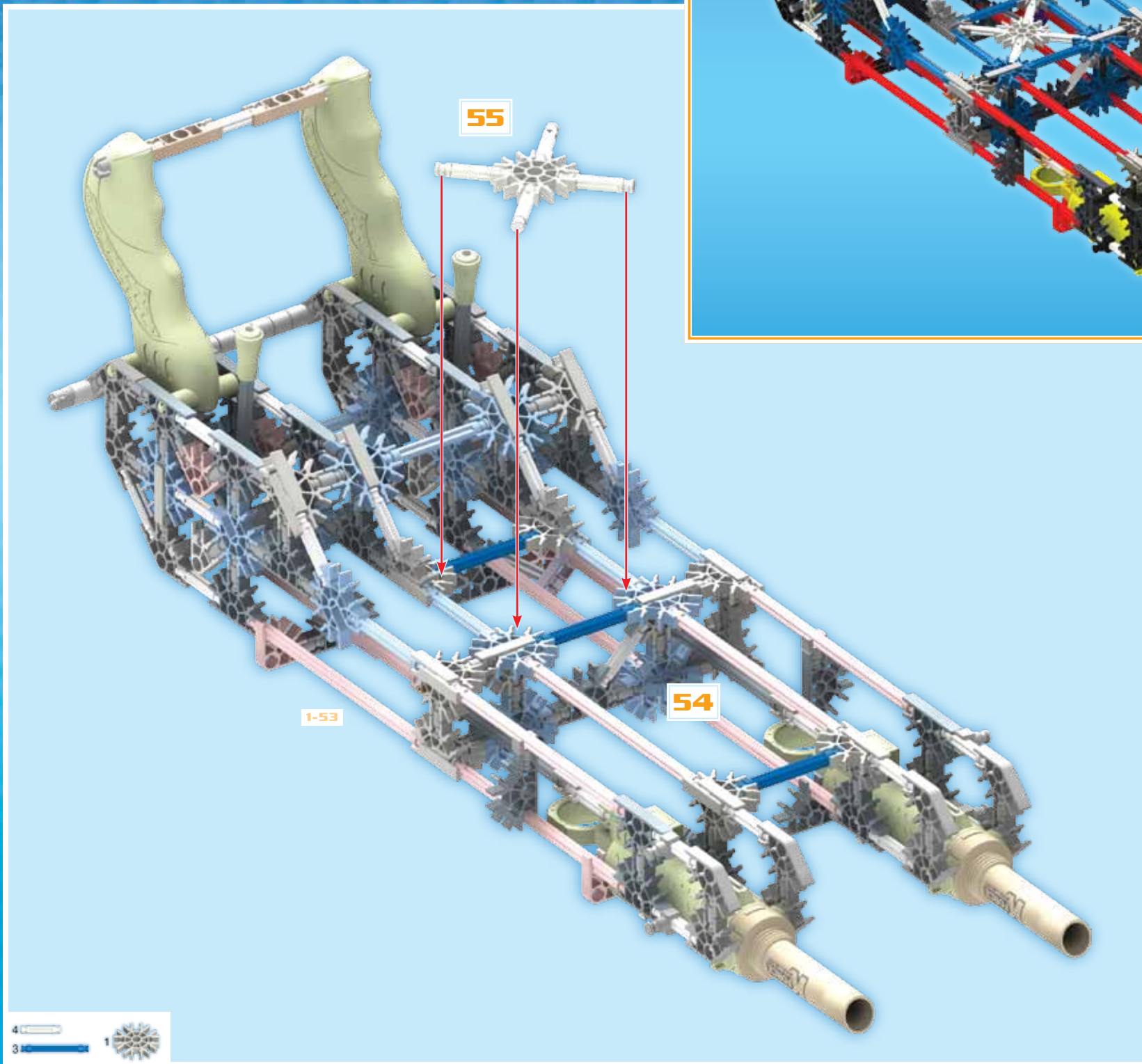

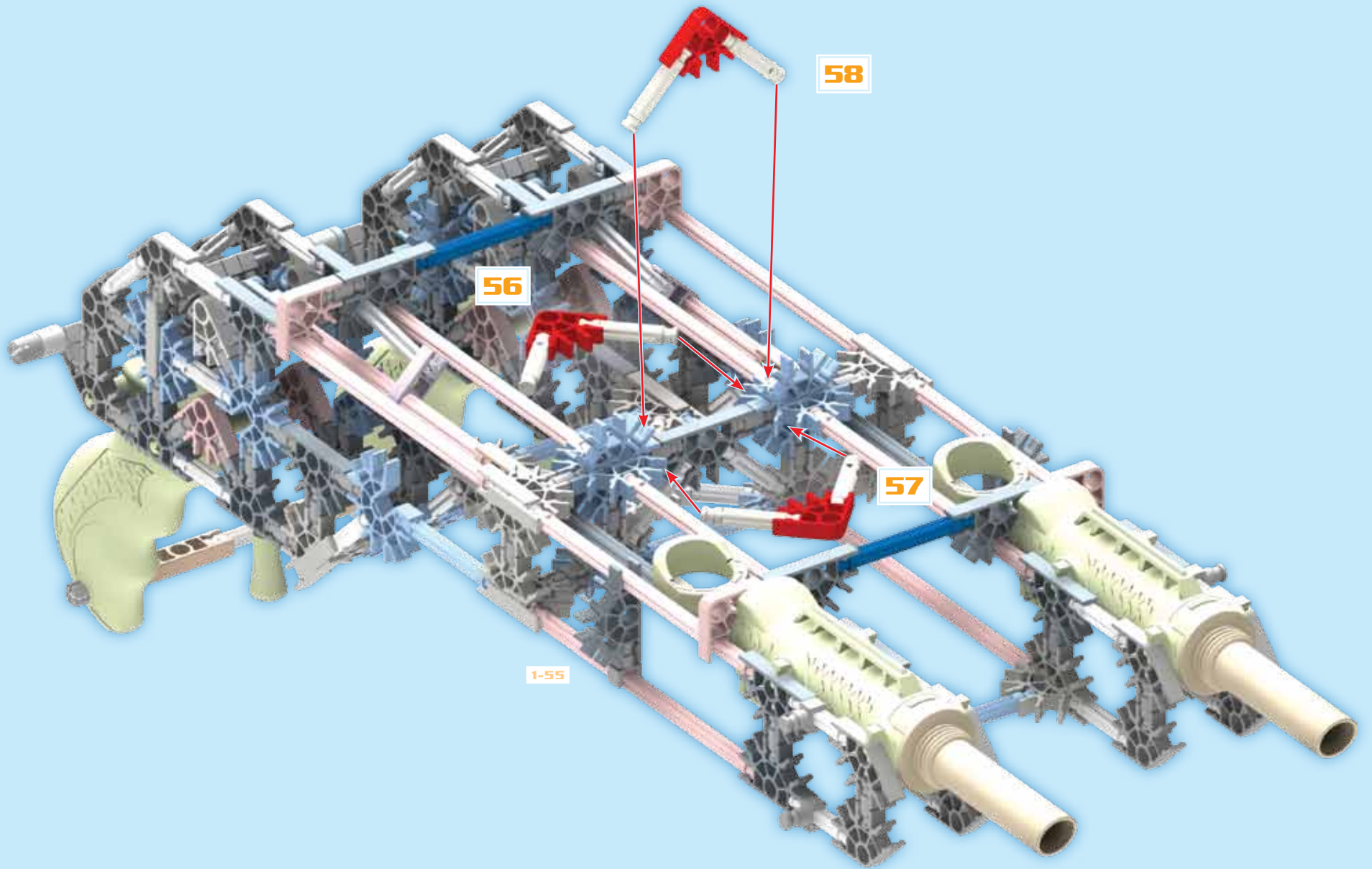

- 4
- 2
- 4
- 6
- 2
- 4

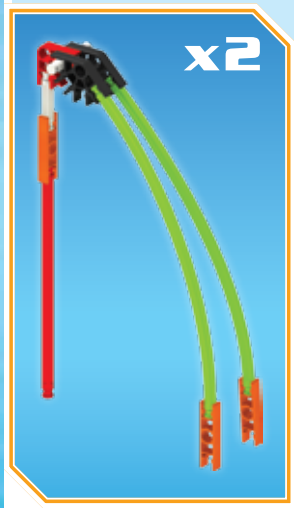

59-60

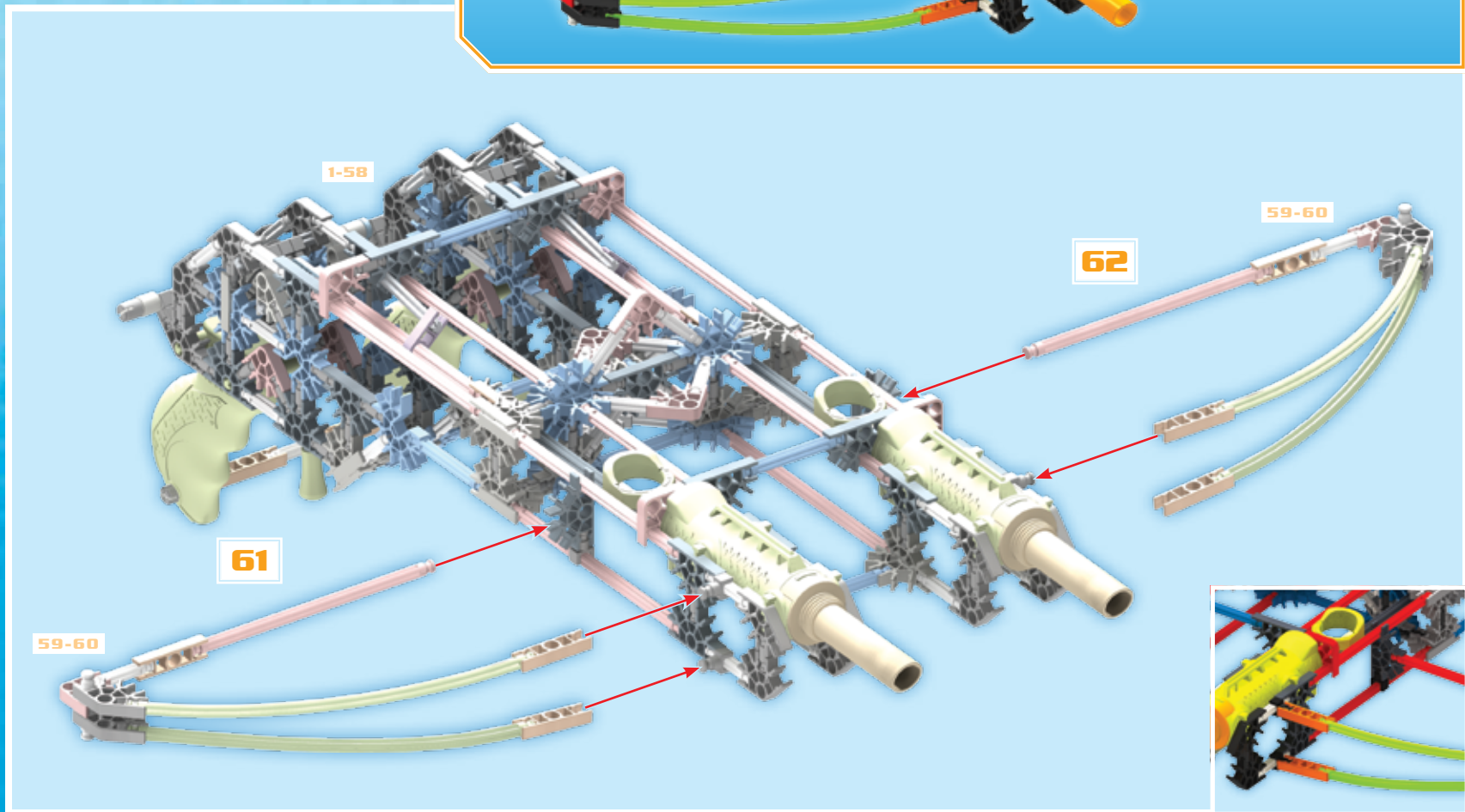

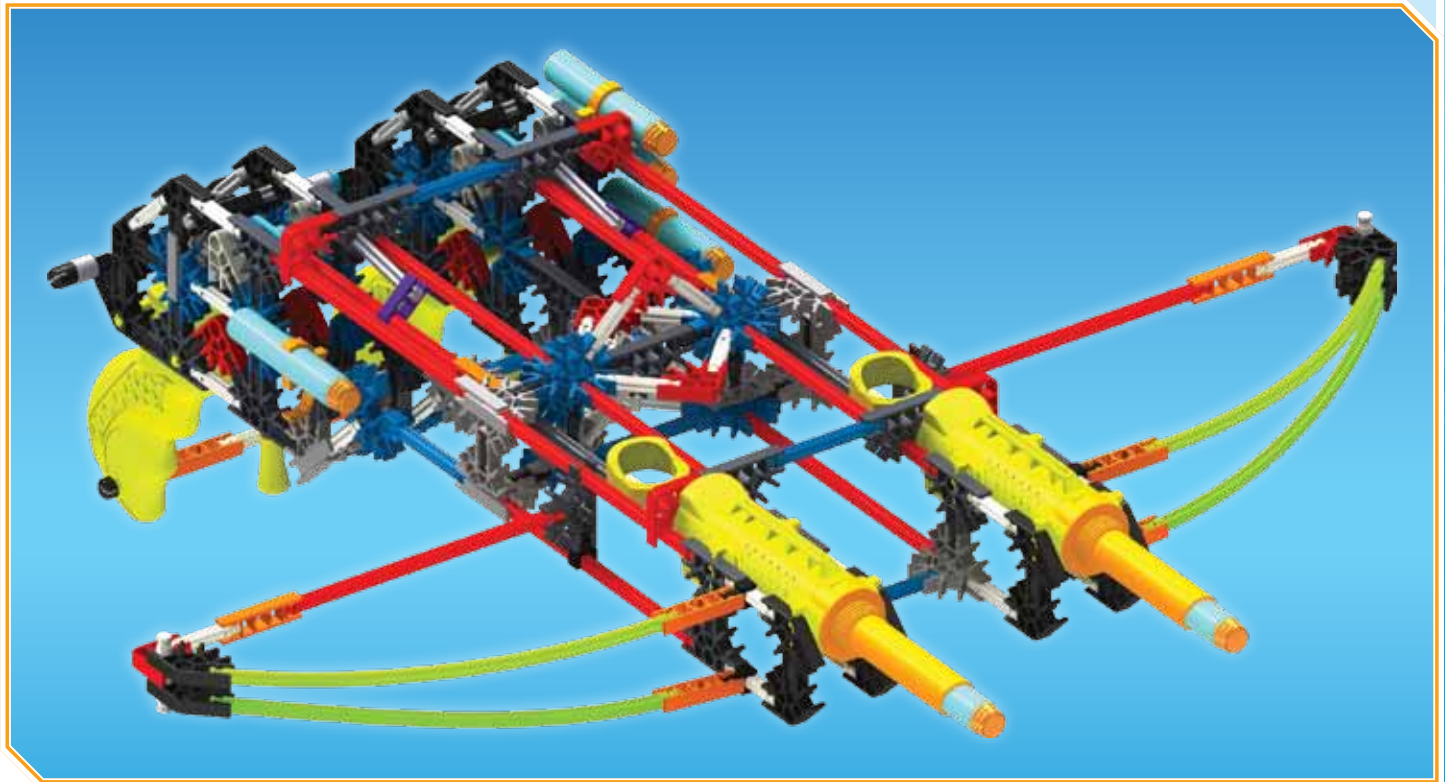
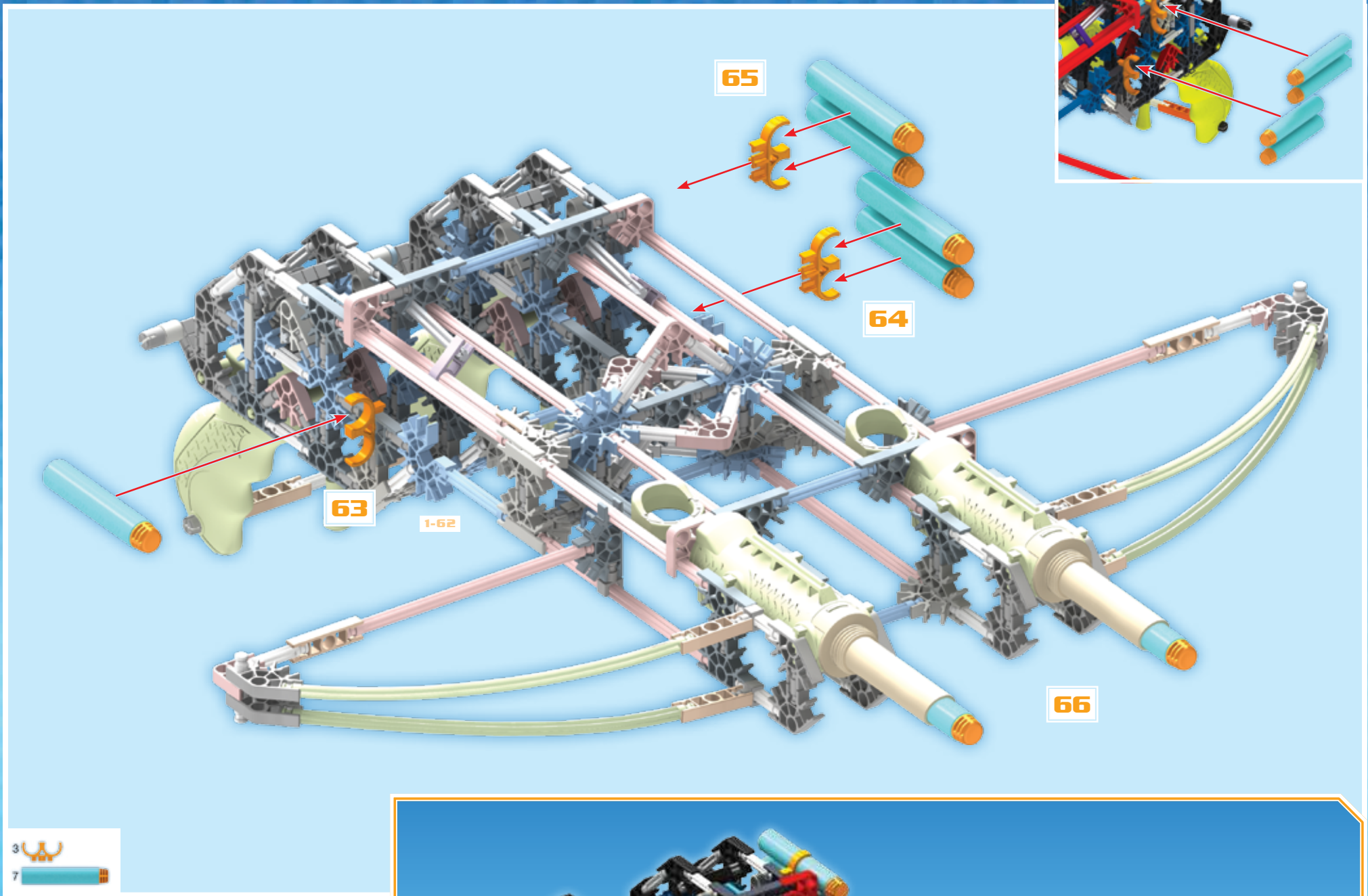



DUAL CROSS DOUBLE ARBELÈTE

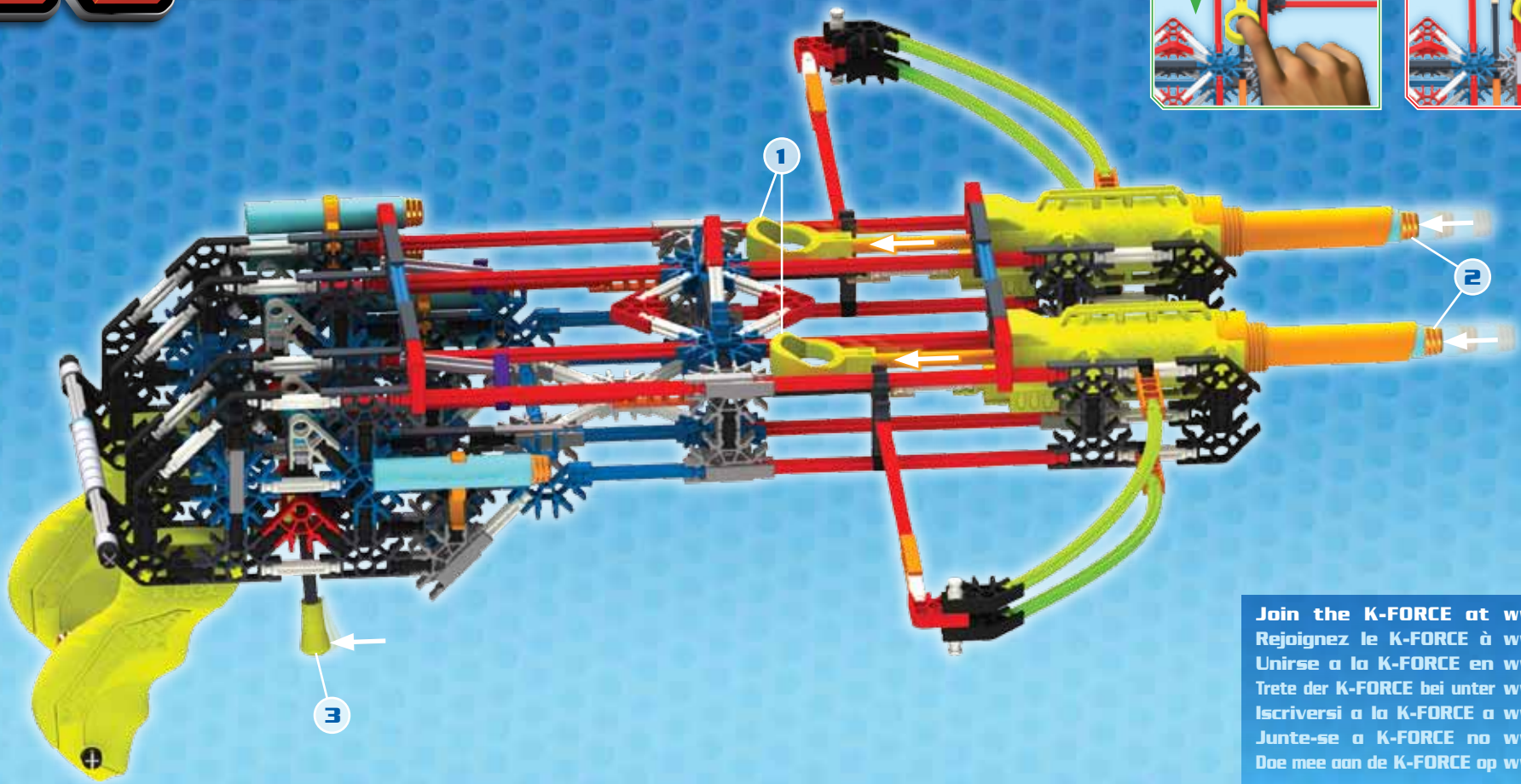

Join the K-FORCE at www.knex.com
Rejoignez le K-FORCE à www.knex.com
Unirse a la K-FORCE en www.knex.com
Trete der K-FORCE bei unter www.knex.com
Iscriversi a la K-FORCE a www.knex.com
Junte-se a K-FORCE no www.knex.com
Doe mee aan de K-FORCE op www.knex.com



5 Alternate Models

For instructions of these 5 models go to knex.com/instructions and enter code **47526**. You can also find it fast using a tablet or mobile device and scanning this QR Code.

5 Modèles Alternatives

Pour les instructions de ces 5 modèles vont à knex.com/instructions et entrez dans le code **47526**. Vous pouvez également le trouver rapidement en utilisant d'un tablet pc ou périphérique mobile en faisant une scanographie de ce QR Code.



(ES) Español

(Página 2)

Para ser utilizado bajo la supervisión directa de un adulto. Lea las instrucciones antes de usar el juguete. Siempre use gafas apropiadas (no se incluyen).

⚠ **ADVERTENCIA:** PELIGRO DE ASFIXIA – Piezas pequeñas. No para niños menores de 5 años.

ADVERTENCIA: No apuntar a los ojos o la cara. **PARA EVITAR LESIONES:** Utilice sólo los dardos de espuma diseñados para este producto. No modifique dardos de espuma o compartimiento.

Nunca mirar en el compartimiento sin protección ocular si esta cargada o cargado. No dispare a corta distancia. No dispare a gente que no llevan gafas apropiadas. No disparen o punto a animales. No guardar compartimiento cargada y cargado. Ser conscientes dardos pueden cambiar de dirección al golpear objetos. Guarde esta información importante para futuras referencias.

BÁSICOS DE CONSTRUCCIÓN

Empieza a construir

Para comenzar tu modelo, busca el 1 y sigue los números. Cada pieza tiene su propia forma y color. Simplemente mira los dibujos, busca las piezas correspondientes en tu juego y después conéctalas. Mientras construyes, trata de colocar tu modelo en la misma dirección que se muestra en las instrucciones. Los colores desteñidos muestran que esta sección ya está construida. Conecta las nuevas secciones en los lugares señalados por las flechas. Las nuevas piezas que agregues estarán en colores vivos.

Espaciadores

Hay lugares en tu modelo donde tendrás que agregar espaciadores azules y plateados. Cerciórate de usar el color correcto y cuéntalos con cuidado.

(Página 3)

Conectores

Hay conectores azules y plateados con ranuras largas especiales. Se enganchan deslizándose como ves en los dibujos. Conecta estas piezas empujándolas hasta que oigas "clic".

Varillas flexibles

Se puede plegar una varilla flexible para hacer formas encorvadas. Será más fácil para conectarla a tu modelo si la doblas varias veces para adelante y atrás.

Construible marca

Cortar los objetivos en la parte trasera de la caja. Usted puede encontrar los objetivos para imprimir y las instrucciones para el modelo en knex.com/instructions y introducir el código 47526.

Lista de Piezas

Antes de empezar con la construcción, asegúrate de comparar las piezas en tu conjunto con la lista de las piezas aquí. Si faltan algunas, llámanos

o escríbenos siguiendo las instrucciones en la página trasera. Estamos aquí para ayudarte.

(Página 25)

5 Modelos Alternativos

Ya que las instrucciones de los estos 5 modelos van a knex.com/instructions y entre en el código 47526.

(DE) Deutsch

(Seite 2)

Zur Verwendung unter direkter Aufsicht eines Erwachsenen. Vor der Verwendung des Spielzeugs die Anleitung lesen. Stets eine geeignete Schutzbrille tragen (nicht enthalten).

⚠ **ACHTUNG:** ERSTICKUNGSGEFAHR – Kleinteile. Nicht geeignet für Kinder unter 5 Jahren.

ACHTUNG: Nicht auf Augen oder das Gesicht zielen. **ZUR VERMEIDUNG VON VERLETZUNGEN:** Nur Schaumstoffpfeile verwenden, die für dieses Produkt entwickelt wurden. Schaumstoffpfeile oder Projektilkammer nicht modifizieren.

Keinesfalls mit bloßem Auge in die Mündung des Blasters schauen, wenn er geladen ist. Nicht aus kurzer Entfernung schießen. Nicht auf Menschen schießen, die keine geeignete Schutzbrille tragen. Nicht auf Tiere zielen und schießen. Den Blaster niemals verstauen, wenn er noch geladen ist. Vorsicht, die Pfeile können die Richtung ändern, wenn sie auf Objekte treffen. Informationen für später aufbewahren.

GRUNDLEGENDE BAUANLEITUNGEN FÜR K'NEX

Los geht's mit dem Bauen

Um mit dem Bauen deines Modells zu beginnen, suche die Nummer 1 und folge den laufenden Nummern. Jedes Teil hat seine eigene Form und Farbe. Schau dir einfach die Abbildungen an, such die Teile in deinem Bausatz, die so aussehen wie das, was du auf der Abbildung siehst und steck sie ineinander. Versuche, dein Modell beim Zusammenbauen so zu orientieren, dass es in die gleiche Richtung weist, wie es in den Anleitungen beschrieben und gezeigt wird. Blasse Farben weisen darauf hin, dass dieser Streckenabschnitt bereits zusammengebaut ist.

Abstandsstücke

An manchen Stellen in deinem Modell musst du Abstandsstücke einbauen. Achte darauf, die richtige Farbe und Anzahl von Abstandsstücken wie in der Anleitung gezeigt zu verwenden.

(Seite 3)

Verbindungsstücke

Blaue und silberfarbene Verbindungsstücke haben besonders lange Schlitze. Wie du auf der Abbildung sehen kannst, lassen sie sich ineinander schieben. Achte beim Aneinanderfügen dieser Teile darauf, dass du ein Klickgeräusch hörst. Erst dann sind die Teile fest miteinander verbunden.

Flexible Stöbe

Flexible Stöbe kann man biegen, um Kurven zu formen. Sie können leichter am Modell befestigt werden, wenn sie zuerst ein paar Mal hin und her gebogen werden.

Bausatz für Ziel

Schneiden Sie die Zielscheiben aus der Rückseite der Schachtel. Weitere Zielscheiben zum Ausdrucken und Anleitungen für das Modell finden Sie auf knex.com/instructions und geben Sie Code 47526 an.

Teileliste

Bevor du mit dem Bauen anfängst, solltest du prüfen ob die Teile in deinem Bausatz mit denen auf dieser Teileliste übereinstimmen. Falls etwas fehlt, rufe uns an oder schreibe uns (siehe Rückseite). Wir sind für dich da!

(Seite 25)

5 Alternative Modelle

Für Anweisungen dieser 5 Modelle gehen sie zu knex.com/instructions und geben sie Code 47526 ein.

(IT) Italiano

(Pagina 2)

Deve essere usato solamente sotto diretta supervisione di un adulto. Leggere le istruzioni prima di usare il giocattolo. Devi sempre indossare l'occhiali protettivi (non incluse).

⚠ **AVVISO:** PERICOLO DI SOFFOCARE – Pezzi piccoli. Non adatto per bambini sotto 5 anni.

AVVISO: Non puntare mai a l'occhi o alla faccia. **PER EVITARE FERITE:** Usa solamente le freccette di spugna fabricate per questo prodotto. Non modificare mai la freccetta di spugna o il Blaster Camera.

Non devi mai guardare nel cilindro del blaster con l'occhio nudo se e' ancora caricato e pronto per sparare. Non sparare a bruciapelo. Non mai sparare alle persone che non indossano occhiali protettivi. Non mai sparare o puntare ad animali. Non mettere via il blaster quando e' ancora caricato e pronto per sparare. Devi sempre essere consapevole che le freccette possono cambiare direzione quando colpiscono oggetti. Conservare queste importanti informazioni per riferimento futuro.

ISTRUZIONI DI BASE PER COSTRUIRE CON K'NEX

Comincia a costruire

Per iniziare il modello, cerca il numero 1 e segui i numeri. Ogni pezzo ha una sua forma e un suo colore. Guarda la figura, trova i pezzi corrispondenti nel set e mettili insieme. Cerca di tenere il modello nella stessa direzione della figura e in tal modo sarà più semplice attaccare i pezzi nei posti giusti. I colori spenti ti dicono che questa sezione è già stata costruita. Dovrai collegare la nuova sezione al punto indicato dalla punta della freccia.

Spaziatori

Ci sono punti nel tuo modello a cui dovrai aggiungere spaziatori blu e argento. Accertati si contarli attentamente.

(Pagina 3)

Connettori

È molto importante posizionare i connettori blu e argento in una specifica direzione. Presta molta attenzione alle istruzioni e posiziona i connettori orizzontalmente o verticalmente proprio come illustrato. Spingi con forza fino ad udire un clic.

Aste flessibili

Puoi piegare le aste flessibili per fare forme curve. Sarà più facile attaccarla al tuo modello se prima la pieghi avanti e indietro per un po' di volte.

Bersaglio che si può costruire

aglia li bersagli che sono al dietro della scatola. Potete trovare altri bersagli che si possono stampare e le istruzioni per il modello a knex.com/instructions e inserire il codice 47526.

Elenco delle parti

Prima di cominciare a costruire, accertati di confrontare le parti che sono nel tuo set con l'elenco delle parti qui. Se ne manca una chiamaci o scrivici usando le informazioni che sono nella retrocopertina. Noi siamo qui per aiutarti!

(Pagina 25)

5 Modelli Alternativi

Per istruzioni di questi 5 modelli vai a knex.com/instructions e' inserire il codice 47526.

(PT) Português

(Página 2)

Para ser utilizado sob a supervisão direta de um adulto. Leia as instruções antes de usar os brinquedos. Sempre use óculos (não estão incluídas).

⚠ AVISO: PERIGO DE SUFOCAÇÃO – Peças pequenas. Não se destina a crianças com menos de 5 anos de idade.

AVISO: Não visam os olhos ou o rosto. PARA EVITAR LESÕES: Use apenas espuma setas desenvolvido para este produto. Não modifique ou espuma dart blaster câmara.

Nunca olhe para baixo o canhão do blaster com olho nu se estiver carregado ou carregado. Não fogo no ponto em branco. Não atirar em pessoas que não estão usando óculos. Não atirar ou objetivo em animais. Não armazene blaster carregada e carregado. Ter consciência setas pode mudar de direção quando bater objetos. Manter esta informação importante para referência futura.

PONTOS BÁSICOS PARA A CONSTRUÇÃO K'NEX

Inicia a construção

Para começar o teu modelo, procura o 1 e segue

os números. Cada peça tem a sua própria forma definida e cor. Basta simplesmente olhares para a ilustração, procurar as peças do teu jogo correspondentes às que estás a ver e, em seguida, conectar umas nas outras. Enquanto estás a montar as peças, tenta manter o teu modelo na mesma direção, conforme mostrado na ilustração, para assim ligares as peças correctamente. As cores desbotadas indicam que esta secção já está montada. Passarás então a fazer a conexão da nova secção no local indicado pelas setas.

Espaçadores

Existirão certos pontos no teu modelo que necessitam a colocação de espaçadores azuis e prateados. Assegura-te que os contas cuidadosamente.

(Página 3)

Conectores

É muito importante que posiciones os conectores azuis e cor de prateados numa direção específica. Presta muita atenção às instruções e coloca estes conectores horizontal ou verticalmente, exactamente conforme se mostra nas ilustrações. Junta as partes simultaneamente e com firmeza até ouvires um "estalido".

Varetas flexíveis

Podes dobrar uma vareta flexível para obteres formas curvas. Será mais fácil unir ao teu modelo se as dobrares primeiro para trás e para a frente várias vezes.

Alvo construtível

Corte fora as metas na parte de trás da caixa. Você pode encontrar alvos para imprimir e instruções para o modelo em knex.com/instructions e digite o código 47526.

Lista de peças

Antes de iniciáres a construção, certifica-te de que comparas as peças do teu conjunto com a lista das peças aqui. Se faltar alguma peça telefona ou escreve-nos usando as informações indicadas na contracapa. Estamos aqui para te ajudar!

(Página 25)

5 Modelos alternativos

Para obter instruções destes 5 modelos vá em knex.com/instructions e digite o código 47526.

(NL) Nederlands

(Bladzijde 2)

Te gebruiken onder rechtstreekse toezicht van een volwassene. Lees de instructies voordat je het speelgoed gebruikt. Draag altijd de juiste oogbescherming (niet inbepenen).

⚠ WAARSCHUWING: VERSTIKKINGSGEVAAR – Kleine onderdelen. Niet geschikt voor kinderen onder 3.

WAARSCHUWING: Niet richten op de ogen of het gezicht. OM VERWONDINGEN TE VERMIJDEN: Gebruik alleen schuimpijltjes die voor dit product

gemaakt zijn. Breng geen aanpassingen aan in de schuimpijltjes of de revolverkamer.

Kijk nooit met het blote oog in de loop van de revolver als die schietklaar of geladen is. Vuur niet af van dichtbij. Schiet niet op mensen die niet de juiste oogbescherming dragen. Schiet of mik niet op dieren. Bewaar de revolver niet schietklaar en geladen. Let op, de pijltjes kunnen van richting veranderen als ze voorwerpen raken. Bewaar deze belangrijke informatie, zodat u deze in de toekomst opnieuw kunt raadplegen.

BASISSTAPPEN VOOR K'NEX BOUWEN

Begin te bouwen

Om met je model te beginnen, vind eerst het nummer 1 en volg de nummers. Elk stuk heeft zijn eigen vorm en kleur. Kijk gewoonweg naar de afbeeldingen, vind de overeenstemmende stukken terug in je geheel en maak ze aan mekaar vast. Tracht je model in dezelfde richting te plaatsen als de aanwijzingen terwijl je bouwt en monteert. De vervaagde kleuren duiden aan dat dit deel reeds is opgebouwd. Gelieve het nieuwe deel vast te koppelen op de plaats aangeduid door de pijlen.

Afstandhouders

Op bepaalde plekken van je model moet je afstandhouders gebruiken. Zorg dat je het juiste aantal afstandhouders gebruikt, zoals wordt getoond in de instructies.

(Bladzijde 3)

Verbindingsstukken

Je kunt deze speciale verbindingstukken in elkaar steken. Duw ze stevig tegen elkaar aan tot je een 'klik' hoort. Let goed op de instructies en plaats ze horizontaal en verticaal, precies zoals wordt getoond.

Soepele stangen

Een soepele stang can gebogen worden om gebogen vormen te maken. Het zal gemakkelijker zijn om ze aan je model vast te hechten wanneer je ze eerst een paar keer heen en weer buigt.

Zelf te bouwen doelwit

Snijd de doelen op de achterzijde van de kast. U kunt doelstellingen op print en instructies voor het model knex.com/instructions en voer de code 47526.

Lijst met onderdelen

Controleer aan de hand van deze lijst of je set alle onderdelen bevat voordat je begint te bouwen. Als er een onderdeel ontbreekt, bel of schrijf ons dan. Je vindt onze gegevens op de achterkant. We helpen je graag!

(Bladzijde 25)

5 Alternatieve Modellen

Voor instructies van deze 5 modellen naar knex.com/instructions en vul de code 47526.



Sold separately
Vendus séparément
Se venden por separado
Separat erhältlich
Venduti separatamente
Vendidos separadamente
Afzonderlijk verkrijgbaar.

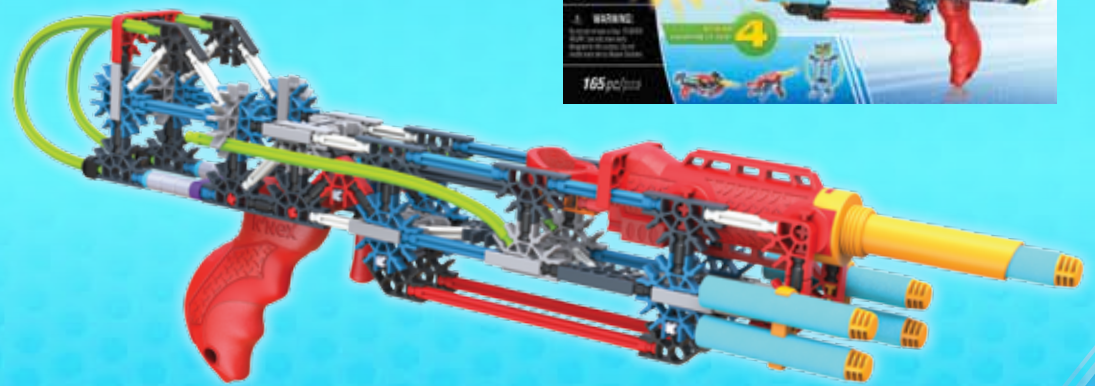

©2015 K'NEX Limited Partnership Group, P.O. Box 700, Hatfield, PA 19440-0700
1-800-KID-KNEX (USA/Canada/États-Unis/EE.UU.); email@knex.com; knex.com
K'NEX UK Ltd., P.O. Box 3083, Reading RG1 9YQ, England.

(EN) K'NEX and Building Worlds Kids Love are registered trademarks of K'NEX Limited Partnership Group. K-FORCE Build and Blast is a trademark of K'NEX Limited Partnership Group. For customers outside the USA/Canada please contact your local distributor at www.knex.com/distributors.

(FR) K'NEX et Building Worlds Kids Love sont des marques déposées de K'NEX Limited Partnership Group. K-FORCE Build and Blast est une marque de K'NEX Limited Partnership Group. Pour les clients en dehors du Canada et des États-Unis, veuillez contacter votre distributeur local que vous pouvez trouver sur www.knex.com/distributors.

(ES) K'NEX y Building Worlds Kids Love son marcas registradas de K'NEX Limited Partnership Group. K-FORCE Build and Blast es una marca de K'NEX Limited Partnership Group. El cliente que no vive en EE.UU./Canadá se pone en contacto con el distribuidor local. Encuentre la información para el distribuidor local en www.knex.com/distributors.

(EN) Product & colors may vary. Most models can be built one at a time.

(FR) Le produit et ses couleurs peuvent varier. Les différents modèles ne peuvent être construits qu'un par un.

(ES) El producto y los colores pueden variar. La mayoría de los modelos se pueden construir uno a la vez.

(DE) Produkte und Farben können abweichen. Die meisten Modelle können immer nur einzeln gebaut werden.

(IT) Prodotti e colori possono differire. La maggior parte dei modelli si può costruire autonomamente.

(PT) O produto e as cores podem variar. A maioria dos modelos pode ser montado um de cada vez.

(NL) Product en kleuren kunnen variëren. De meeste modellen kunnen uitsluitend een voor een worden gebouwd.

+ ¡Recójalos todos!
Sammeln Sie sie alle!
Raccogliali tutti!
Colete-os todos!
Verzamel ze allemaal!

** ¡Dispara hasta 75 pies!
Fliegt bis zu 22 m!
Spara all'altezza di 22 m!
Incêndios até 22 m!
Schiet ruim 22 m ver!

* ¡Construye 6!
Für 6 Varianten!
Costruisci 6!
Constrói 6!
Voor 6 stuks!



147526-V2-05/15