

KNEX

Imagine • Build • Play™

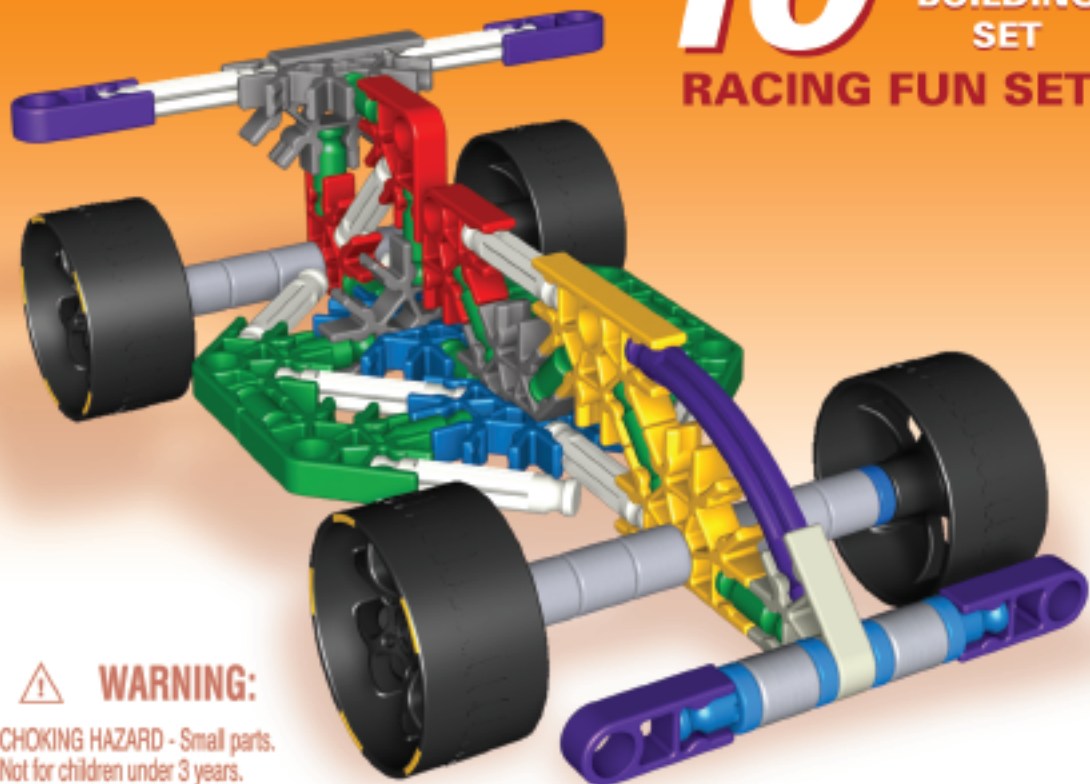

10 MODEL BUILDING SET RACING FUN SET™



WARNING:

CHOKING HAZARD - Small parts.
Not for children under 3 years.



AVERTISSEMENT:

DANGER D'ÉTOUFFEMENT - Pièces de petite taille.
Ne pas donner aux enfants de moins de 3 ans.

115 pcs/pzs/pzas

11612/77418

5+

CONTENTS

Building Instructions:

RALLY TRUCK	4
STOCK CAR	5
TOP-FUEL DRAGSTER	6
TURBO CAR	9
SPEED BOAT	12

Building Ideas:

TORTOISE & HARE ...	16
RACE HORSE	16
RACING BIKE	16
RUNNER	16
AIR RACER	16

Foreign Languages	17
-------------------------------	-----------

PARTS CHECK LIST

Before you start building, be sure to compare the parts in your set with the parts listed below. If anything is missing, check out the back cover of this instructions booklet for how to contact us.

We're here to help!

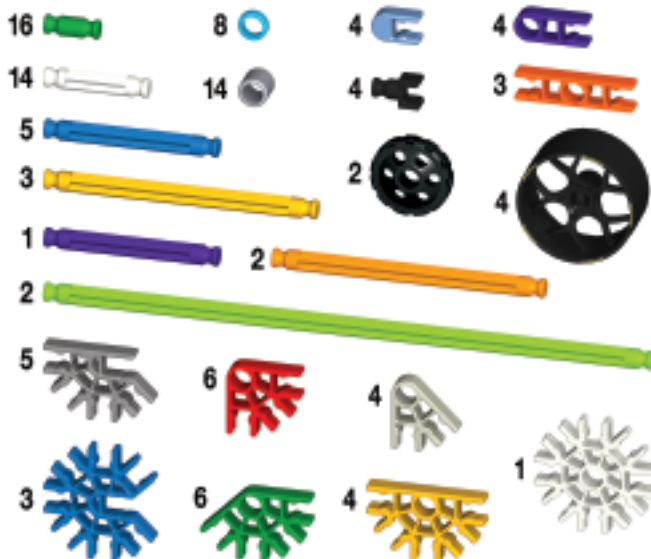

Building with K'NEX



"Hi! I'm your K'NEX co-pilot! Need help... I'm here! Look for me to guide you as you select models with the right level of challenge. Or keep an eye out for me where the building details may get tricky."



**FRIENDLY
CHALLENGE**



**MODERATE
CHALLENGE**



**GREATER
CHALLENGE**

Ready, Set, Build

To begin your model, find the 1 and follow the numbers. Each piece has its own shape and color. Just look at the picture, find the pieces in your set that match what you see, and snap them together. Try to hold your model in the same direction as in the picture so you'll attach your pieces to the right place.

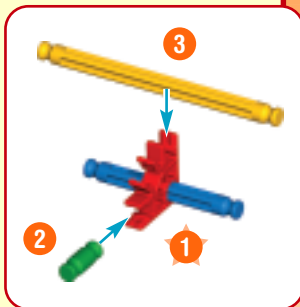

Movin' On

The faded colors tell you this section is already built. You'll want to connect the new section to the place where the arrows are pointing. These pieces will be in full color.

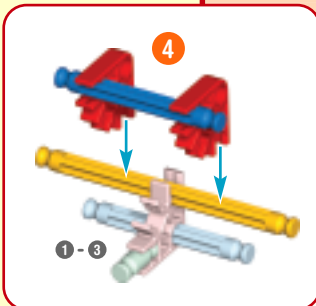

Spacers

There are places in your model where you need to add Spacers. Be sure to use the right color and count them carefully.



Connectors

There are blue and silver Connectors with special long slots. They slide together as you see in the pictures. Push the parts together until you hear a "click".

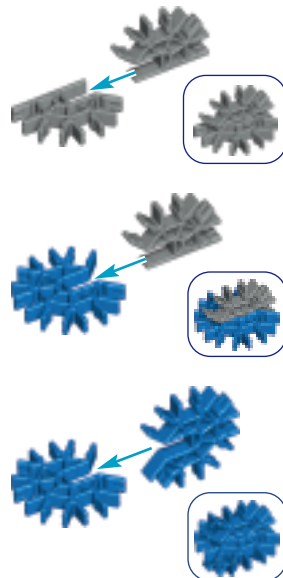

Flexi-rods

A Flexi-rod is a Rod that you bend to make curves. It will be easier to attach to your model if you bend it back and forth first.



Rally Truck

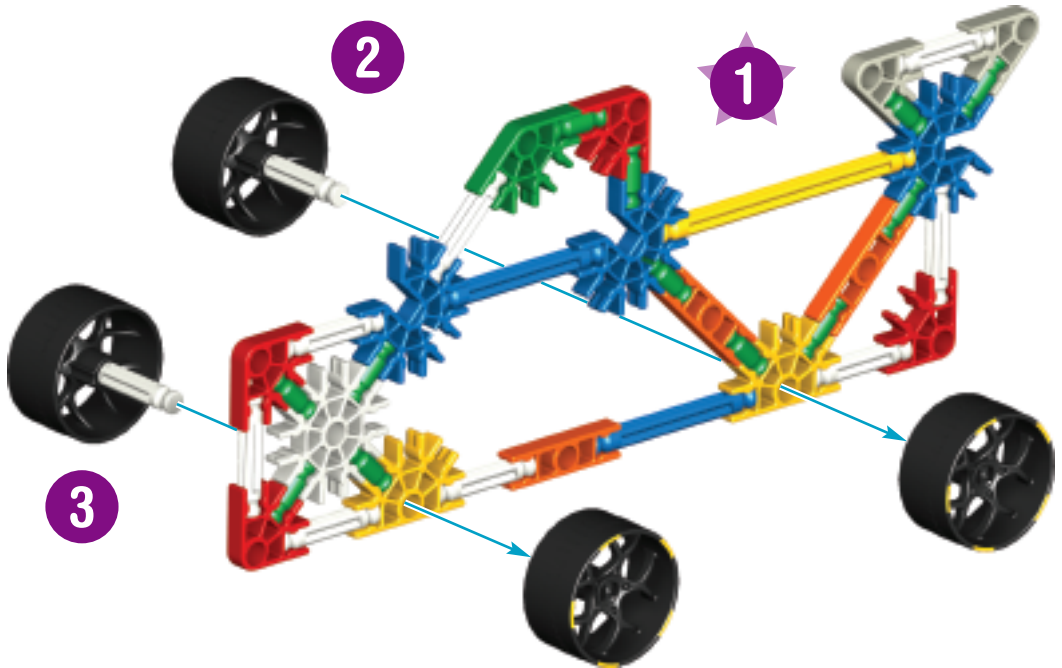
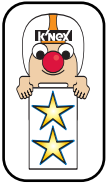

Stock Car

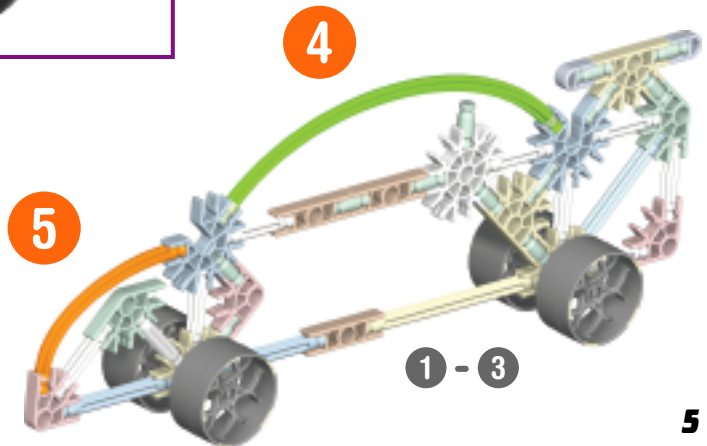
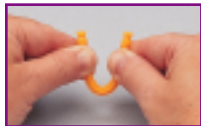

Top-Fuel Dragster



1 - 3

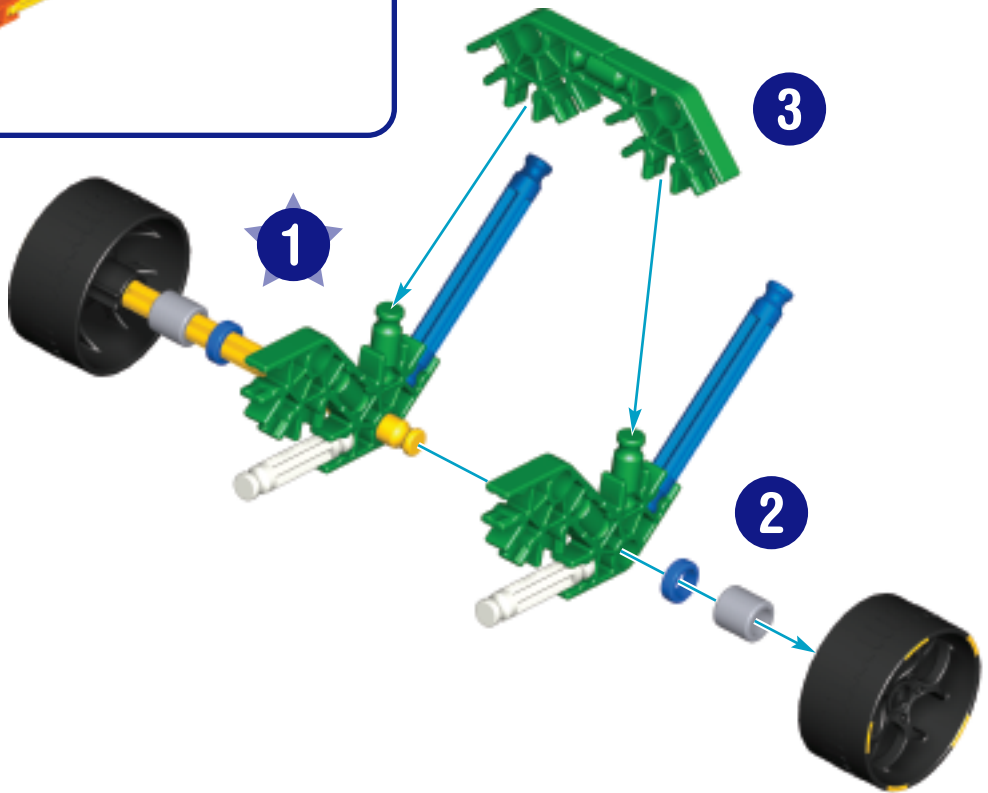

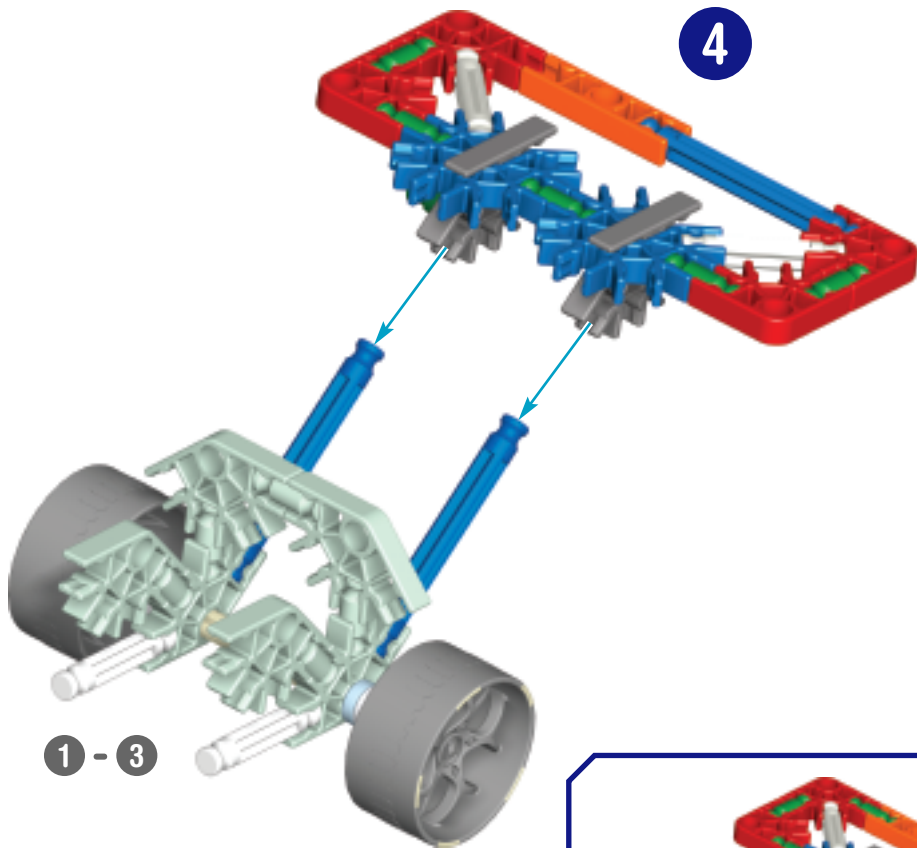

1 - 3

4

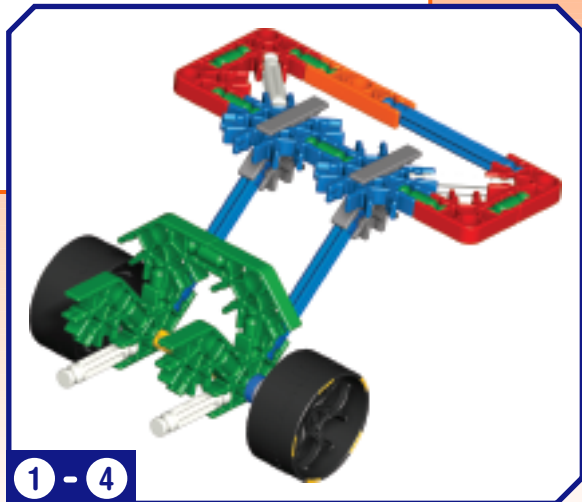

1 - 4

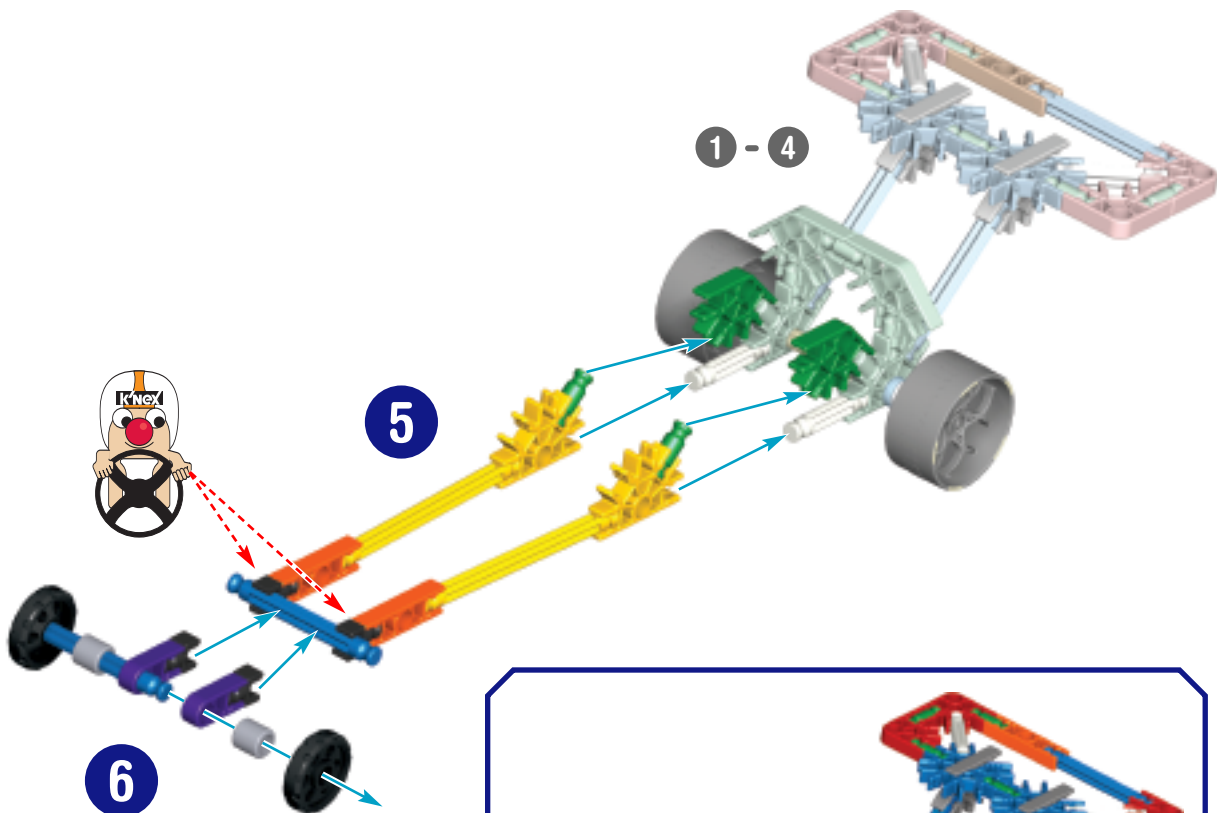

Turbo Car

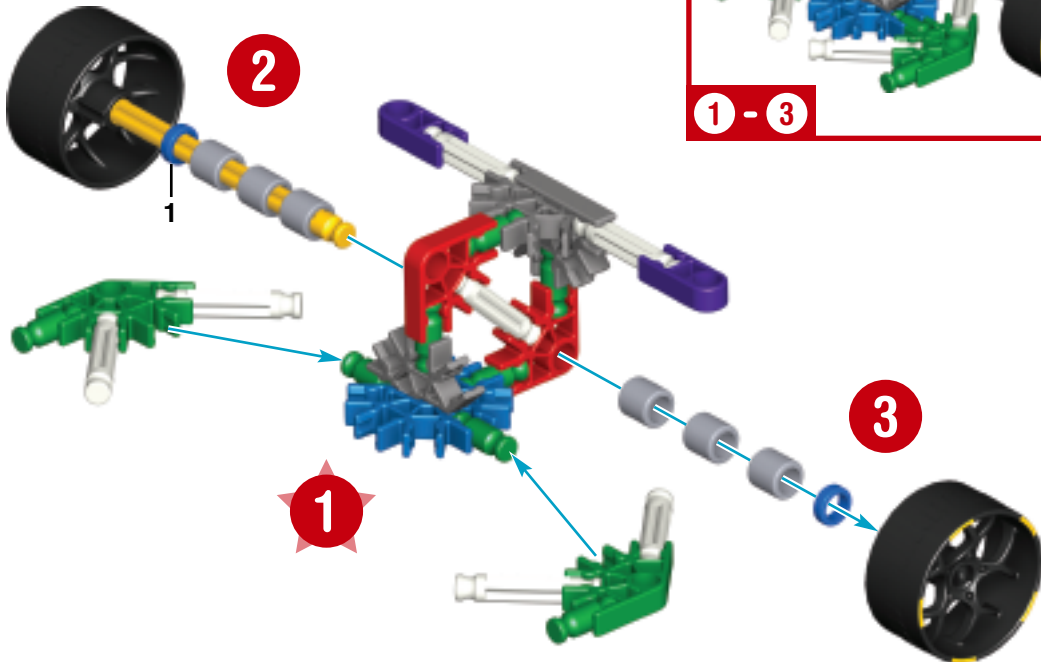
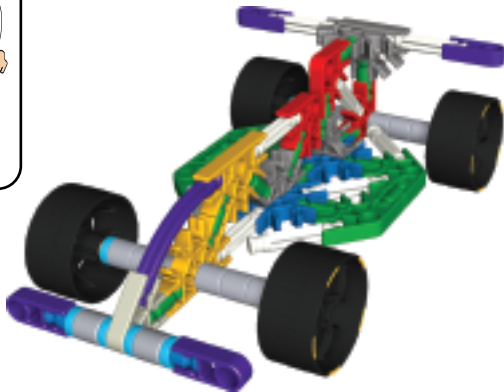
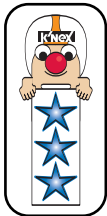

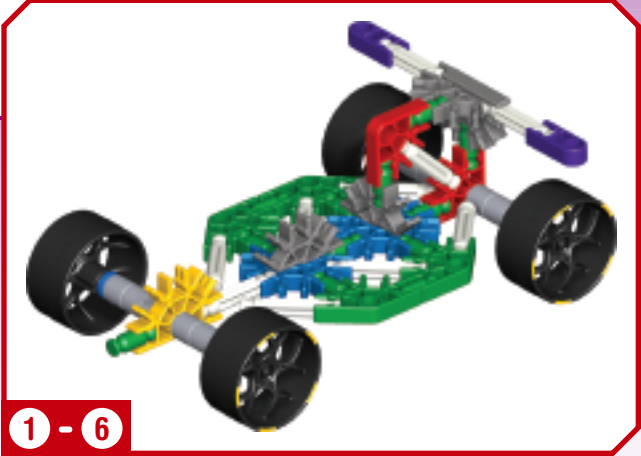
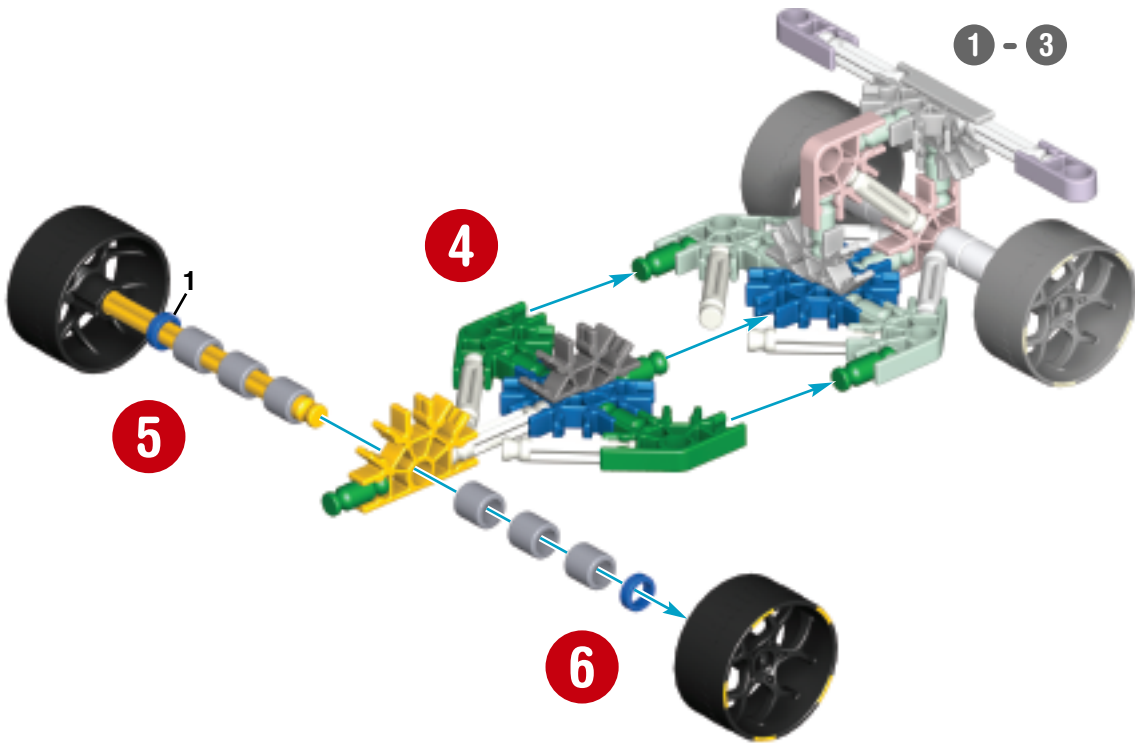

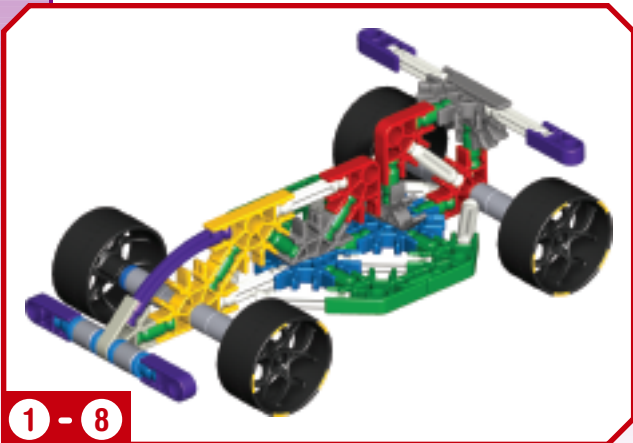
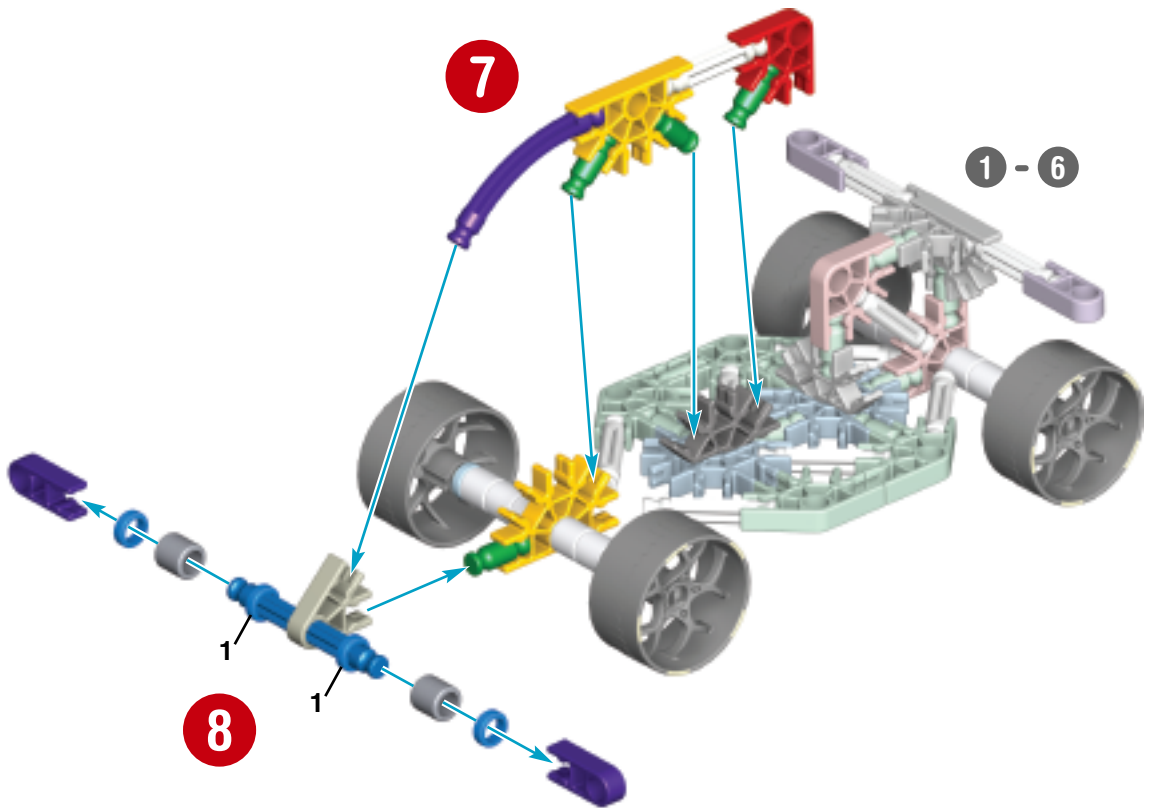

1 - 8

Speed Boat

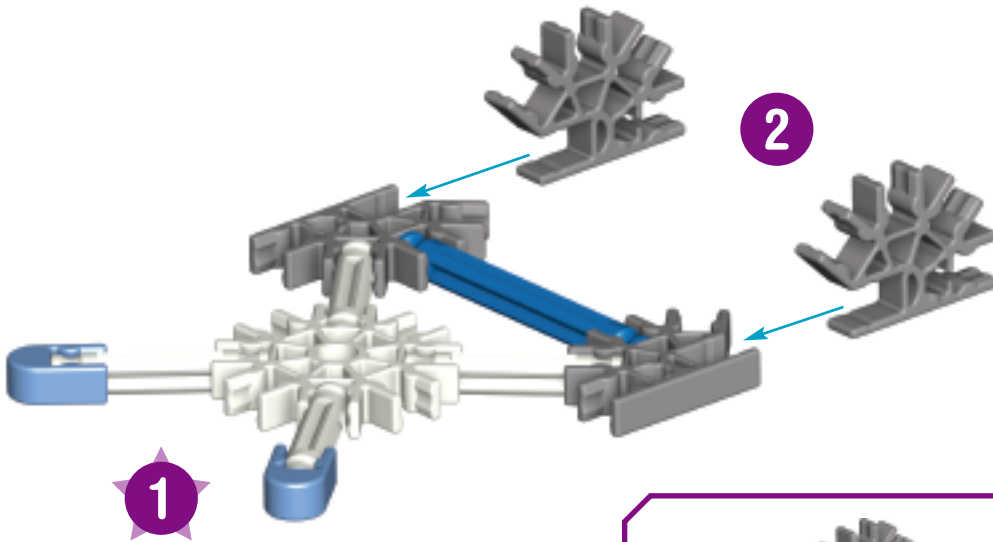
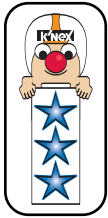

2

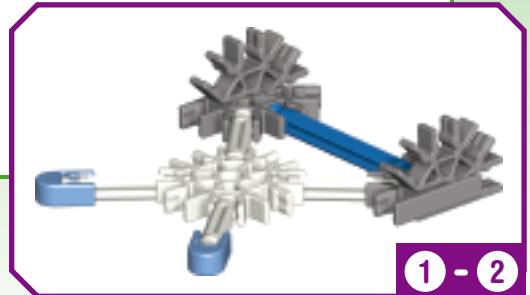

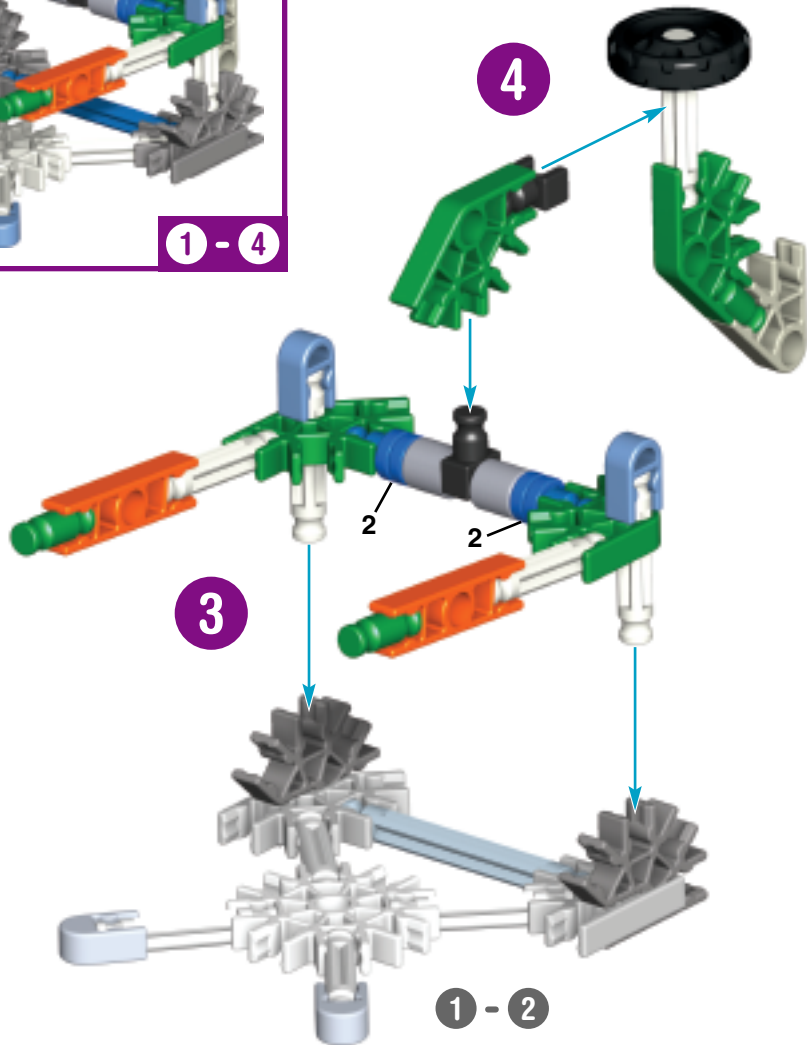
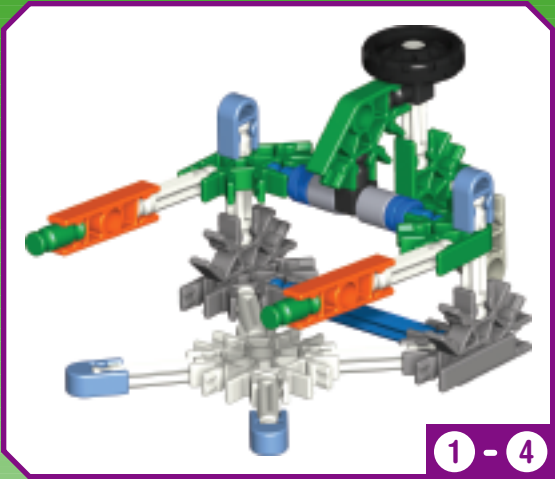

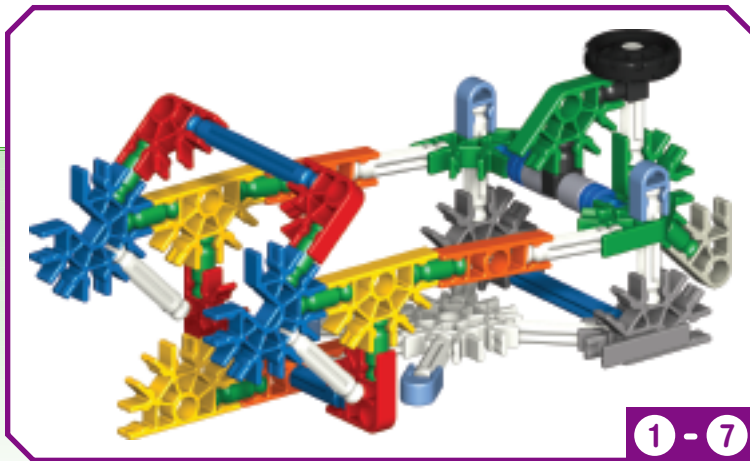
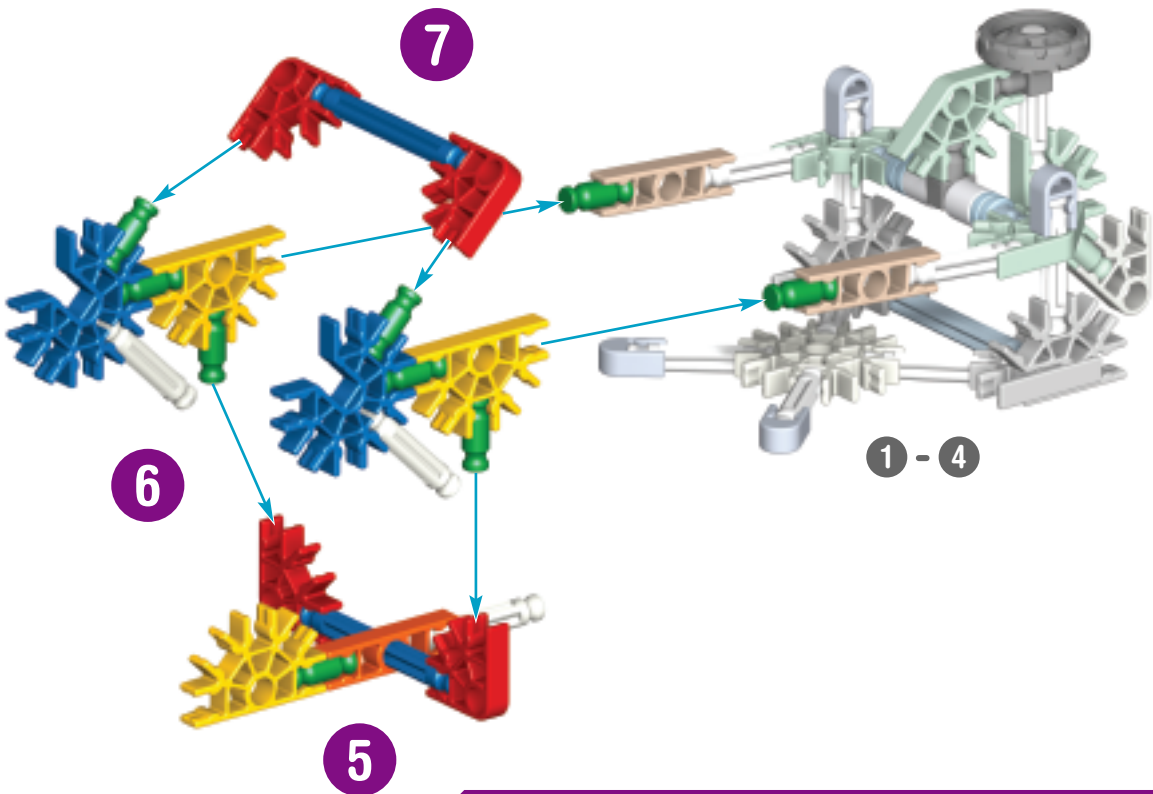

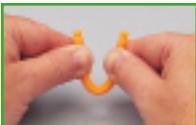

1 - 7

9

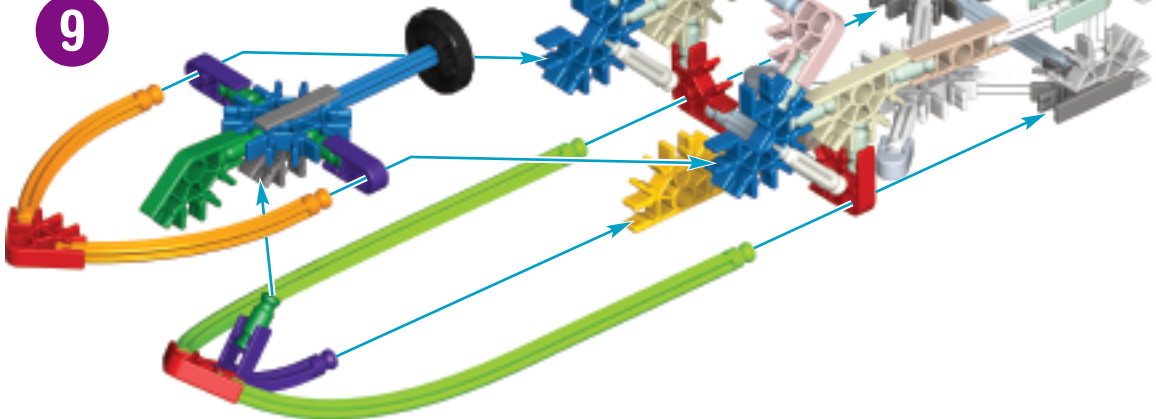

8

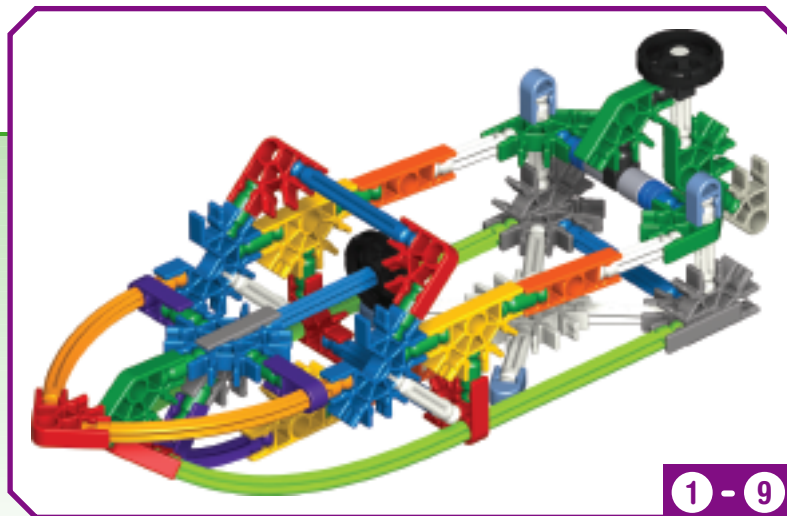

1 - 9

BUILDING IDEAS

TORTOISE & HARE

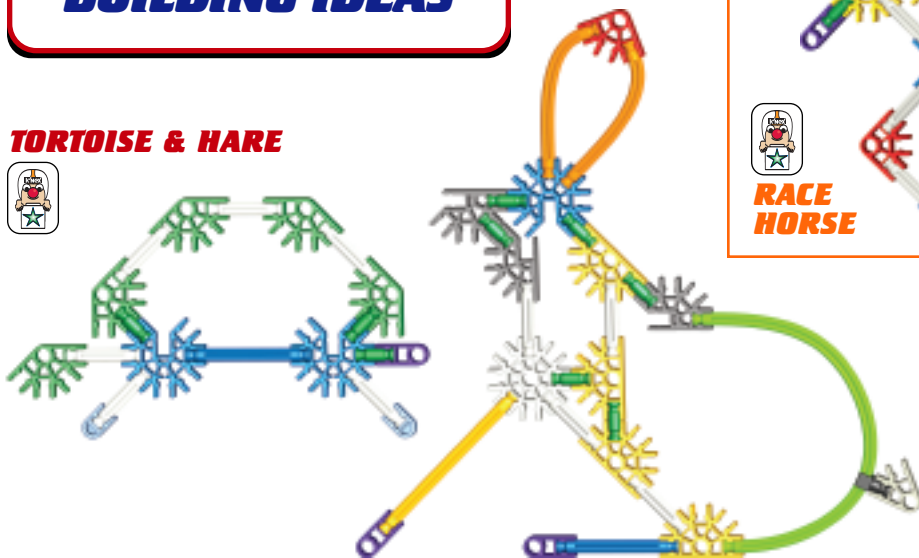

RACE HORSE



RACING BIKE



RUNNER

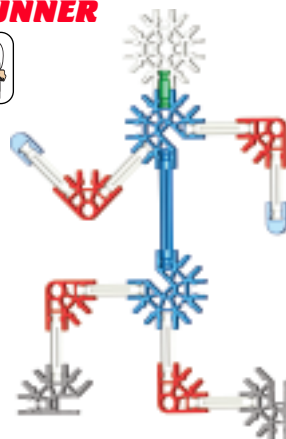

AIR RACER



FR Français

CONSTRUIRE AVEC K'NEX

"Salut. Je suis ton K'NEX copilote ! Si tu as besoin d'un coup de main... Je suis là ! Cherche-moi que je puisse te guider et t'aider à sélectionner les modèles correspondant à ton niveau. Ou bien essaie de me repérer lorsque tu rencontres des détails de construction un peu épineux."

PRÊT À MONTER

Pour commencer ton modèle, trouve le 1 et suis les chiffres. Chaque pièce a sa propre forme et sa propre couleur. Il suffit de regarder les illustrations pour retrouver les pièces correspondantes dans le jeu et de les connecter ensemble. Essaie de situer ton modèle dans le même sens que les instructions durant le montage.

SUITE...

Les couleurs dégradées indiquent que cette section est déjà montée. Tu dois connecter la section suivante à l'endroit indiqué par les flèches. Les nouvelles pièces ajoutées auront une couleur vive.

ENTRETOISES

Dans ton modèle, il y a des endroits où il faudra ajouter des entretoises bleues et argentées. Assure-toi d'utiliser la couleur correcte et compte-les soigneusement.

CONNECTEURS

Tu trouveras des connecteurs bleus et argentés comportant des fentes extra-longues. Ils se glissent l'un dans l'autre tel qu'illustré. Pousse les pièces ensemble jusqu'à ce que tu entendes un "clac".

TIGES FLEXIBLES

Un Flexi-Rod est une tige que tu peux courber pour faire des courbes. Elle pourra être attachée plus aisément à ton modèle si tu la plies en avant et en arrière plusieurs fois.

ES Español

CONSTRUYENDO CON K'NEX

"Hola. ¡Soy tu K'NEX copiloto! Si necesitas ayuda... ¡aquí estoy! Búscame para que te guíe mientras eliges modelos que corresponden al nivel de tus capacidades. O estate seguro de encontrarme cuando encuentres detalles de la construcción más complicados."

TODO LISTO, COMIENZA A CONSTRUIR

Para comenzar tu modelo, busca el 1 y sigue los números. Cada pieza tiene su propia forma y color. Simplemente mira los dibujos, busca las piezas correspondientes en tu juego y después conéctalas. Mientras construyes, trata de colocar tu modelo en la misma dirección que se muestra en las instrucciones.

CONTINÚA

Los colores desteñidos muestran que esta sección ya está construida. Conecta las nuevas secciones en los lugares señalados por las flechas. Las nuevas piezas que agregues estarán en colores vivos.

ESPACIADORES

Hay lugares en tu modelo donde tendrás que agregar espaciadores azules y plateados. Cerciérate de usar el color correcto y cuéntalos con cuidado.

CONECTORES

Hay conectores azules y plateados con ranuras largas especiales. Se enganchan deslizándose como ves en los dibujos. Conecta estas piezas empujándolas hasta que oigas "clac".

VARILLAS FLEXIBLES

Una Varilla Flexible es una Varilla que se puede doblar para formar curvas. Serán más fáciles de conectar a tu modelo si primero las doblas hacia atrás y hacia adelante.

DE Deutsch

BAUEN MIT K'NEX

"Hallo! Ich bin dein K'NEX Copilot! Ich helfe dir jederzeit! Zum Beispiel bei der Auswahl der Modelle mit dem richtigen Schwierigkeitsgrad. Oder schau einfach nach mir, wenn das Bauen der Modelle zu schwierig wird."

AUF DIE PLÄTZE, FERTIG, LOS! DAS BAUEN BEGINNT

Um mit dem Bauen deines Modells zu beginnen, suche die Nummer 1 und folge den laufenden Nummern. Jedes Teil hat seine eigene Form und Farbe. Schau dir einfach die Abbildungen an, such die Teile in deinem Bausatz, die so aussehen wie das, was du auf der Abbildung siehst und steck sie ineinander. Versuche, dein Modell beim Zusammenbauen so zu orientieren, dass es in die gleiche Richtung weist, wie es in den Anleitungen beschrieben und gezeigt wird.

UND WEITER GEHT'S

Blaue Farben weisen darauf hin, dass dieser Streckenabschnitt bereits zusammengebaut ist. Der neue Streckenabschnitt wird dort befestigt, worauf die Pfeile deuten. Die neuen Teile, die du anbaust, sind knallbunt angezeigt.

ABSTAND HALTEN

An bestimmten Stellen in deinem Modell musst du Abstandshalter, sogenannte Spacer, einbauen. Diese Abstandshalter sind blau und silberfarben. Achte darauf, dass du die richtige Farbe wählst und dass du die richtige Anzahl davon verwendest.

VERBINDUNGSSTÜCKE

Blaue und silberfarbene Steckanschlüsse haben besonders lange Spaltlöcher. Wie du auf der Abbildung sehen kannst, lassen sie sich ineinander schieben. Achte beim Aneinanderfügen dieser Teile darauf, dass du ein Klickgeräusch hörst. Erst dann sind die Teile fest miteinander verbunden.

FLEXI-LASCHEN

Eine Flexi-Lasche ist eine Lasche, die du zu einer Kurve zurechtbiegen kannst. Sie lassen sich leichter an dein Modell anschließen, wenn du sie mehrmals hin- und herbiegst, um sie flexibler zu machen, bevor du sie das erste Mal benutzt.

IT Italiano

COSTRUIRE CON K'NEX

"Ciao, sono il tuo amico costruttore K'NEX. Troverai modelli per tre livelli di costruzione. Cercami ogni volta che vuoi iniziare a costruire qualcosa e mi troverai con un segnale che mostra la difficoltà di ogni modello..... controlla:"

PRONTI, PARTENZA, VIA ALLA COSTRUZIONE

Per iniziare il modello, cerca il numero 1 e segui i numeri. Ogni pezzo ha una sua forma e un suo colore. Guarda la figura, trova i pezzi corrispondenti nel set e mettili insieme. Cerca di tenere il modello nella stessa direzione della figura e in tal modo sarà più semplice attaccare i pezzi nei posti giusti.

ANDIAMO AVANTI

I colori spenti ti dicono che questa sezione è già stata costruita. Dovrai collegare la nuova sezione al punto indicato dalla punta della freccia. Questo pezzo avrà un colore brillante.

SPAZIATORI

Ci sono punti nel tuo modello a cui dovrai aggiungere spaziatori blu e argento. Accertati di contarli attentamente.

CONNETTORI

È molto importante posizionare i connettori blu e argento in una specifica direzione. Presta molta attenzione alle istruzioni e posiziona i connettori orizzontalmente o verticalmente proprio come illustrato. Spingi con forza fino ad udire un clic.

ASTE FLESSIBILI

Un'asta flessibile può essere piegata per fare le curve. Sarà più facile attaccarla al modello se prima la pieghi per alcune volte.

PT Português

CONSTRUIR COM K'NEX

"Olá! Eu sou o teu companheiro que te vai ajudar a montar o teu K'NEX. Encontrarás modelos destinados a três diferentes níveis de dificuldade de construção. Procura-me antes de começares a montar cada construção; eu estarei segurando num letreiro para te mostrar qual o grau de dificuldade que apresenta cada modelo; presta atenção:"

ESTÁS PRONTO? COMEÇA POIS A CONSTRUIR

Para começar o teu modelo, procura o 1 e segue os números. Cada peça tem a sua própria forma definida e cor. Basta simplesmente olhares para a ilustração, procurar as peças do teu jogo correspondentes às que estás a ver e, em seguida, conectar umas nas outras. Enquanto estás a montar as peças, tenta manter o teu modelo na mesma direcção, conforme mostrado na ilustração, para assim ligares as peças correctamente.

CONTINUANDO

As cores desbotadas indicam que esta secção já está montada. Passarás então a fazer a conexão da nova secção no local indicado pelas setas. Esta peça terá uma cor viva.

ESPAÇADORES

Existirão certos pontos no teu modelo que necessitam a colocação de espaçadores azuis e prateados. Assegura-te que os contas cuidadosamente.

CONECTORES

É muito importante que posiciones os conectores azuis e cor de prateados numa direcção específica. Presta muita atenção às instruções e coloca estes conectores horizontal ou verticalmente, exactamente conforme se mostra nas ilustrações. Junta as partes simultaneamente e com firmeza até ouvires um "estalido".

VARETAS FLEXIVEIS

Uma vareta flexível é uma vareta que podes dobrar para formar curvas. Para montares no teu modelo, será mais fácil se dobrares primeiro a vareta para trás e para a frente.

NL Nederlands

BOUWEN MET K'NEX

"Groetjes. Ik ben je K'NEX co-piloot. Heb je hulp nodig ... Hier ben ik dan. Kijk naar me uit voor inlichtingen wanneer je modellen kiest met de gepaste moeilijkheidsgraad. Of kijk naar me uit wanneer de opbouwdetails een beetje ingewikkeld worden."

KLAAR OM TE BOUWEN

Om met je model te beginnen, vind eerst het nummer 1 en volg de nummers. Elk stuk heeft zijn eigen vorm en kleur. Kijk gewoonweg naar de afbeeldingen, vind de overeenstemmende stukken terug in je geheel en maak ze aan mekaar vast. Tracht je model in dezelfde richting te plaatsen als de aanwijzingen terwyl je bouwt en monteert.

VERDER NOG ...

De vervaagde kleuren duiden aan dat dit deel reeds is opgebouwd. Gelieve het nieuwe deel vast te koppelen op de plaats aangeduid door de pijlen. De nieuwe delen die je toevoegt verschijnen in volle kleur.

TUSSENSTUKKEN

In je model zijn er plaatsen waar blauwe en zilveren tussenstukken moeten toegevoegd worden. Verzeker je ervan de juiste kleur te gebruiken en tel ze zorgvuldig.

KOPPELSTUKKEN

Er zijn blauwe en zilveren koppelstukken met speciale lange gleuven. Ze schuiven in mekaar zoals je kunt zien op de afbeeldingen. Duw deze onderdelen in mekaar tot je een "klik" hoort.

FLEXI-RODS

Een Flexi-Rod is een stang die kan gebogen worden om bochten of curves te maken. Ze maken zich gemakkelijker vast aan je model wanneer je ze eerst een paar keer heen en weer buigt.

SV Swedish

*"HEJ, jag är din K'NEX byggkompis. Behöver du hjälp...
Jag finns här."*

PLATSERNA, FÄRDIGA, BYGG

Hitta nummer 1 och följ numreringen. Varje del har sin egen form och färg. Titta på bilden, räkta upp motsvarande delar och tryck dem på plats.

FORTSÄTT

De bleka färgerna anger att denna sektion redan är byggd. Koppla den nya sektionen till stället som anges av pilarna. Dessa delar visas i klara färger.

MELLANSTÄNGER

Det finns ställen i din modell där du måste placera mellanstänger. Använd rätt typ och räkna dem omsorgsfullt.

KOPPLINGAR

Det finns blå och silverfärgade kopplingar med speciellt långa hål som skjuts samman. Tryck ihop delarna tills du hör ett klick-ljud.

FLEXI-RODS

En Flexi-rod är en stång som du böjer för att göra kurvor. Det är lättare om du först böjer den fram och tillbaka.

DA Danish

"HEJ, jeg er din K'NEX byggekammerat. Hvis du har brug for hjælp ... så kom bare til mig."

PARAT, PÅ MÆRKERNE, BYG

Find nummer 1 og følg numrene. Hvert stykke har sin egen form og farve. Se på billedet, match stykkerne til hinanden og snap dem sammen.

SÅ FORTSÆTTER VI

De falmede farver betyder, at dette afsnit allerede er bygget. Sæt det nye afsnit sammen på det sted, som pilene peger mod. Disse dele vil være i klare farver.

AFSTANDSSTYKKER

Der er steder i modellen, hvor du får brug for at tilføje afstandsstykker. Sørg for at bruge de rette stykker og tæl den omhyggeligt.

SAMLESTYKKER

Der er blå og sølvfarvede samlestykker med særlige lange slider, som skydes sammen. Skub delene sammen, indtil du hører et "klik".

FLEKSI-STÆNGER

En fleksistang er en stang, som du bøjer til at lave buer. Det bliver lettere, hvis stangen bøjes frem og tilbage først.

NO Norwegian

*"HEI, jeg er din K'NEX byggekamerat. Trenger du hjelp...
er jeg her."*

KLAR, FERDIG, BYGG

Finn tallet 1 og følg numrene. Hver del har sin egen form og farge. Se på bildet, finn tilsvarende deler og smekk dem sammen.

FORTSETT

De bleke fargene viser deg at denne delen allerede er bygget. Fest den nye delen der pilen peker. Disse delene har sterke farger.

MELLOMLEGG

Noen steder må du bruke mellomlegg i modellen din. Pass på å bruke de riktige mellomleggene og tell dem nøye.

SKJØTEMUNNSTYKKER

Det er blå og sølvfargede skjøtemunnstykker med spesielt lange åpninger, som glir sammen. Skyv delene sammen inntil du hører et klikk.

FLEKSISTENGER

En fleksistang er en stang som du bøyer for å lage buer. Det blir lettere hvis du bøyer den frem og tilbake først.

FI Finnish

*"HEI, olen K'NEX rakennuskaverisi. Tarvitsetko apua ...
olen paikalla."*

PAIKOILLANNE, VALMIIT, RAKENTAKAA

Löydä numero 1 ja seuraa numerointia. Jokaisella osalla on oma muotonsa ja värinsä. Katso kuvaa, sovita osat ja paina ne yhteen.

JATKA

Himmeät värit osoittavat, että tämä kokonaisuus on jo rakennettu. Liitä uusi kokonaisuus nuolien osittamaan paikkaan. Nämä osat näkyvät kirkkain värein.

VÄLITANGOT

Mallissasi on paikkoja joihin sinun on lisättävä välitankoja. Varmista, että käytät oikeita ja laske ne huolellisesti.

LIITTIMET

Sarjassa on sinisiä ja hopeanvärisiä liittimiä, joissa on erityisen pitkiä aukkoja, jotka työnnetään toisiinsa. Työnnä osat yhteen kunnes kuulet napsahduksen.

FLEXI-RODS

Flexi-rod on tanko, jonka taivutat kun haluat tehdä kaarteita. On helpompaa, jos ensin taivutat sitä edestakaisin.

KNEX.COM



Questions? Call 1-800-KID-KNEX (U.S.A./Canada only) or 00800-22427276 (UK/Ireland only)
Write to email@knex.com or visit www.knex.com

For Customer Service outside the USA, CAN, GBR please contact local distributor. Distributor information can be found at: <http://www.knex.com/contact/international.php>

Le Service clients hors d'USA et CAN, s'il vous plaît contacter le distributeur local. L'information de distributeur peut être trouvée à <http://www.knex.com/contact/international.php>

©2007 K'NEX Industries, Inc.
P.O. Box 700, Hatfield, PA 19440-0700

Products may not be available in certain countries.

Les produits peuvent ne pas être disponibles dans certains pays.
Los productos pueden no estar disponibles en determinados países.
Die Produkte sind in bestimmten Ländern evtl. nicht erhältlich.
I prodotti potrebbero non essere disponibili in alcuni paesi.
Os produtos podem não estar disponíveis em determinados países.
Eventueel kunnen de producten niet beschikbaar zijn in andere landen.
Produktene är eventuellt inte tillgängliga i vissa länder.
Produktterne er muligens ikke tilgængelige i vissa lande.
Nævn produktet er ikke i alle land.
Tuotteet eivät välttämättä ole saatavissa joksakin maassa.



Product & colors may vary. Models can be built one at a time.

K'NEX is a registered trademark of K'NEX Industries, Inc.
Produits et couleurs peuvent varier. La plupart des modèles ne peuvent être construits que un à un. K'NEX est une marque déposée de K'NEX Industries, Inc.
El producto y los colores pueden variar. La mayoría de los modelos se puede construir uno a la vez. K'NEX es una marca registrada de K'NEX Industries, Inc.

Manufactured under U.S. Patents/Fabriqué sous brevets américains/
Fabricado bajo patentes de EE.UU. 5,061,219; 5,137,486; 5,199,919;
5,350,331. Other U.S. and foreign patents pending.
Autres brevets américains et étrangers en instance.
Otras patentes de EE.UU. y países extranjeras pendientes.
Conforms to ASTM F963-03. Conforme aux ASTM F963-03.
Cumple con F963-03 de la ASTM.

407438.11-V1-2/07