

KNEX®

Imagine • Build • Play®

5+



10 MODEL BUILDING SET WHEEL ACTION™

! WARNING:

CHOKING HAZARD - Small parts.
Not for children under 3 years.

! AVERTISSEMENT:

DANGER D'ÉTOUFFEMENT - Pièces de petite taille.
Ne pas donner aux enfants de moins de 3 ans.

61007/61007A/70328

BUILDING INSTRUCTIONS:

★	QUICK CAR	3
★	SPEEDSTER	4
★★	FLATBED TRUCK	6
★★	DRAGSTER	10
★★	TOW TRUCK	14
★★★★	PLOW	18

BUILDING IDEAS:

★	MINI CAR	
★	AIRPLANE	
★	FUNNY CAR 1	22
★	FUNNY CAR 2	
★★★★	FORKLIFT	

TRANSLATIONS:

Deutsch
Français
Italiano
Español
Português
Nederlands

23

Parts Count:

Before you start building, be sure to compare the parts in your set with the list here. If anything is missing, call or write to us using the contact information on the back cover of this book. We're happy to help you!



Start Building:

Follow the steps in order. Each part has its own color and shape. Look at the picture, find the parts in your set that match and put them together. Try to hold your model in the same direction as the picture so you'll attach your piece to the right place.

Next Step:

The faded colors are the sections you have already built. You'll want to connect the next parts to the place where the arrows are pointing. There isn't an arrow for every connection spot.

Spacers:

Some models use different colored spacers. Be sure that you use correct color, size and number of spacers.



1

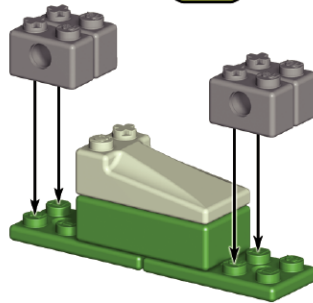

1 • 2



QUICK CAR

2

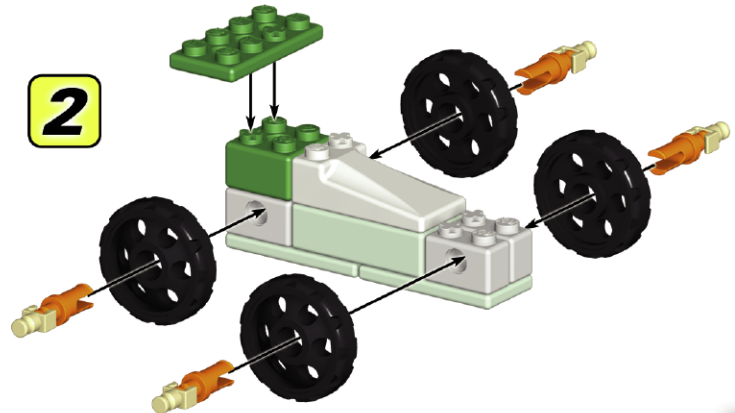

1

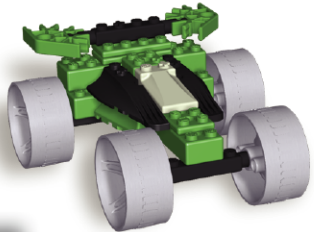
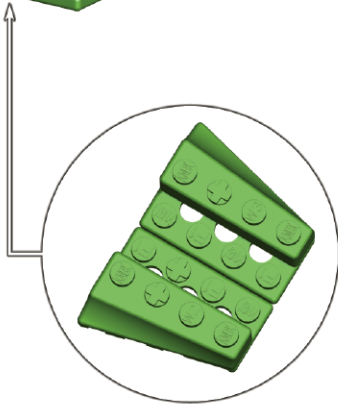
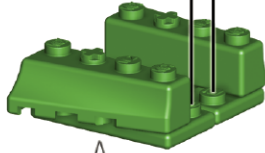
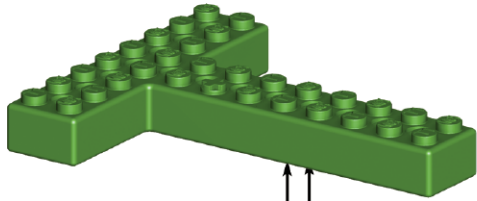

SPEEDSTER

1-2

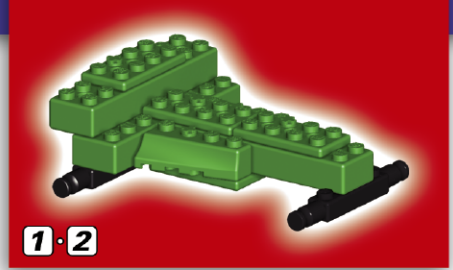

2

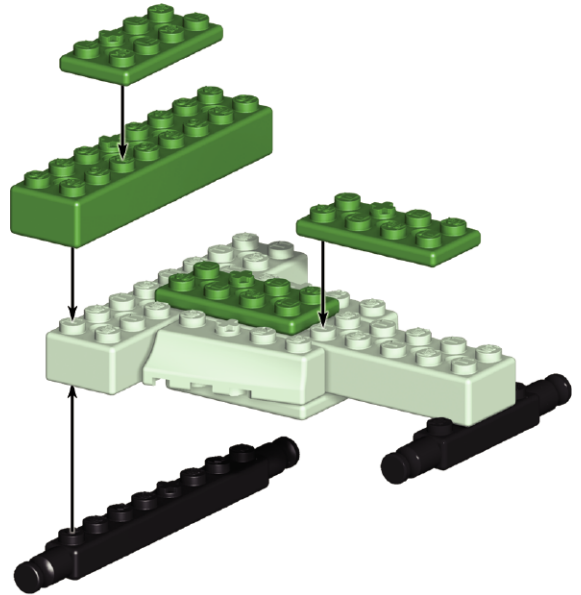



3

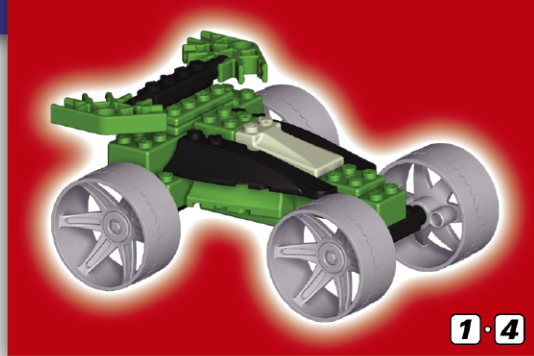

1 · 4

SPEEDSTER

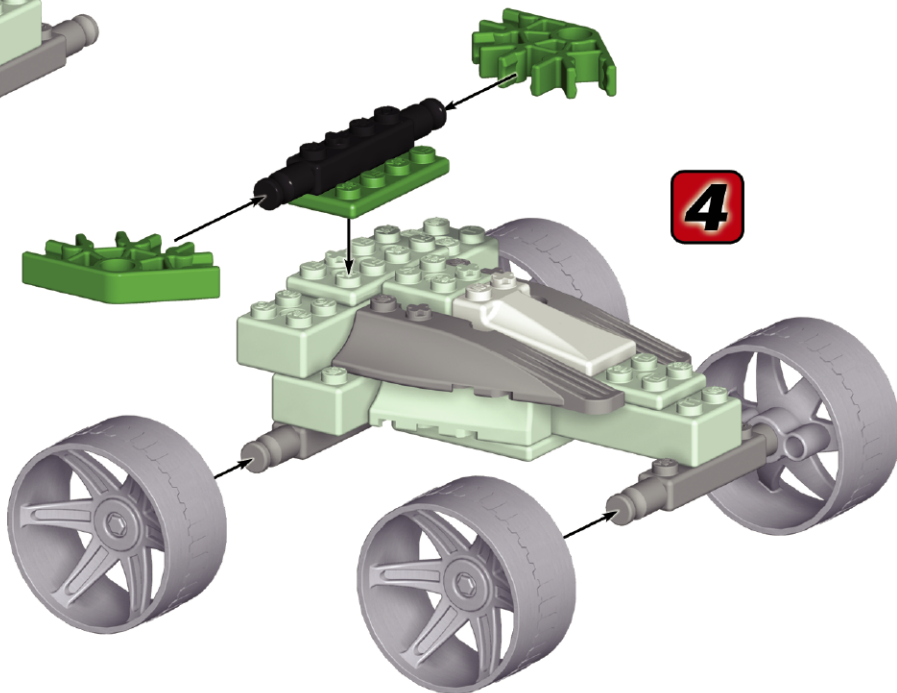

4

FLATBED TRUCK

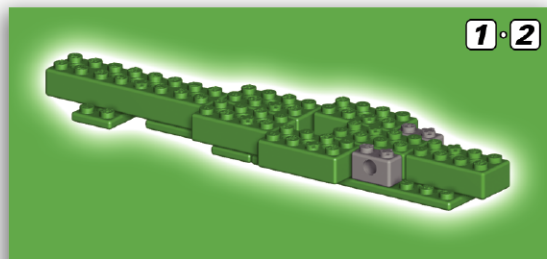
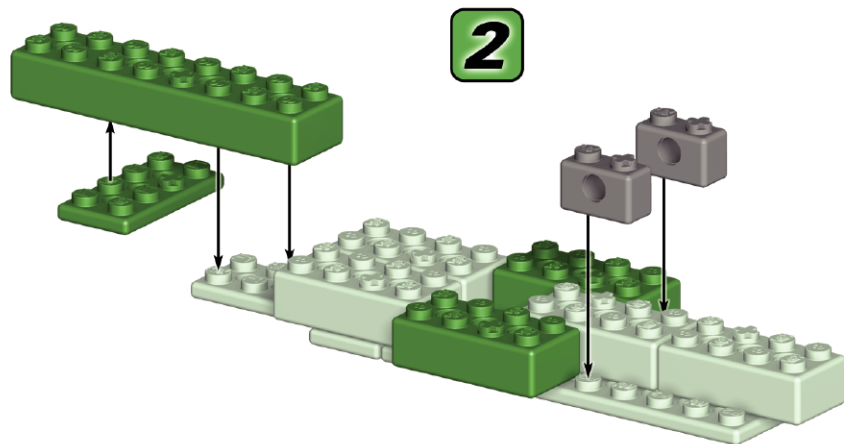
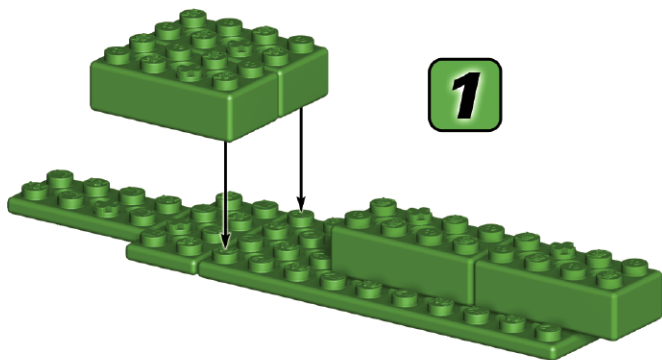
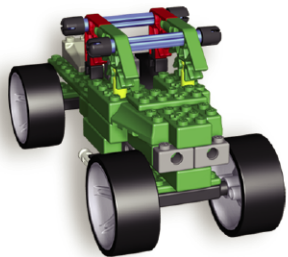

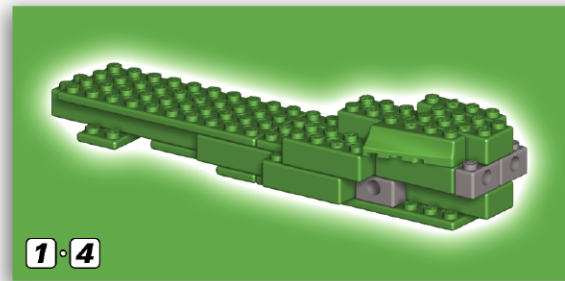
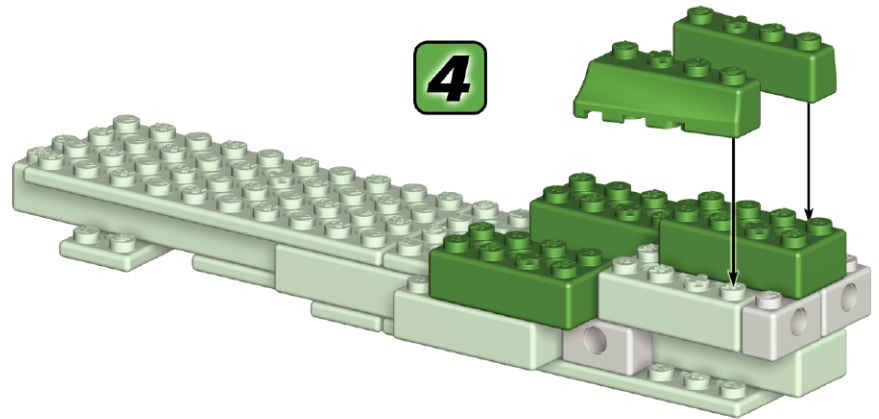
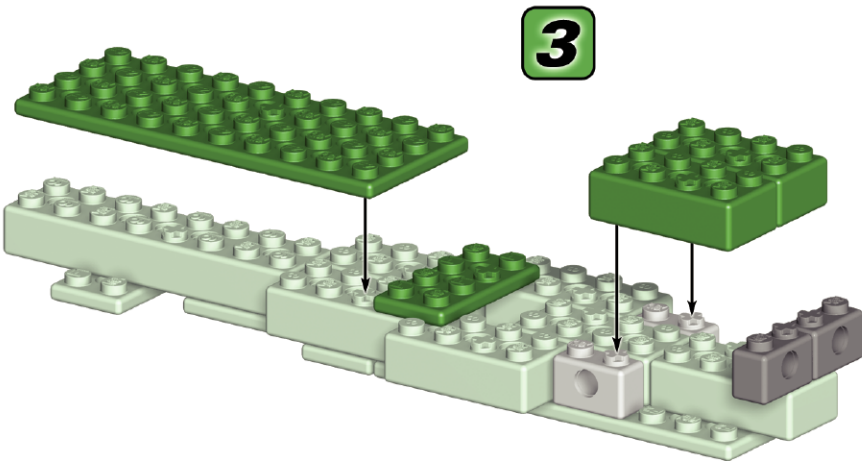

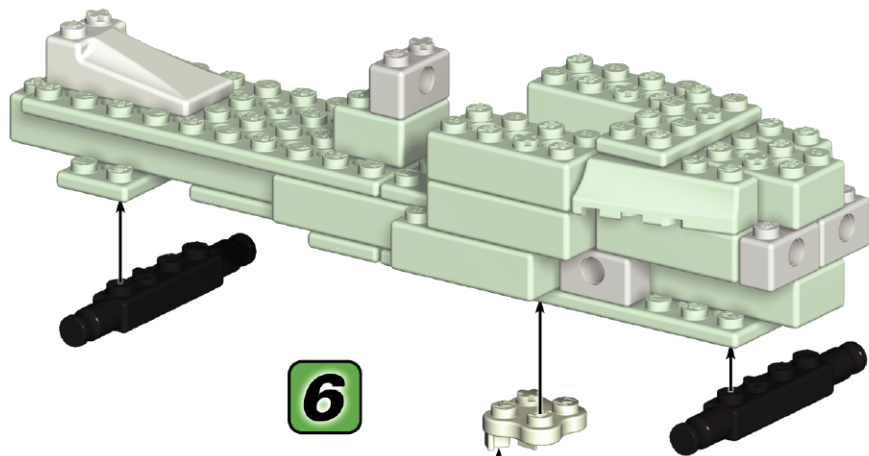
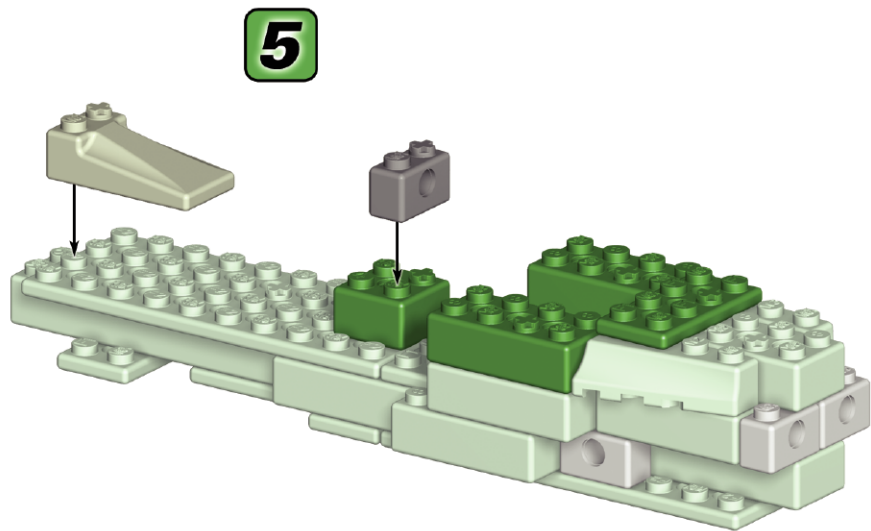

6

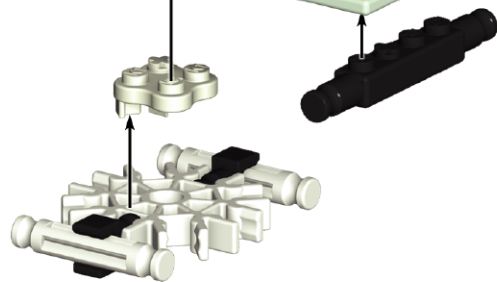

8

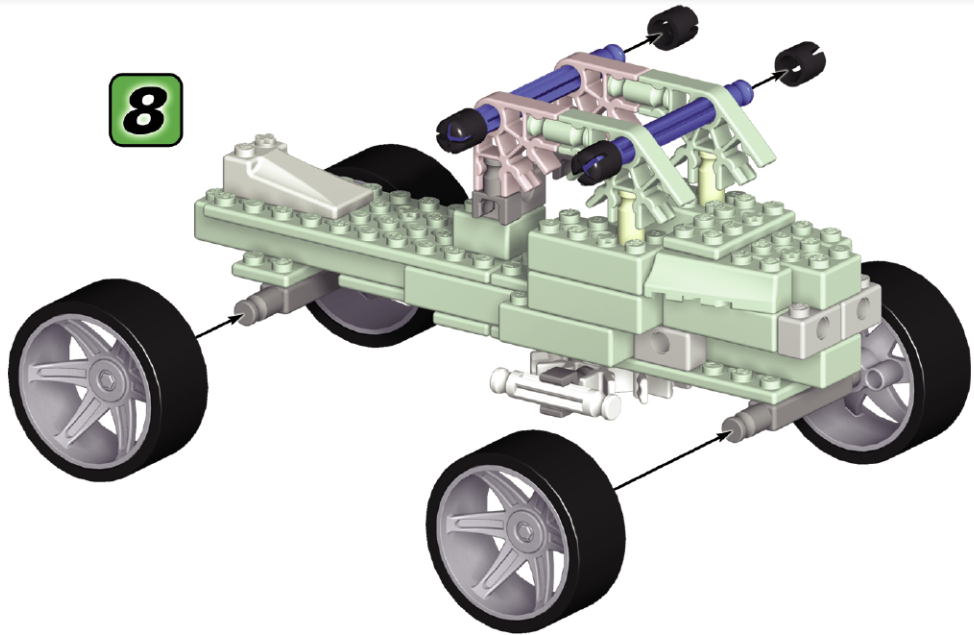

7

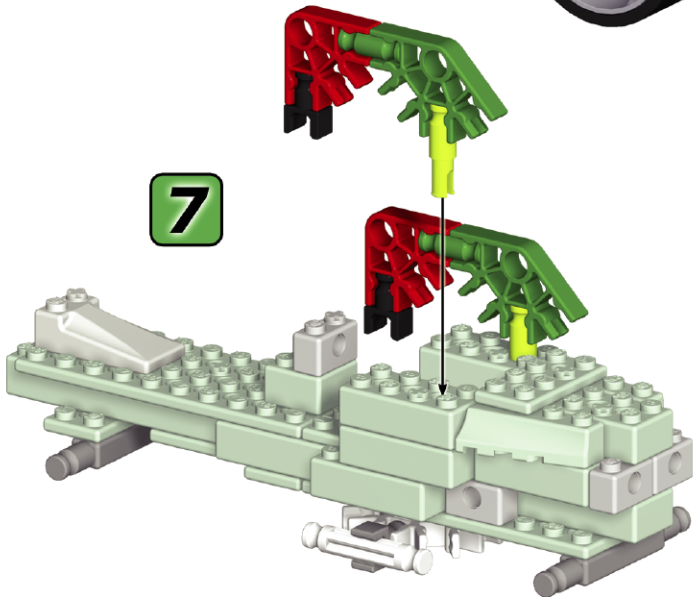

FLATBED TRUCK

1-8



DRAGSTER

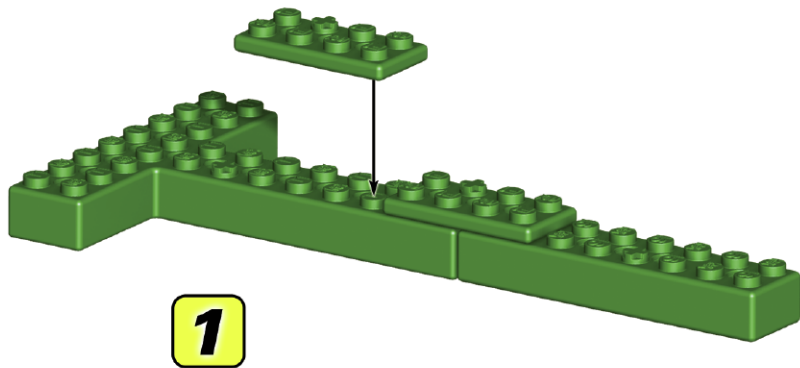
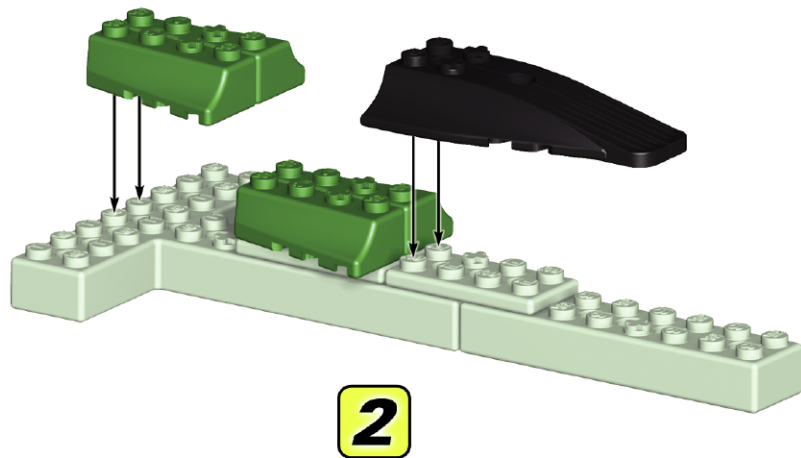
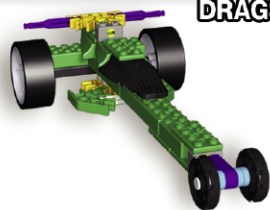

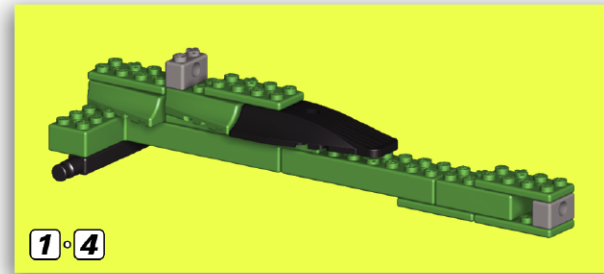
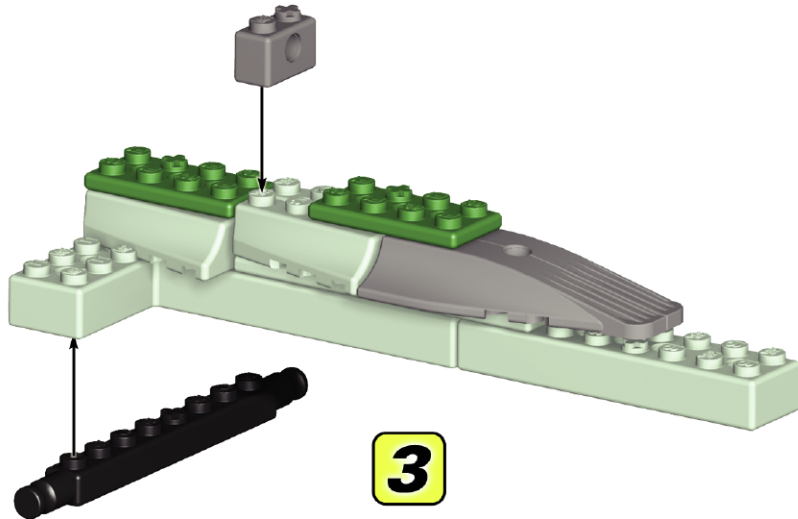
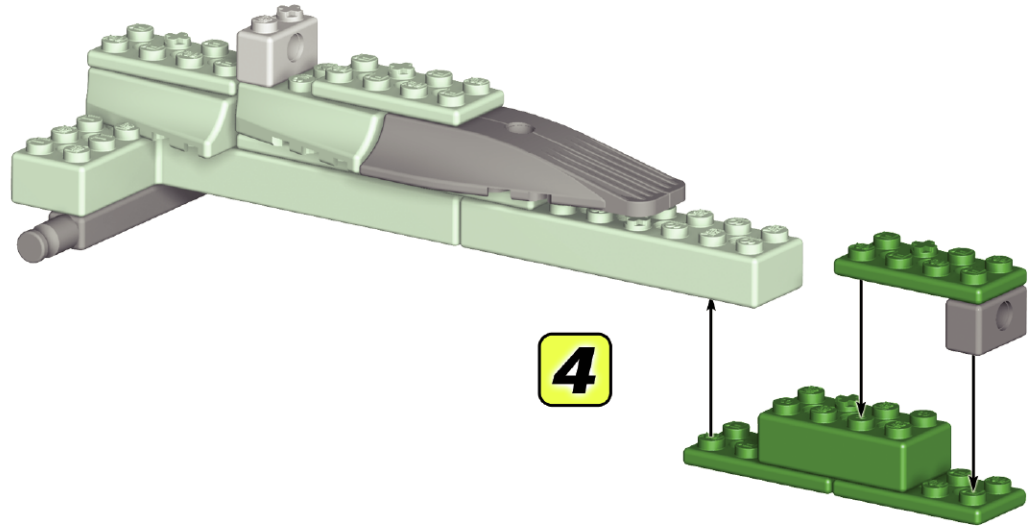

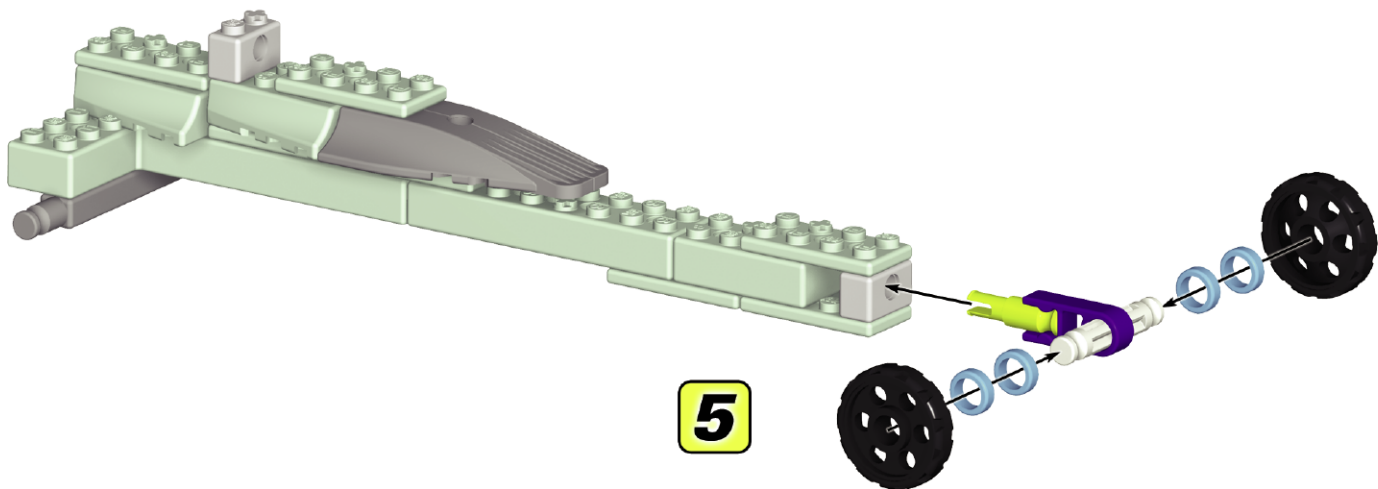
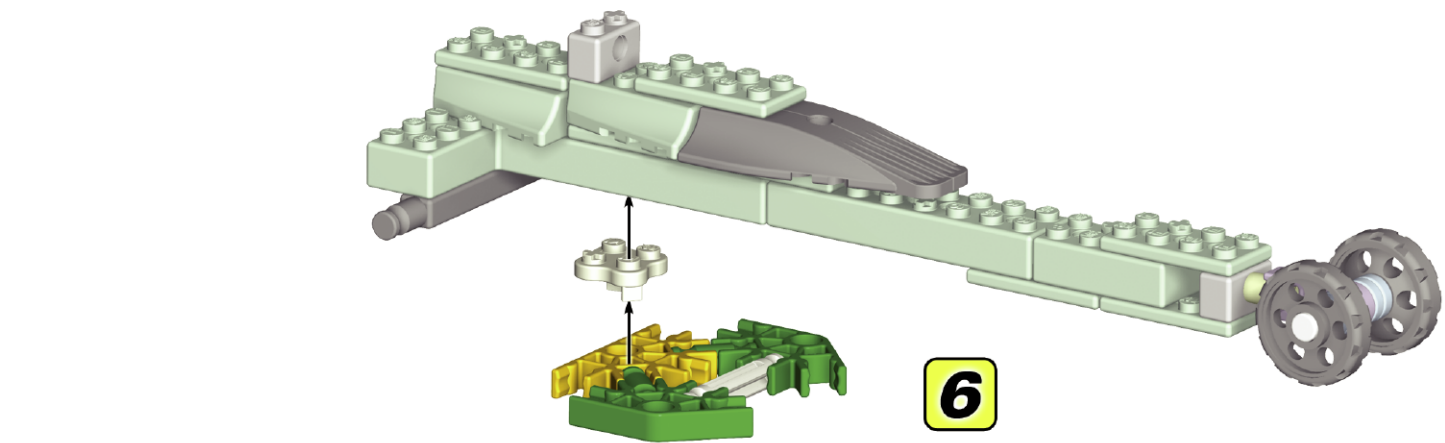

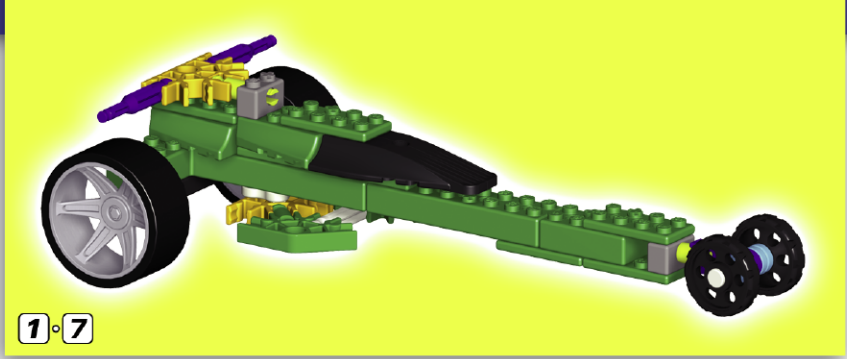

DRAGSTER

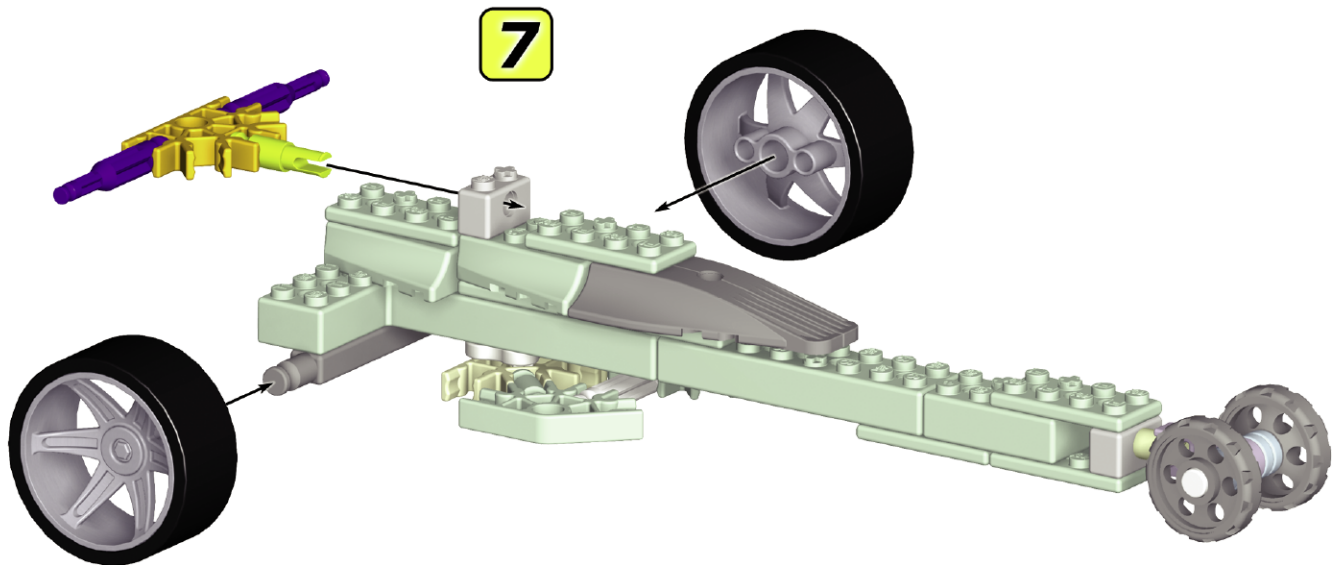

TOW TRUCK

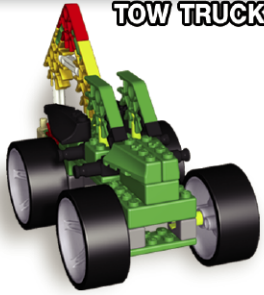

2

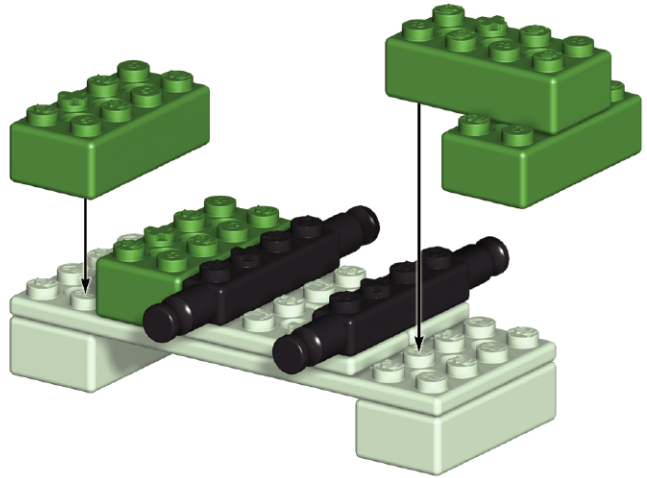

1

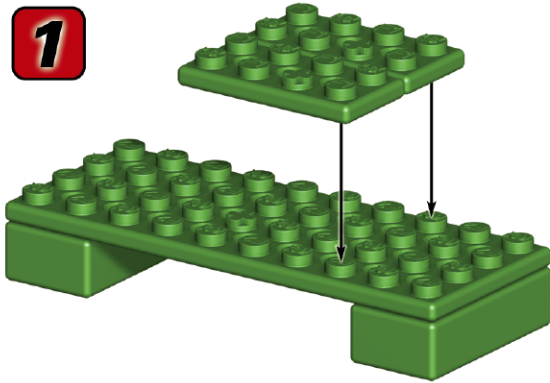

1-2

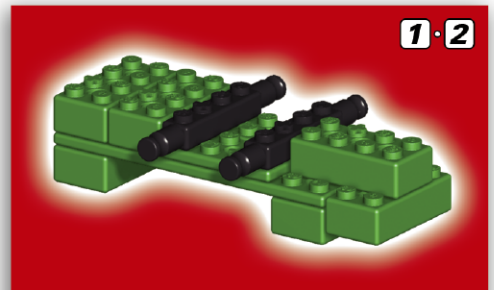

3

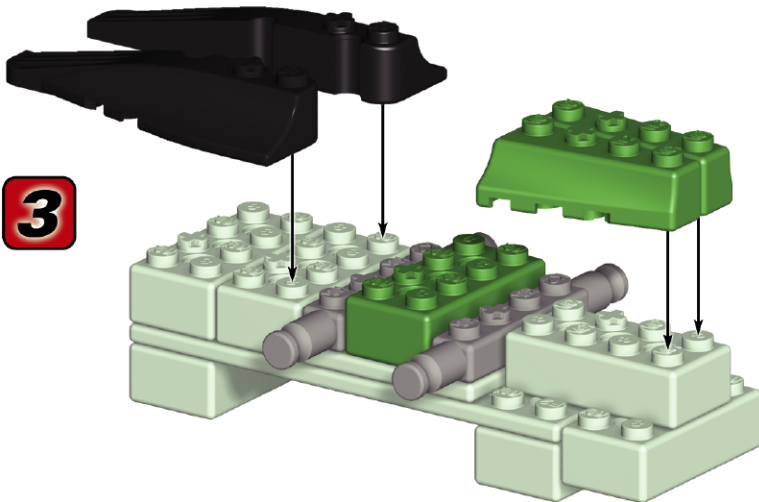

4

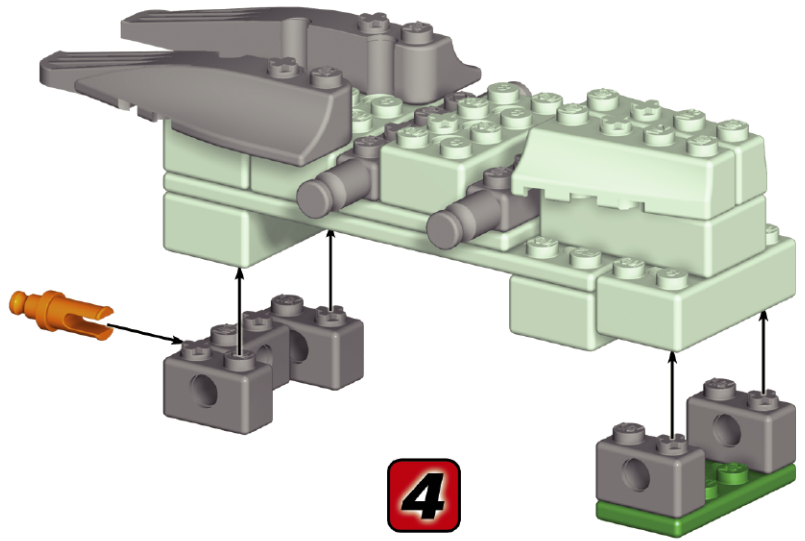

1-4

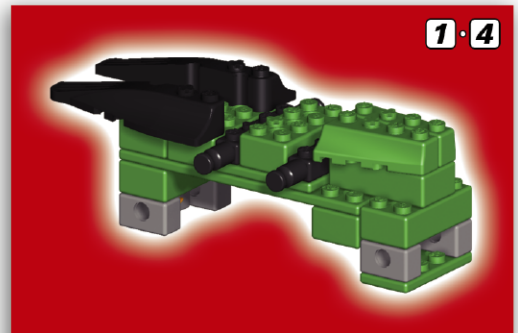

5

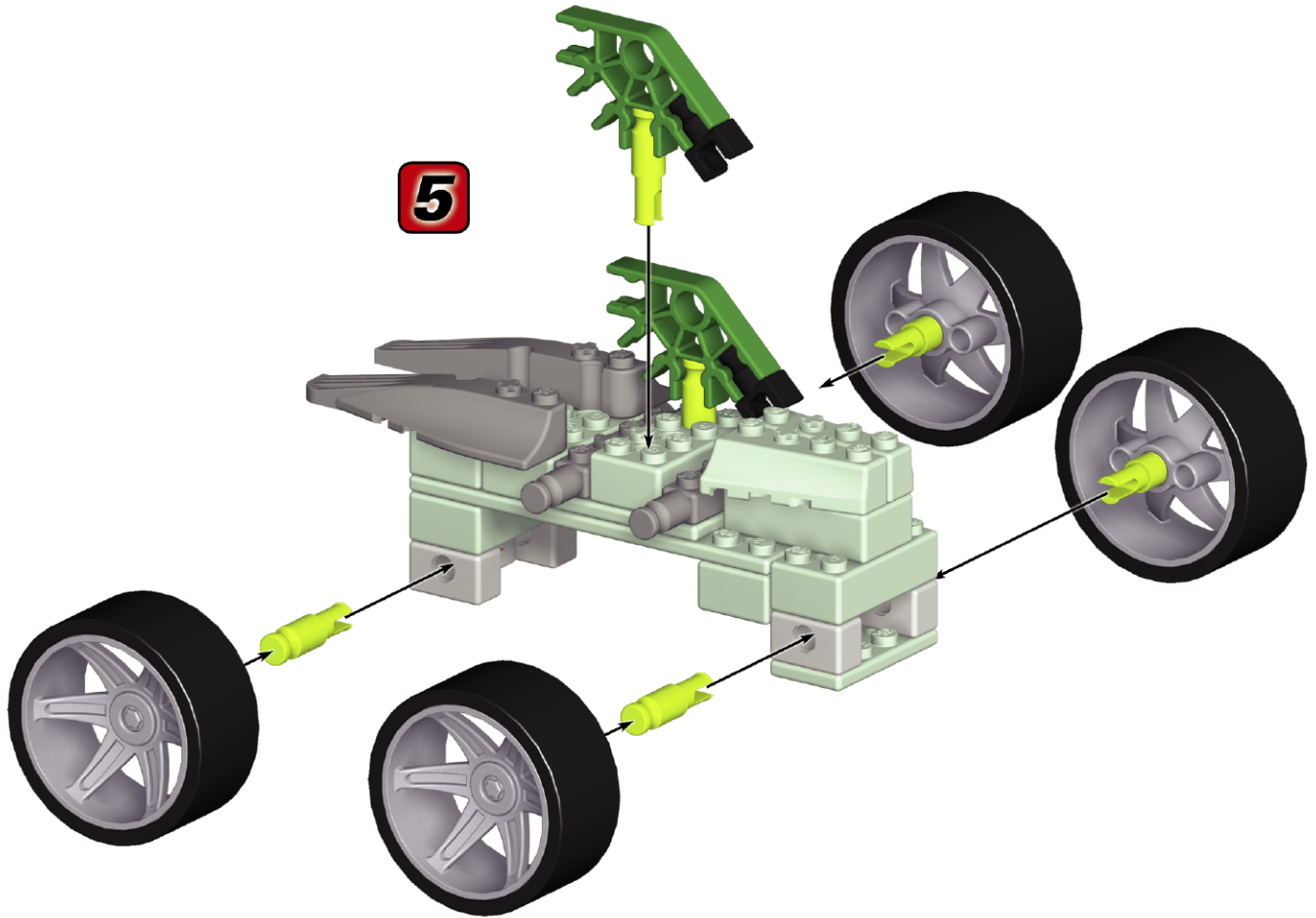

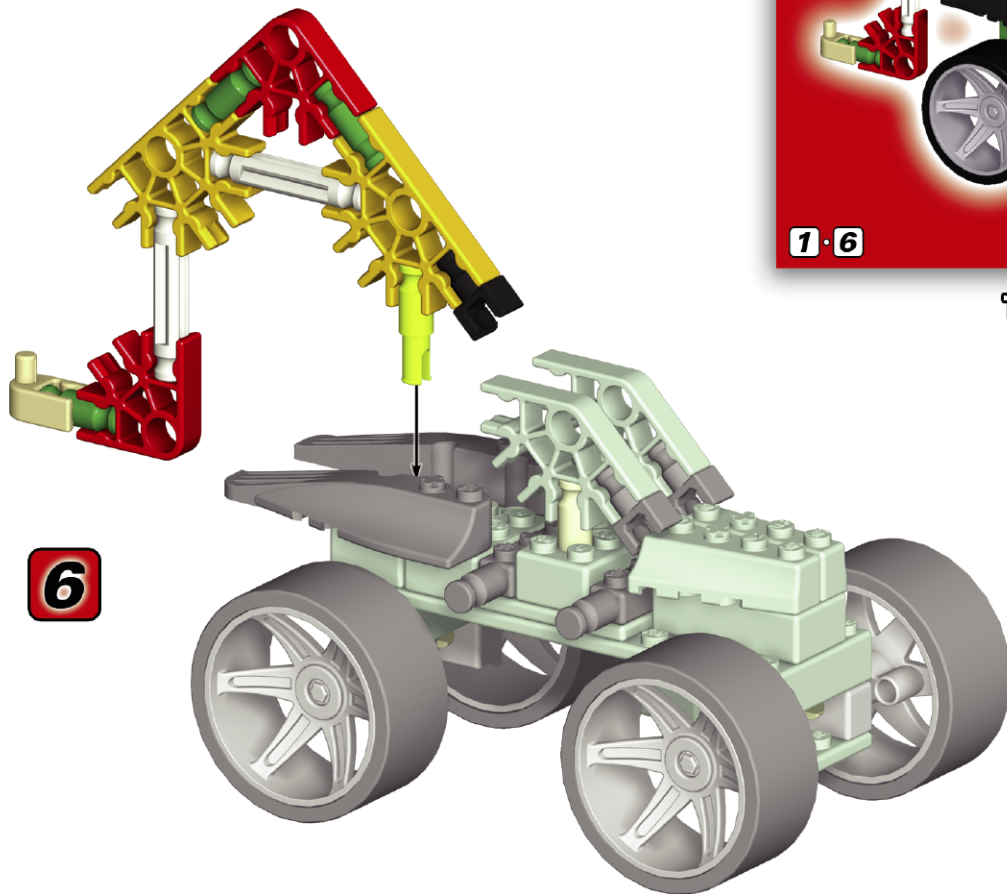

1-6



TOW TRUCK

FLOW

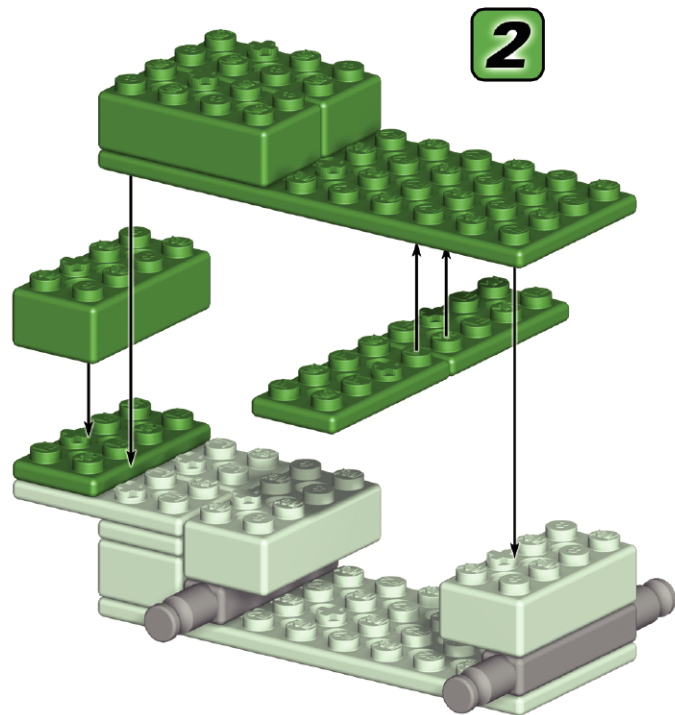
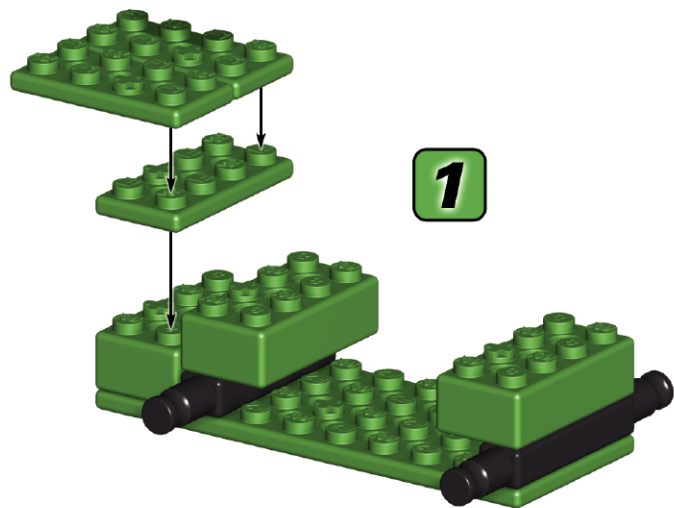
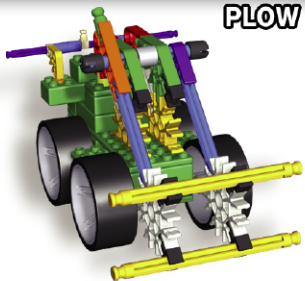

3

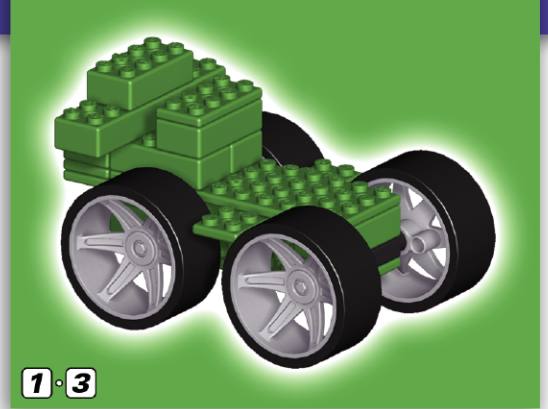
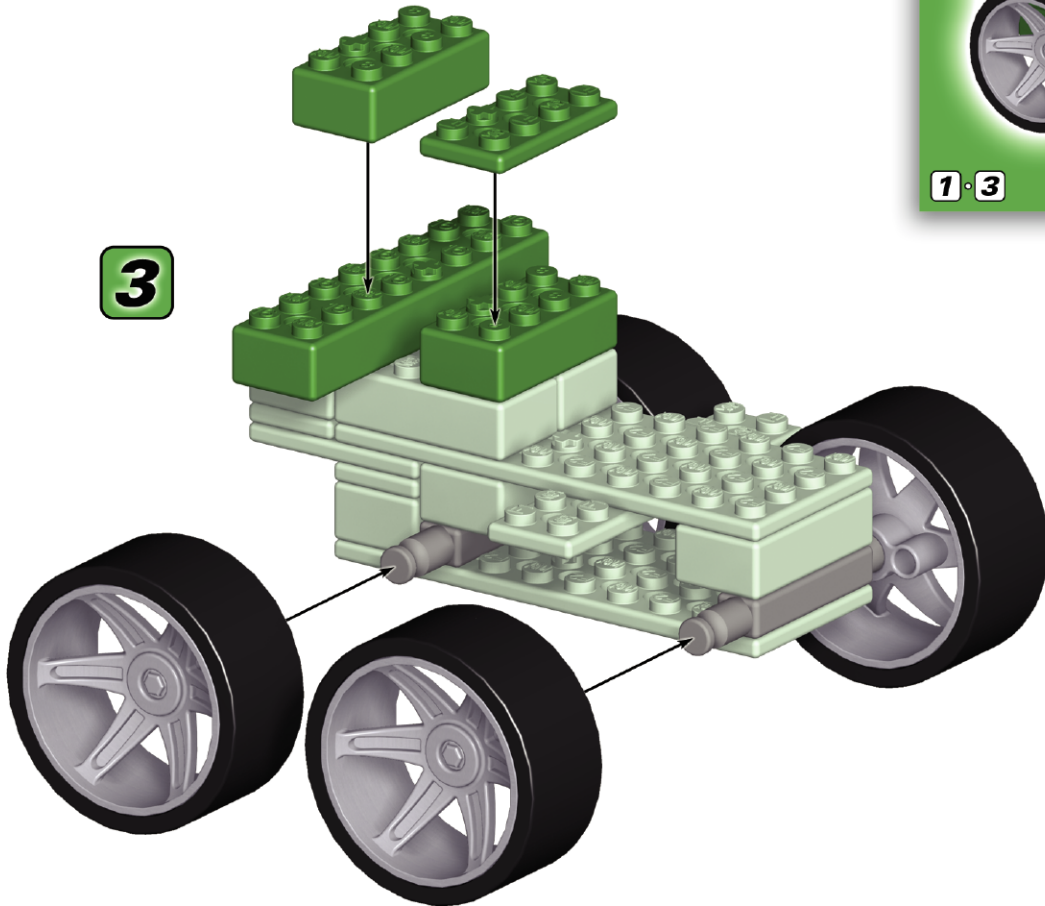

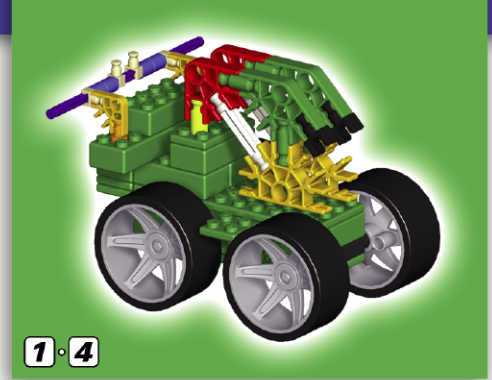
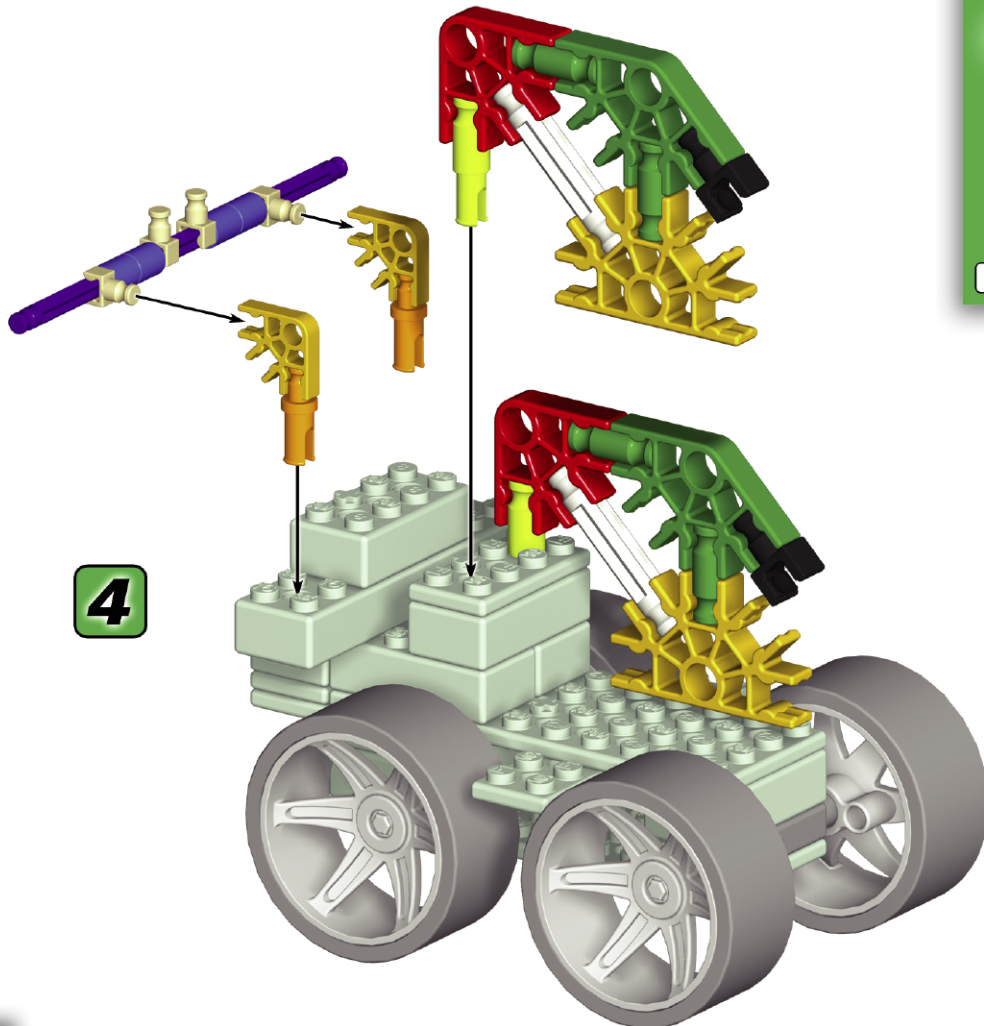

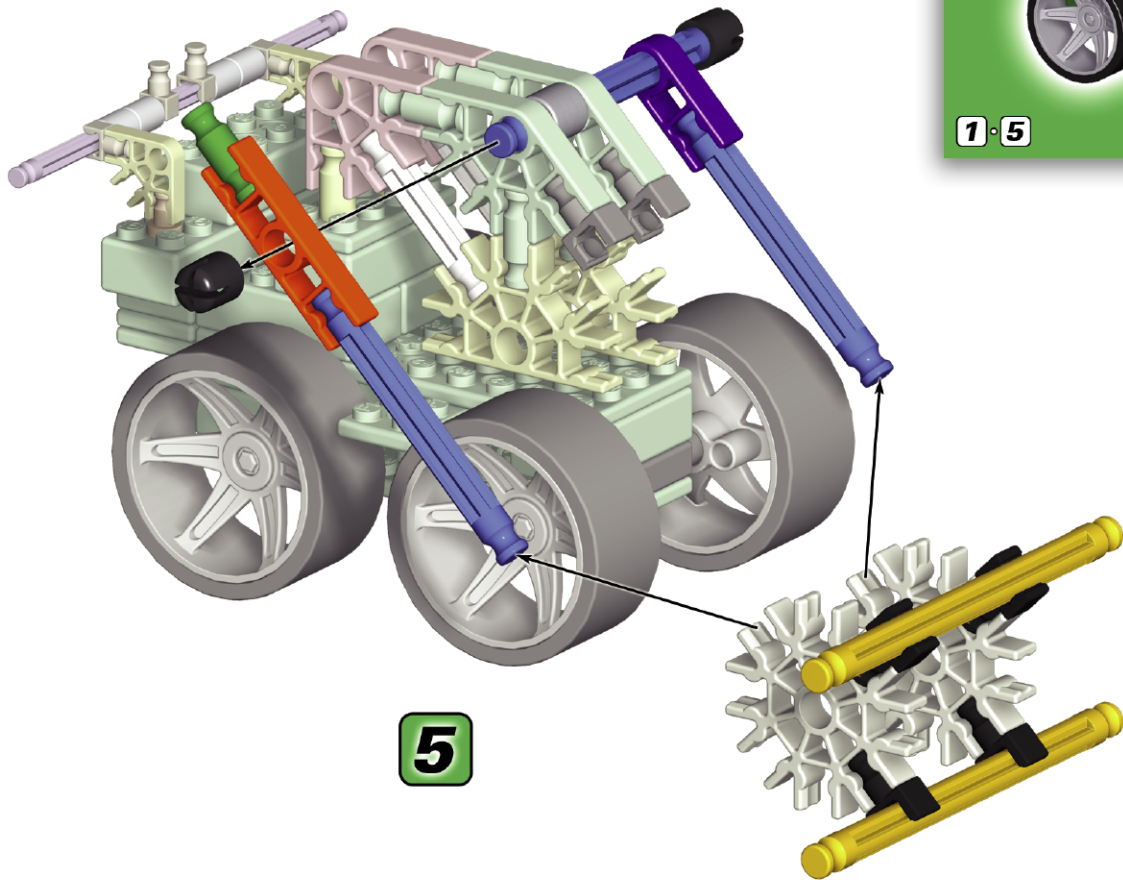

1 · 5



FLOW

Want full instructions for these models?
No problem! Go to www.knex.com/casesets
and enter code number **61007**

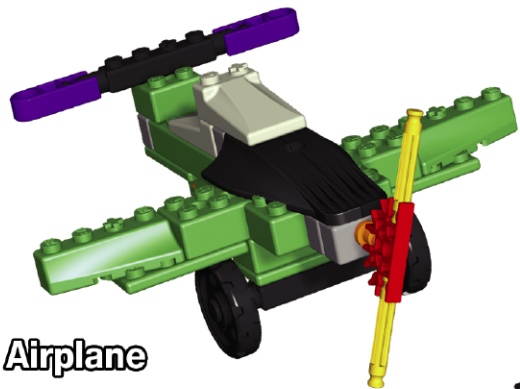

Airplane

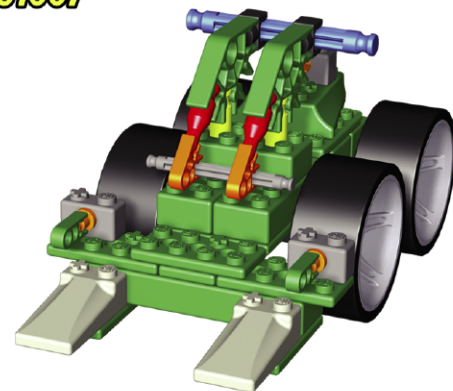

Forklift

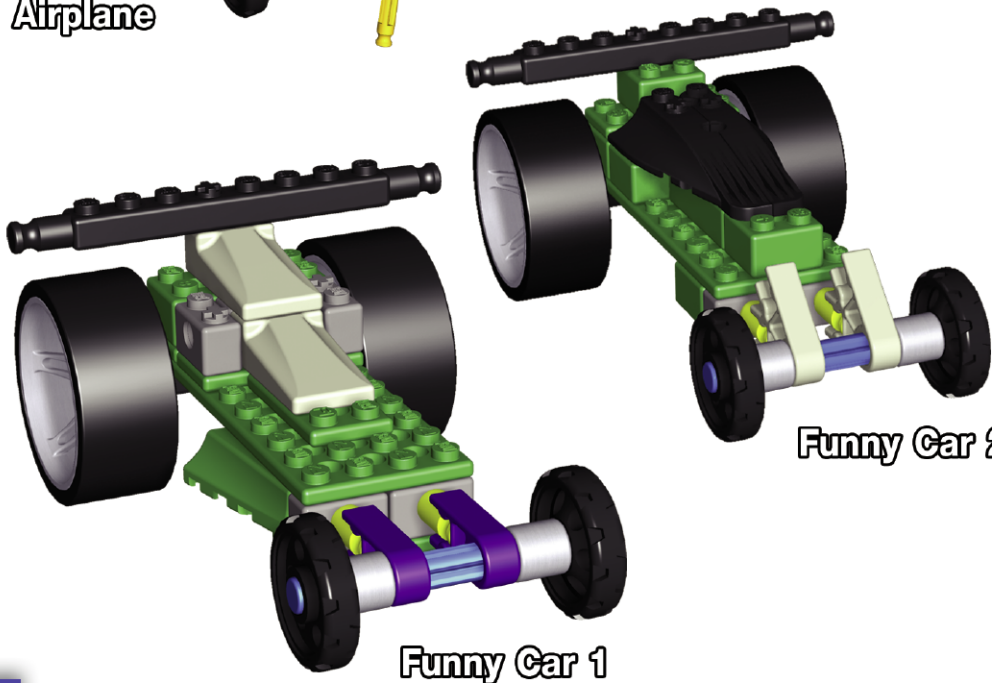

Funny Car 1

Funny Car 2

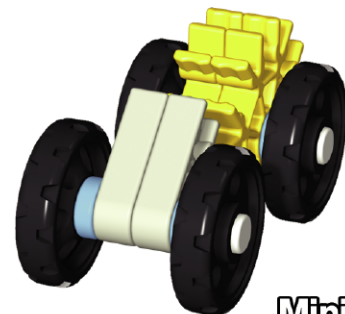

Mini Car

D 1. Los geht's mit dem Bauen:

Jedes Teil hat eine bestimmte Farbe und Form. Schau dir das Bild an und suche nach Teilen, die zueinander passen. Füge diese Teile dann zusammen. Versuche, dein Modell in der gleichen Richtung zu halten, wie in dem Bild, damit du die Teile an der richtigen Stelle zusammenfügst.

2. Nächster Schritt:

Die Abschnitte mit blassen Farben hast du schon fertig gebaut. Die nächsten Teile gehören dort hin, wo die Pfeile hinzeigen. Für manche Befestigungspunkte gibt es keinen separaten Pfeil.

3. Abstandsstücke:

Abstandsstücke haben unterschiedliche Farben. Achte darauf, die richtige Farbe, Größe und Anzahl von Abstandsstücken zu verwenden.

E 1. Commence la construction :

Chaque élément a ses propres couleur et forme. Regarde l'illustration, trouve les éléments qui vont ensemble et assemble-les. Essaie de tenir ton modèle dans le même sens que sur l'illustration de façon à fixer la pièce à l'endroit qu'il faut.

2. Étape suivante :

Les couleurs délavées représentent les sections que tu as déjà assemblées. Tu devras connecter les éléments suivants à l'endroit où pointent les flèches. Il n'y a pas de flèche pour chaque point de connection.

3. Espaceurs :

Il y a des espaceurs de différentes couleurs. Veille à utiliser la couleur, la dimension et le nombre d'espaceurs qu'il faut.

I 1. Comincia a costruire:

Ogni parte ha il suo colore e la sua forma. Guarda la figura, trova le parti che corrispondono e mettile insieme. Cerca di tenere il tuo modello nella stessa direzione della figura così attaccherai il pezzo al posto giusto.

2. Il prossimo passo:

I colori sbiaditi sono le sezioni che hai già costruito. Quello che vorrai fare è connettere le prossime parti nel posto verso il quale sono rivolte le frecce. Non c'è una freccia per ogni punto di connessione.

3. Distanziatori:

Ci sono distanziatori di colore diverso. Assicurati di star usando il colore, la misura e il numero di distanziatori giusti.

E 1. Empieza a construir:

Cada pieza tiene su propio color y forma. Observa el dibujo, encuentra las piezas que combinan y ponlas juntas. Trata de mantener tu modelo en la misma dirección en que se muestra en el dibujo. Así podrás conectar la pieza en el correcto lugar.

2. Paso siguiente:

Las partes descoloridas son las secciones que ya has construido. Querrás conectar las piezas que siguen en el lugar hacia el cual las flechas están apuntando. No hay una flecha para cada punto de conexión.

3. Espaciadores:

Encontrarás espaciadores de diferentes colores. Asegúrate de que usas la correcta cantidad de espaciadores, y que el color y la medida de los espaciadores también sean correctos.

P 1. Inicia a construção:

Cada peça tem a sua própria cor e configuração. Observa a ilustração, procura as peças que correspondem e coloca-as todas juntas. Tenta manter o teu modelo na mesma direcção mostrada na ilustração para encaixares a peça no local correcto.

2. Passo seguinte:

As cores desbotadas pertencem às secções que já construístes. Necessitarás de unir as peças seguintes no local apontado pelas setas. Não existe uma seta para cada ponto de conexão.

3. Espaçadores:

Existem espaçadores de cores diferentes. Certifica-te de que usas a cor, tamanho e número de espaçadores exactos.

NL 1. Begin te bouwen:

Elk onderdeel heeft zijn eigen kleur en vorm. Kijk naar de afbeelding, vind de overeenstemmende onderdelen en voeg ze aan mekaar. Tracht het model in dezelfde richting te houden als de afbeelding; zo zul je het stuk op de correcte plaats vastmaken.

2. Volgende stap:

De vage kleuren zijn delen die reeds werden opgebouwd. De volgende onderdelen zullen moeten gekoppeld worden op de plaats aangeduid door de pijlen. Er is geen pijl voor elk koppelpunt.

3. Spatiestukken:

Er zijn verschillende gekleurde spatiestukken. Verzeker je ervan om de juiste kleur, grootte en aantal spatiestukken te gebruiken.

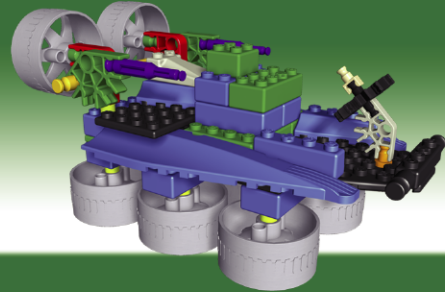

Visit www.knex.com/casesets and click on **combo builds** for instructions.

Sold separately.
Vendus séparément.
Se venden por separado.
Separat erhältlich.
Venduti separatamente.
Afzonderlijk verkocht.
Säljes separat.
Selges separat.
Myydään erikseen.



Questions? Call 1-800-KID-KNEX (U.S.A./Canada only) or 00800-22427276 (UK/Ireland only)

Write to email@knex.com or visit www.knex.com For Customer Service outside the USA, CAN, GBR please contact local distributor. Distributor information can be found at: <http://www.knex.com/distributors> Le Service clients hors d'USA et CAN, s'il vous plaît contacter le distributeur local. L'information de distributeur peut être trouvée à <http://www.knex.com/distributors>

Standard K'NEX parts made in the U.S.A. Special components made in China. Product & colors may vary. K'NEX and Imagine, Build, Play are a registered trademarks of K'NEX Limited Partnership Group

93017/407054.11-V5-08/08

Pièce K'NEX courantes fabriqués aux États-Unis. Éléments spéciaux fabriqués en Chine. Fabriqués aux États-Unis. K'NEX hechas en EE.UU. Produits et couleurs peuvent varier. K'NEX est une marque déposée de K'NEX Limited Partnership Group. Componentes especiales hechos en China. Hecho en los EE.UU. El producto y los colores pueden variar. K'NEX es una marca registrada de K'NEX Limited Partnership Group. Manufactured under U.S. Patents/Fabriqués sous brevets américains/Fabricado bajo patentes de EE.UU. 5,061,219; 5,199,919; 5,350,331, D412,020. Other U.S. and foreign patents pending. Autres brevets américains et étrangers en instance. Otras patentes de EE.UU. y países extranjeros pendientes. Conforme to ASTM F963-07. Conforme aux ASTM F963-07. Cumples con F963-07 de la ASTM. Community Design No. 000 645338-001-0002.

- Identifies Genuine K'NEX Bricks.
- Identifie que ce sont d'authentiques briques K'NEX.
- Identifica los ladrillos genuinos de K'NEX.
- Identifiziert echte K'NEX-Bausteine.
- Edentifica i veri blocchi K'NEX.
- Identifica que são cubos genuinos da K'NEX.
- Identificeert K'NEX bakstenen voor.
- Anger äkta K'NEX klossar.
- Identifierer ægte K'NEX brikker.
- Identifiserer ekte K'NEX murstein.
- Osoittaa aitoja K'NEX paloja.



©2008 K'NEX Industries, Inc.
P.O. Box 700, Hatfield, PA 19440-0700