

12605



100 MODEL IMAGINE
BUILDING SET

PREHISTORIC CREATURES

Hadrosaurid
page 1



K'NEX Rex
page 6

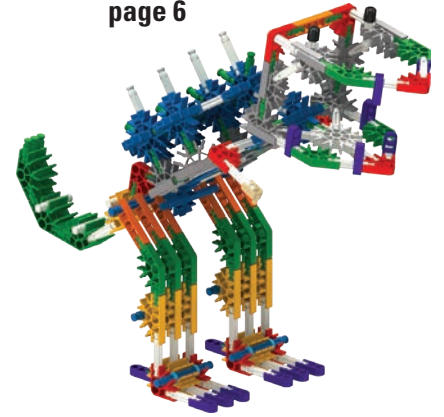

Pterodactyl
page 15

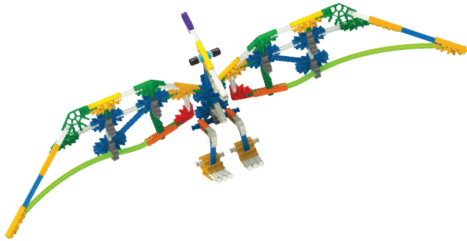

Stegosaurus
page 21

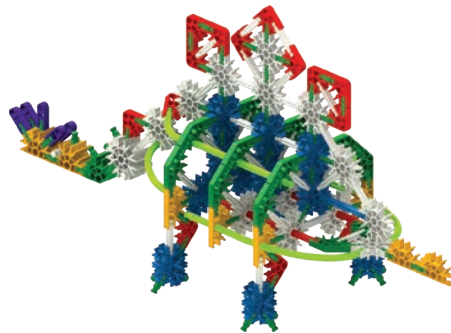

Triceratops
page 30

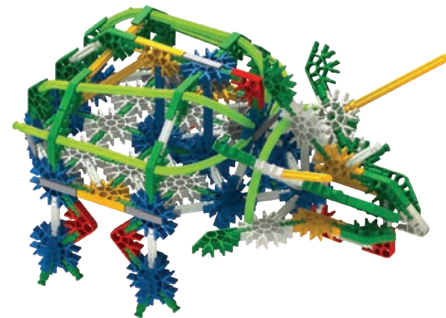

Woolly Mammoth
page 39

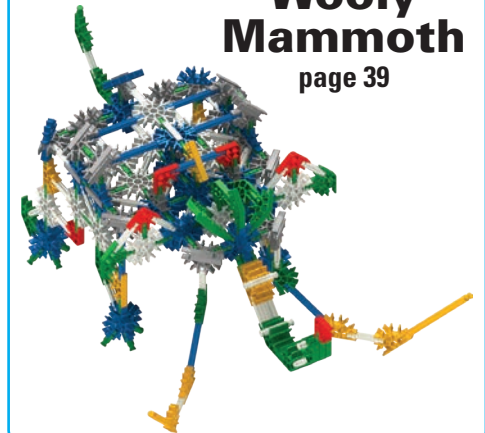

Hadrosaurid



1

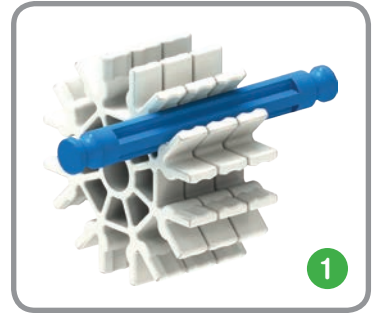
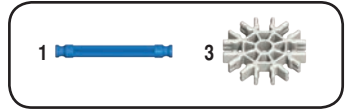
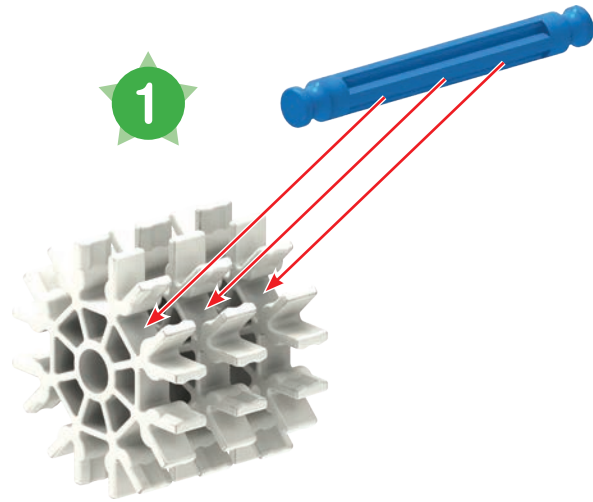

x3

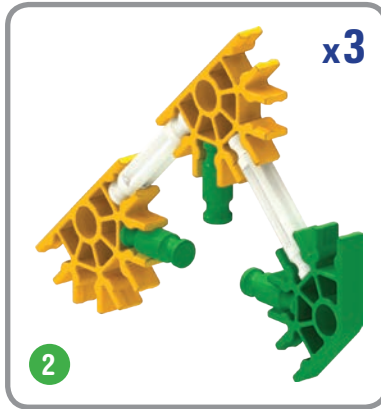
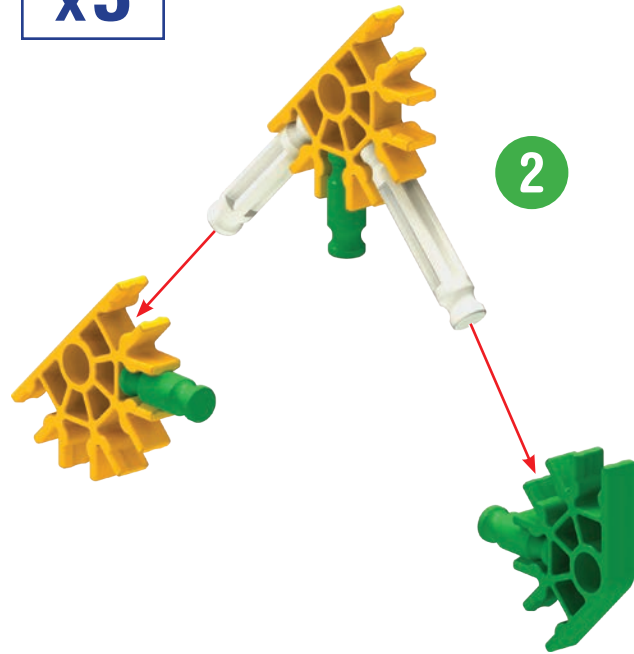

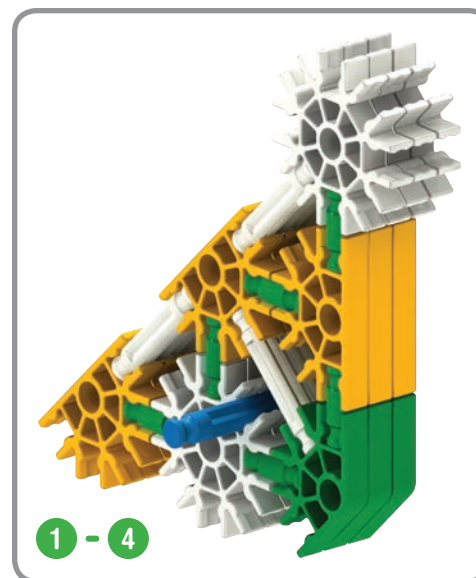
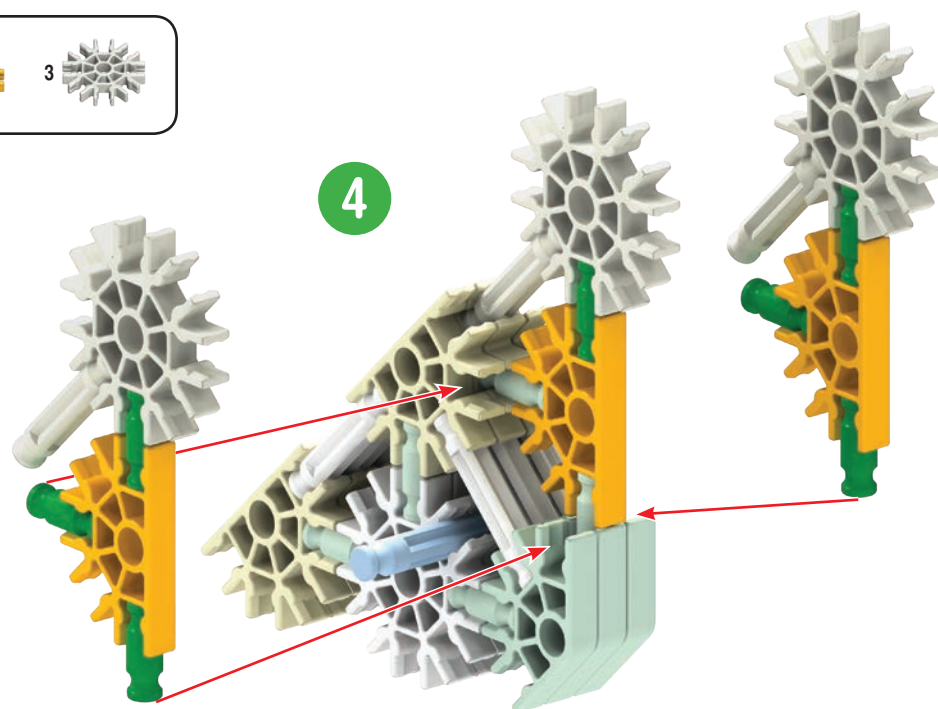
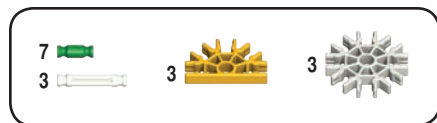
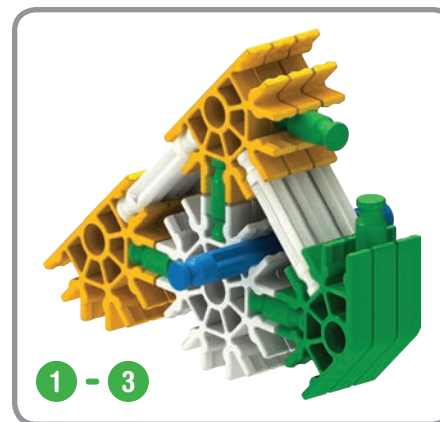
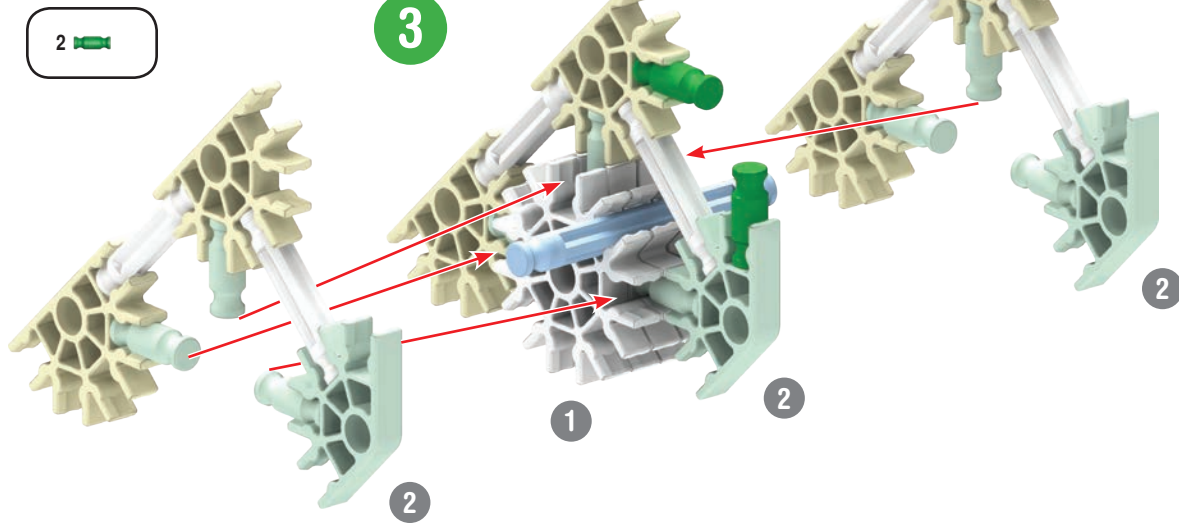

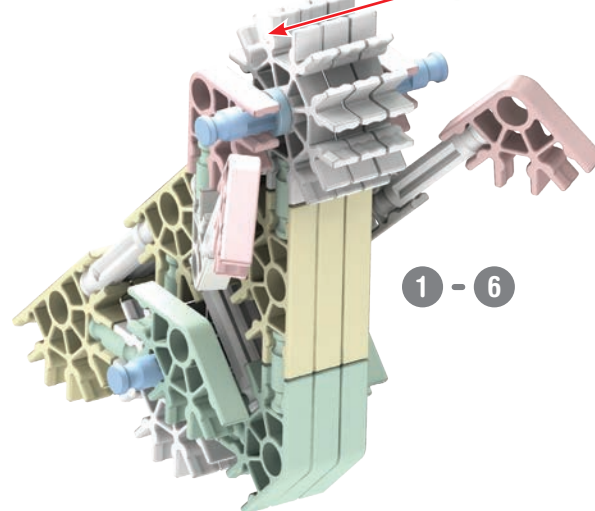
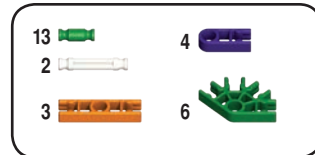
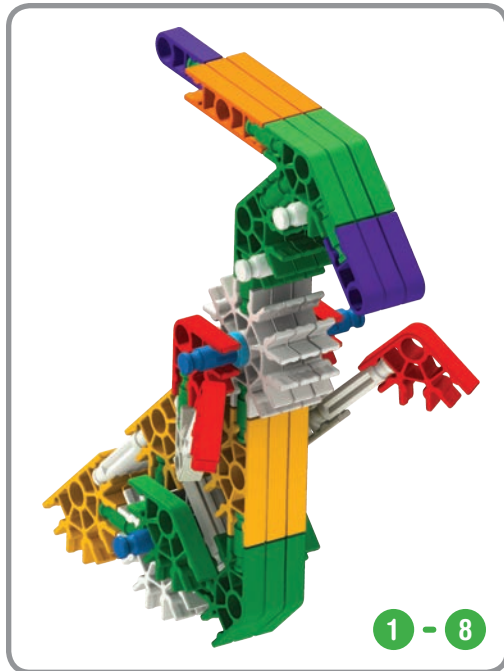
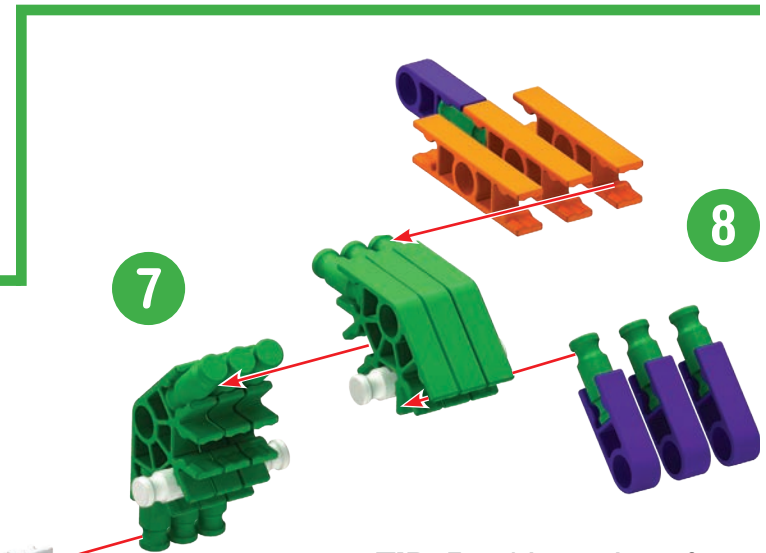
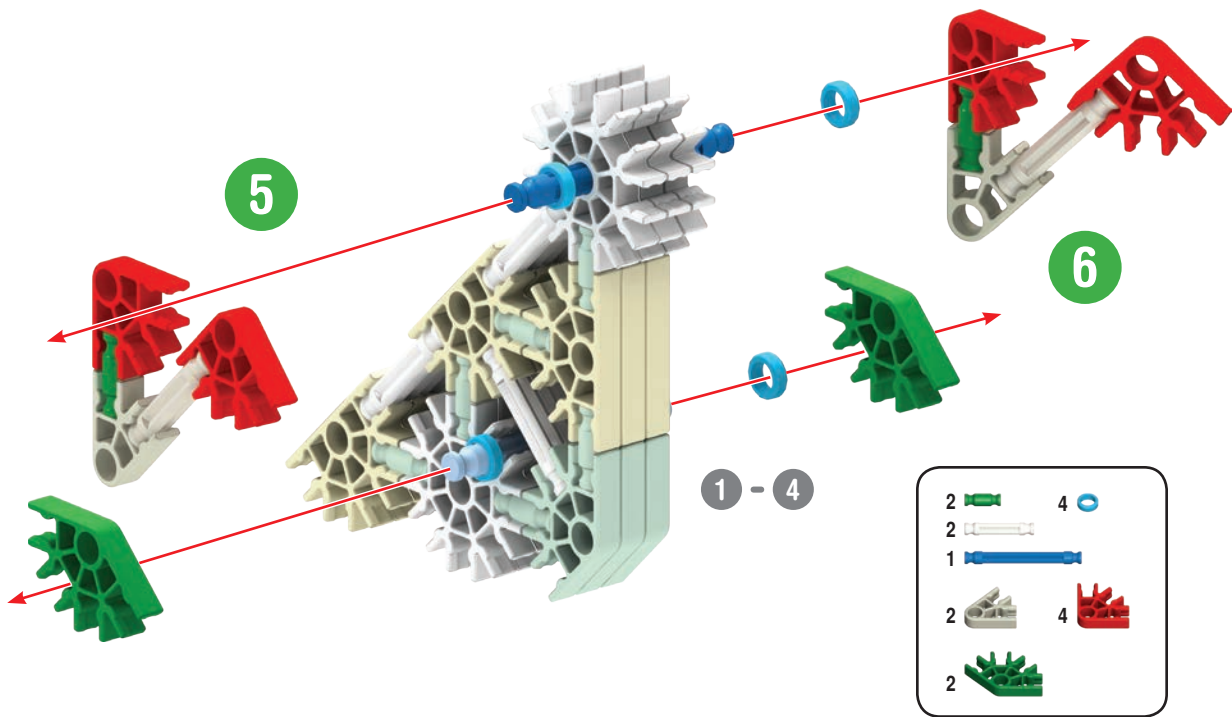

TIP: For this section of the model, it is easier to connect the rods to the connectors by pushing them from the side.

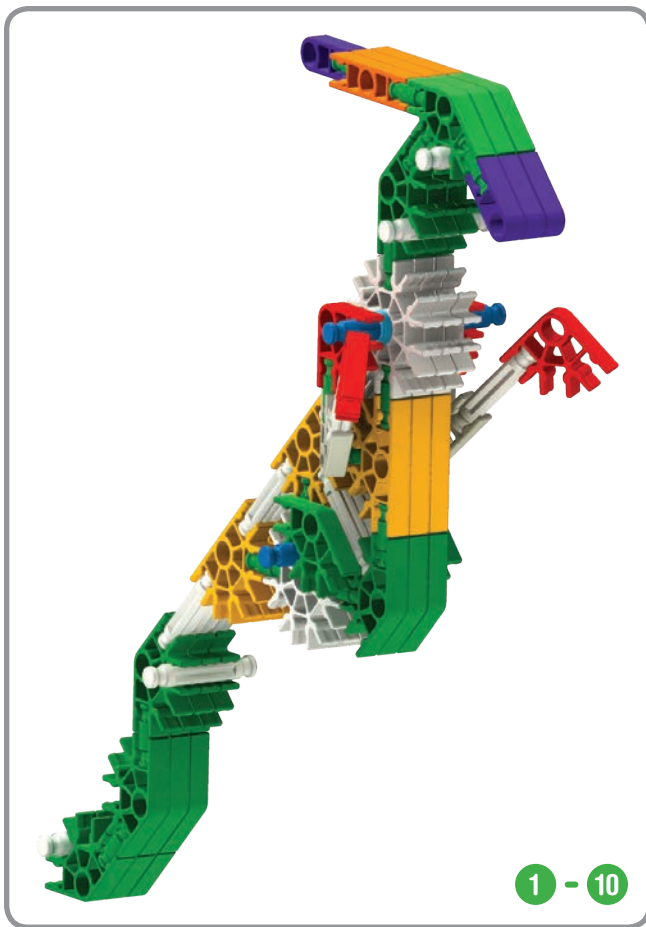

1 - 10

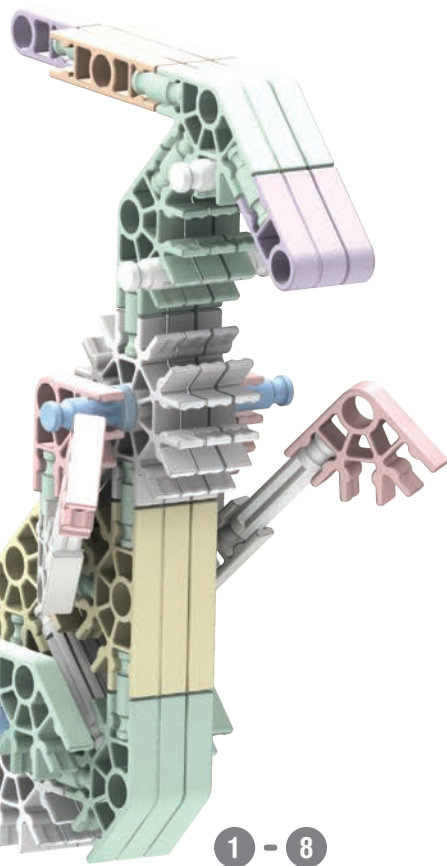

1 - 8

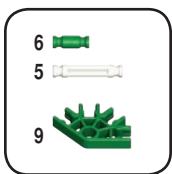

9

10

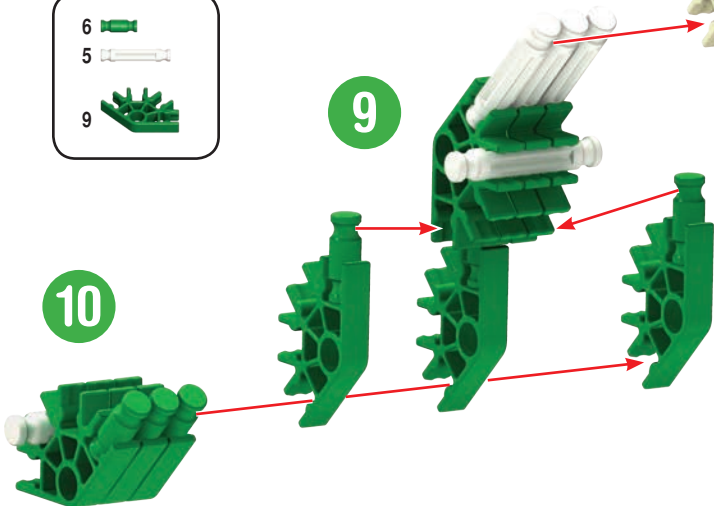

TIP: For this section of the model, it is easier to connect the rods to the connectors by pushing them from the side.

x2

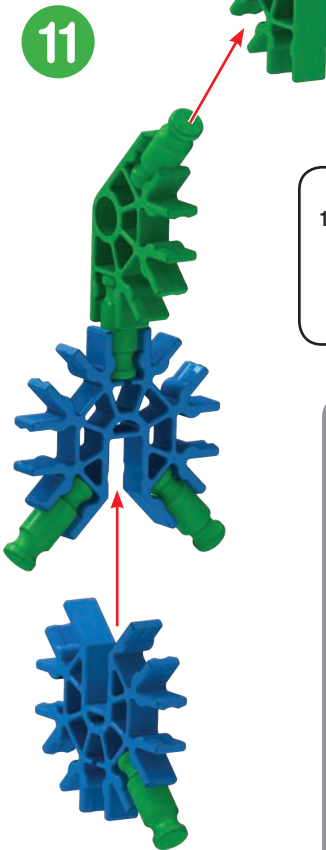

11

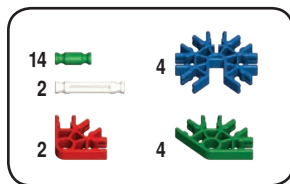

x2

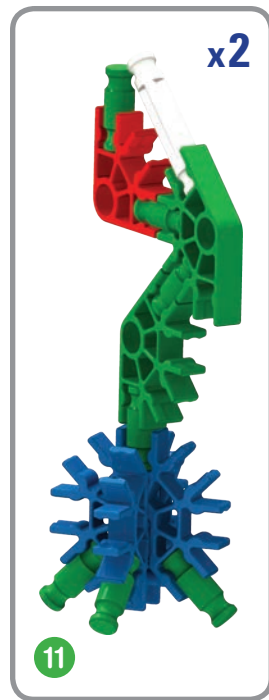

11

Hadrosaurid

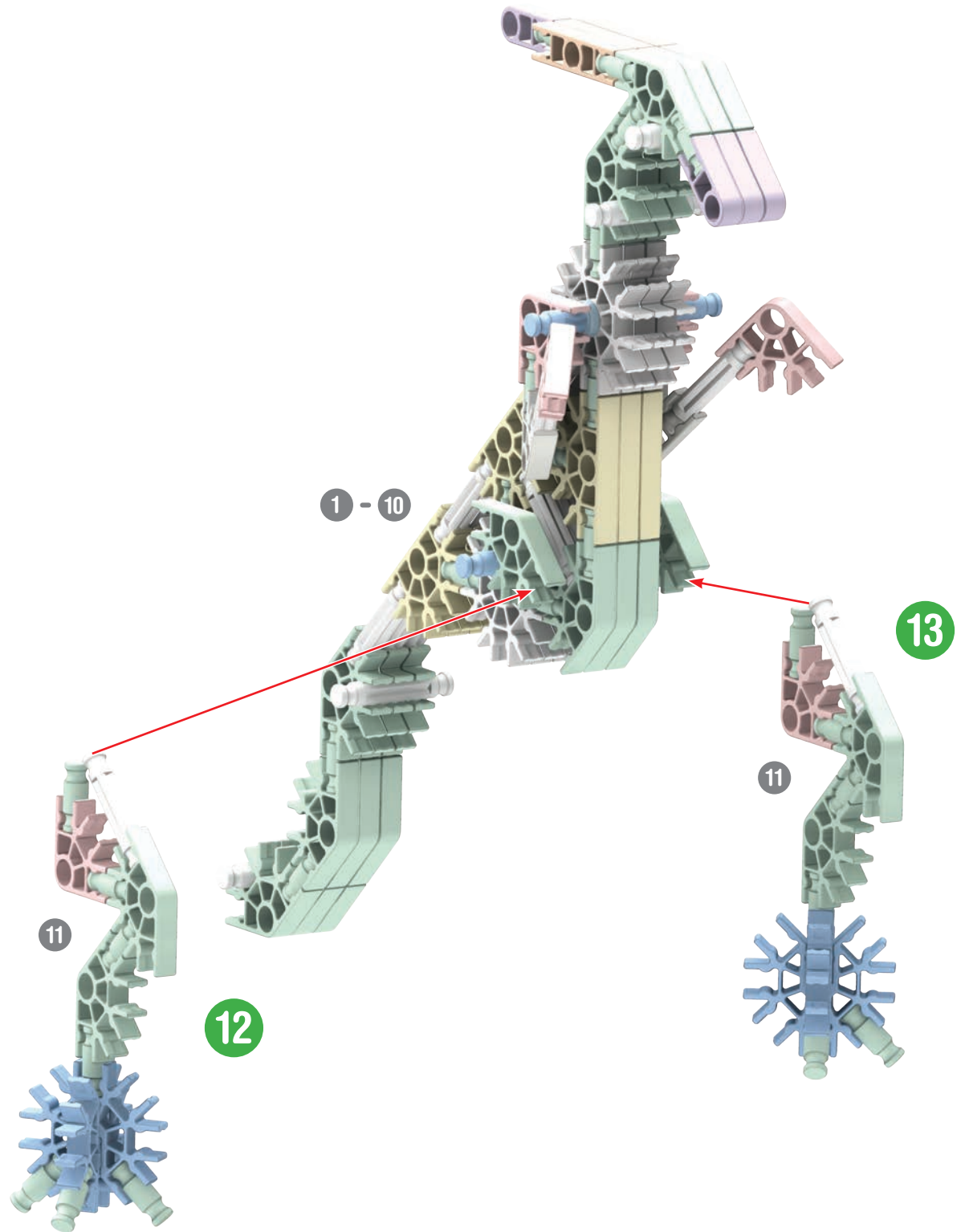

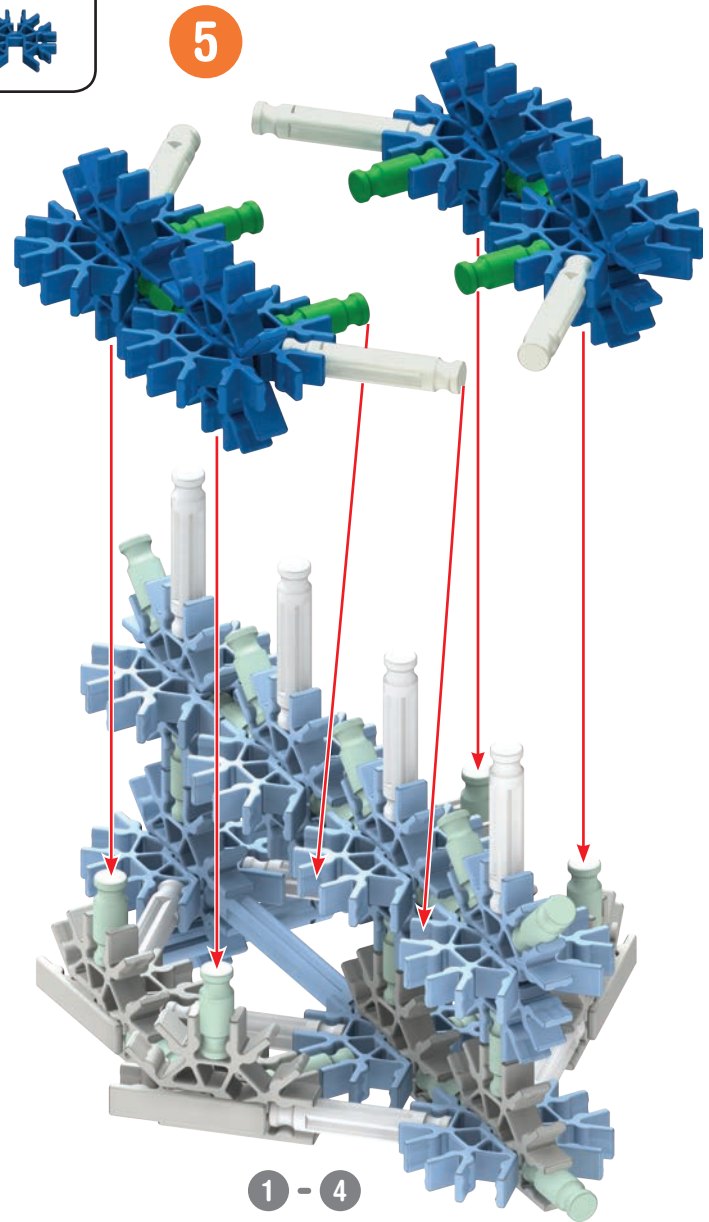
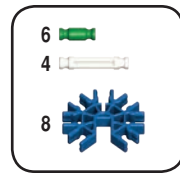
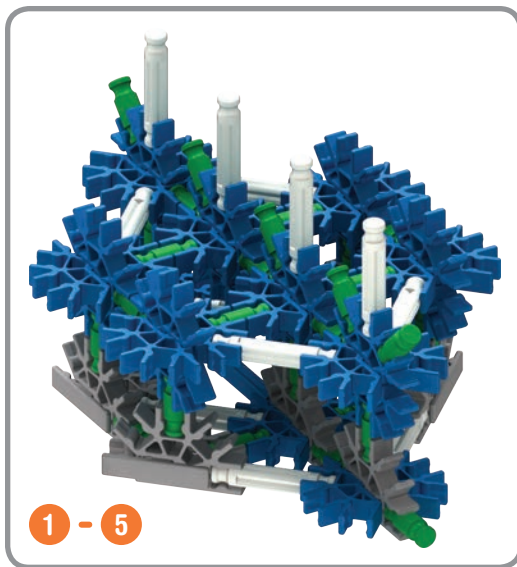
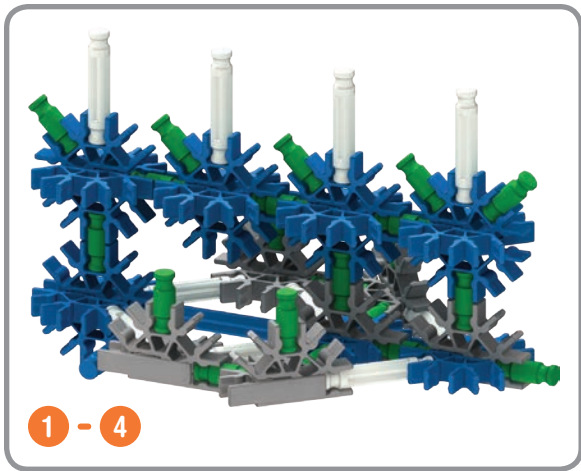
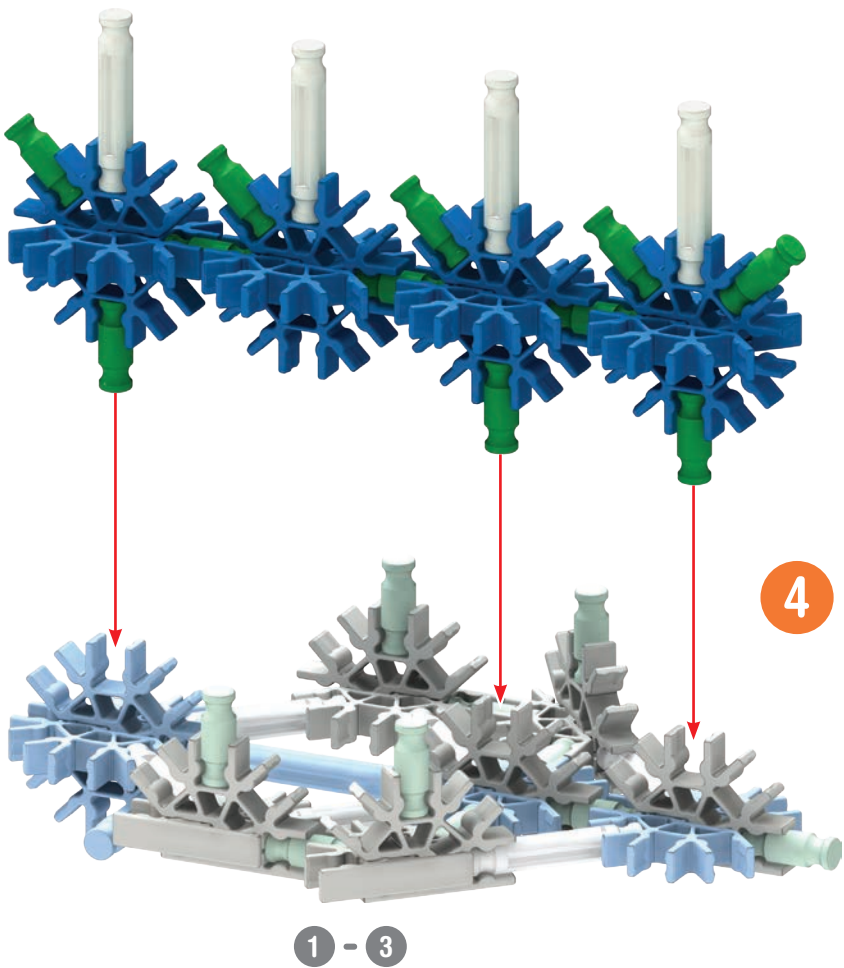

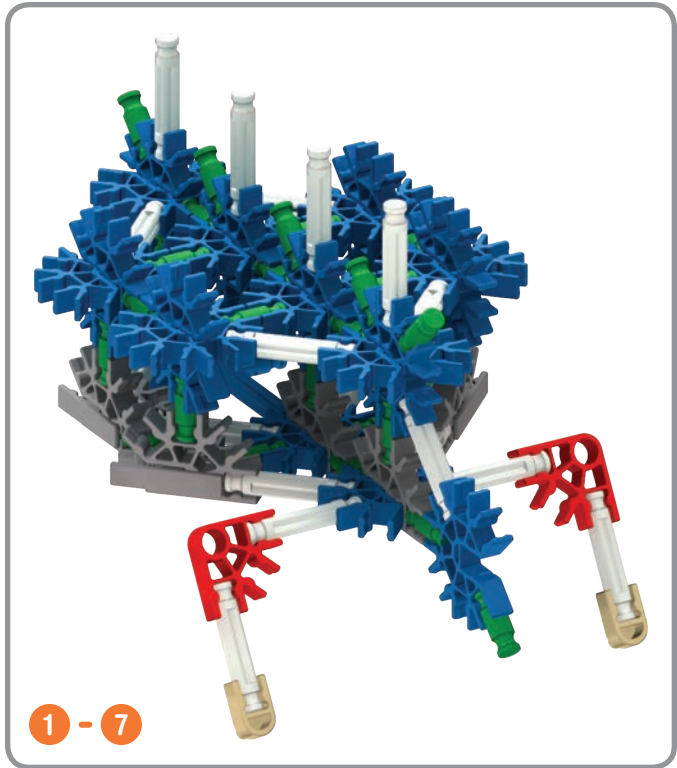
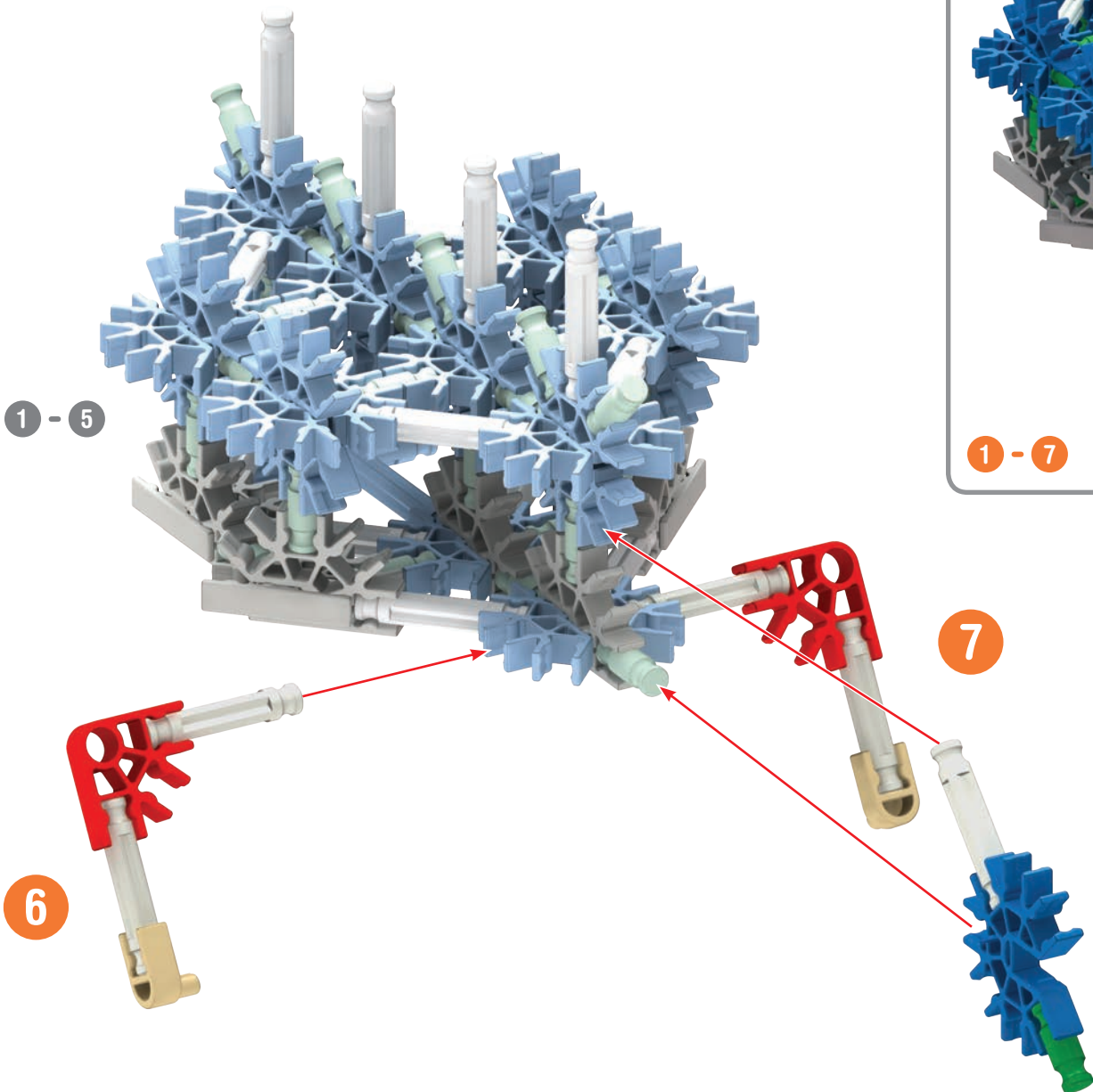

- | | | |
|---|--|---|
| 1 | | |
| 5 | | |
| 2 | | 2 |
| 1 | | |

4		2	
7		1	
4		1	
1		1	
6		1	

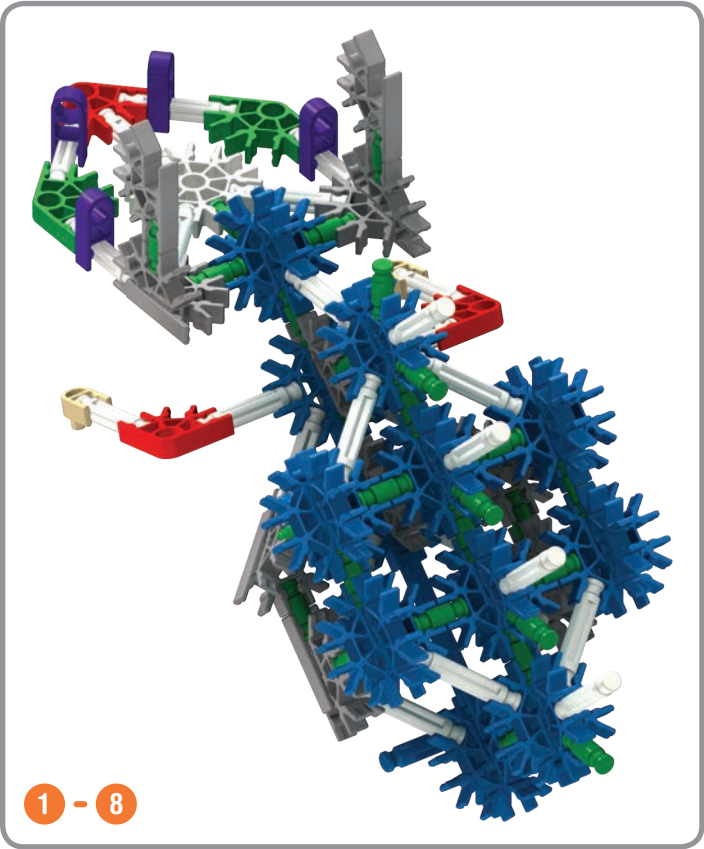
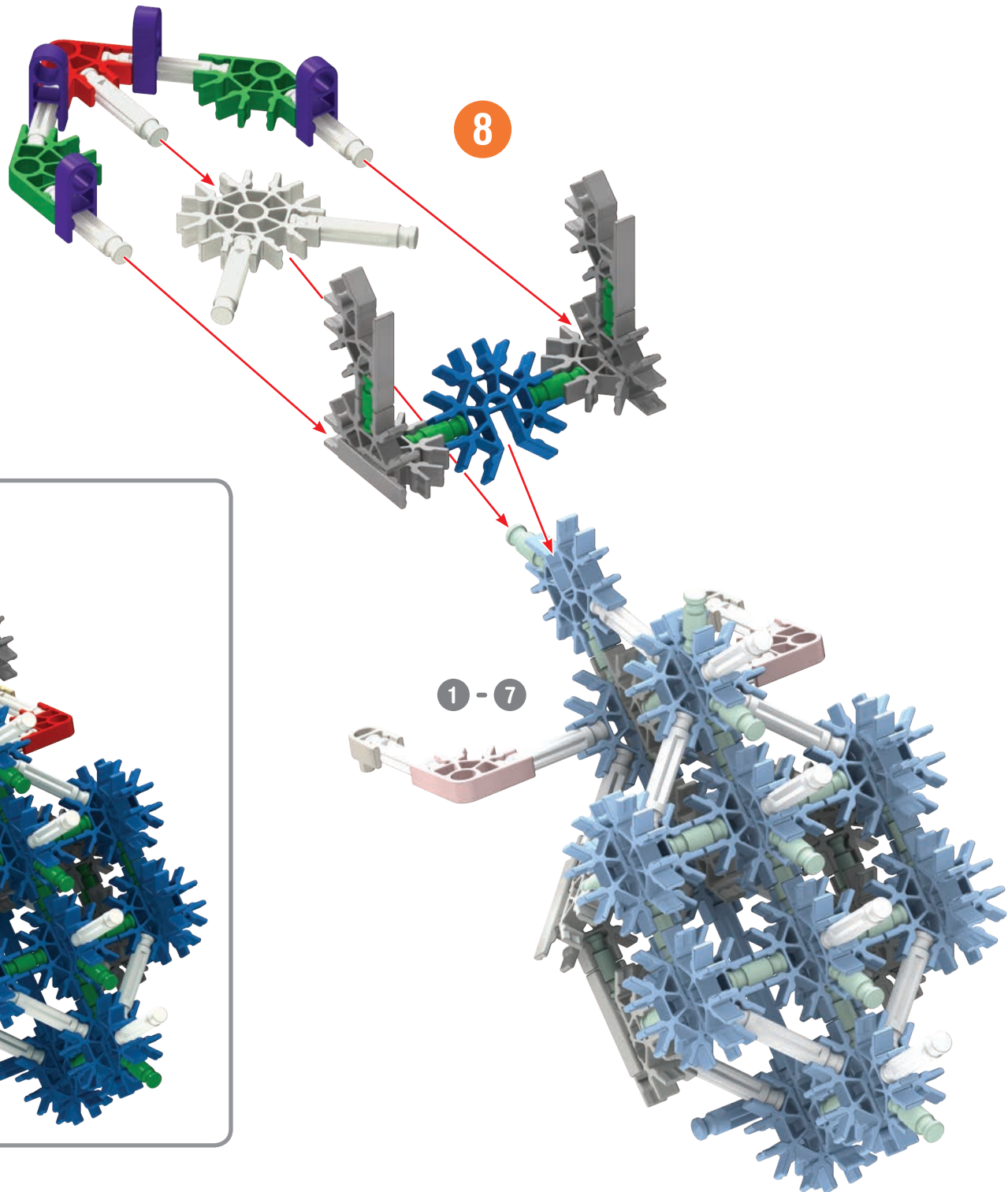

6		2		2		1	
8							
3		2		6			

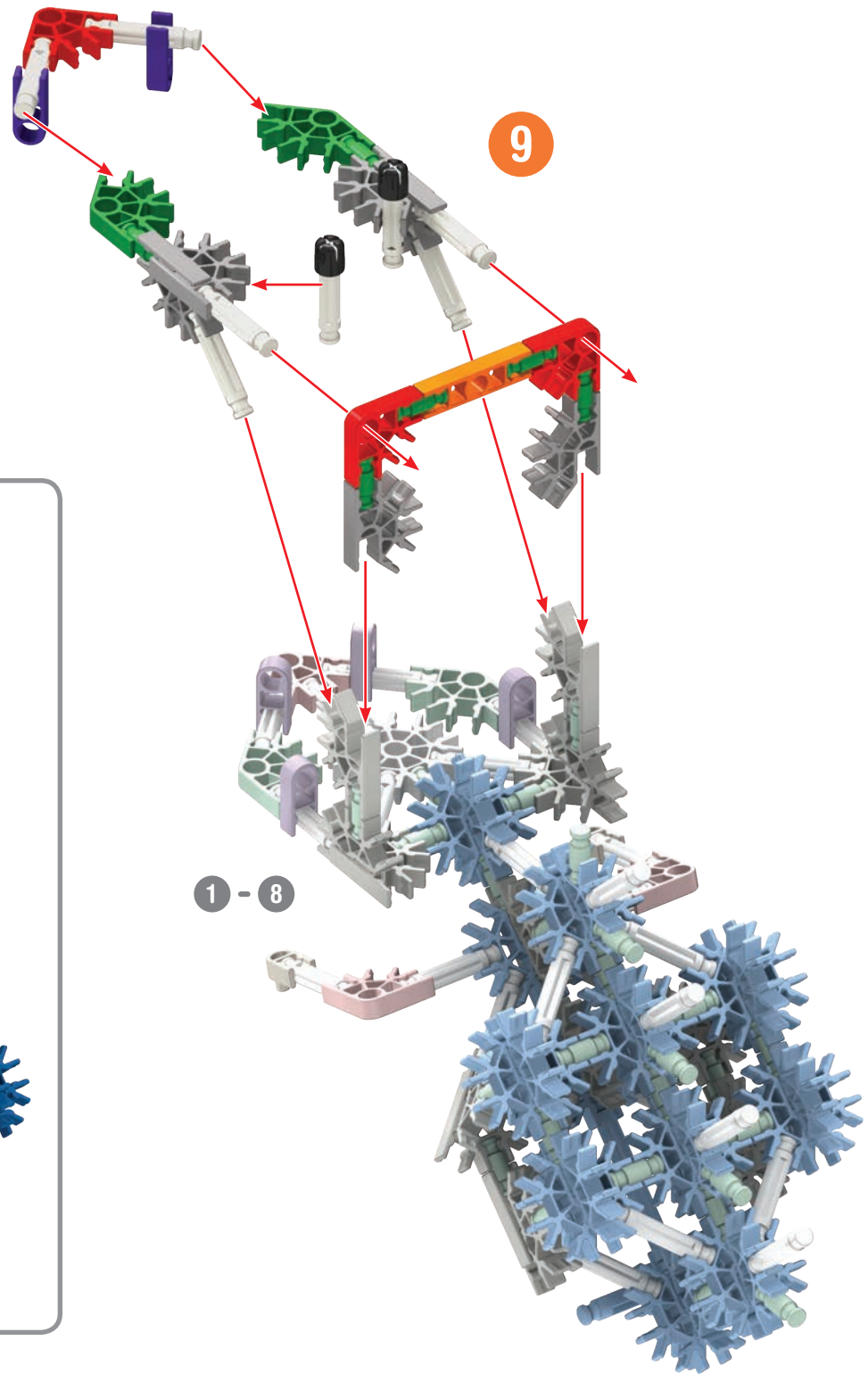
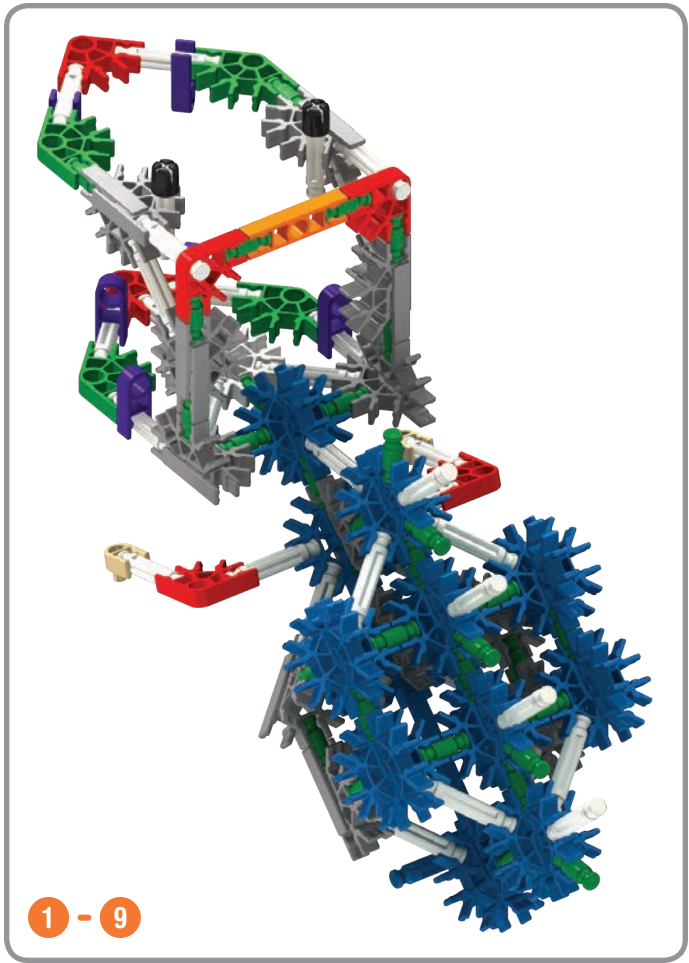

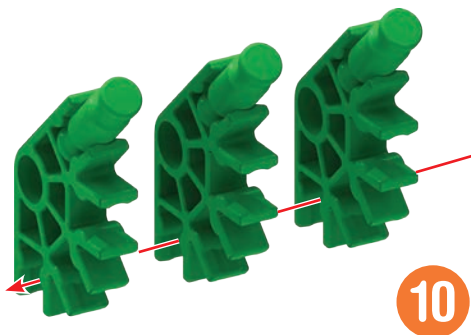

10

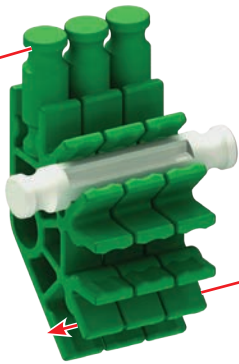

11

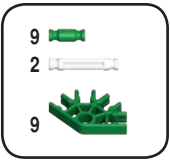

10 - 11

TIP: For this section of the model, it is easier to connect the rods to the connectors by pushing them from the side.

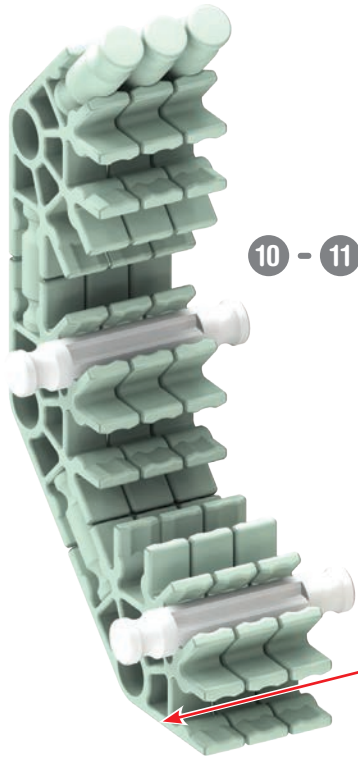

10 - 11



12

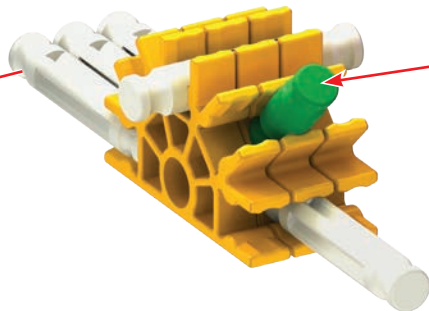

13

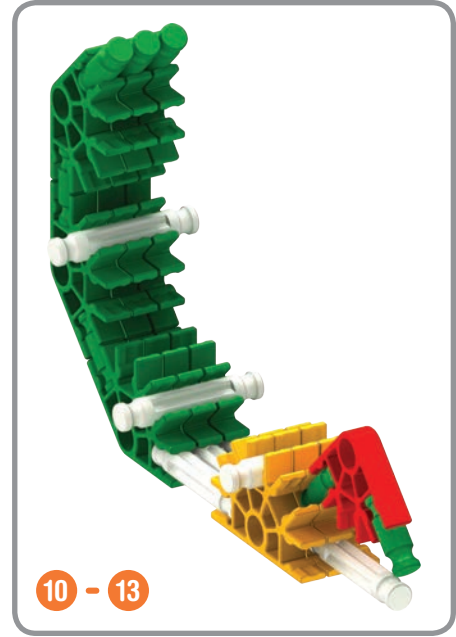
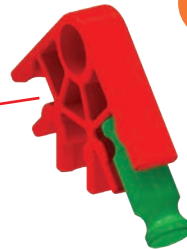

10 - 13

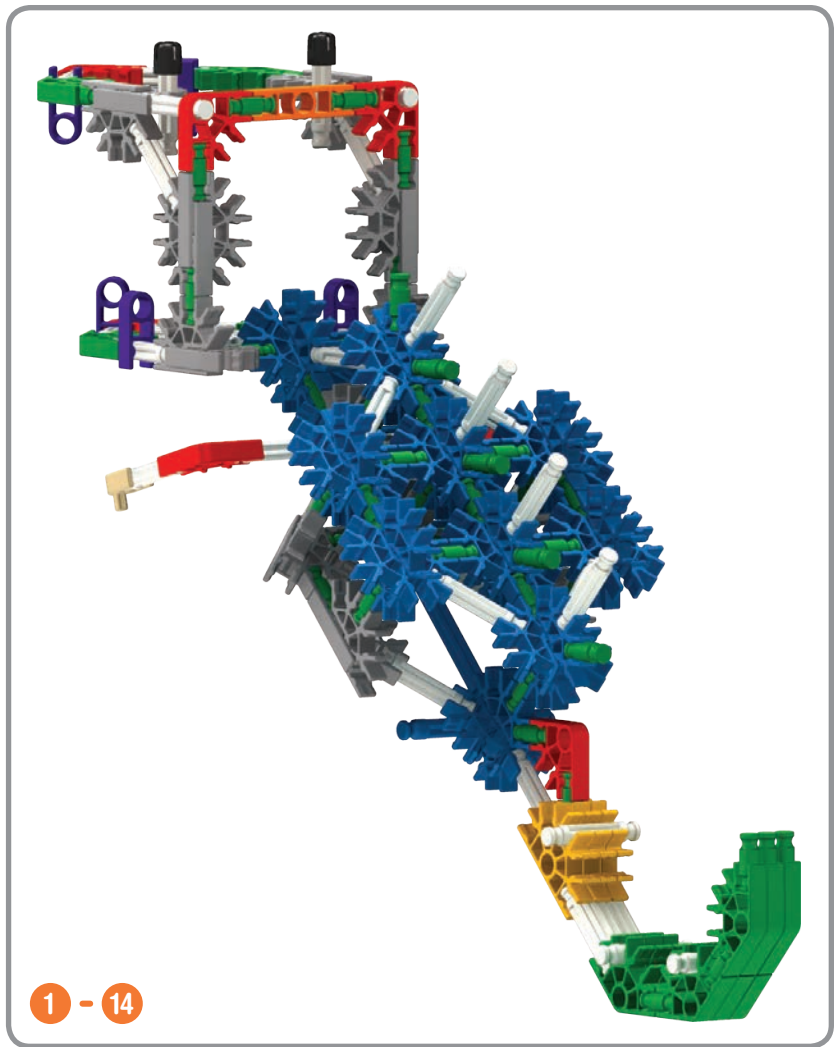
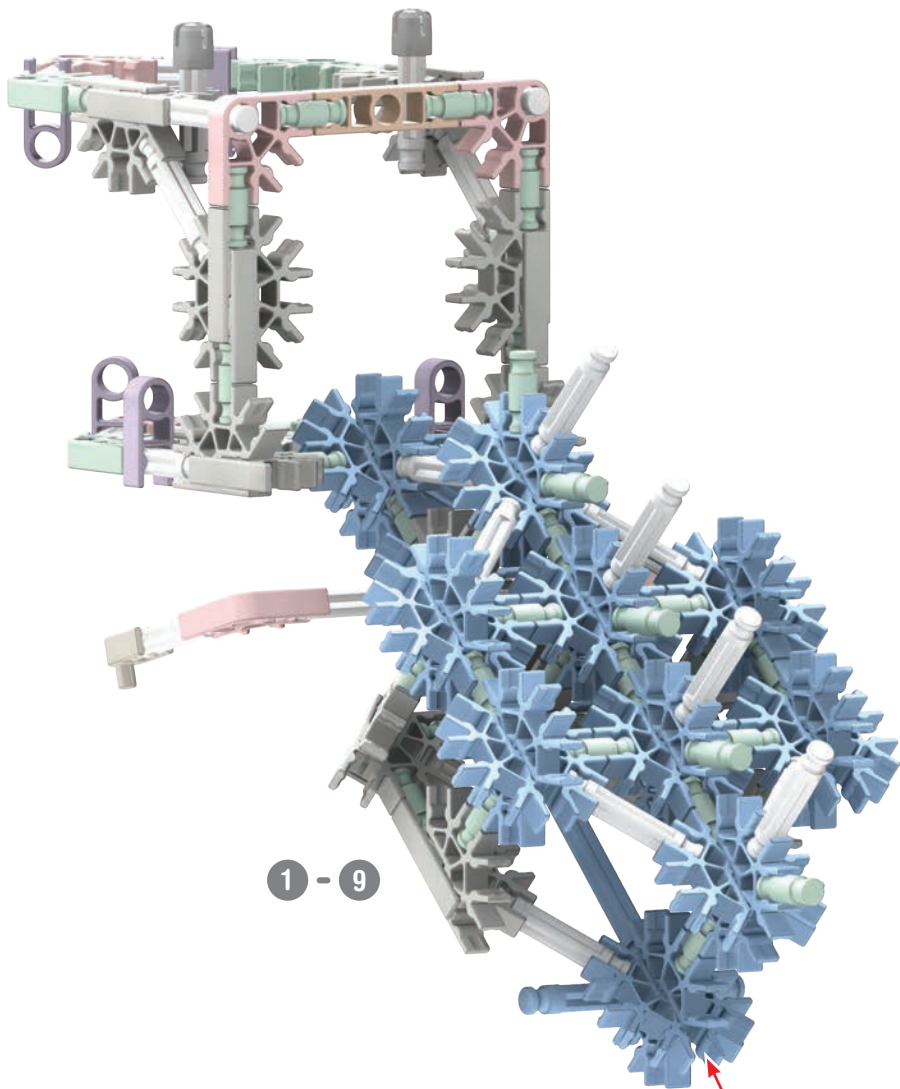

14

10 - 13

x2

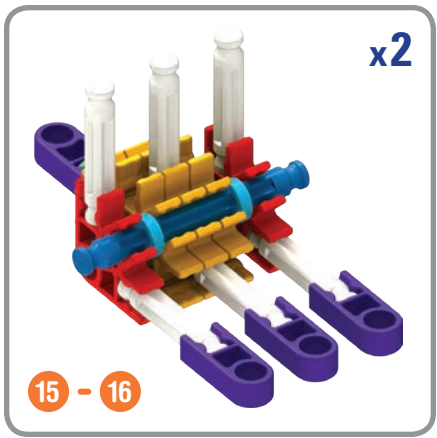
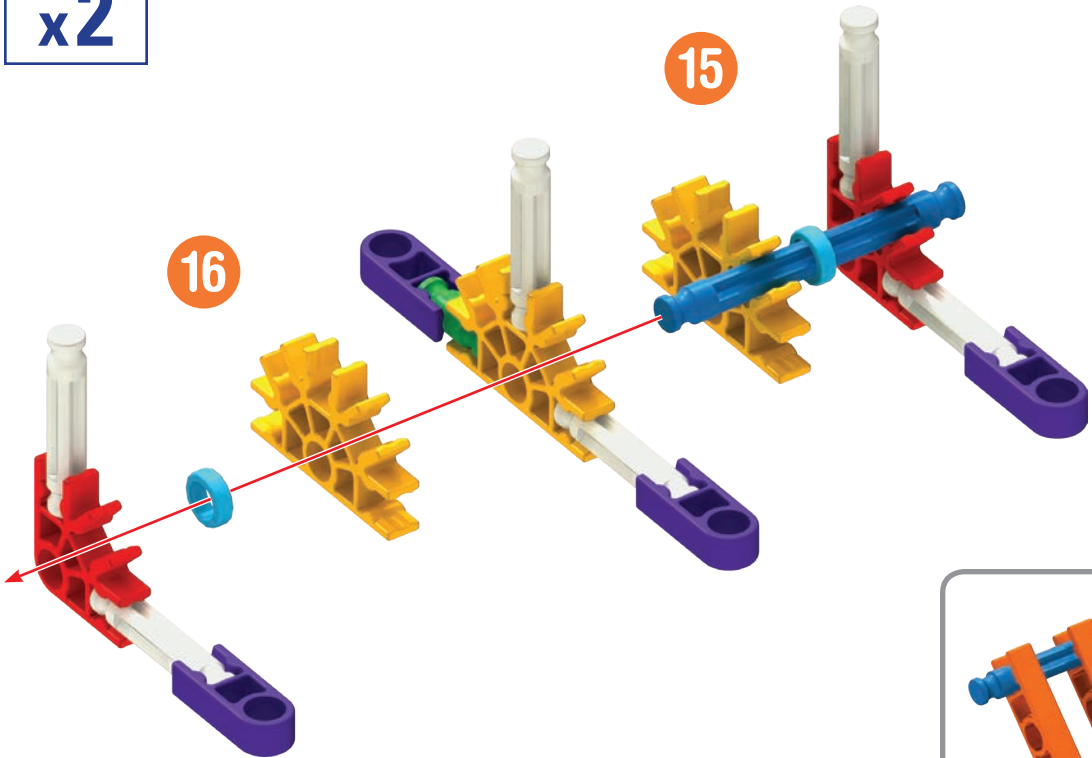

- | | | | |
|----|--|---|--|
| 2 | | 4 | |
| 12 | | 8 | |
| 2 | | 6 | |
| 4 | | | |

x2

- | | | | |
|----|--|---|--|
| 12 | | 6 | |
| 4 | | 6 | |
| 6 | | | |

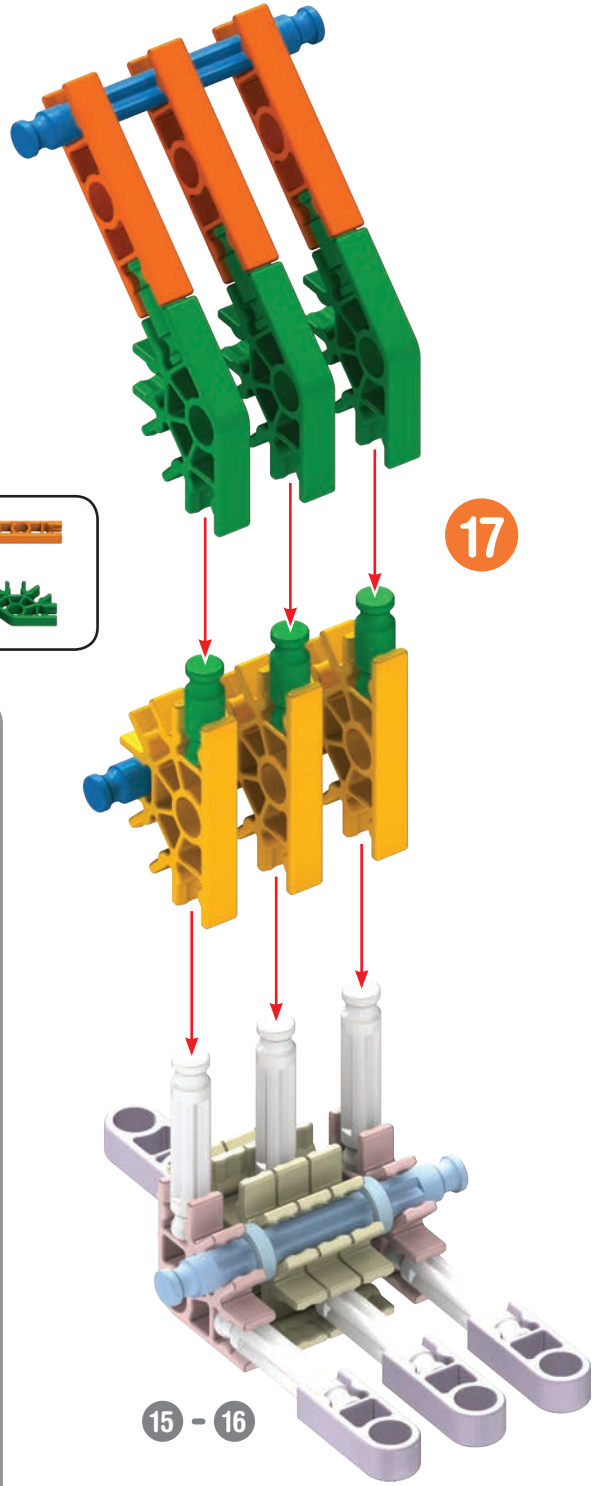
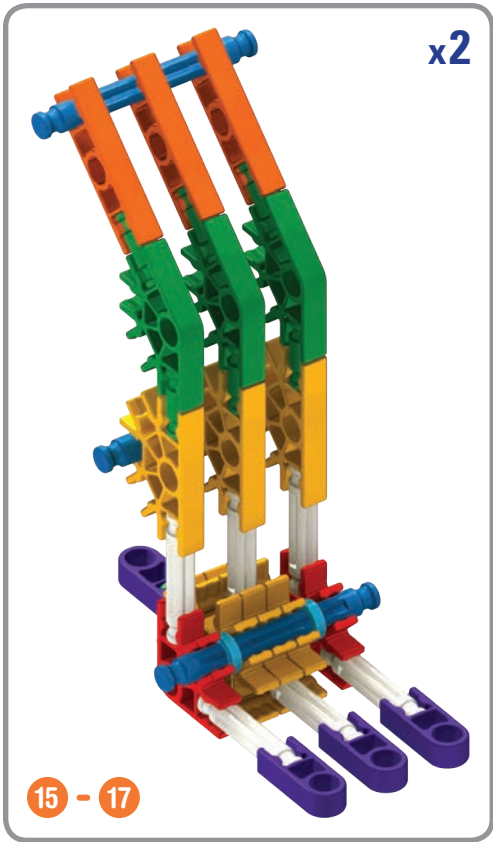

K'NEX Rex

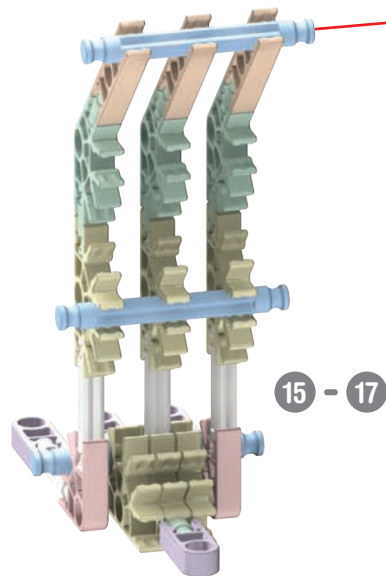
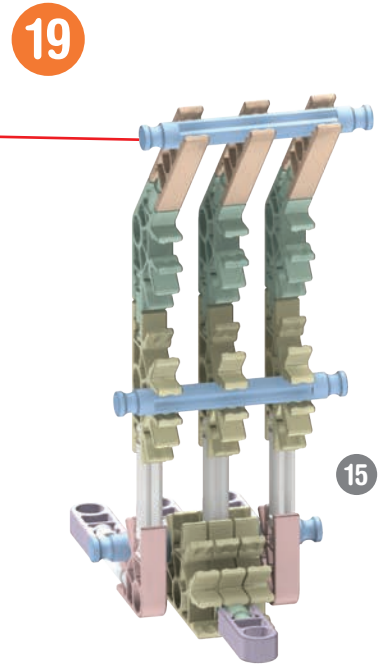
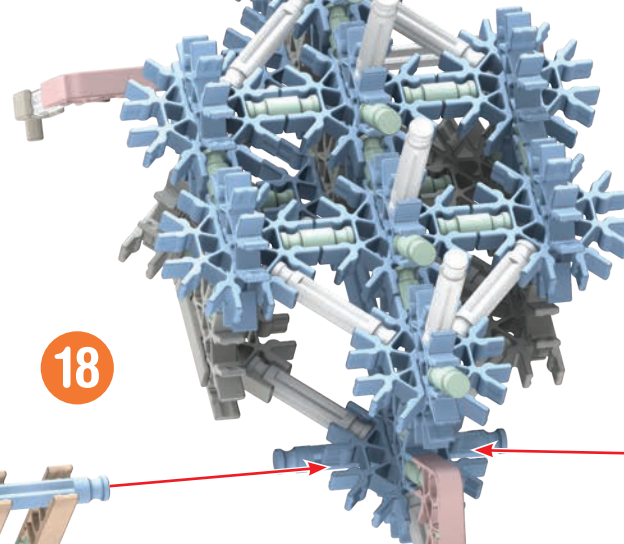
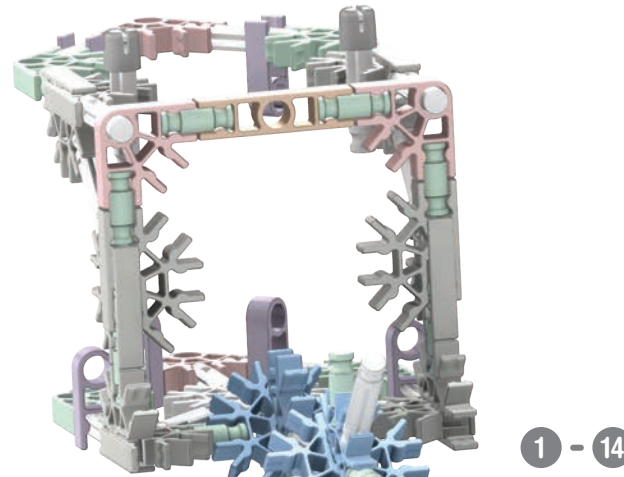
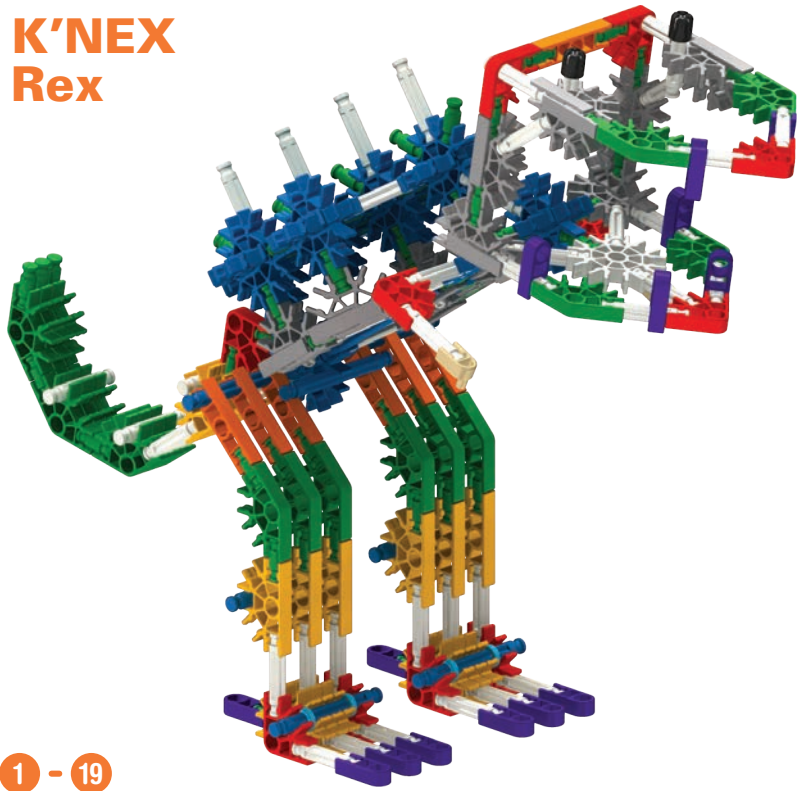

15 - 17

Pterodactyl

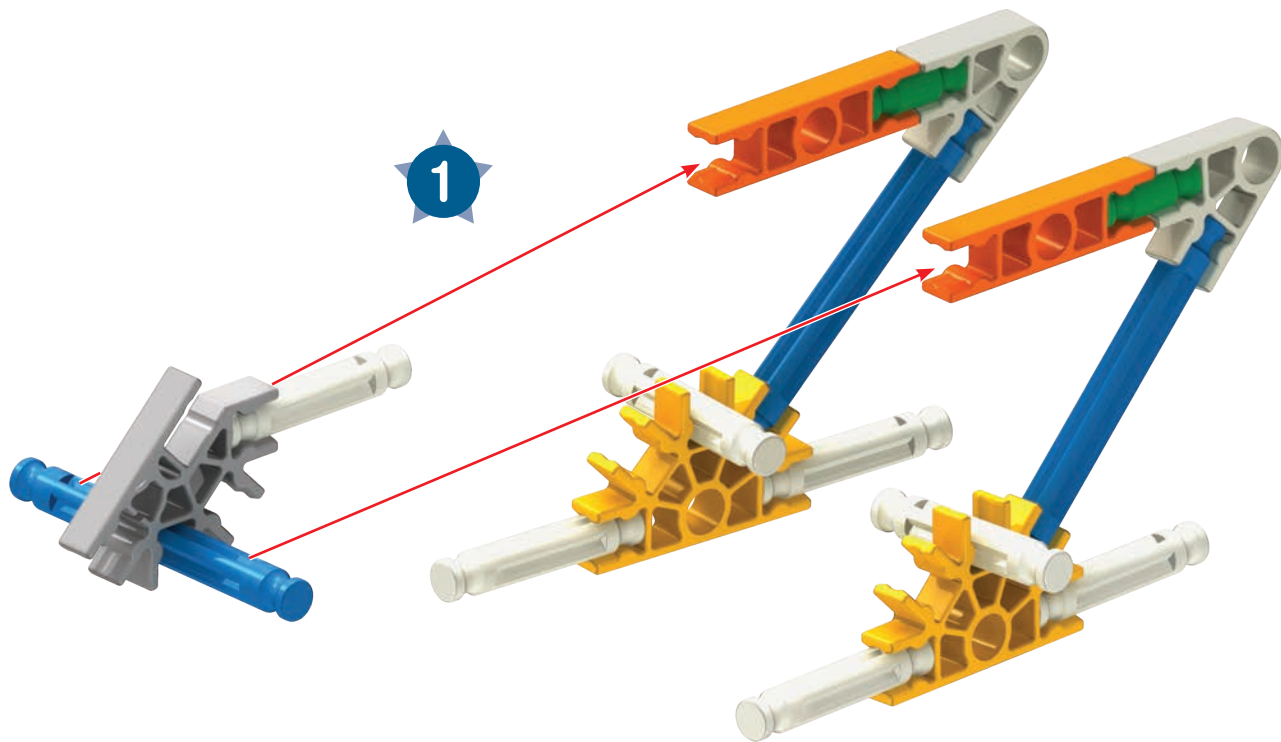
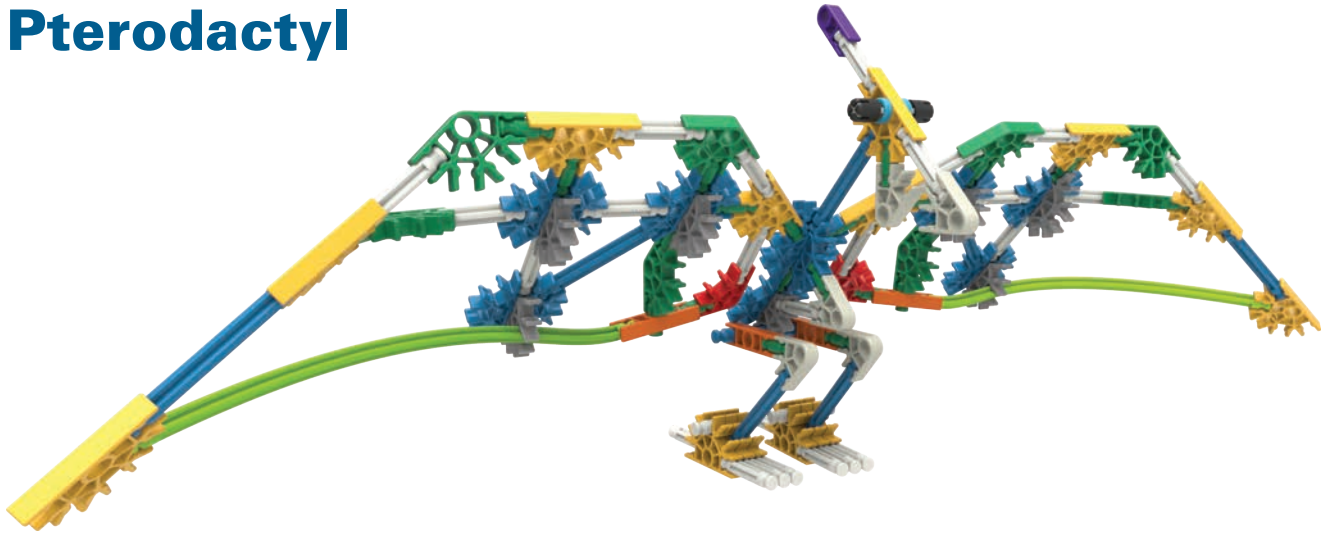

2		2	
7		2	
3		1	
2			



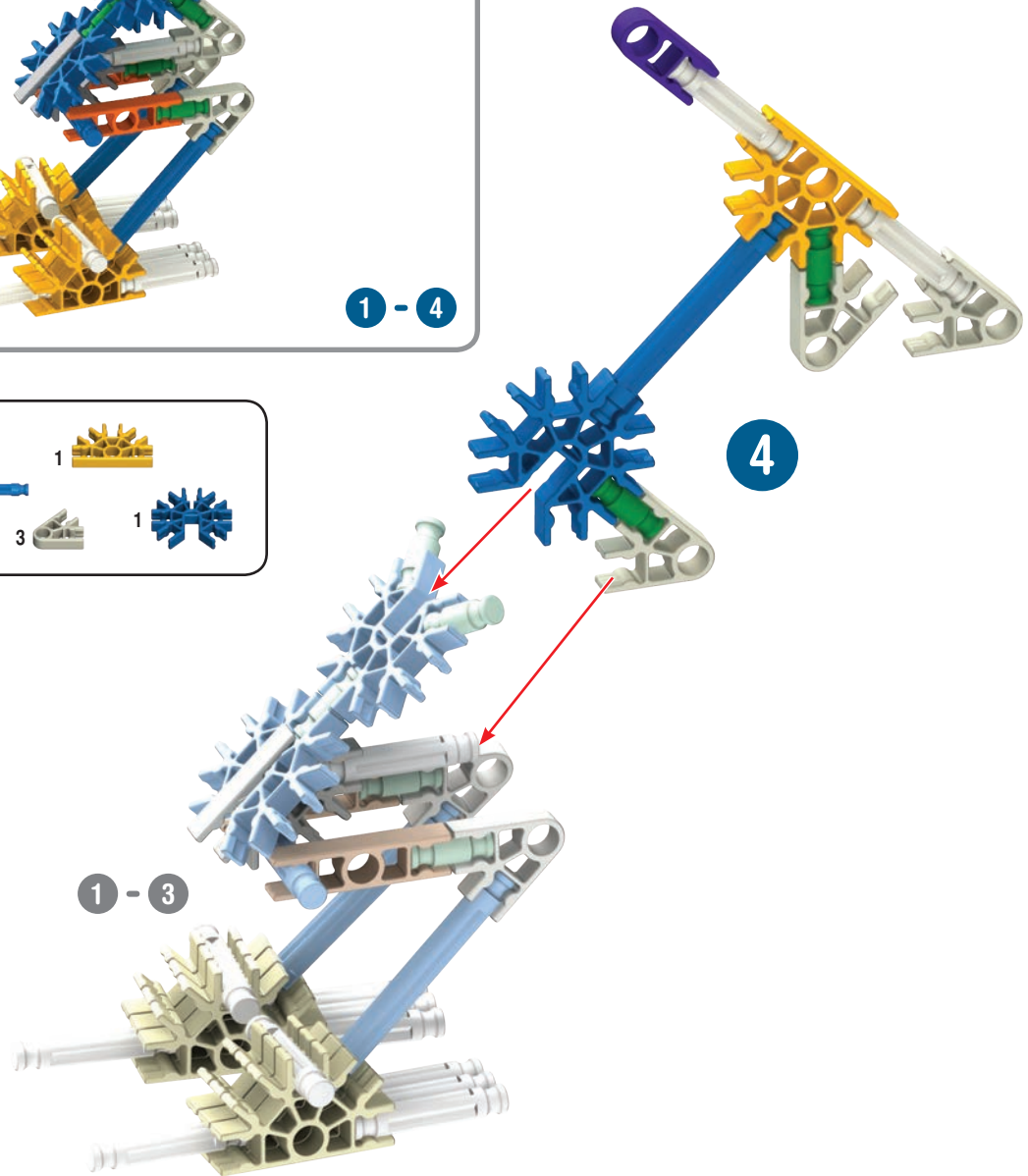
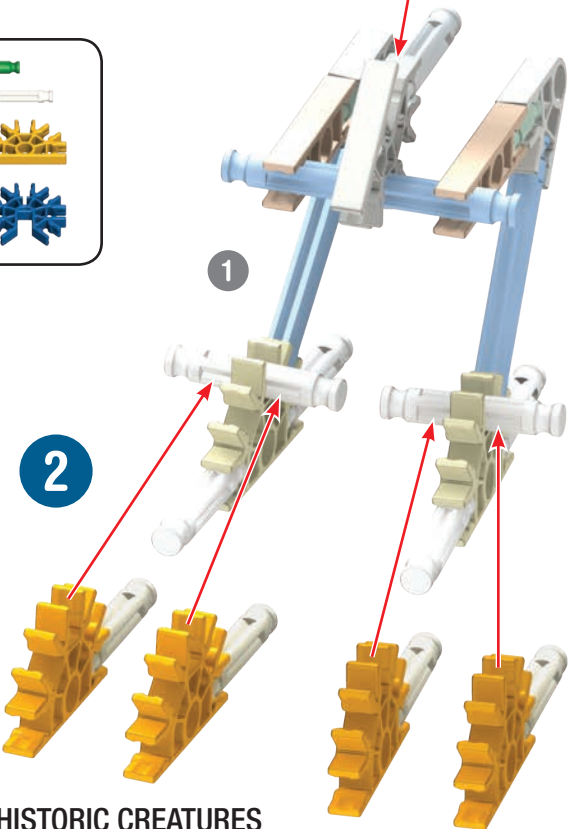
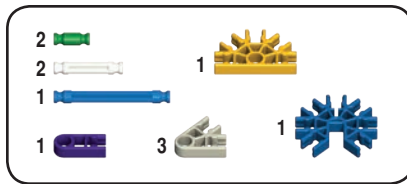
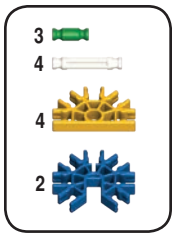
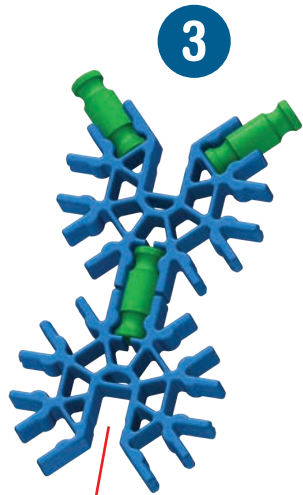
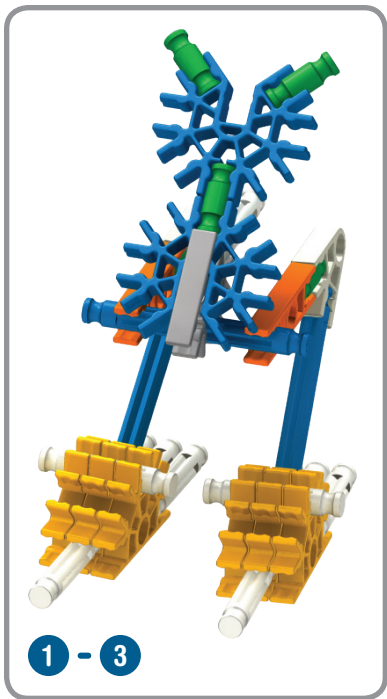

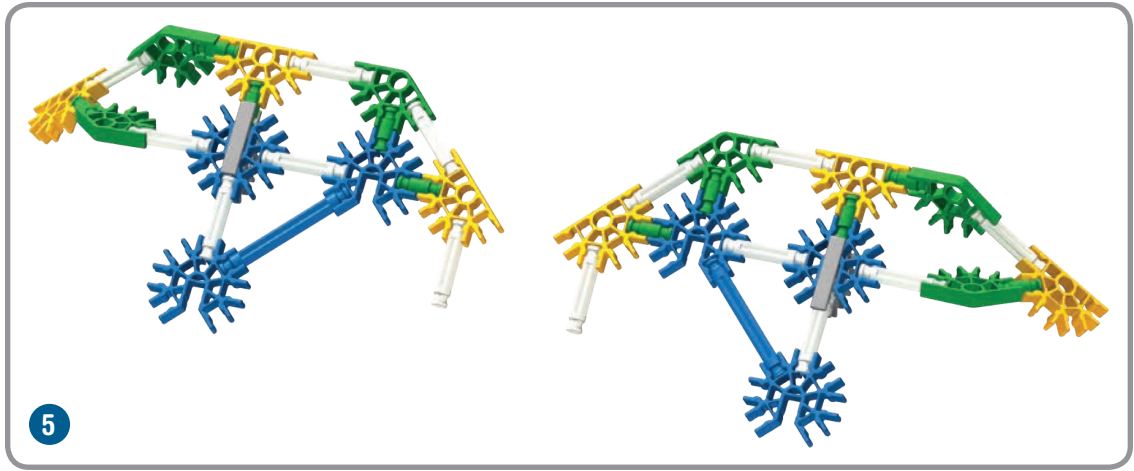
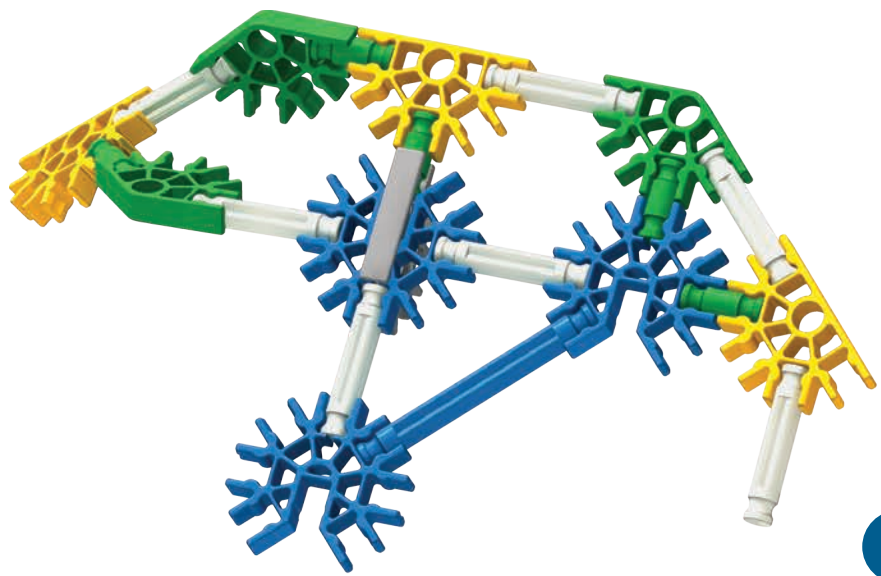

5

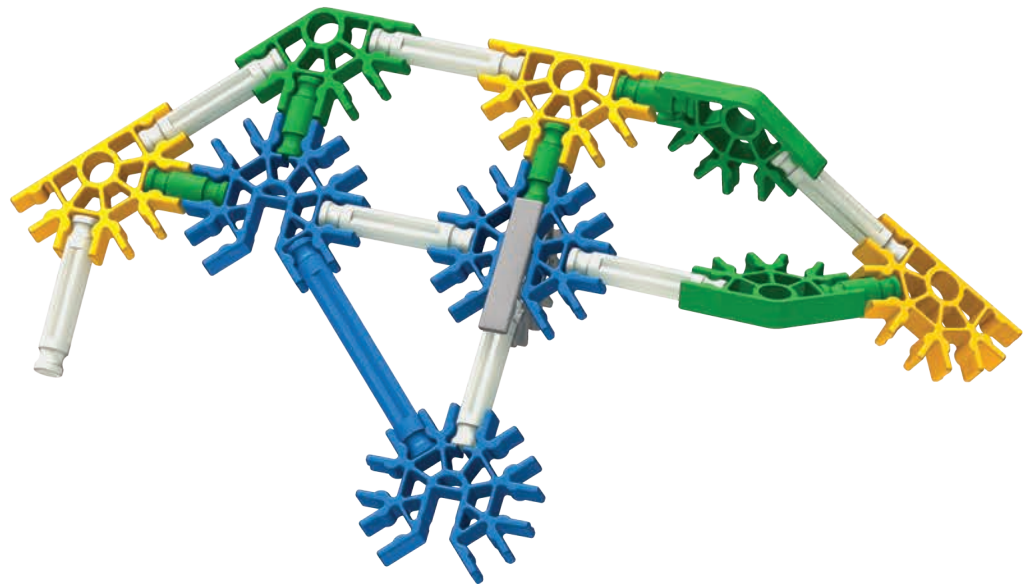

- | | | | | | |
|----|--|---|--|---|--|
| 10 | | 6 | | 6 | |
| 14 | | 2 | | 6 | |
| 2 | | 6 | | 2 | |
| 6 | | 2 | | | |

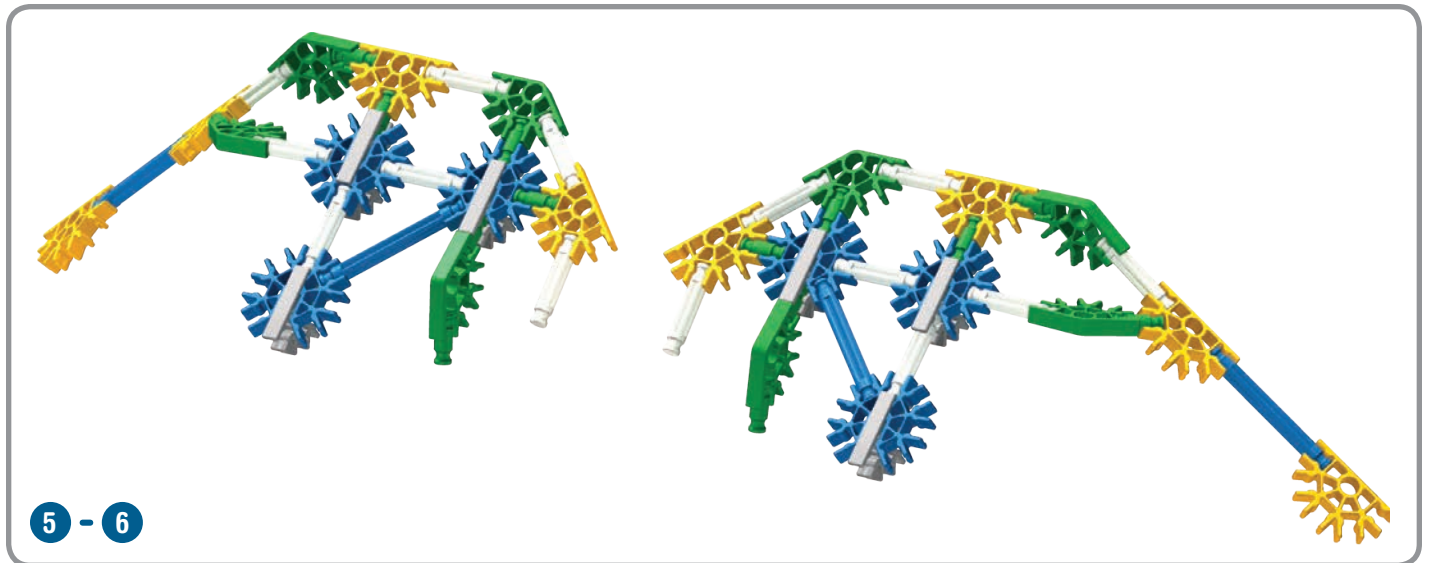
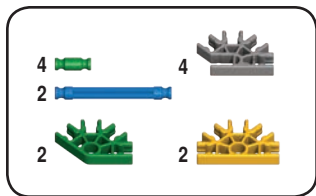
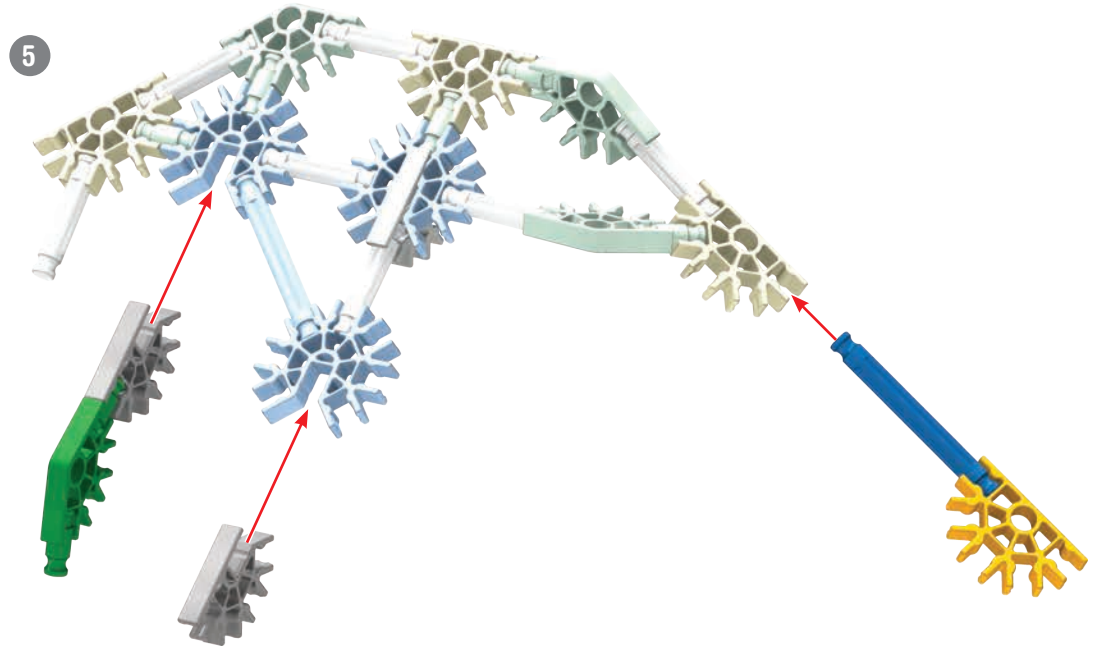
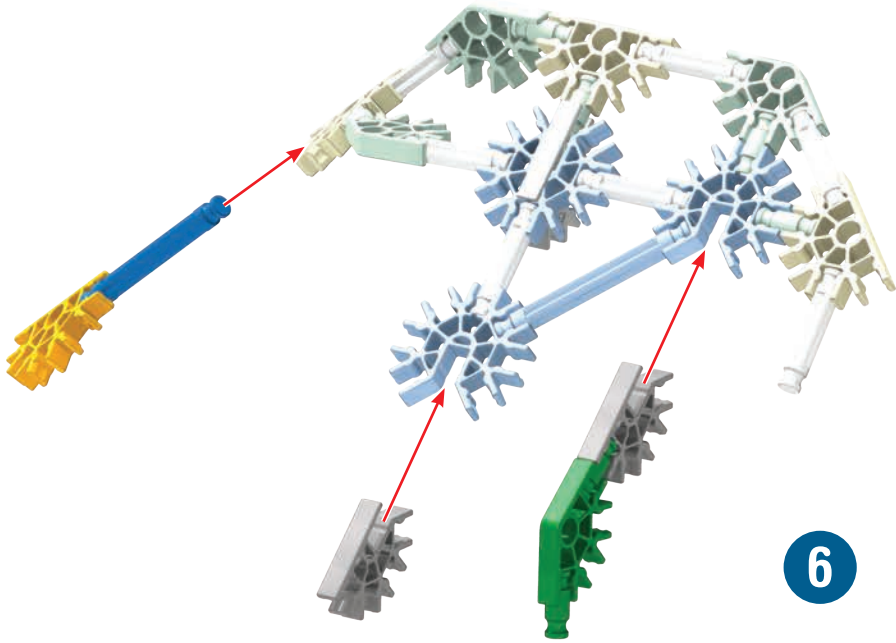

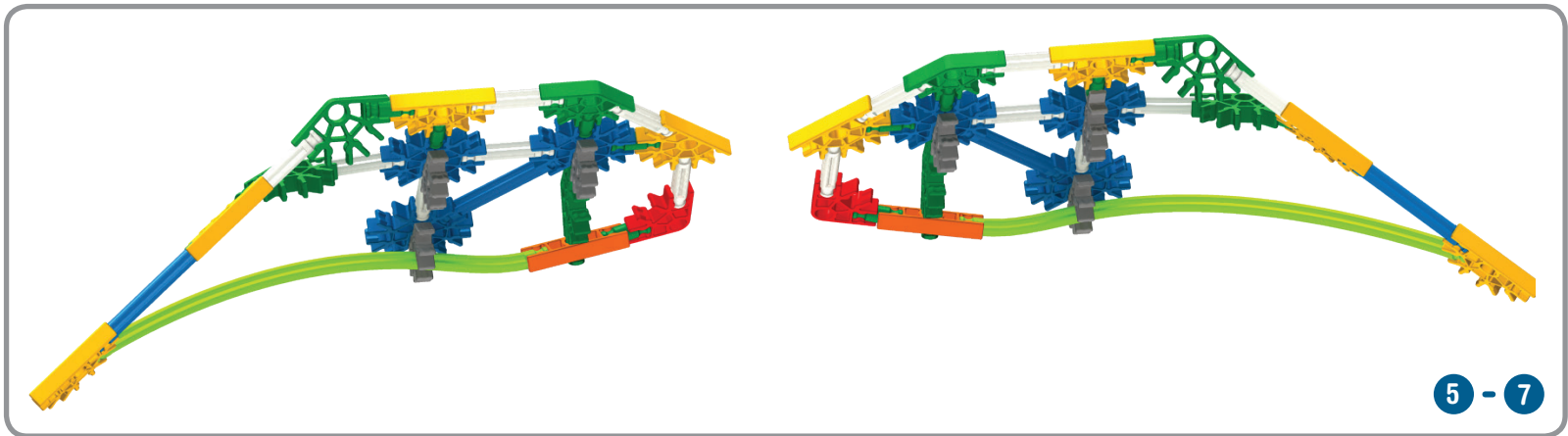
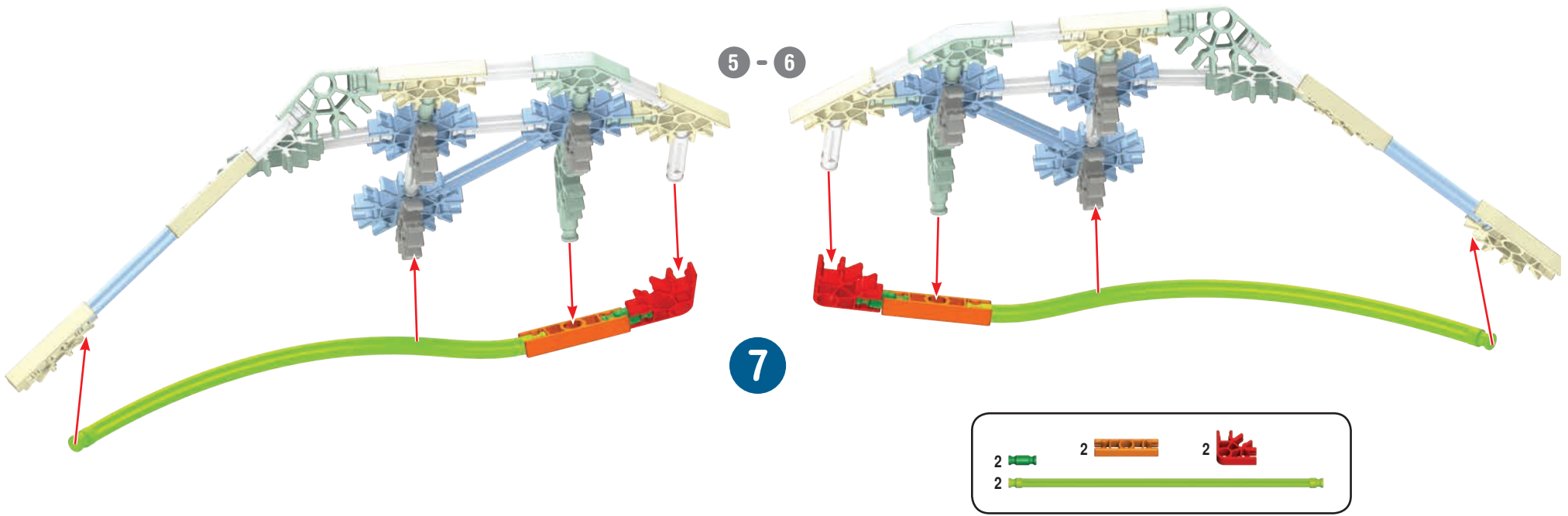

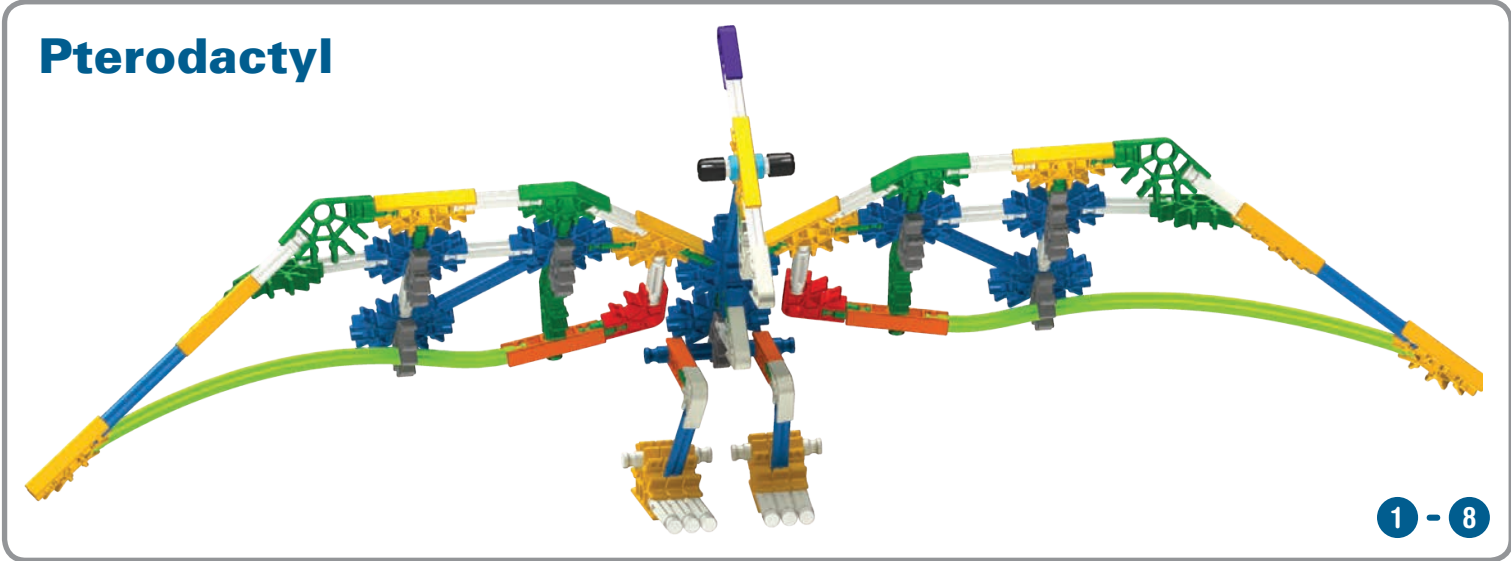
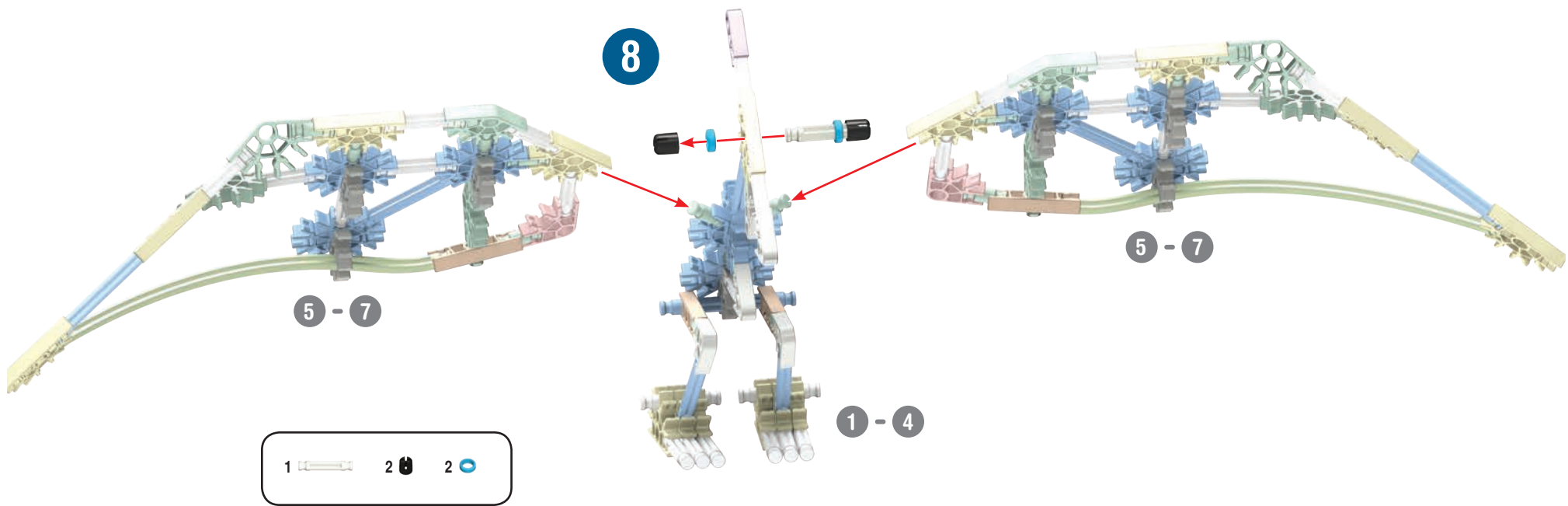

Stegosaurus

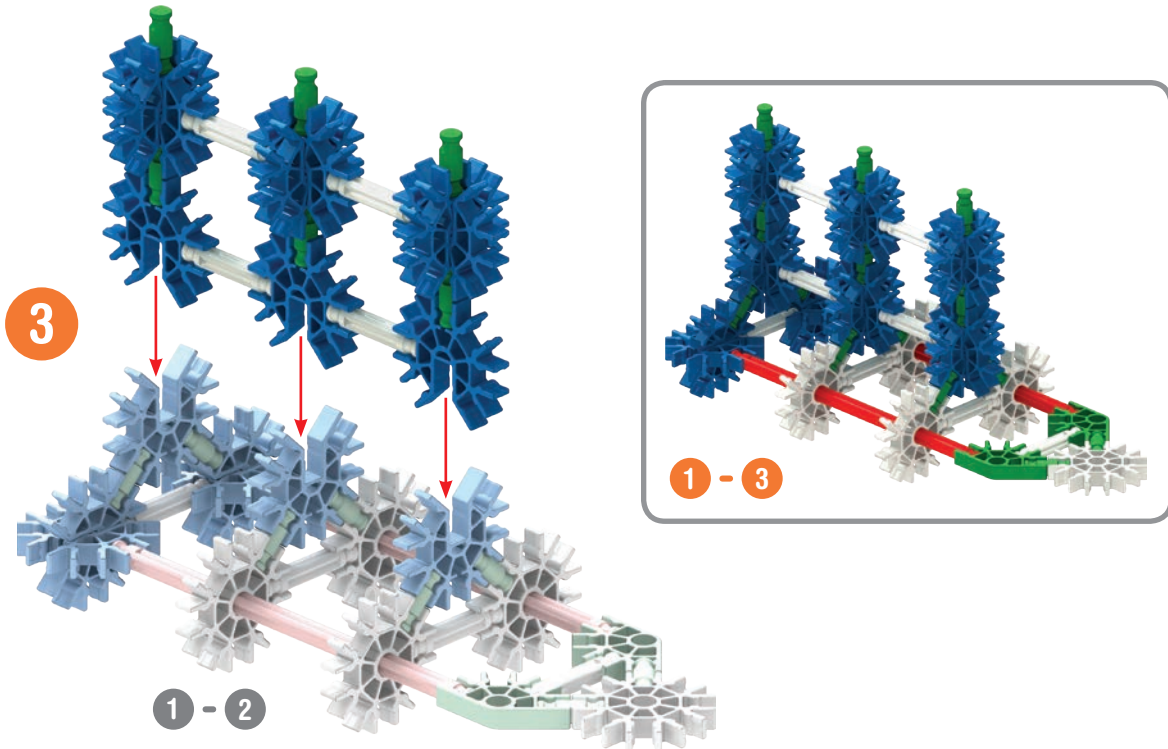
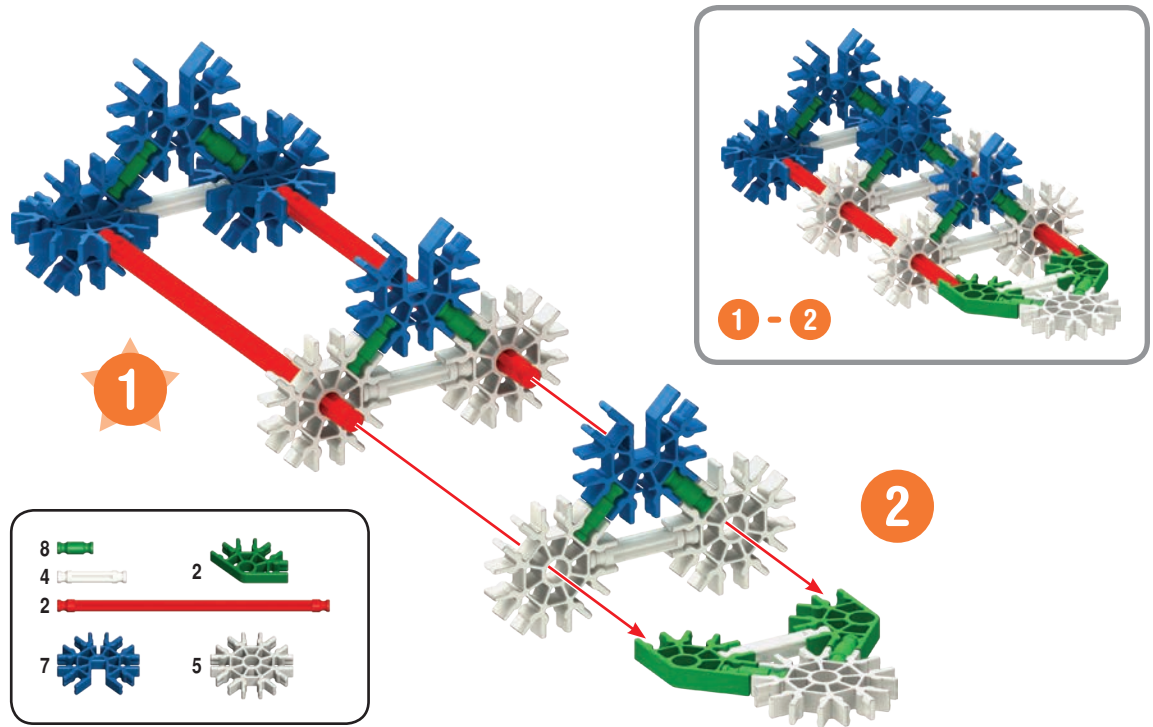
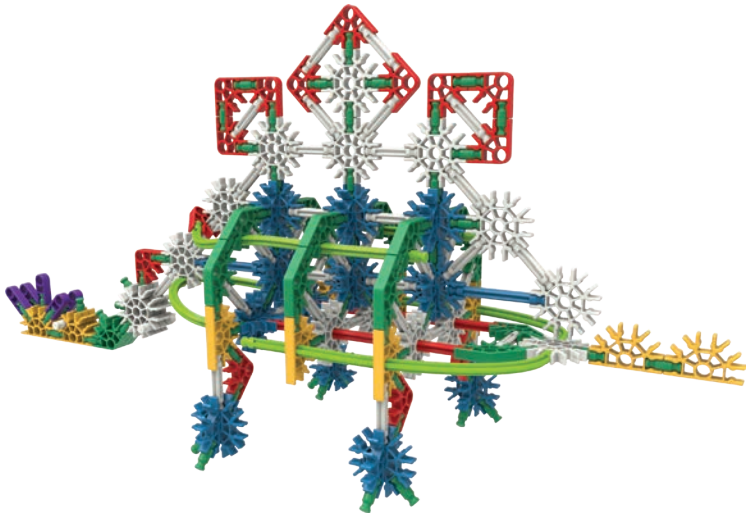

2		1		7	
8					
2					

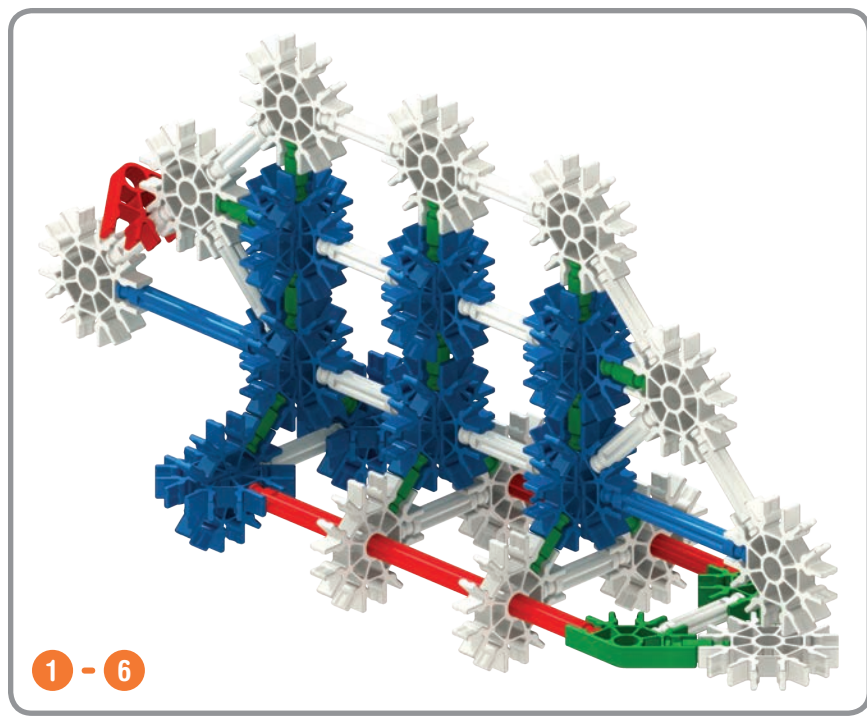
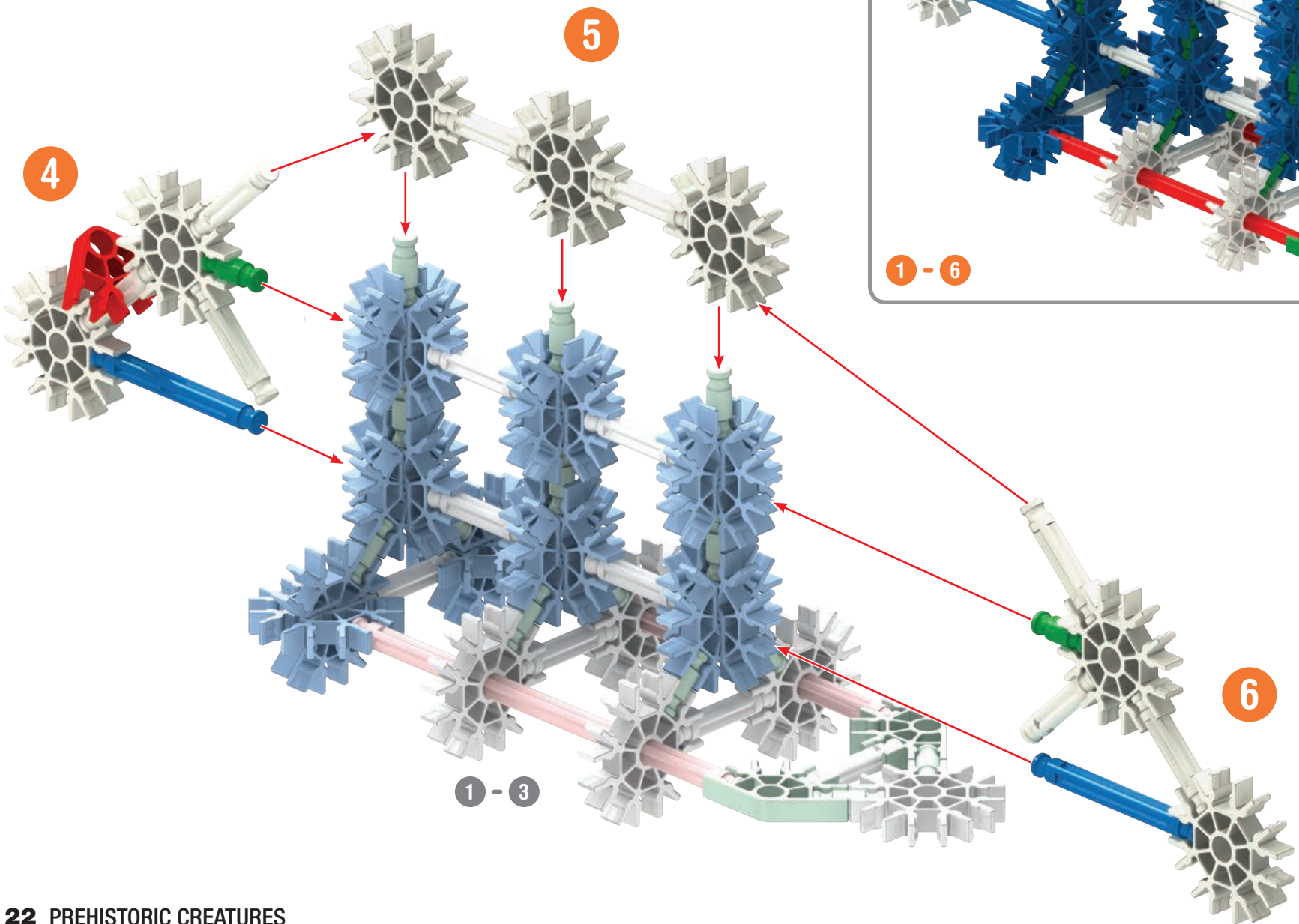

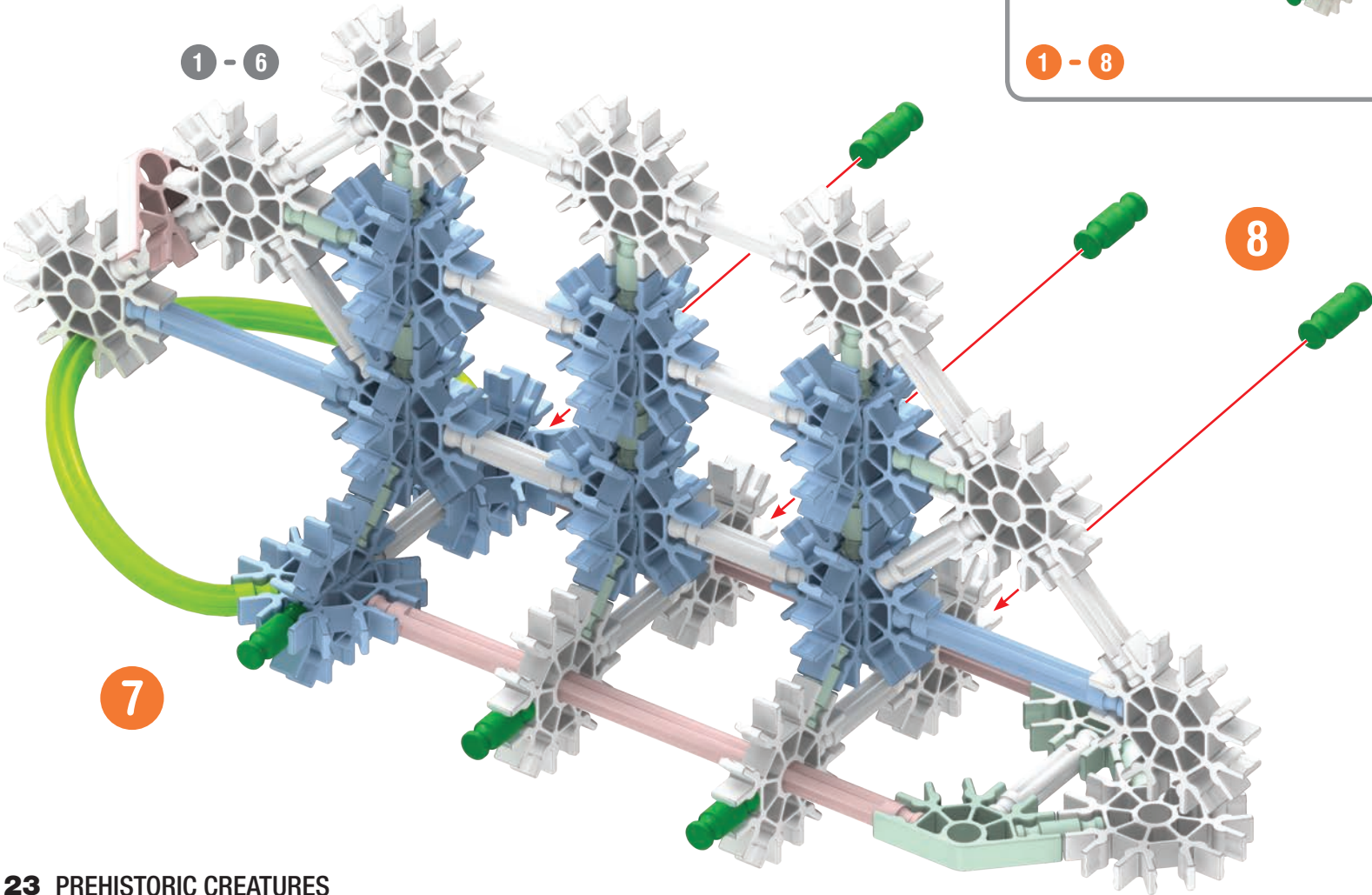
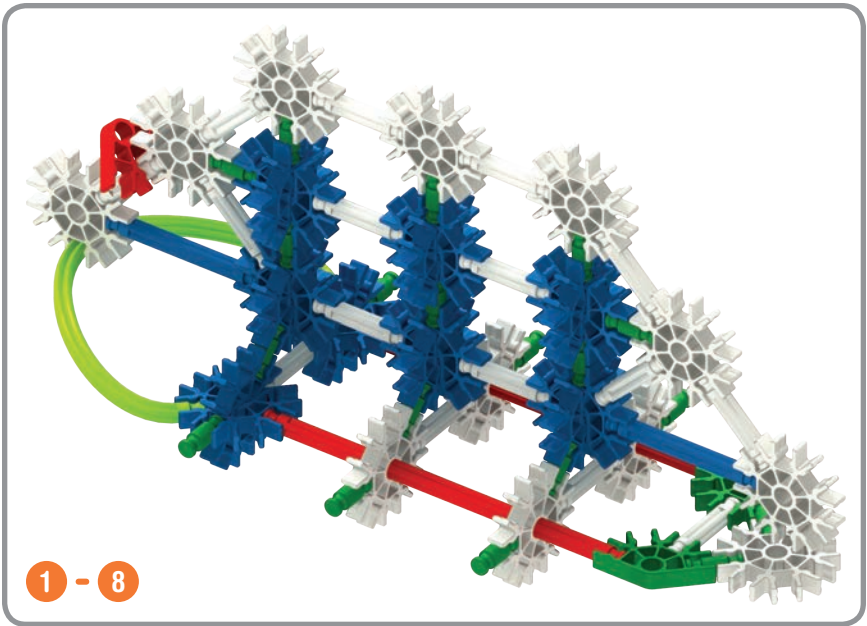

1 - 8

9		6		3	
3					
1					

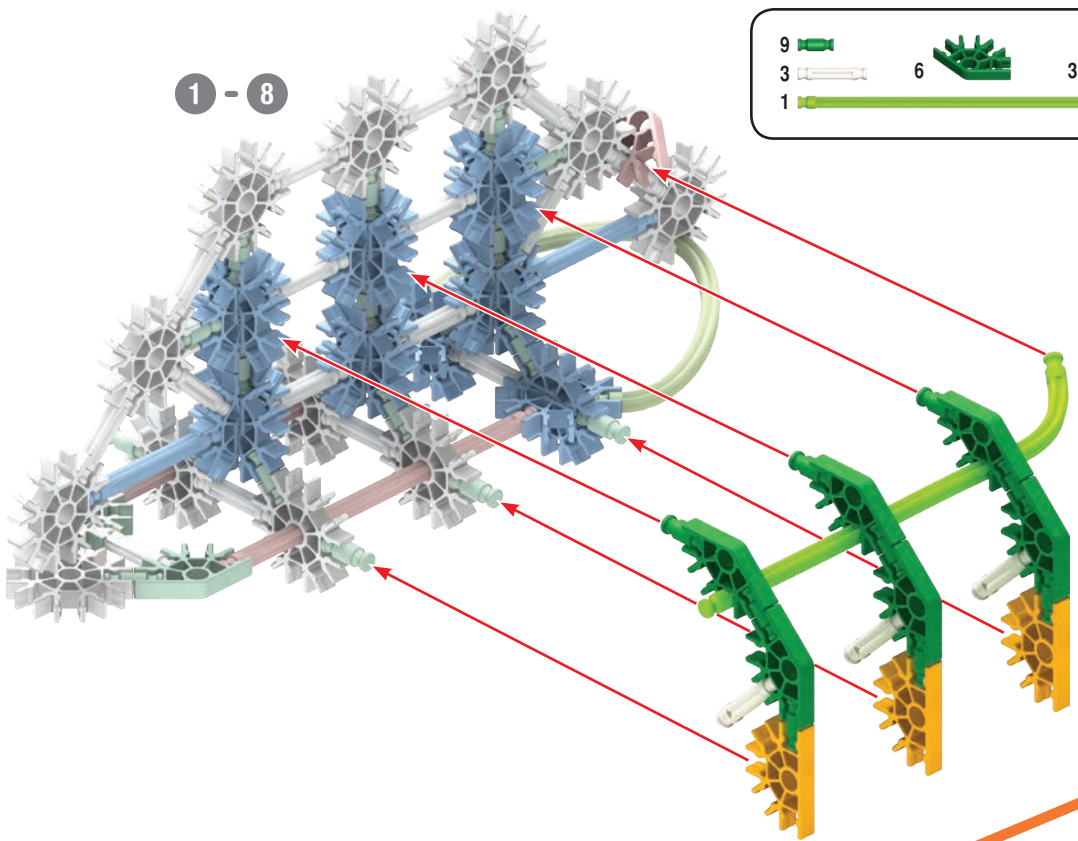

9

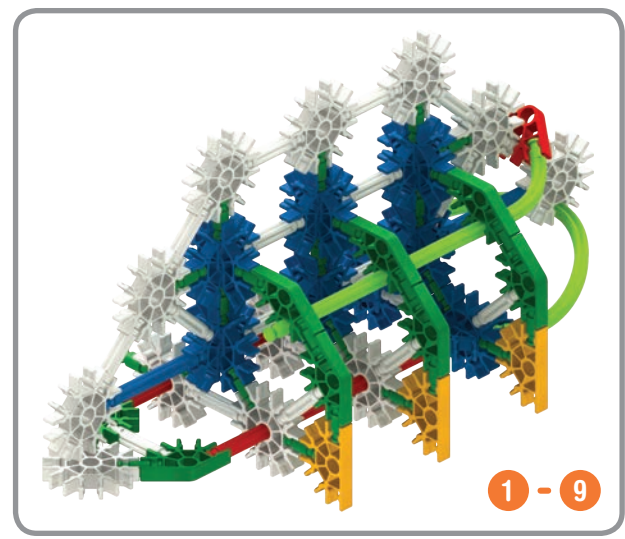

1 - 9

9		6		3	
3					
1					

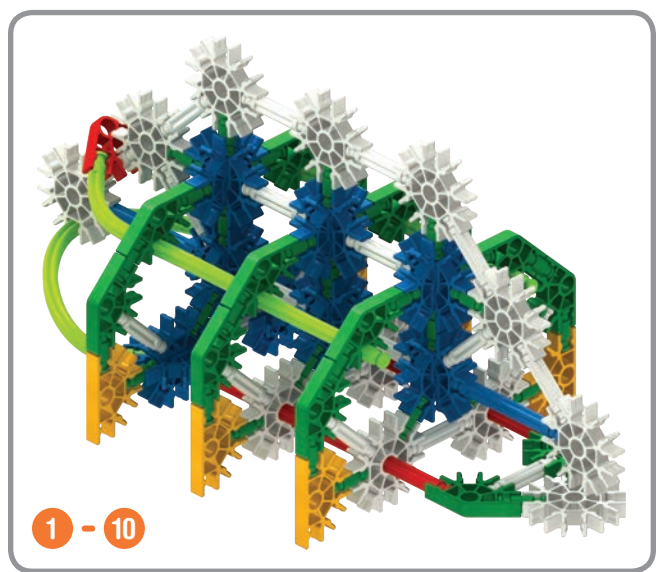

1 - 10

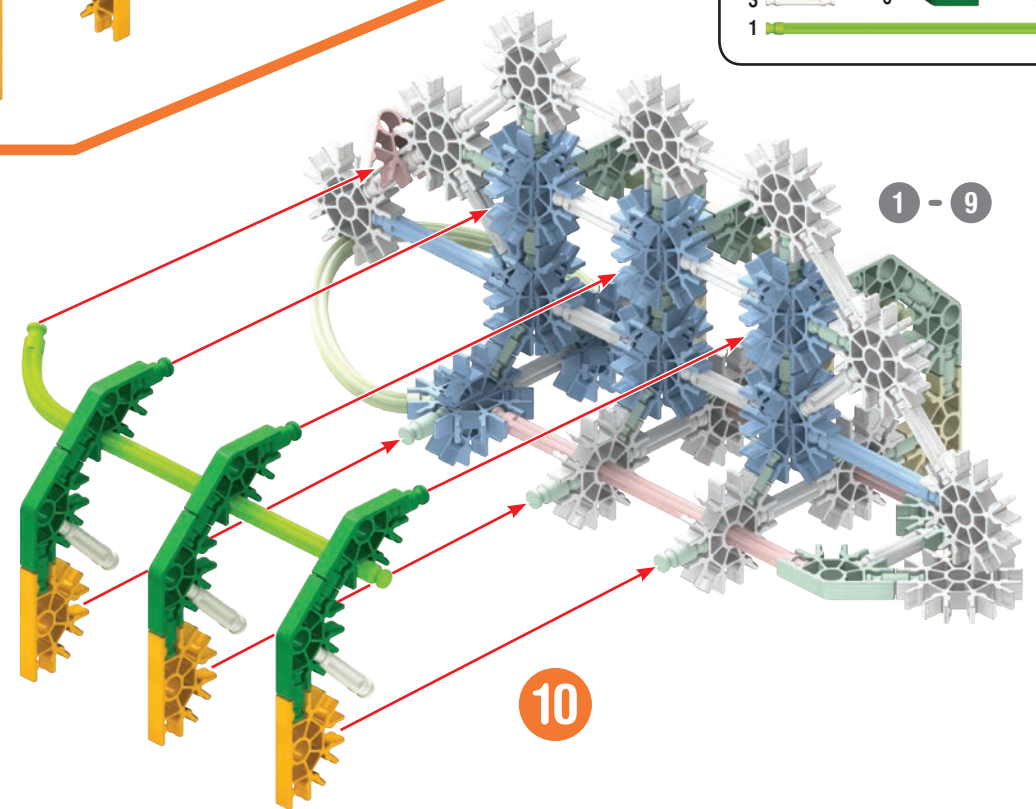

10

1 - 9

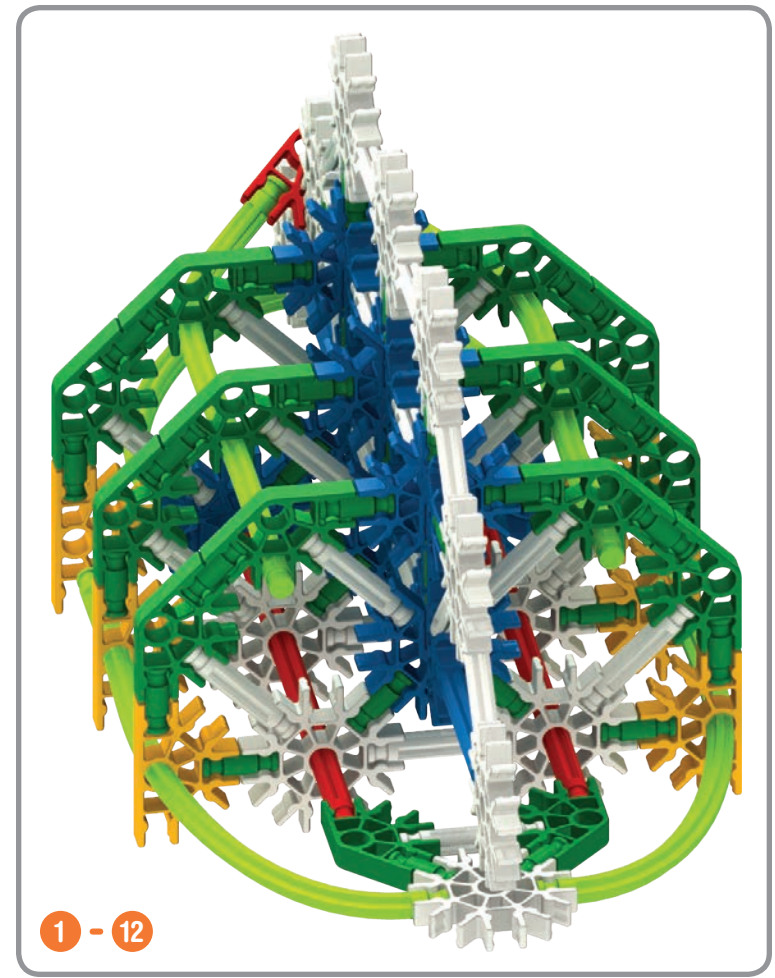
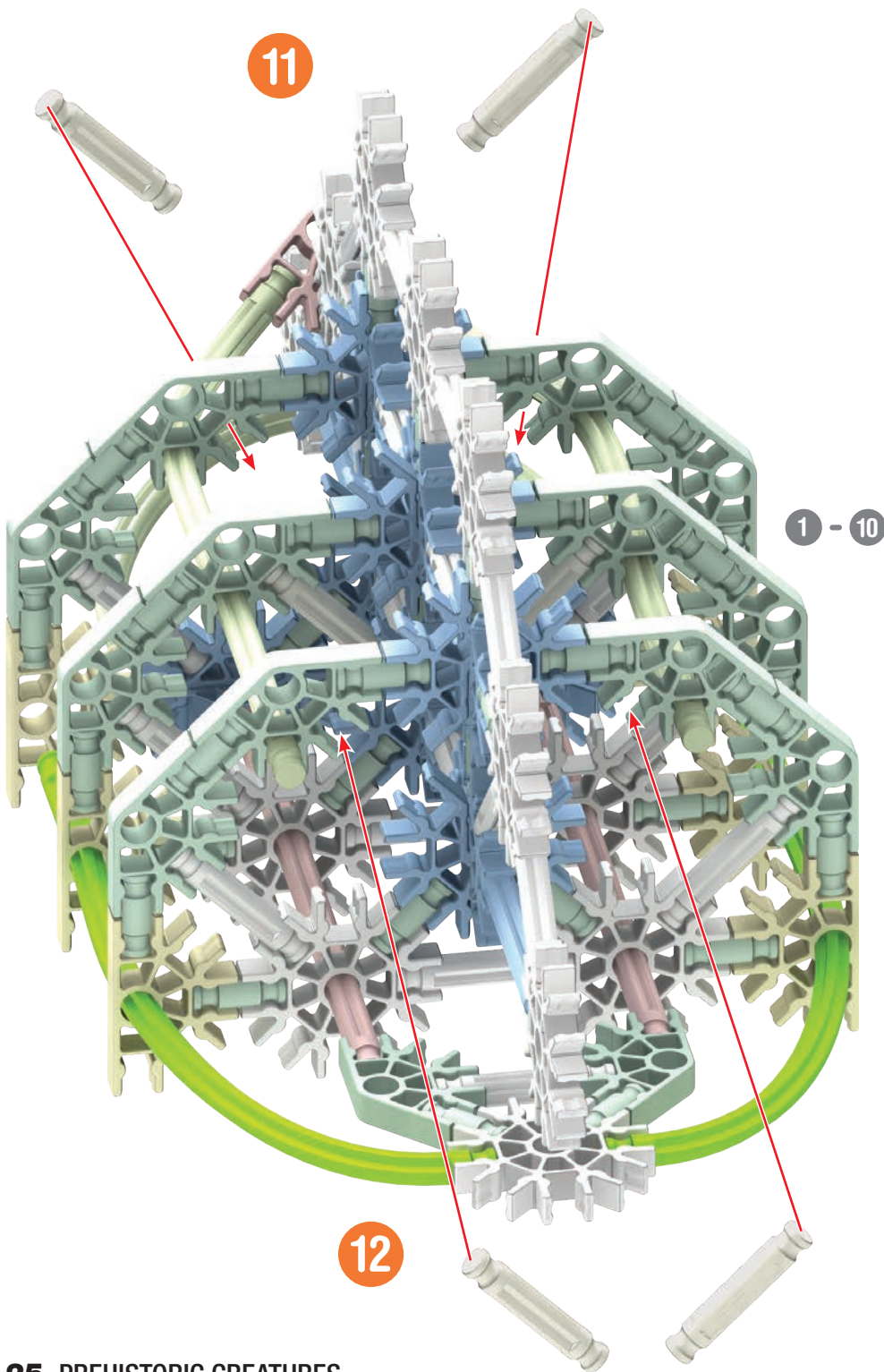

13

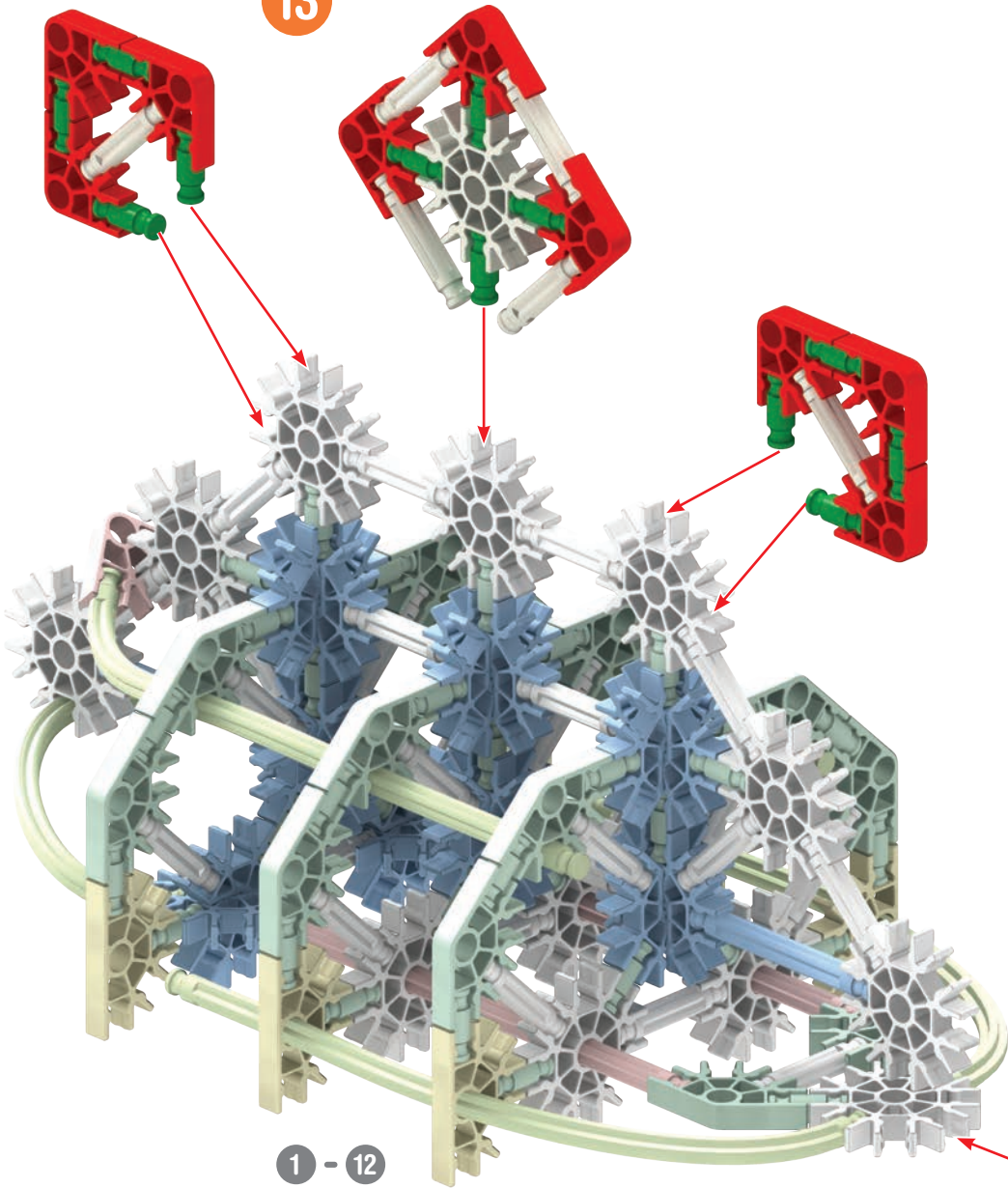

1 - 12

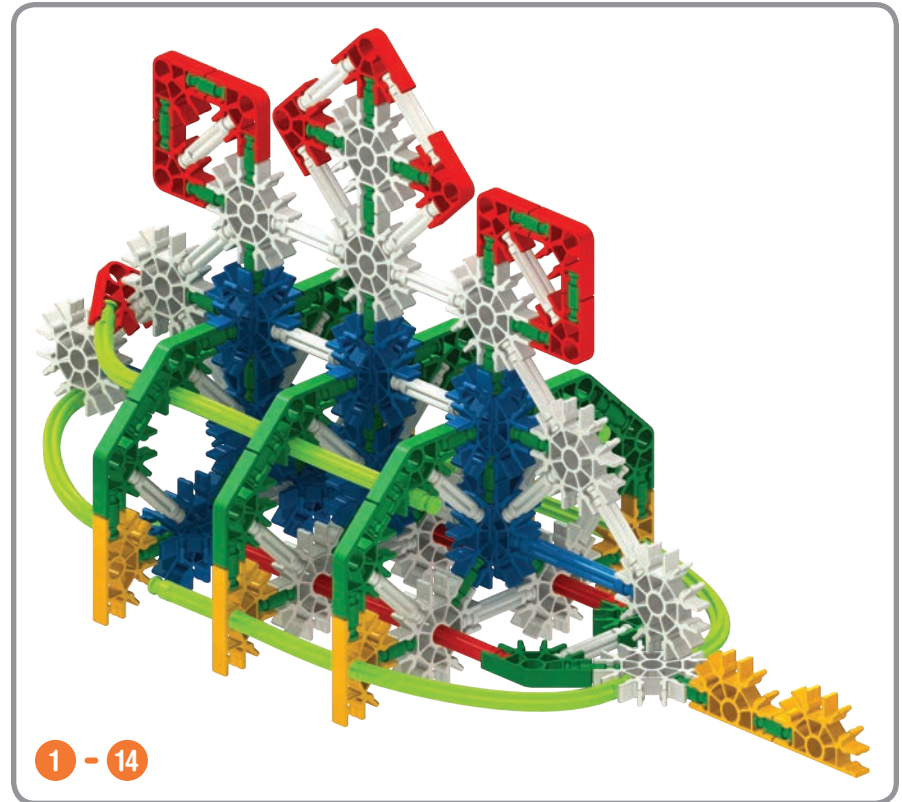

1 - 14

14		9		2		1	
6							

14

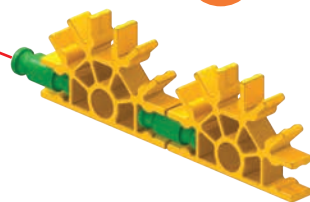

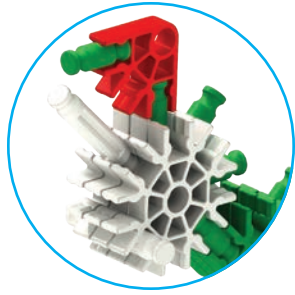

TIP: For this section of the model, it is easier to connect the rods to the connectors by pushing them from the side.

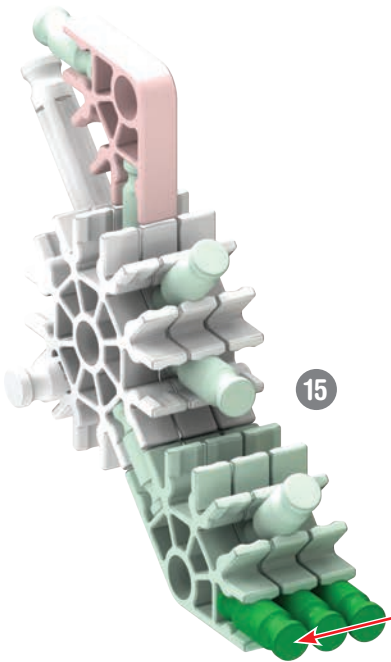
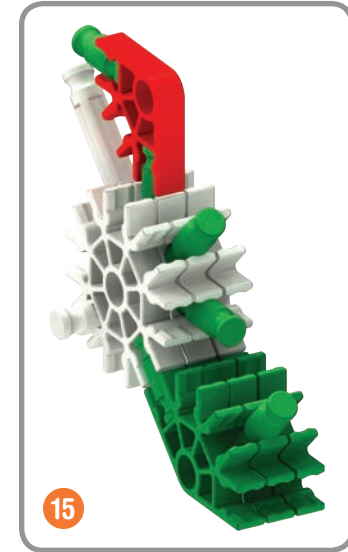
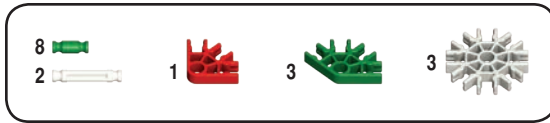
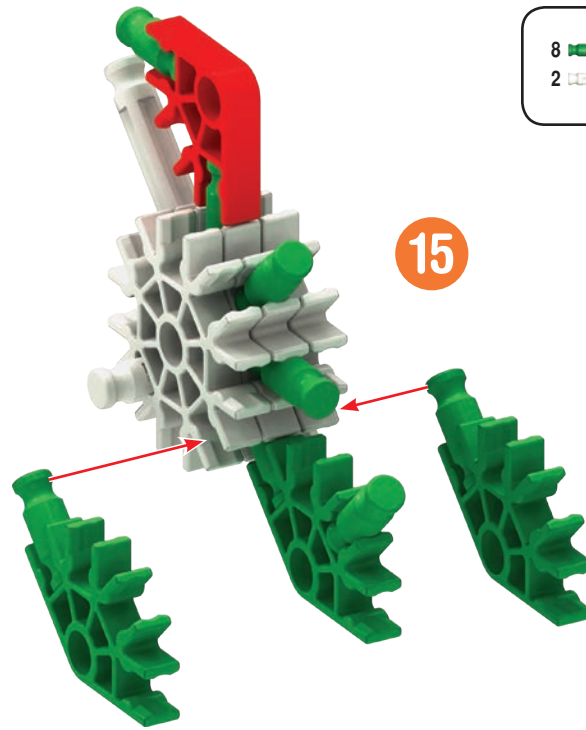

TIP: Connect white rod to the yellow connectors first.

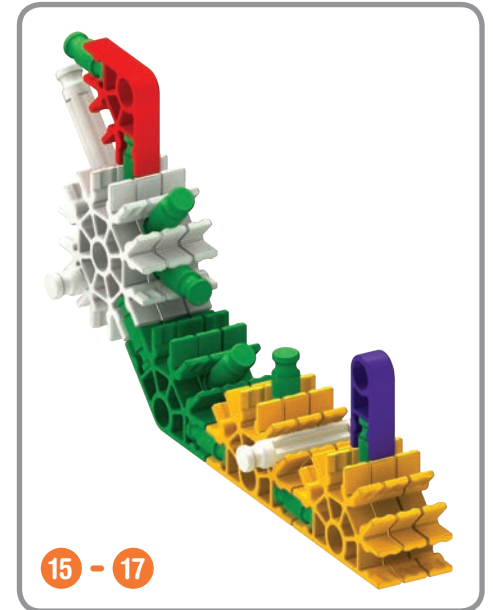
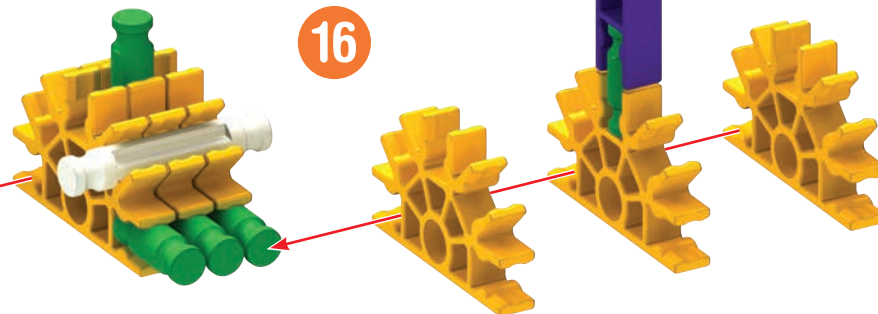

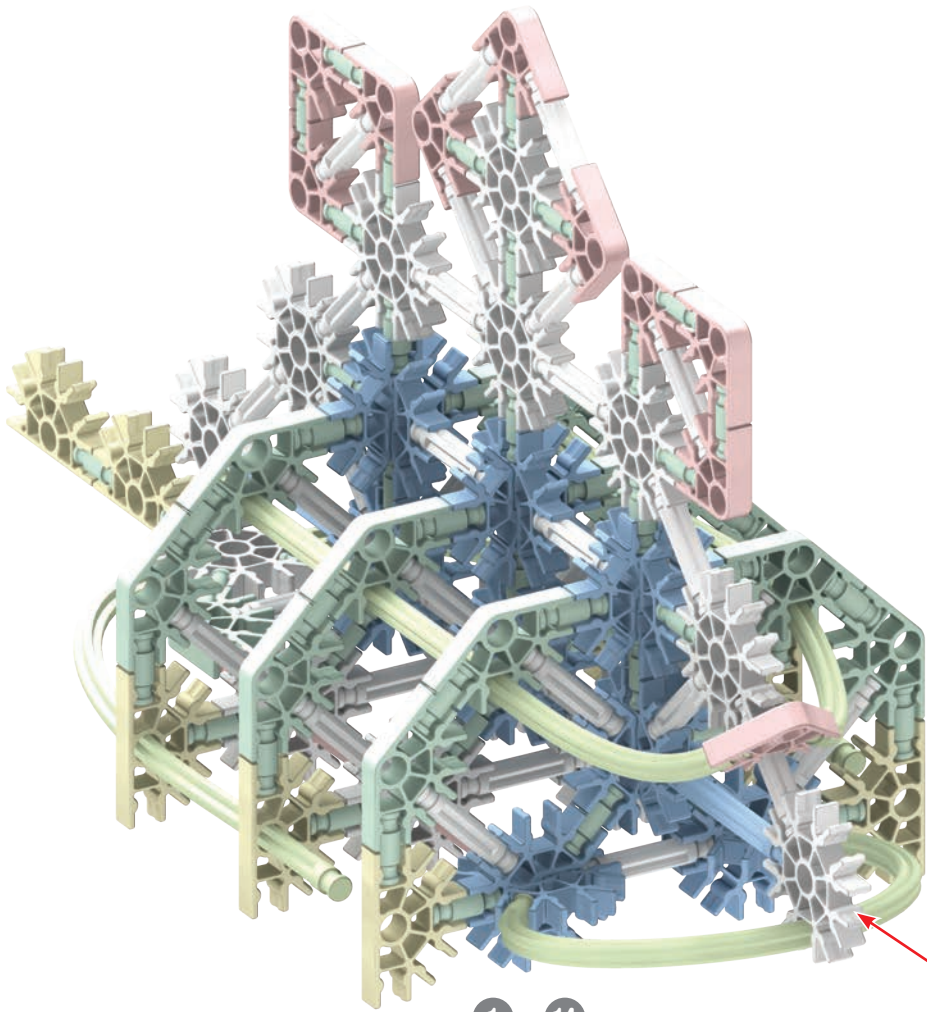

1 - 14

18



1 - 18



15 - 17

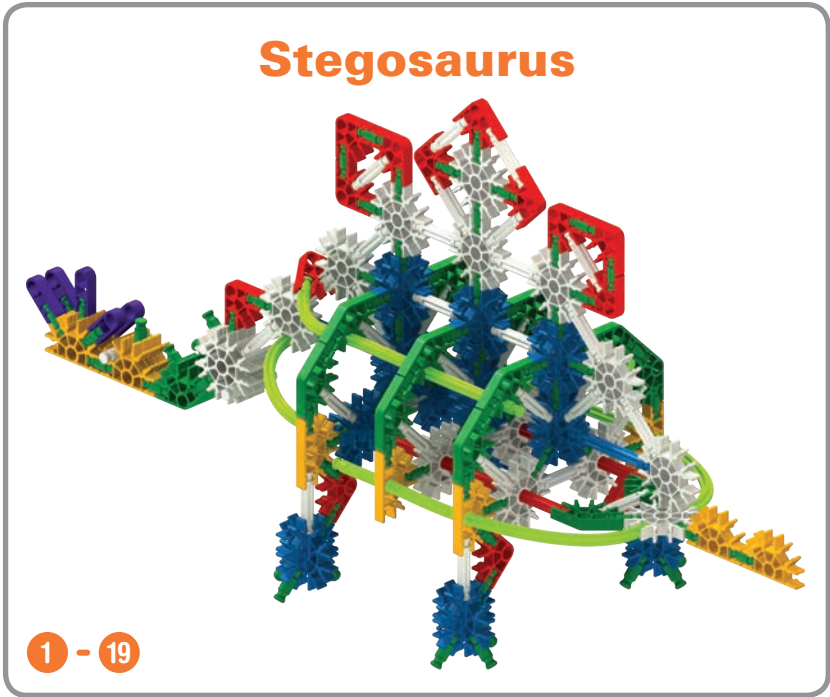
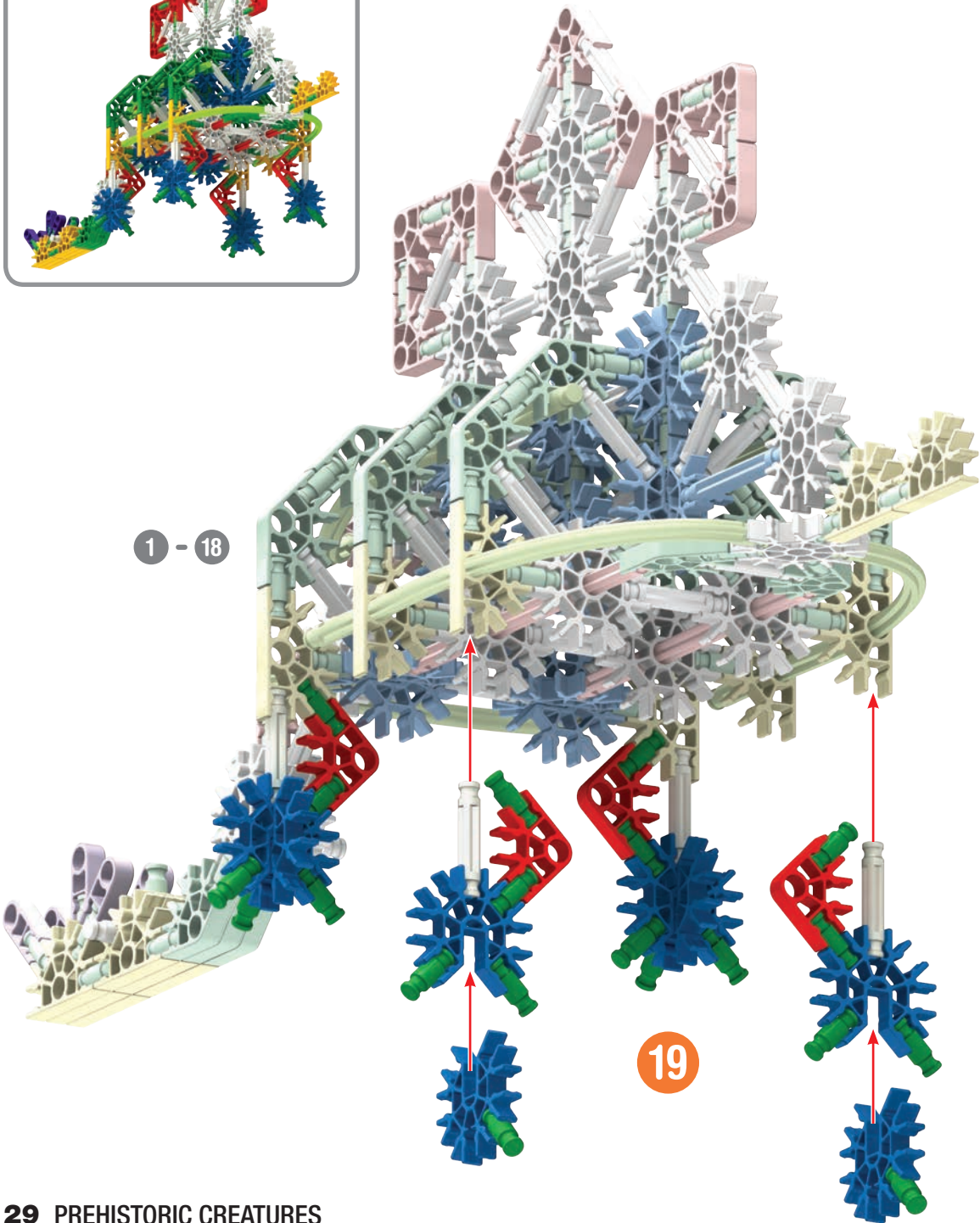

Triceratops

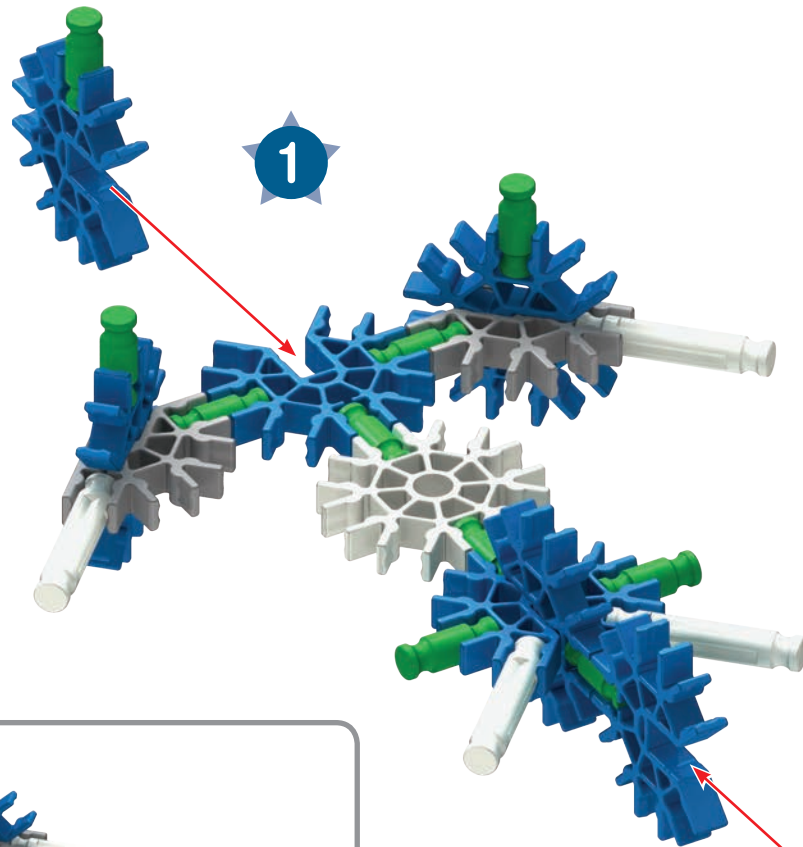
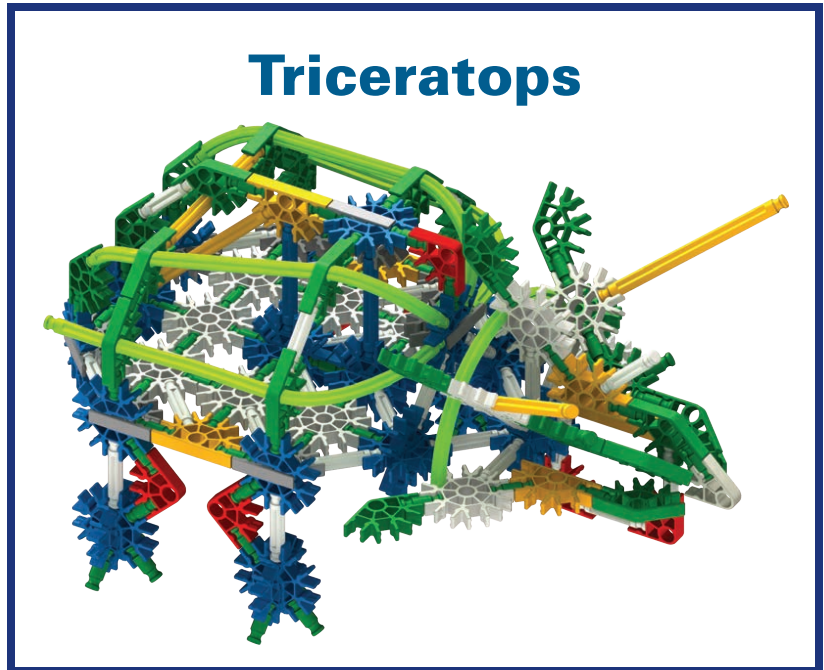

- 10
- 6
- 2
- 12
- 1

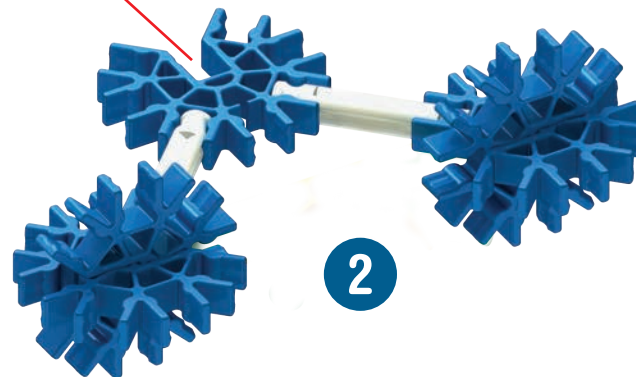
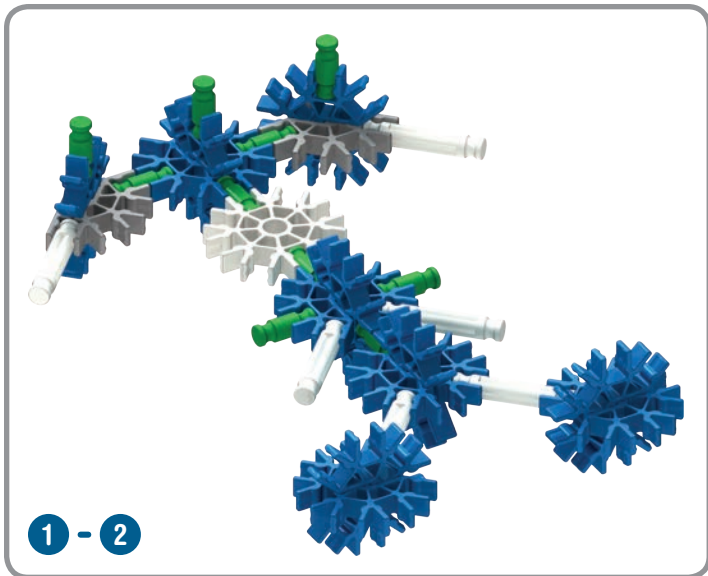

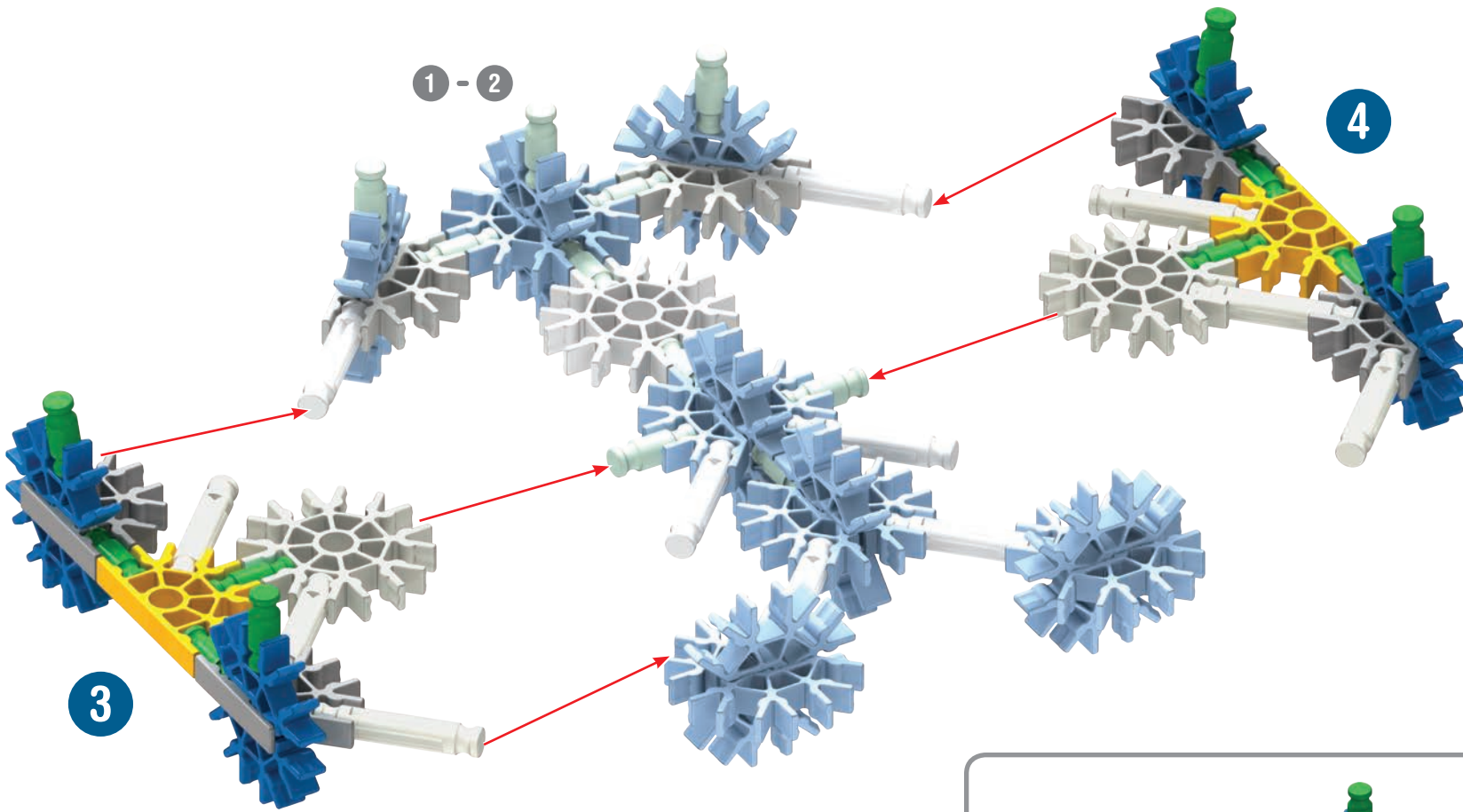

10		2		4		4		2	
6									

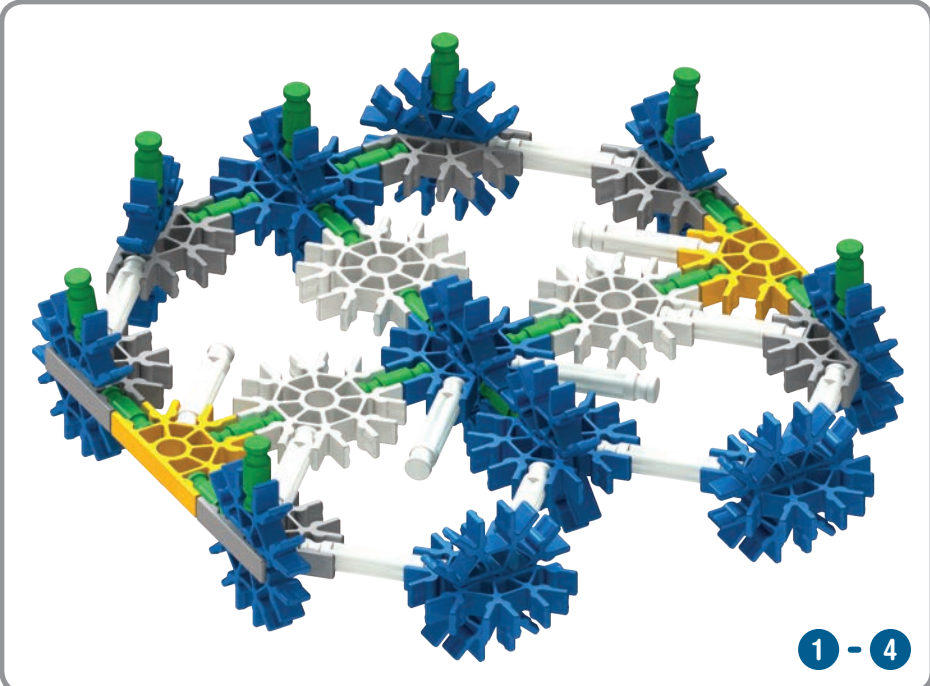

x4

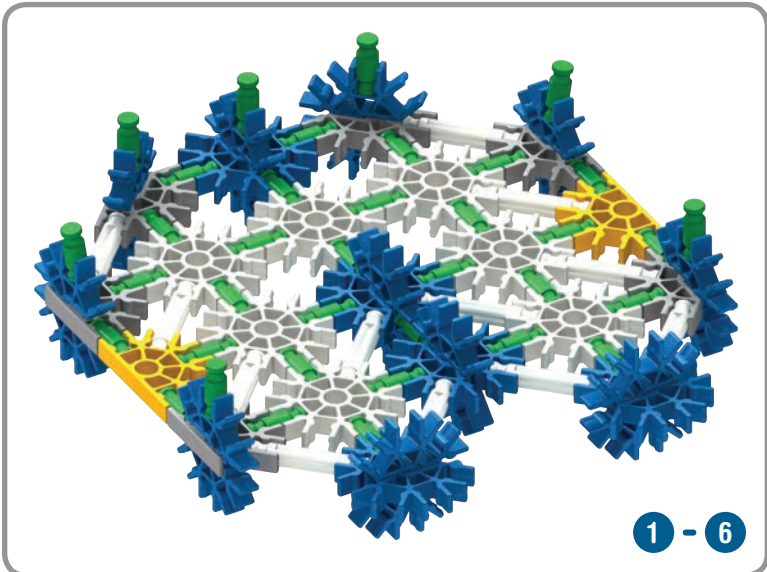
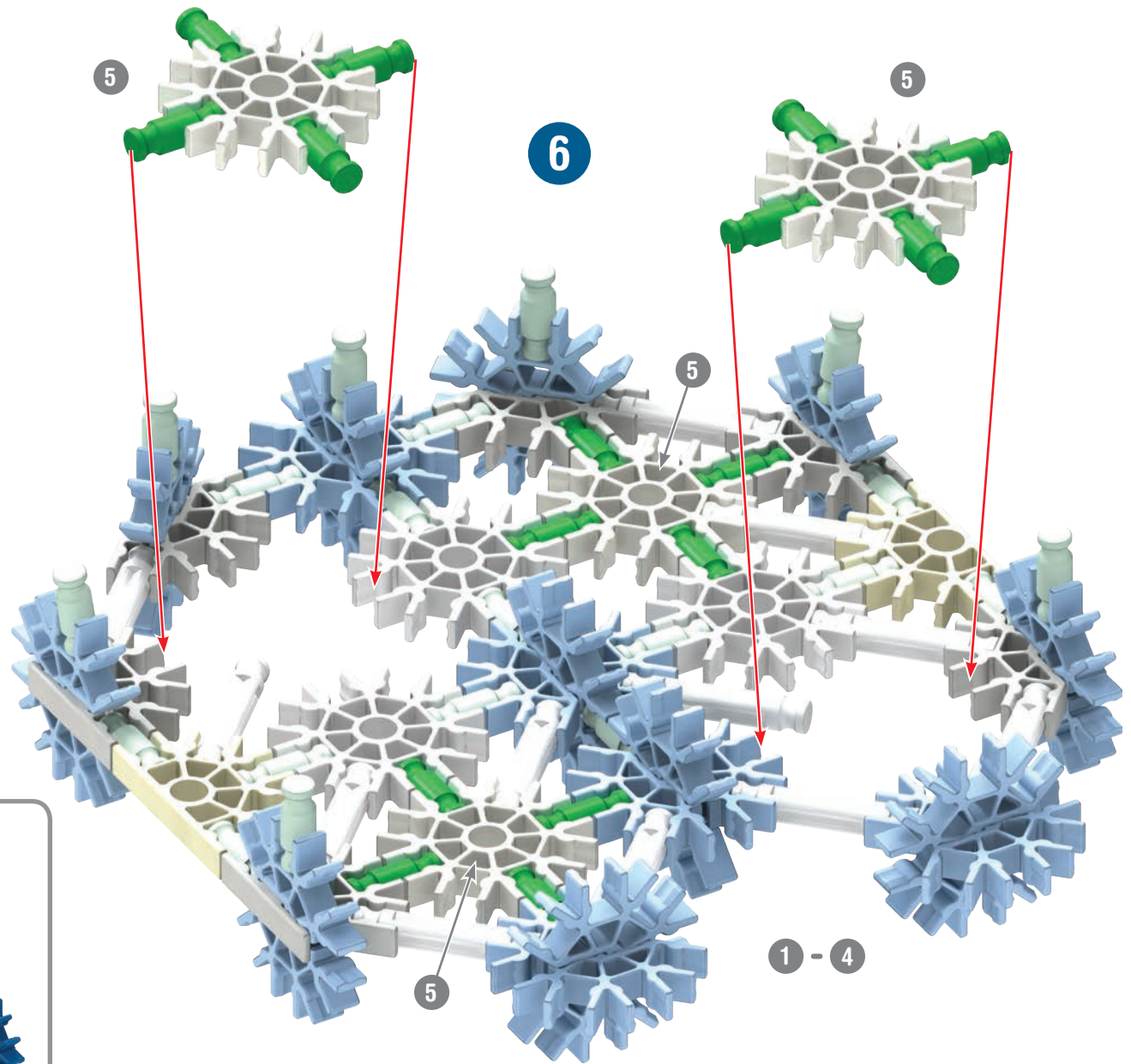
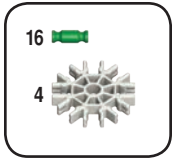
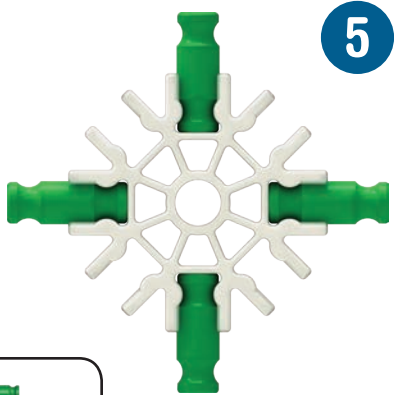

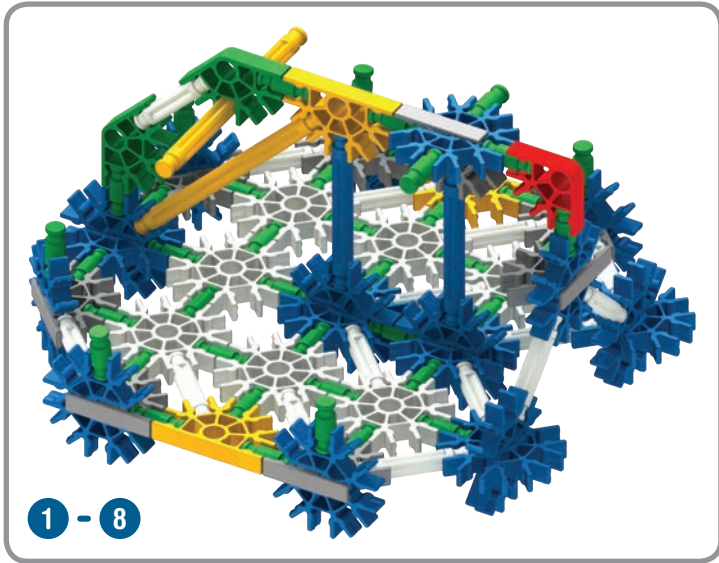
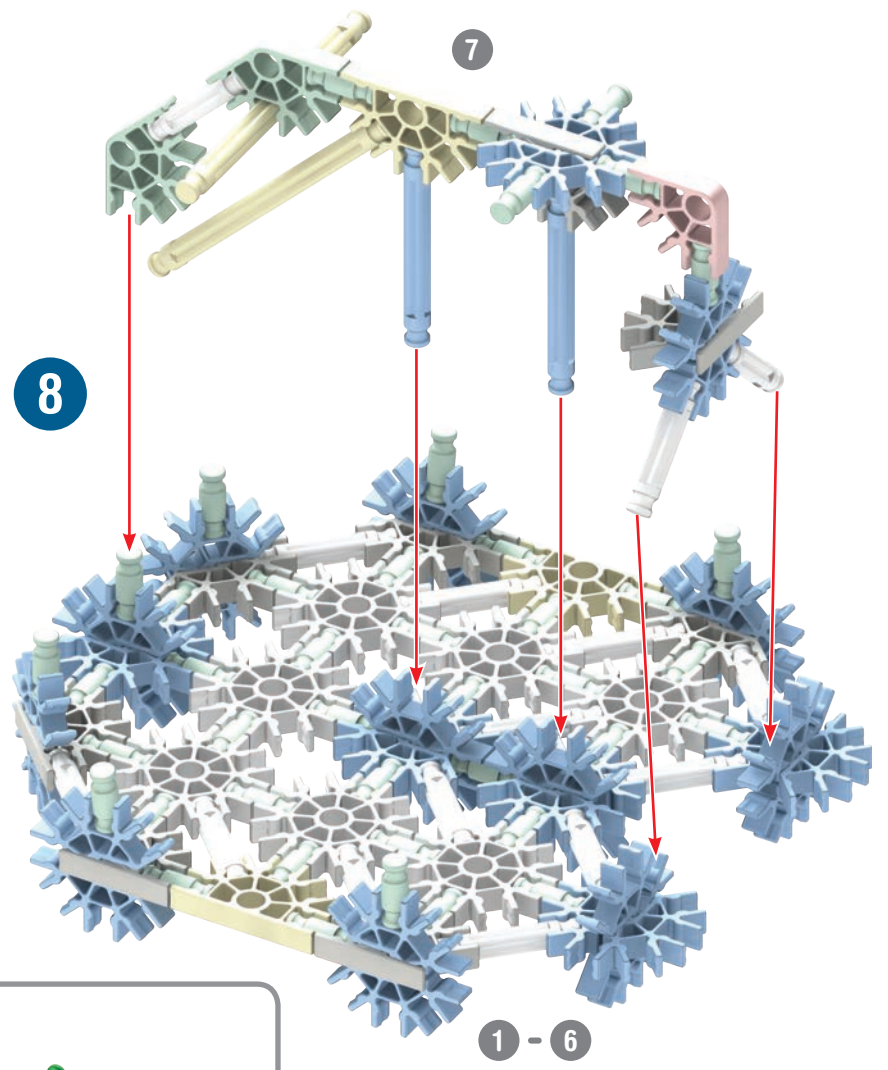
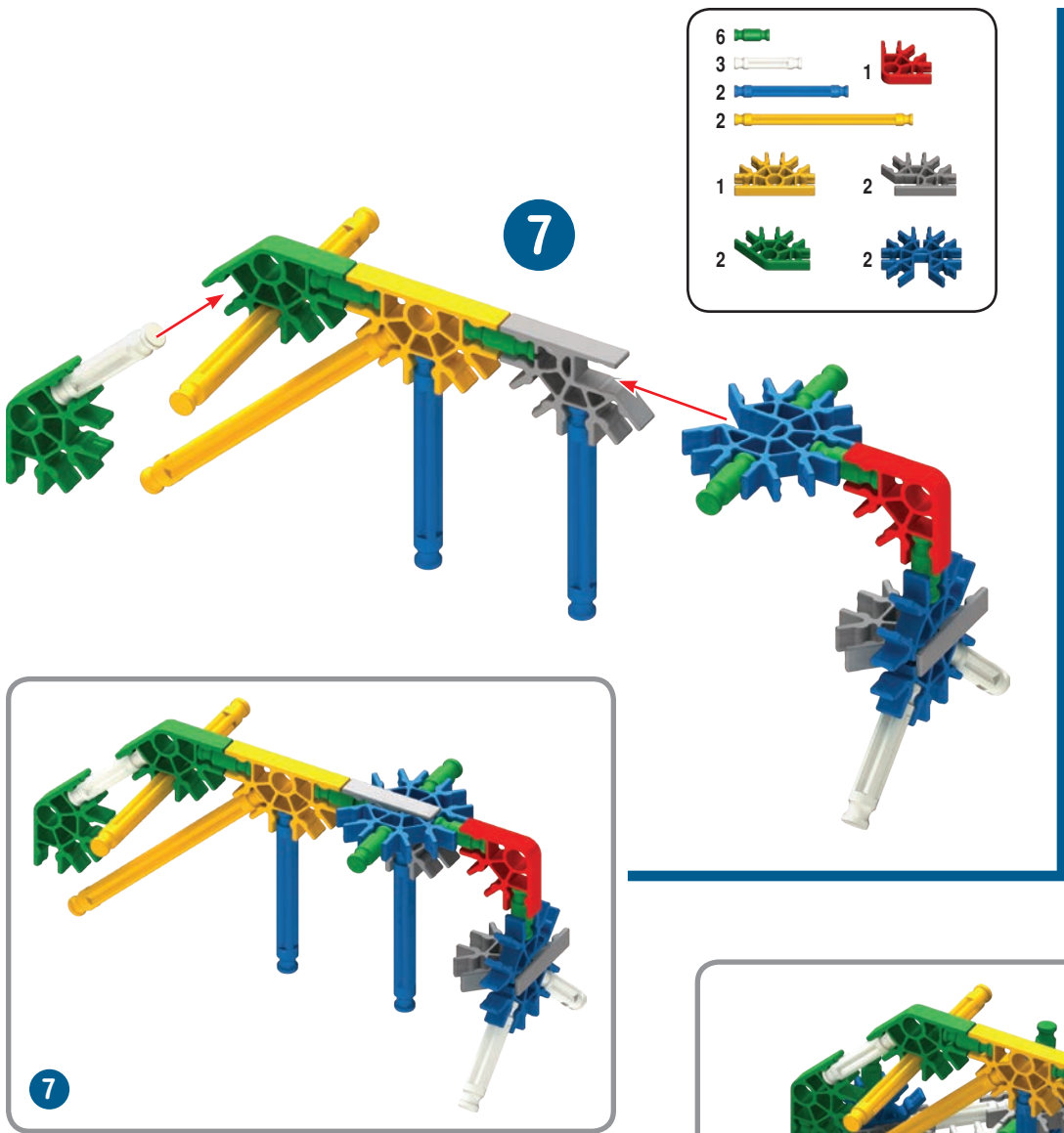

9

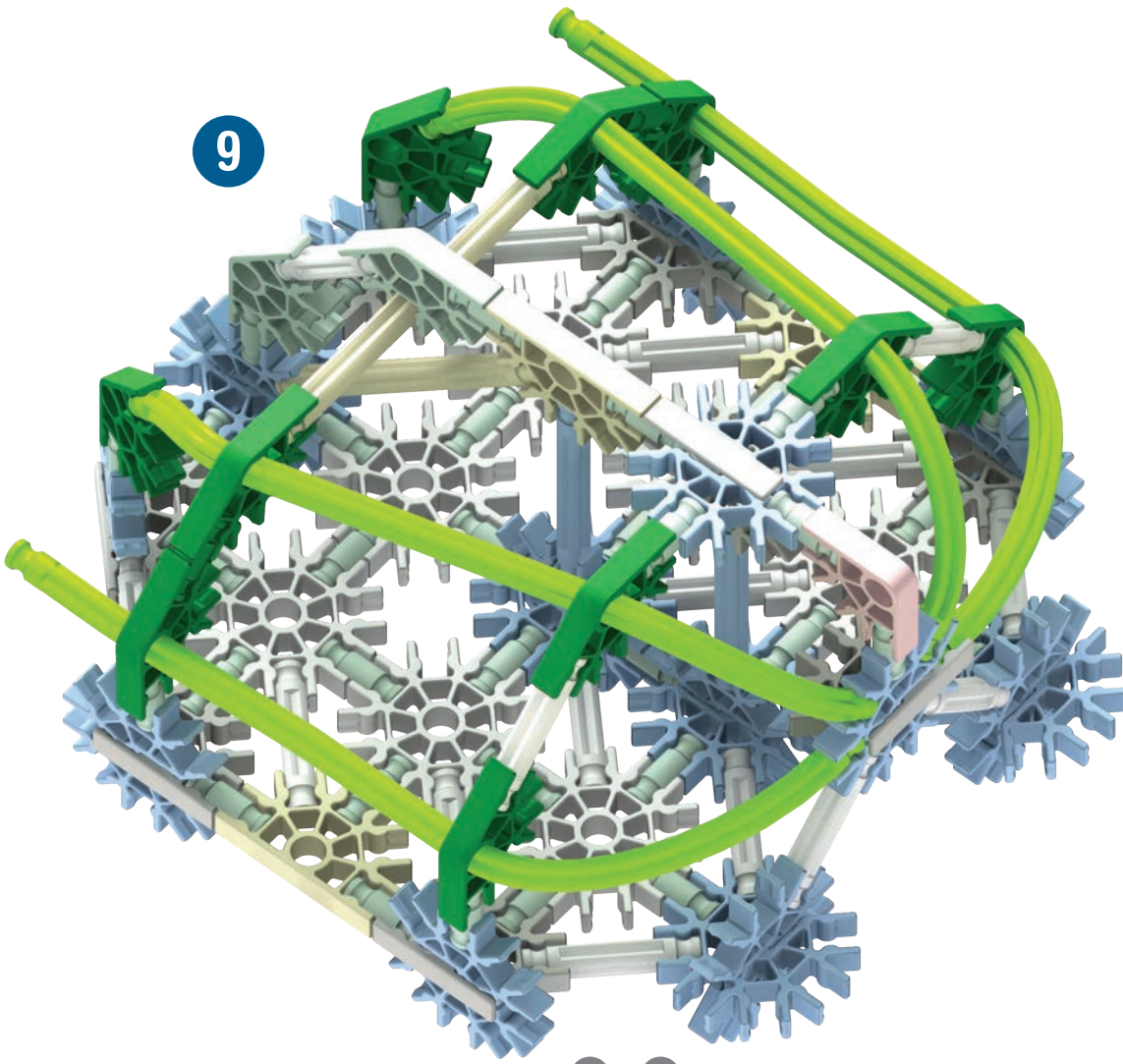

1 - 8

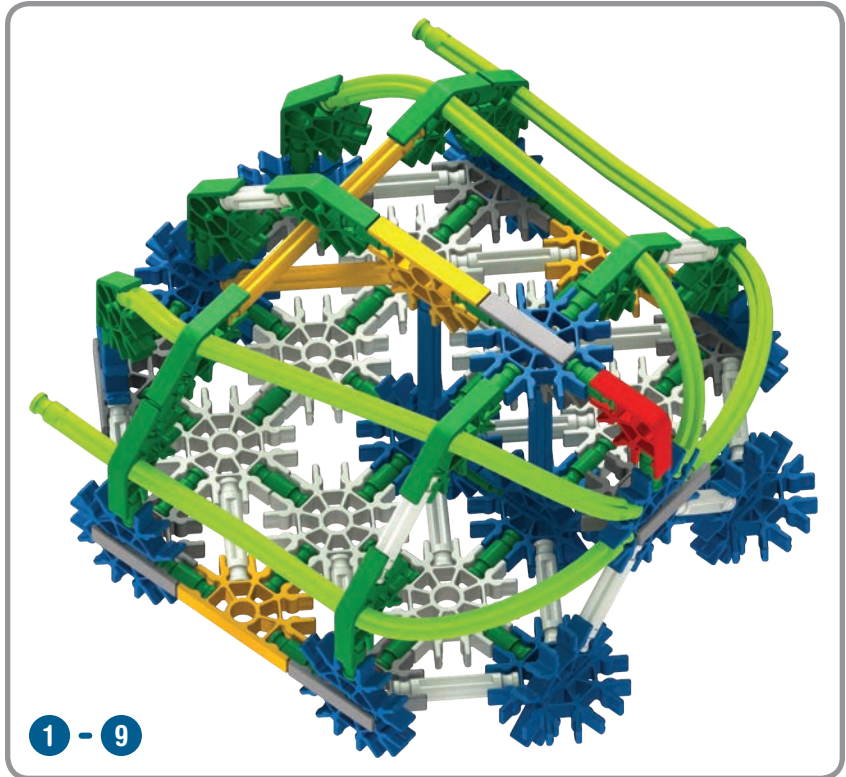
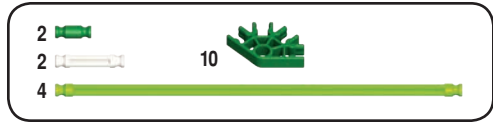

1 - 9

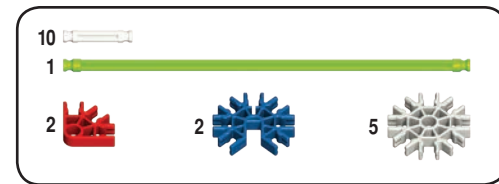
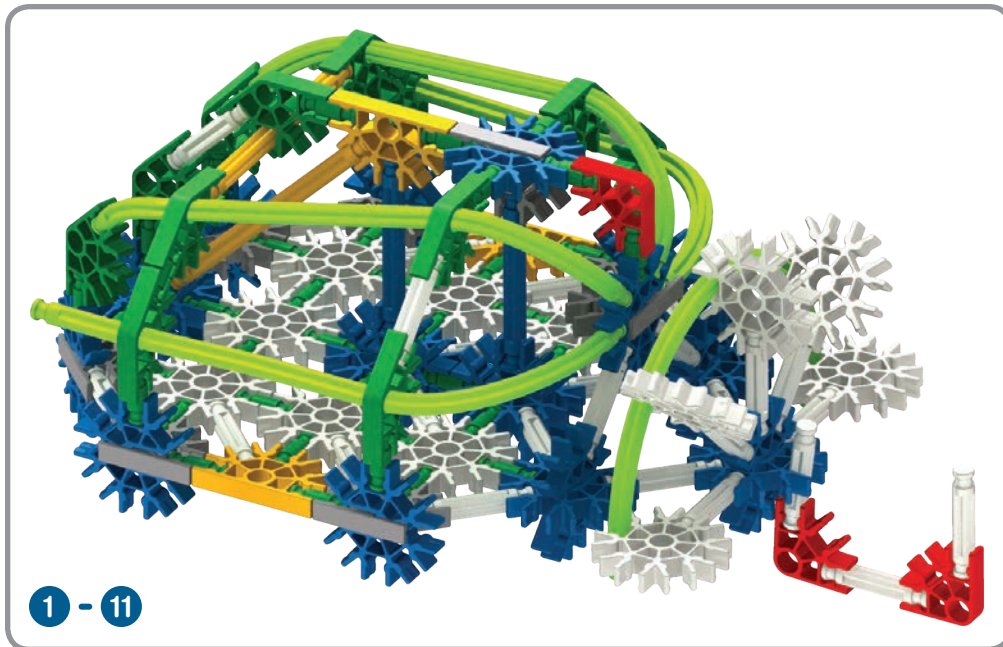
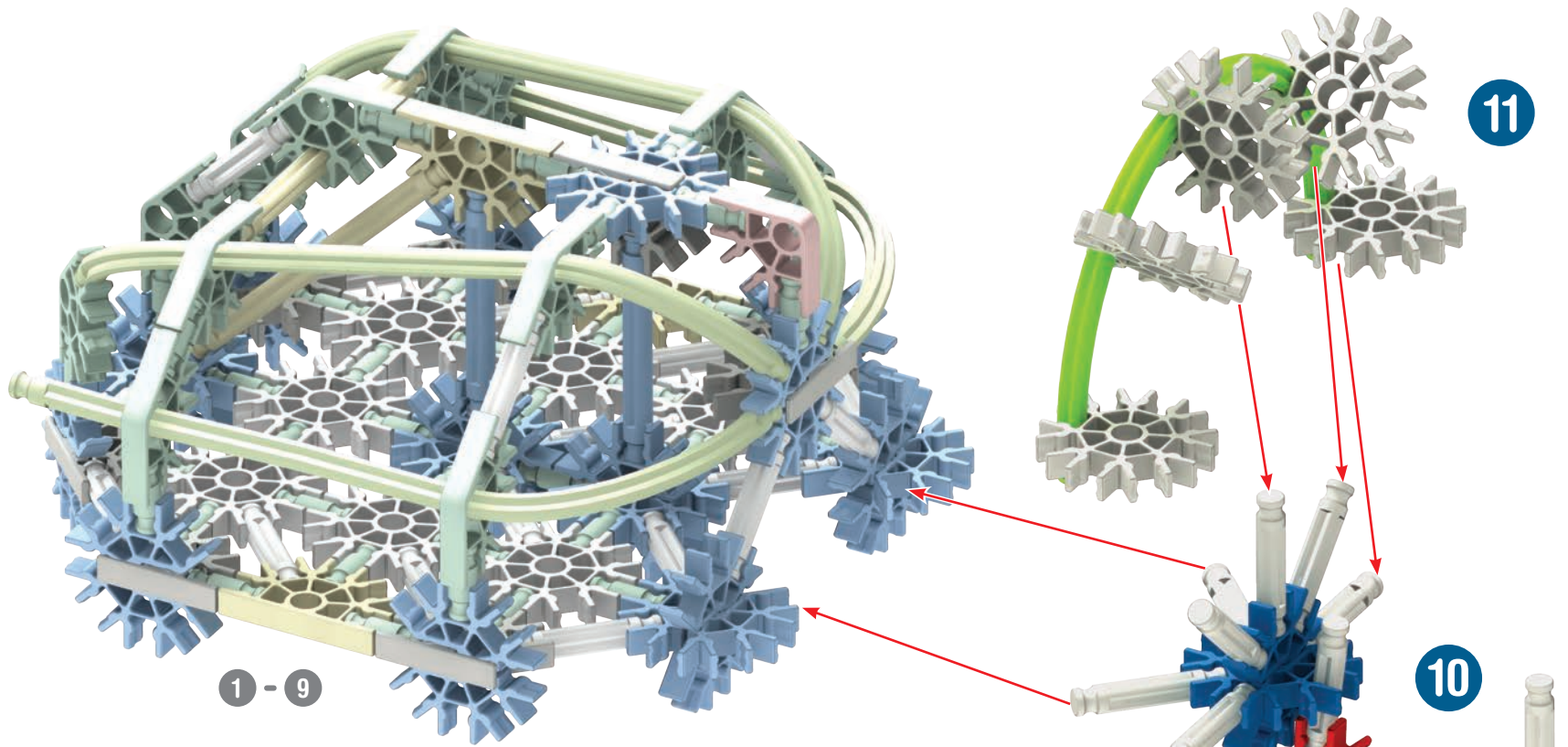

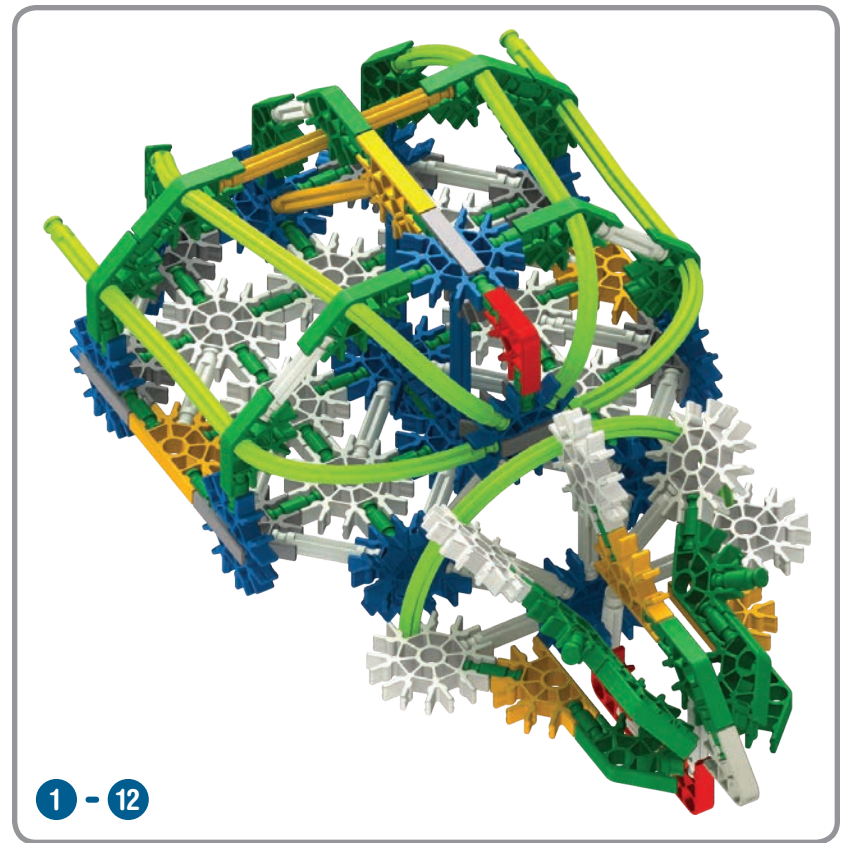
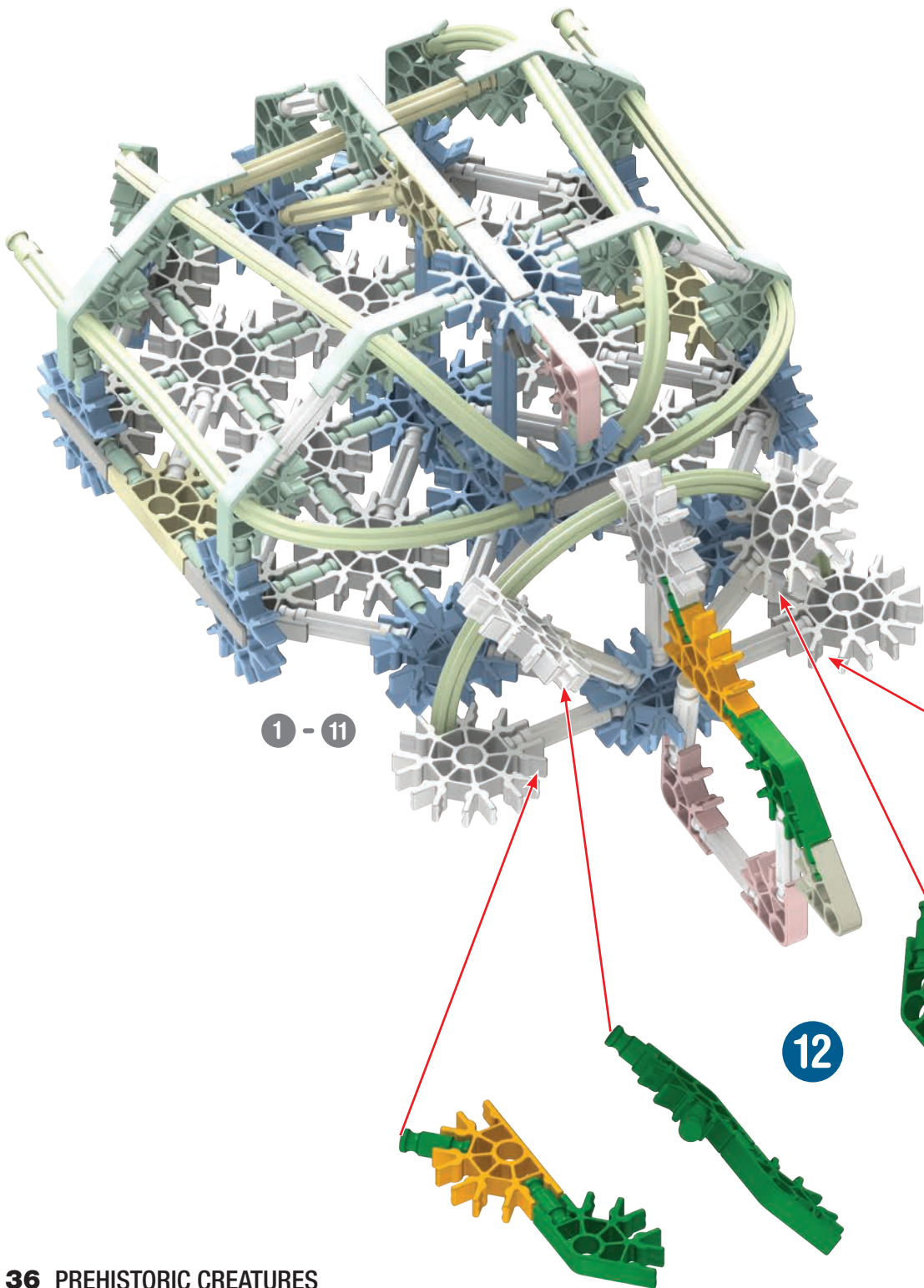

13		3	
1		7	

12

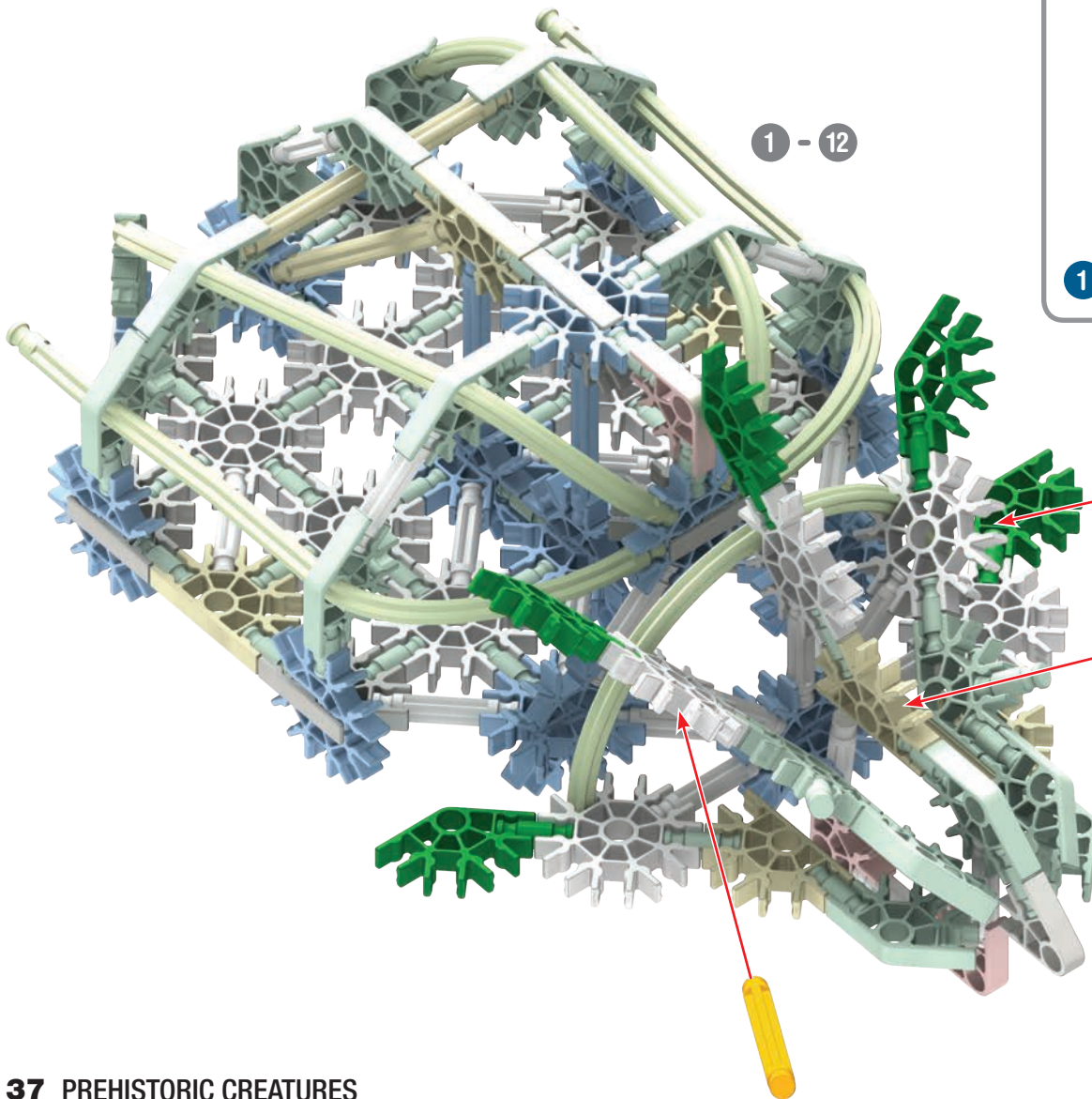

1 - 12

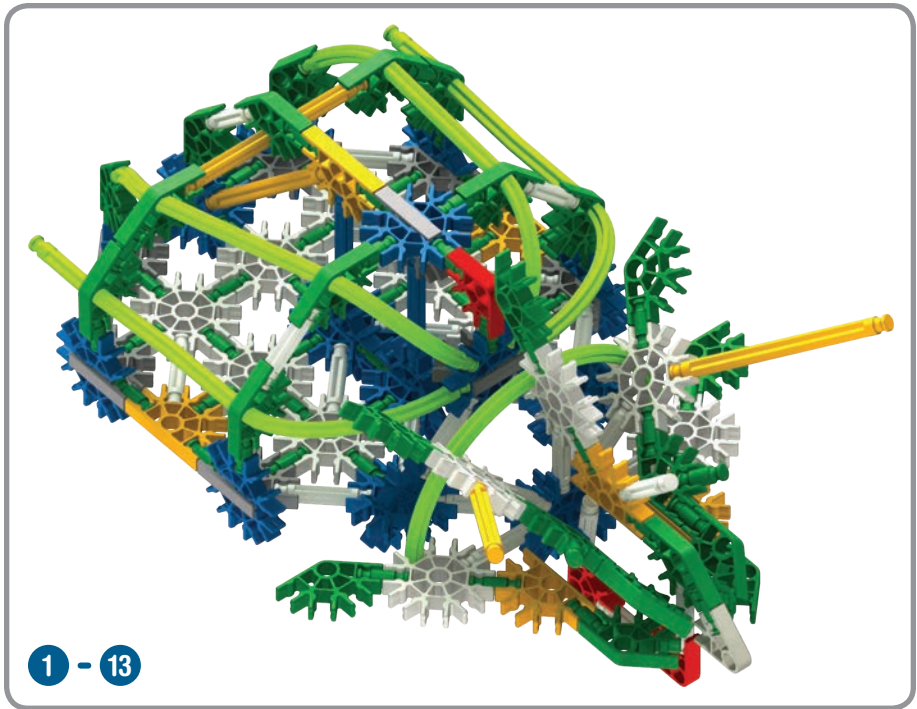

1 - 13

- | | | | |
|---|--|---|--|
| 5 | | 5 | |
| 1 | | | |
| 2 | | | |

13

1 - 13

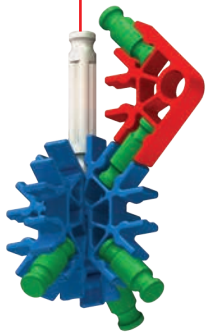
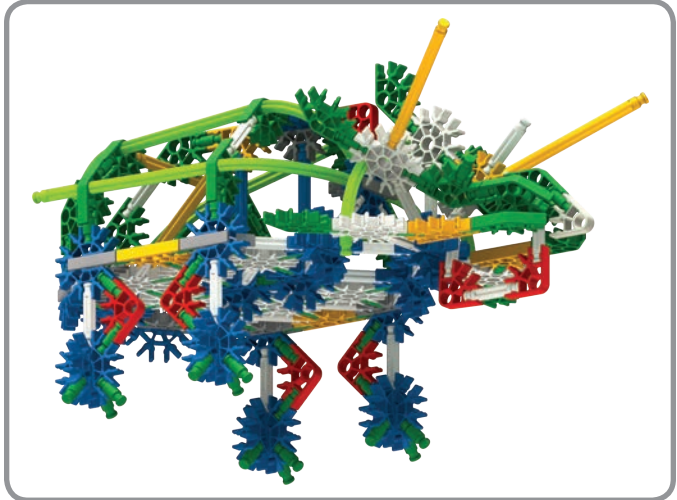
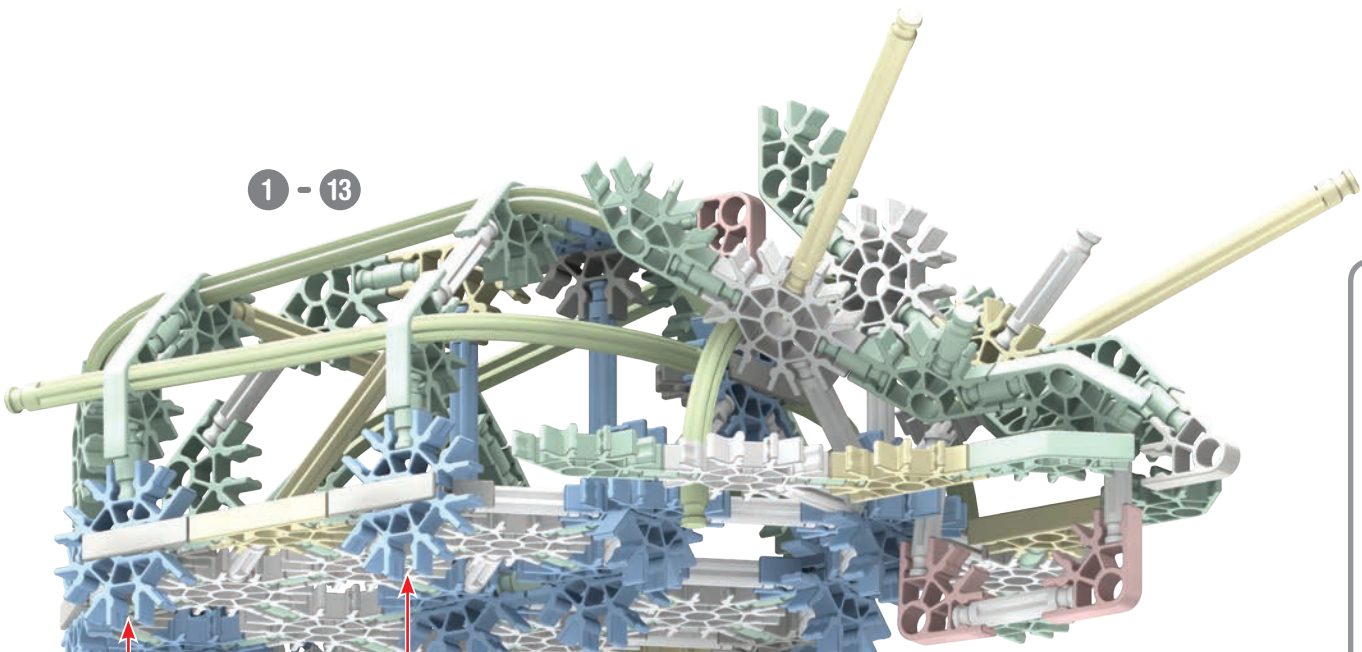

14

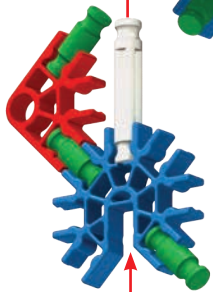

15

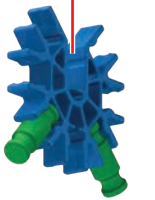

Triceratops

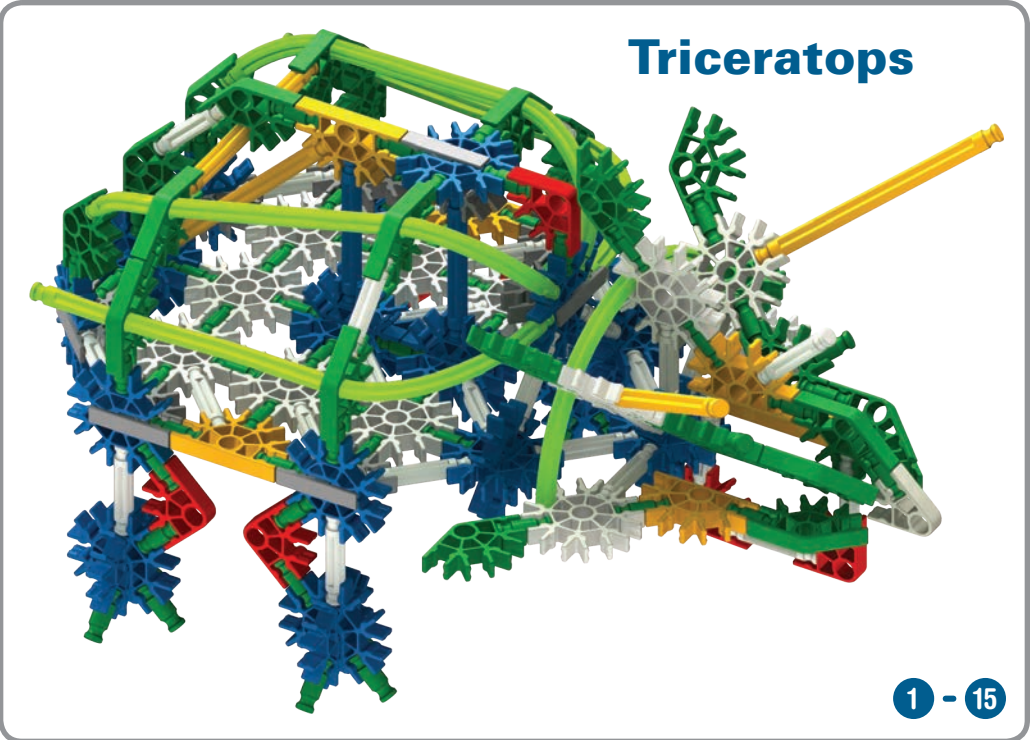

1 - 15

Woolly Mammoth

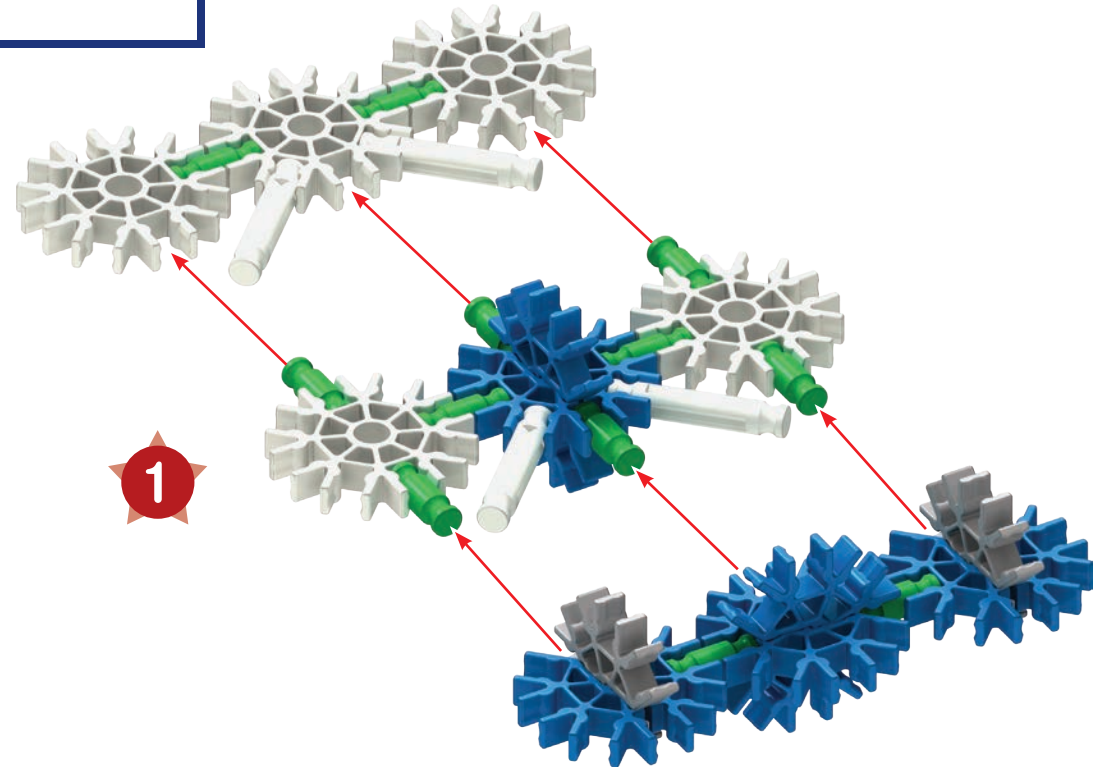
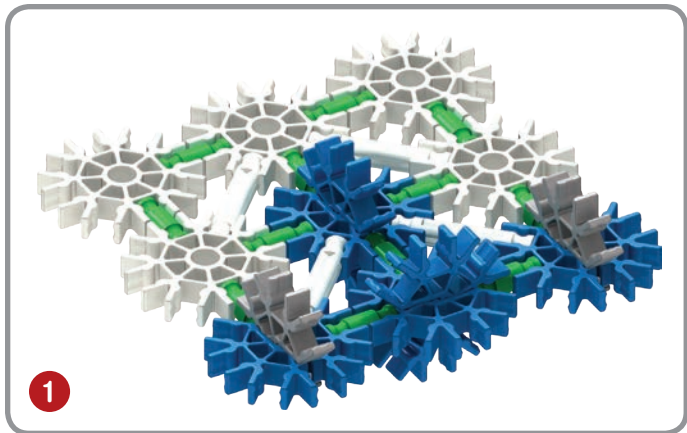
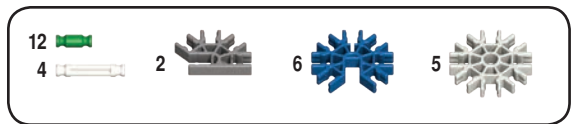

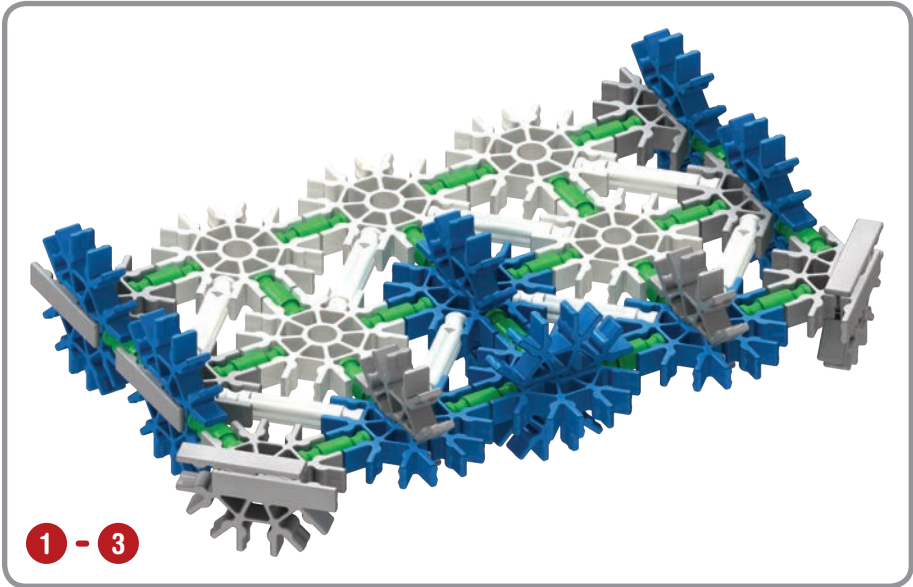
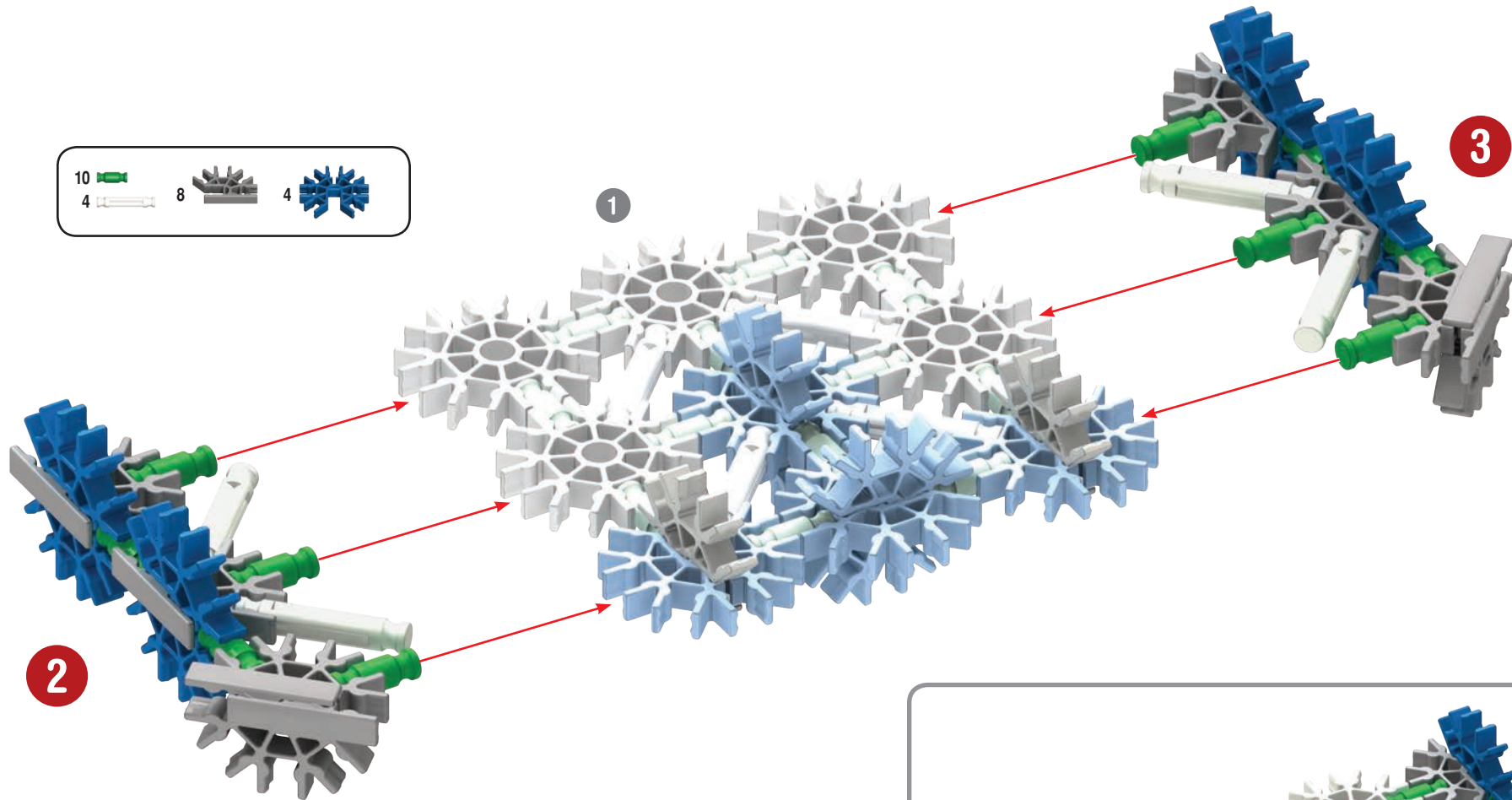

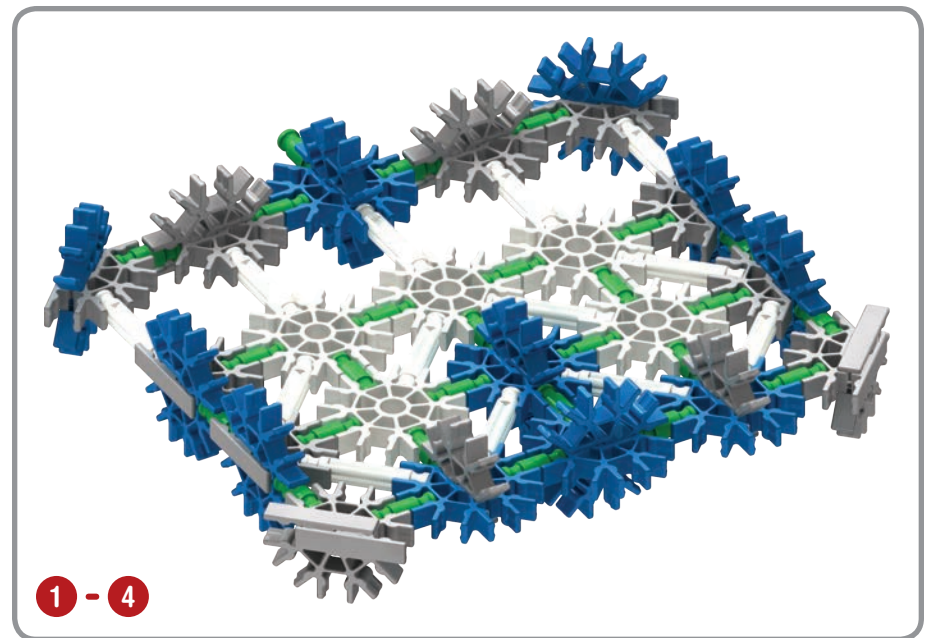
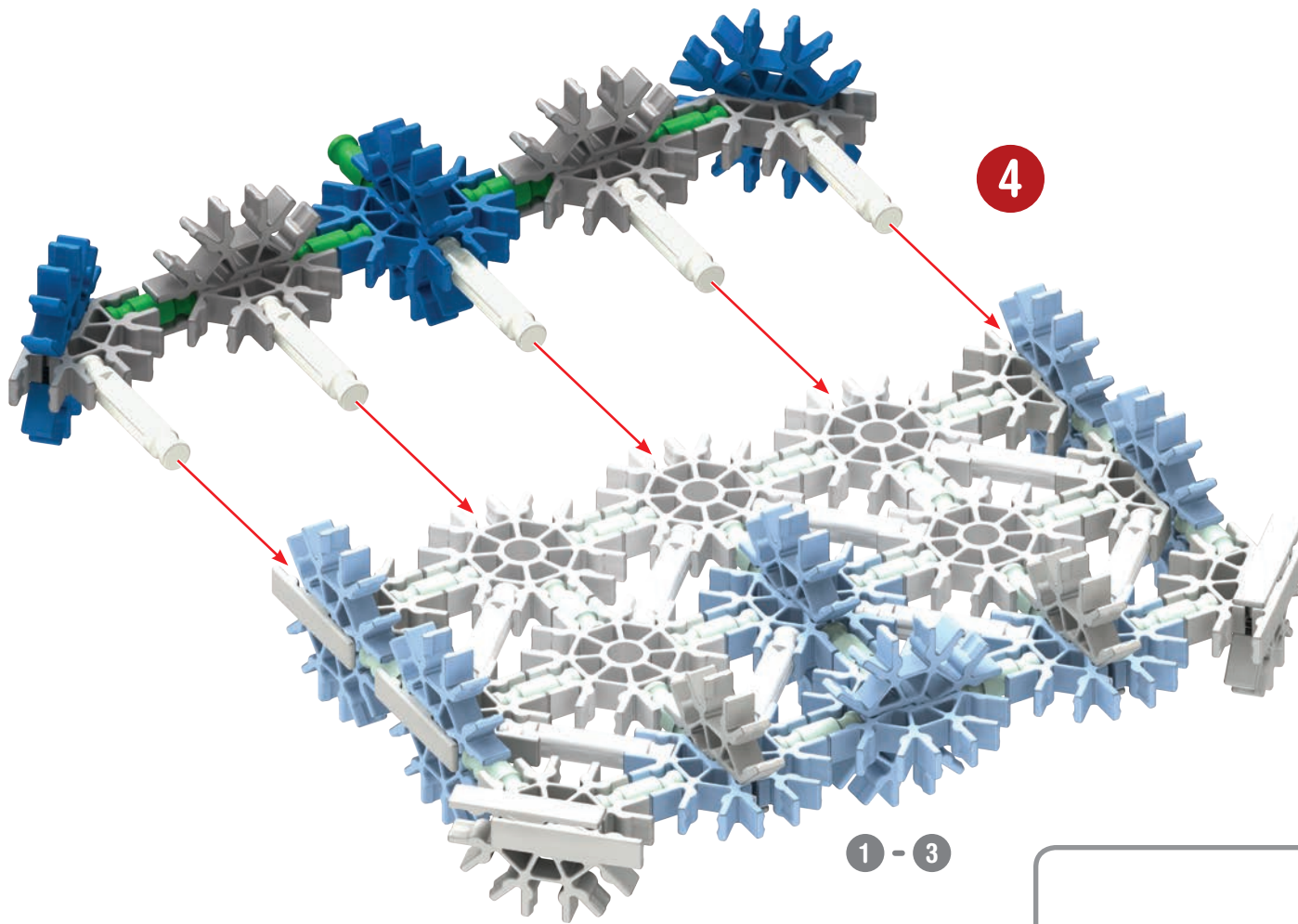

1 - 4

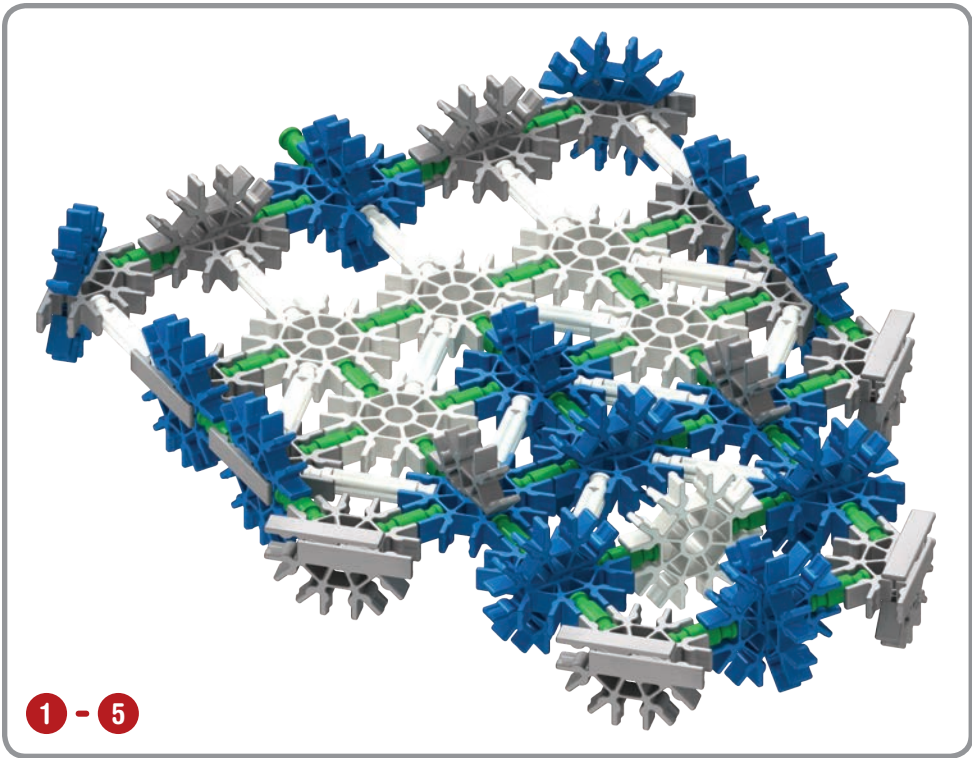
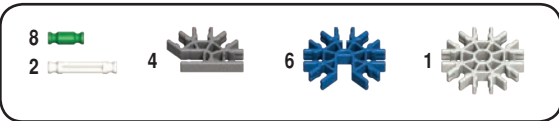
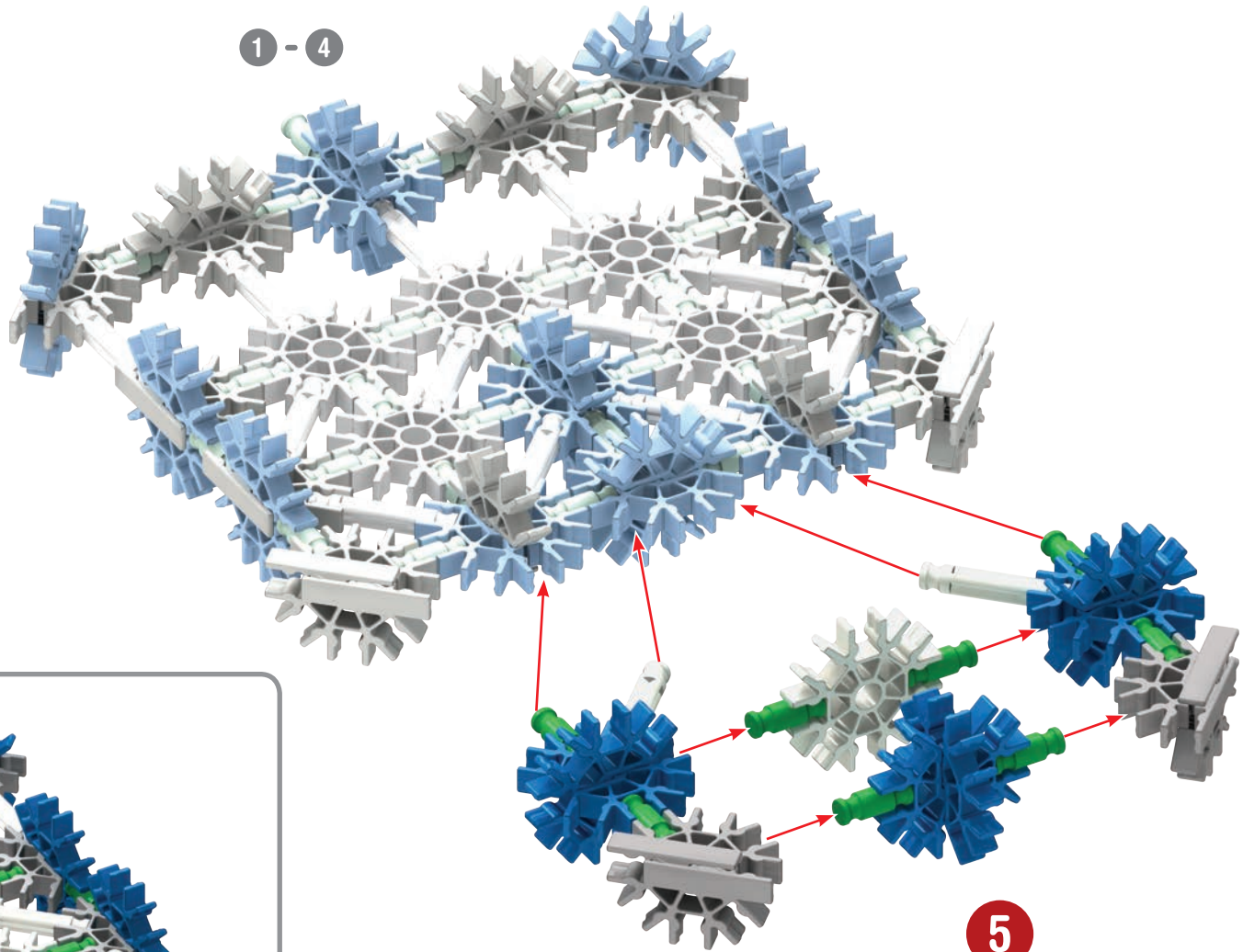

1 - 5

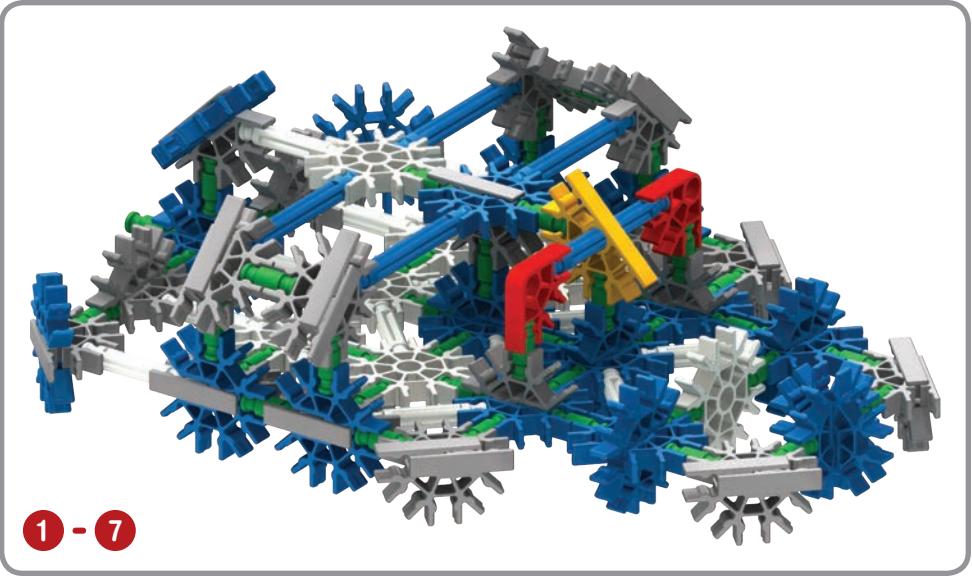
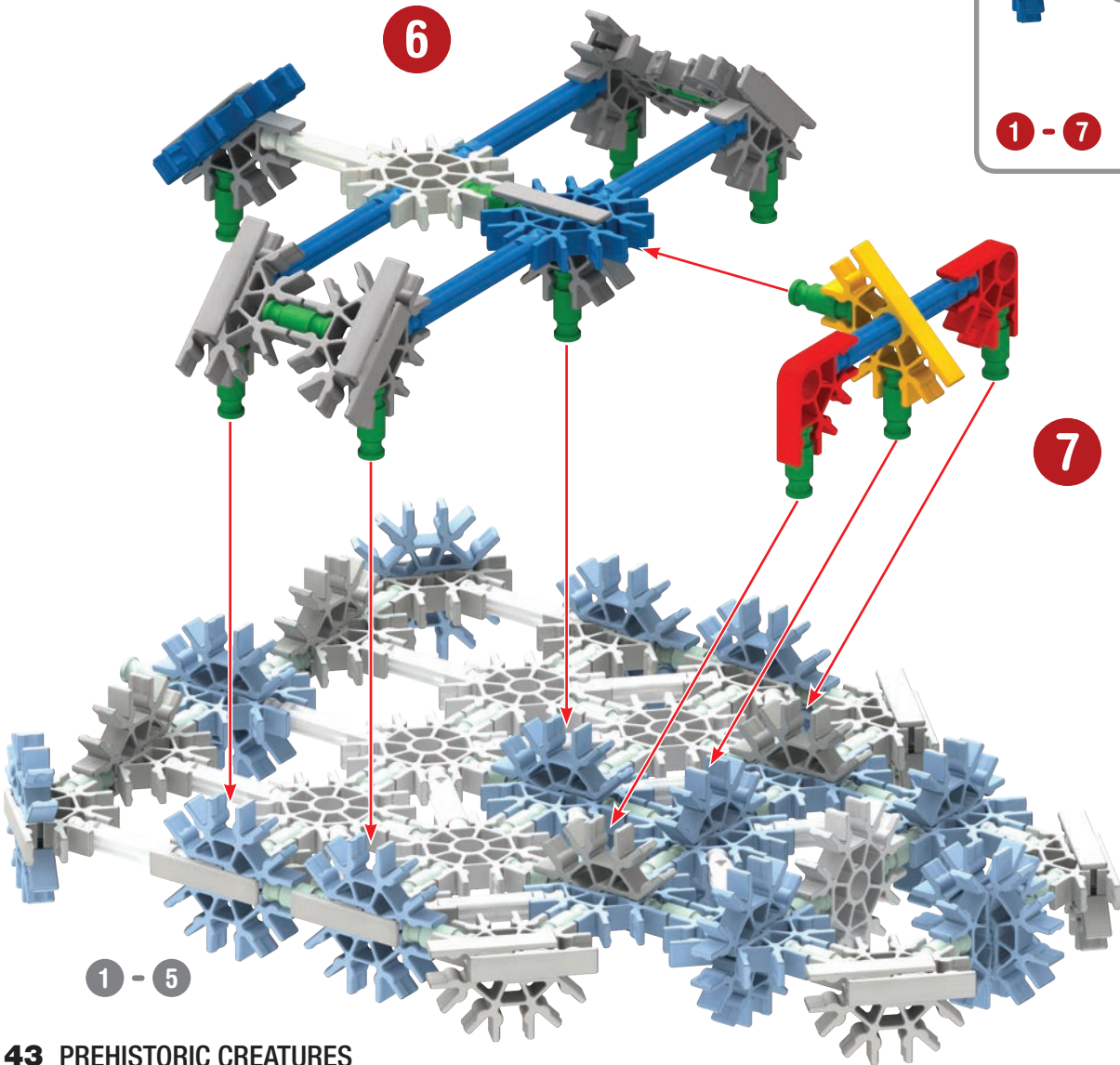

13		2		1	
1					
5					
10		2		1	

1 - 5

7

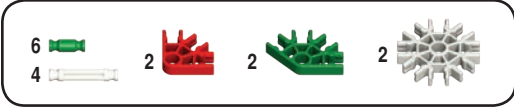
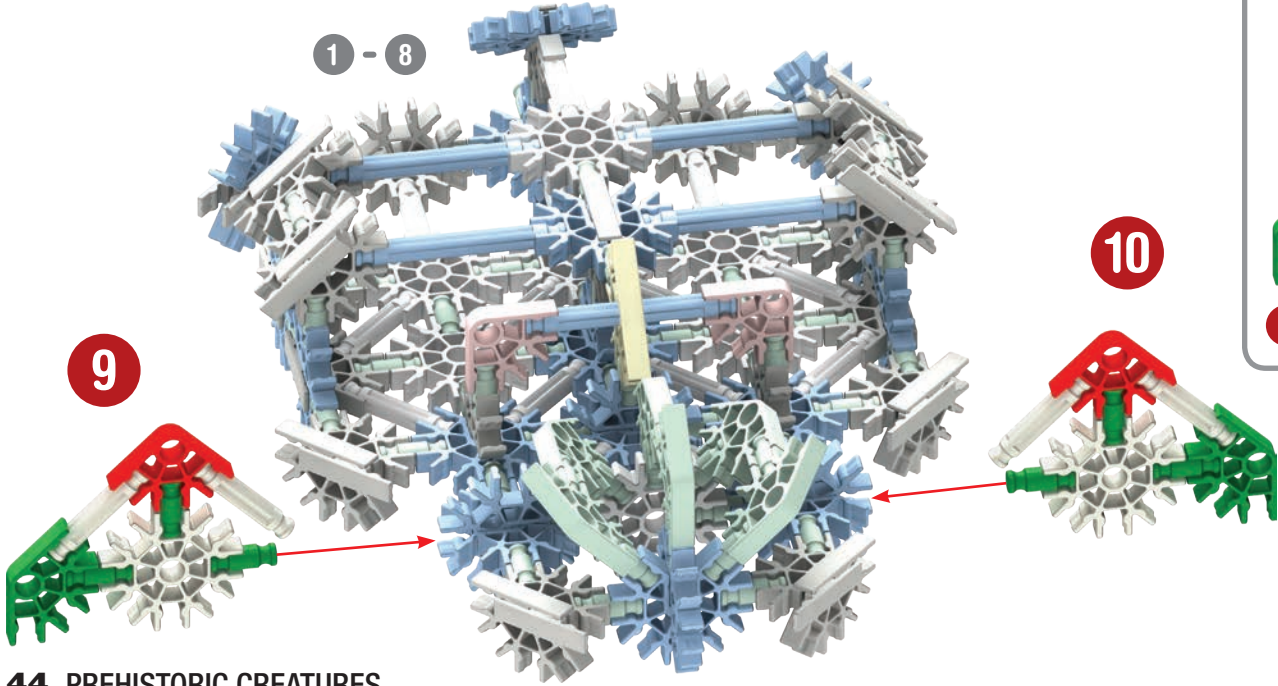
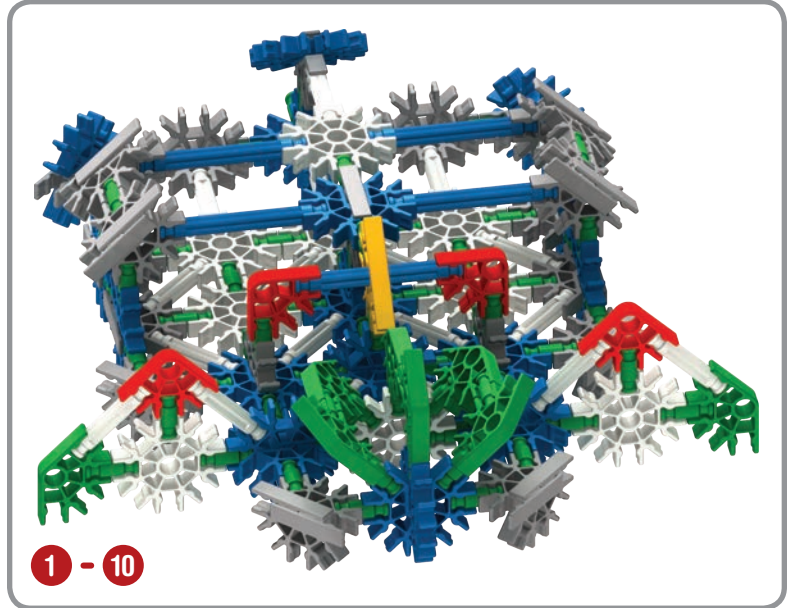
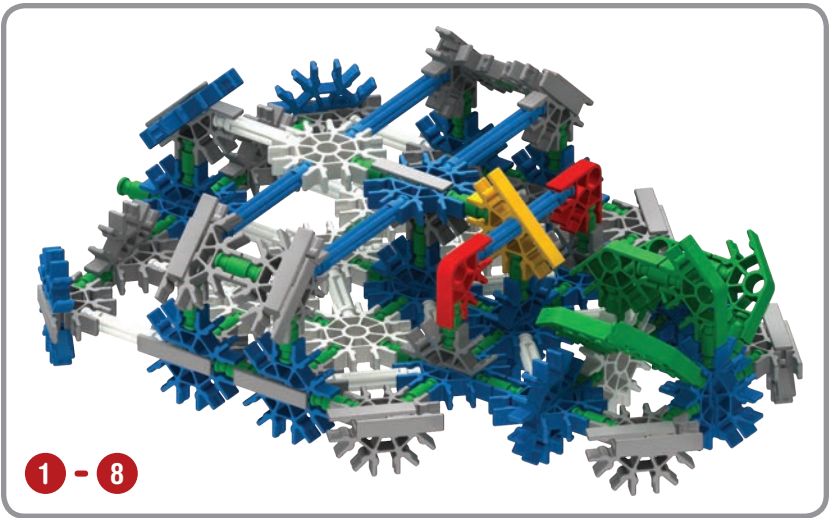
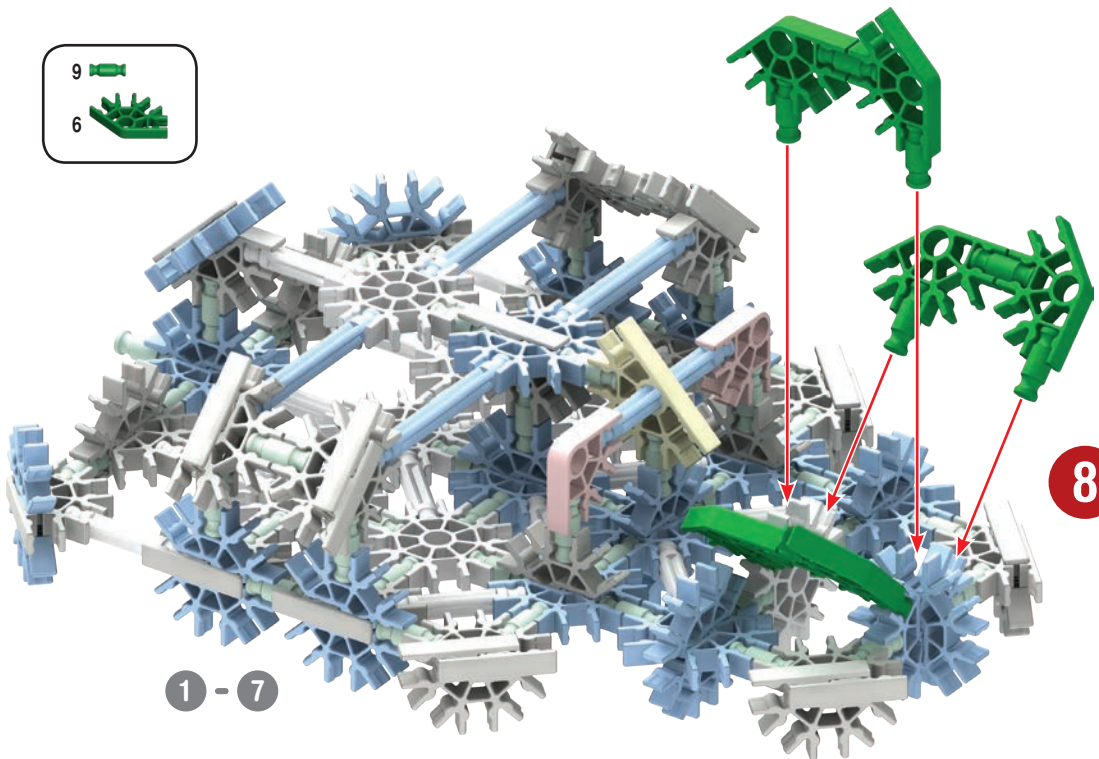
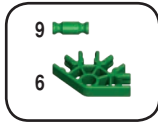

11

x2

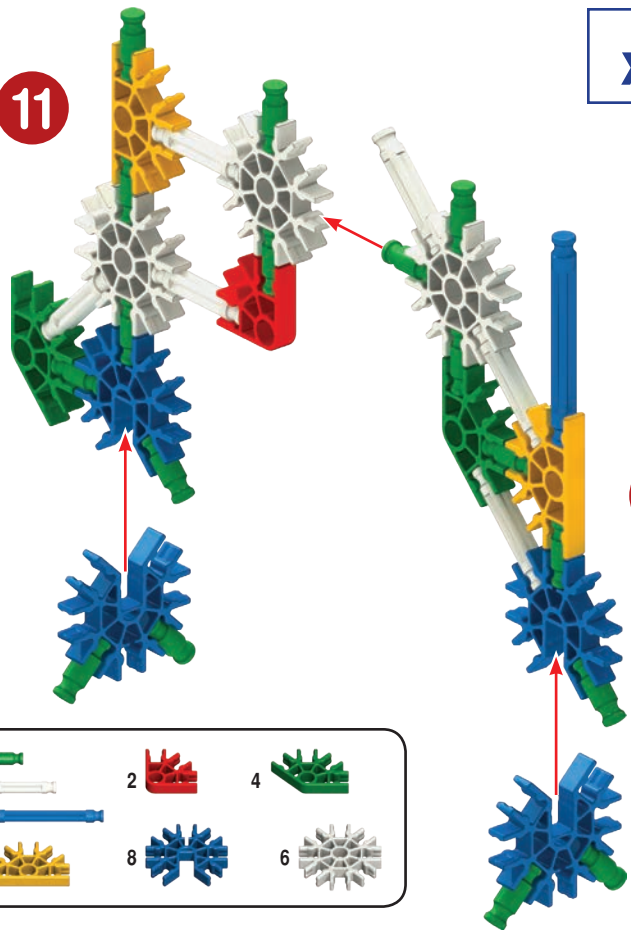

12

34	2	4
12	2	4
2	8	6
4		

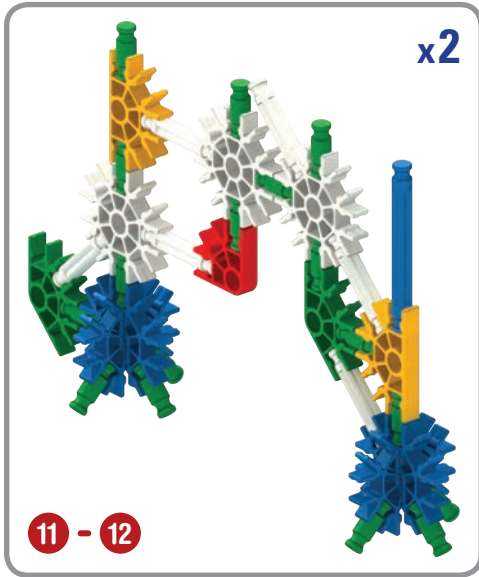

11 - 12

x2

1 - 10

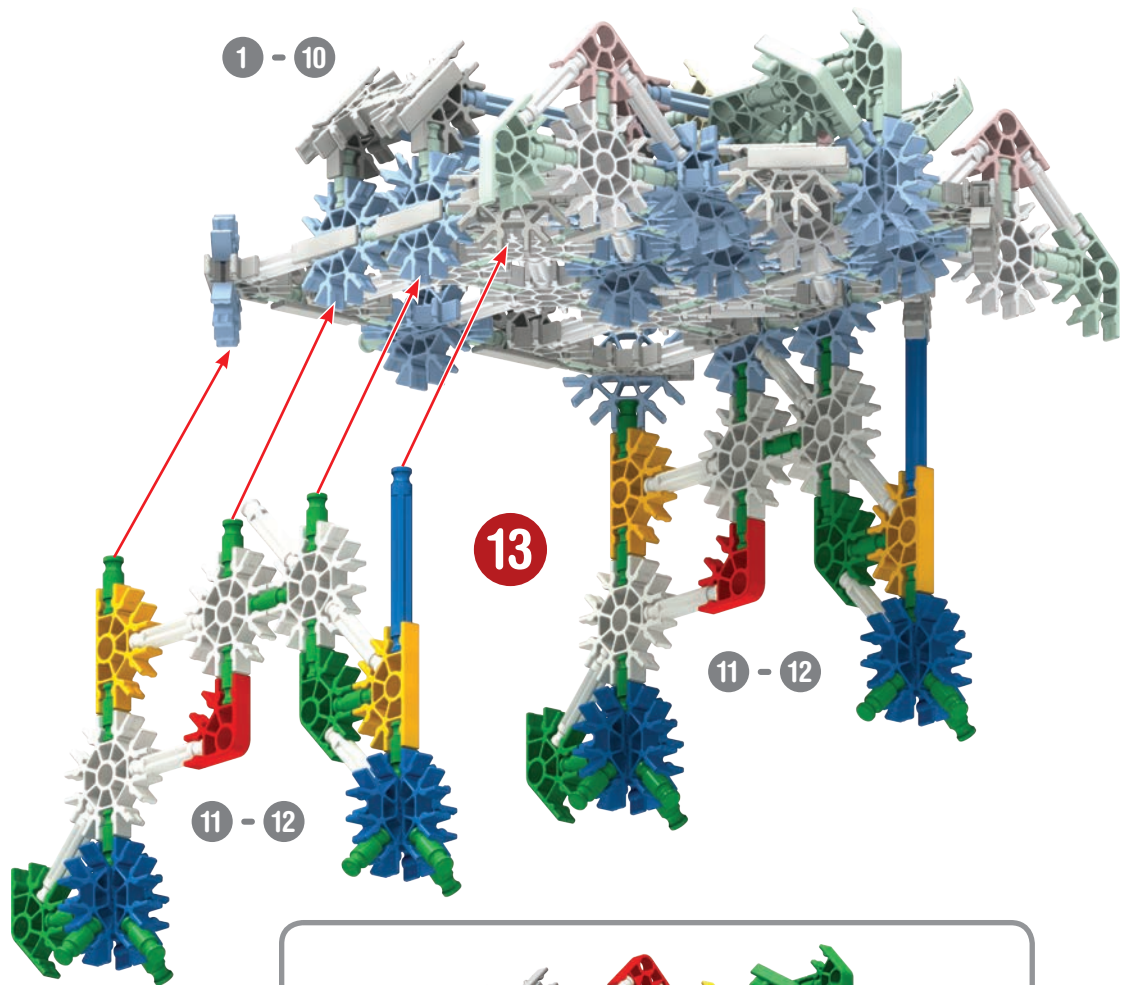

13

11 - 12

11 - 12

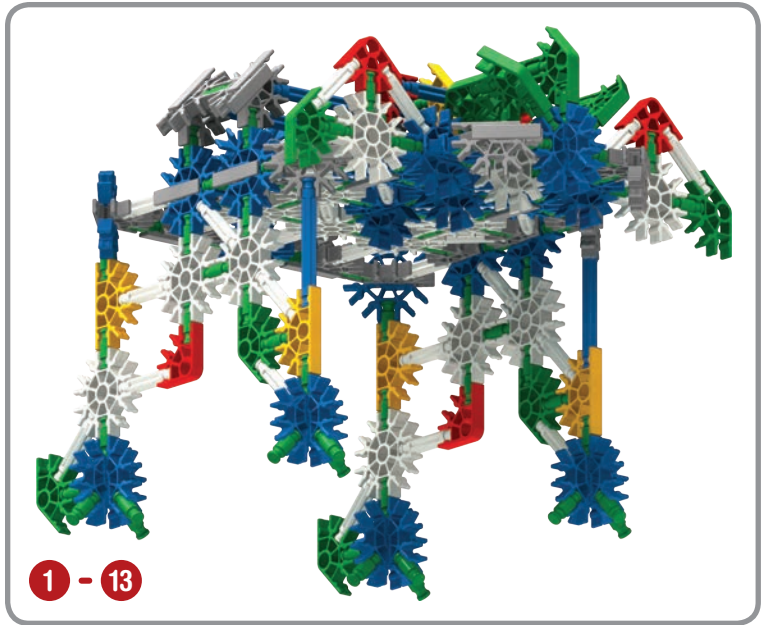

1 - 13

TIP: For this section of the model, it is easier to connect the rods to the connectors by pushing them from the side.

