

12605

K'NEX

**100 MODEL
IMAGINE
BUILDING SET**

**AIR
MODELS**

Flying Machine
page 1



Hang Glider
page 15

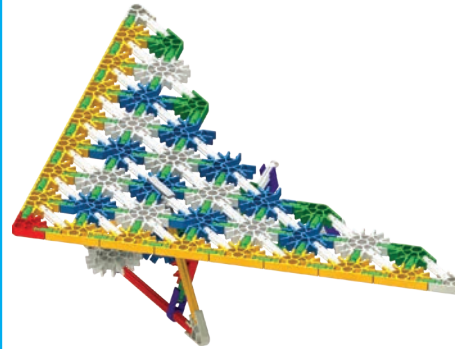

Helicopter
page 17

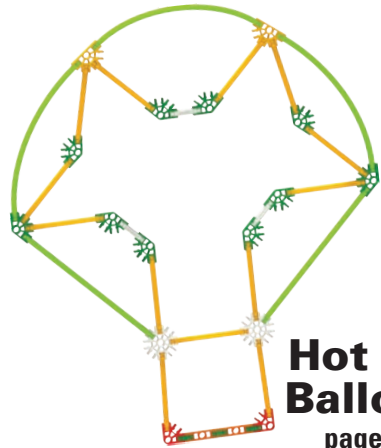

**Hot Air
Balloon**
page 21

Plane
page 22

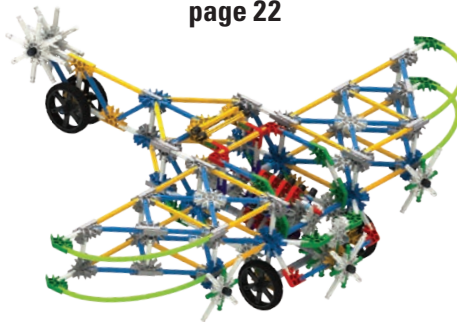

Space Jet
page 41

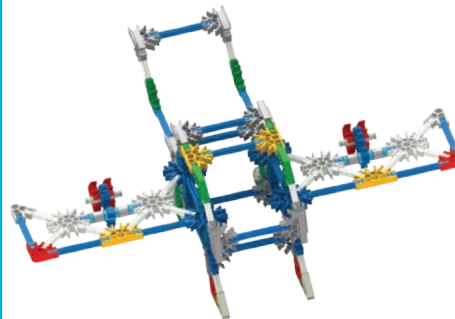

UFO
page 46



Flying Machine

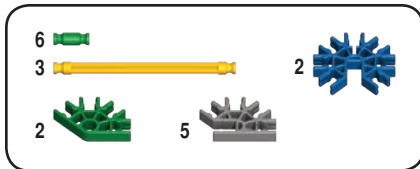
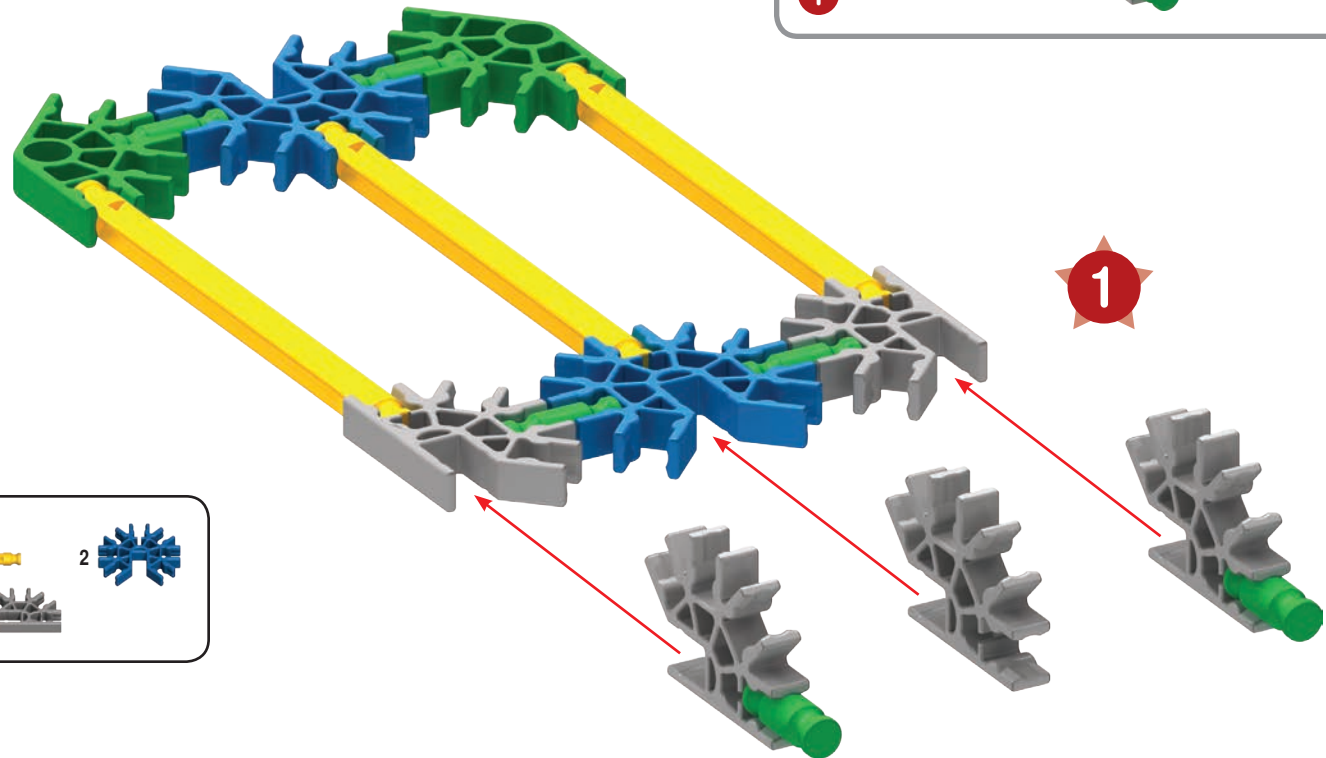
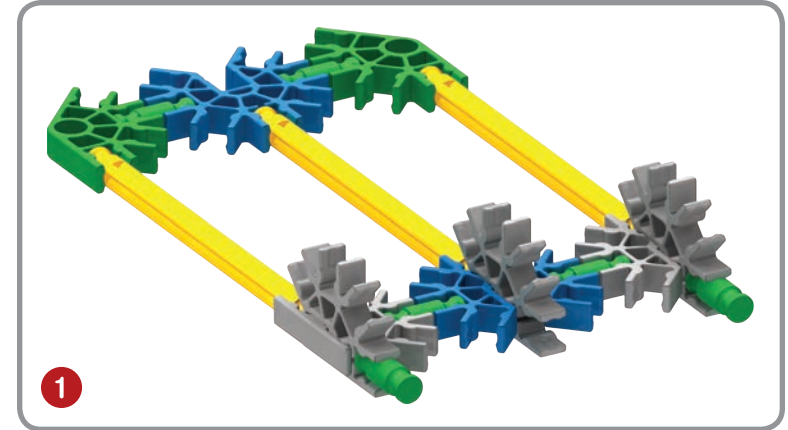

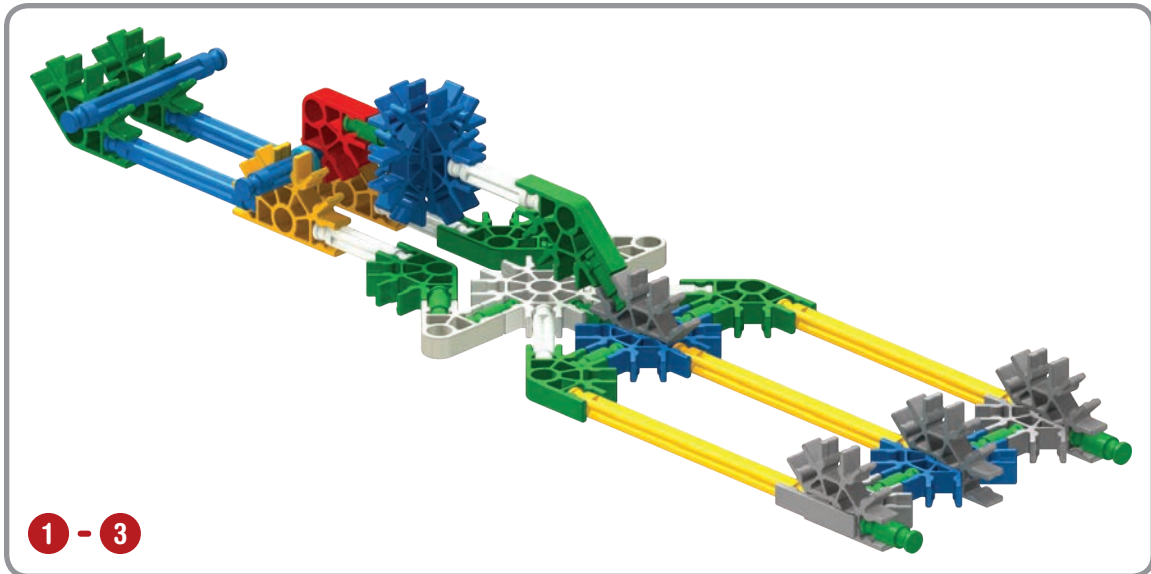
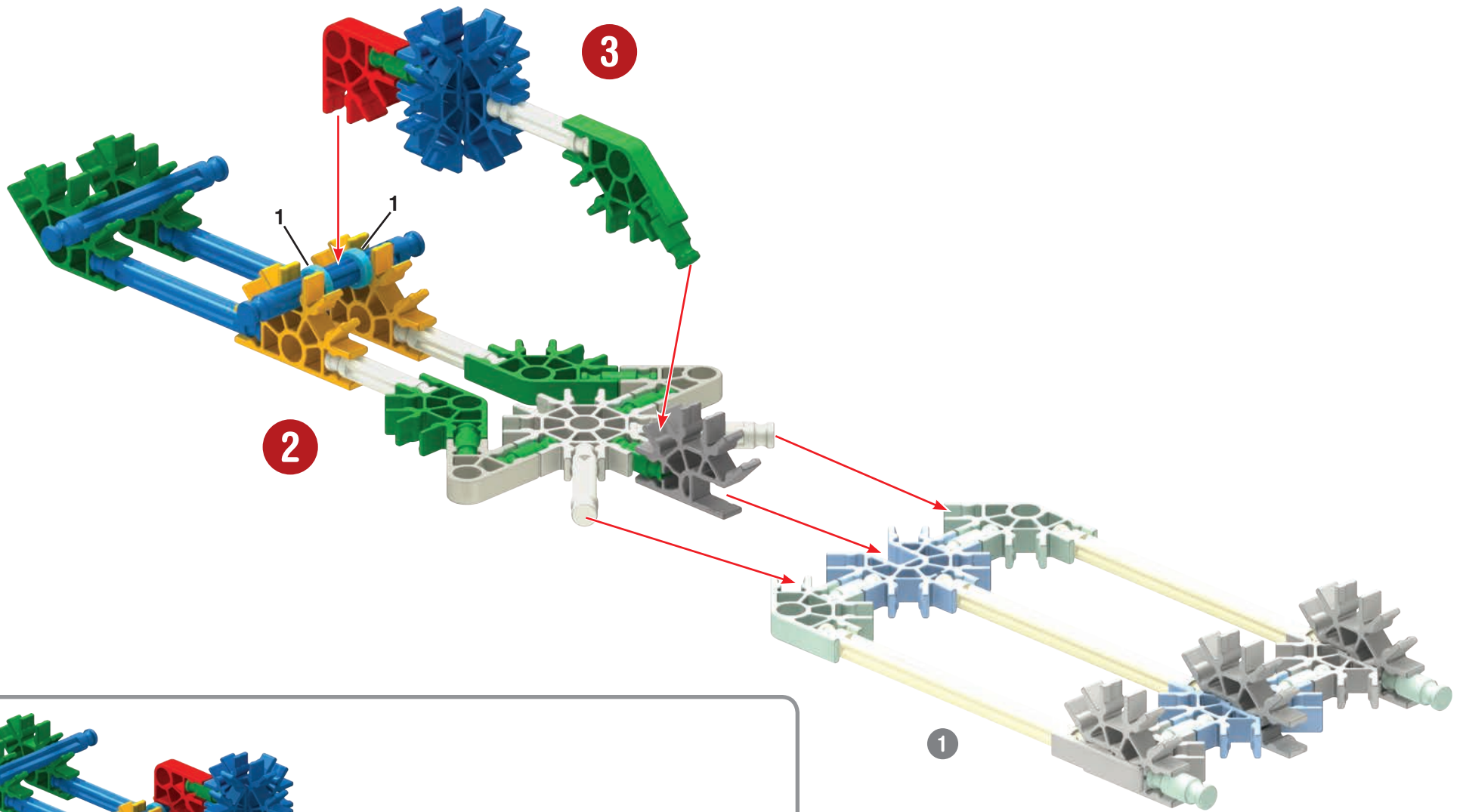

- | | | | | | | | | | |
|---|--|---|--|---|--|---|--|---|--|
| 7 | | 2 | | 2 | | 1 | | 5 | |
| 5 | | | | | | | | | |
| 4 | | | | | | | | | |
| 2 | | 1 | | 2 | | 1 | | | |

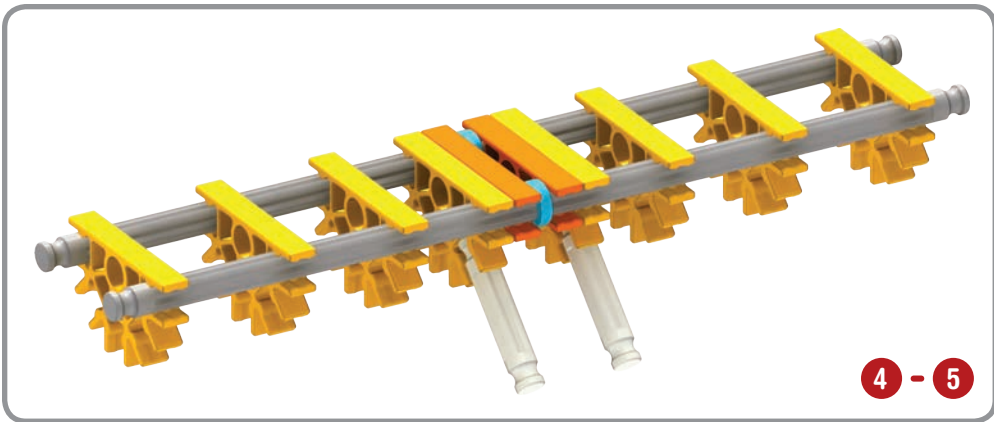
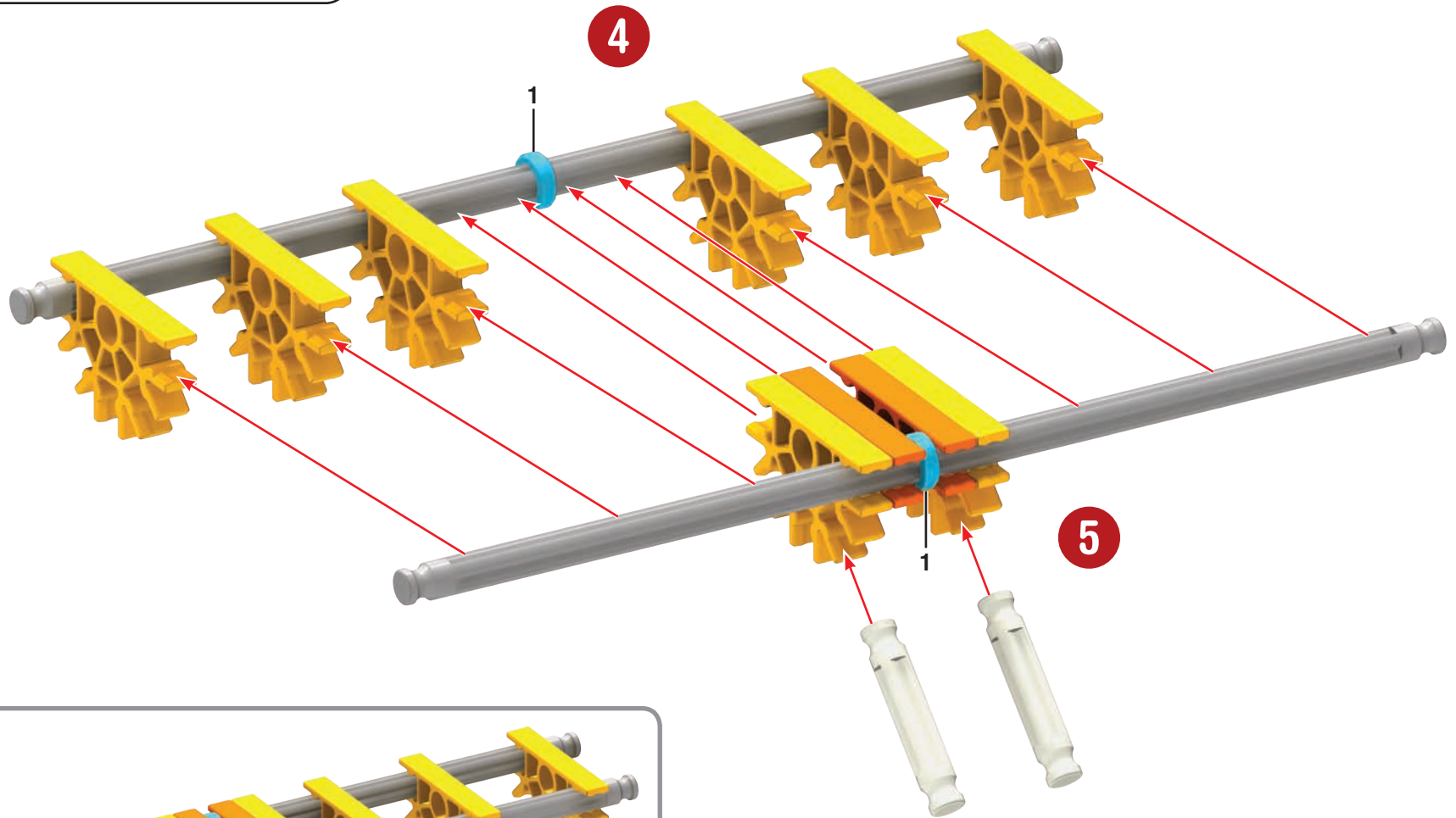
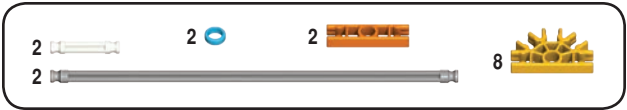

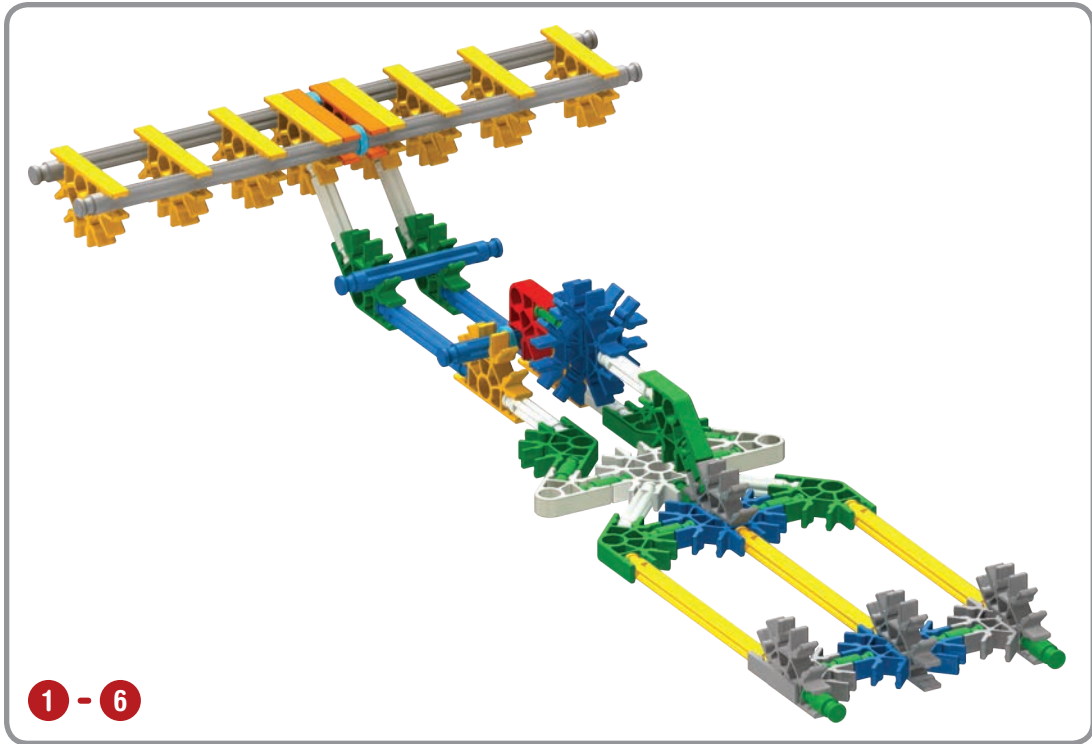
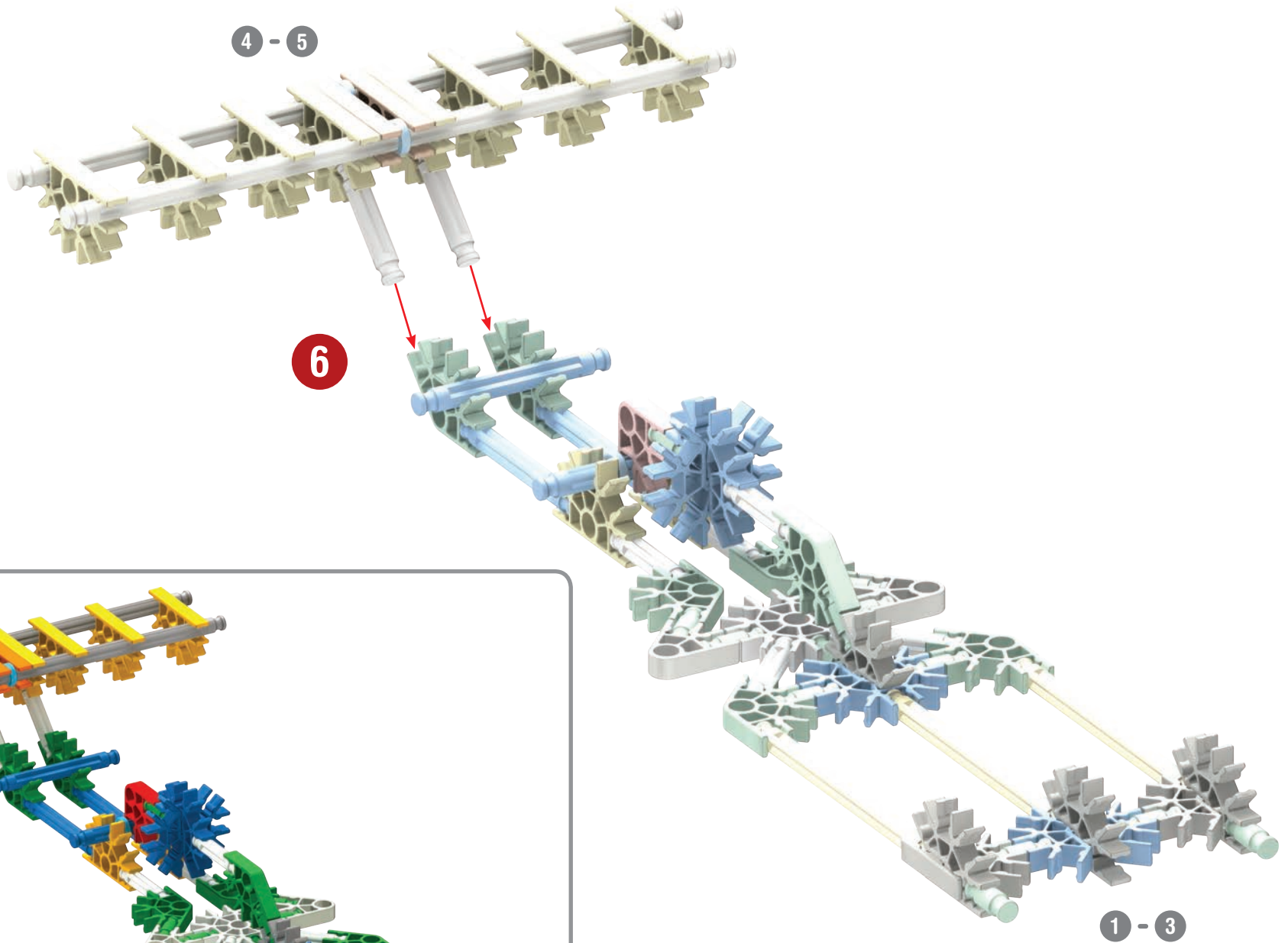

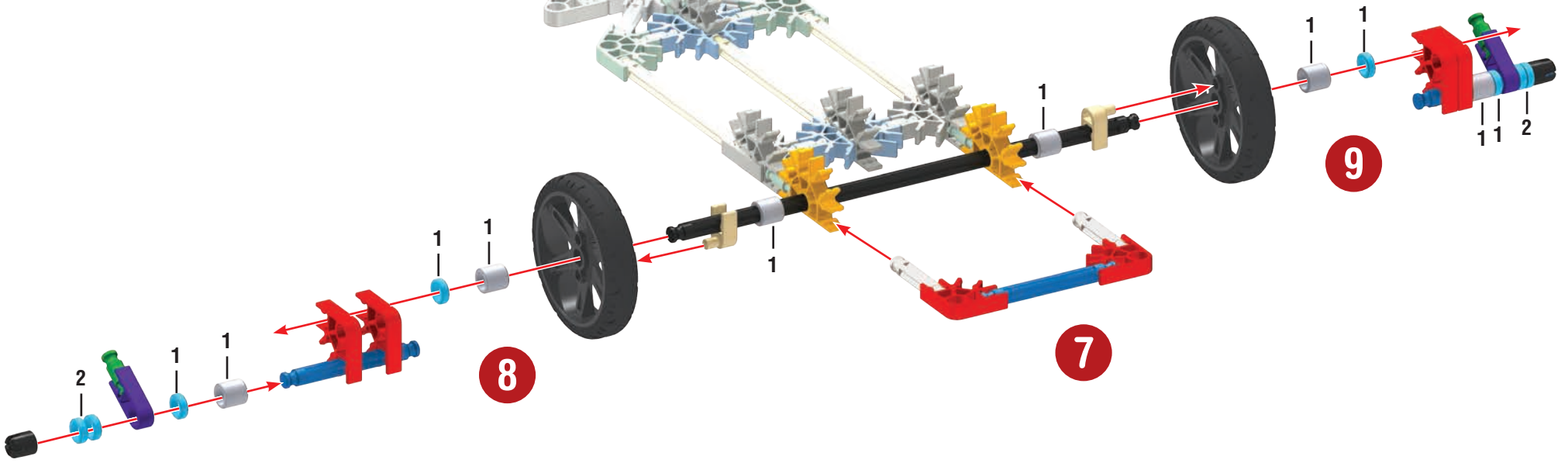
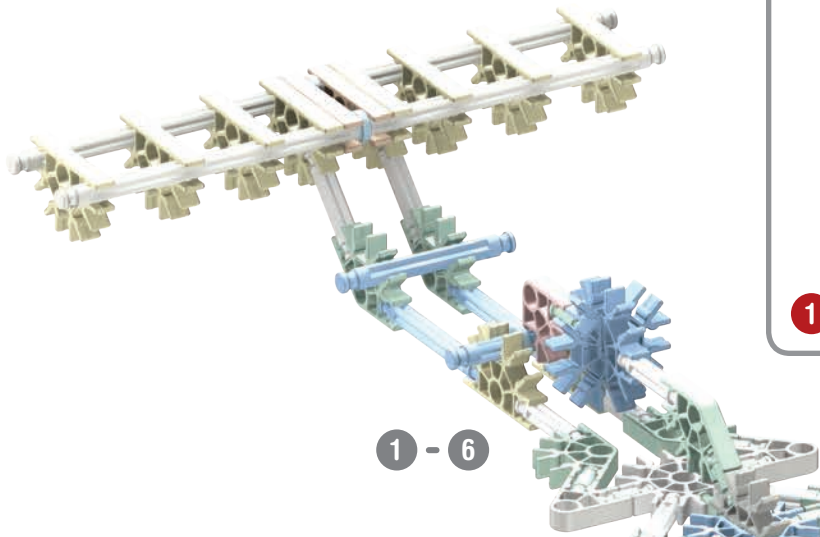
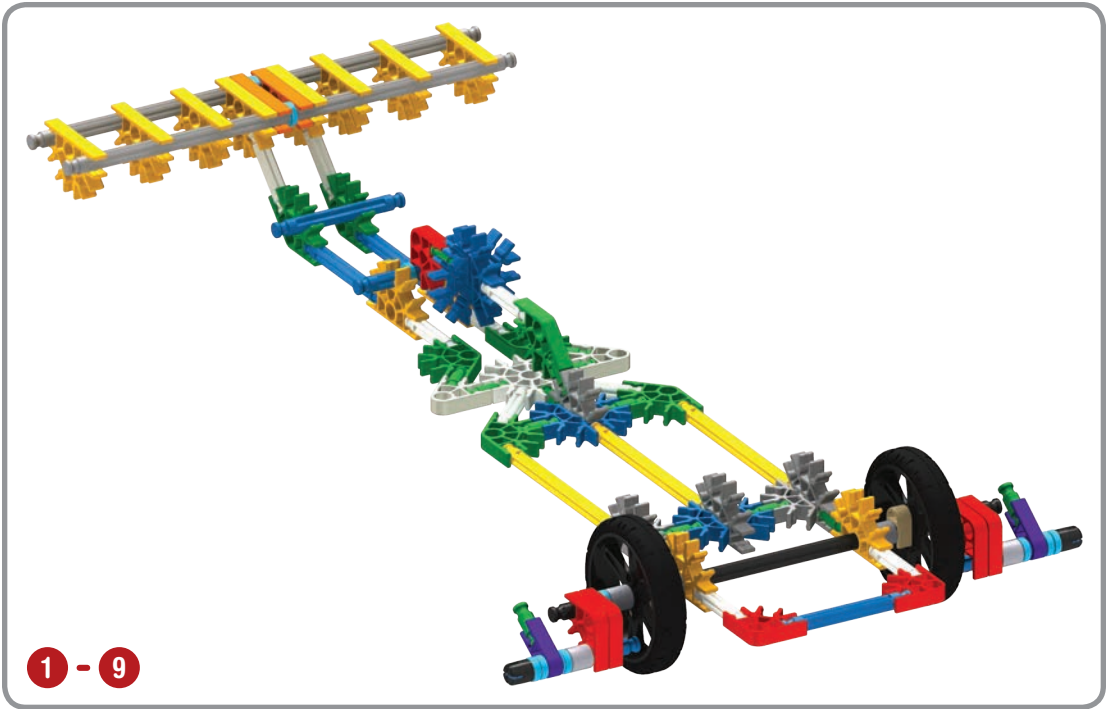
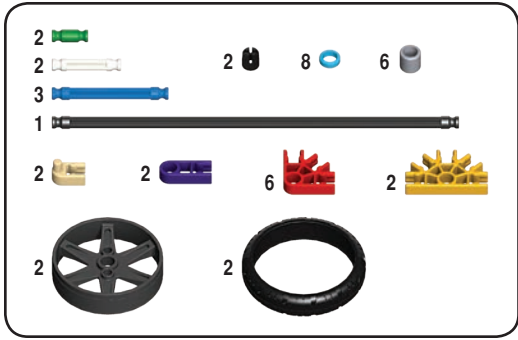

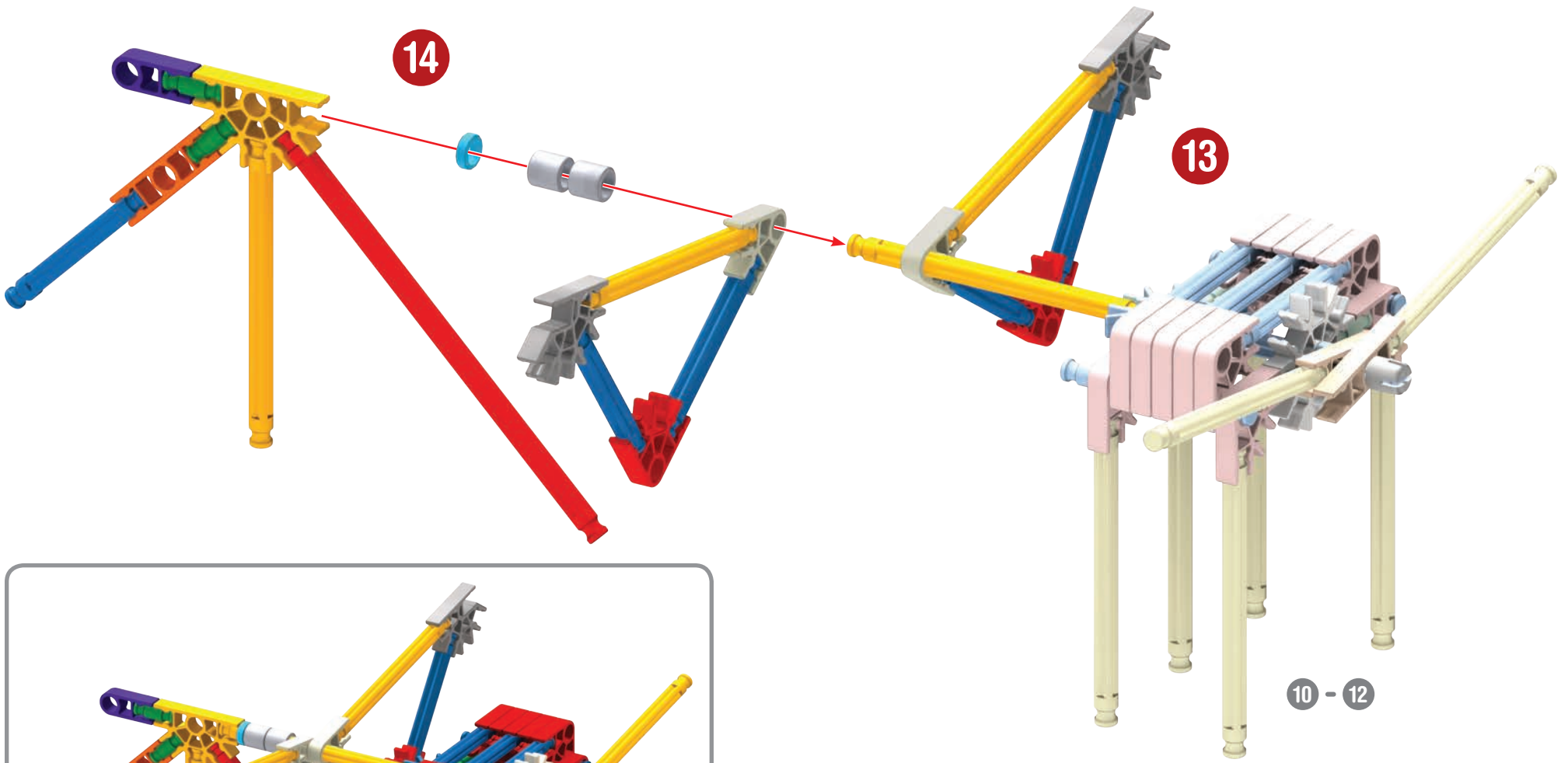

10 - 14

10 - 12

- | | | | | | | | |
|---|--|---|--|---|--|---|--|
| 2 | | 1 | | 2 | | 1 | |
| 5 | | | | | | | |
| 4 | | | | | | 1 | |
| 1 | | | | | | | |
| 2 | | 2 | | 1 | | 2 | |

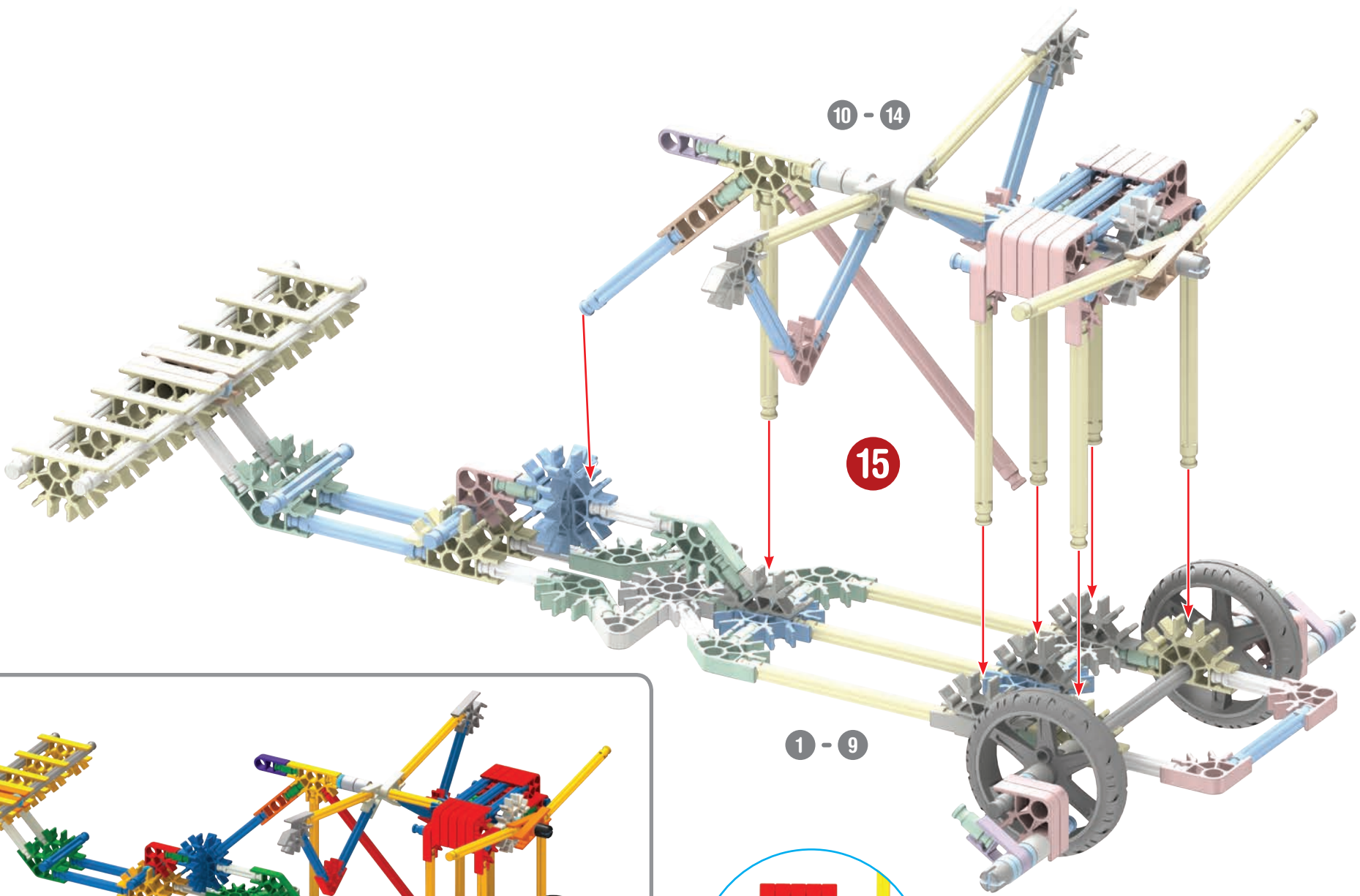

10 - 14

15

1 - 9



1 - 15

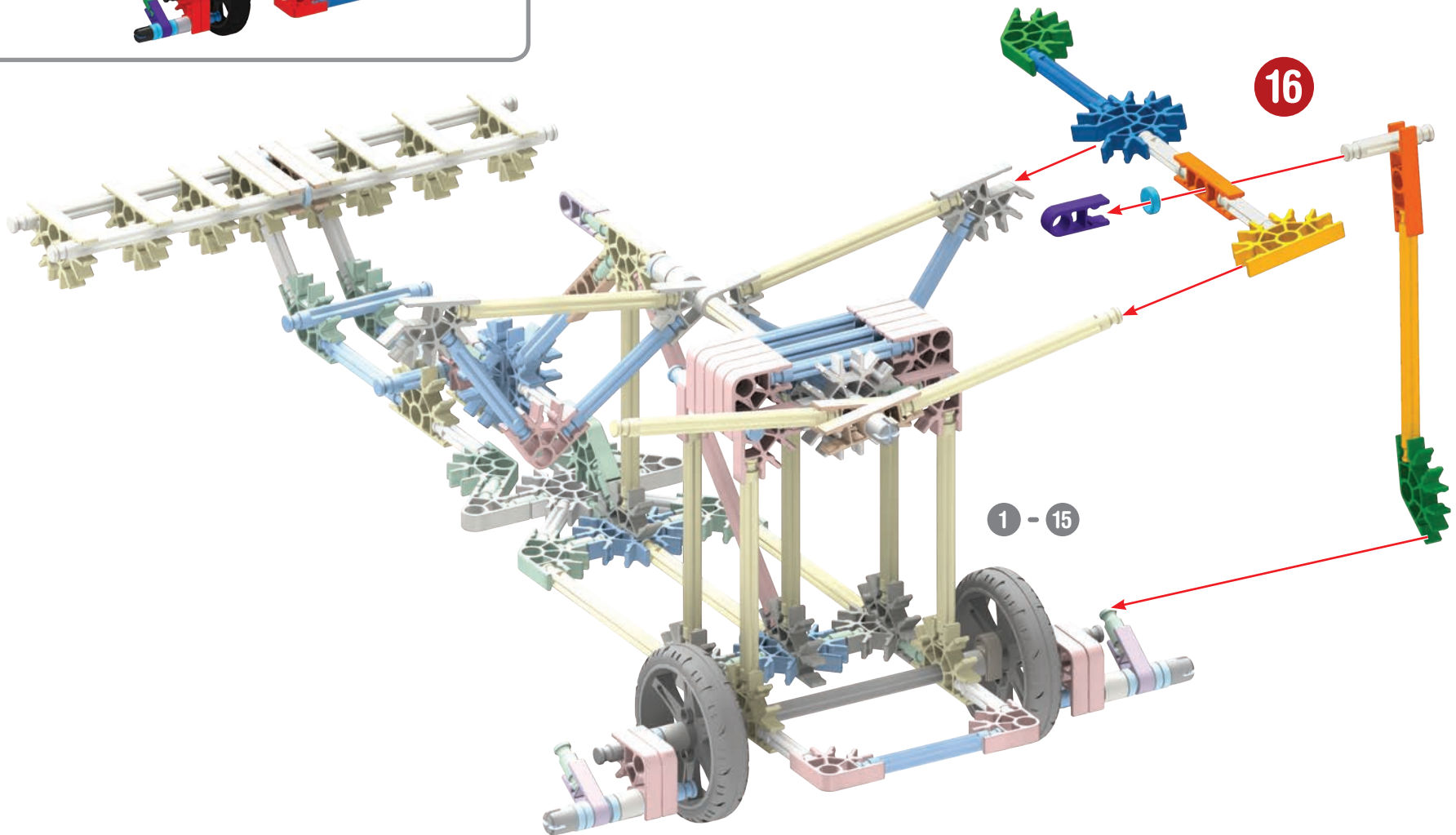
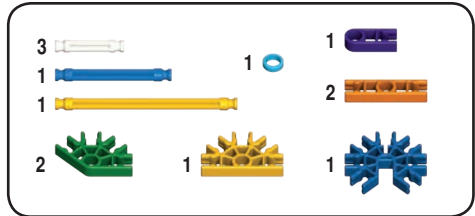

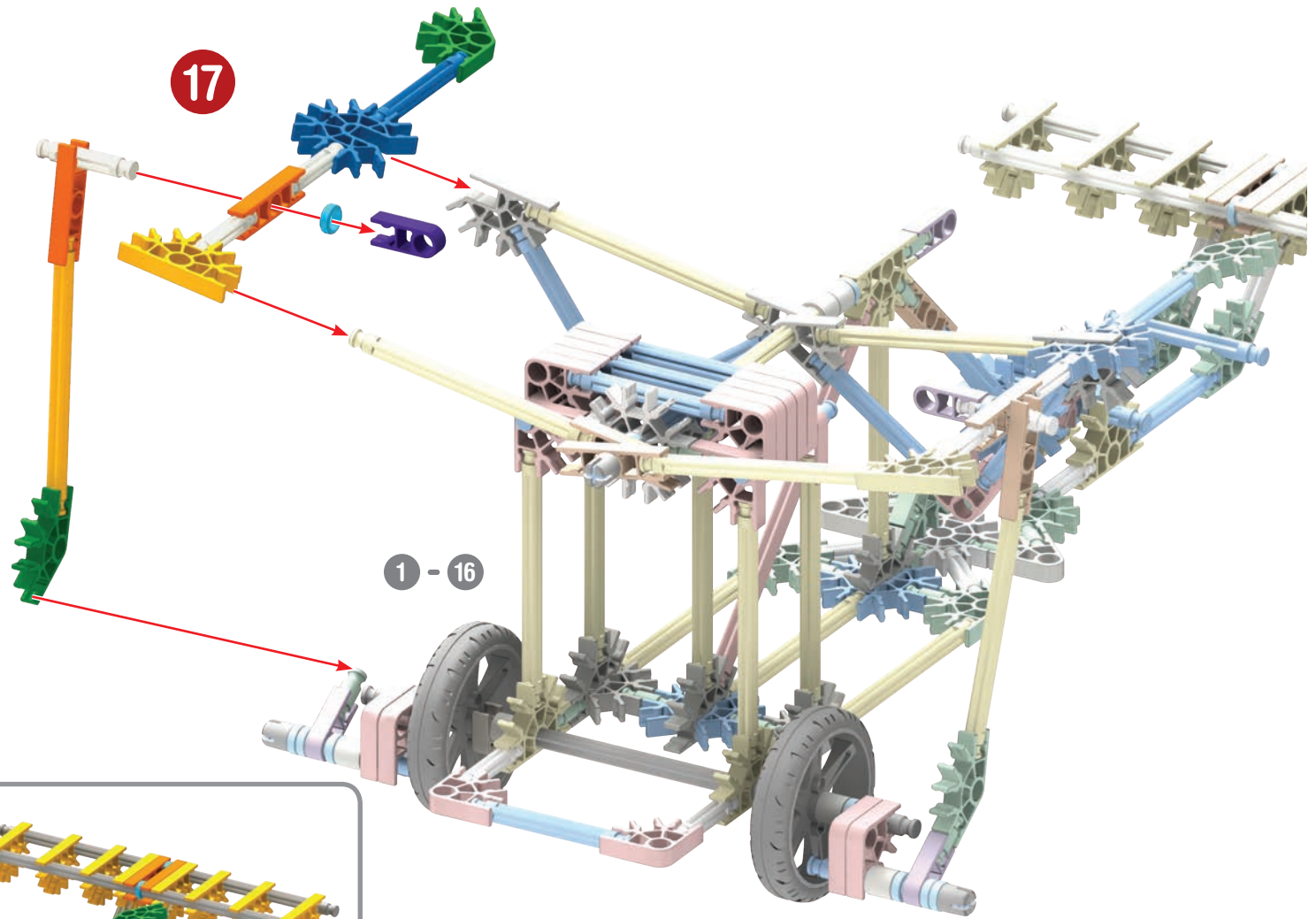

- | | | | | | |
|---|--|---|--|---|--|
| 3 | | 1 | | 1 | |
| 1 | | 1 | | 2 | |
| 1 | | | | | |
| 2 | | 1 | | 1 | |

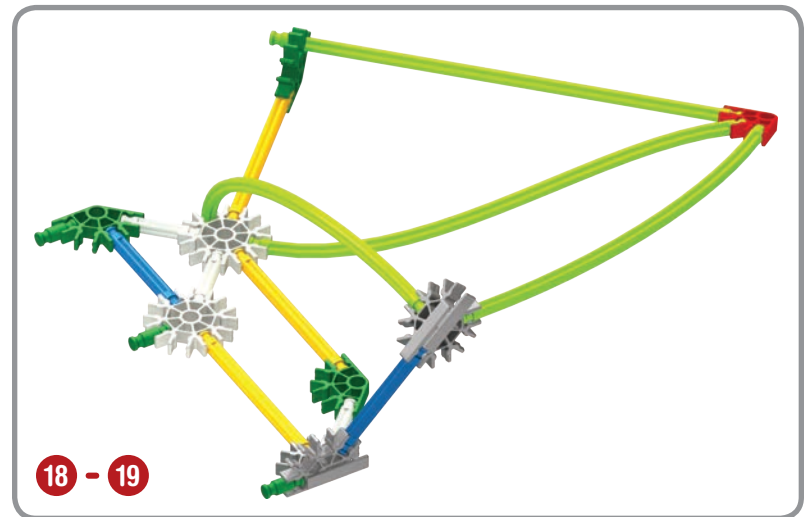
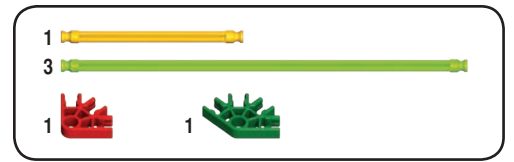
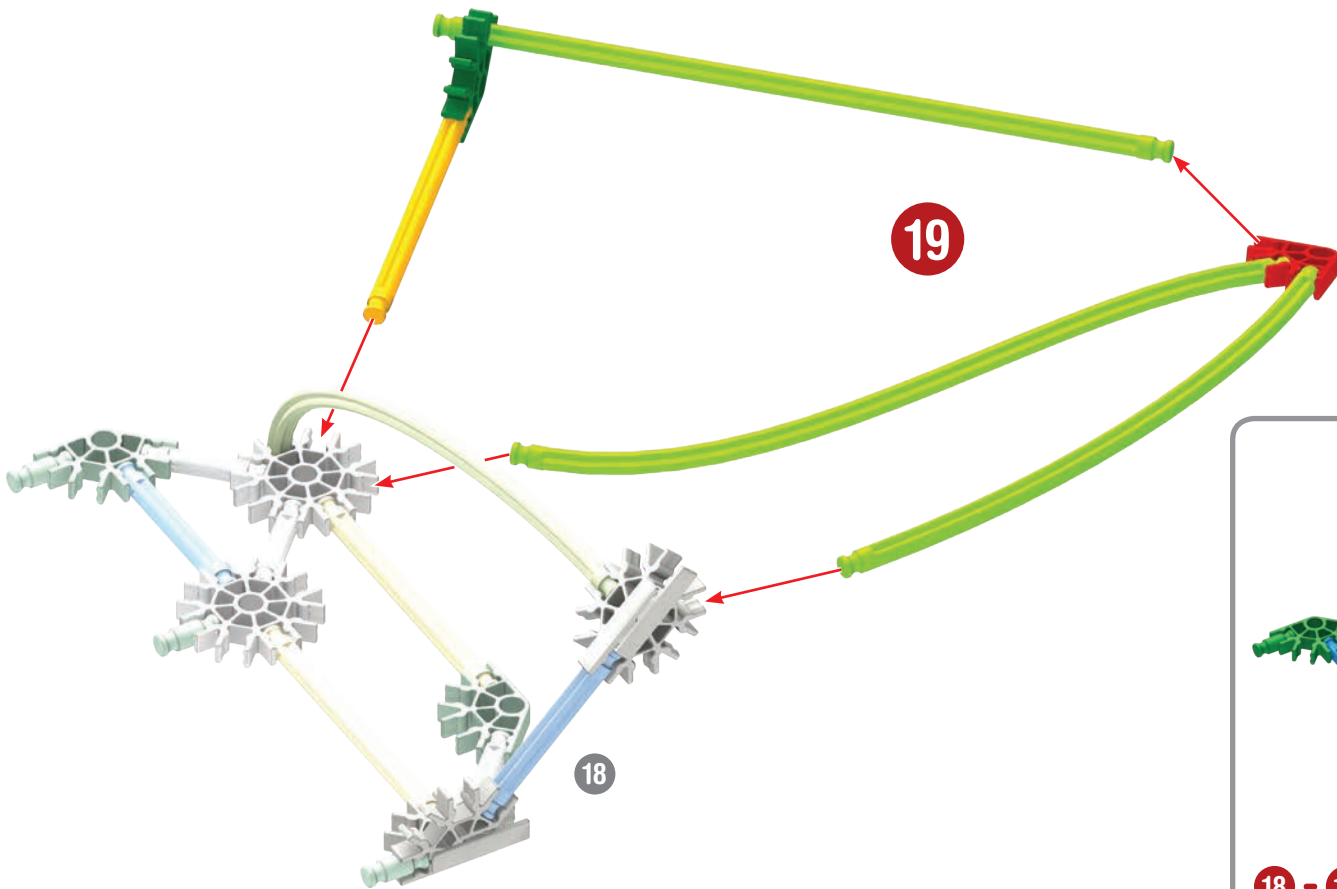
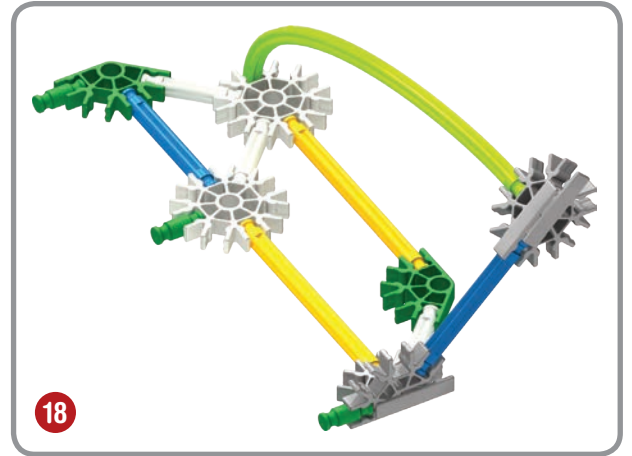
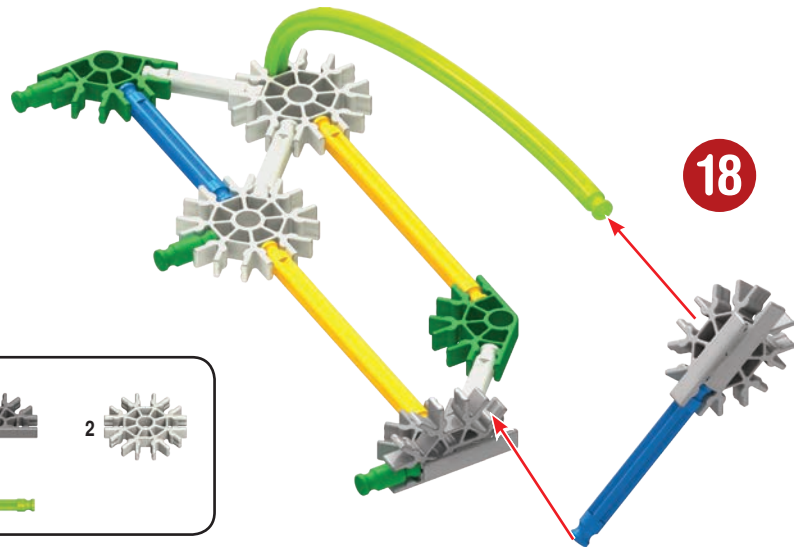
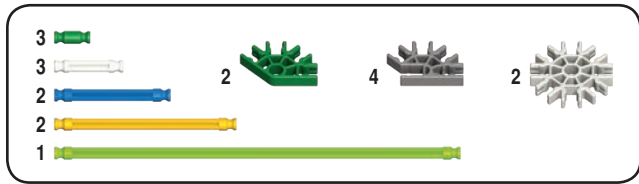

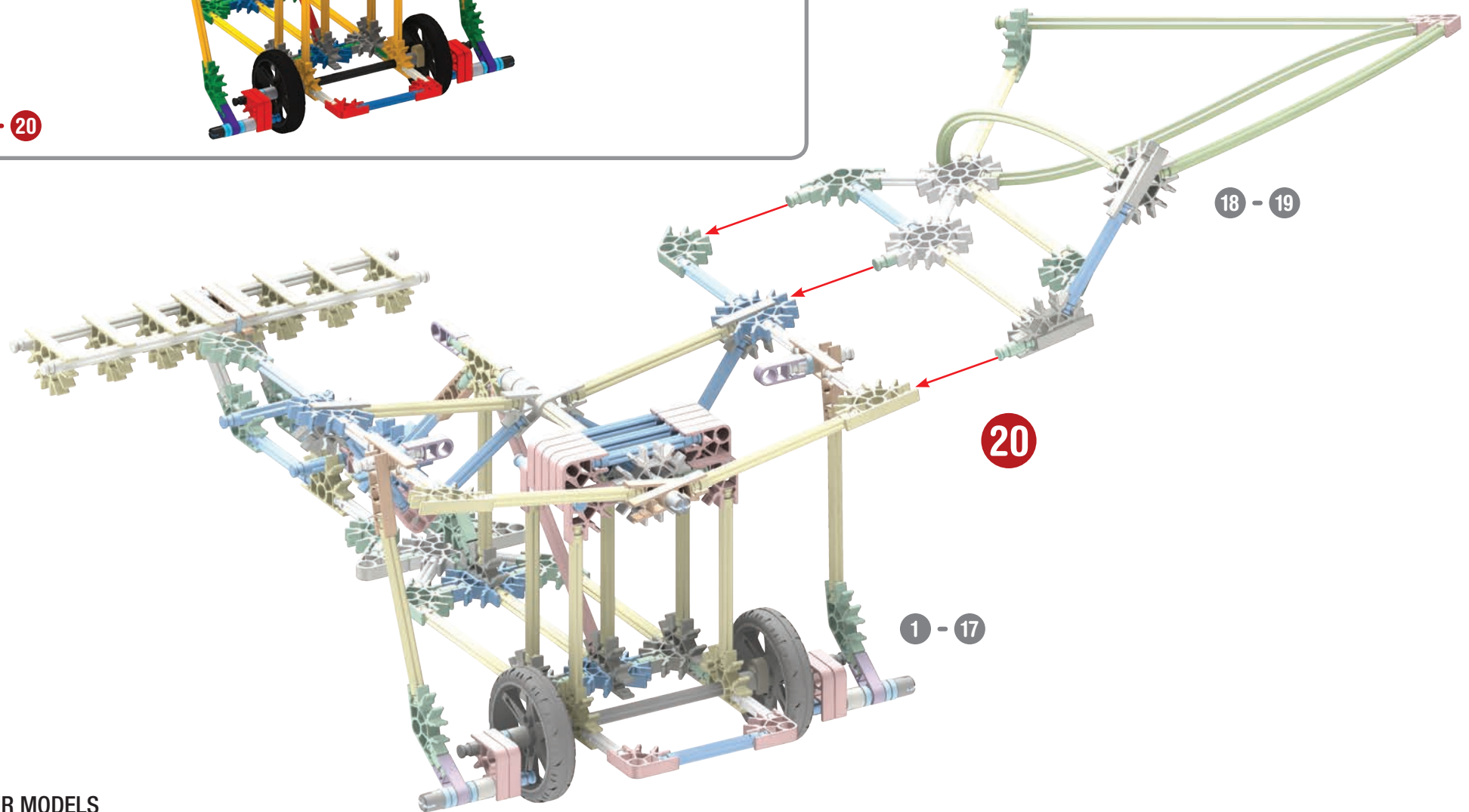

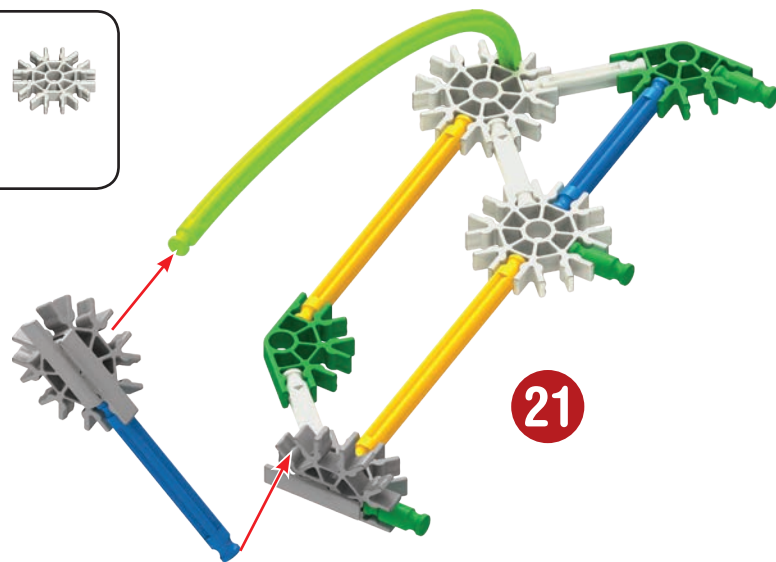
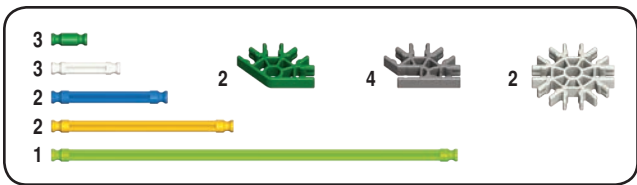

21

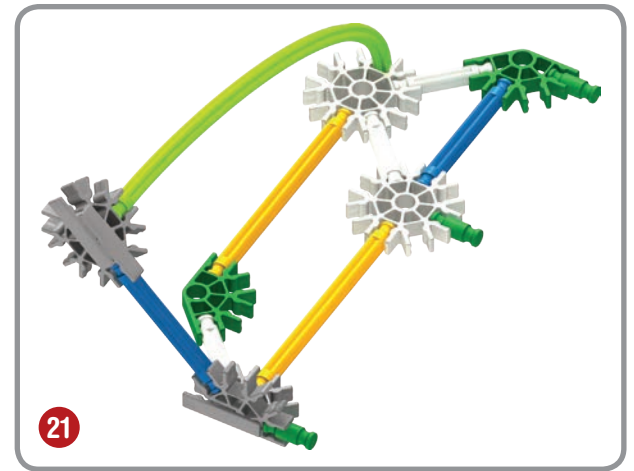

21

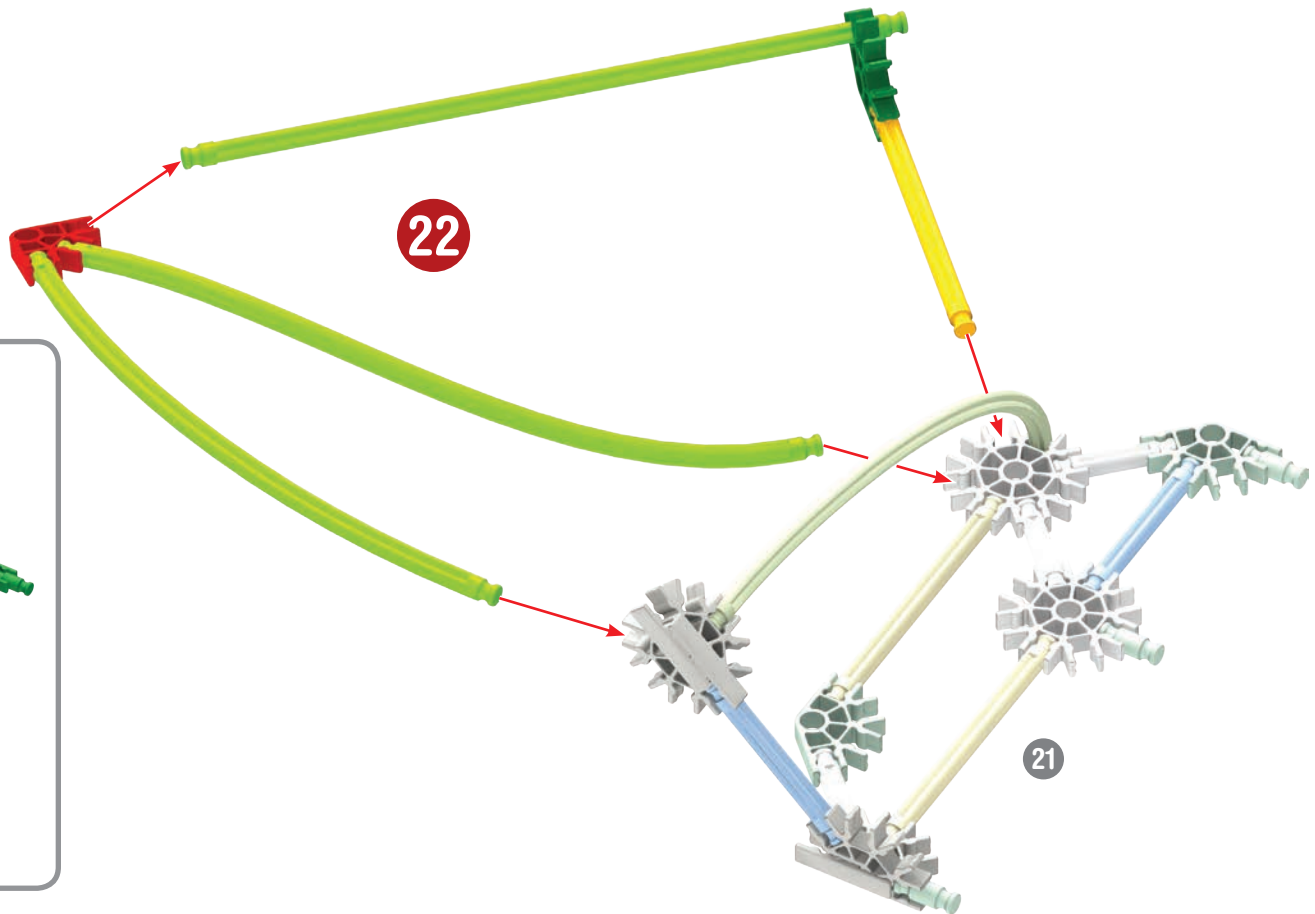
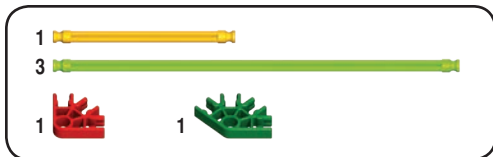

22

21

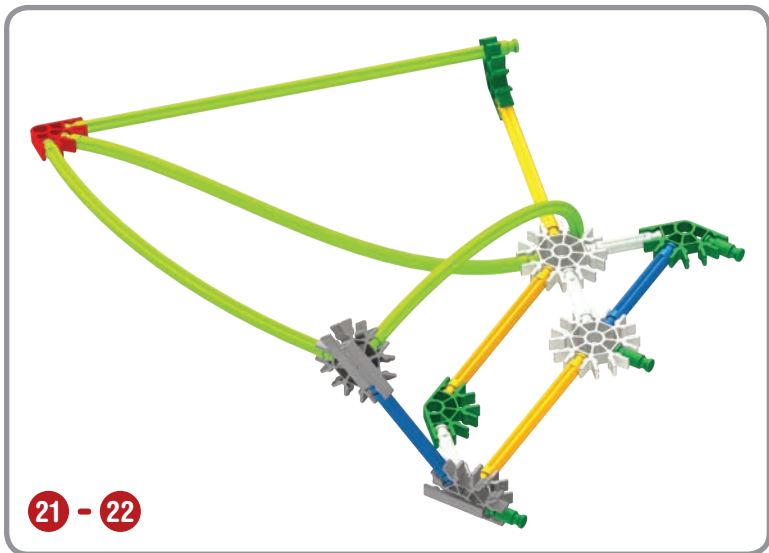

21 - 22

Flying Machine

1 - 23

21 - 22

23

1 - 20

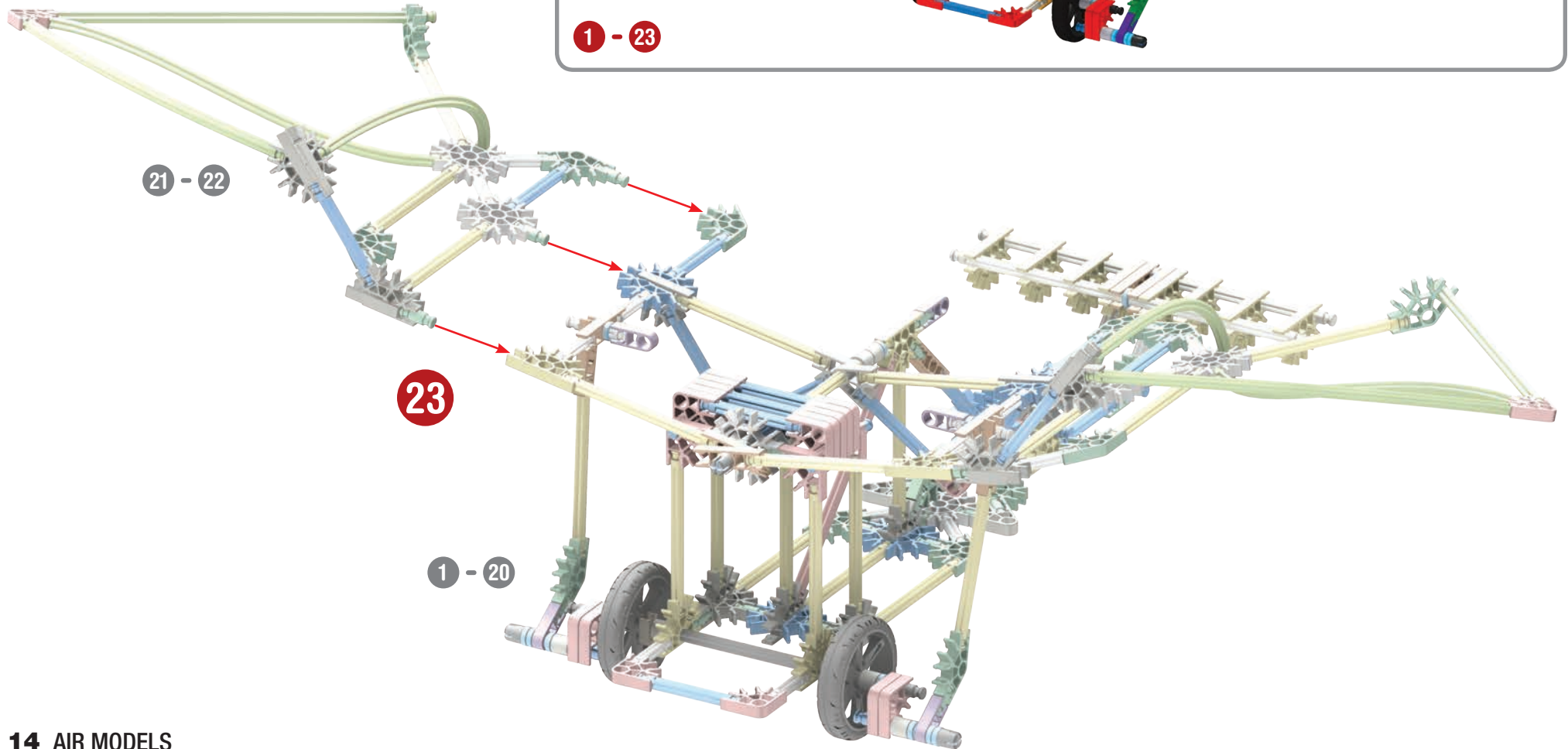

Hang Glider

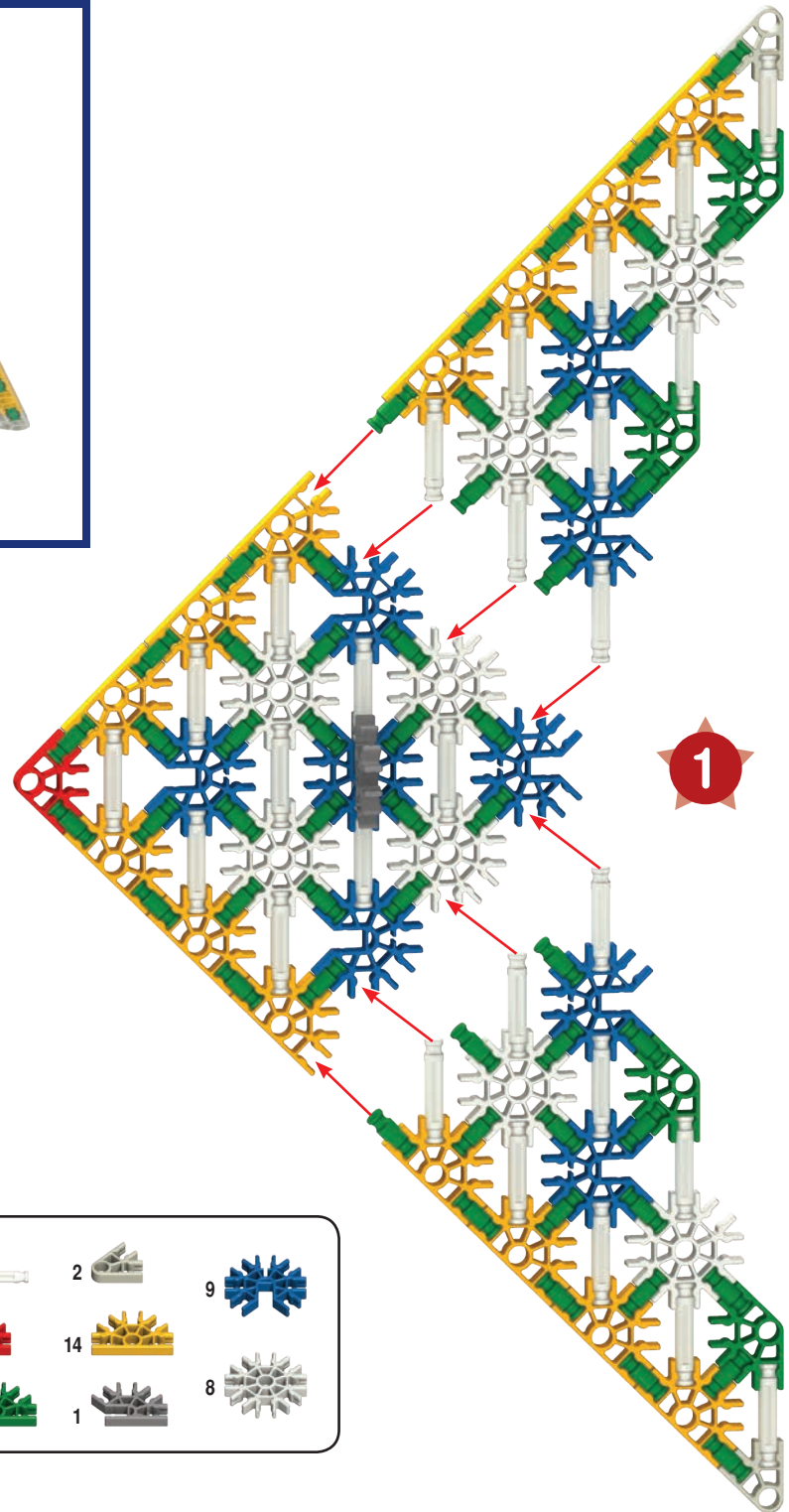
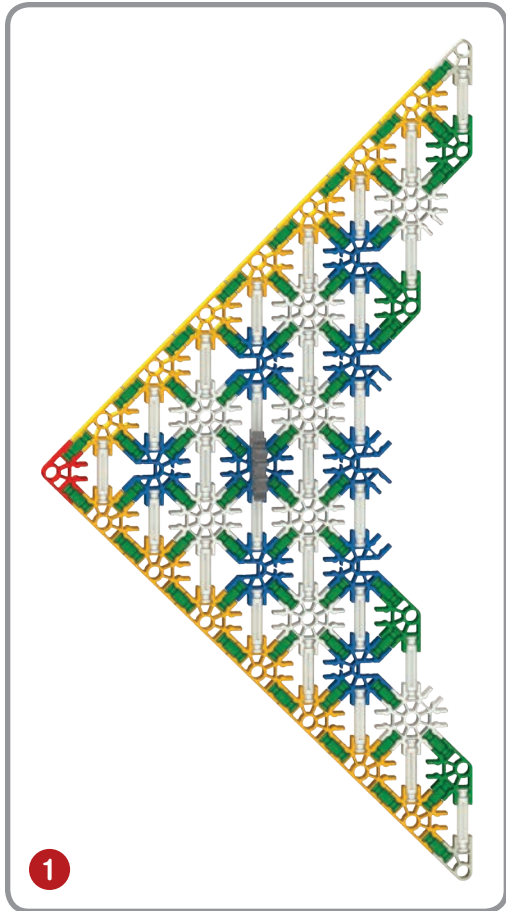
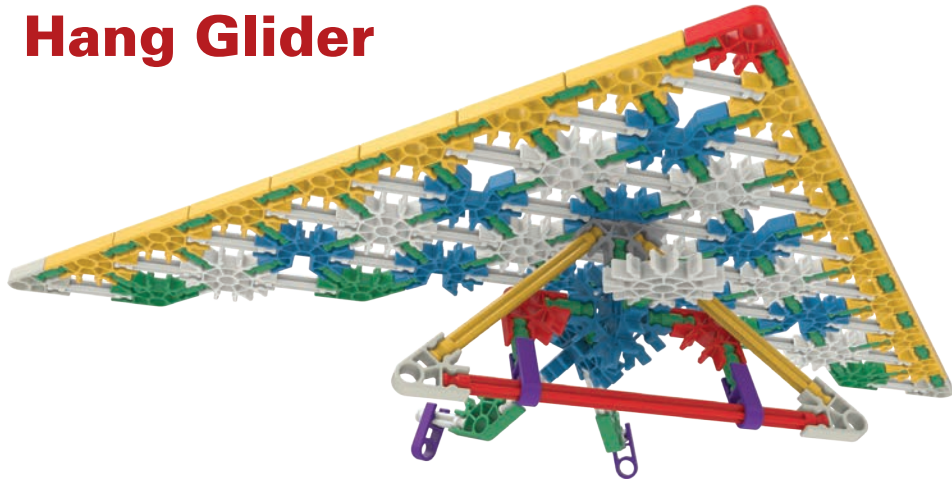

| | | | | | |
|----|--|----|--|---|--|
| 58 | | 2 | | 9 | |
| 27 | | 14 | | 8 | |
| 1 | | 1 | | | |
| 4 | | | | | |

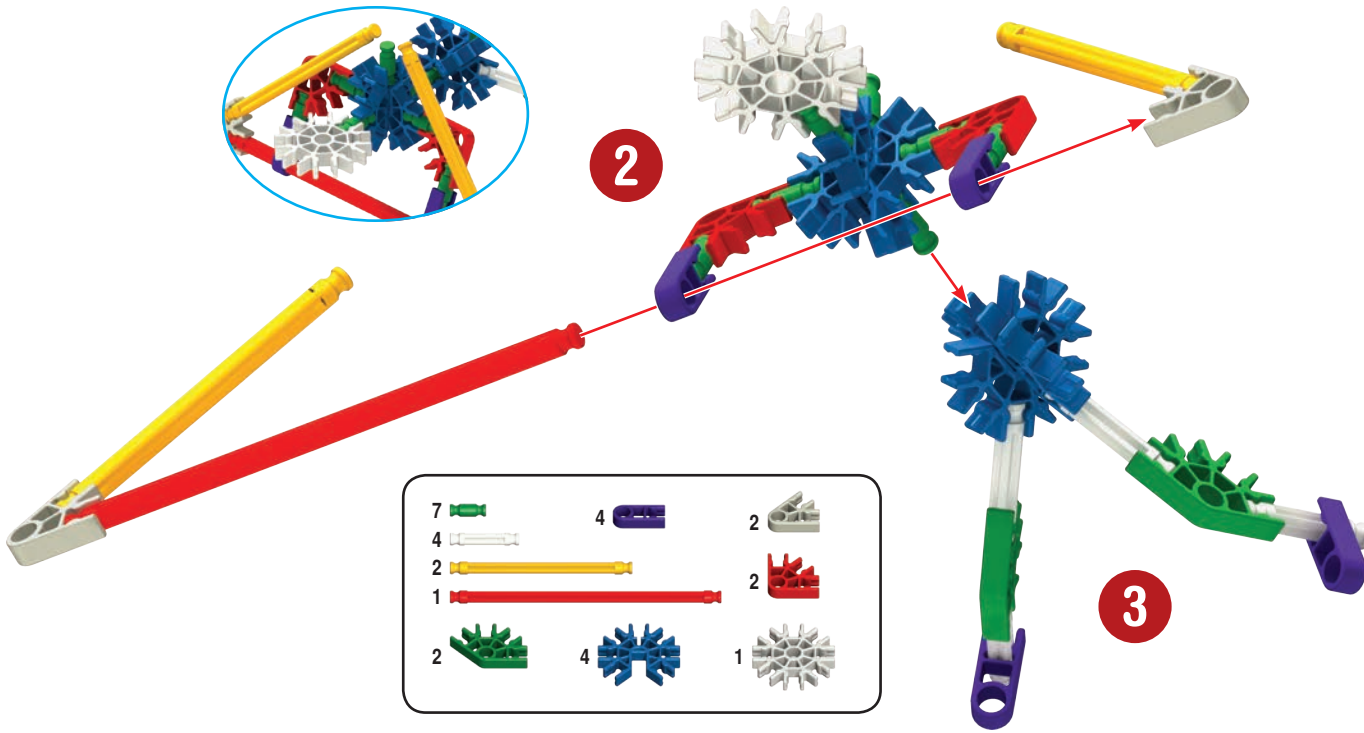

| | | |
|---|---|---|
| 7 | 4 | 2 |
| 4 | 2 | 2 |
| 2 | 1 | 2 |
| 1 | 2 | 2 |
| 2 | 4 | 1 |
| | | |

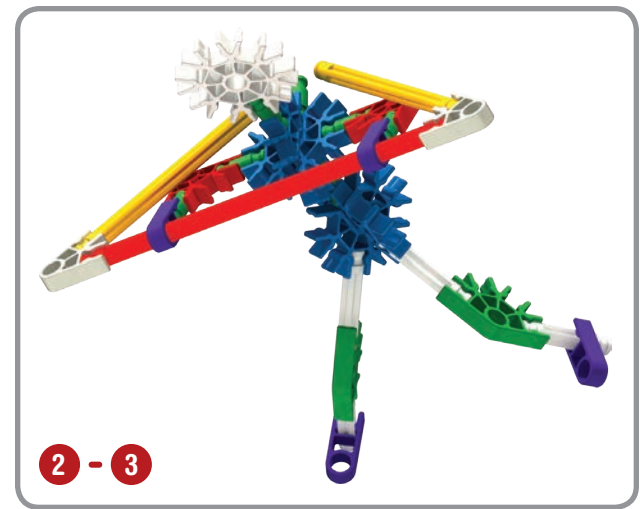

3

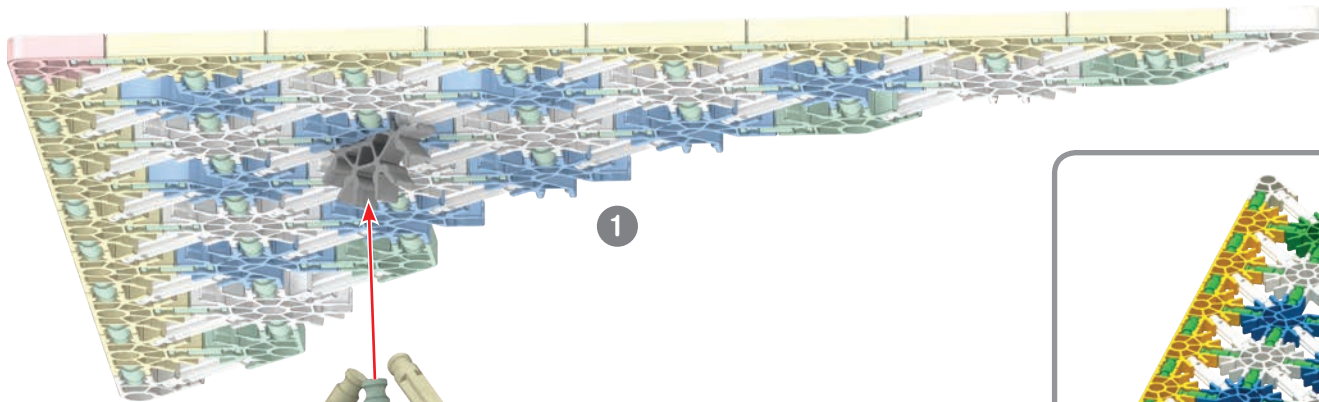

4

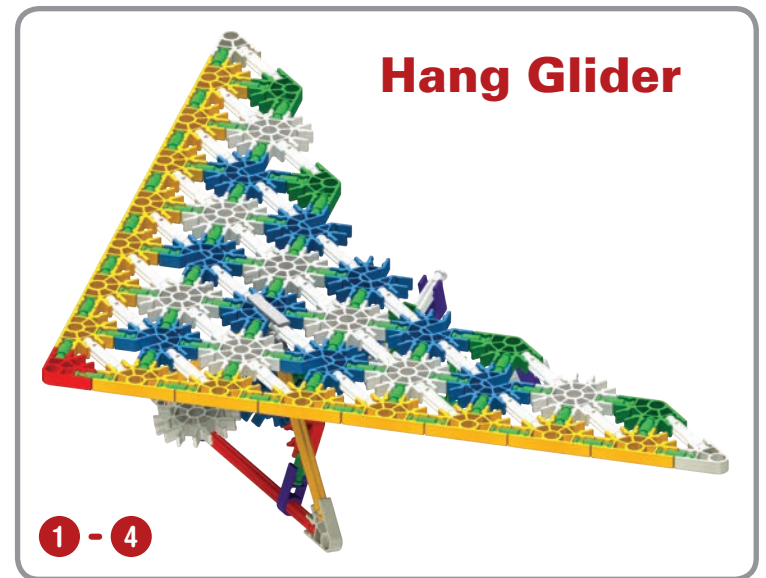
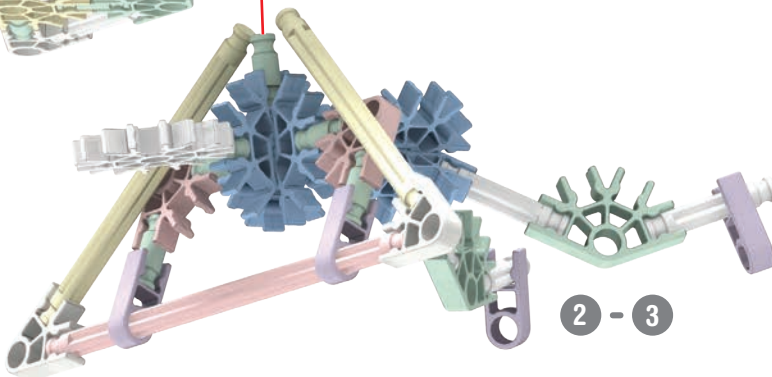

Helicopter





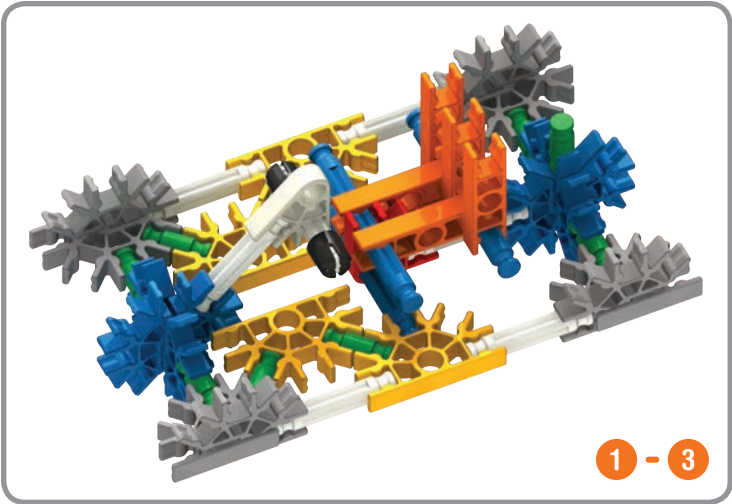
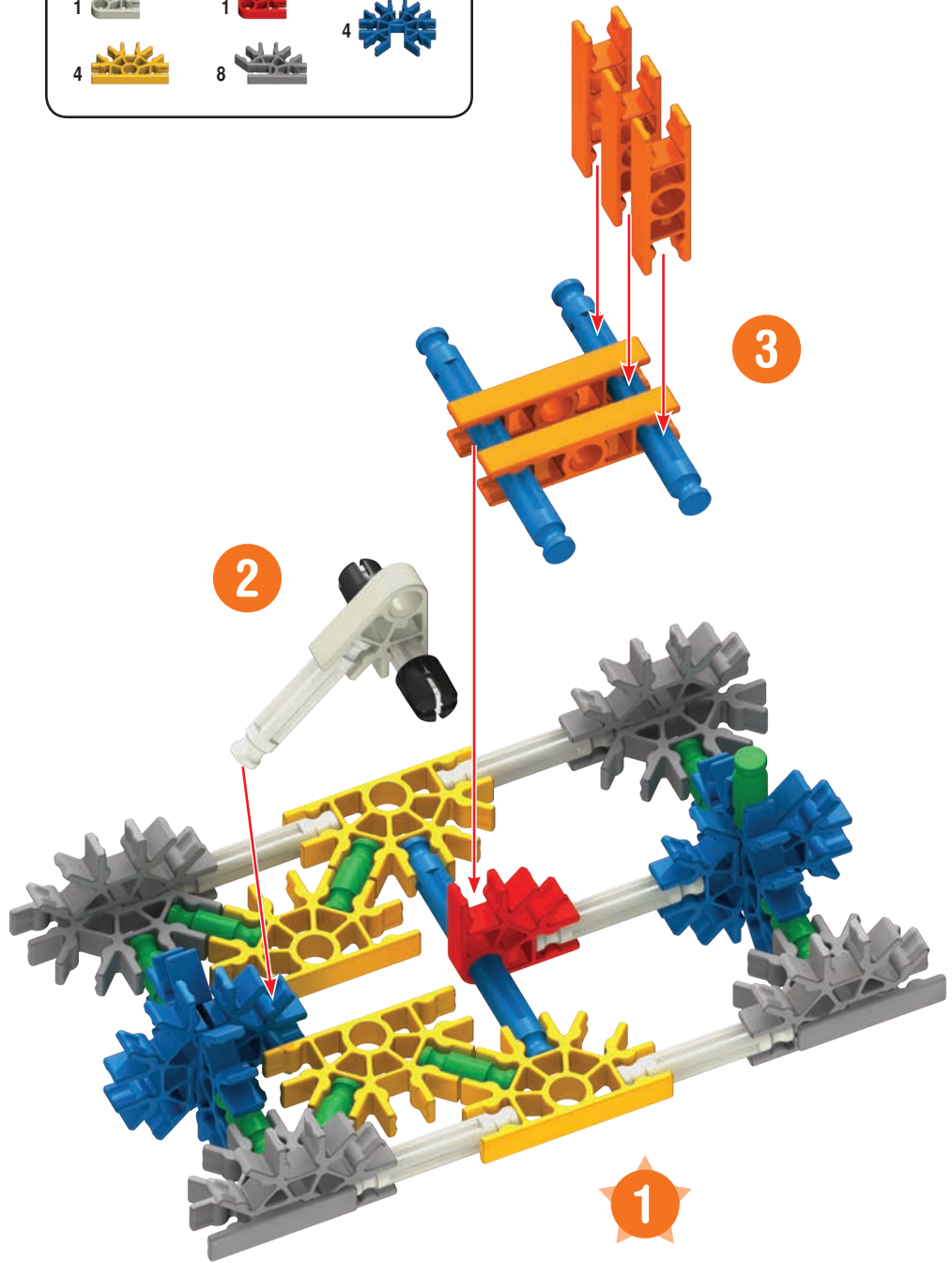

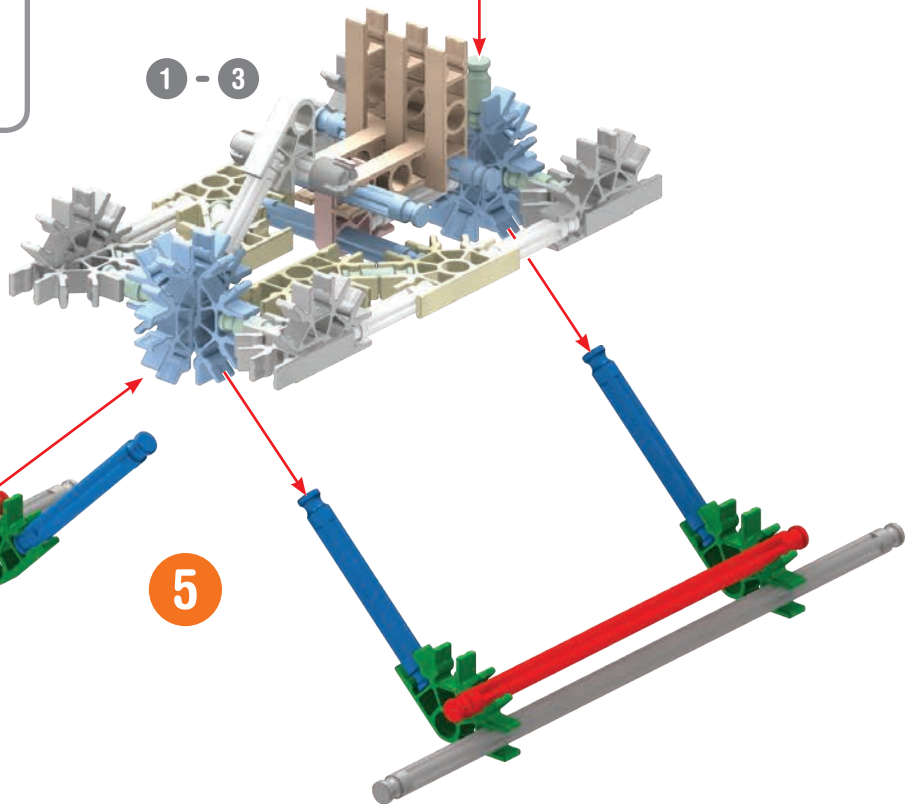
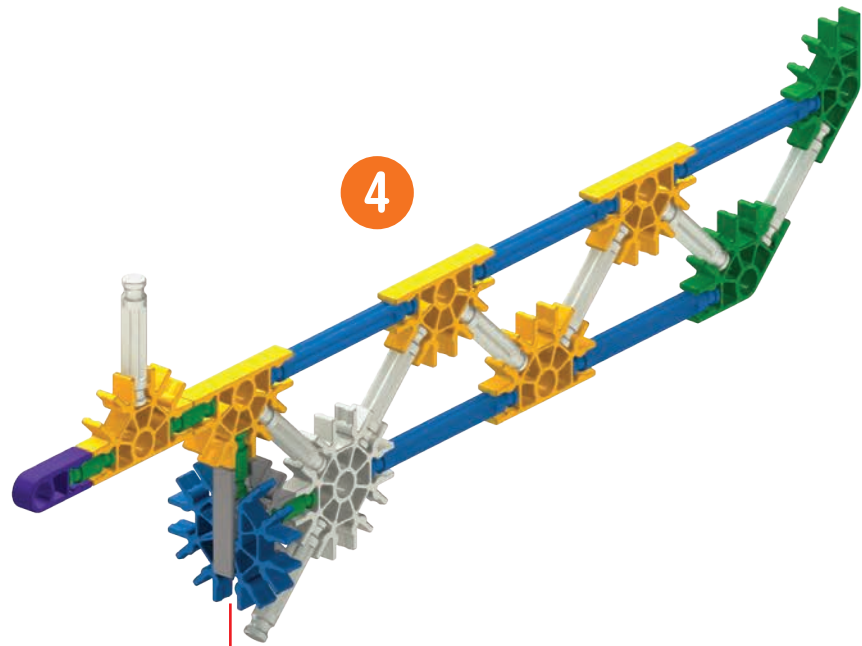
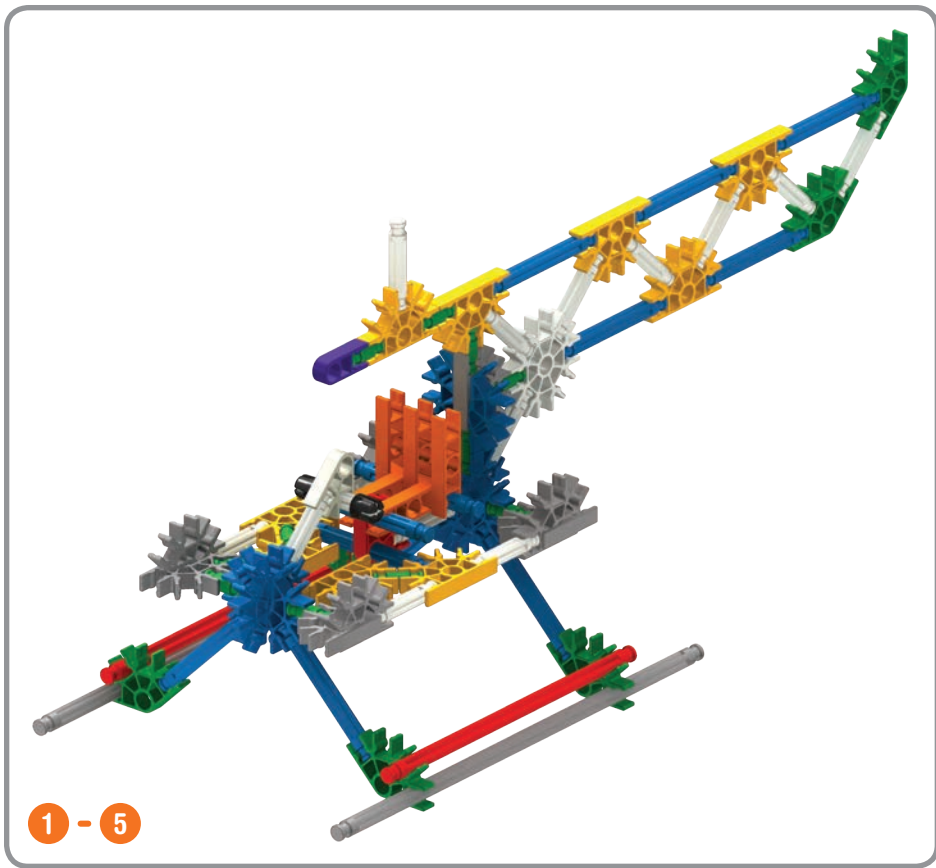



- | | | | | | |
|---|--|---|--|---|--|
| 9 | | 2 | | 5 | |
| 7 | | | | | |
| 3 | | | | | |
| 1 | | 1 | | 4 | |
| 4 | | 8 | | | |





- | | | | | | |
|---|--|---|--|---|--|
| 4 | | 5 | | 1 | |
| 8 | | | | 6 | |
| 9 | | | | | |
| 2 | | | | | |
| 2 | | | | | |
| 1 | | 1 | | 1 | |

- | | | | |
|---|---|---|---|
| 6 |  | | |
| 6 |  | 4 |  |
| 4 |  | | |
| 2 |  | | |
| 4 |  | 2 |  |
| | | 2 |  |

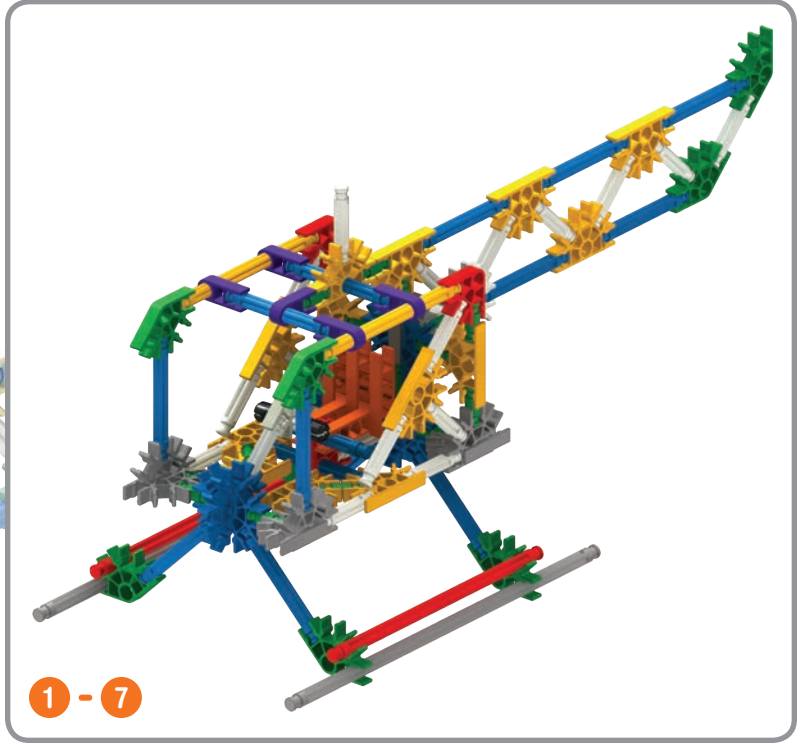
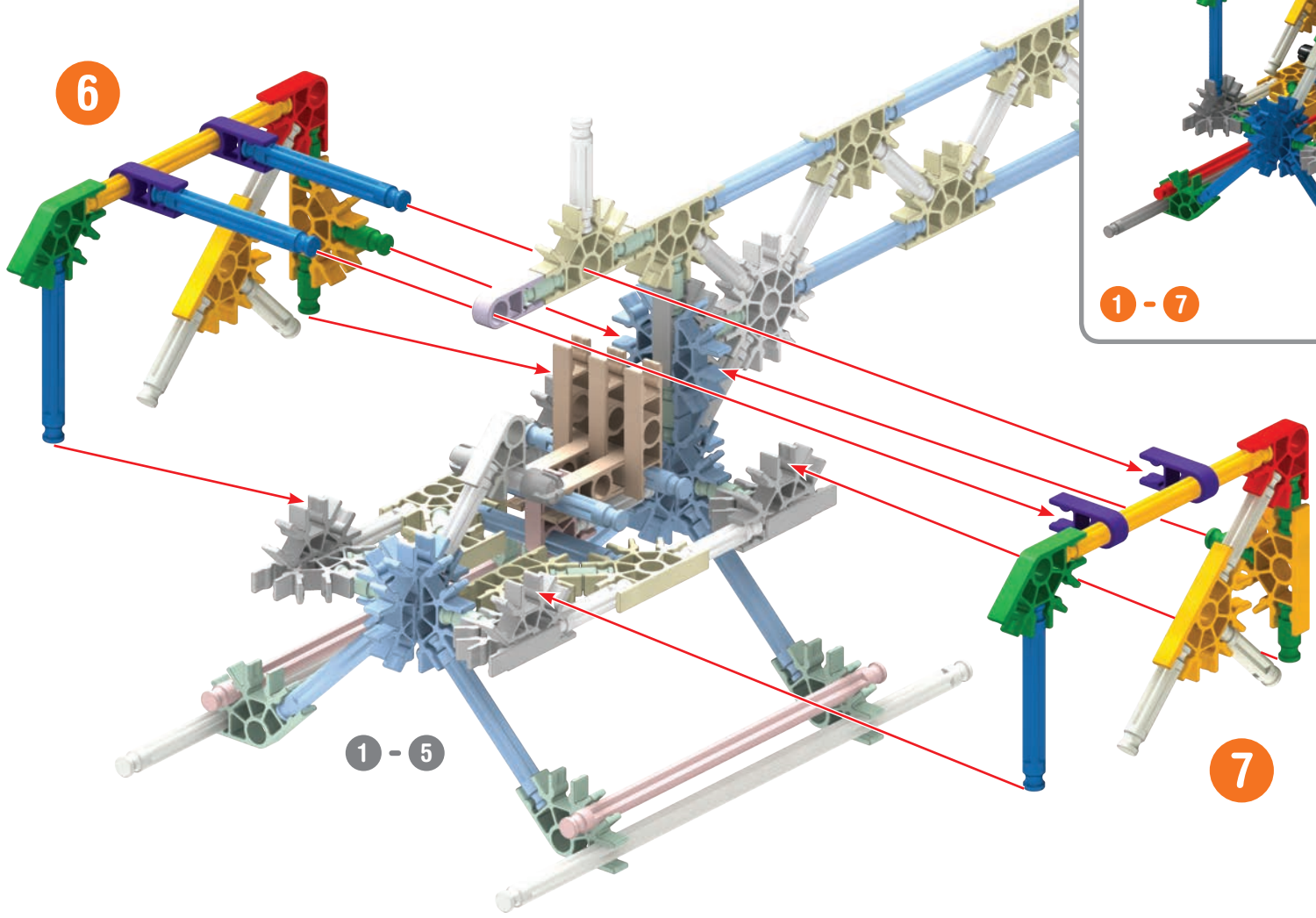

- | | | | | | | | |
|----|--|---|--|---|--|---|--|
| 8 | | 1 | | 1 | | | |
| 12 | | 1 | | 2 | | 2 | |
| 2 | | 1 | | 2 | | | |
| 4 | | | | | | | |
| 1 | | | | | | | |
| 2 | | 3 | | 4 | | 4 | |

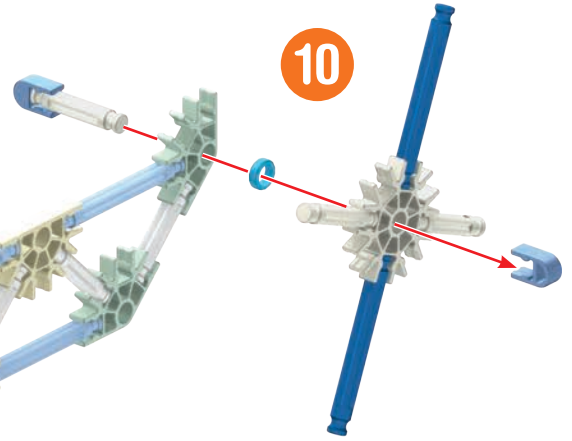
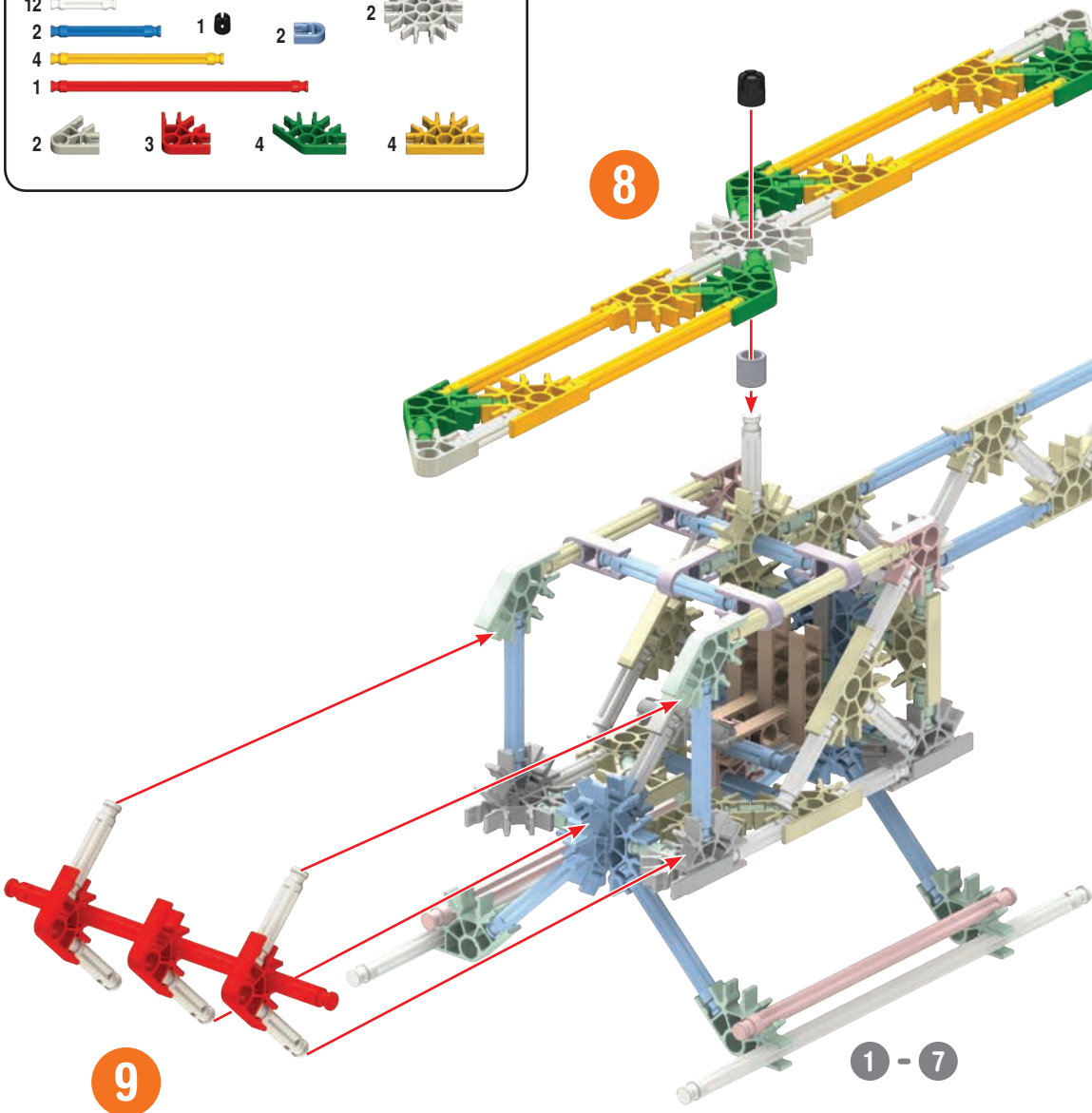

Helicopter

Hot Air Balloon

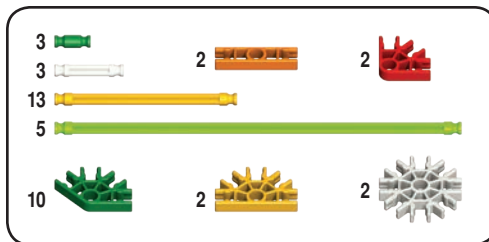
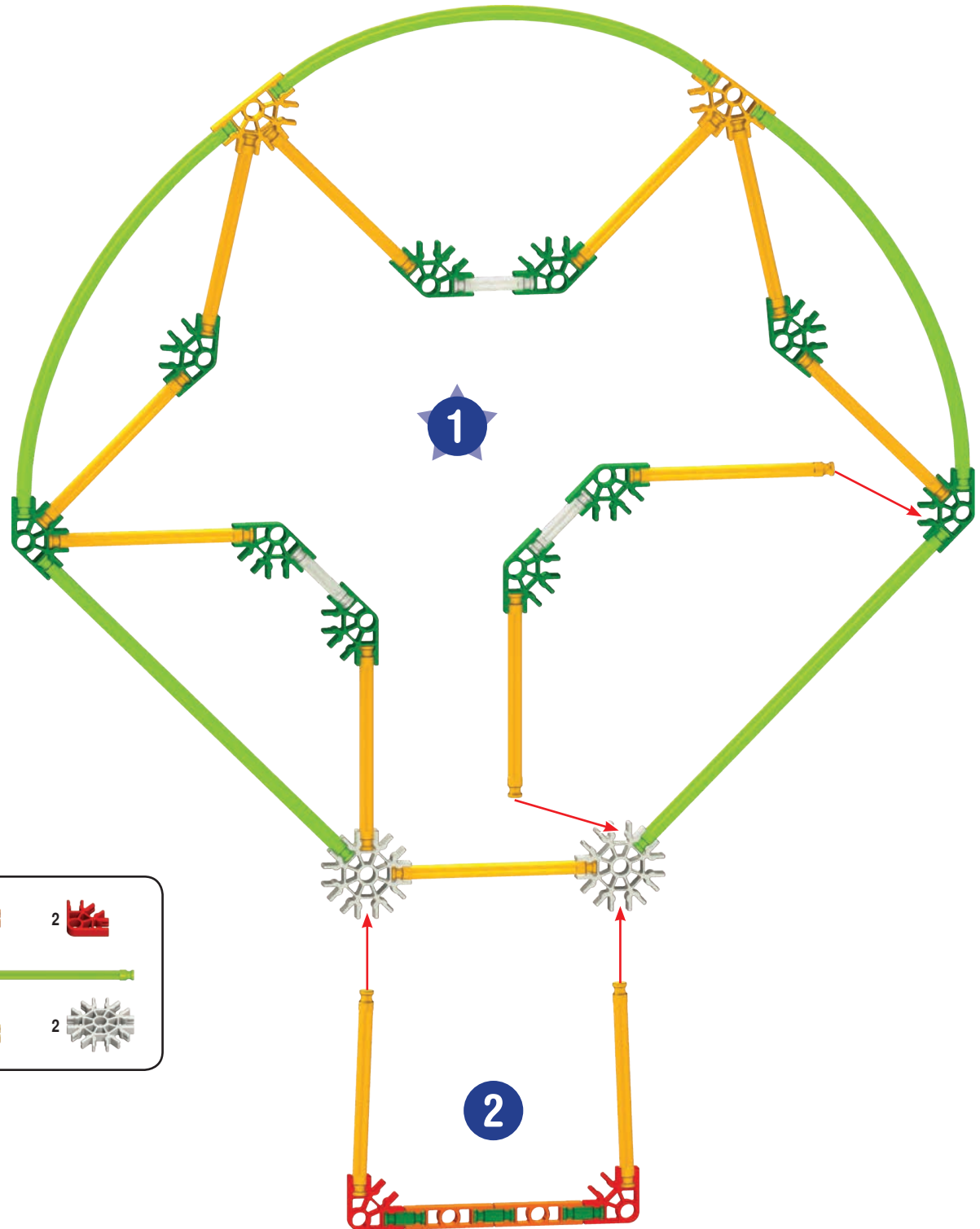
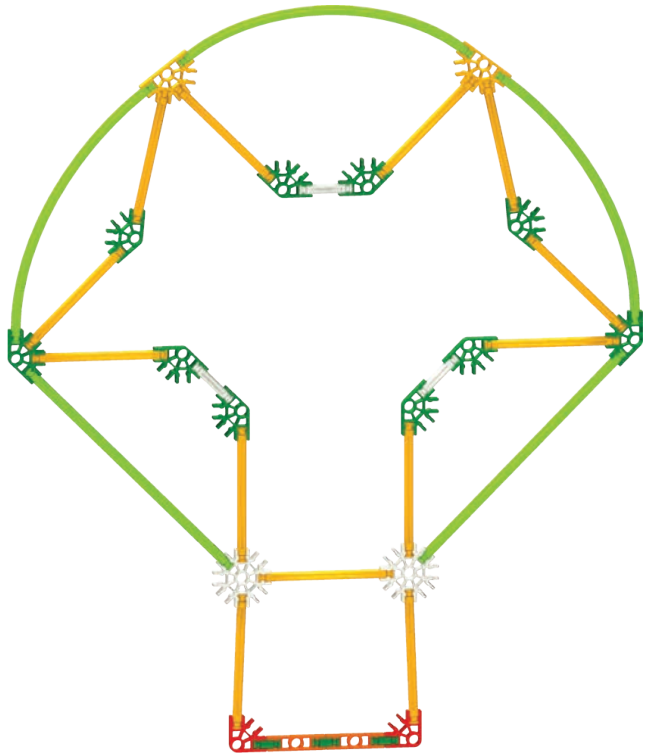

Plane

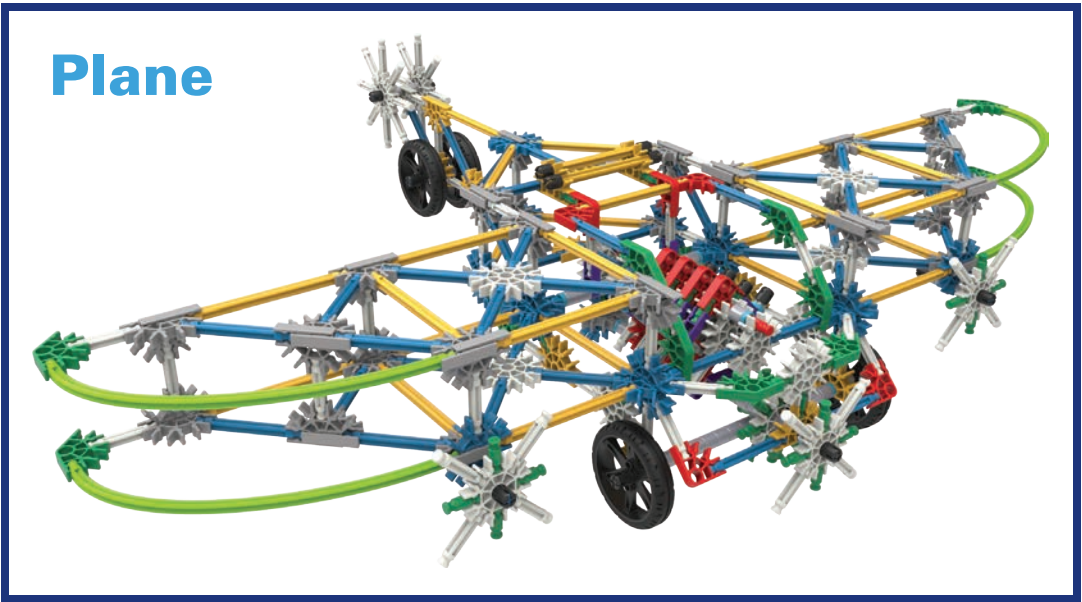

1

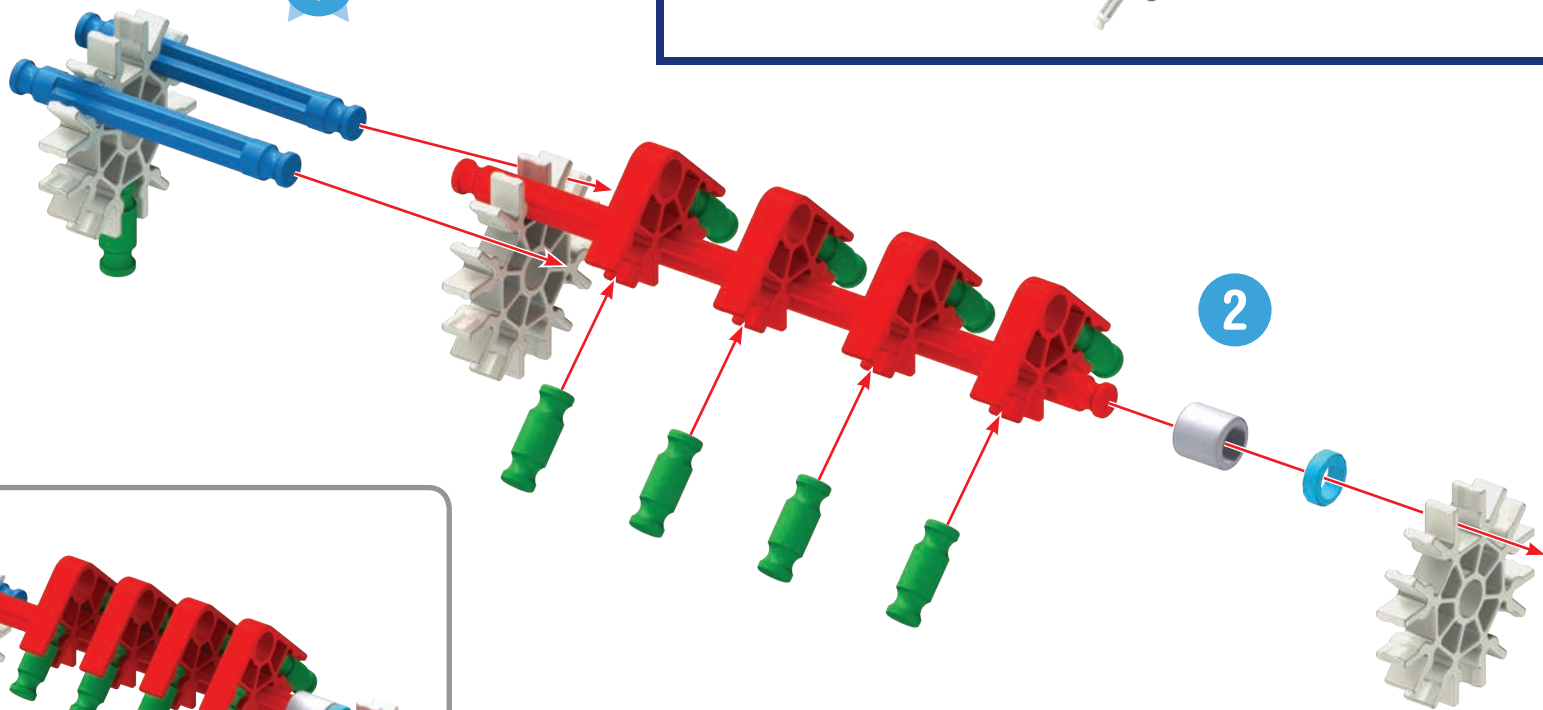

2

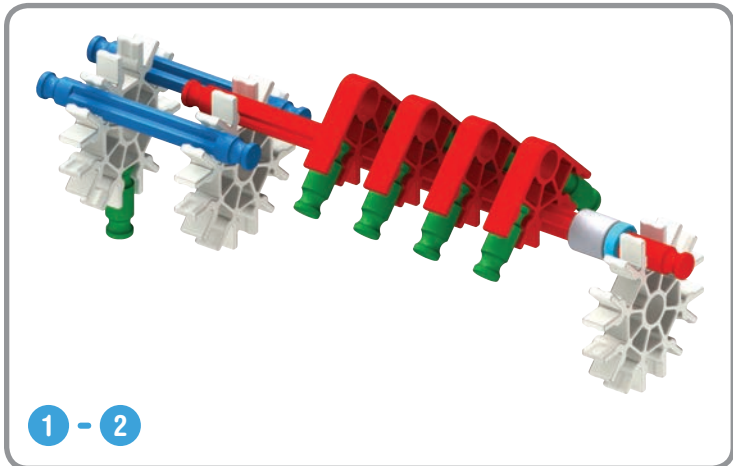

- | | | | |
|---|---|---|---|
| 1 | 1 | 4 | 3 |
| 9 | | | |
| 2 | | | |
| 1 | | | |

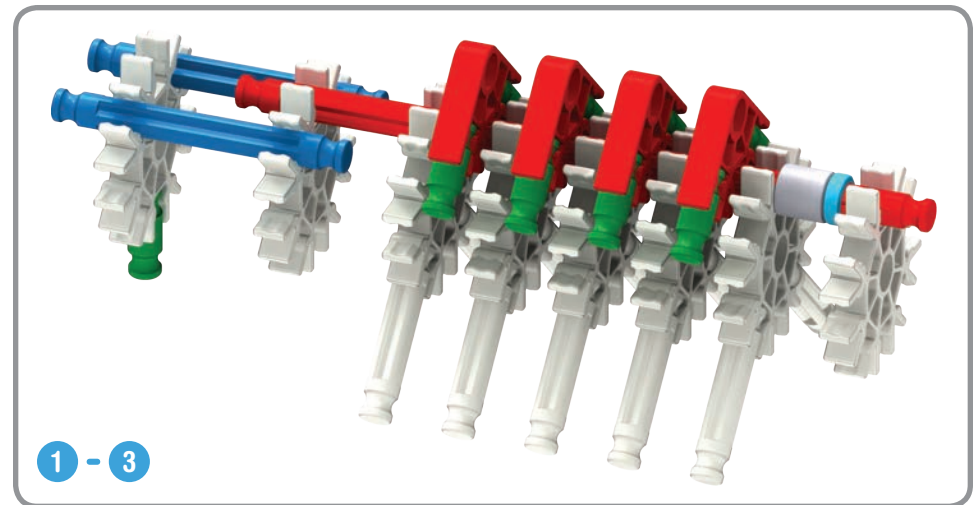
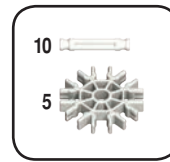
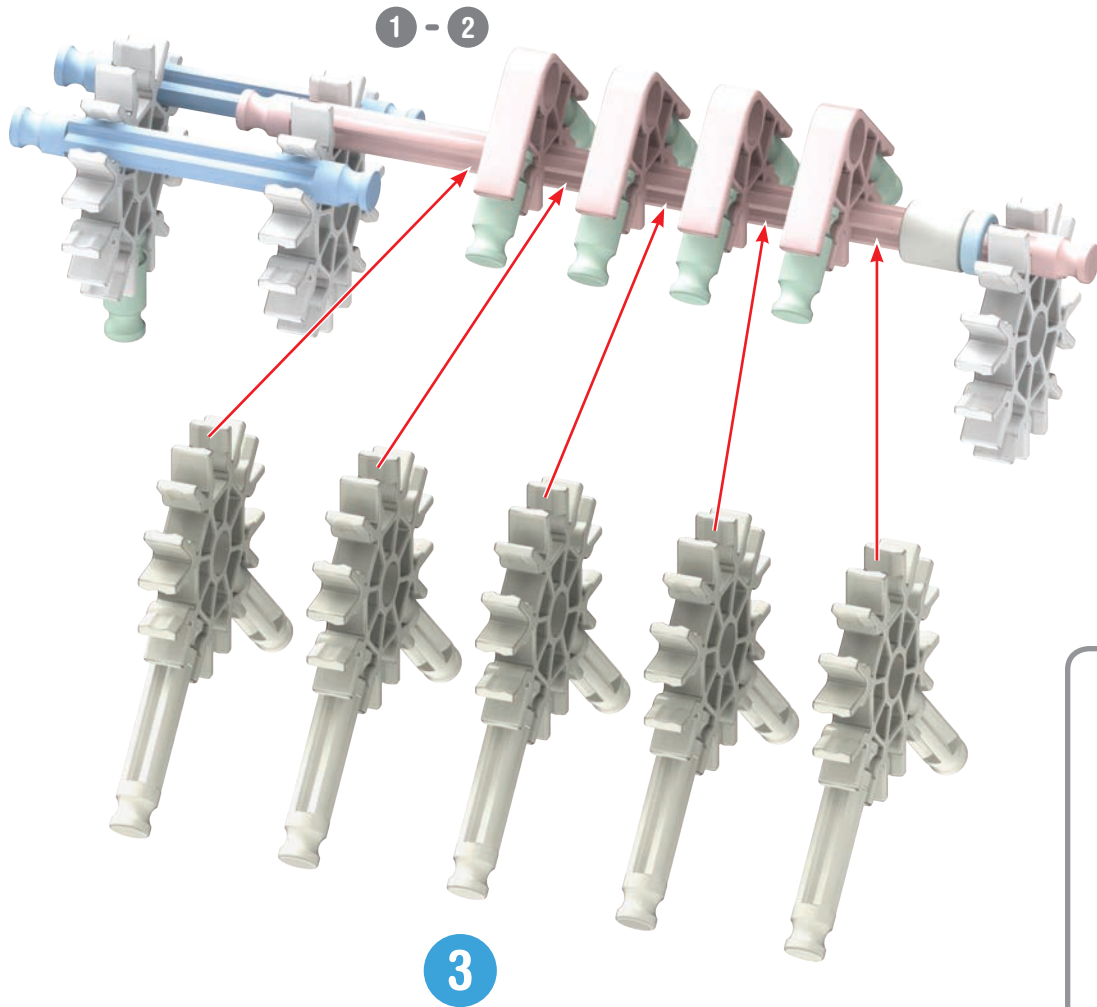

x8

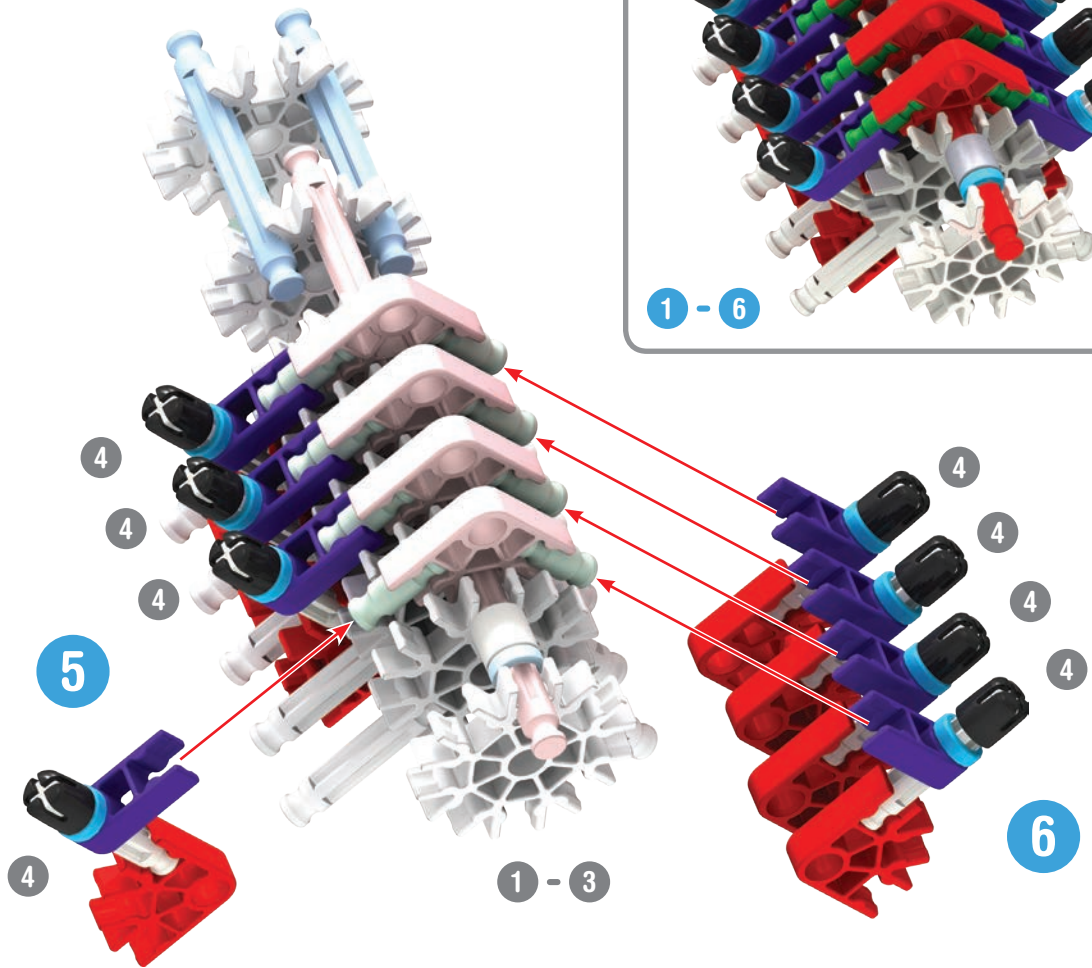
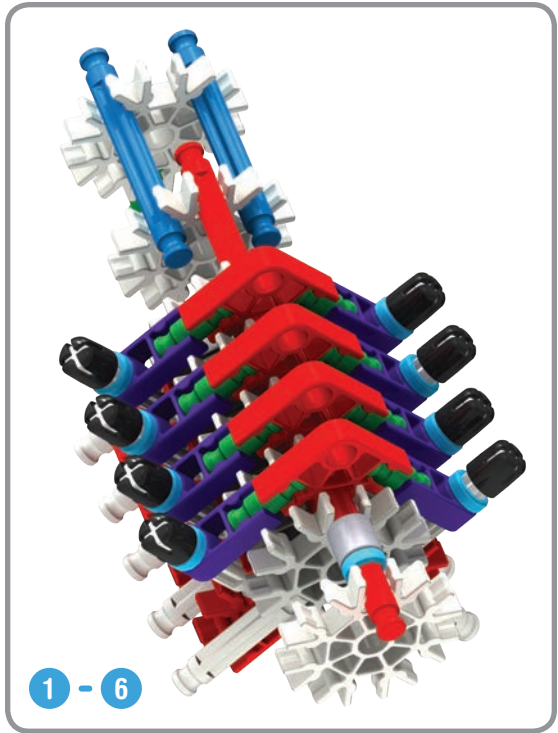
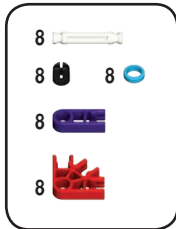
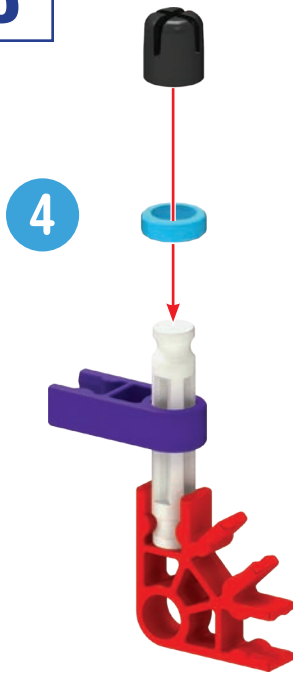

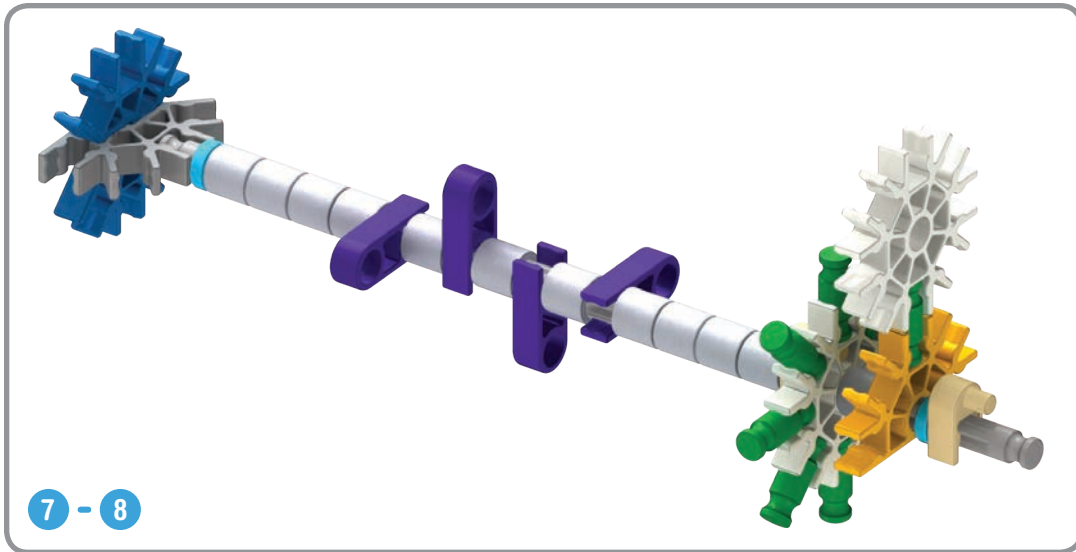
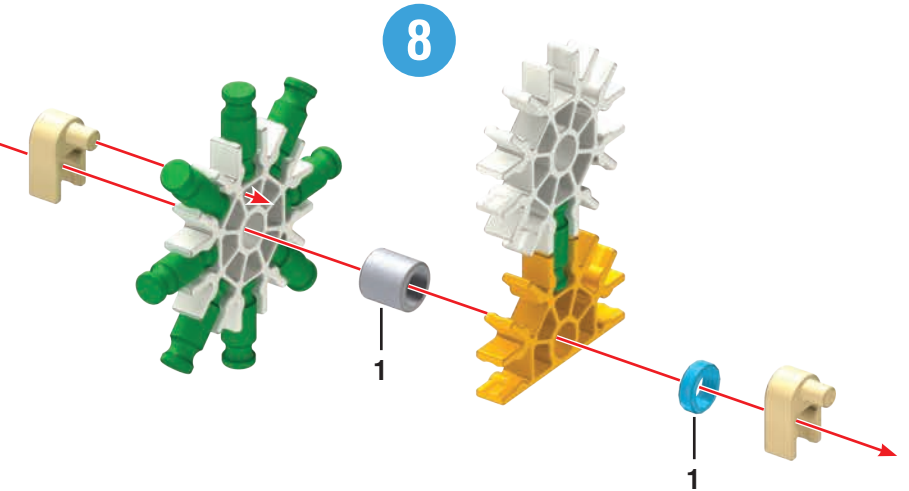
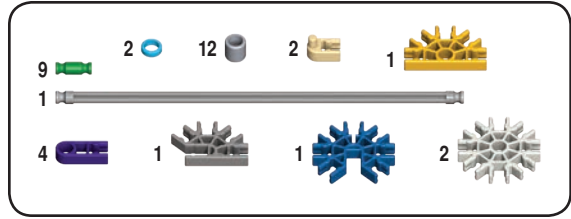
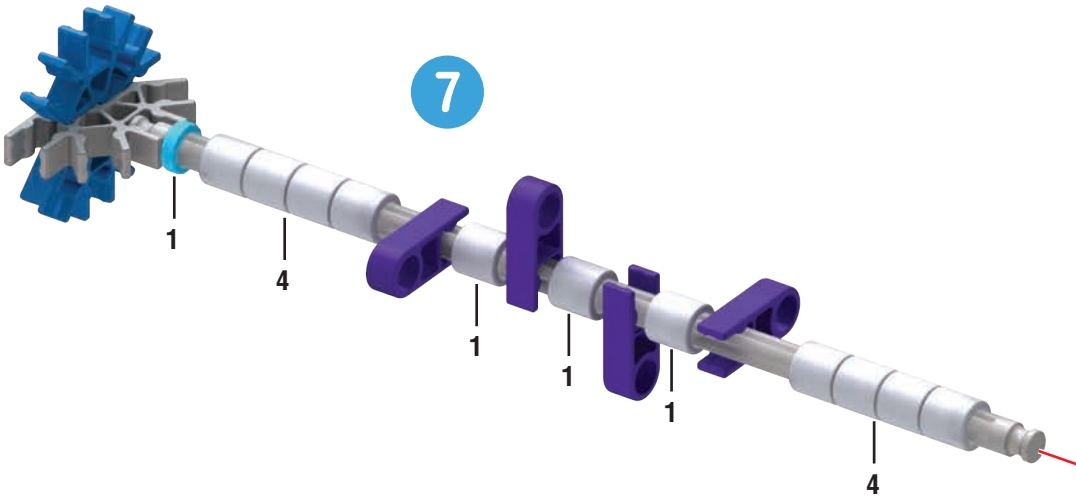

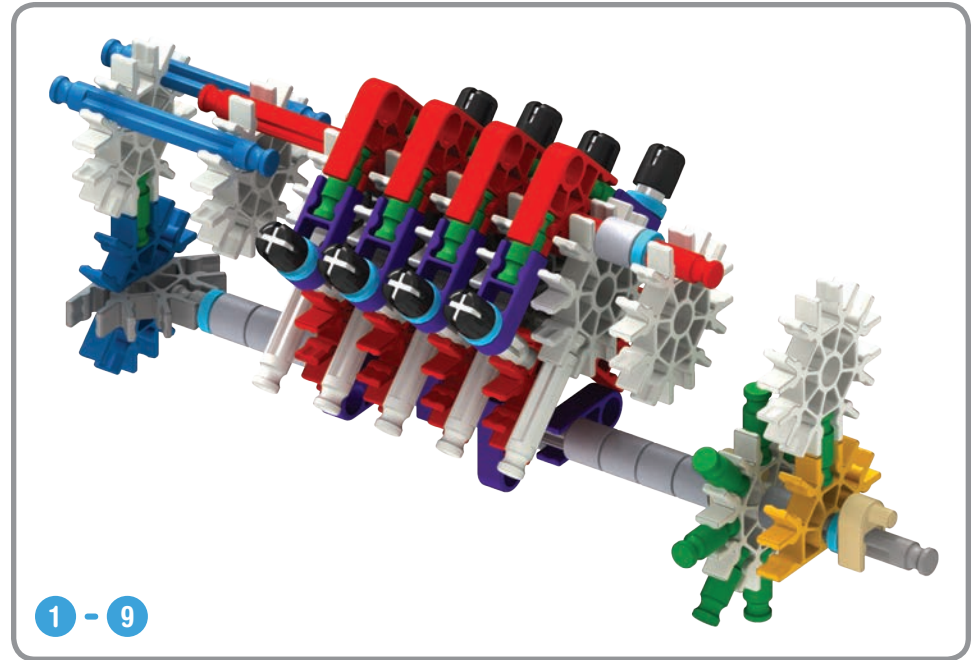
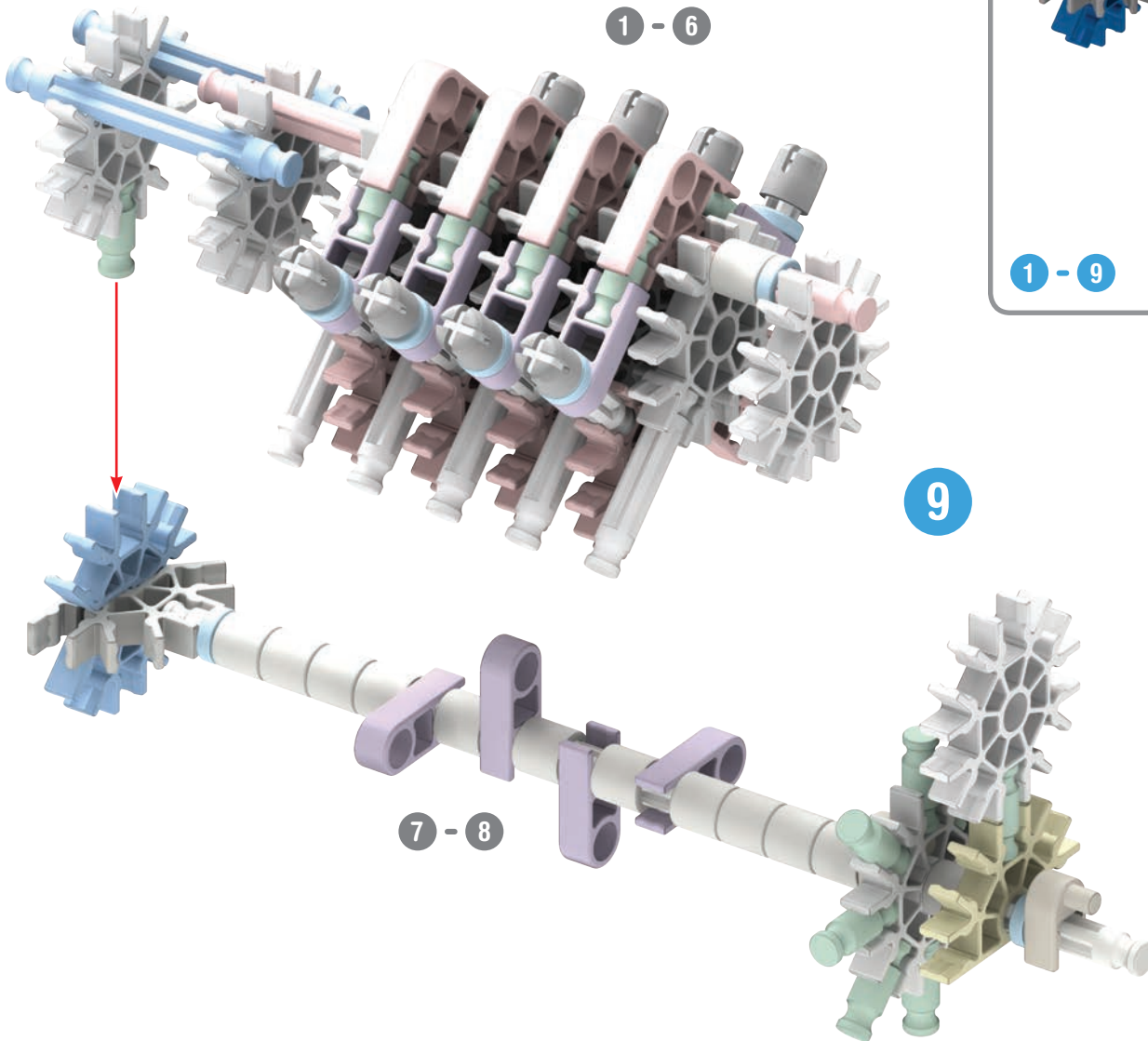

1 - 9

11

10

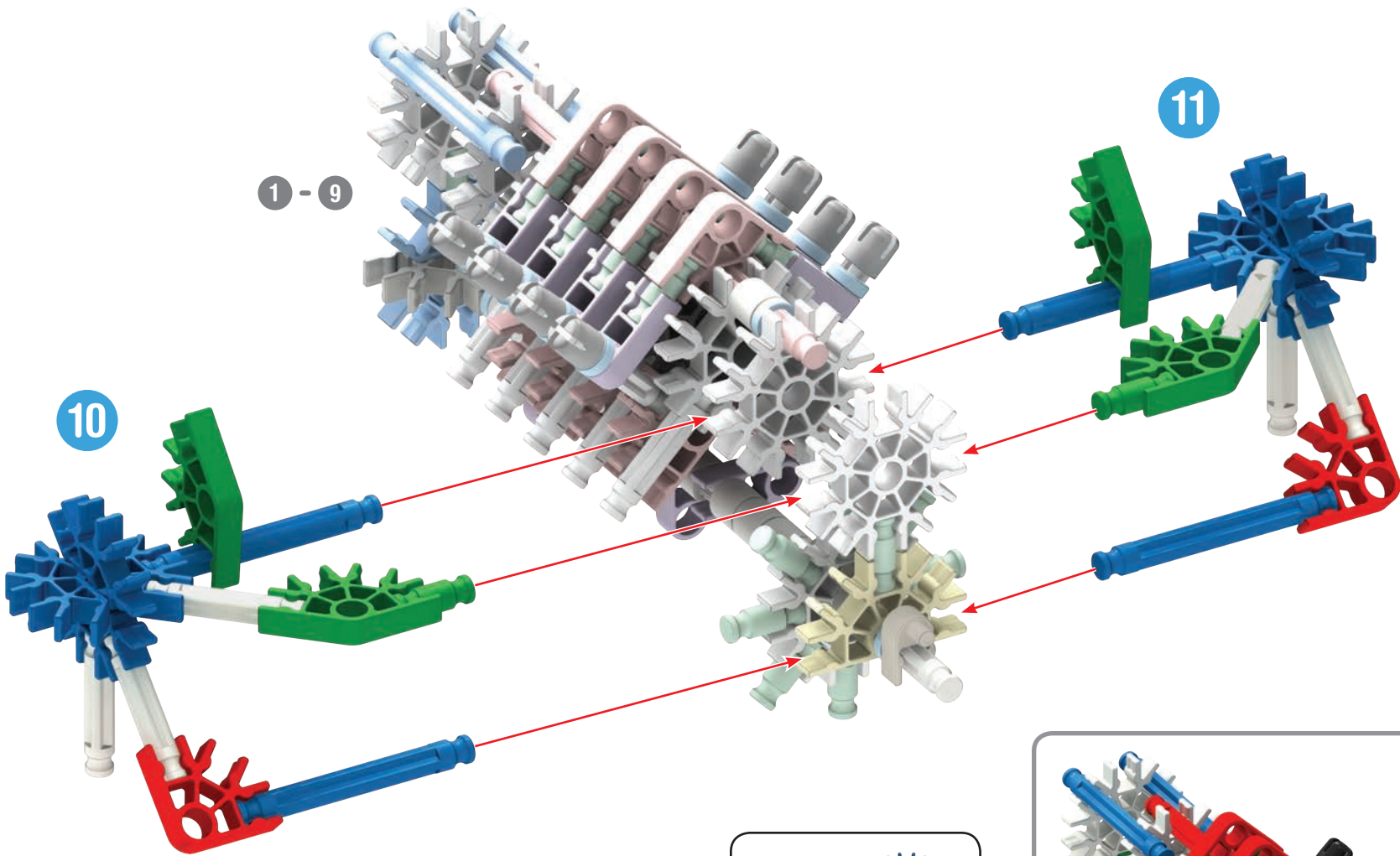

- | | | | |
|---|--|---|--|
| 2 | | 4 | |
| 6 | | 4 | |
| 4 | | 4 | |
| 2 | | 4 | |

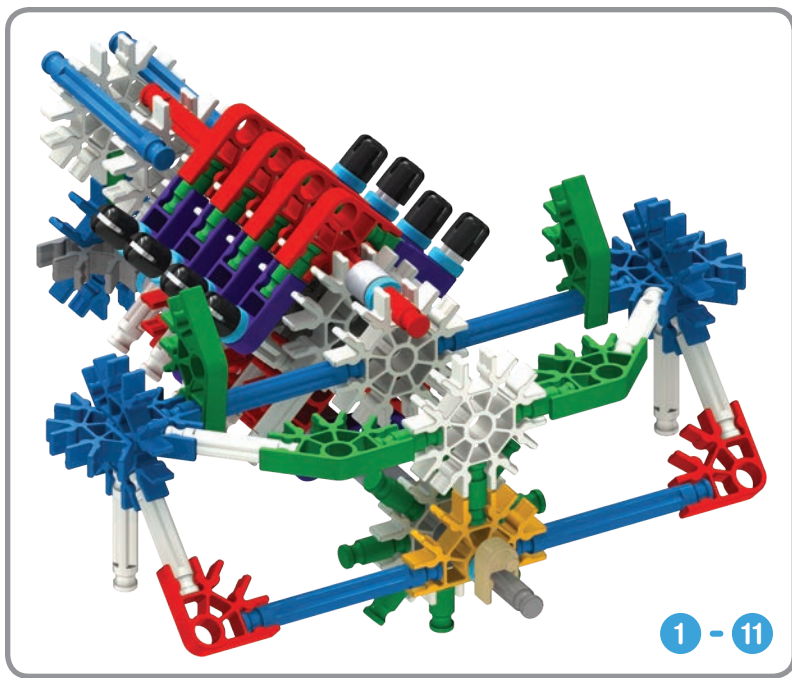

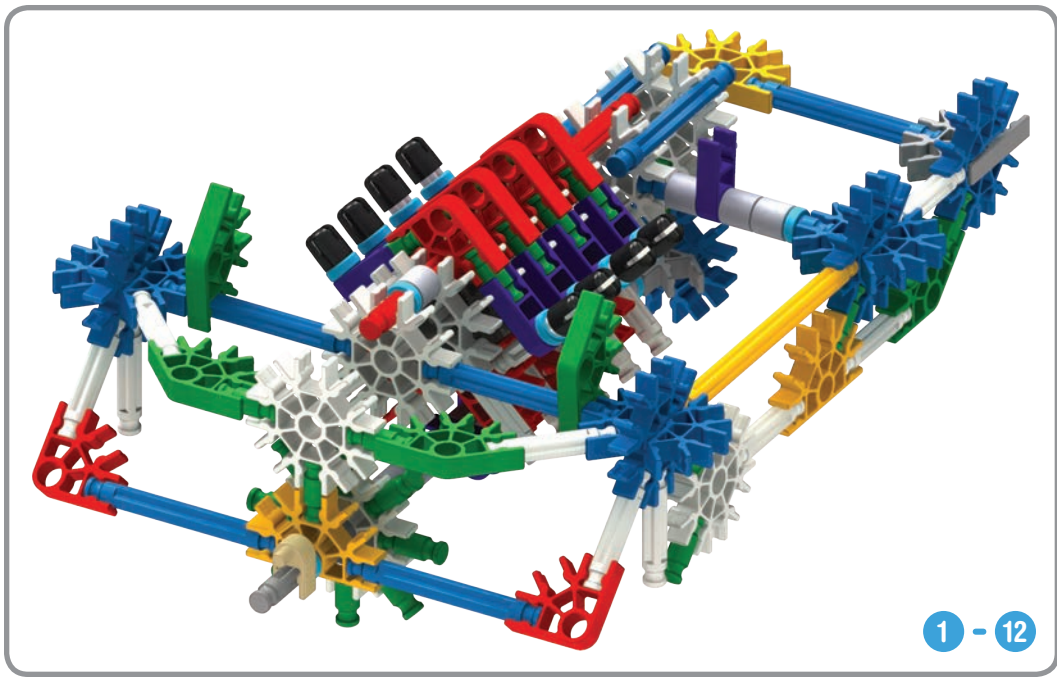

- | | | | | | | | | | |
|---|--|---|--|---|--|---|--|---|--|
| 5 | | 1 | | 3 | | 1 | | 1 | |
| 3 | | 2 | | 1 | | 1 | | 3 | |
| 1 | | 1 | | 2 | | 1 | | 1 | |
| 1 | | | | | | | | | |

1 - 12

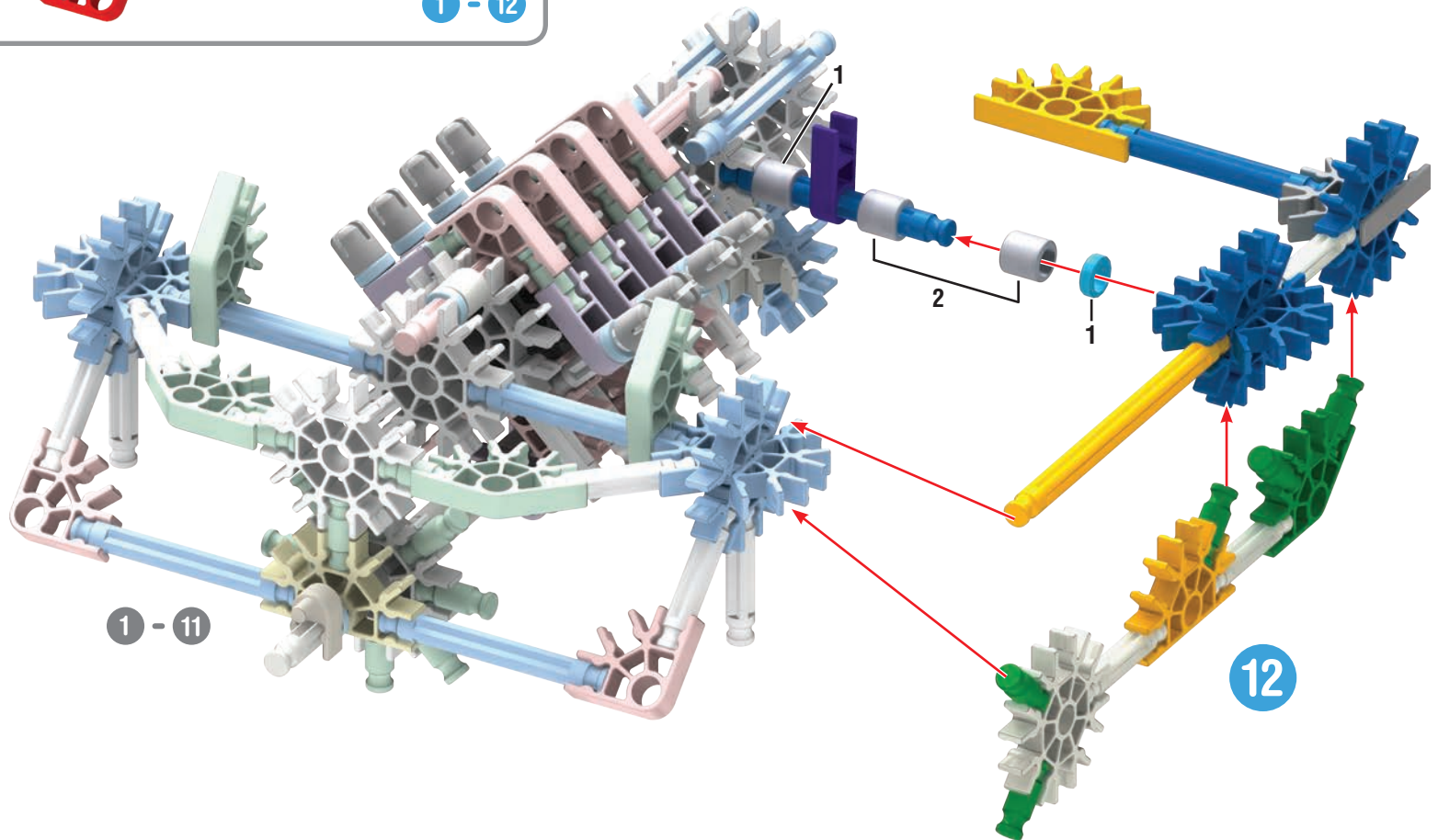

1 - 11

12

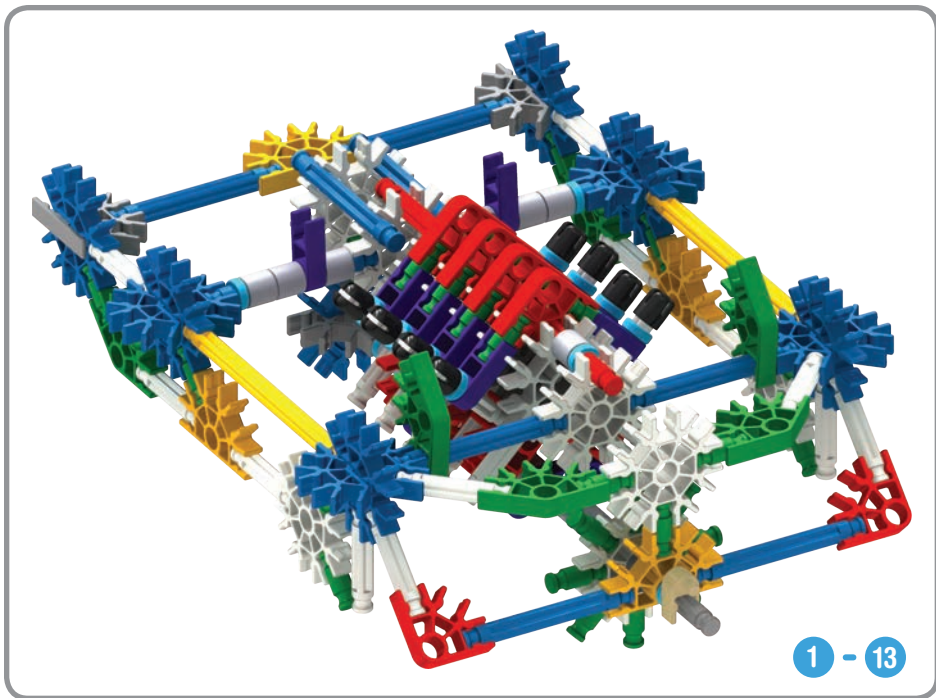

- | | | | | | | | | | |
|---|--|---|--|---|--|---|--|---|--|
| 5 | | 1 | | 3 | | 1 | | 1 | |
| 3 | | | | | | | | | |
| 2 | | | | | | | | | |
| 1 | | | | | | | | | |
| 1 | | 1 | | 1 | | 1 | | 3 | |

1 - 13

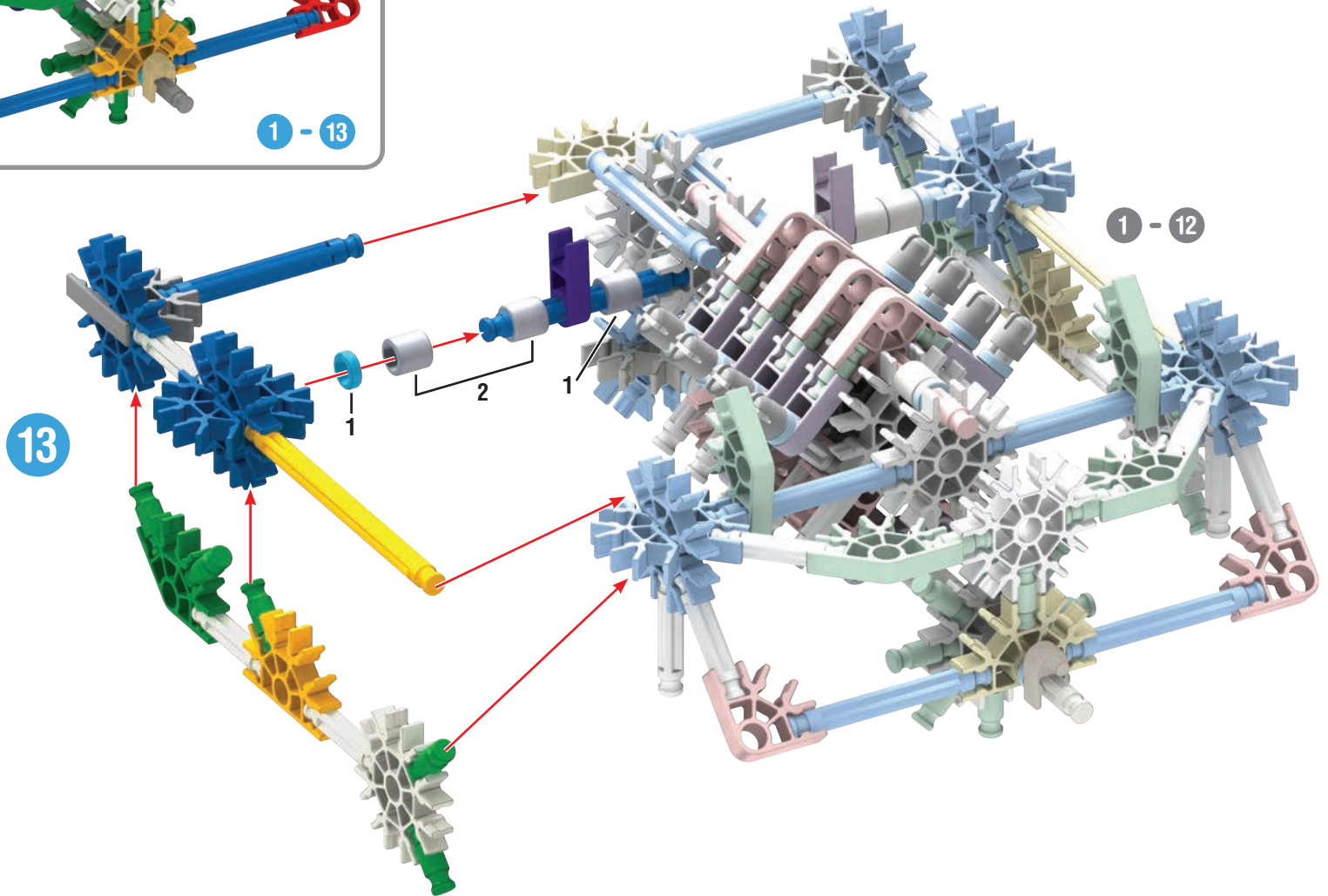

1 - 12

13

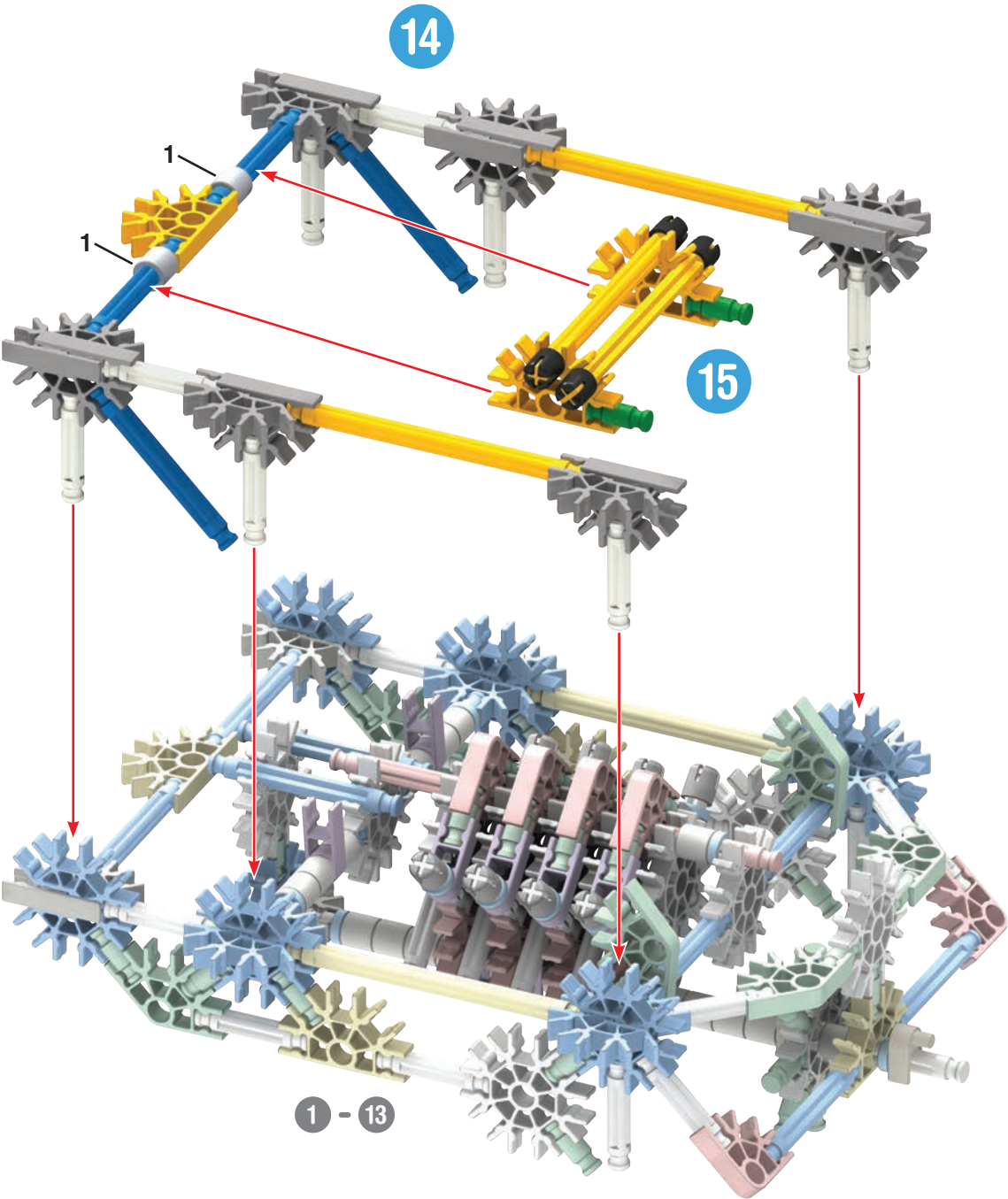

| | | | | | |
|---|--|---|--|----|--|
| 2 | | 4 | | 3 | |
| 6 | | 2 | | | |
| 4 | | | | 12 | |
| 4 | | | | | |

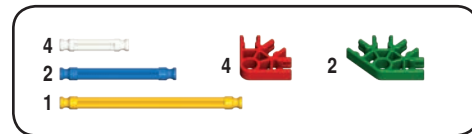
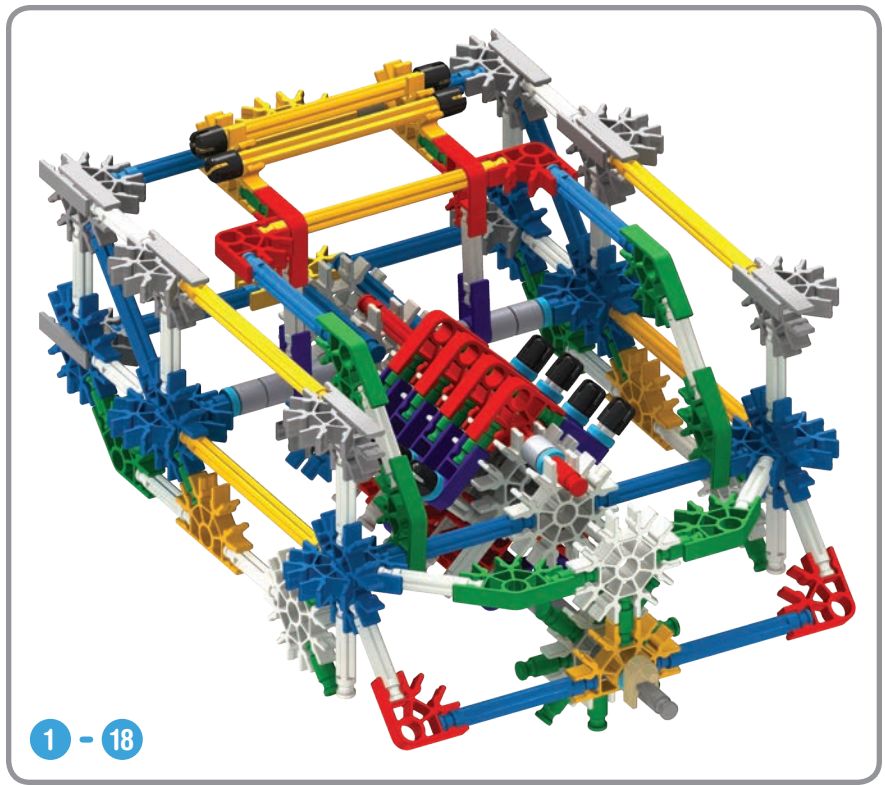
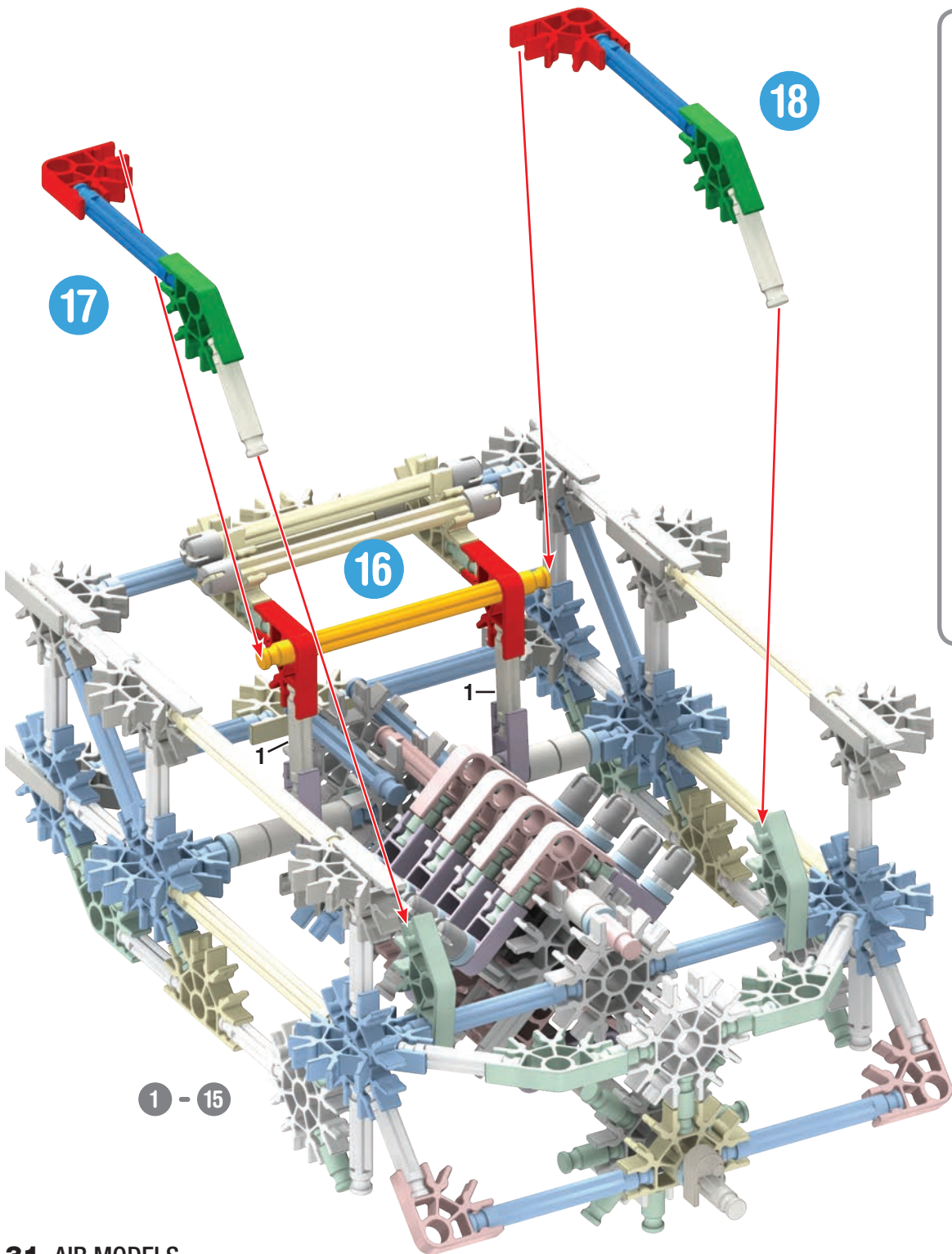

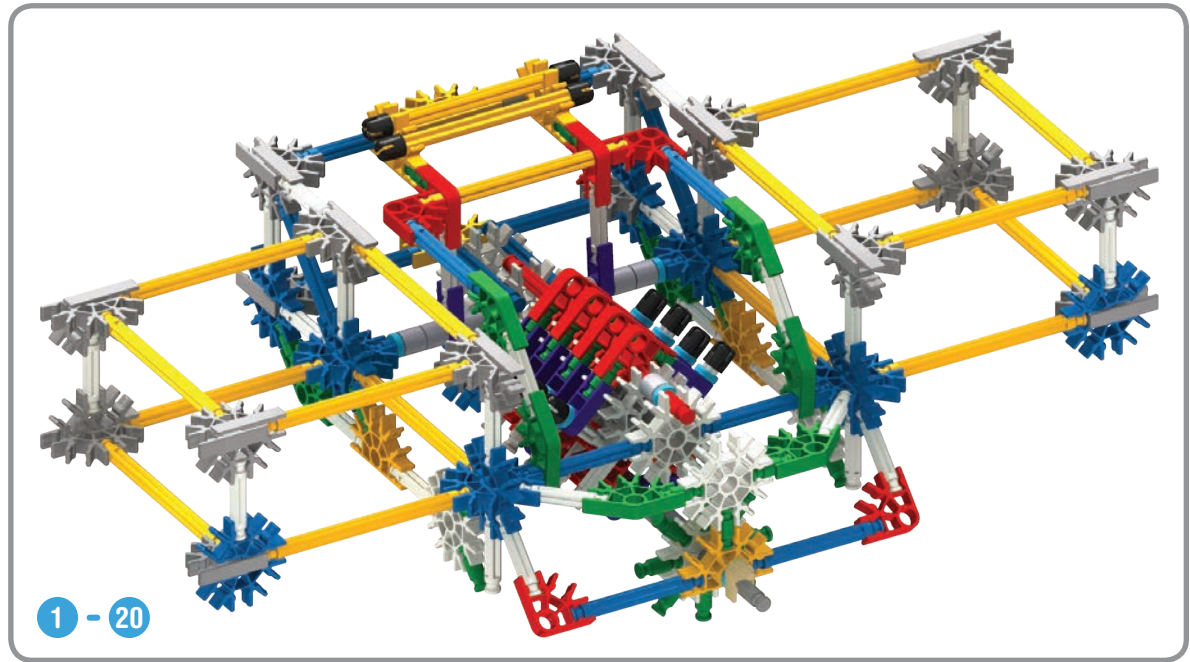
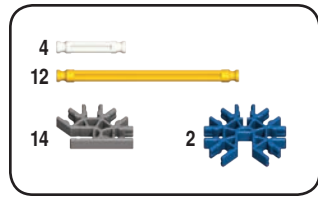
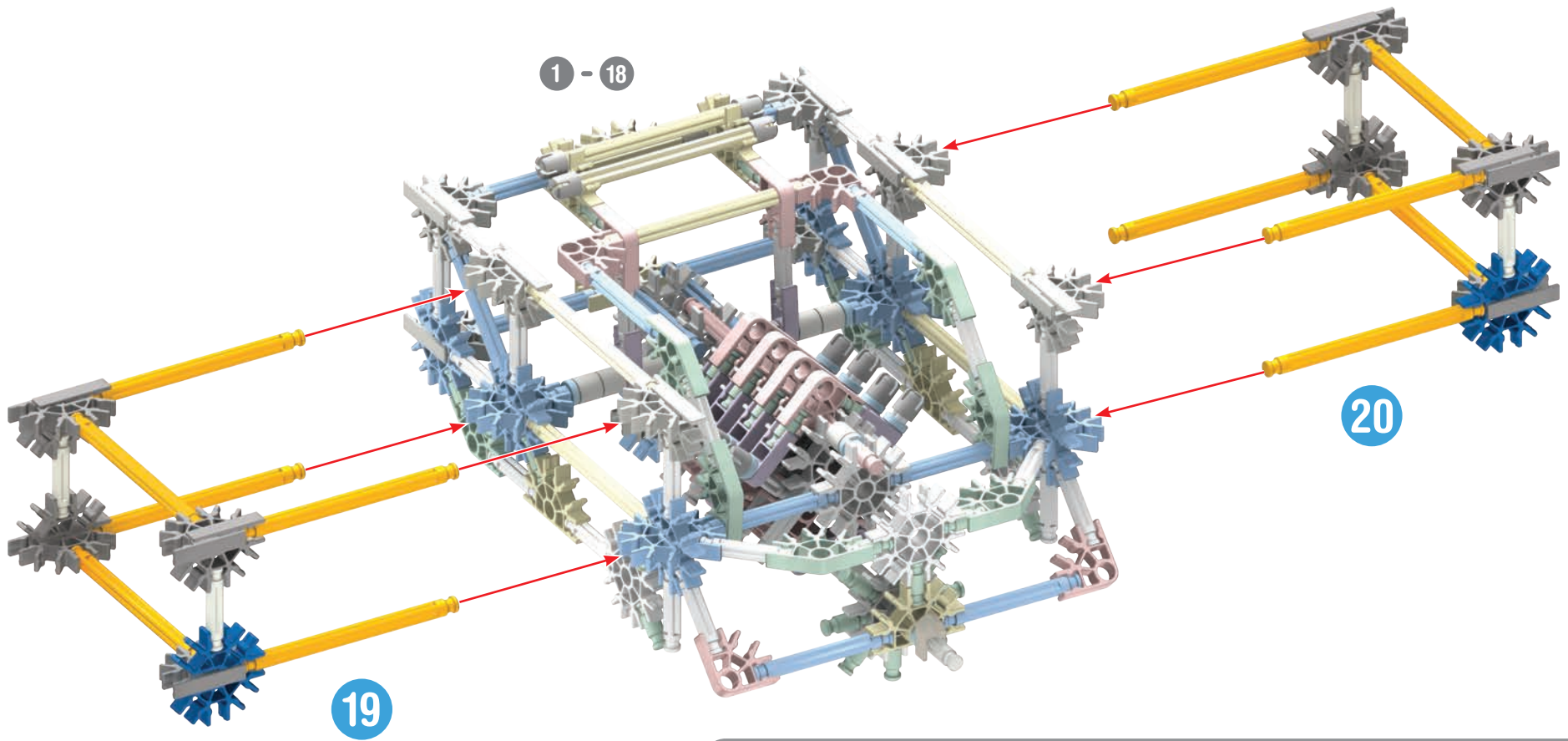

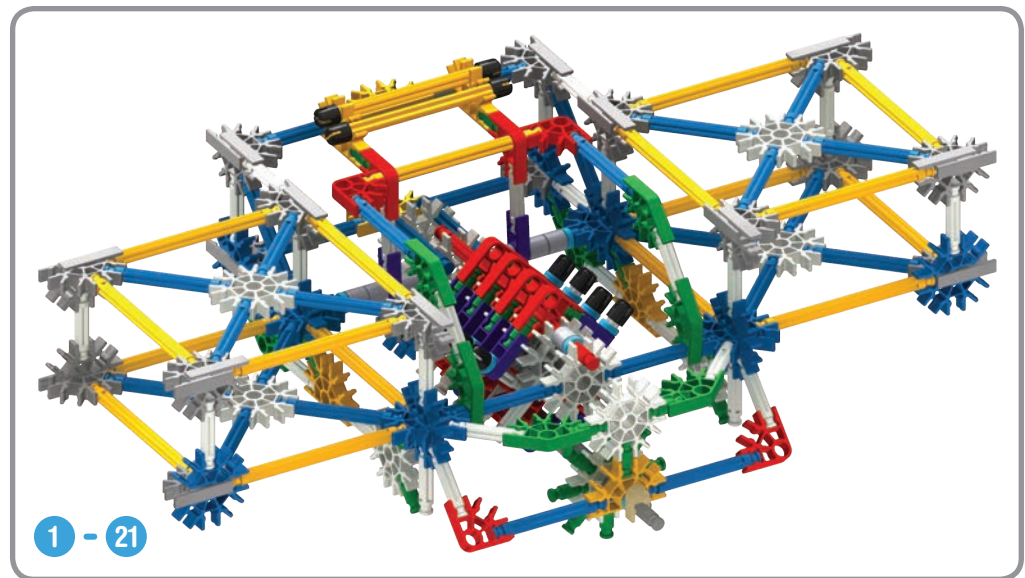
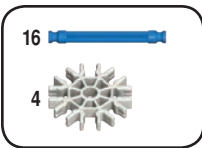
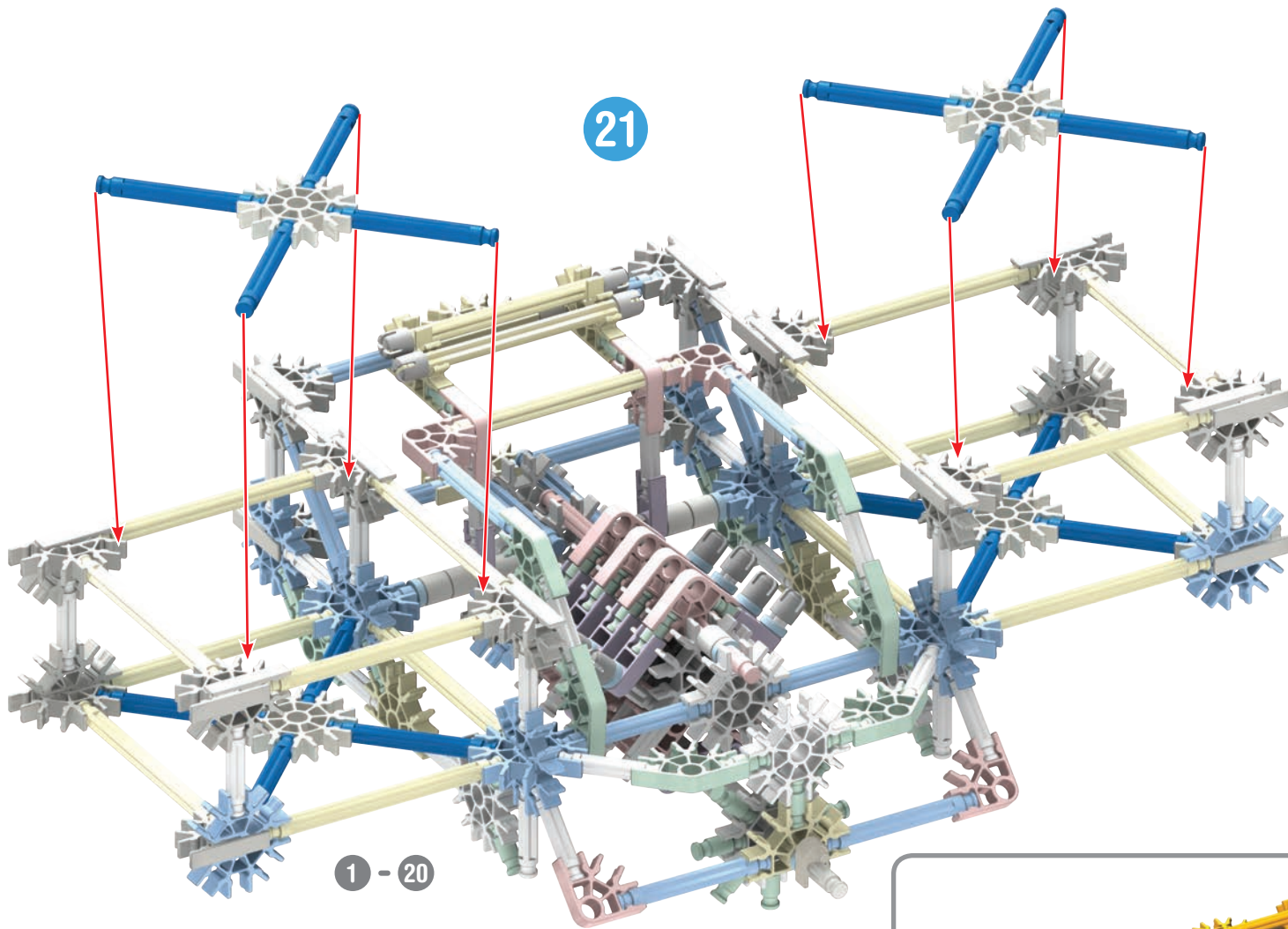

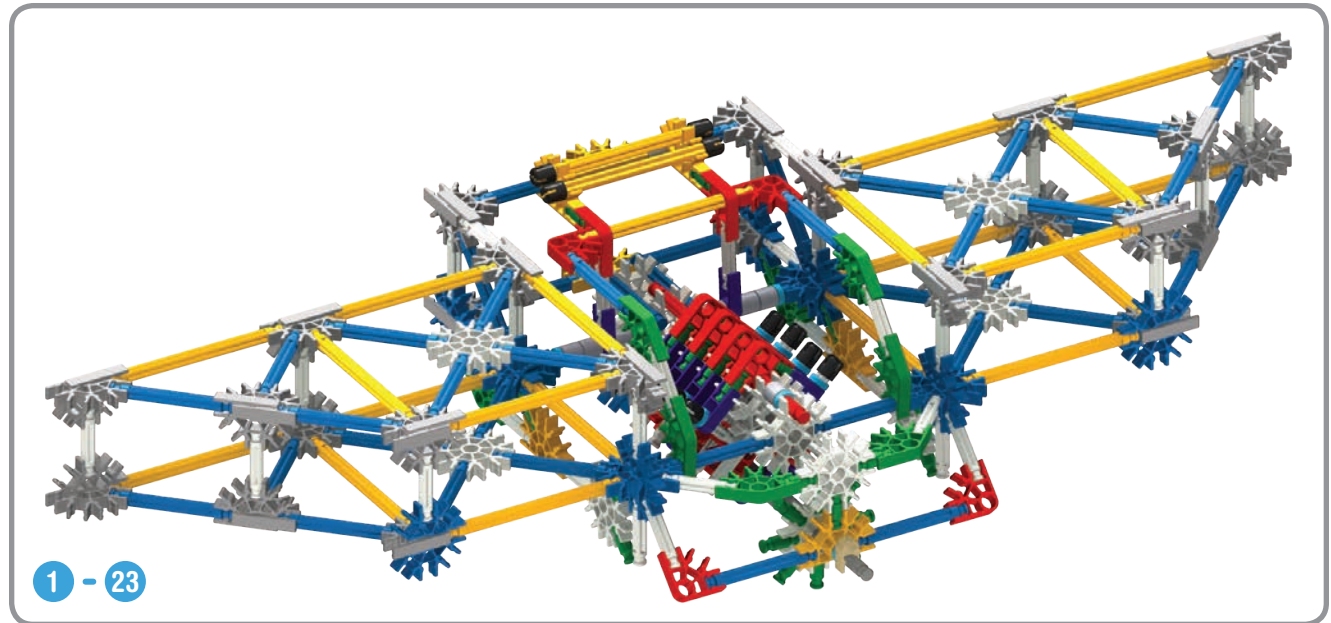
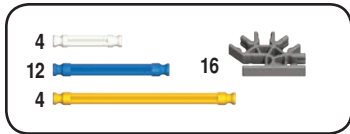
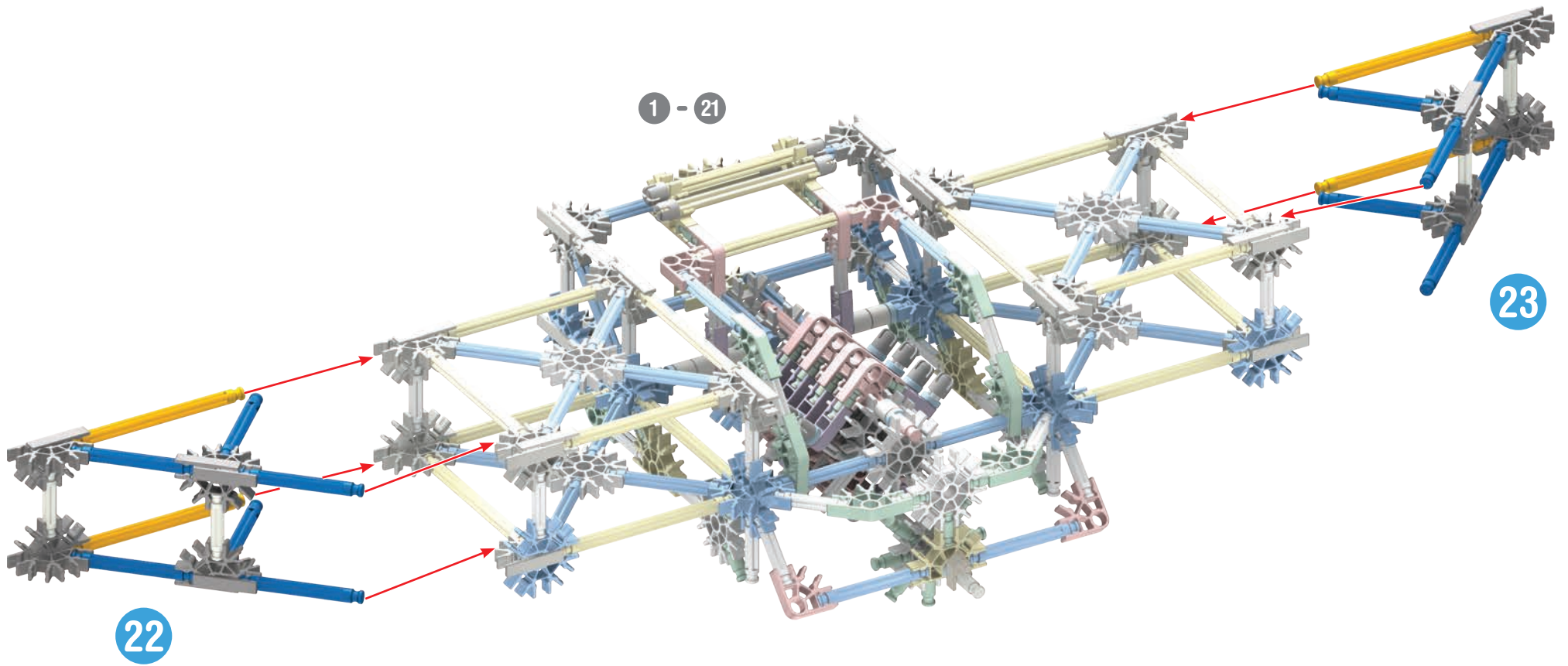

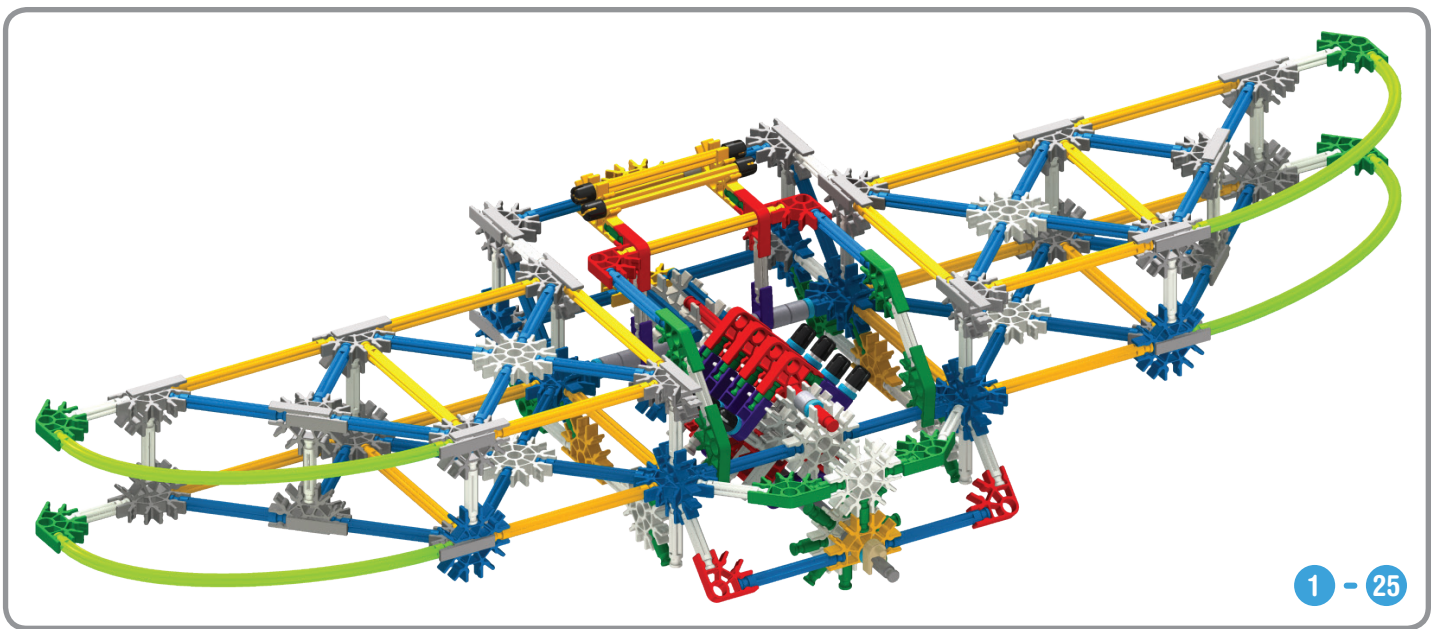
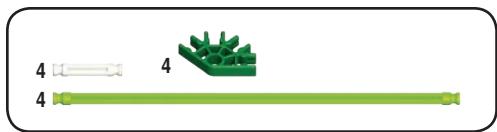
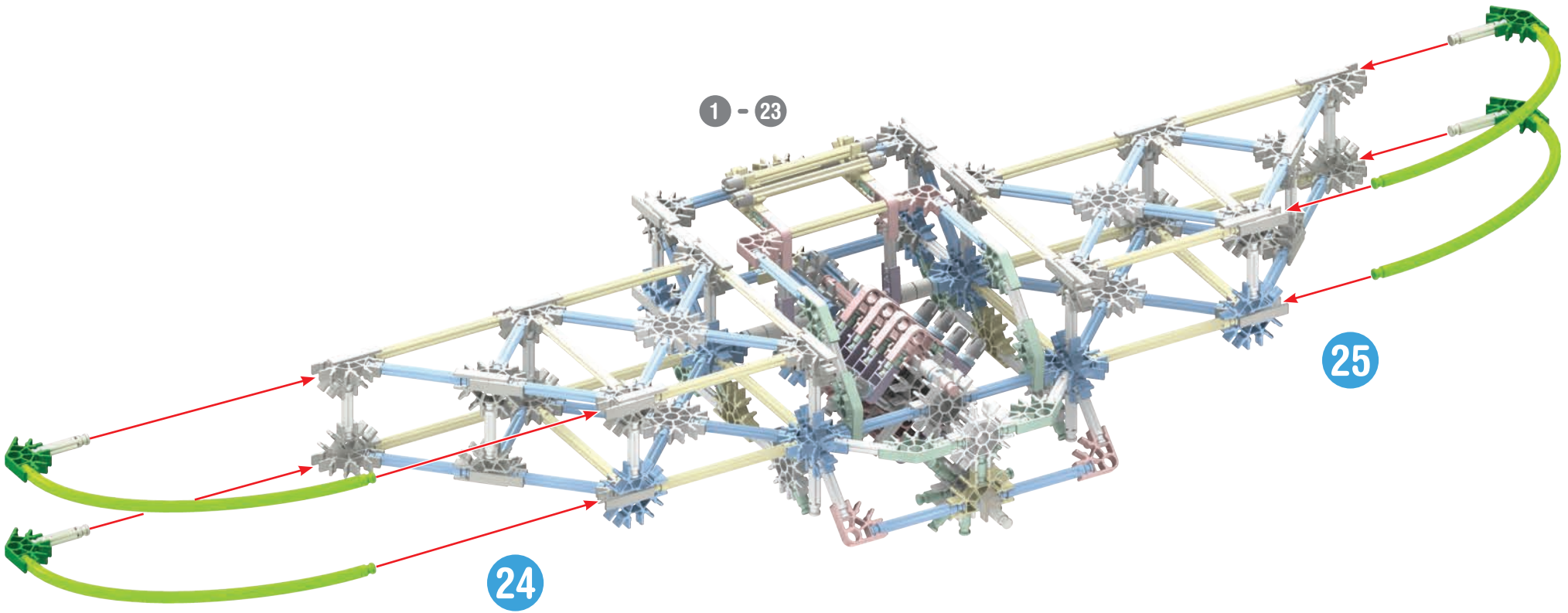

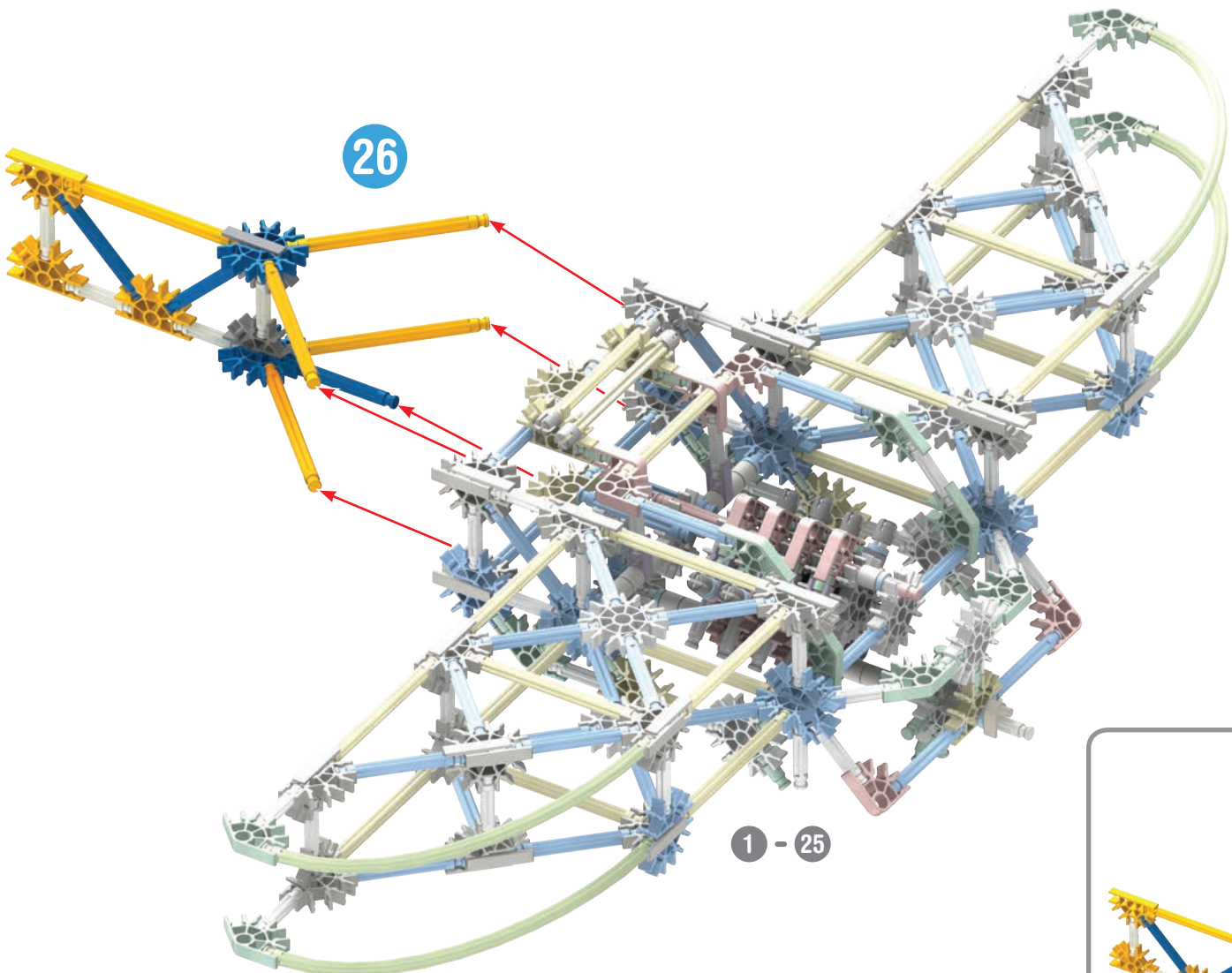

26

1 - 25

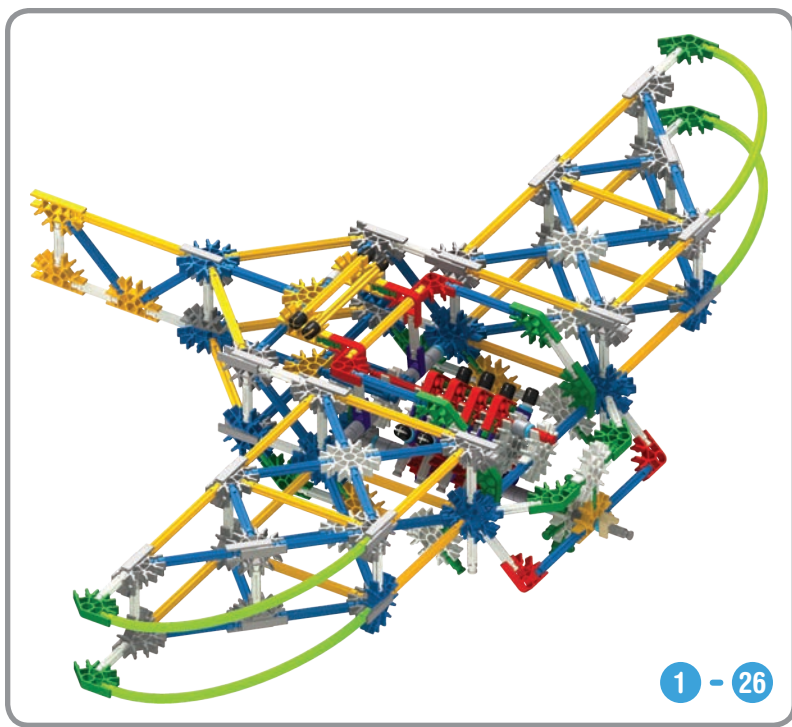
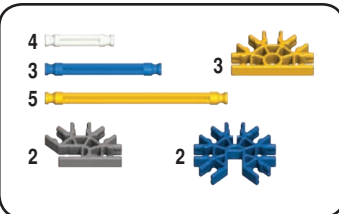

1 - 26

| | | | |
|----|--|---|--|
| 2 | | 2 | |
| 17 | | 1 | |
| 2 | | 2 | |

27

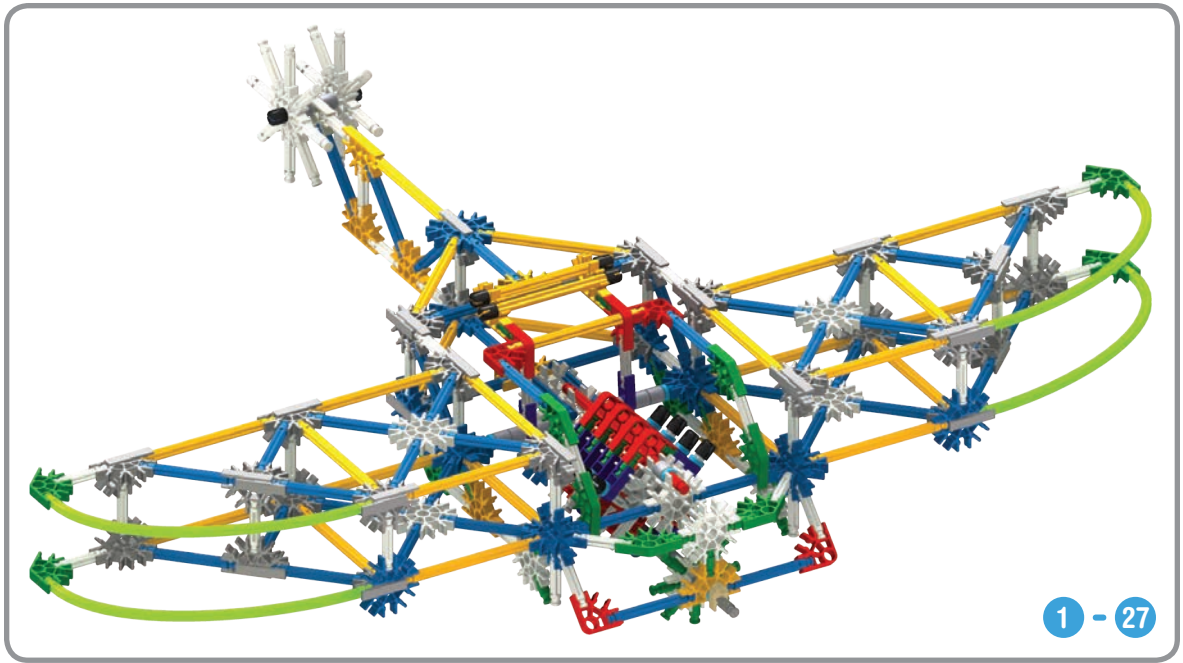
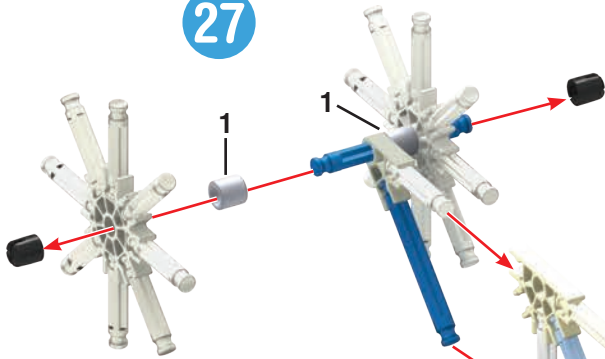

1 - 27

1 - 26

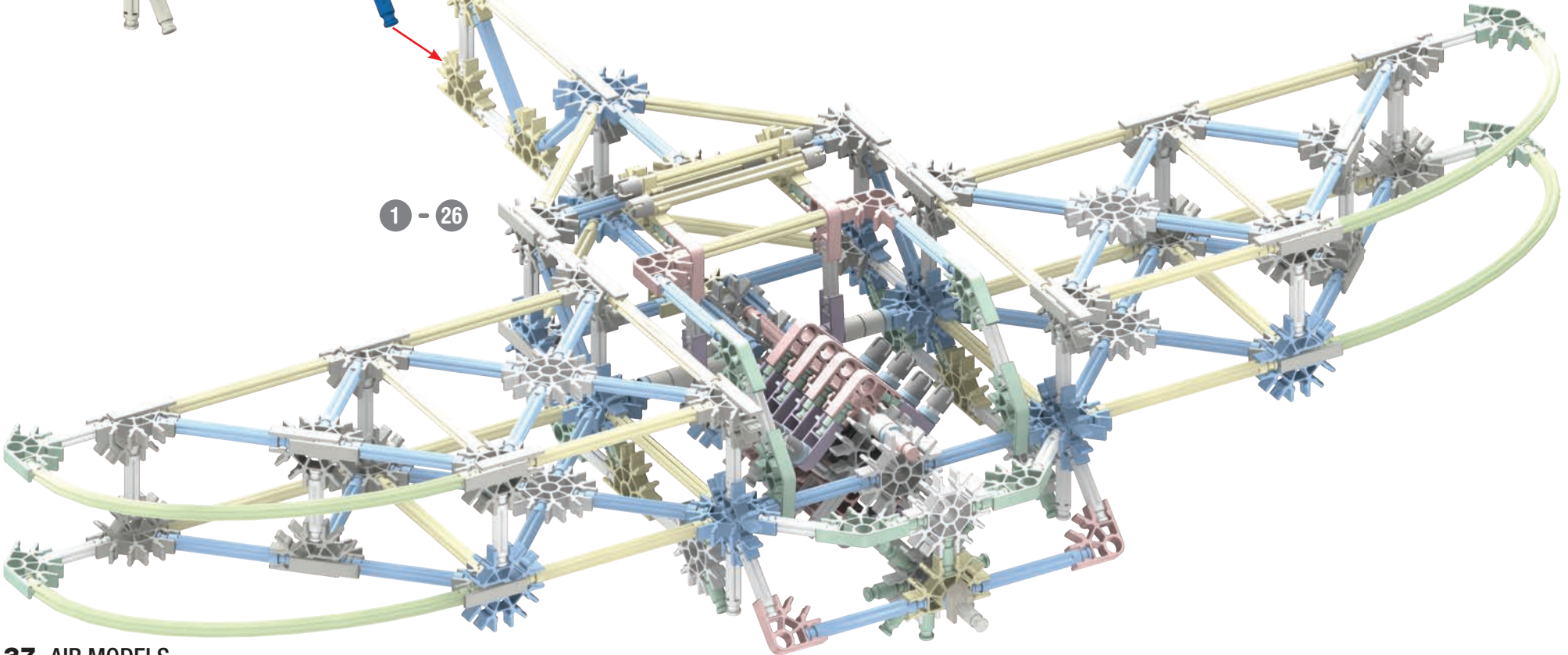

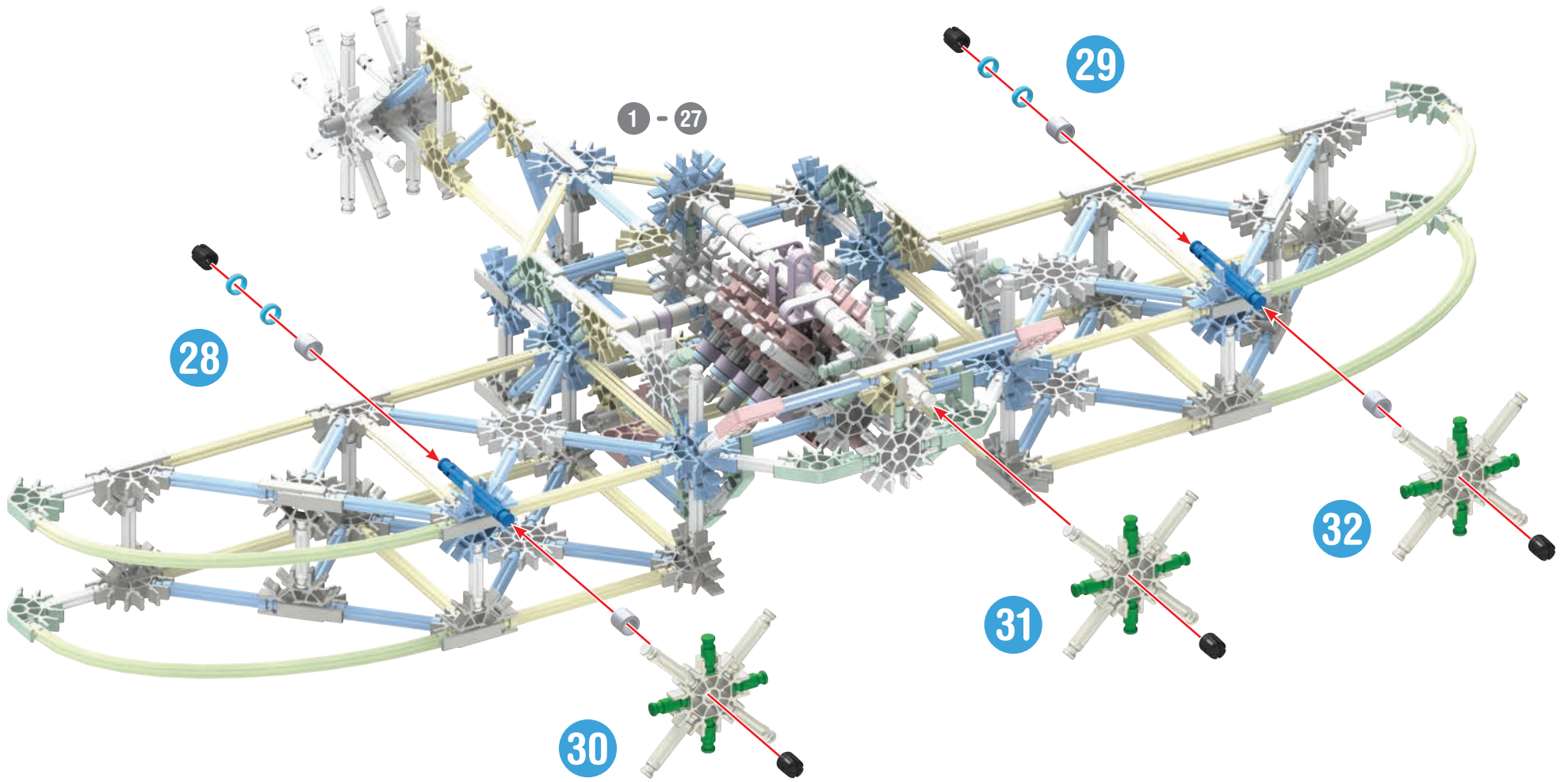

- | | | | |
|----|--|---|--|
| 12 | | 3 | |
| 12 | | | |
| 2 | | | |
| 5 | | 4 | |
| | | 4 | |

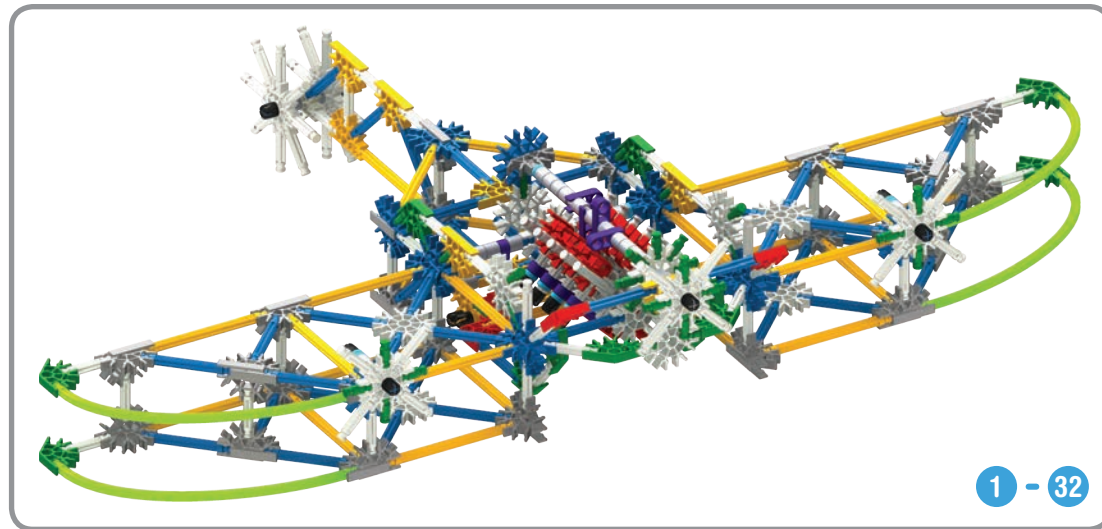

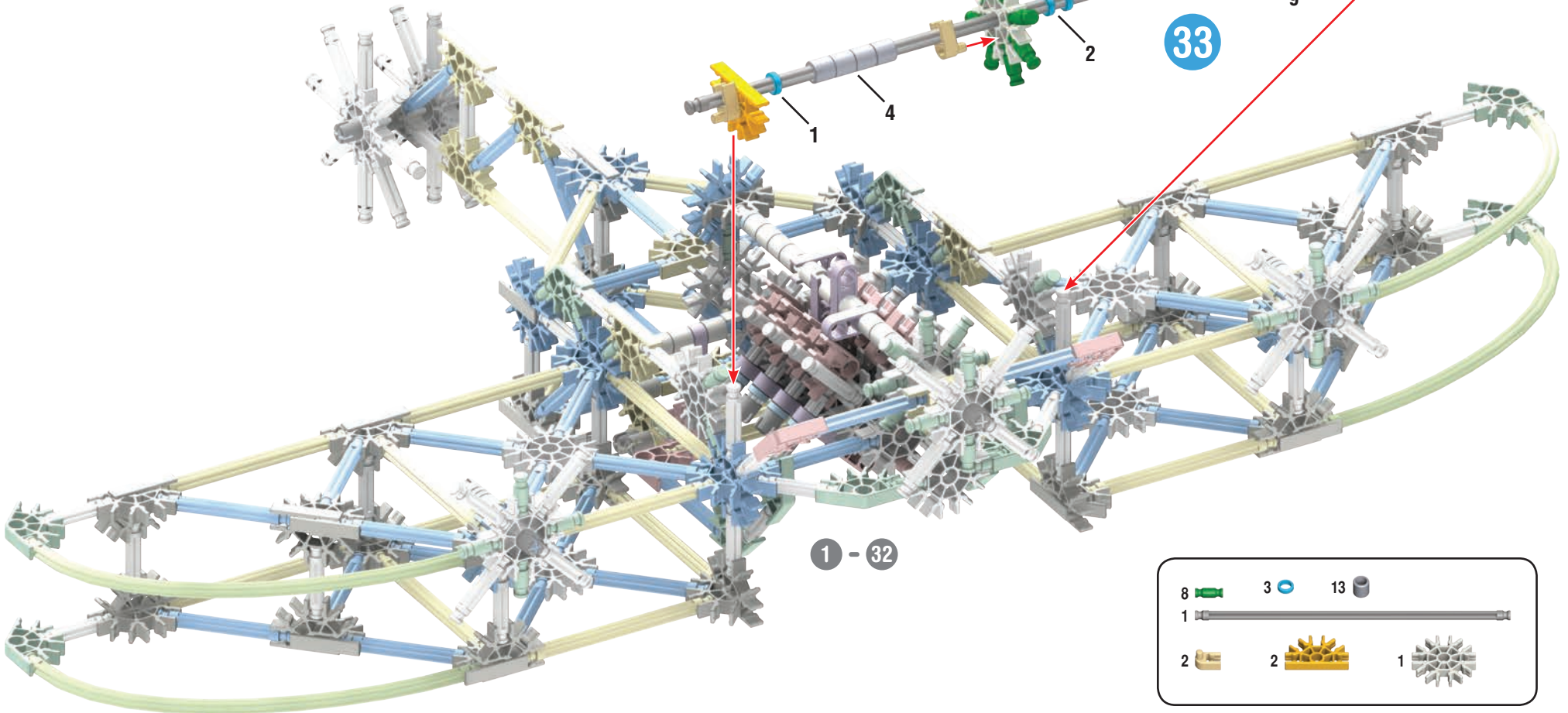
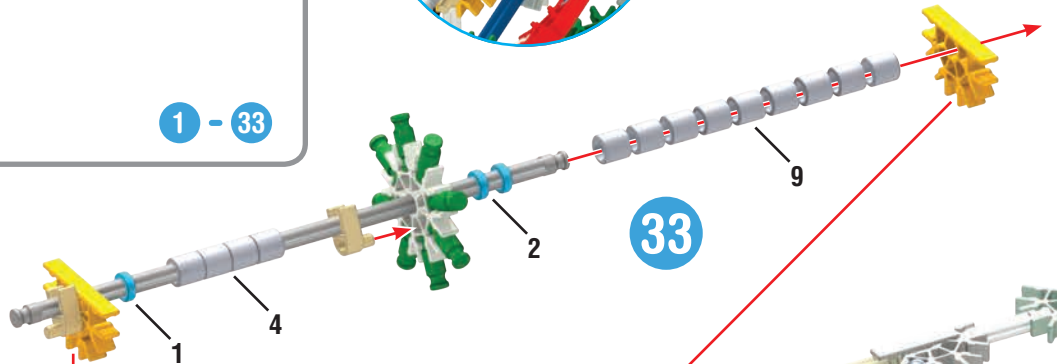
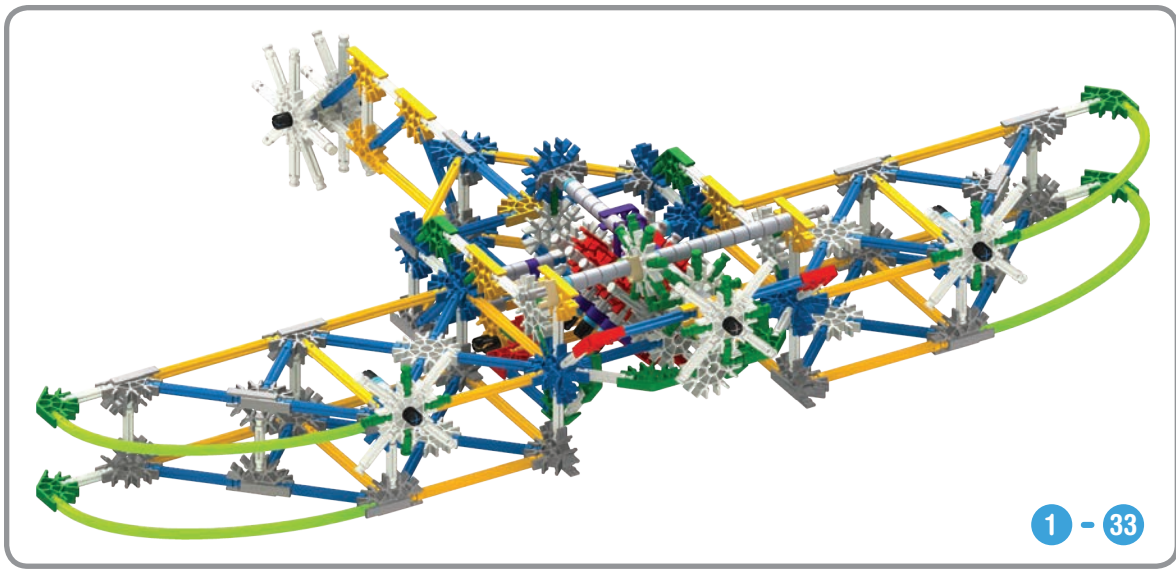

| | | | | | |
|---|--|---|--|----|--|
| 8 | | 3 | | 13 | |
| 1 | | | | | |
| 2 | | 2 | | 1 | |

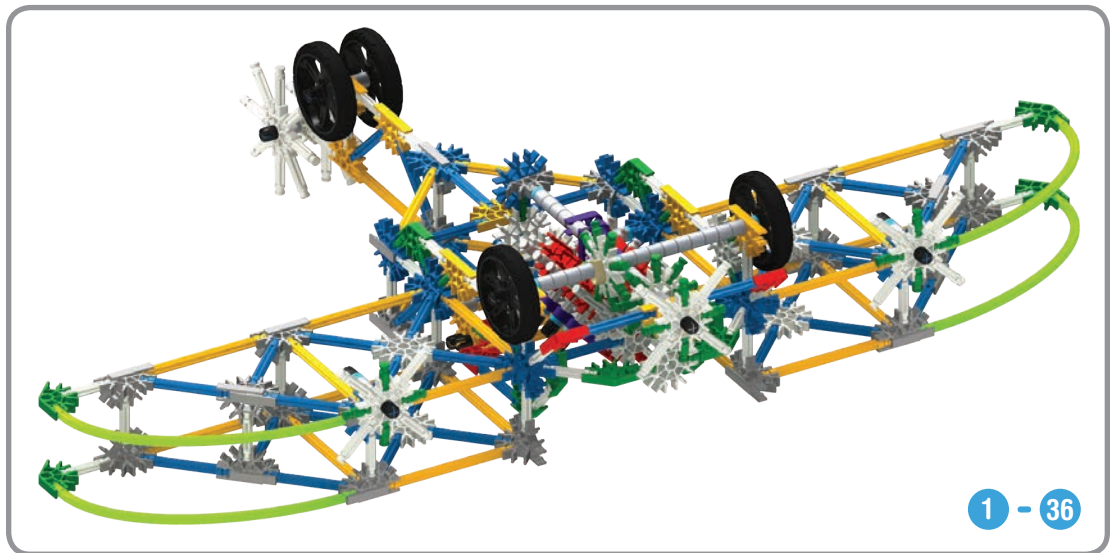
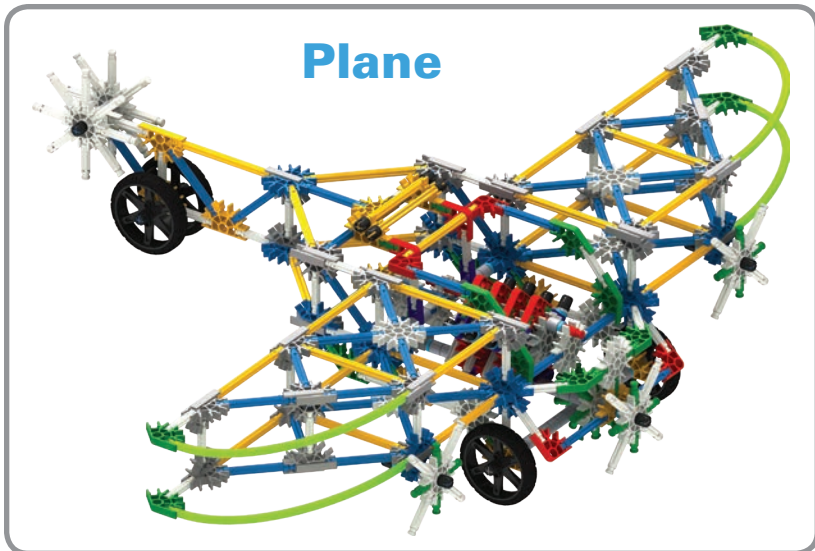
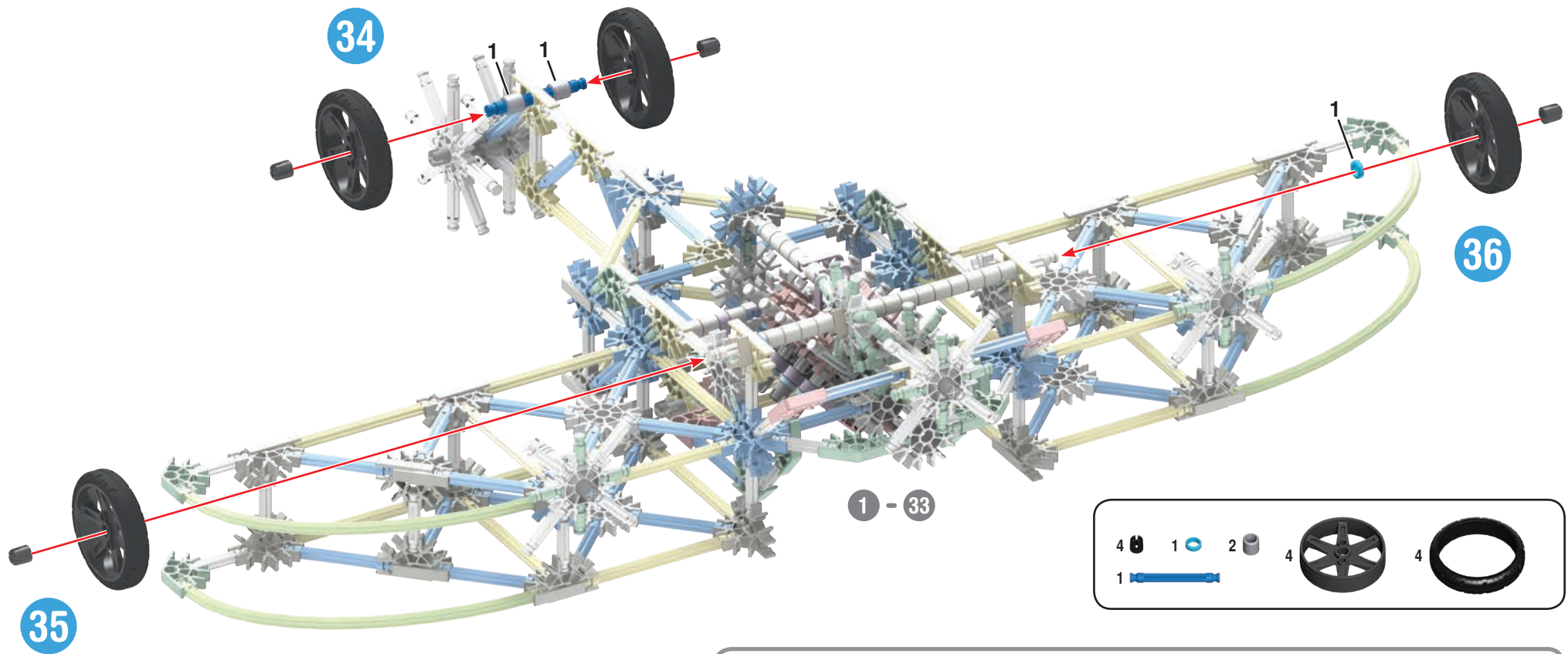

Space Jet

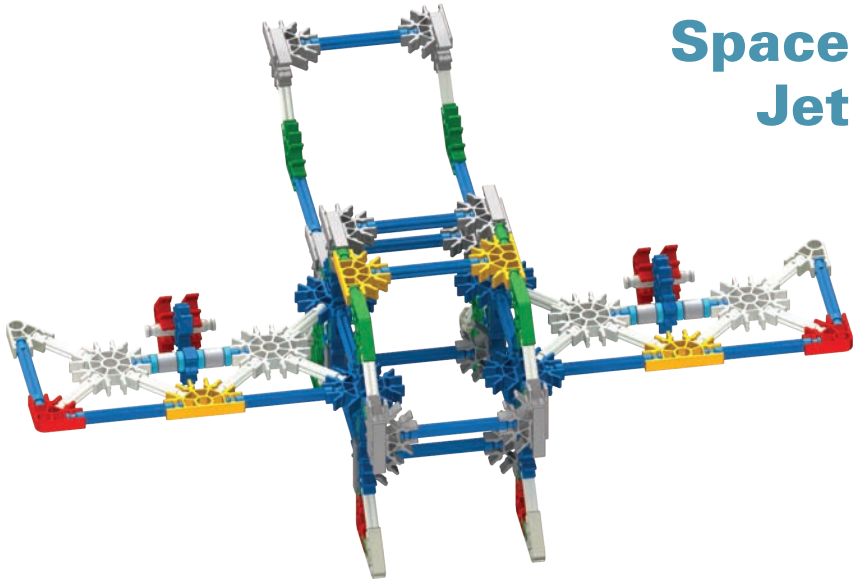

| | | | |
|----|--|---|--|
| 10 | | 4 | |
| 6 | | 4 | |
| 4 | | 4 | |
| 2 | | 4 | |
| 4 | | 4 | |

2

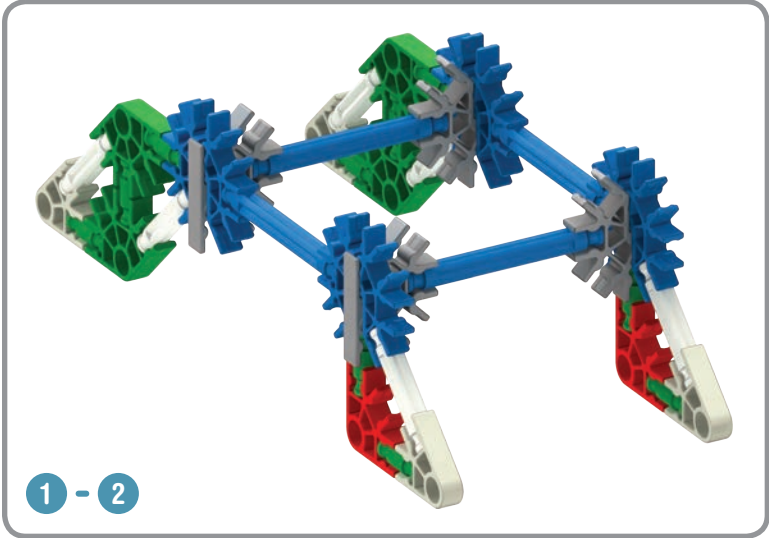
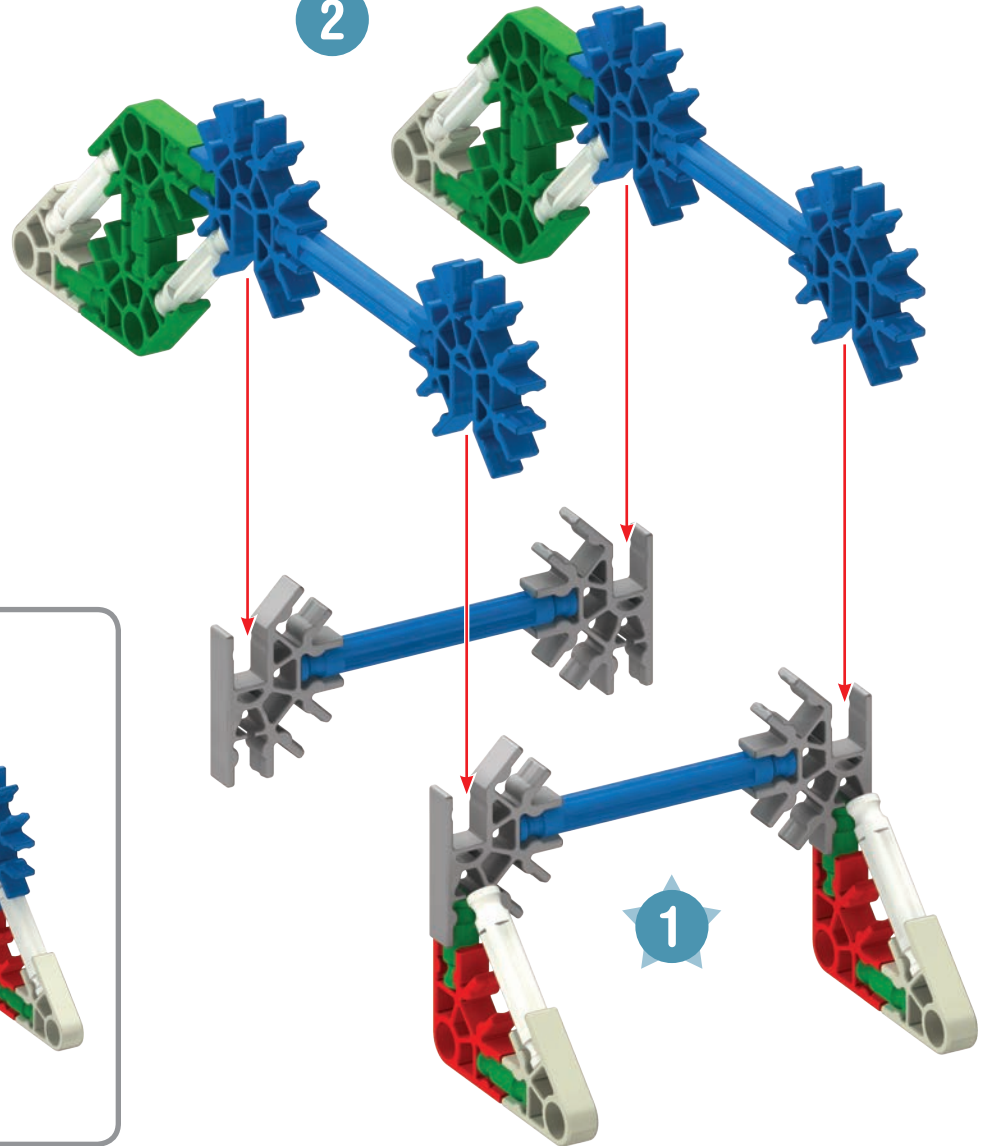

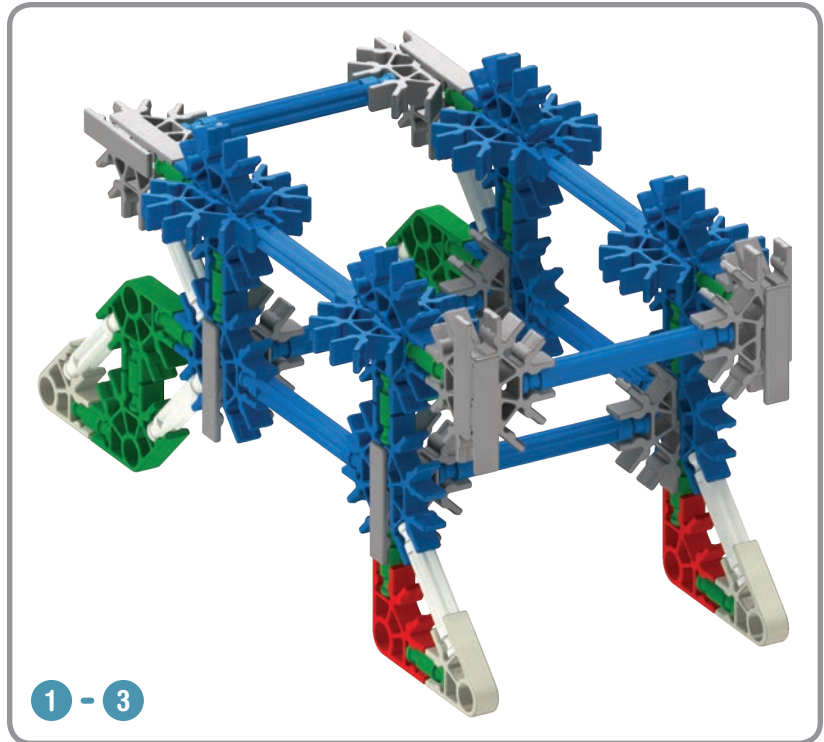
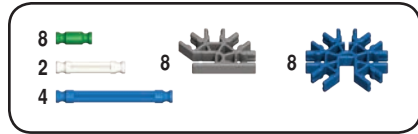
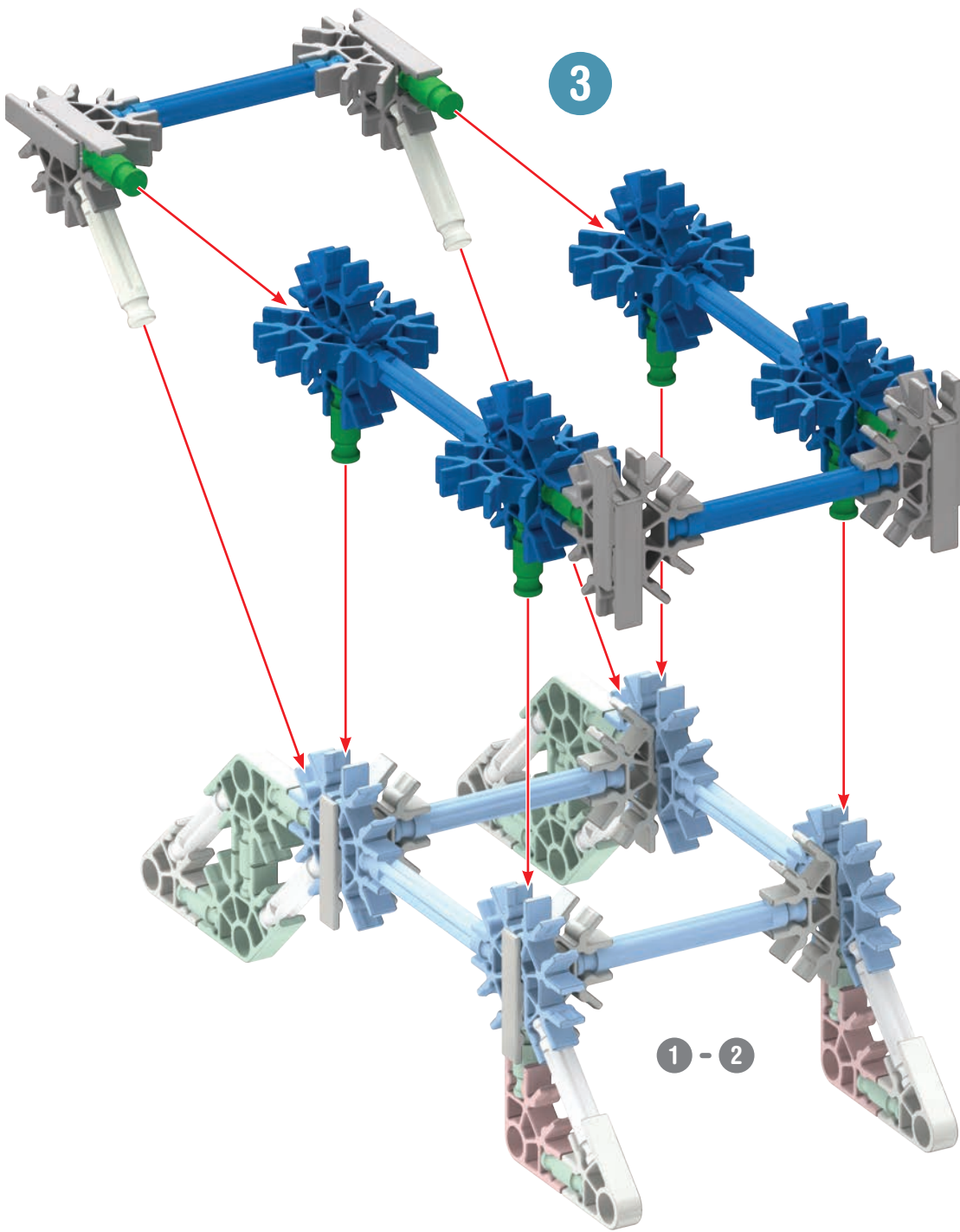

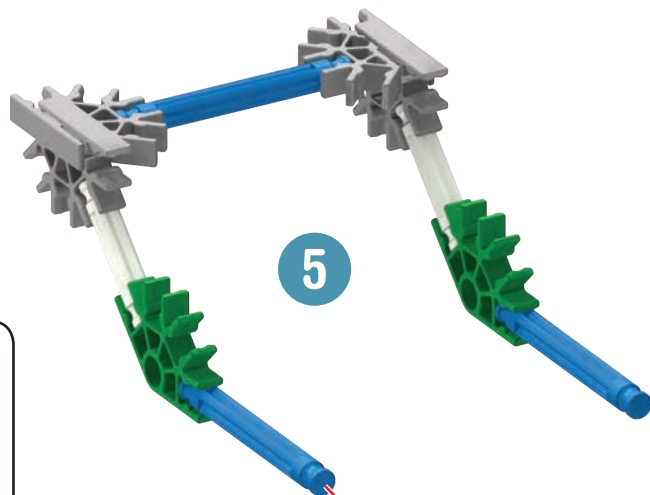
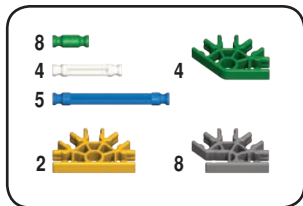

5

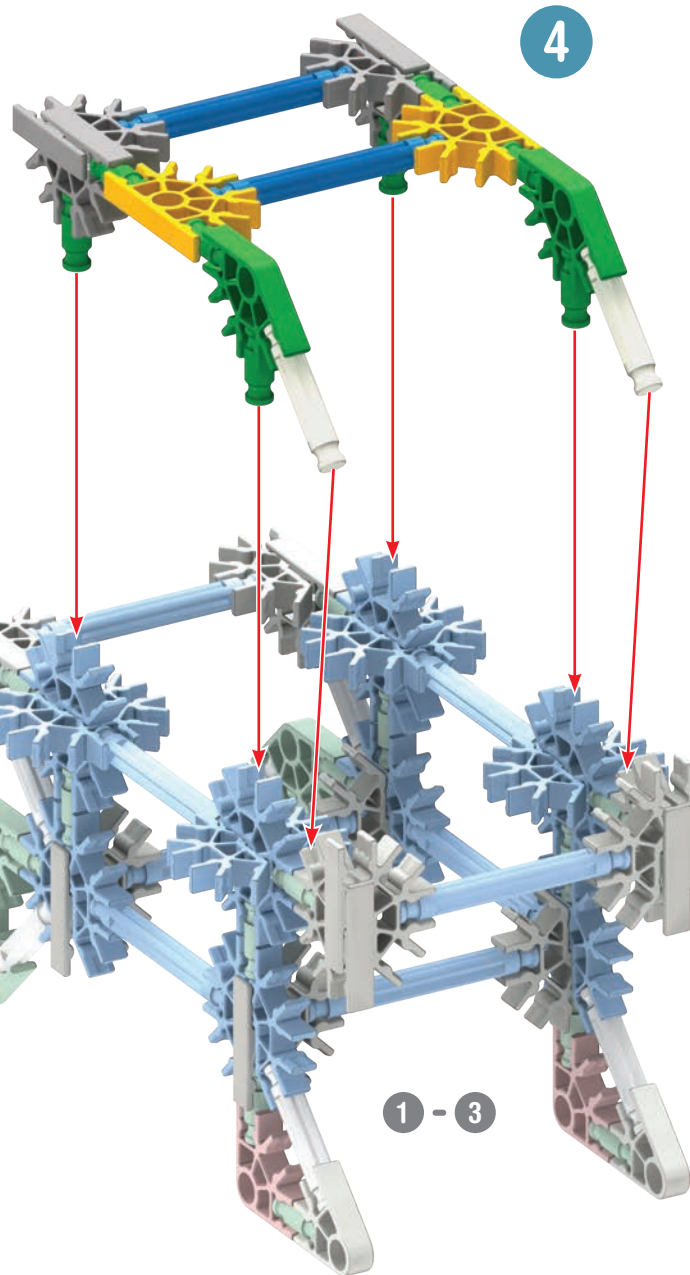

4

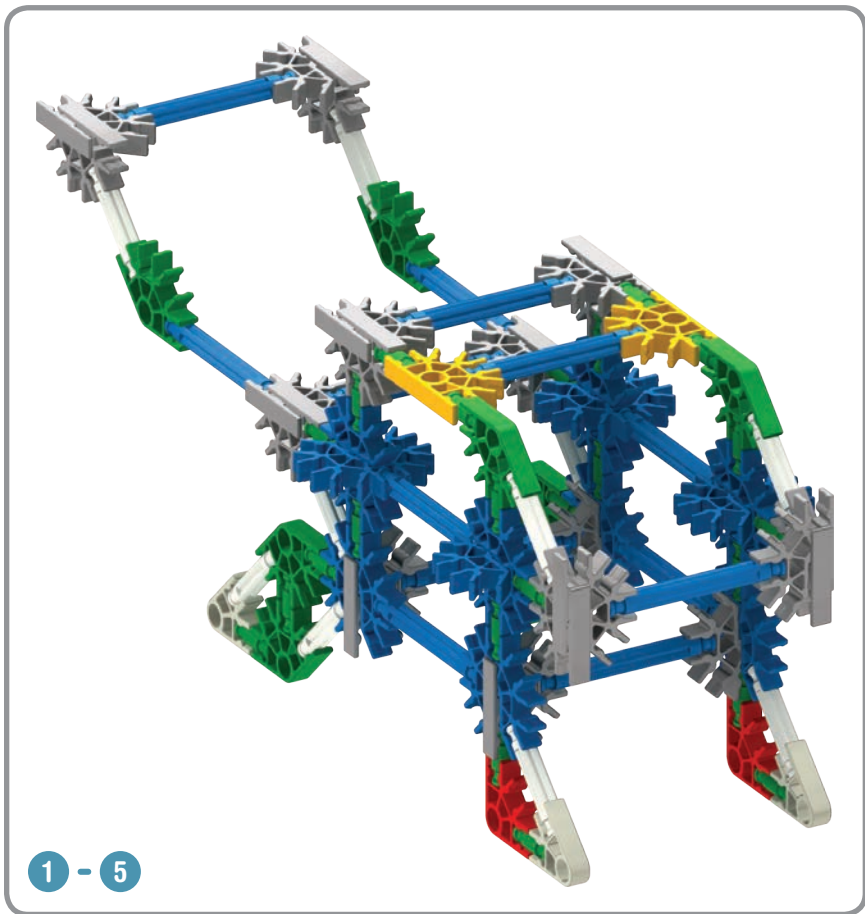

1 - 5

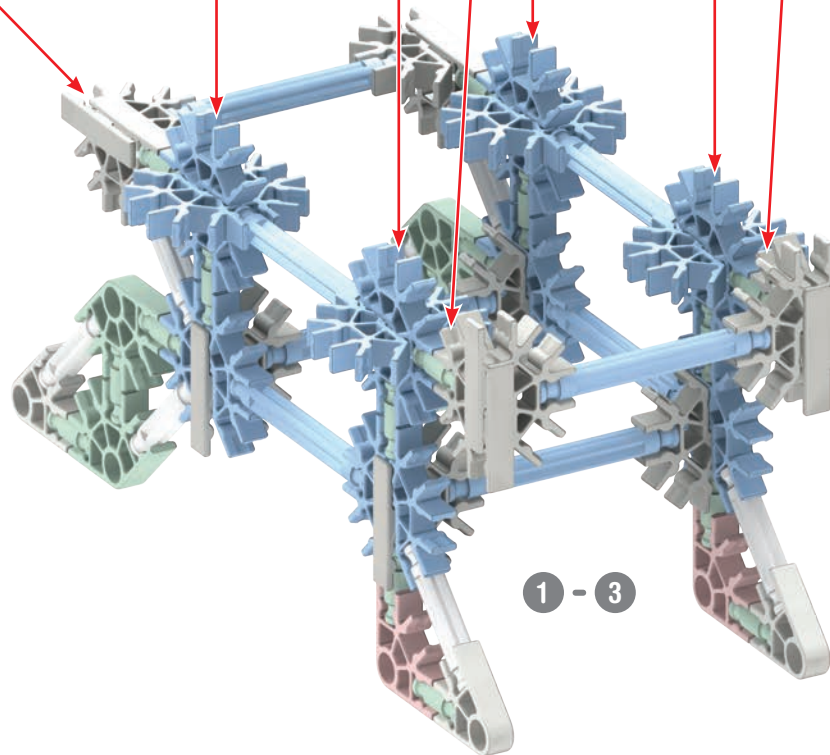

1 - 3

x2

6

7

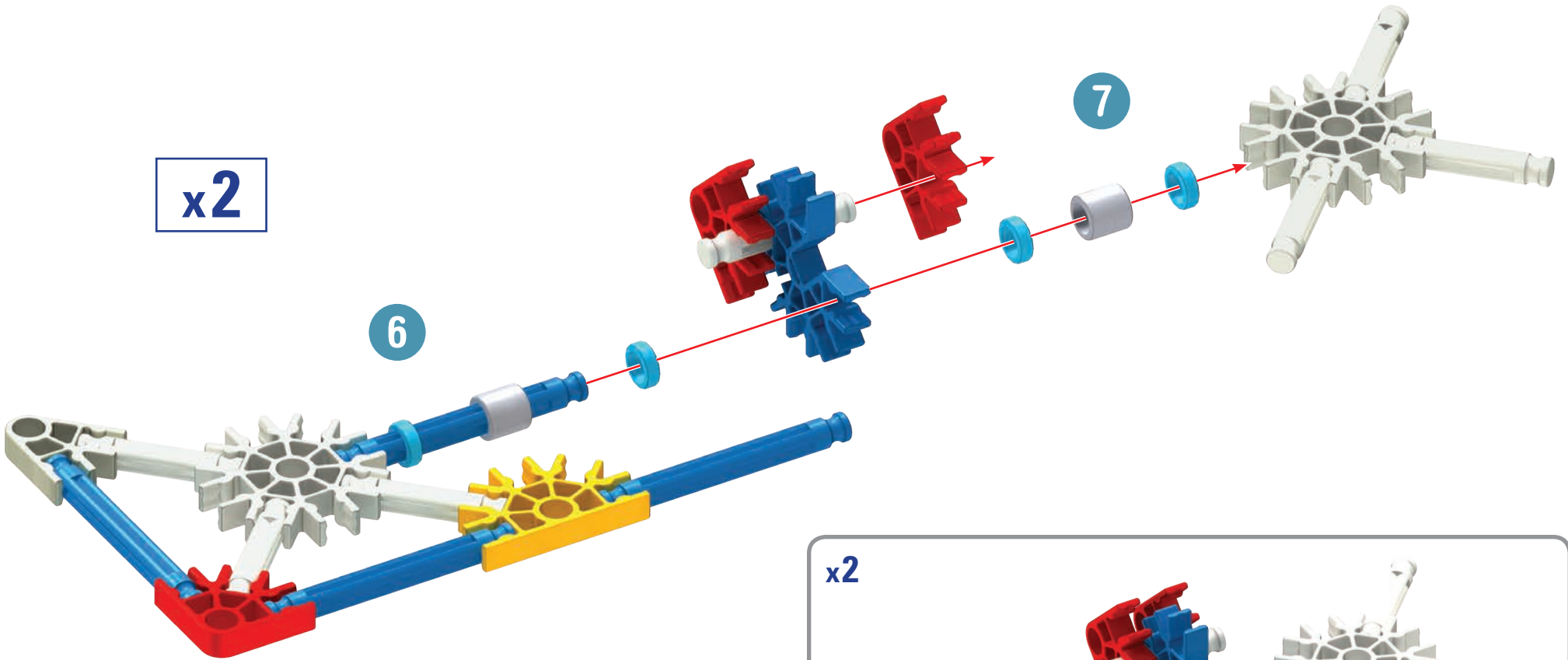

- | | | | | | | | | |
|----|--|---|--|---|--|---|--|--|
| 8 | | 4 | | 2 | | 2 | | |
| 14 | | 6 | | 2 | | 4 | | |
| 8 | | | | | | | | |

x2

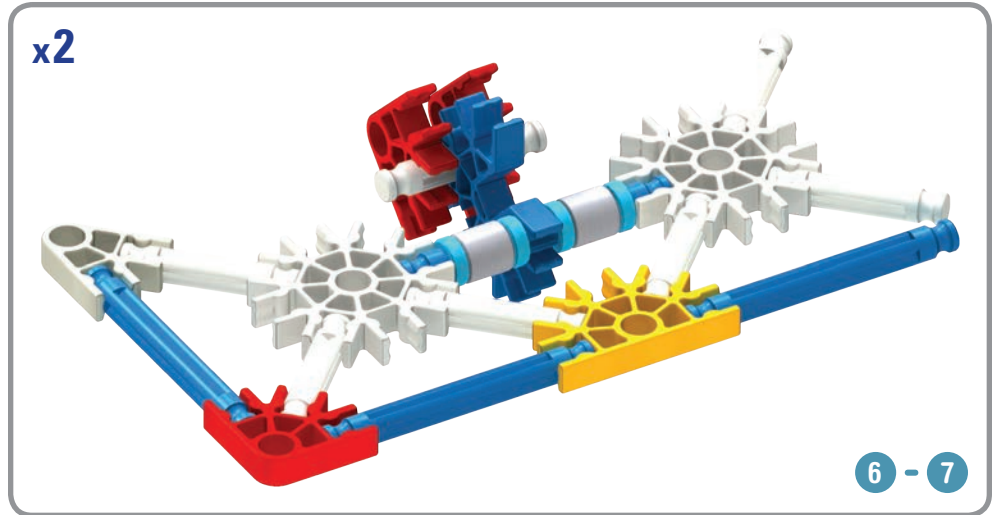

6 - 7

Space Jet

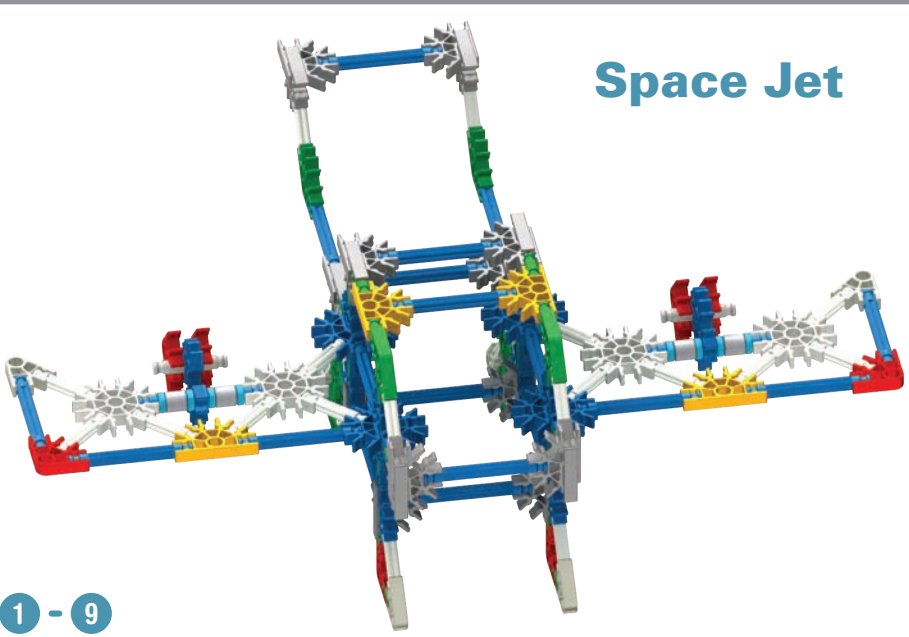

1 - 9

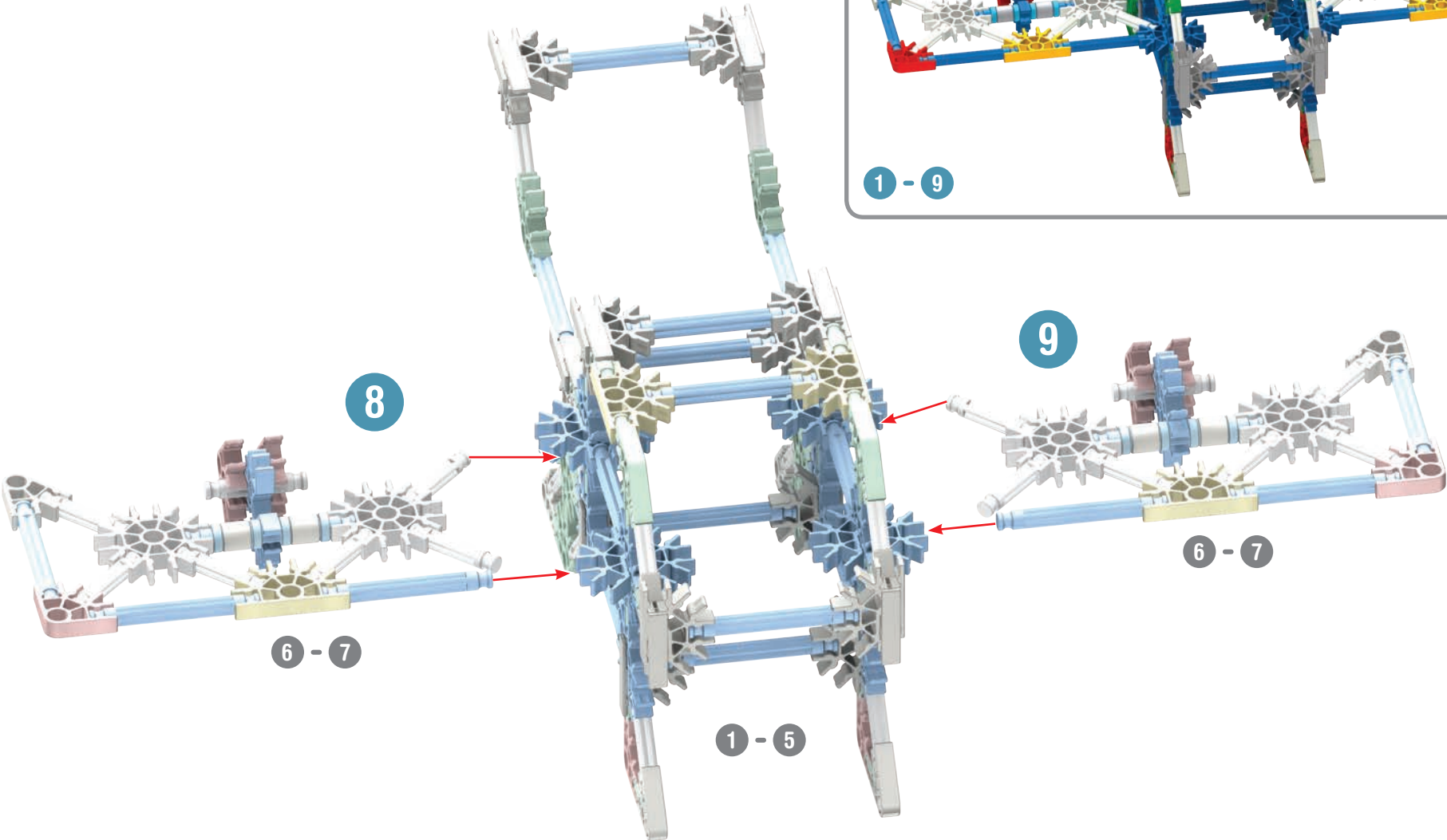

UFO

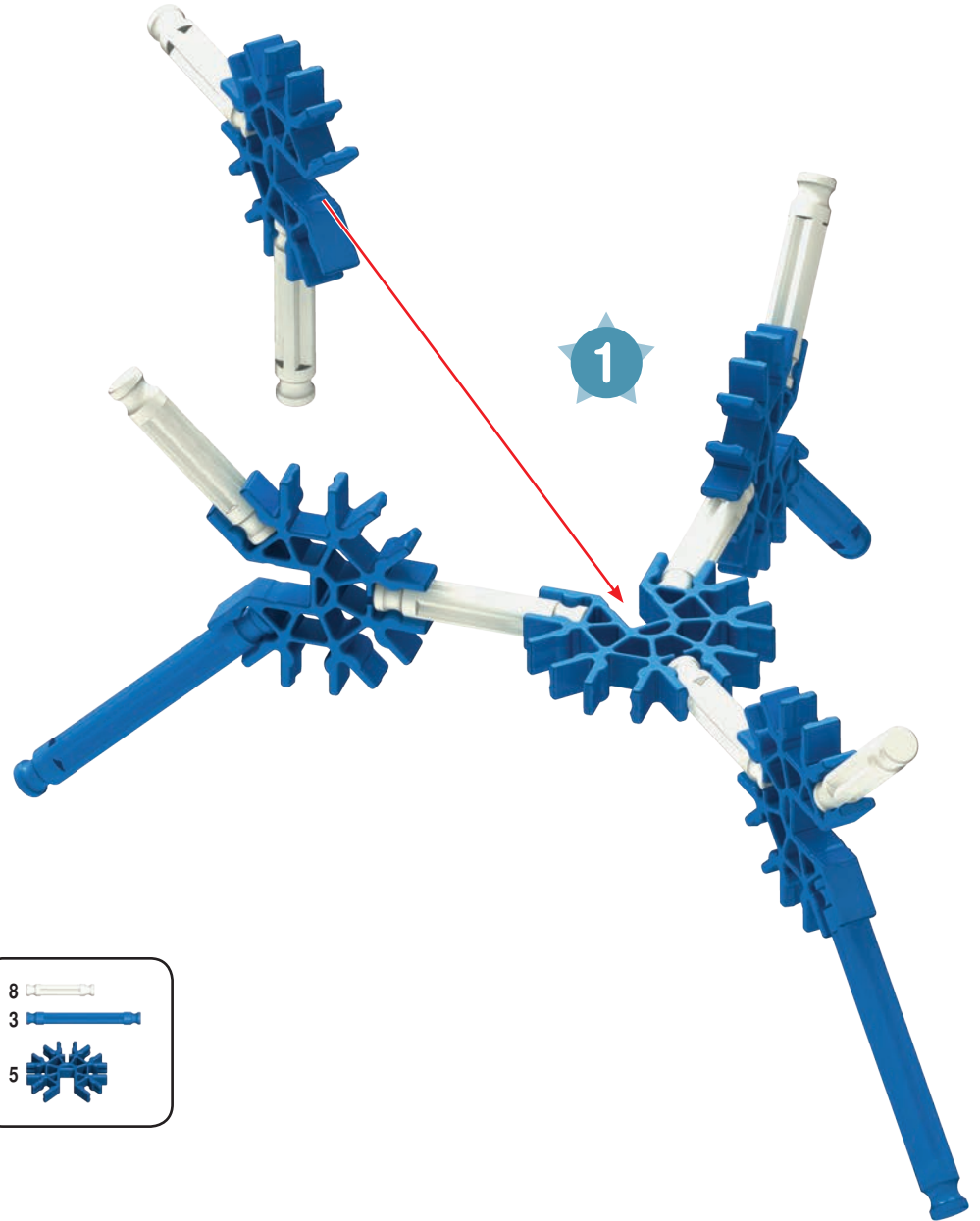
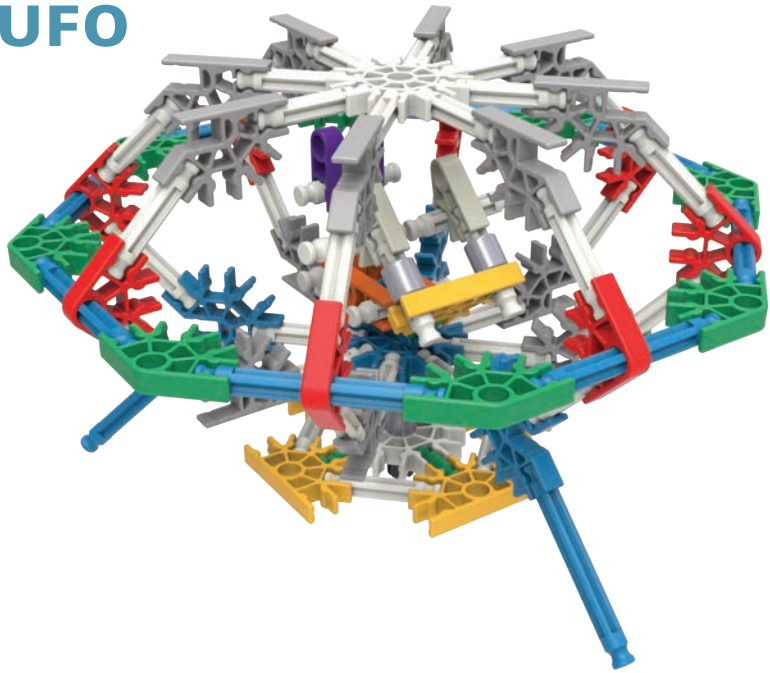

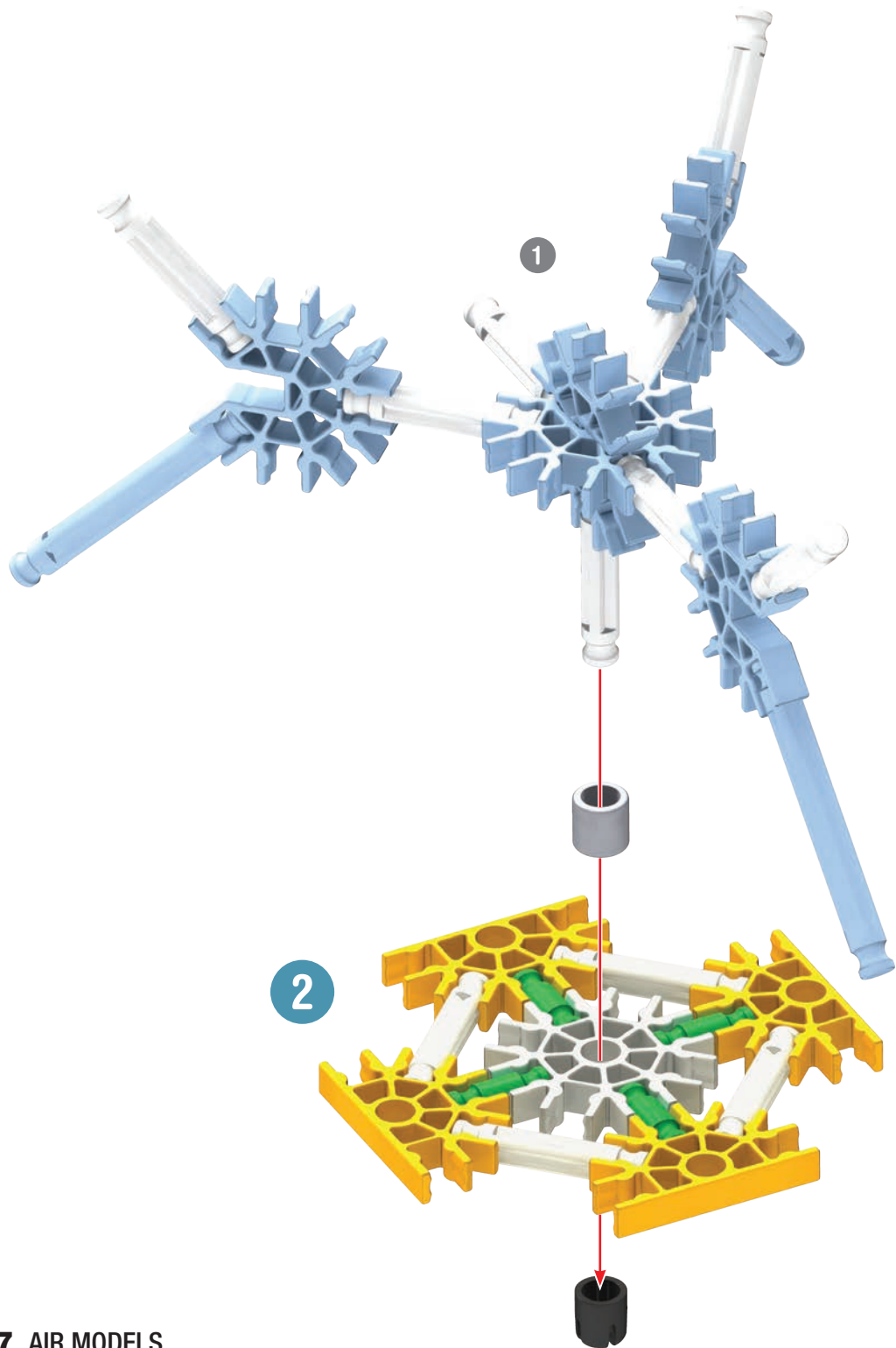

- | | | | | | | | | | |
|---|--|---|--|---|--|---|--|---|--|
| 4 | | 1 | | 1 | | 4 | | 1 | |
| 4 | | | | | | | | | |



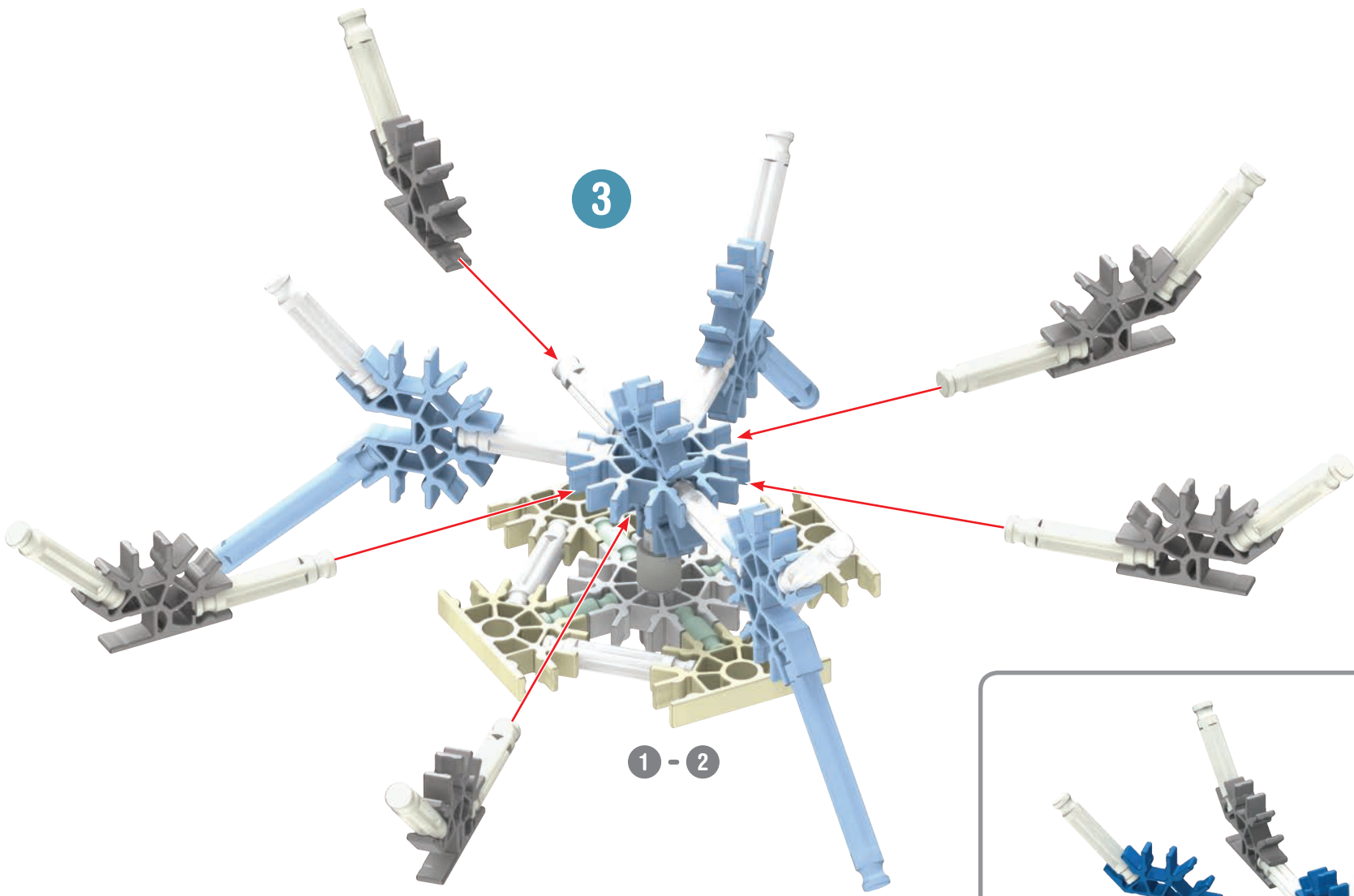

3

1 - 2

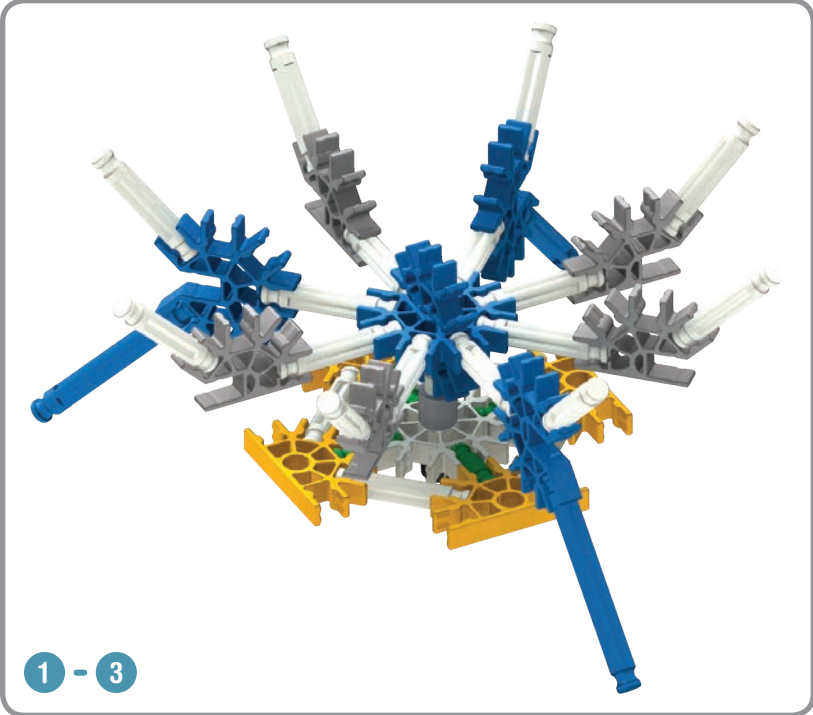
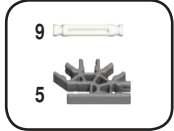

1 - 3

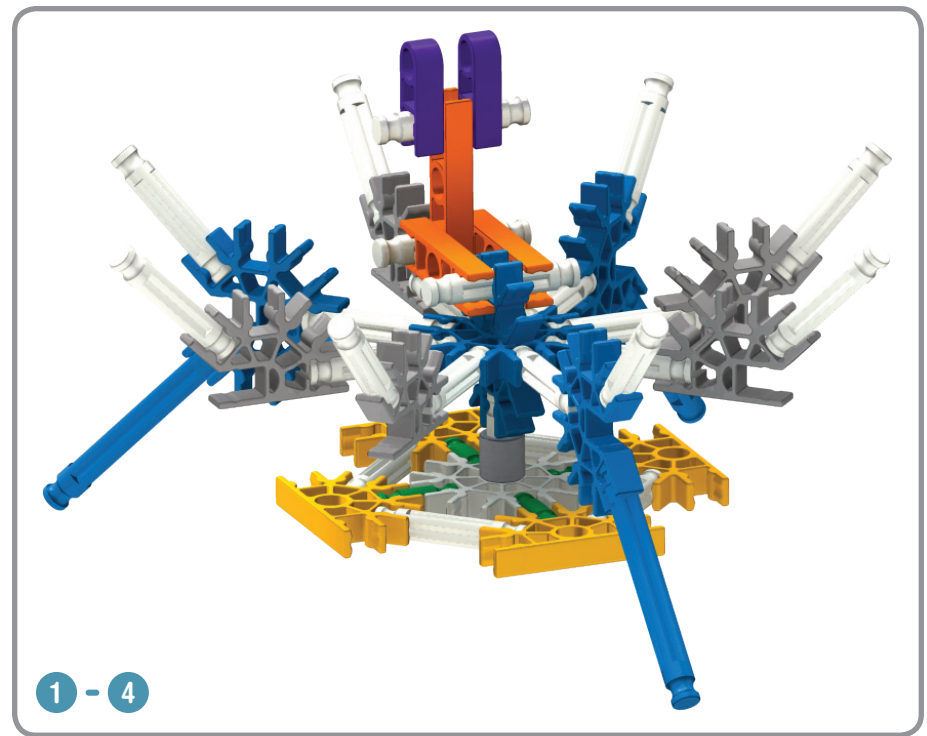
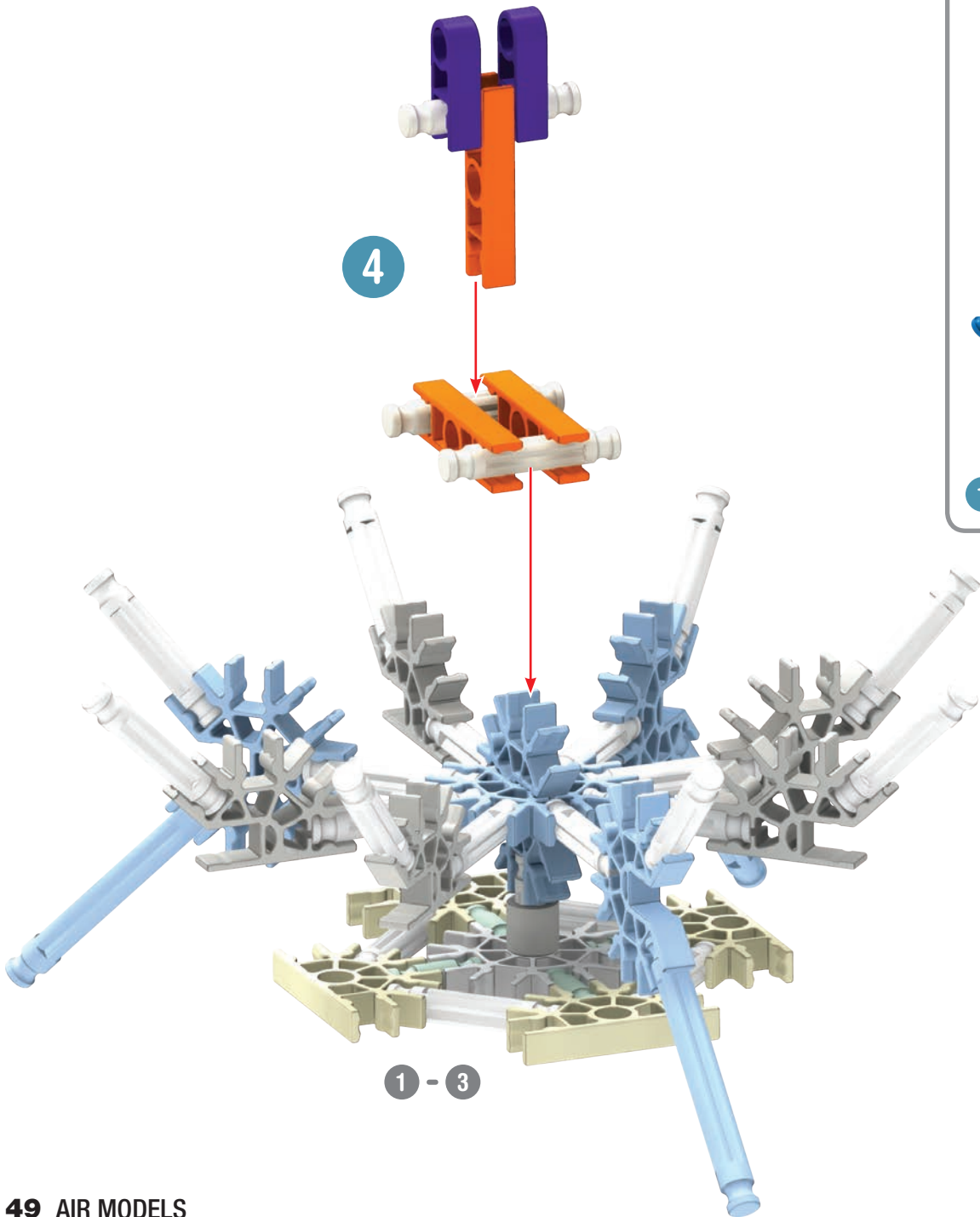

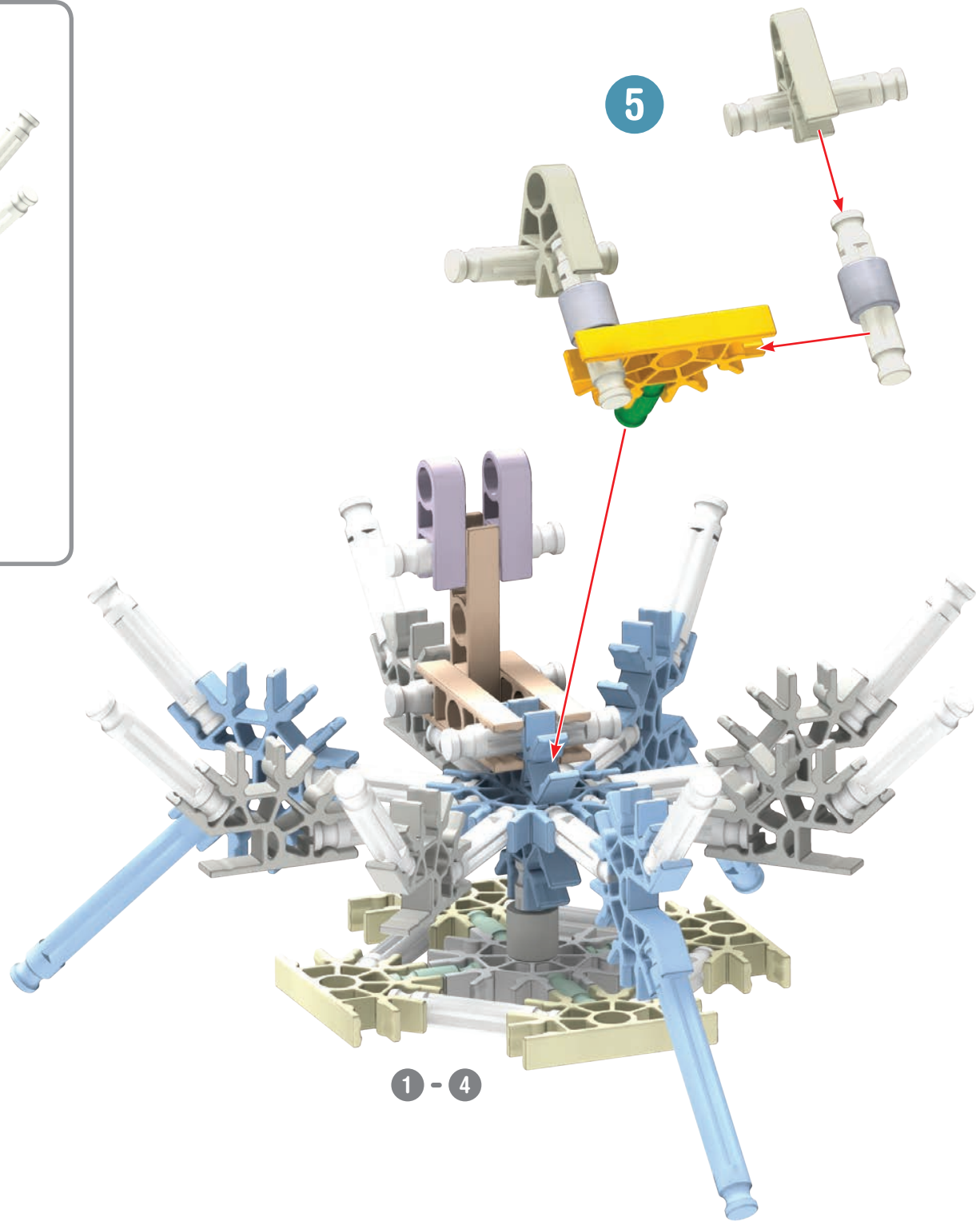

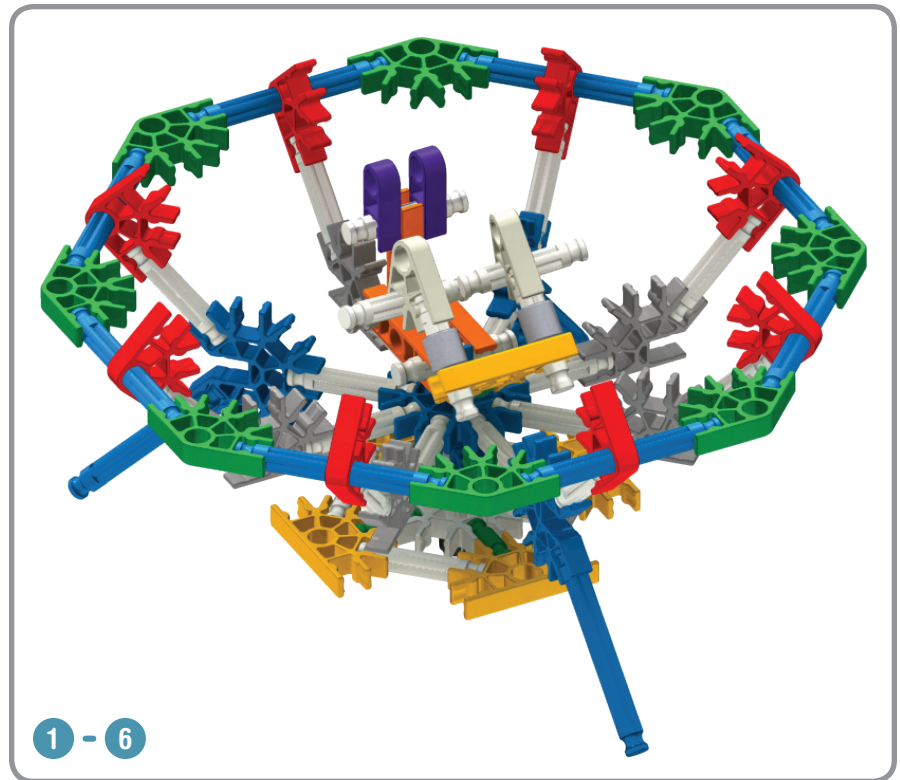
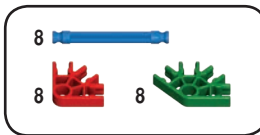
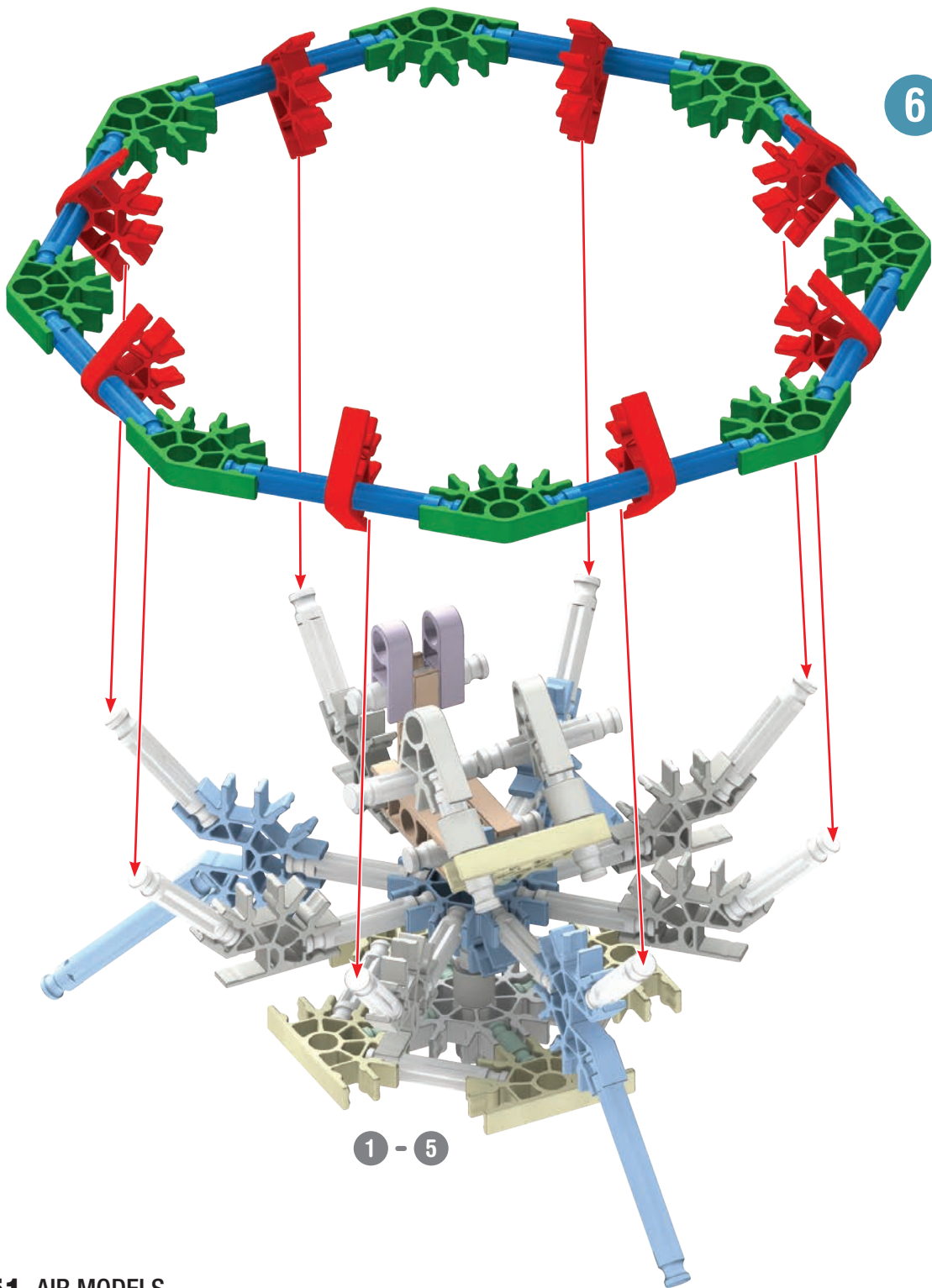

7

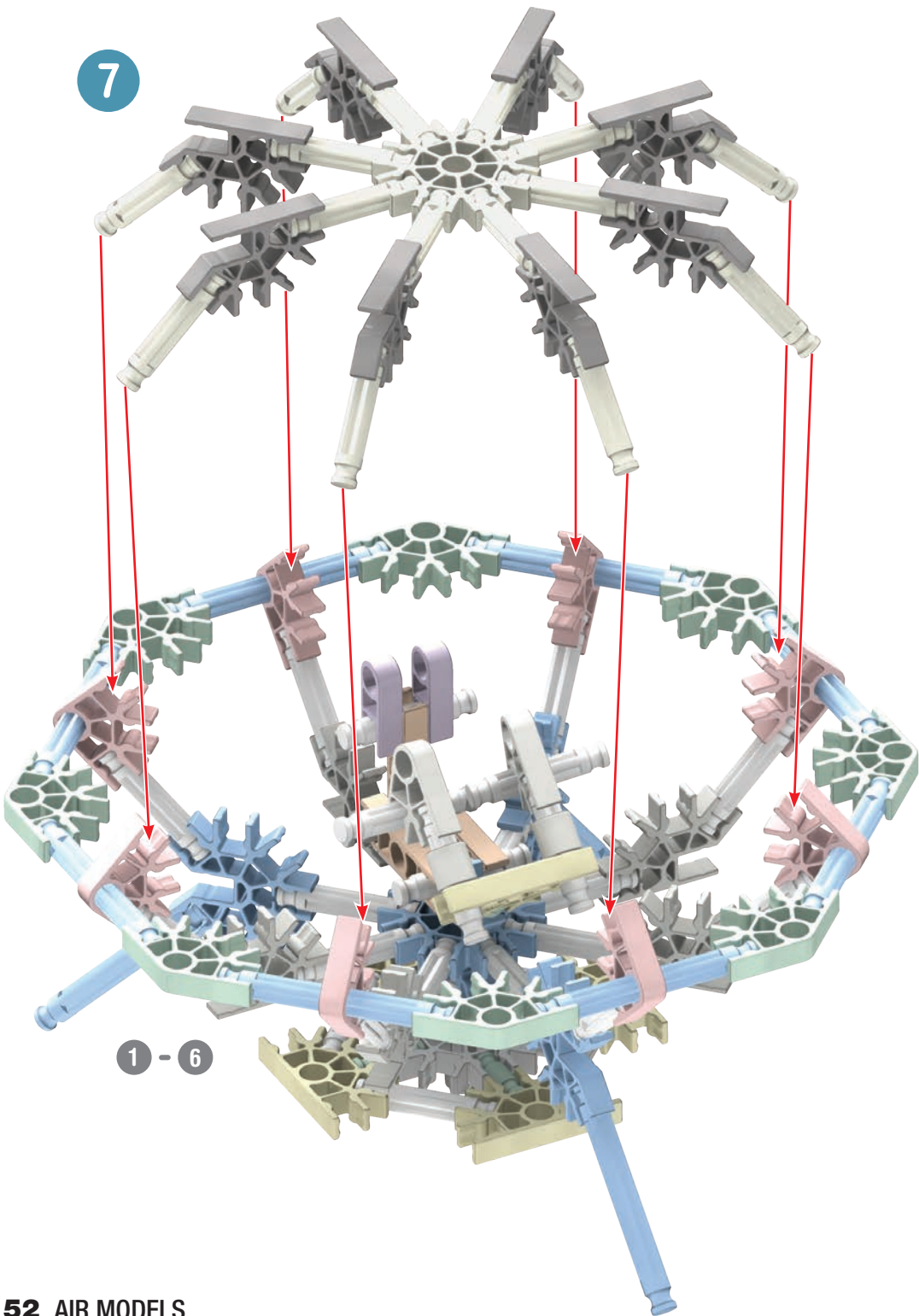

1 - 6

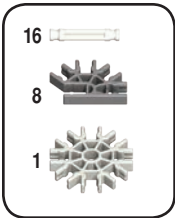

UFO

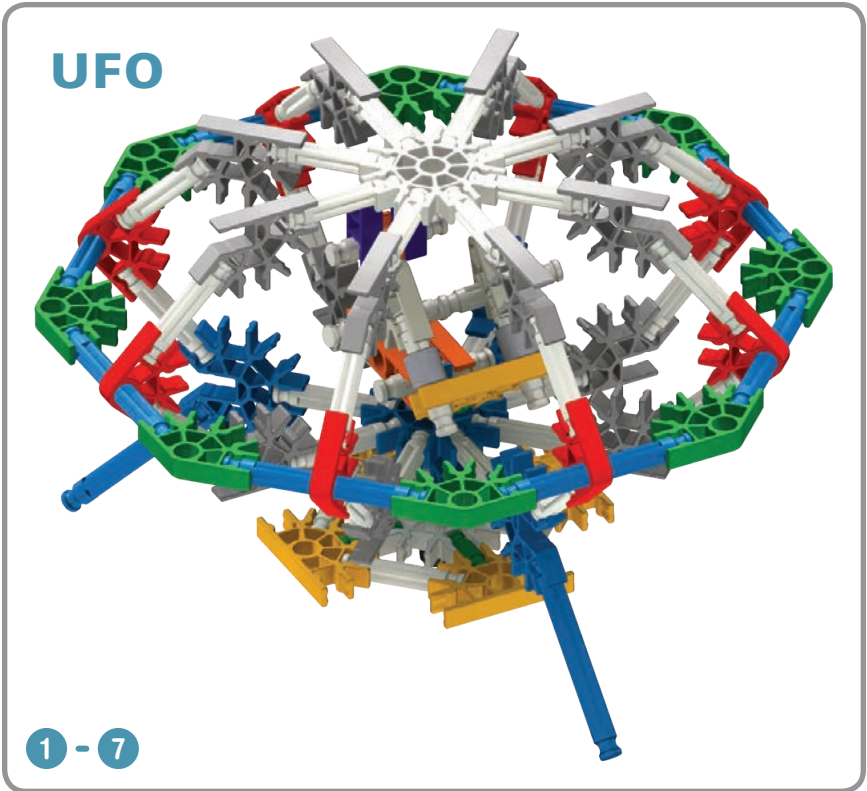

1 - 7