

12605

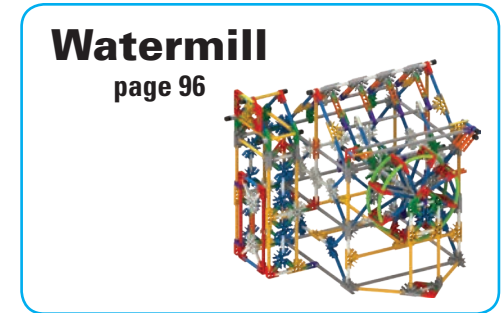

100 MODEL IMAGINE
BUILDING SET

STRUCTURES

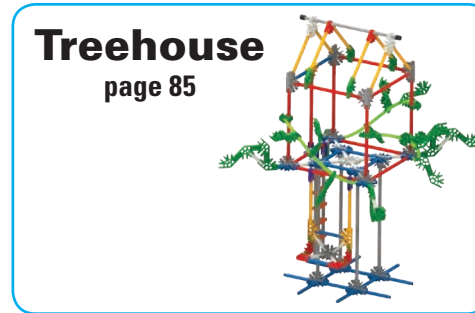
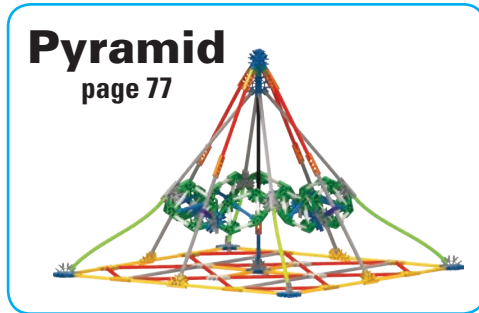
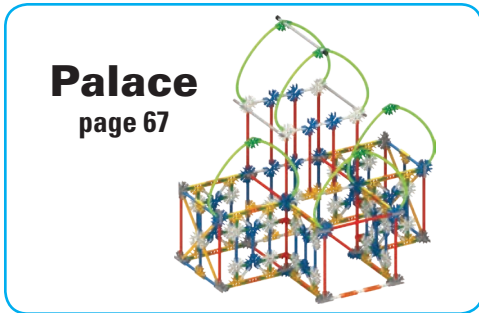
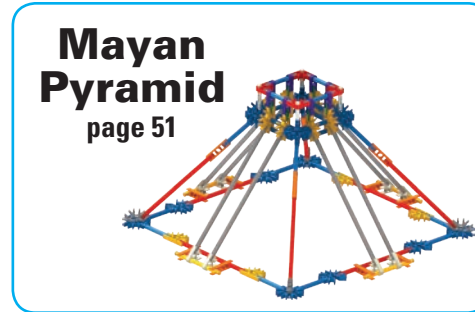
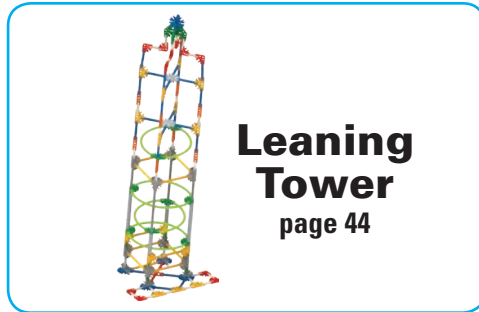
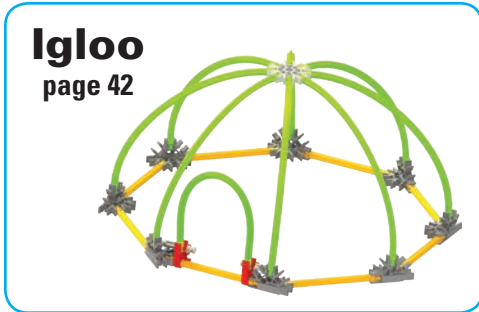
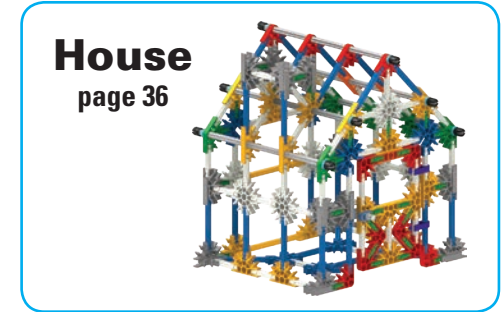
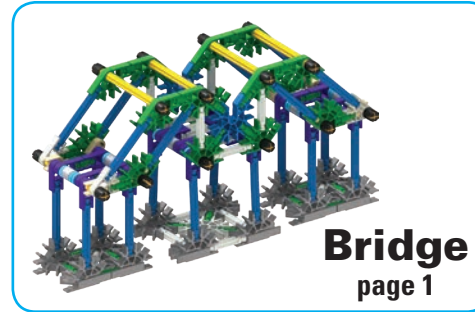

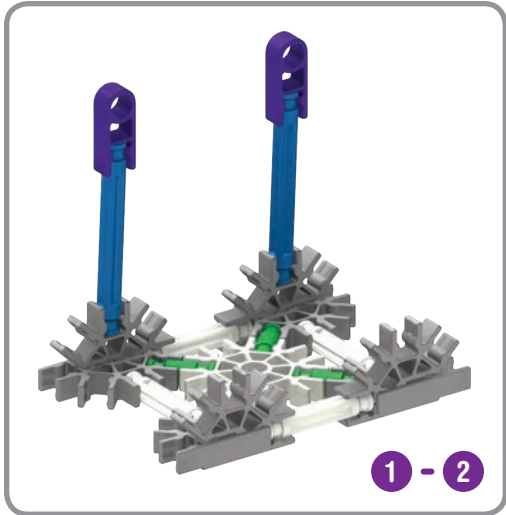

- 4
- 4
- 2
- 2
- 8
- 1

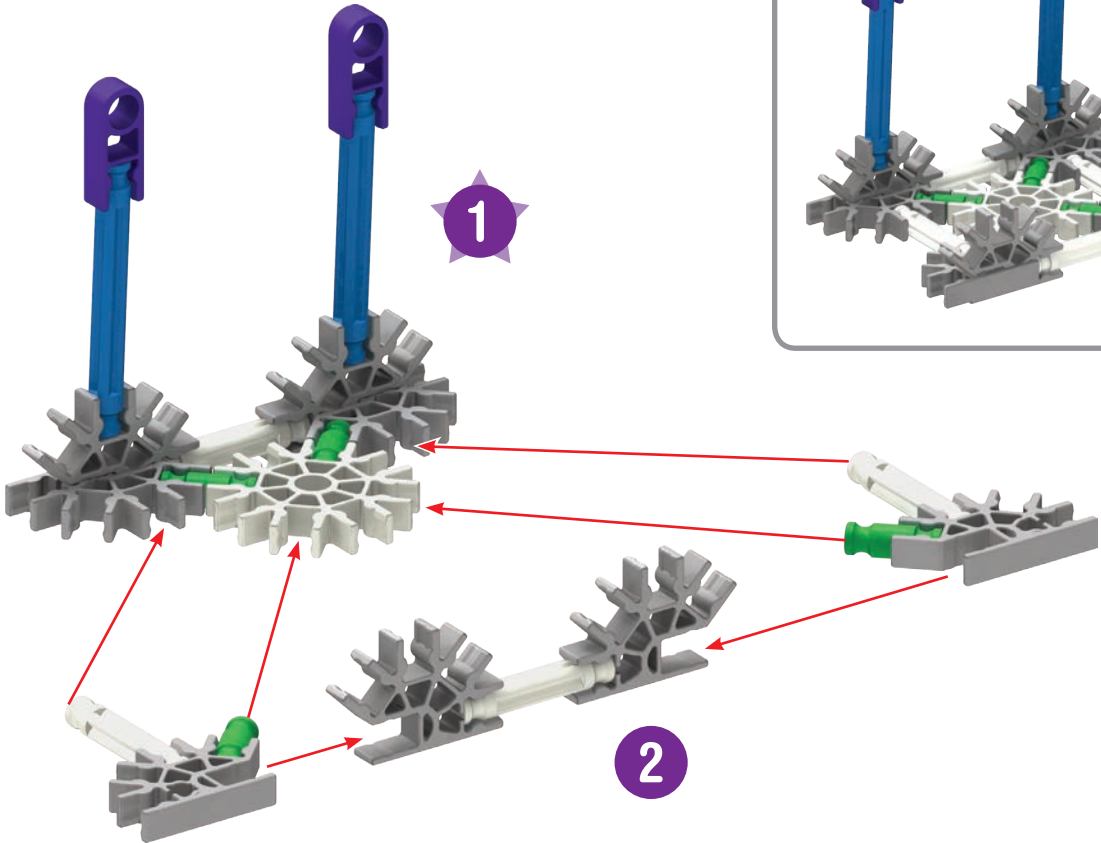

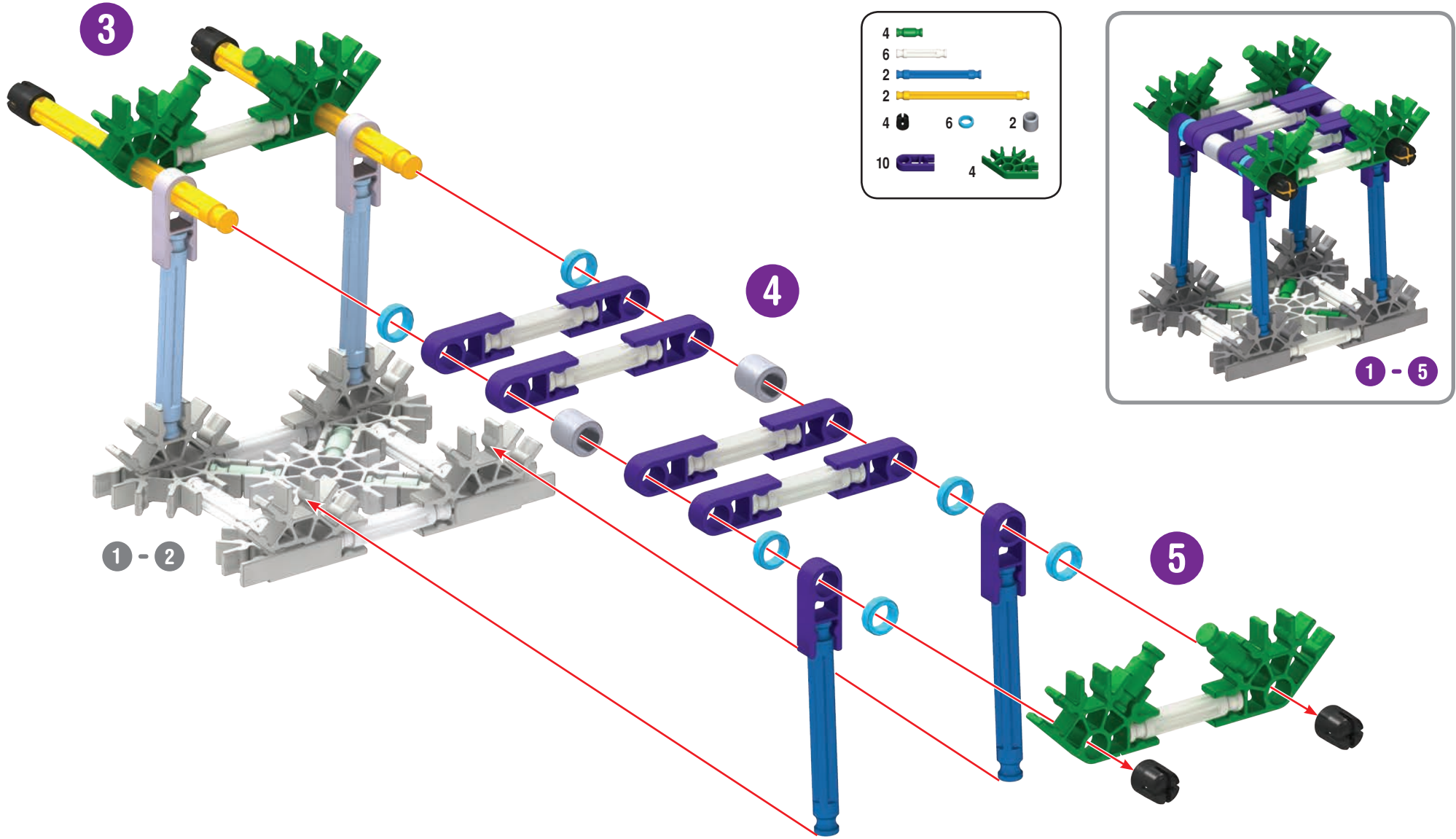



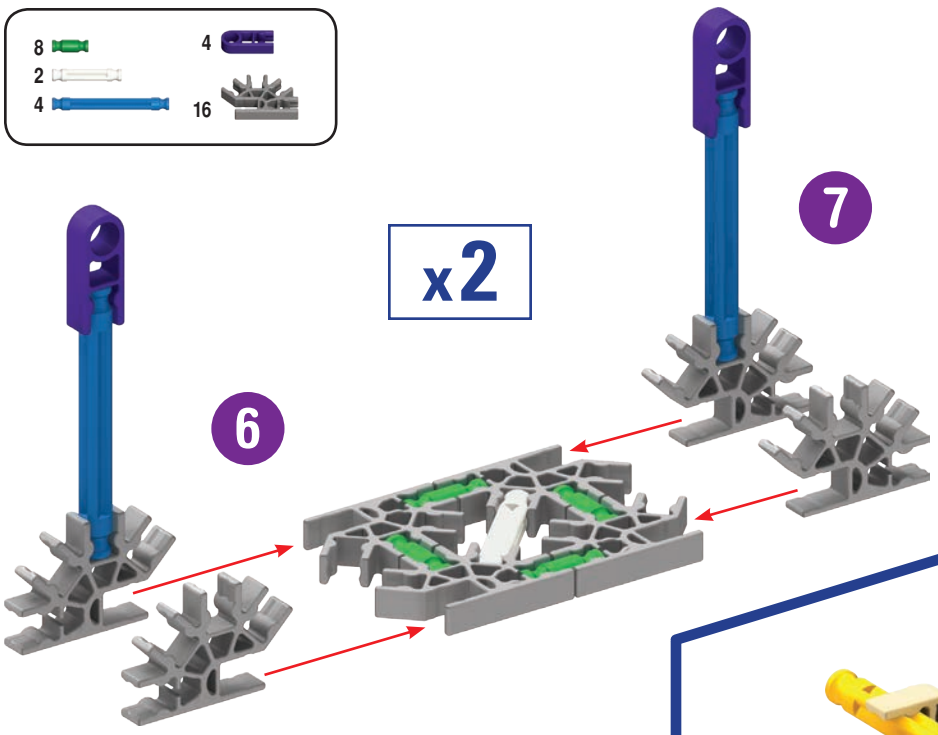

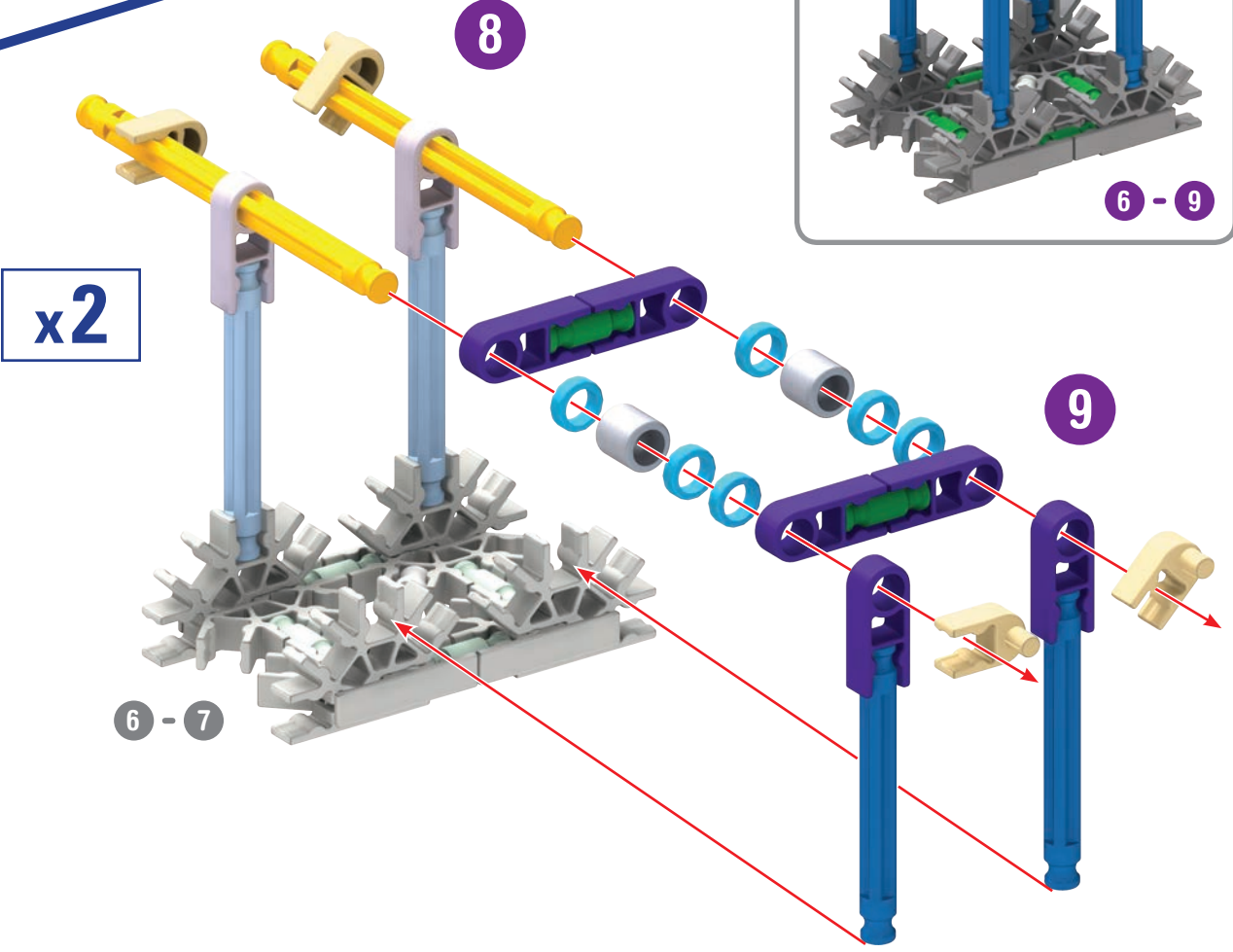
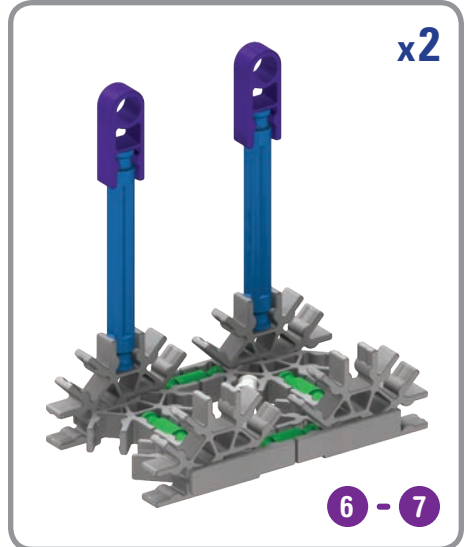
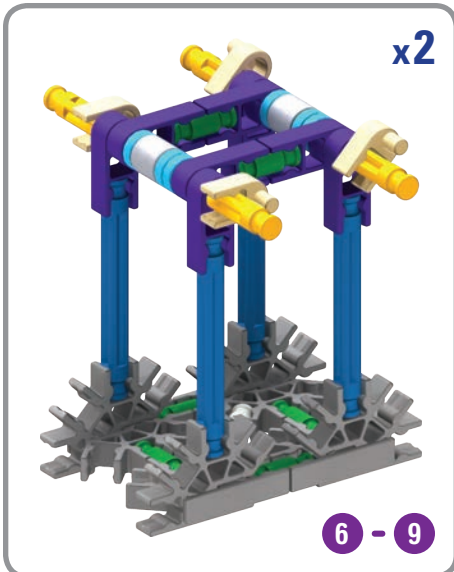

- | | | | |
|---|--|----|--|
| 8 | | 4 | |
| 2 | | | |
| 4 | | 16 | |



- | | | | | | |
|---|--|----|--|---|--|
| 4 | | 12 | | 4 | |
| 4 | | | | | |
| 4 | | | | | |
| 8 | | 12 | | | |



- 12 
- 4 
- 8 
- 4 
- 12 
- 2 

x2

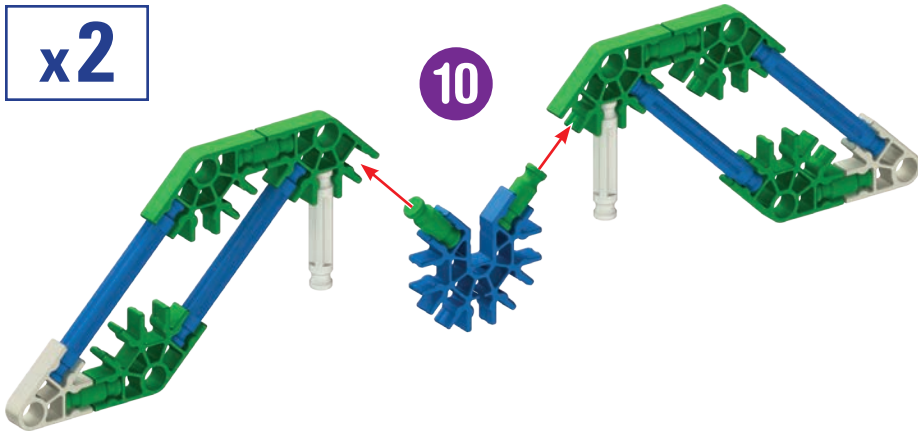

10

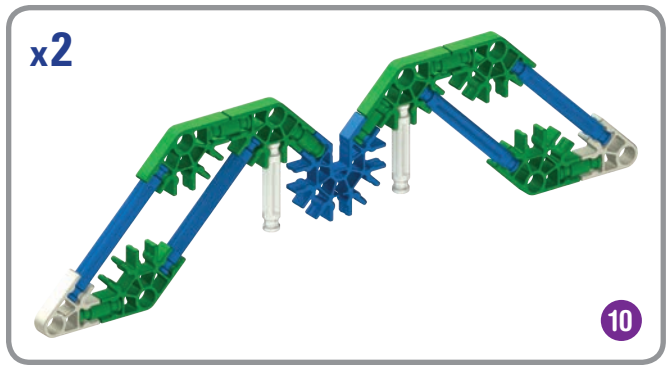

x2

10

Bridge

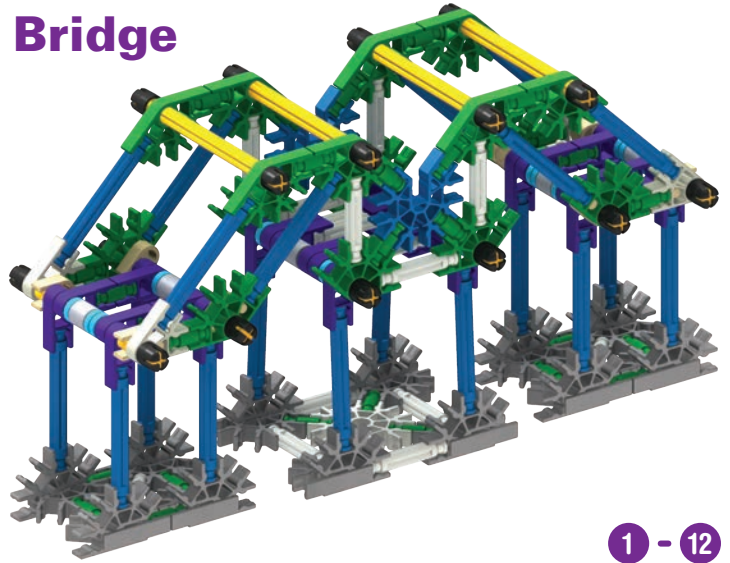

1 - 12

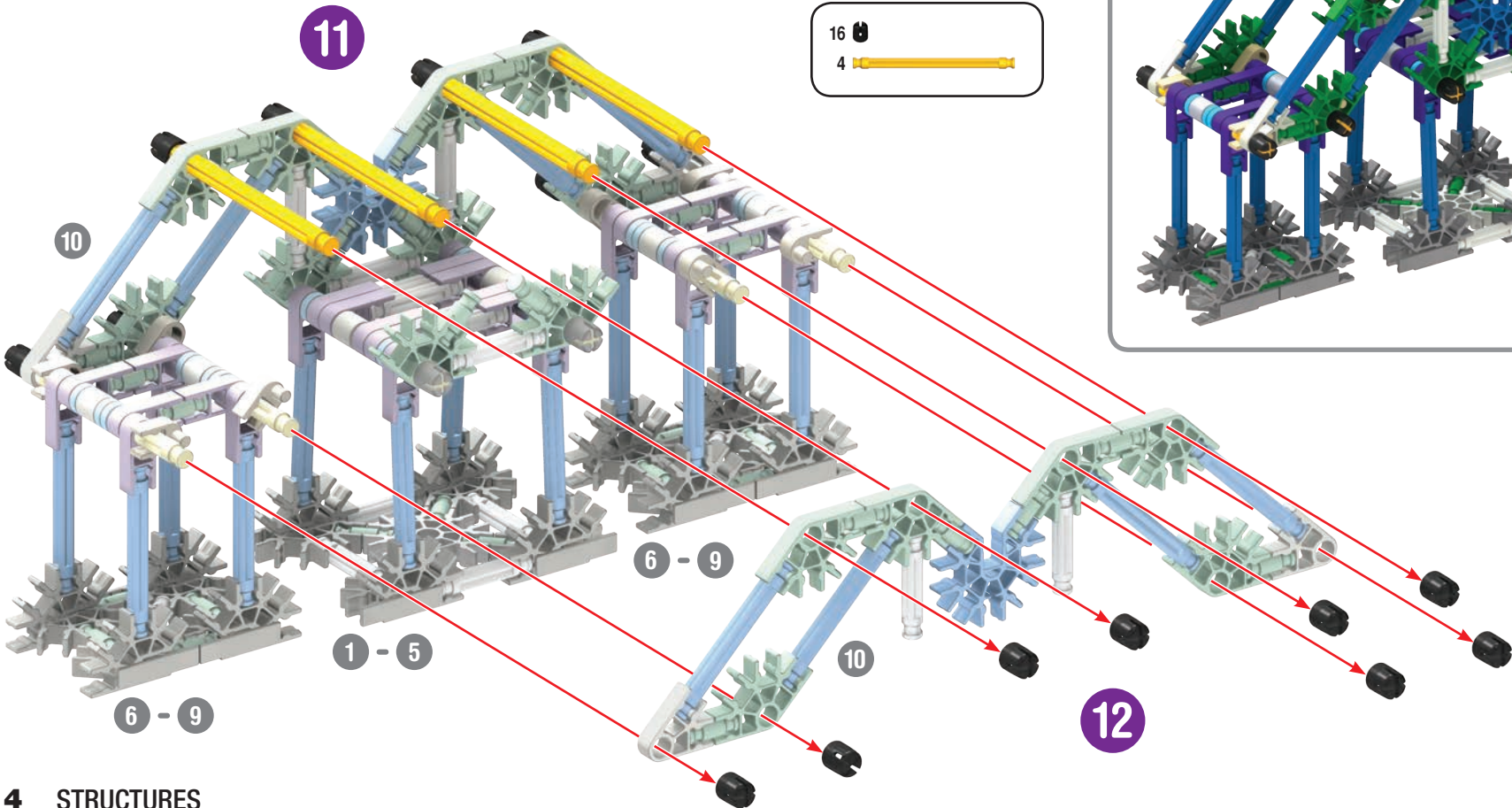

11

- 16 
- 4 

10

6 - 9

1 - 5

6 - 9

10

12

Cabana



x7

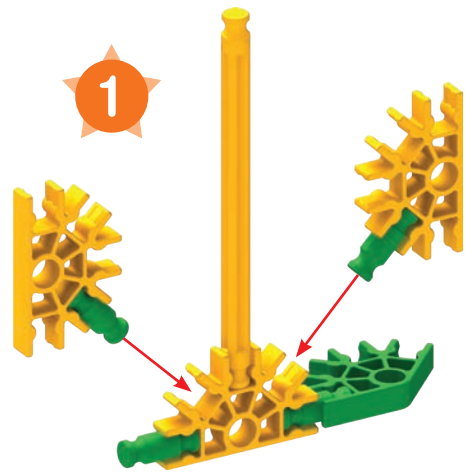

- 28
- 7
- 7
- 21

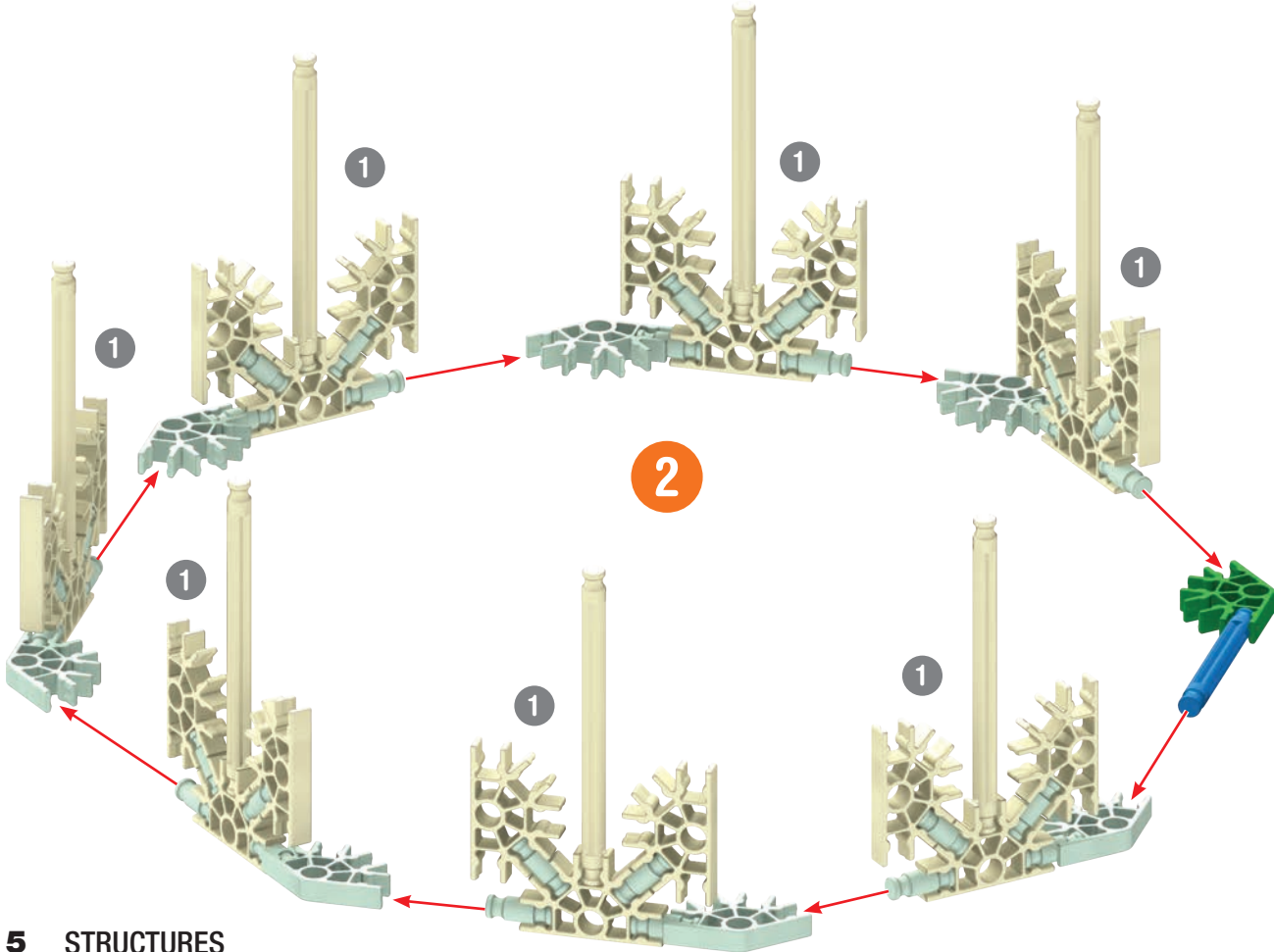
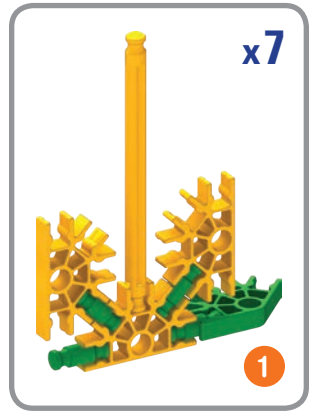

- 1
- 1

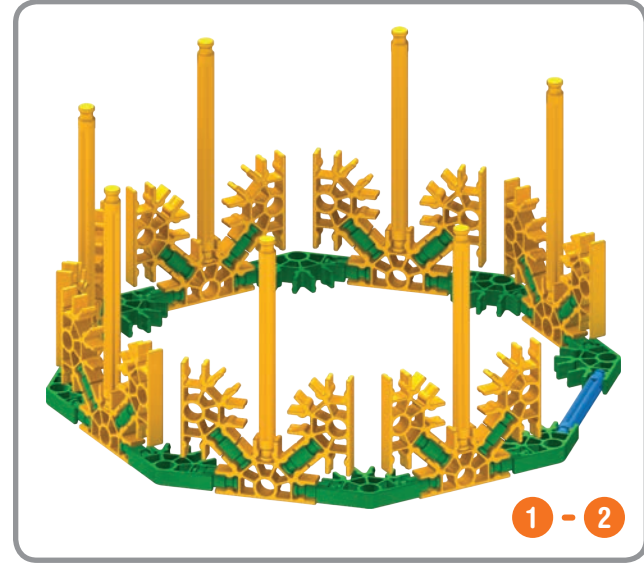

x8

40		8	
8		8	
8		16	
8		8	

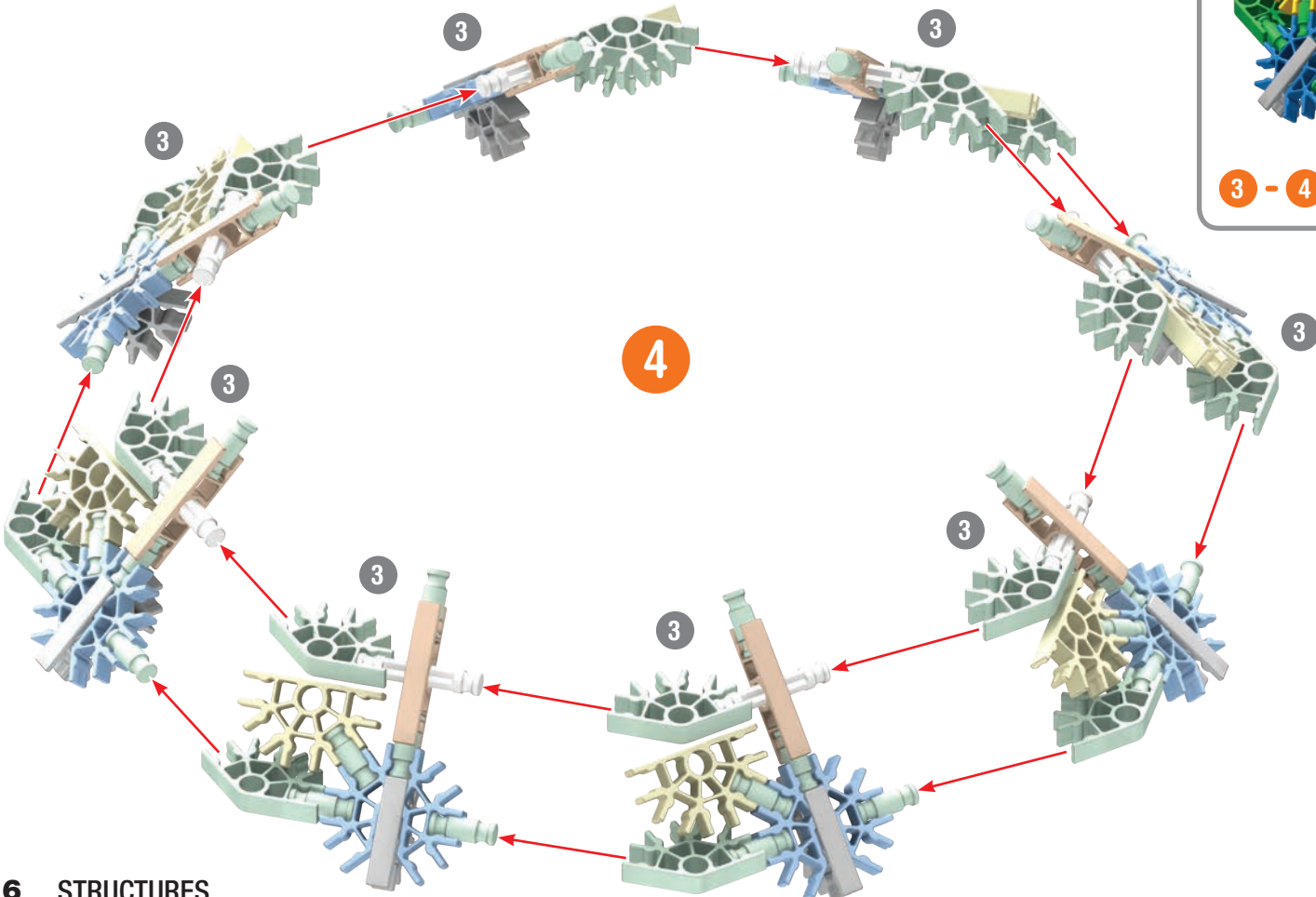
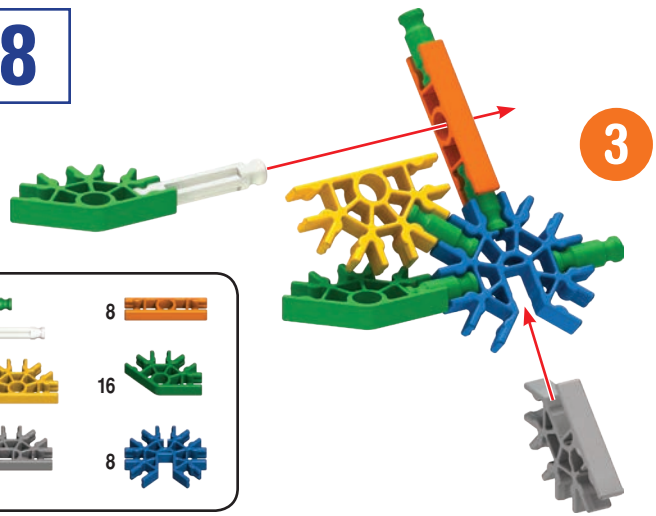

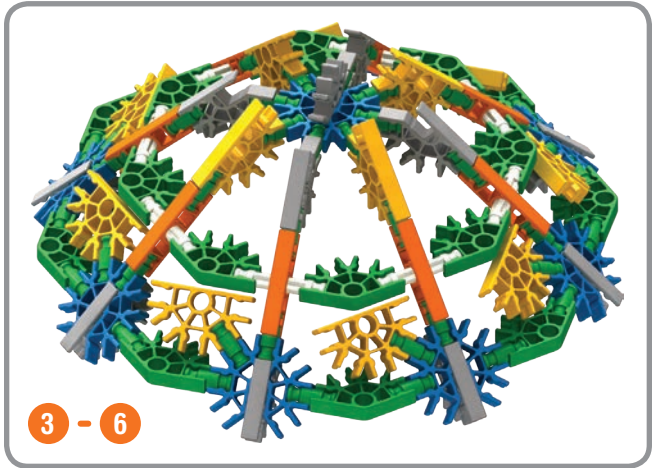
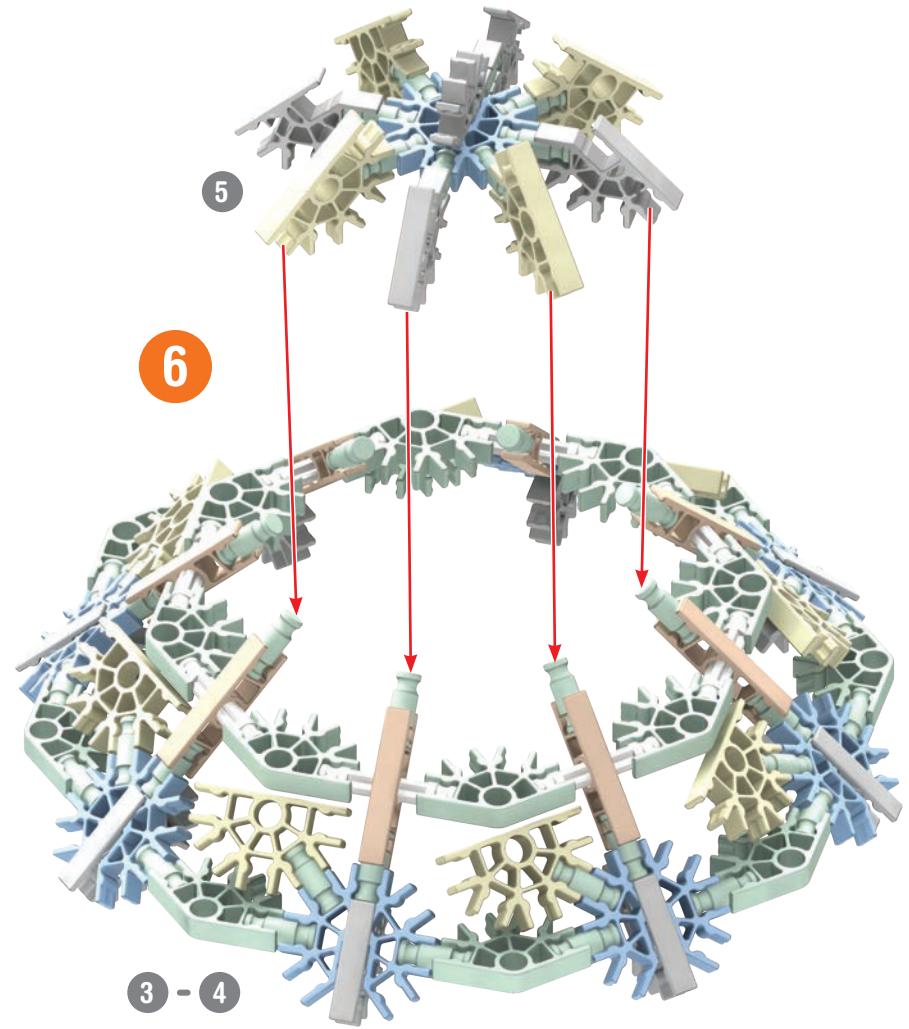
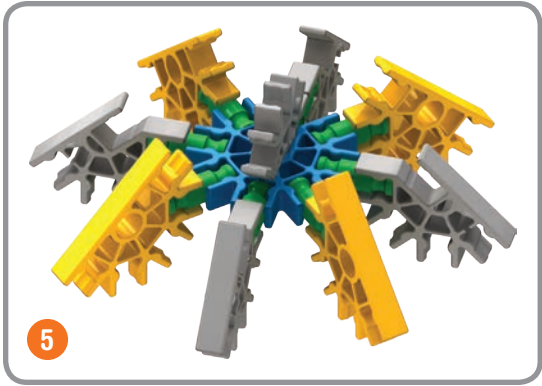
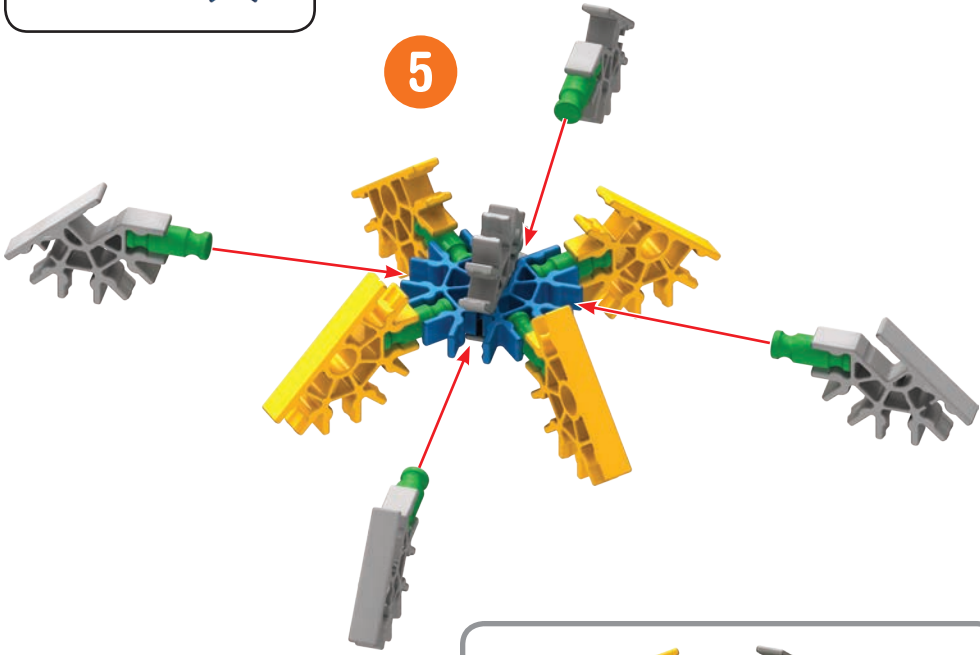
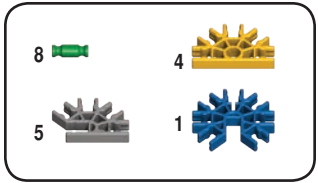

x4

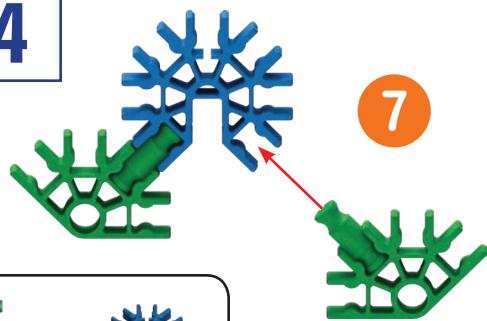

7

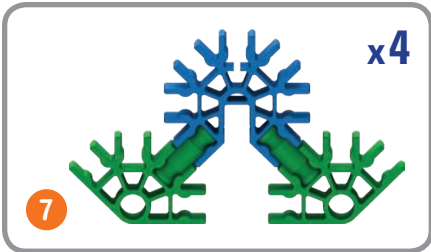

x4

7

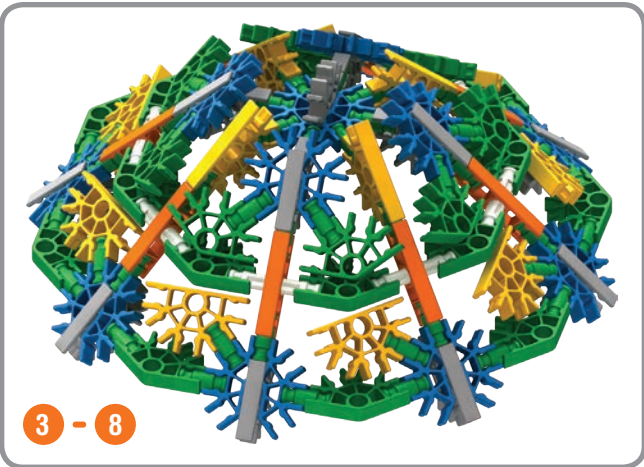
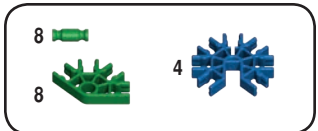

3 - 8

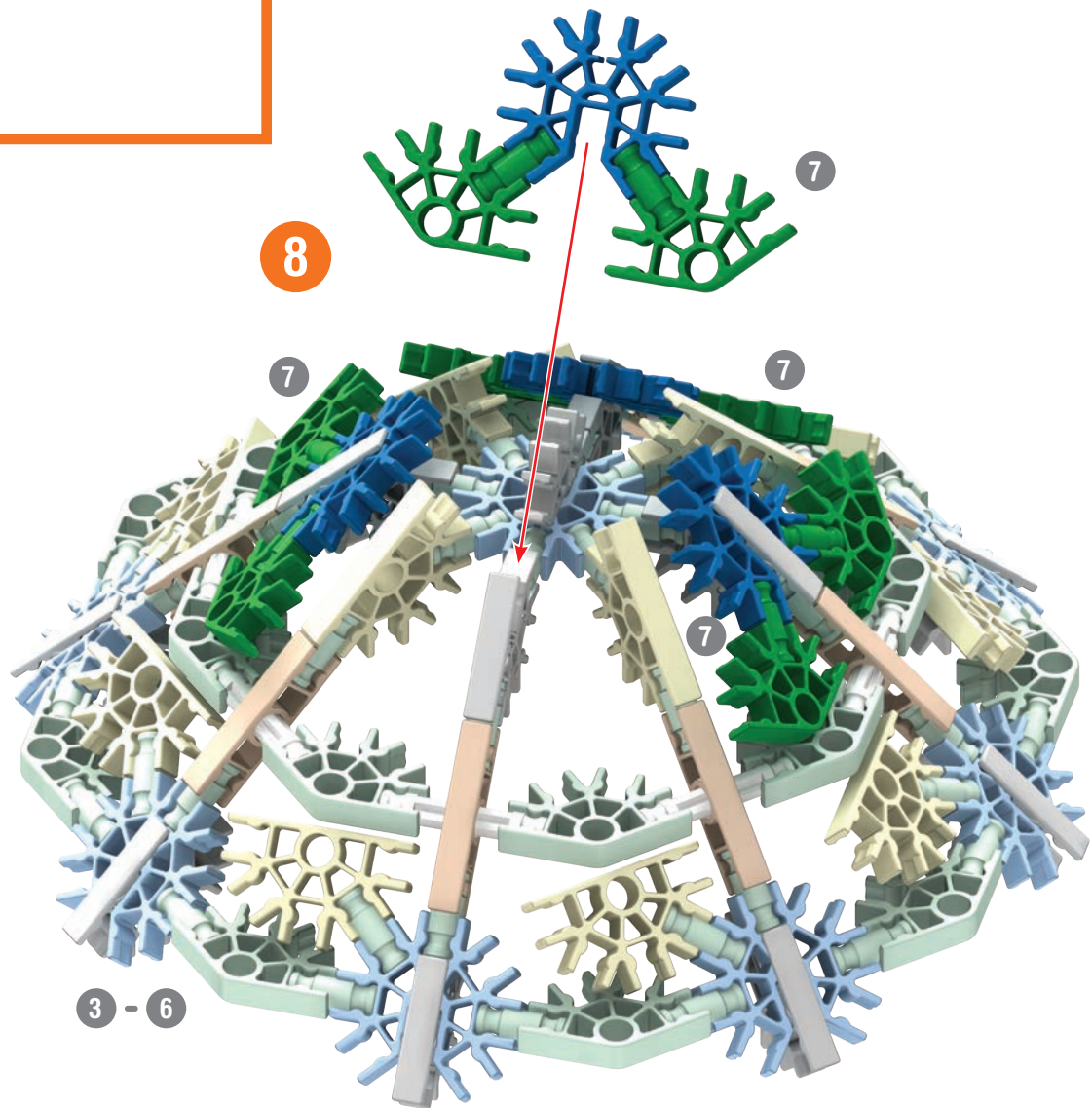

8





7

7

7

7

3 - 6

- 8 
- 1 
- 1  2 

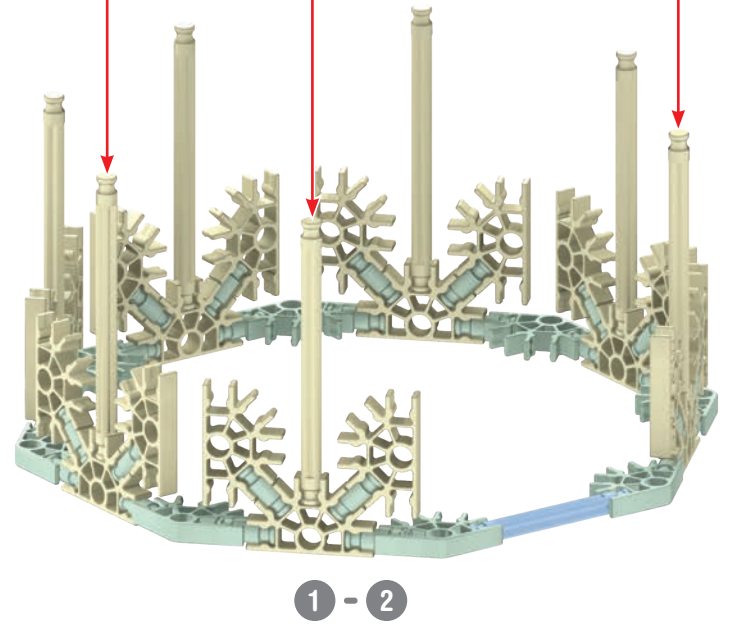
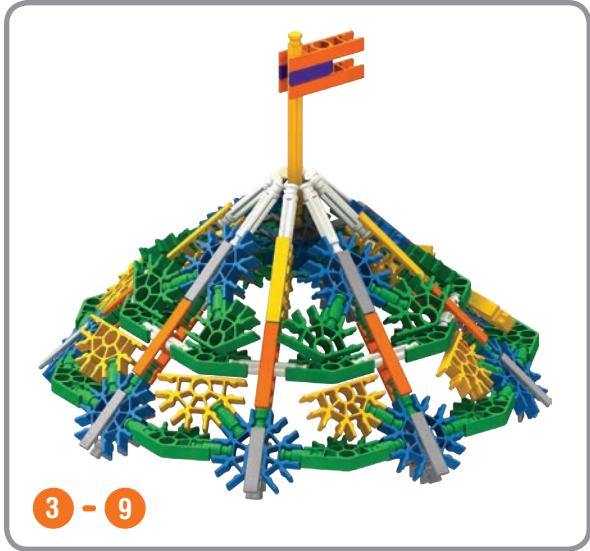
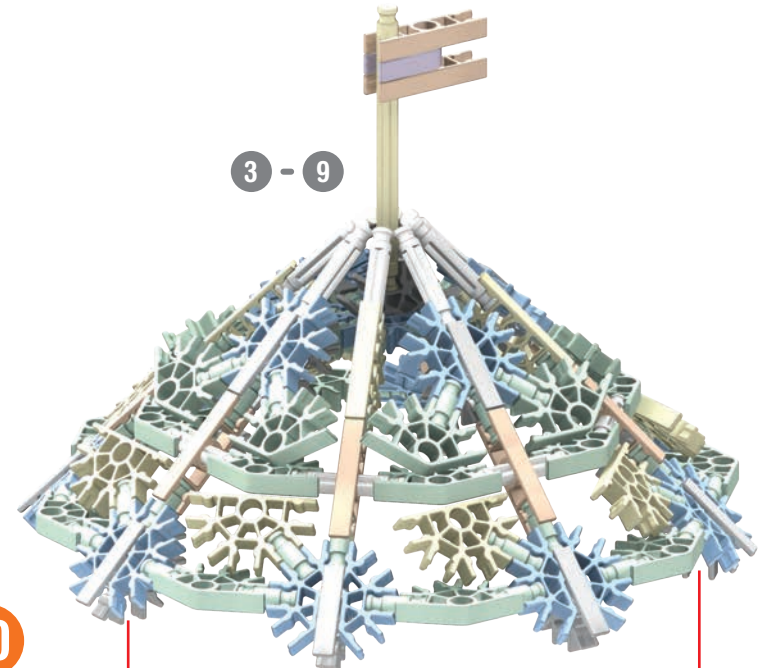
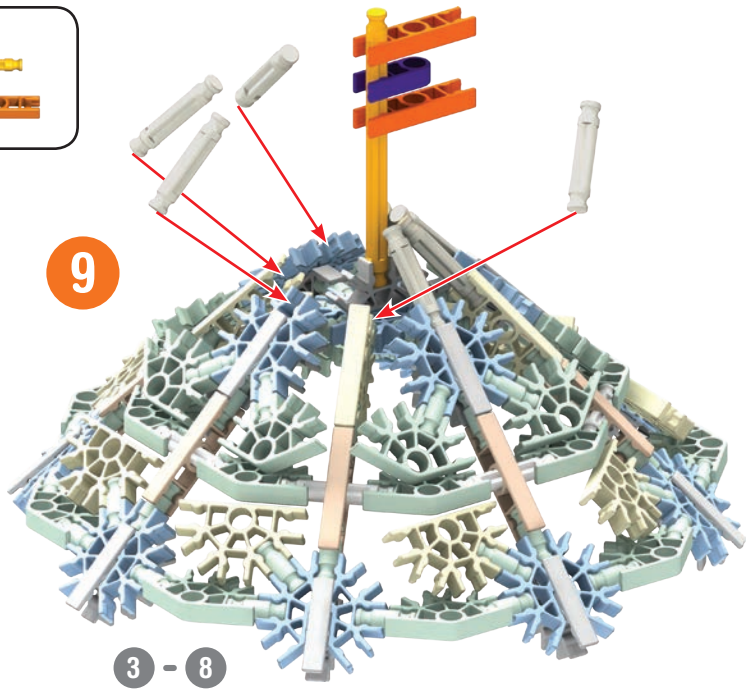

Car Wash

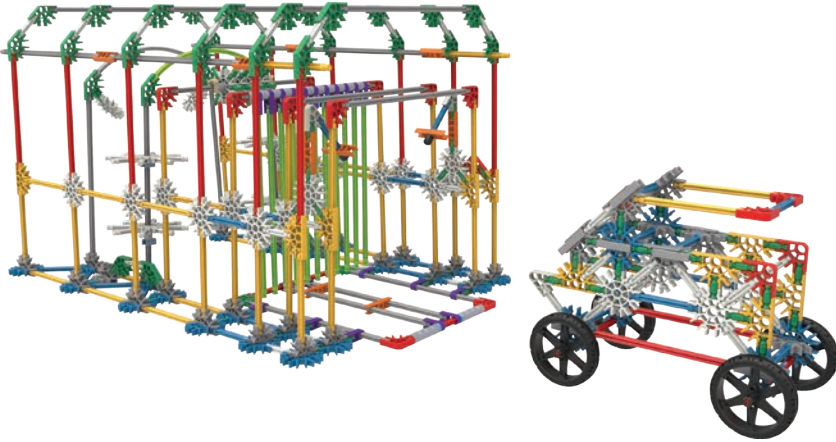

12		2		2		12	
6							
4							
2							
4						12	
2		8		10		2	

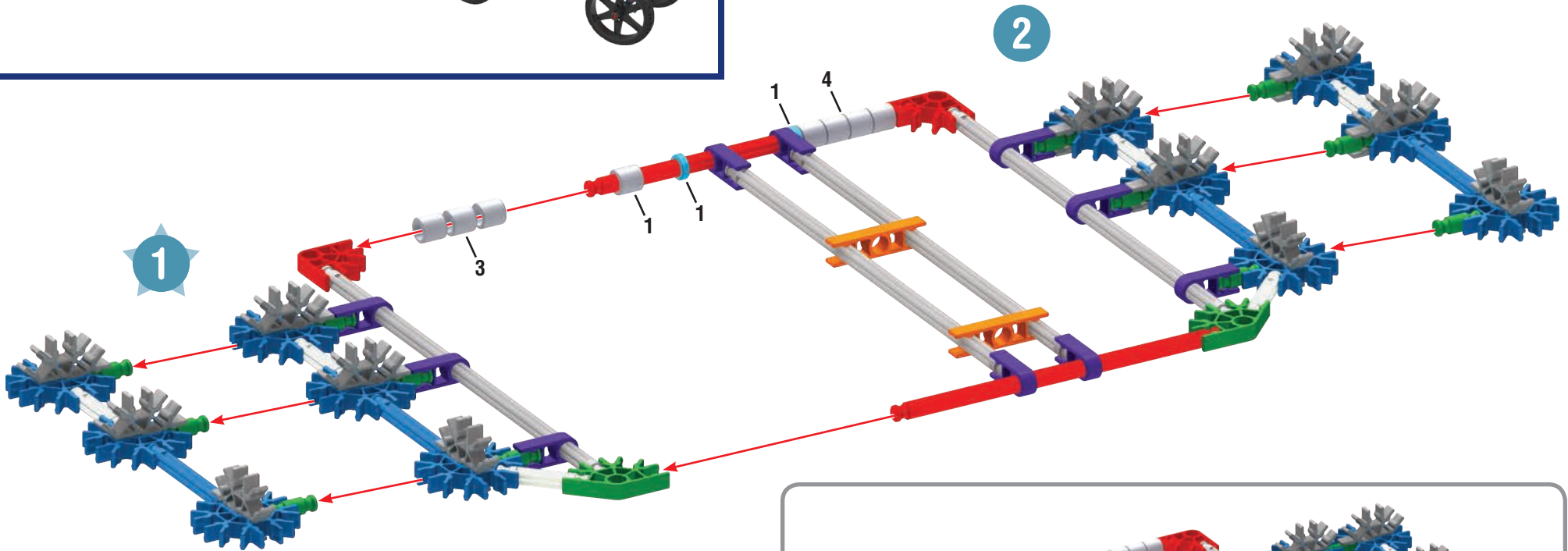

2

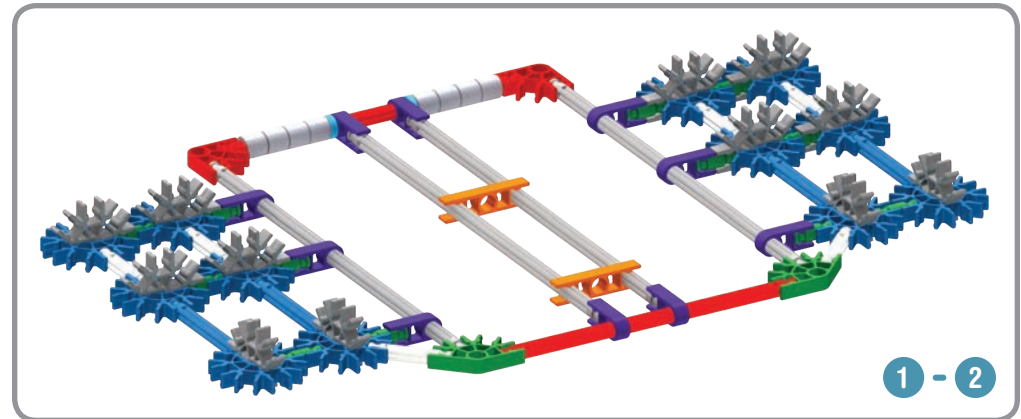
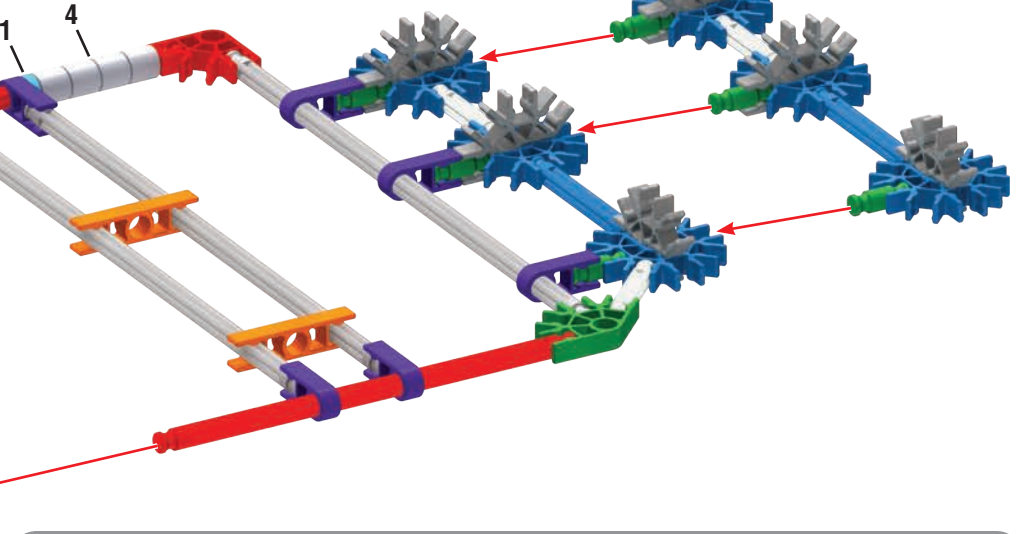

1 - 2

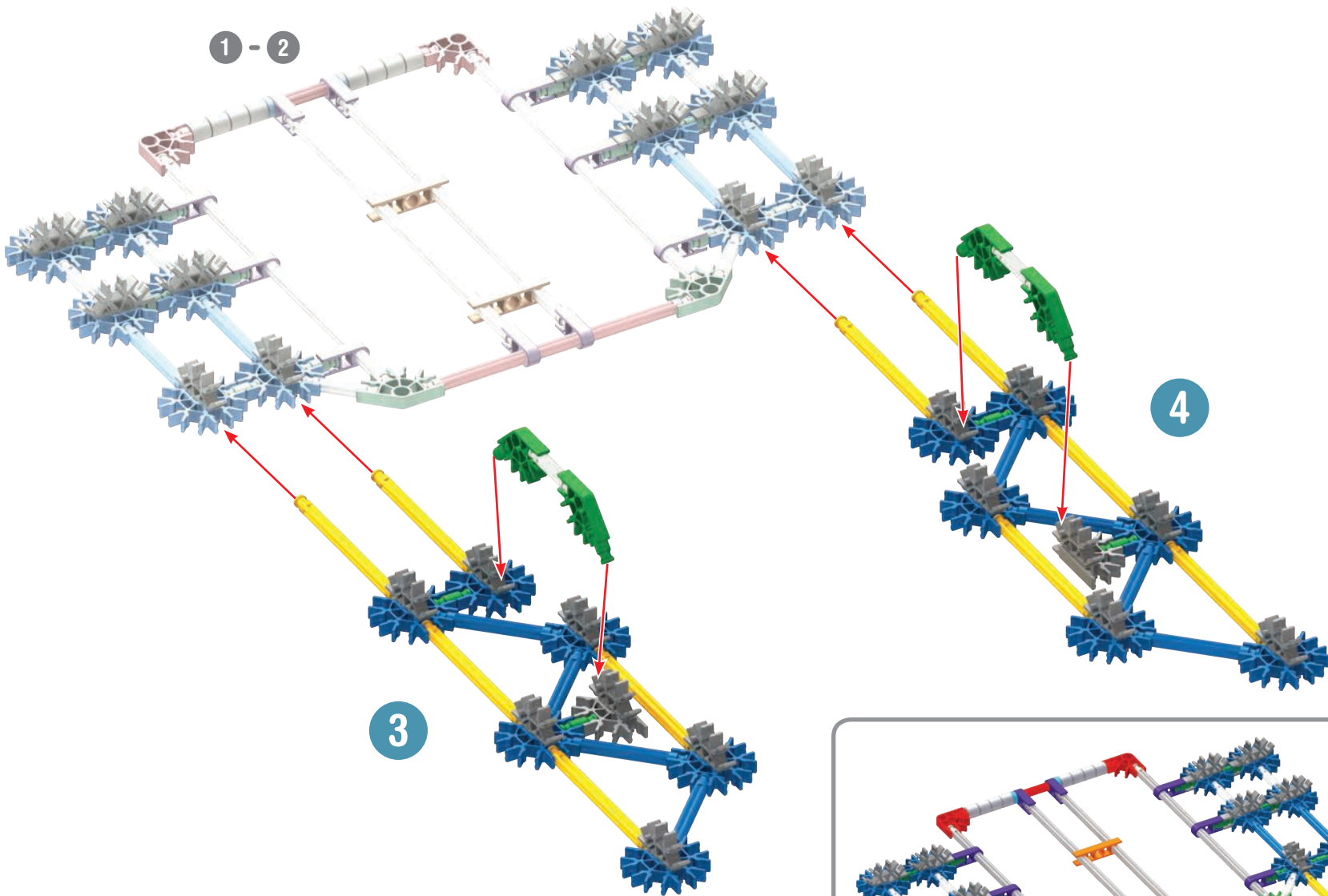

3

4

8		12		4	
2					
8				16	
10					

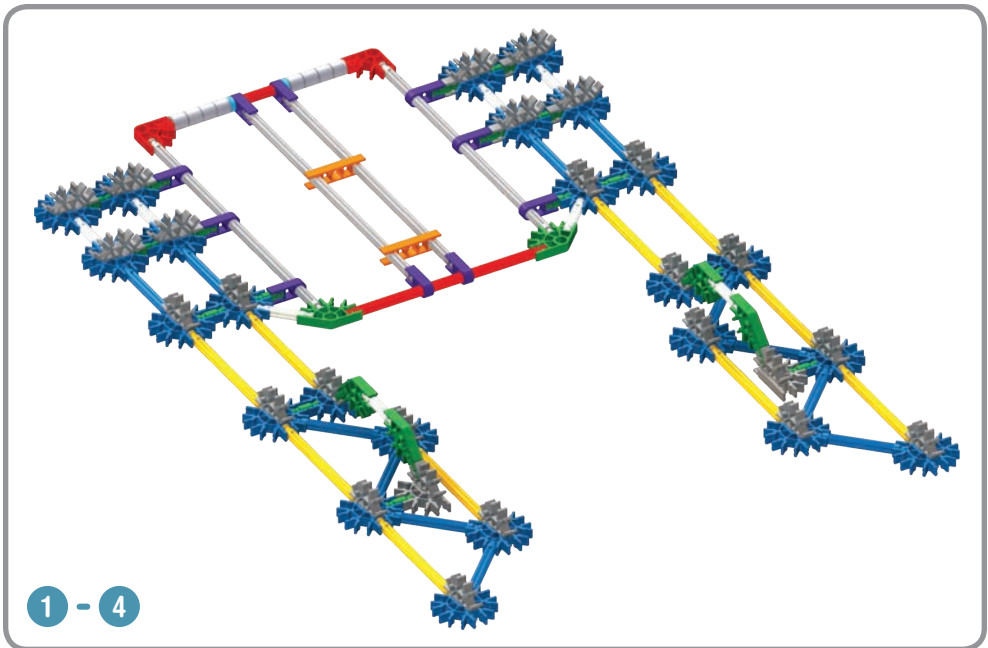

1 - 4

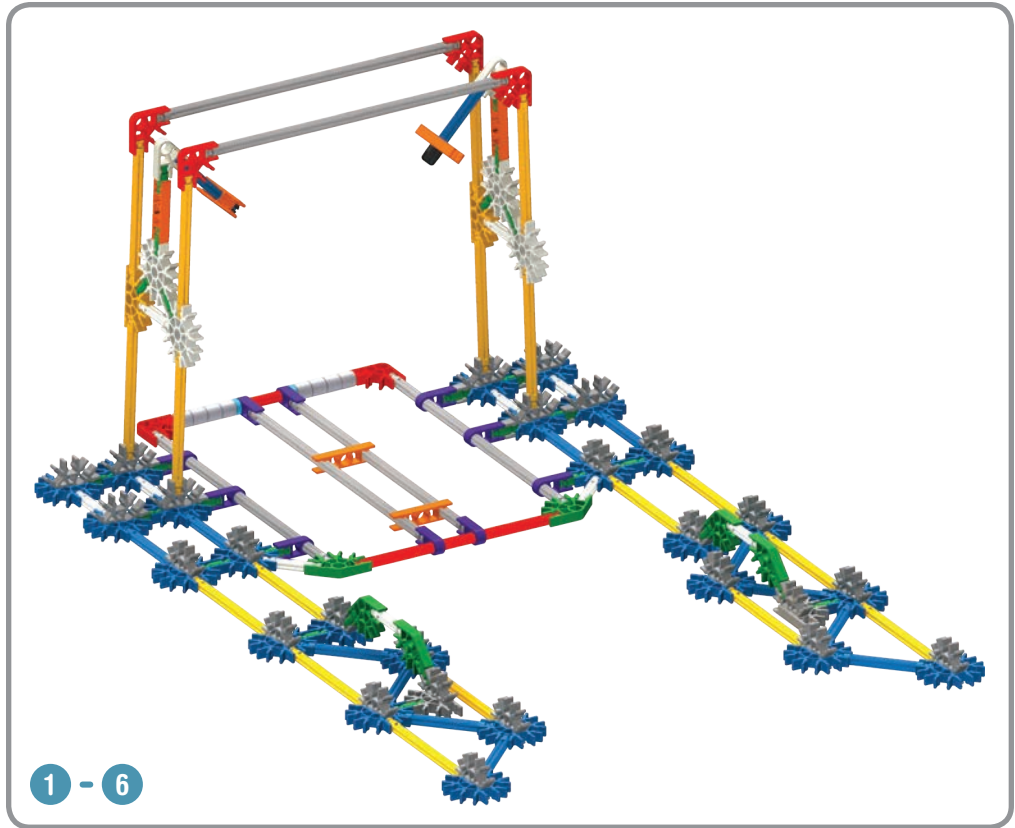
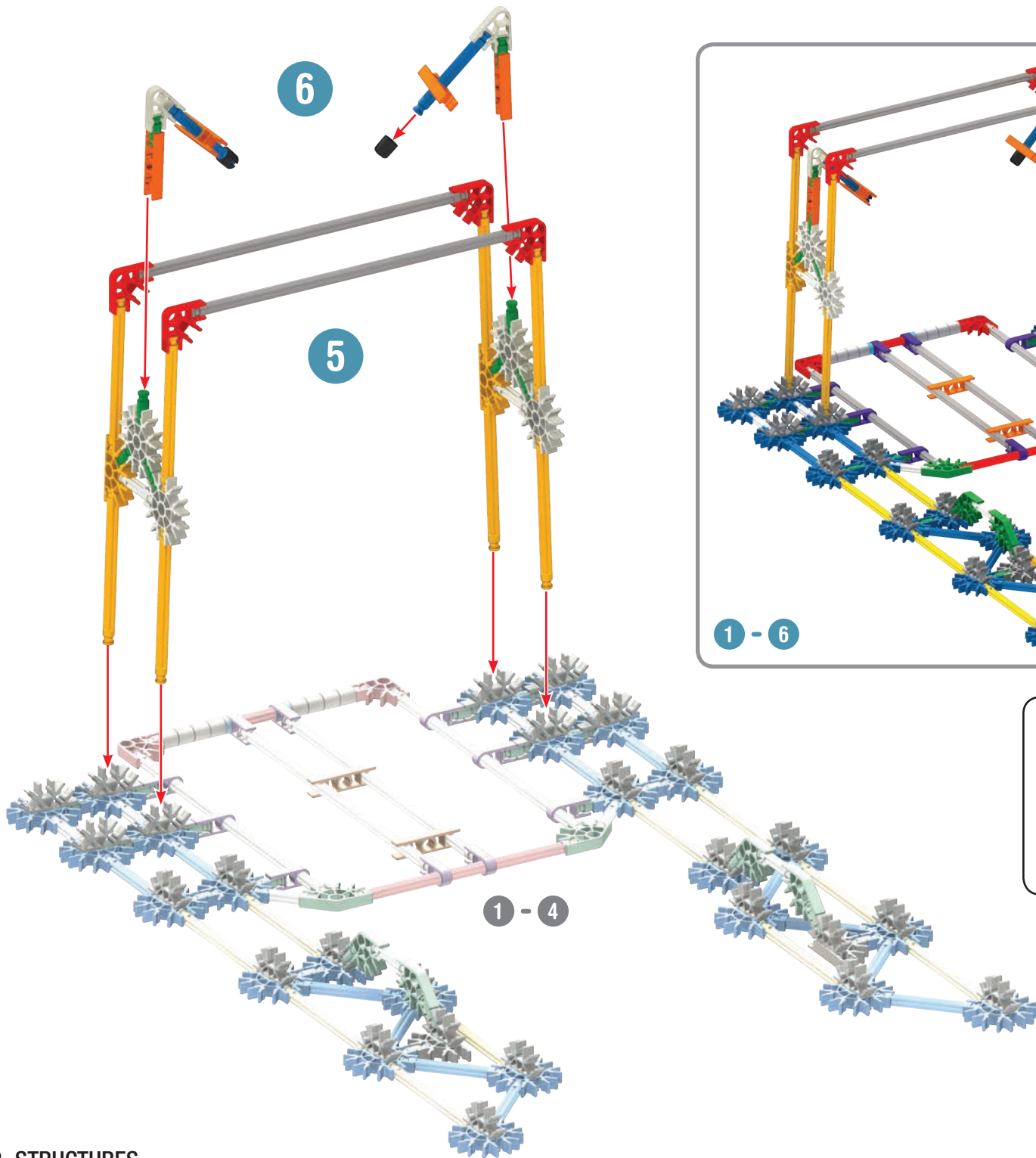

- | | | |
|---|---|---|
| 8 | 2 | 4 |
| 2 | 2 | |
| 2 | | 2 |
| 8 | | |
| 2 | | |
| 4 | 2 | 4 |

8

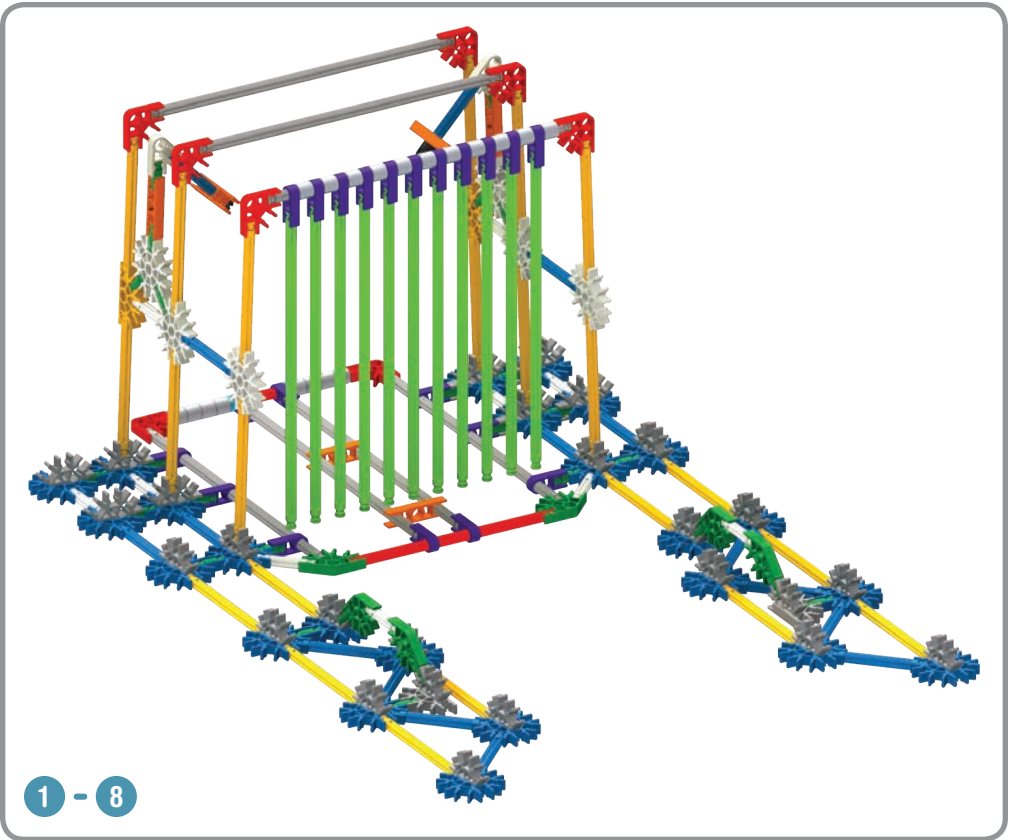
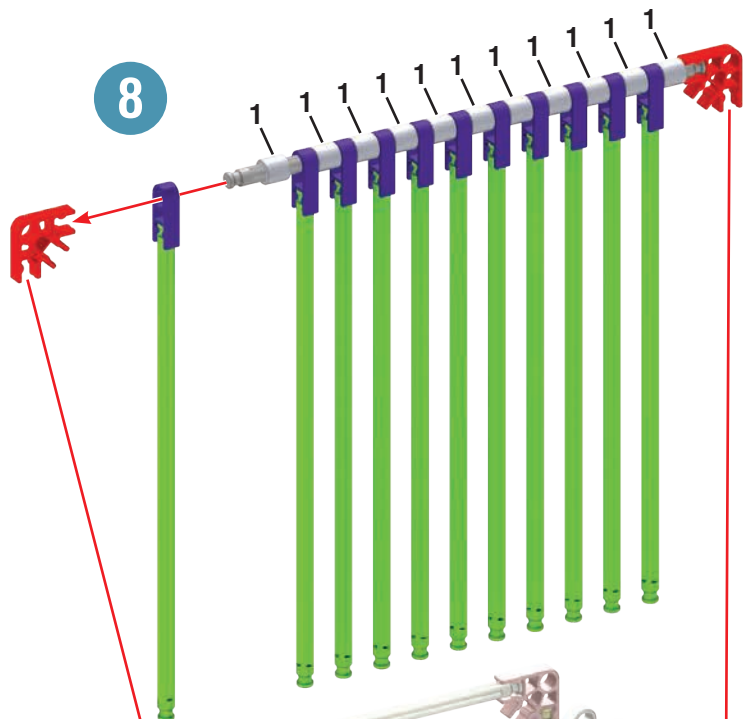

1 - 8

7



1 - 6

2		2	
4			
1			
11			
11		11	
		2	

10

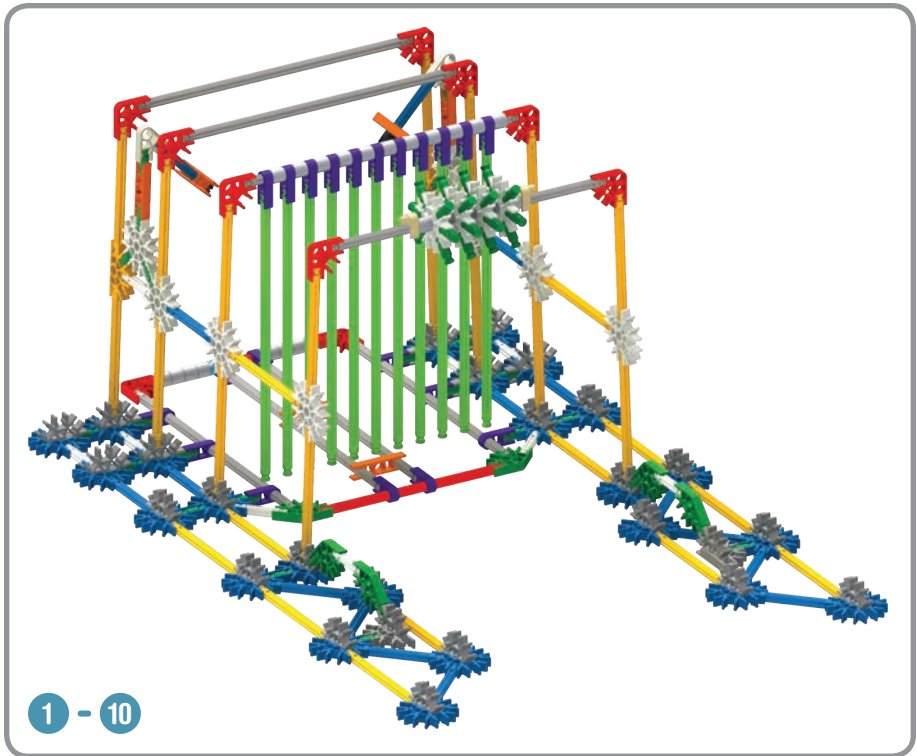
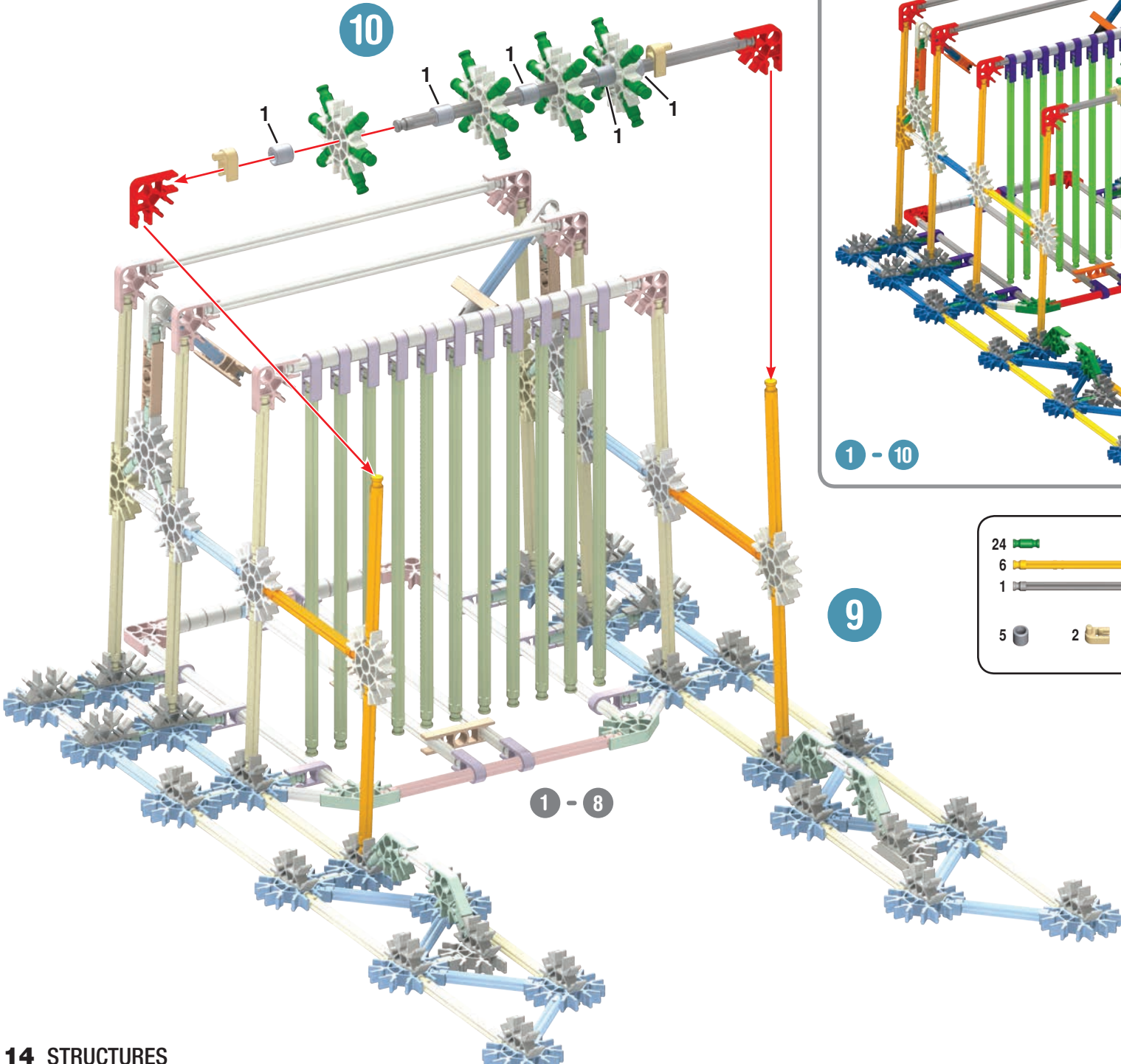

9

24				
6				
1				
5		2		2
				6

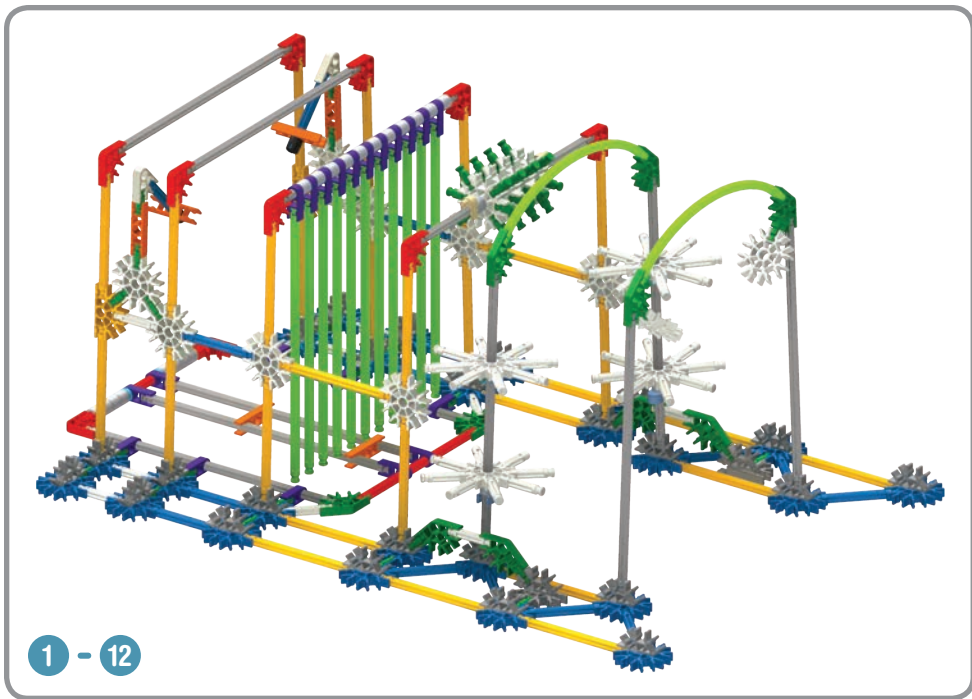

- 2
- 32
- 4
- 2
- 2
- 4
- 4
- 6

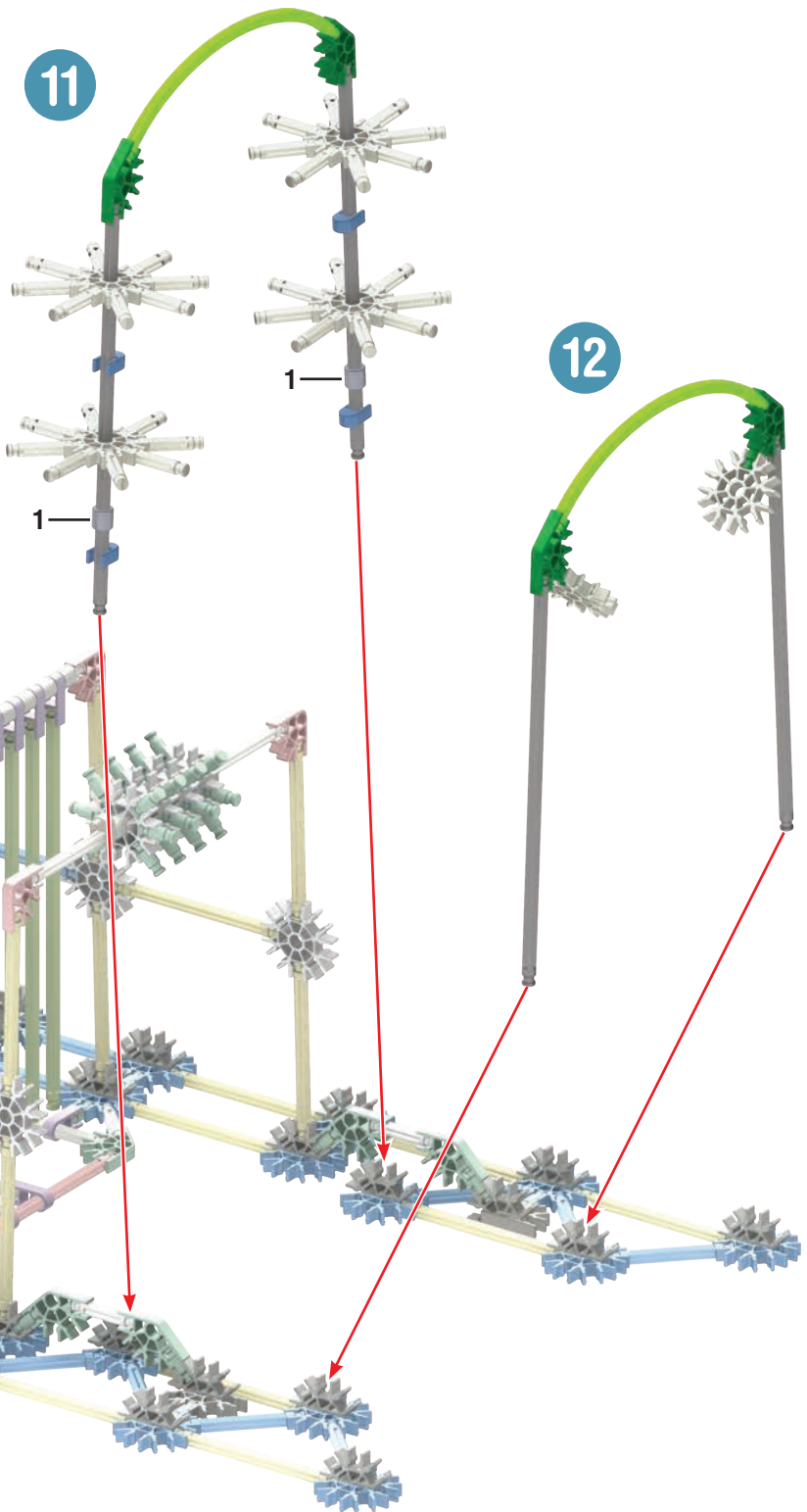

1 - 10

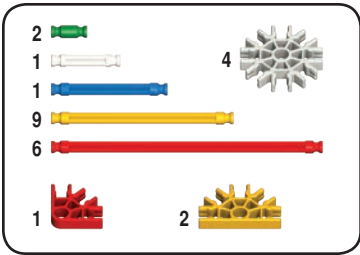

13

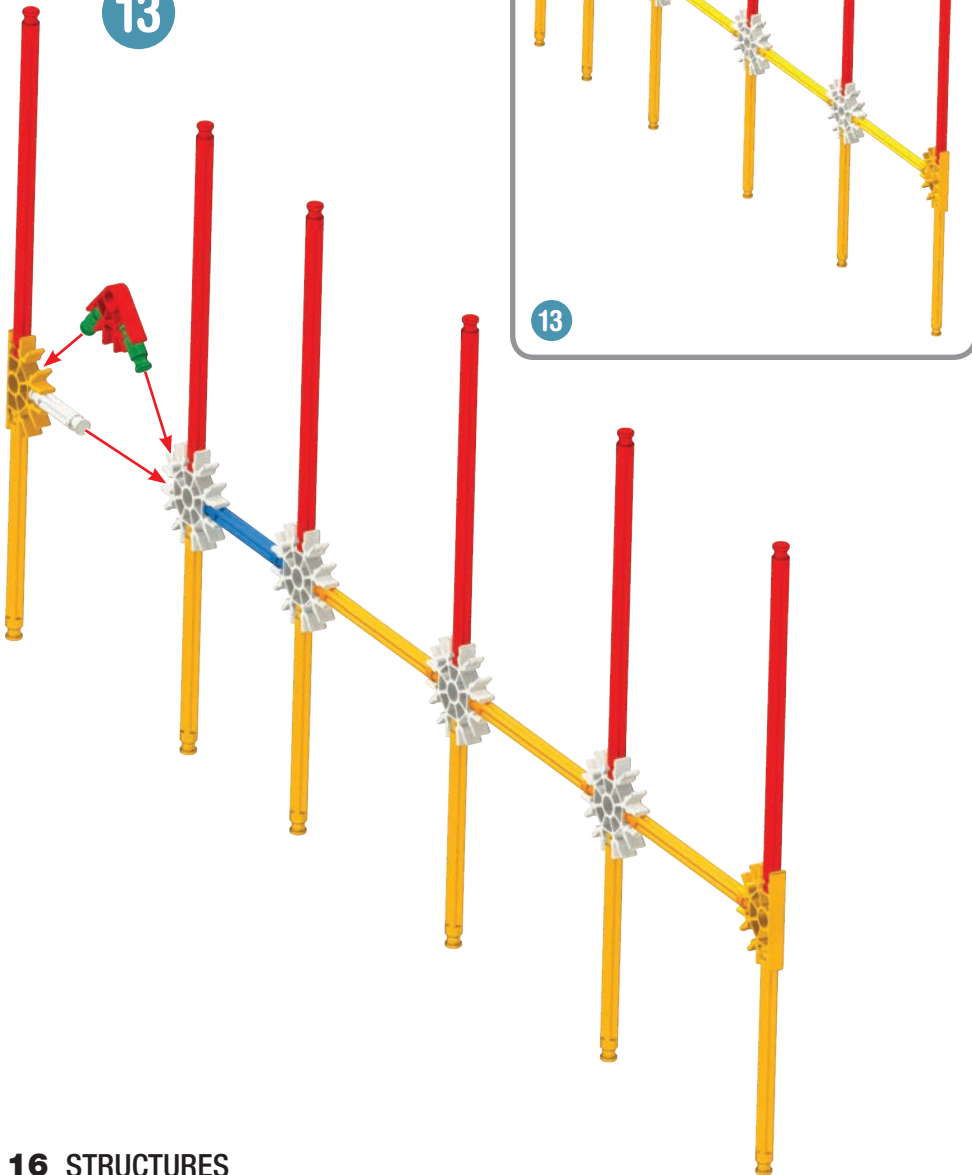

13

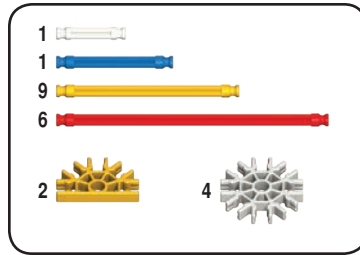

14

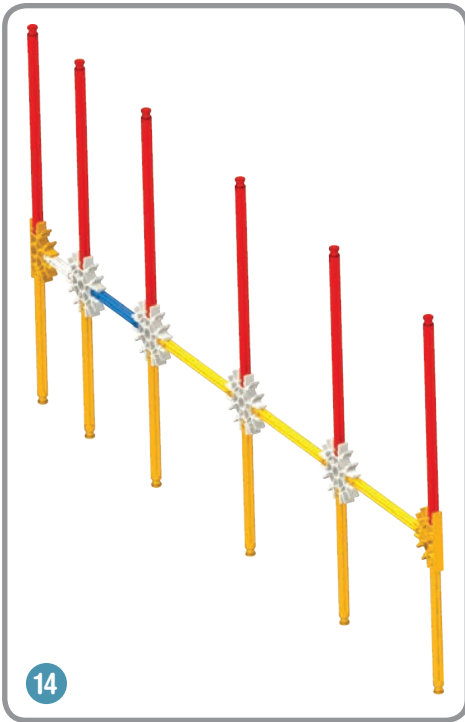
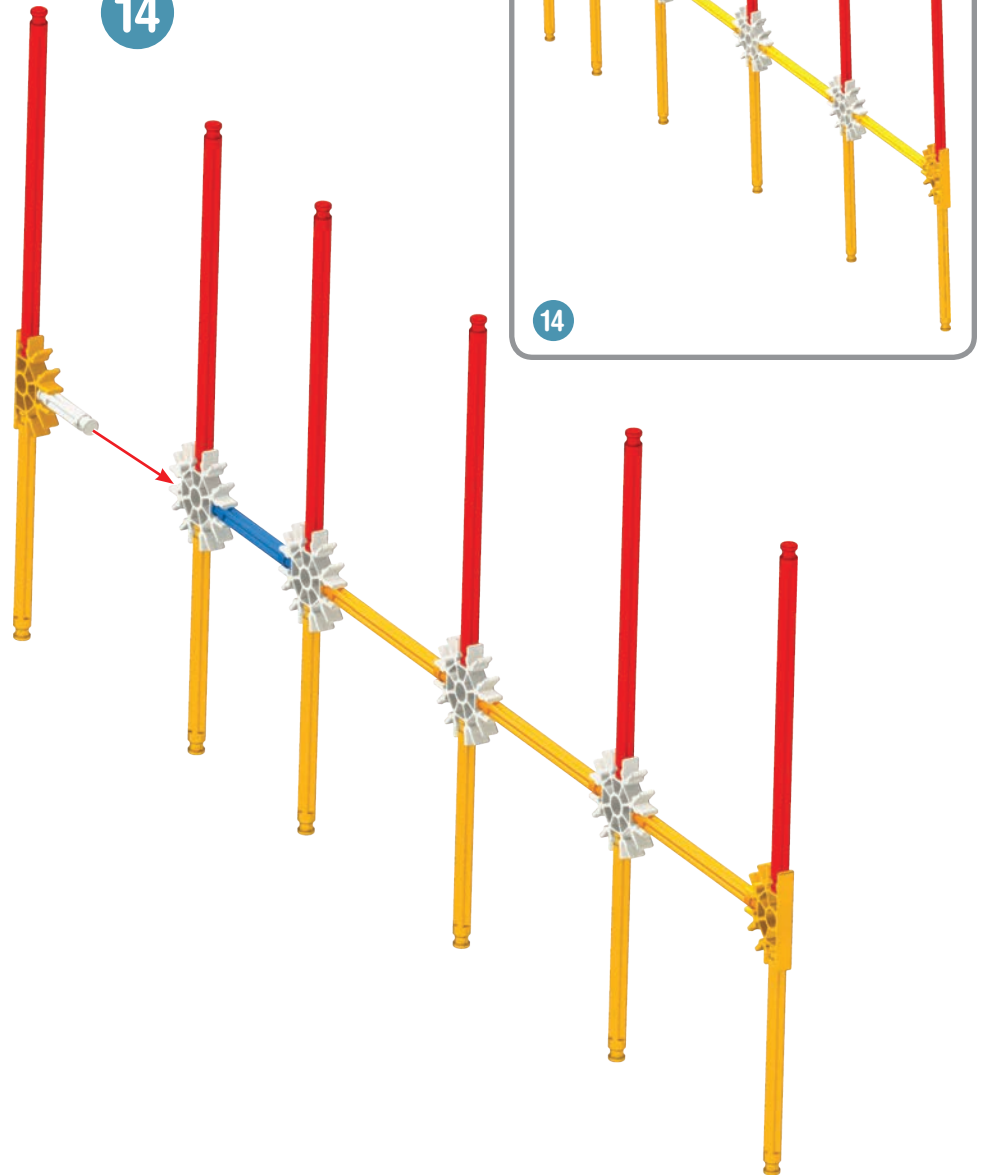

14

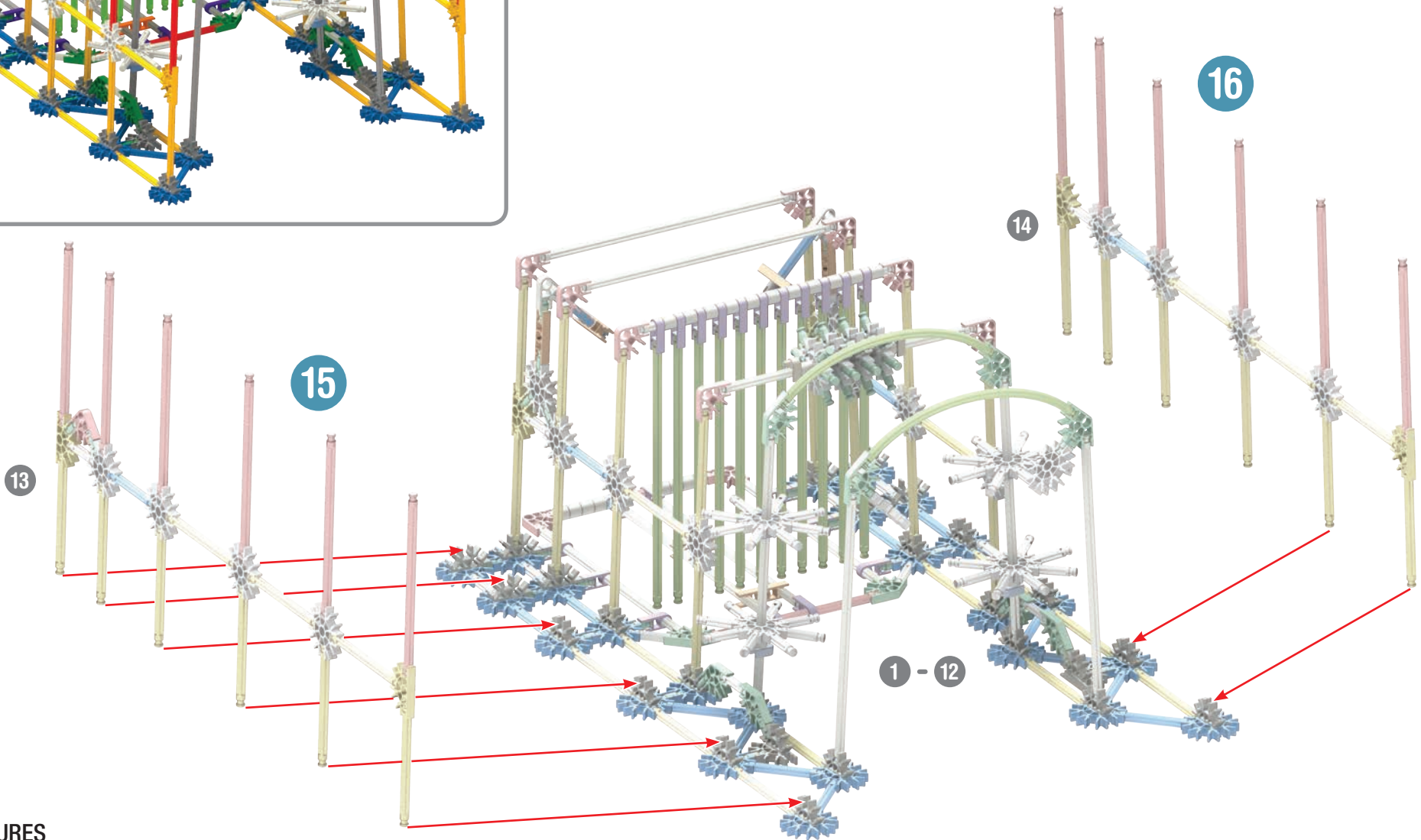
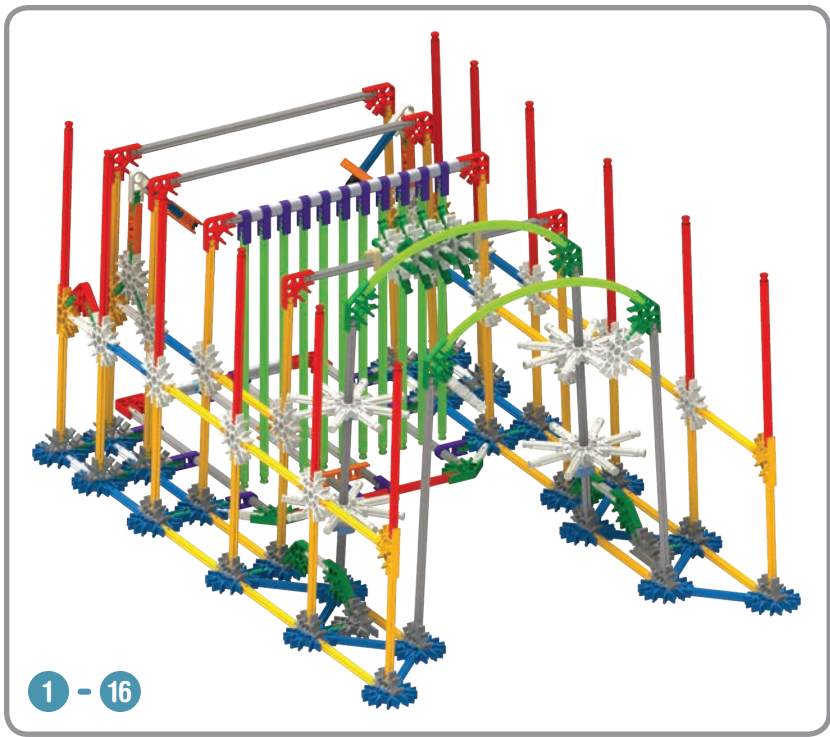

x6

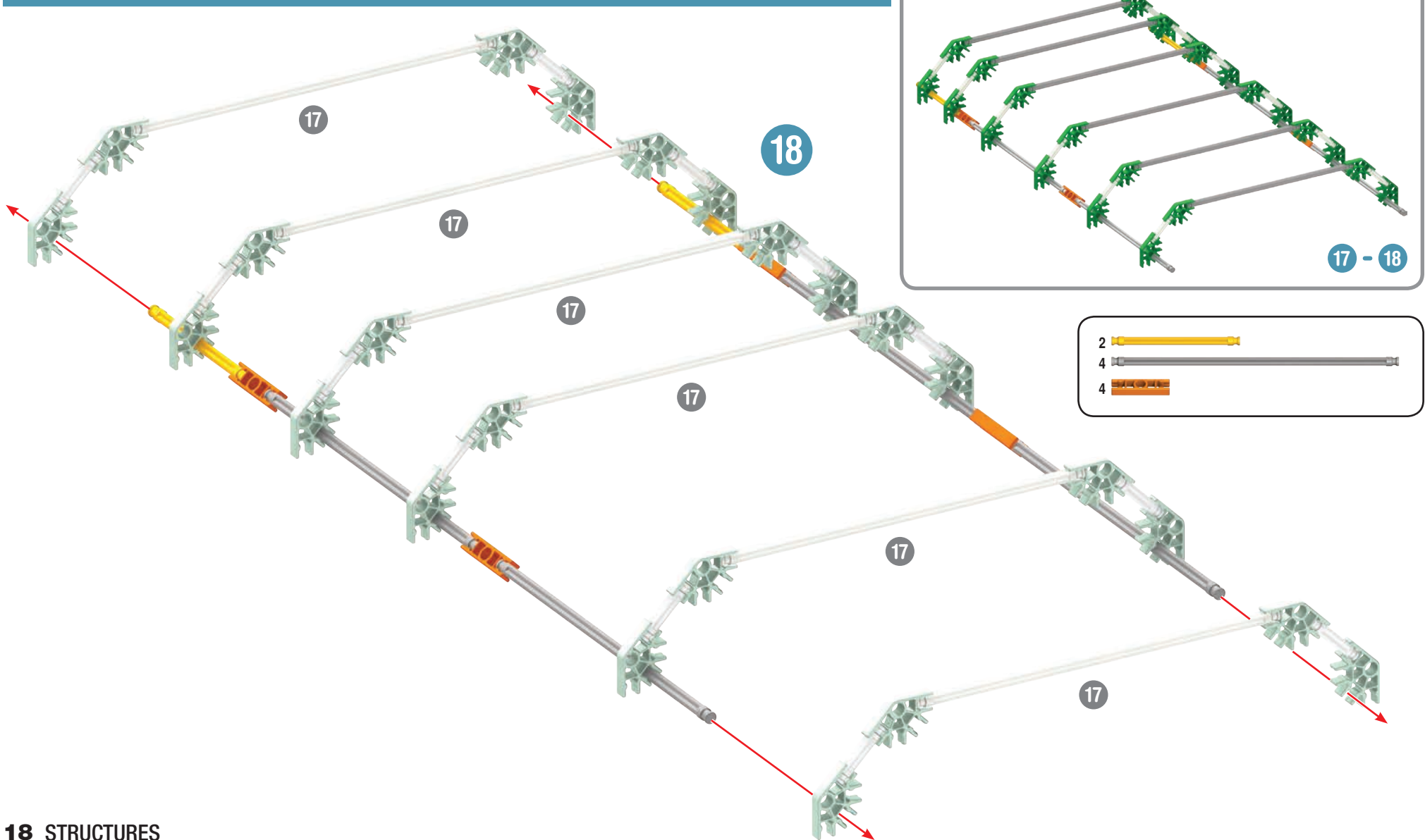
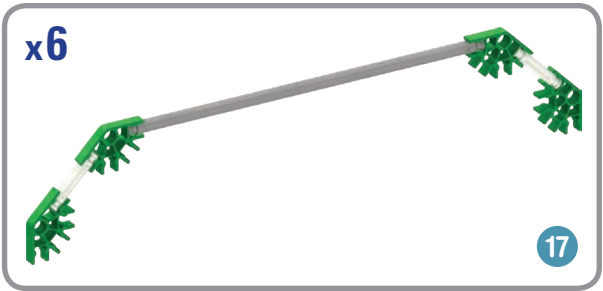
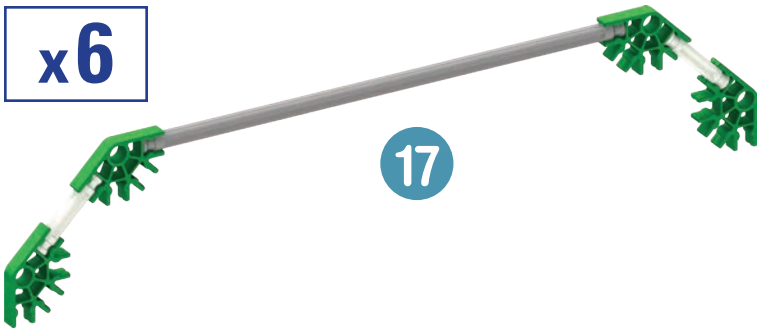

17 - 18

19

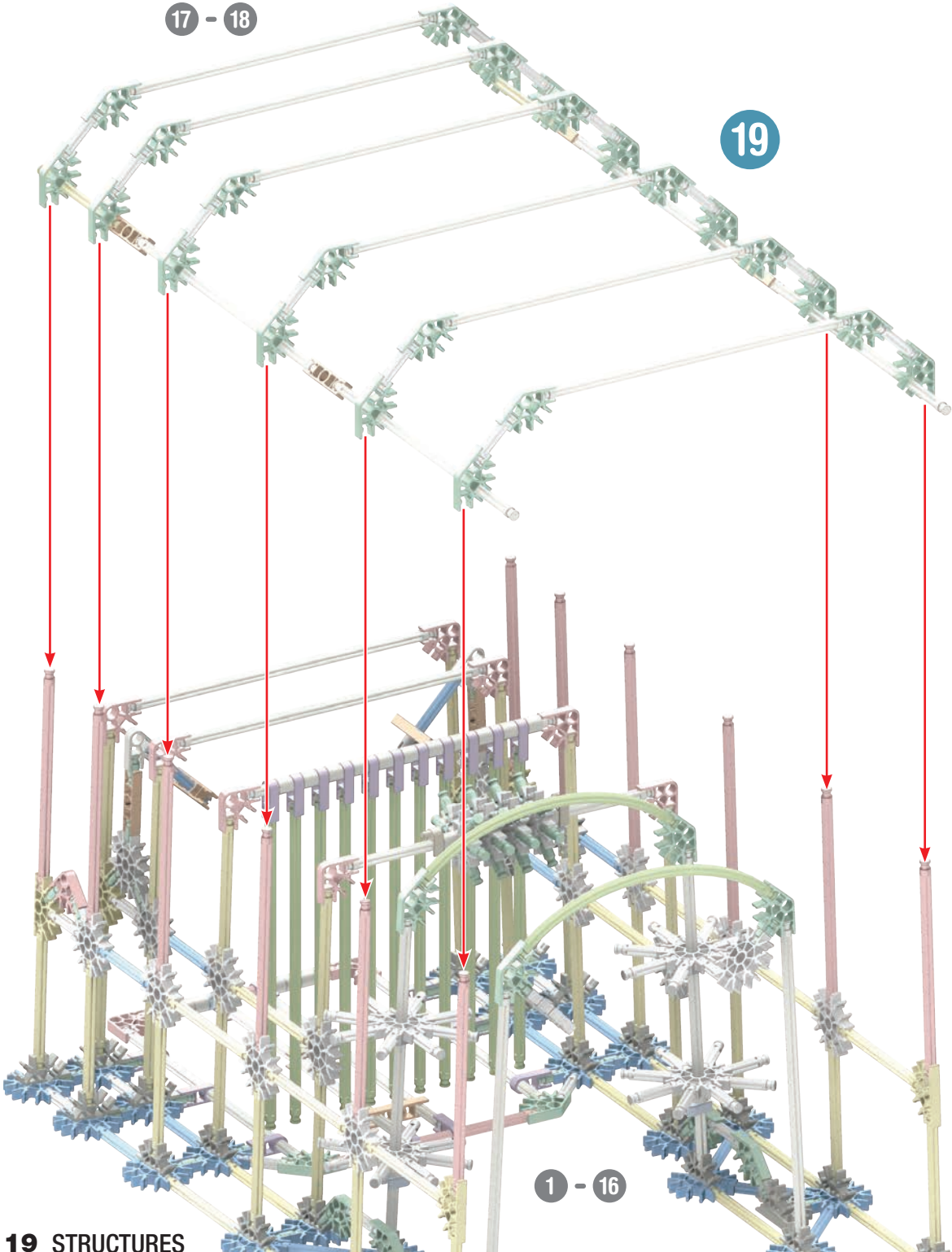

1 - 16

19 STRUCTURES

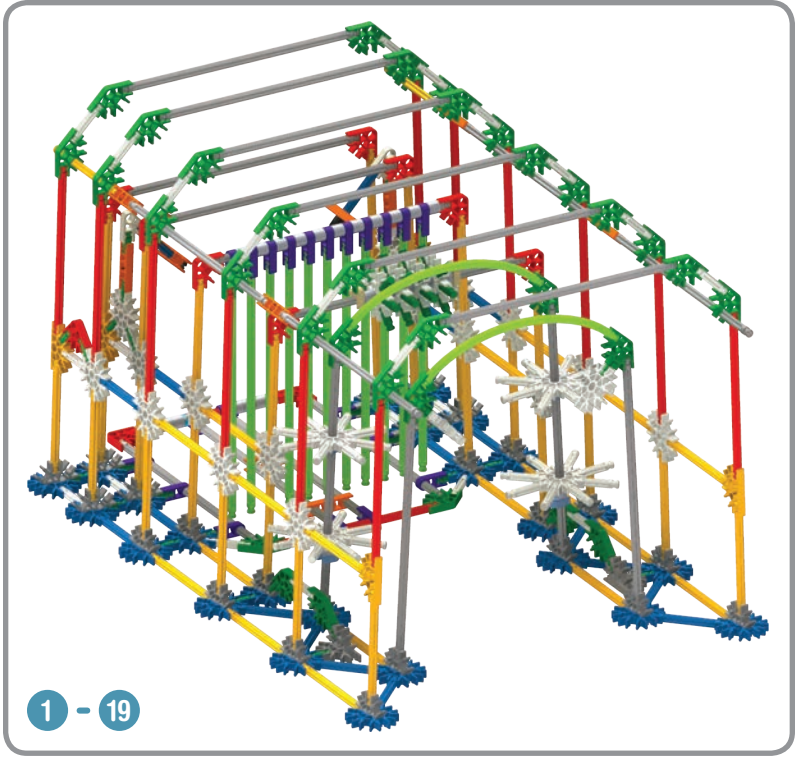

1 - 19

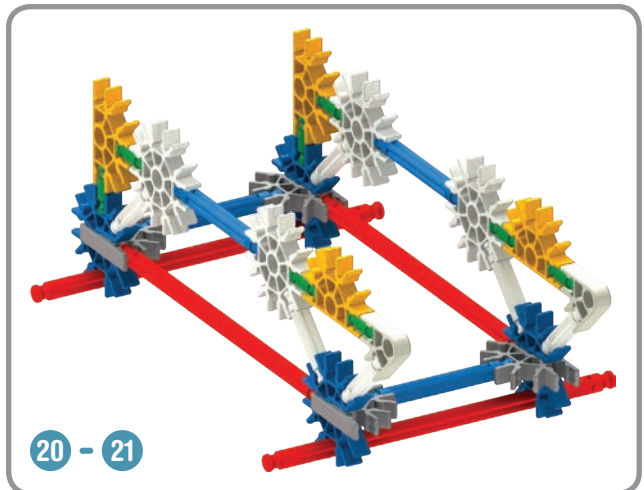
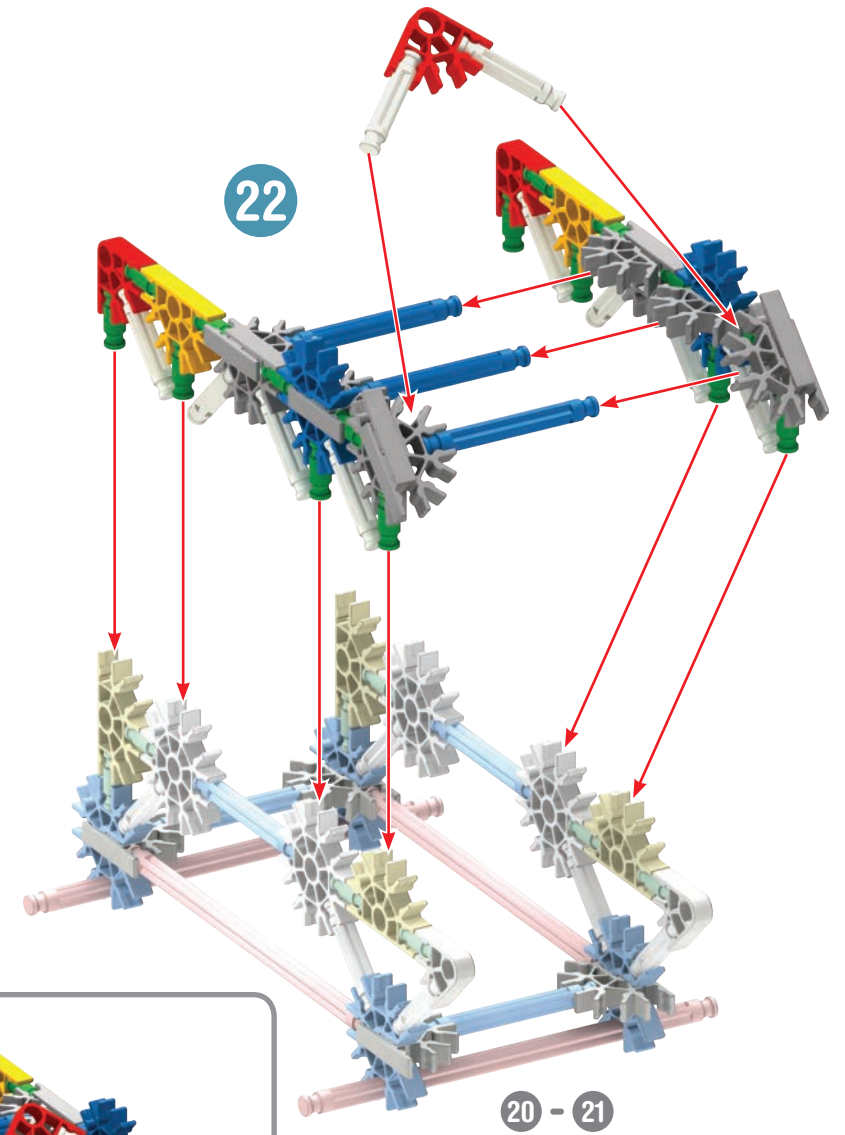
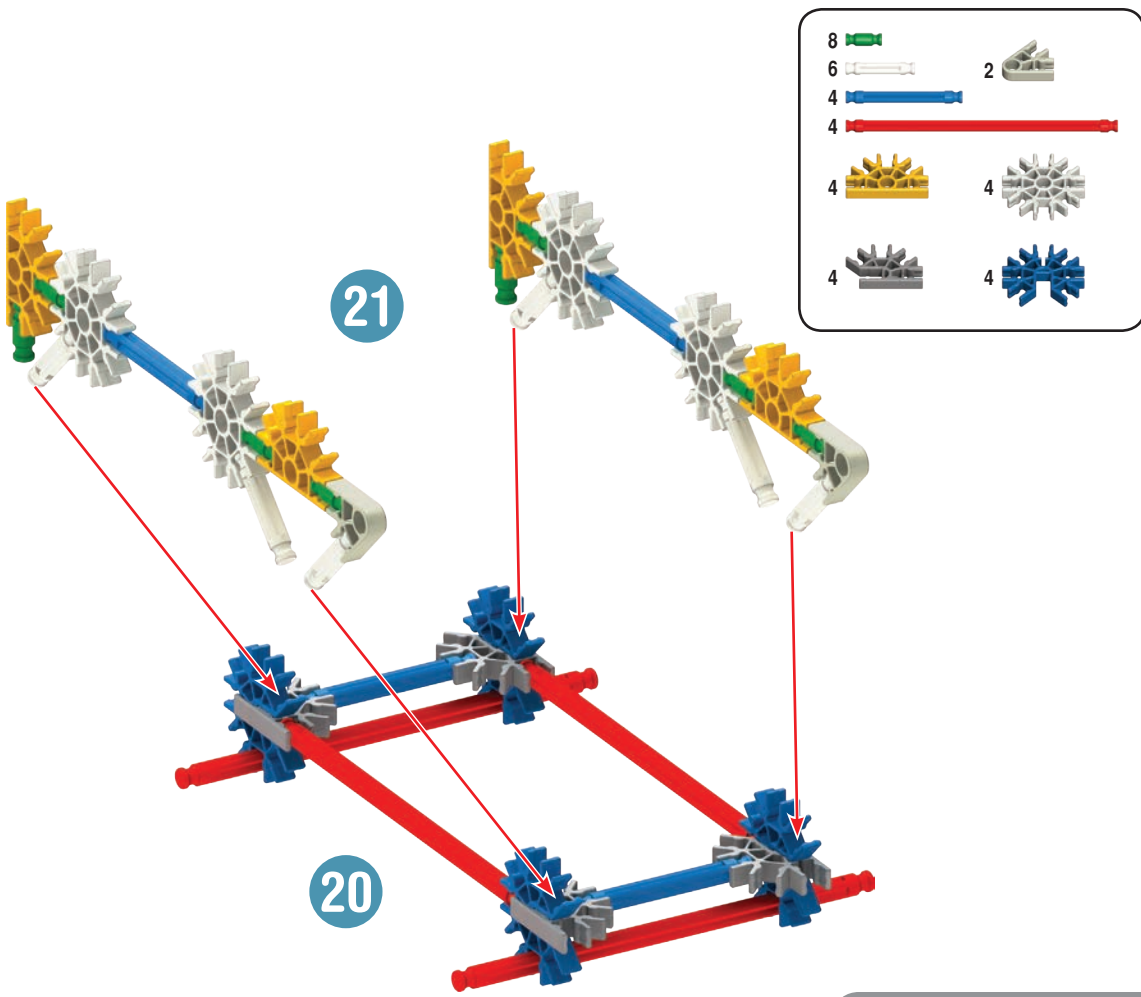

20 - 21

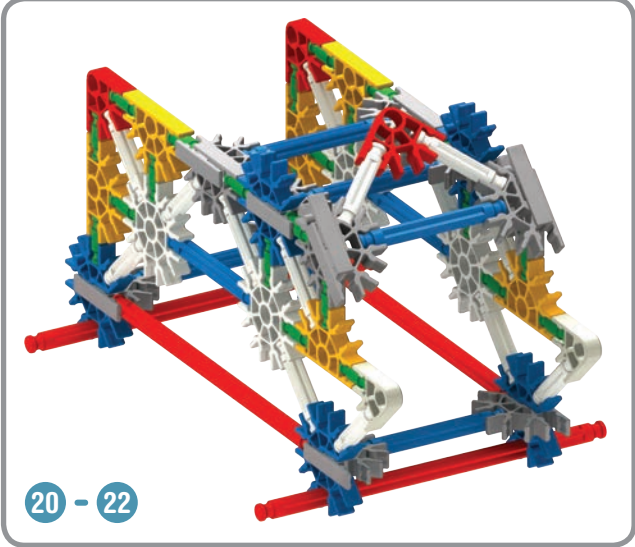

20 - 22

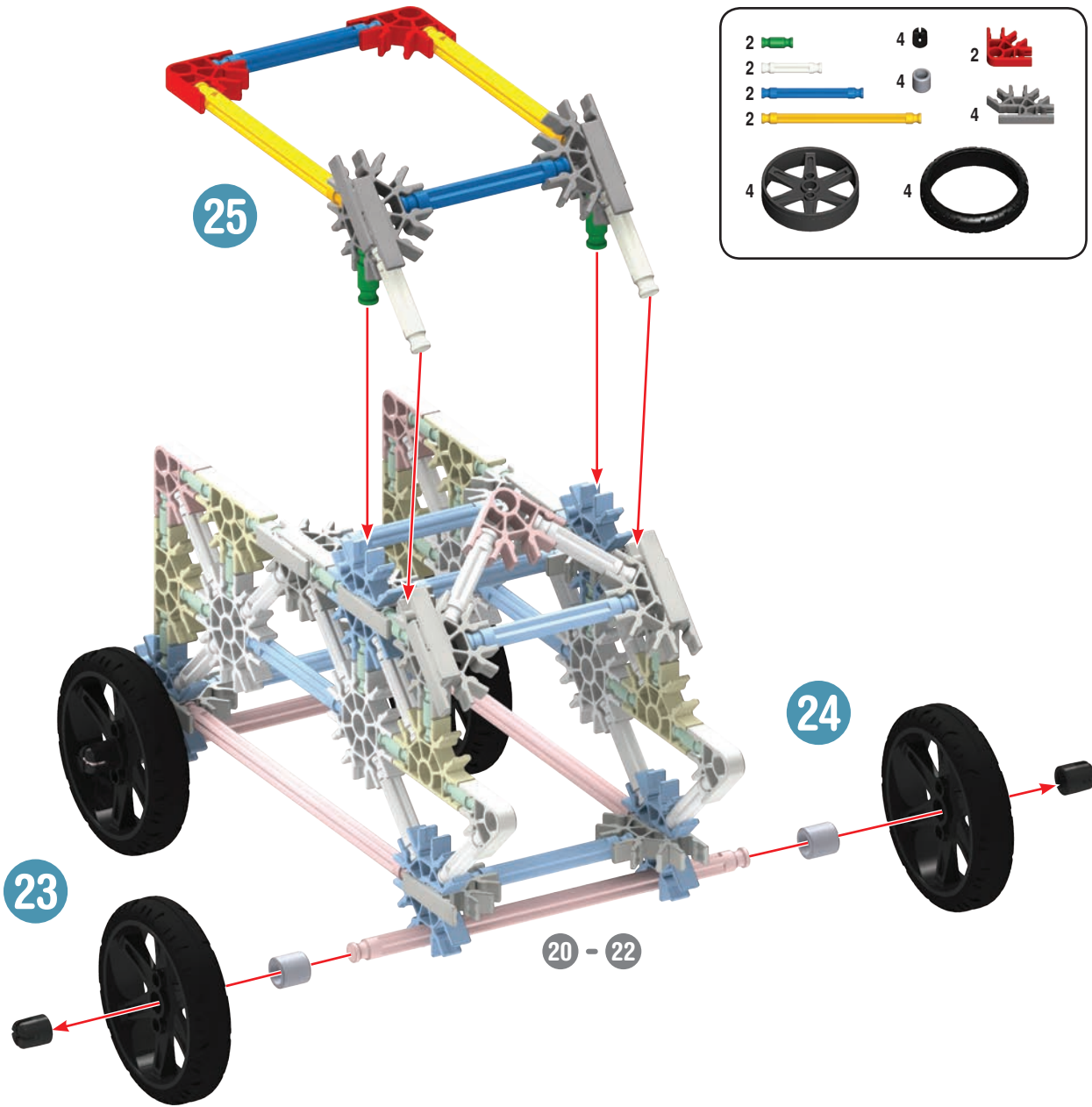

- | | | | | | |
|---|--|---|--|---|--|
| 2 | | 4 | | 2 | |
| 2 | | 4 | | 4 | |
| 2 | | | | | |
| 2 | | | | | |
| 4 | | 4 | | | |



23

24

25

20 - 22

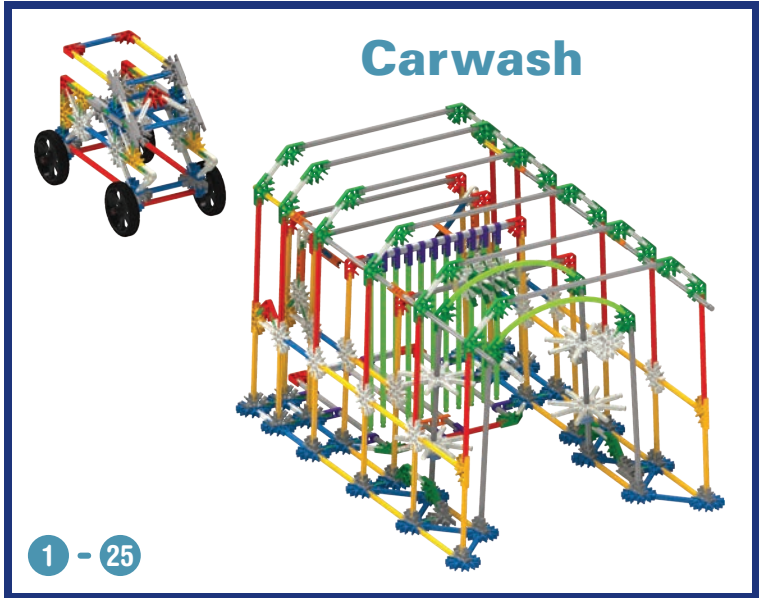

Carwash

1 - 25

Castle

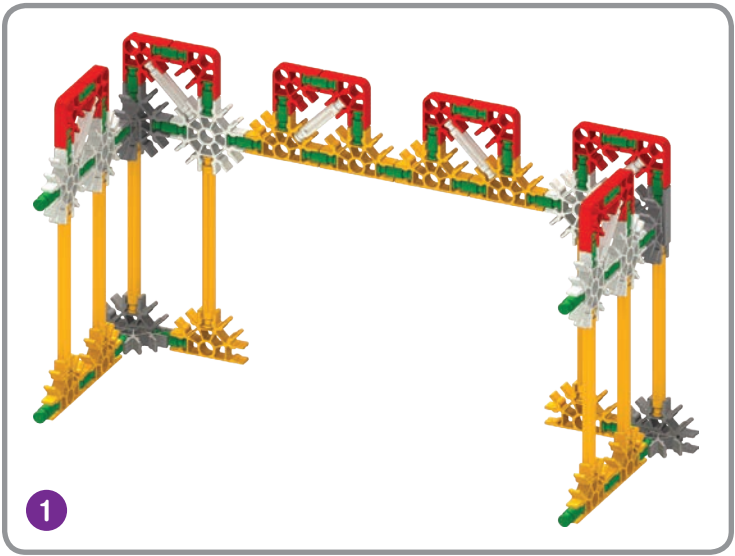
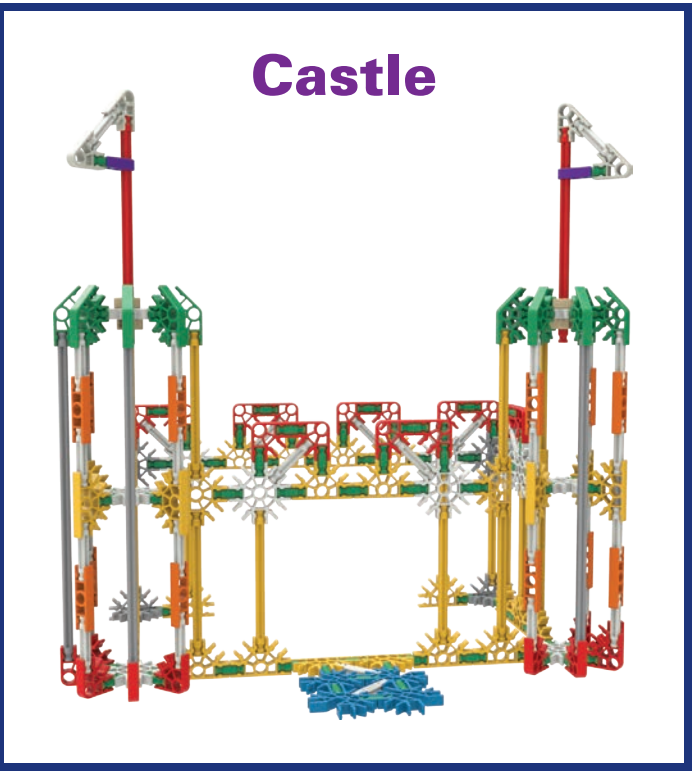

- | | | | | | |
|----|--|----|--|---|--|
| 39 | | 12 | | | |
| 6 | | | | | |
| 8 | | | | 6 | |
| 10 | | 8 | | | |

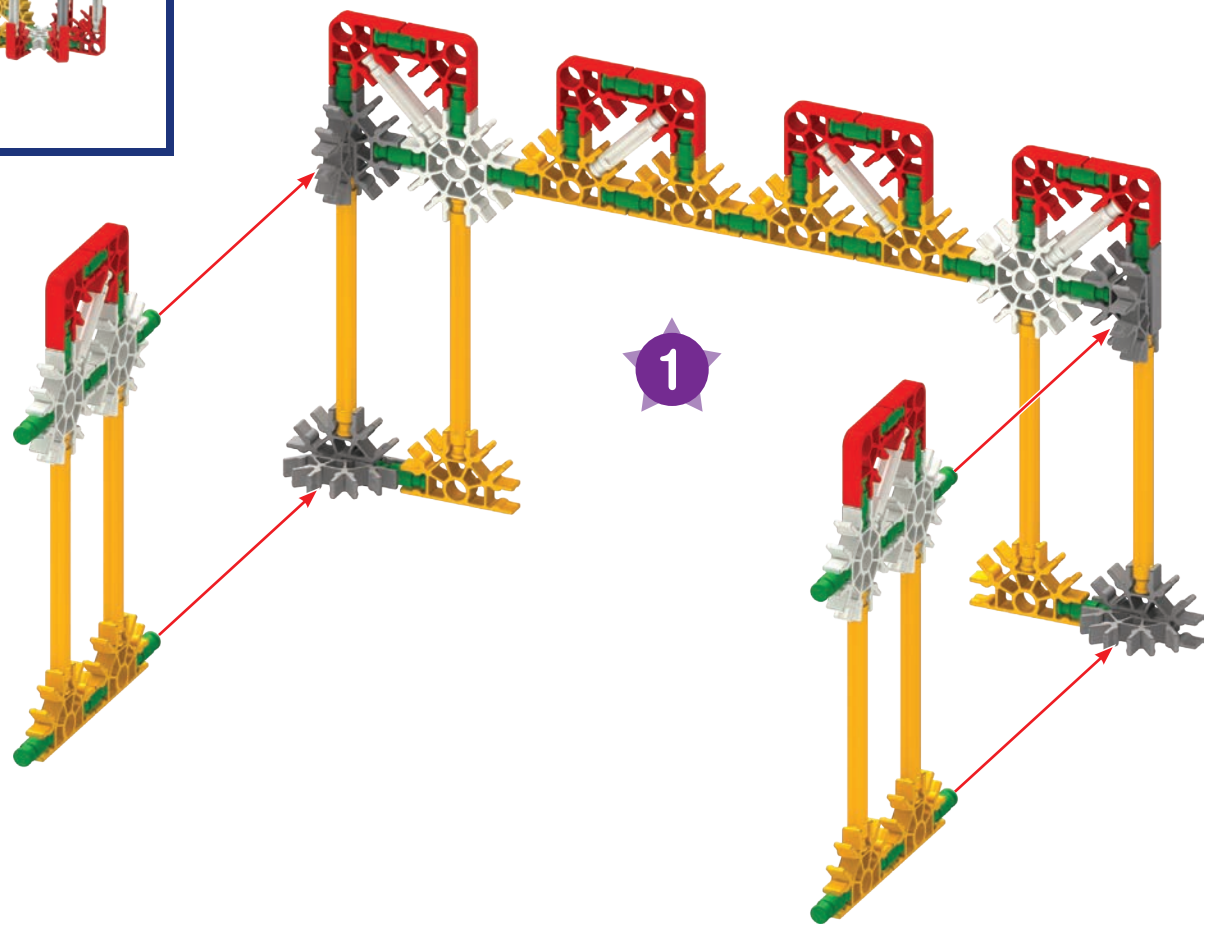

x2

- 20
- 24
- 8
- 4
- 12
- 10
- 14
- 4

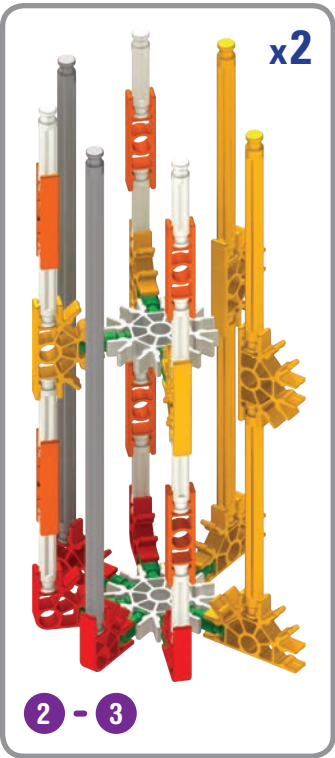
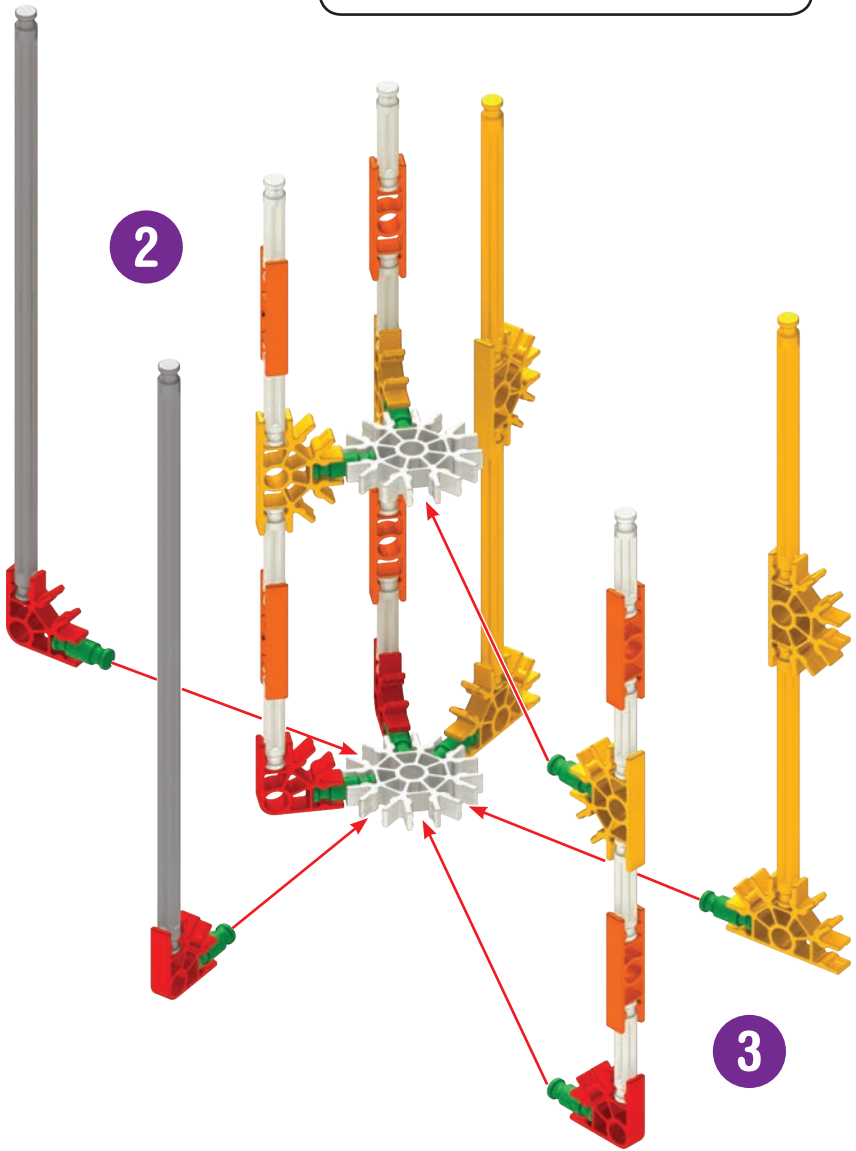

x2

4

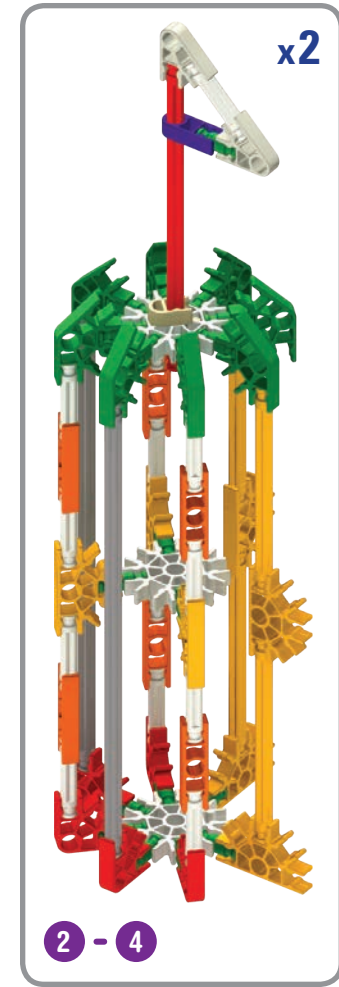
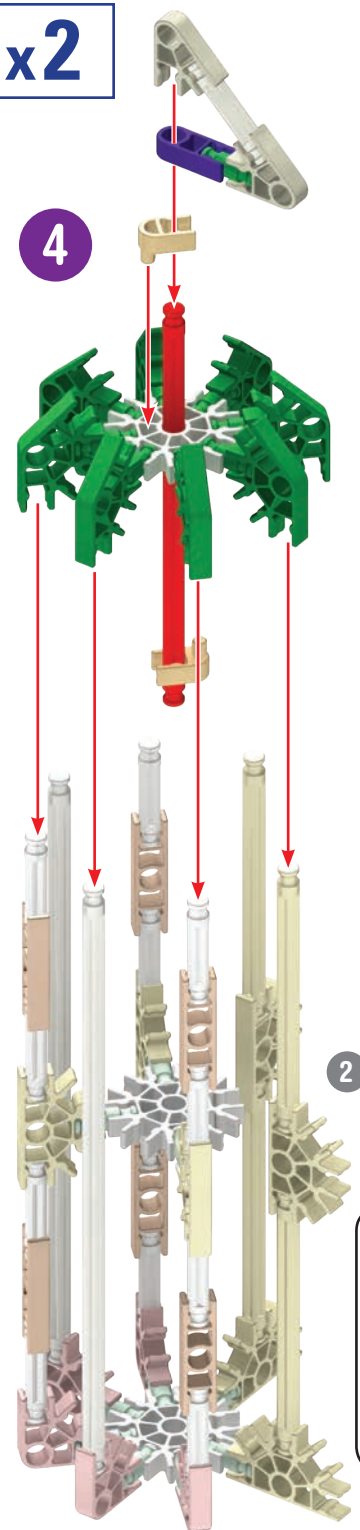

- 18
- 2
- 2
- 16
- 4
- 4
- 2
- 2

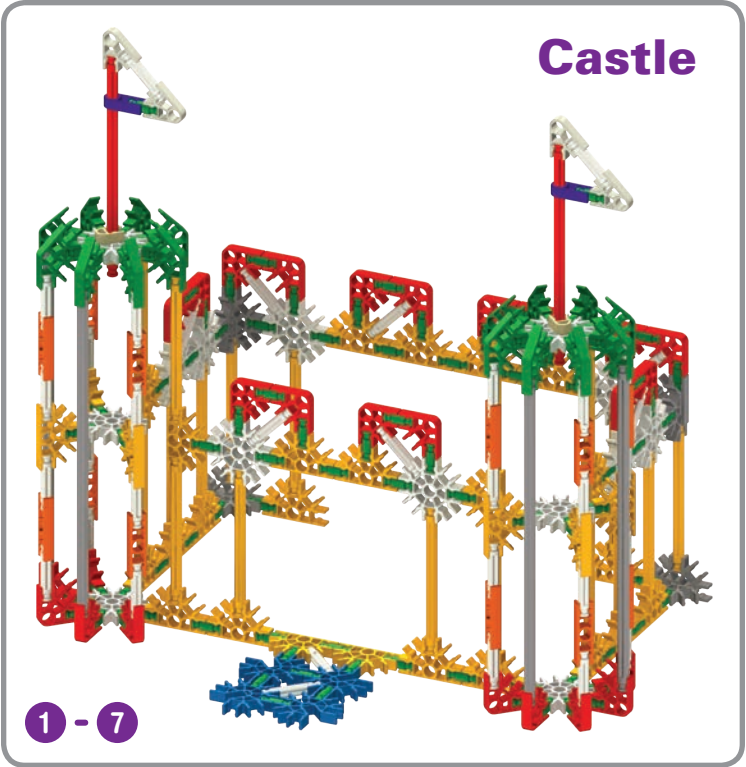
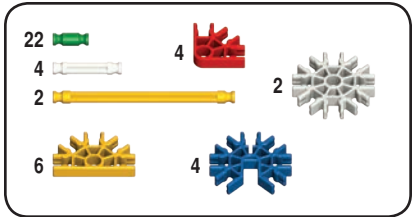
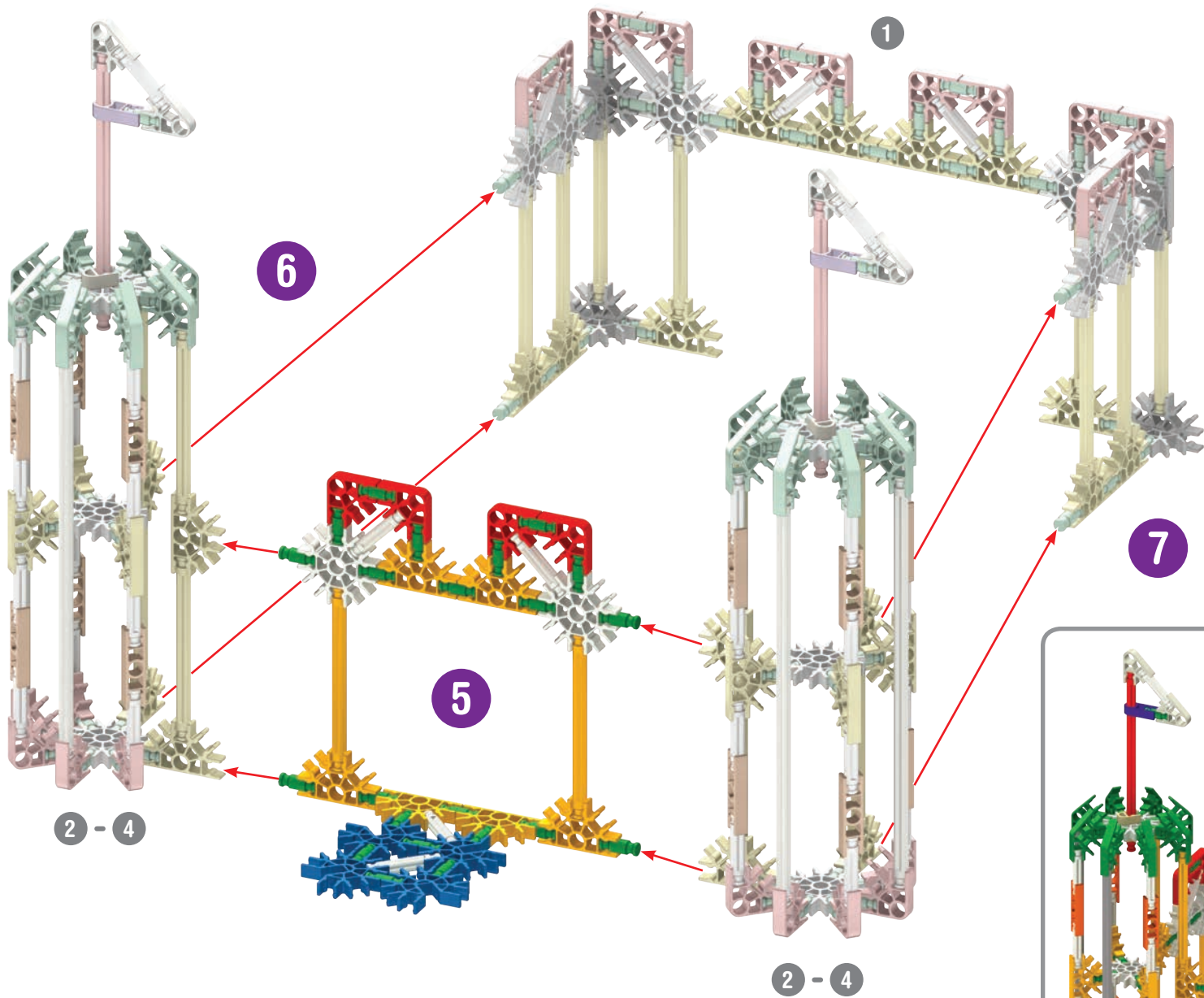





Clock Tower

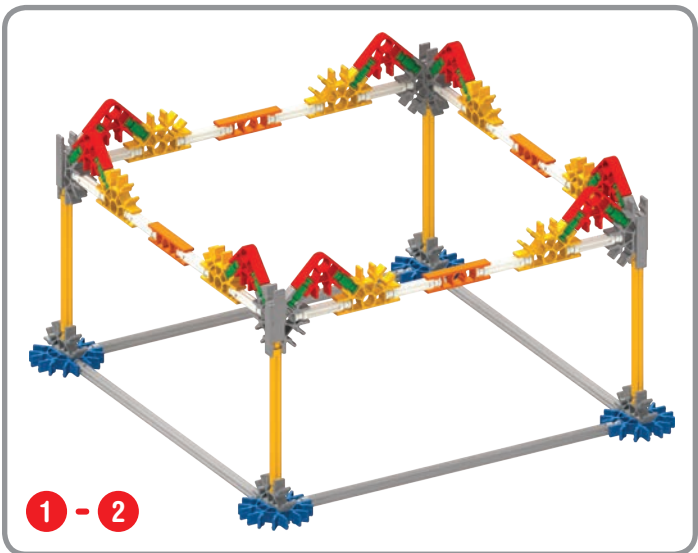
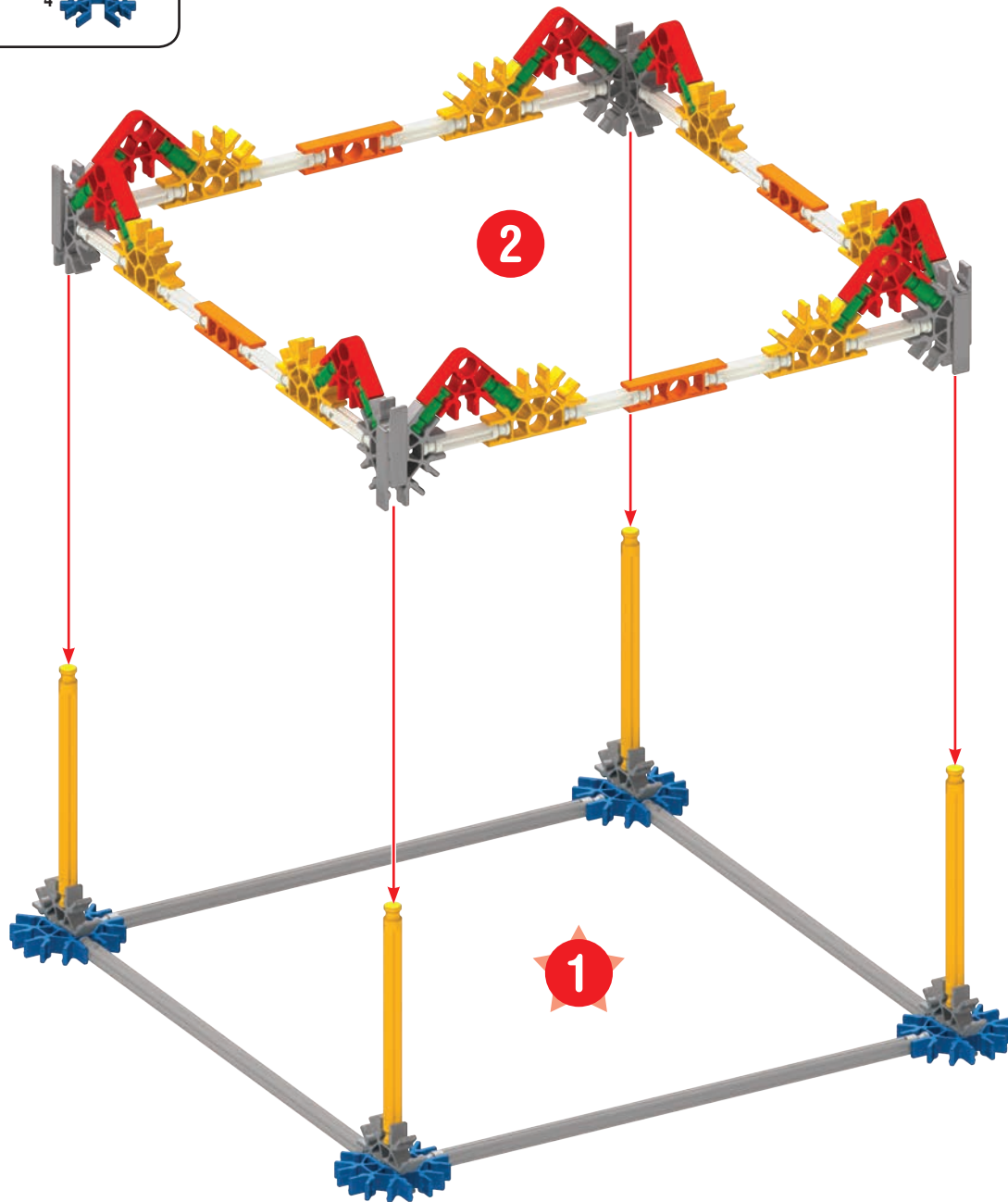

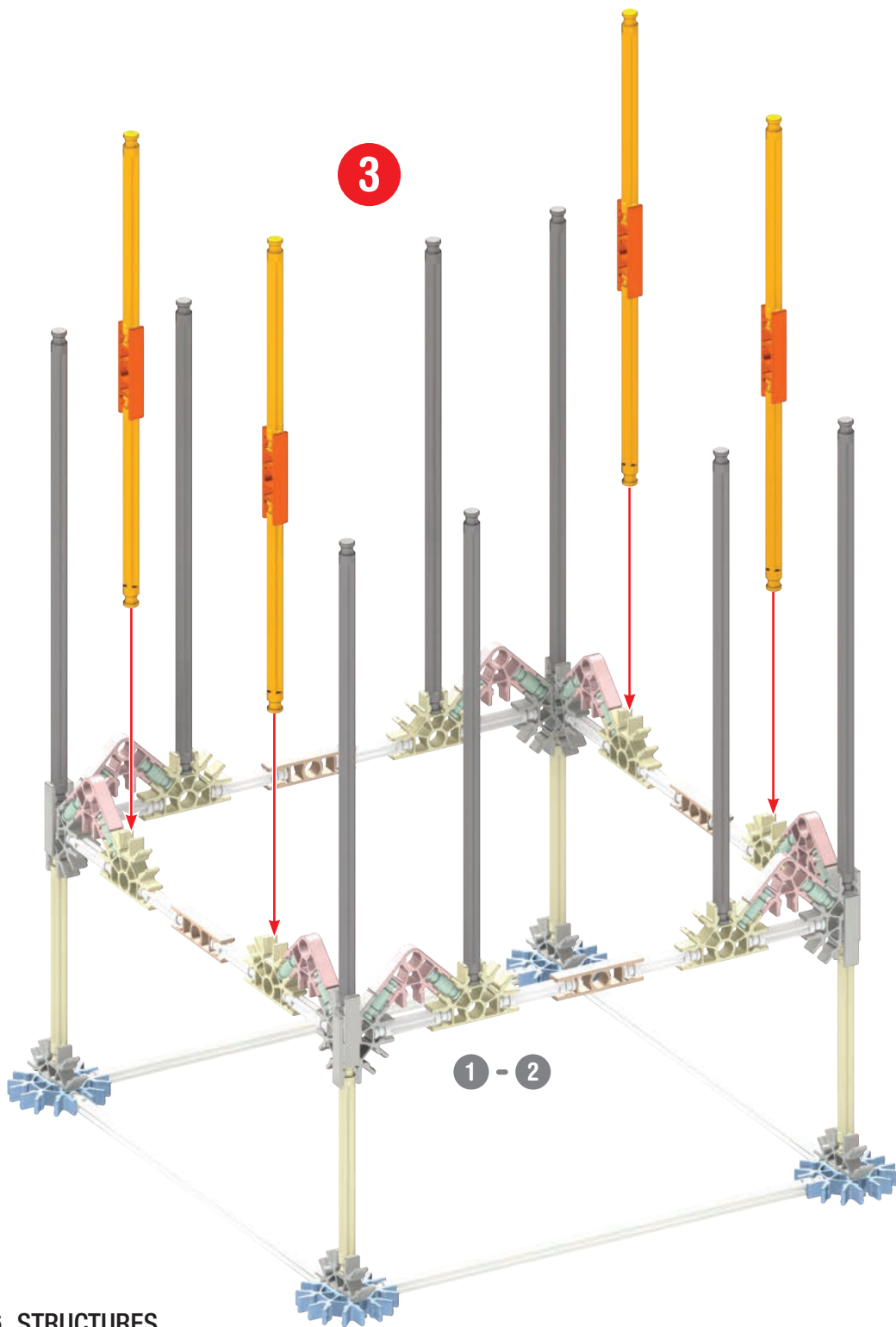
- | | | | | | |
|----|--|----|--|---|--|
| 16 | | 8 | | 8 | |
| 16 | | 8 | | 8 | |
| 4 | | 4 | | 4 | |
| 4 | | 12 | | 4 | |
| 4 | | 12 | | 4 | |





8	
8	
4	

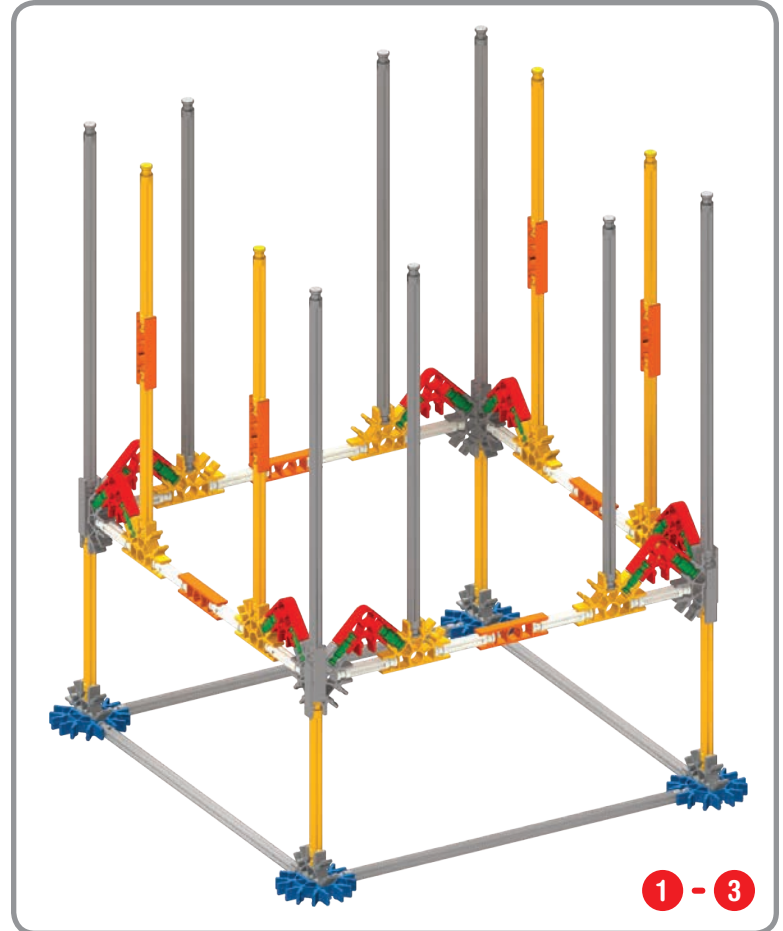



- 32
- 16
- 16
- 8
- 12

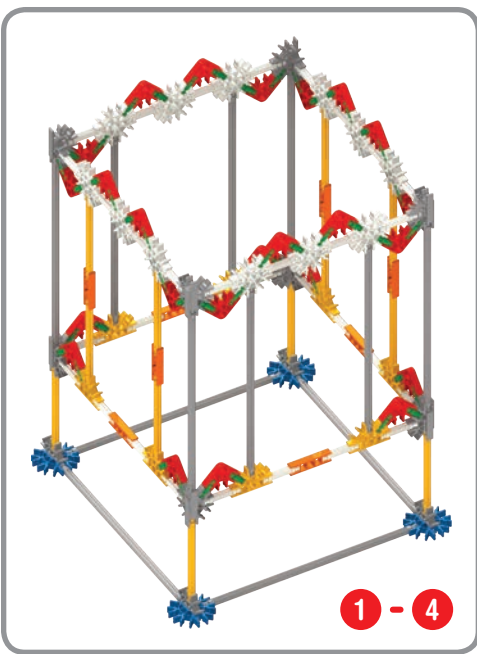
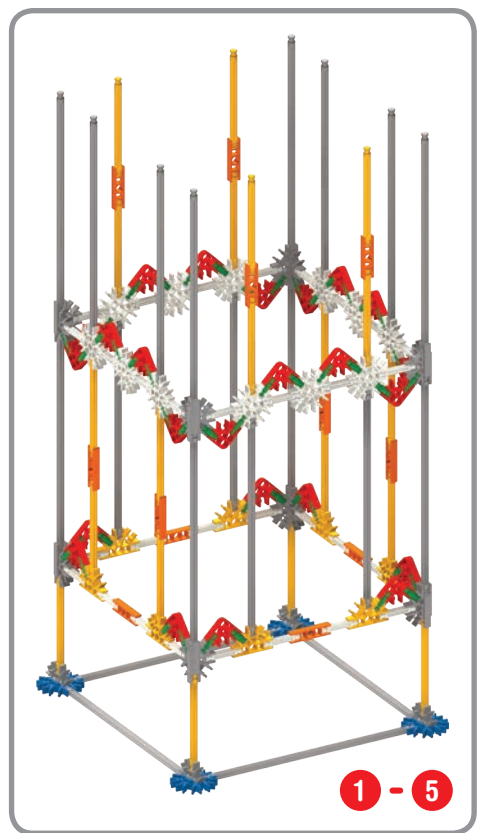

- 8
- 8
- 4

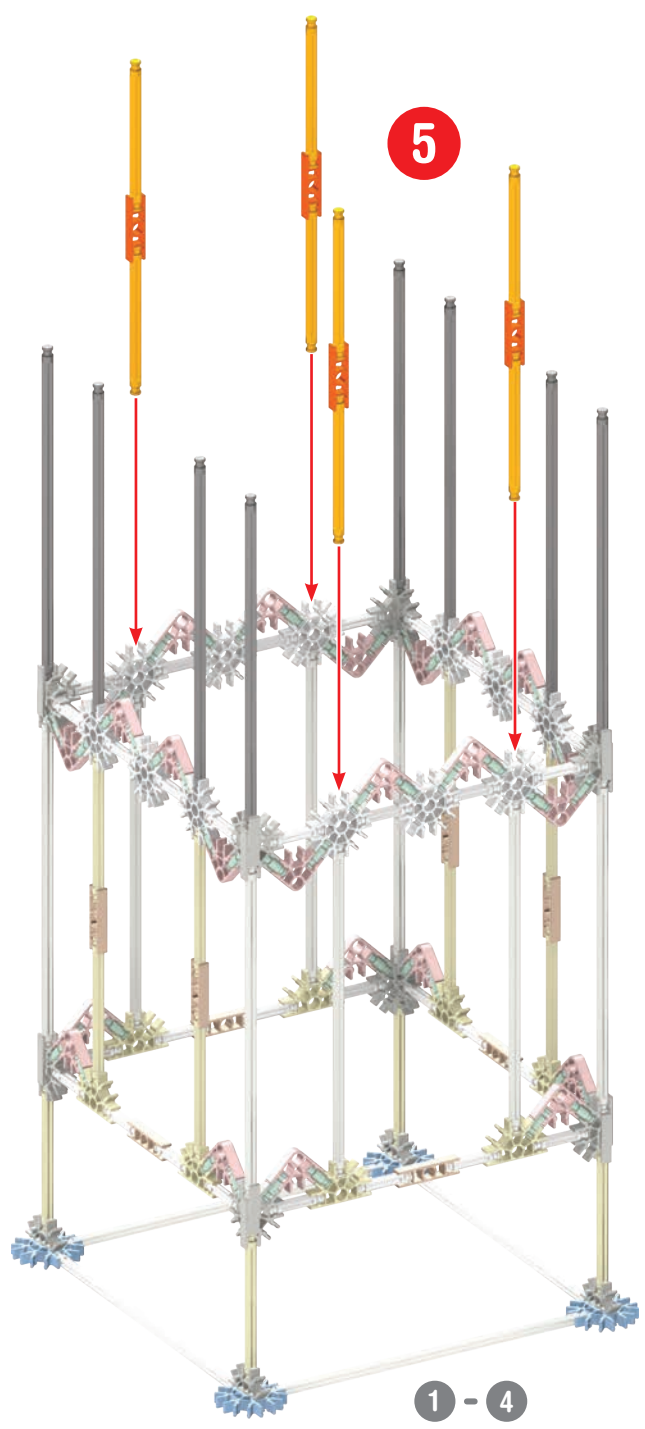

5

1 - 4

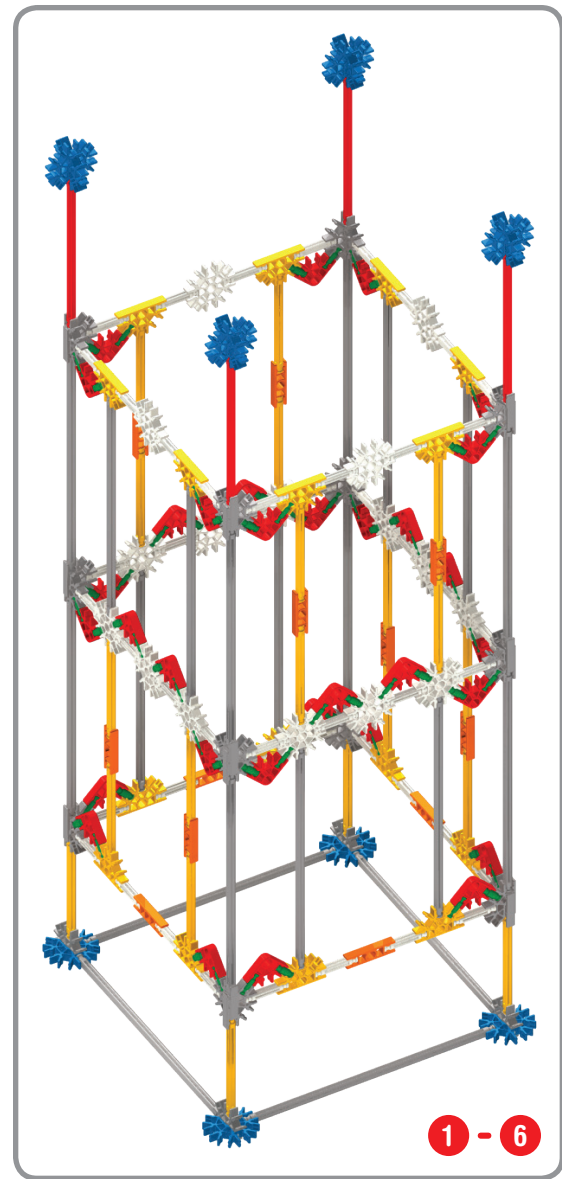
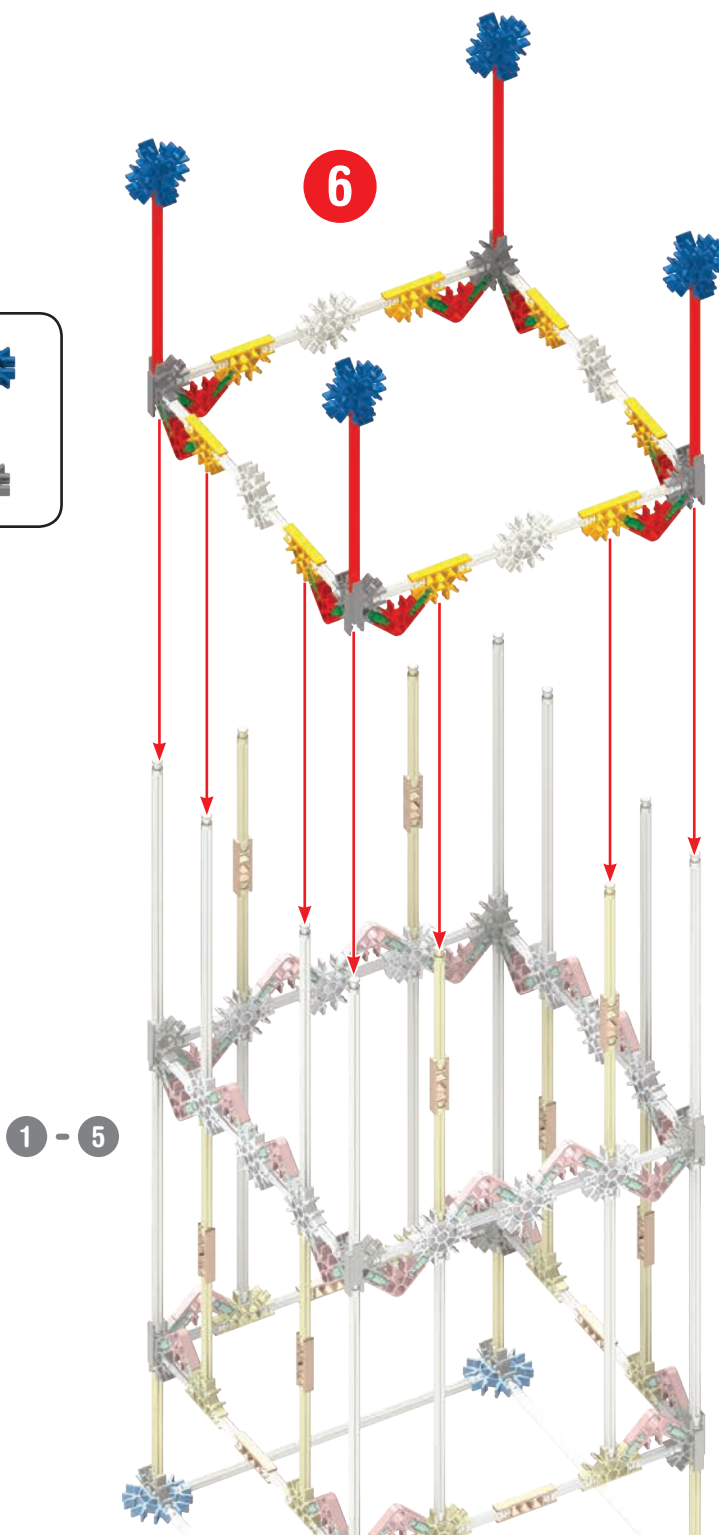
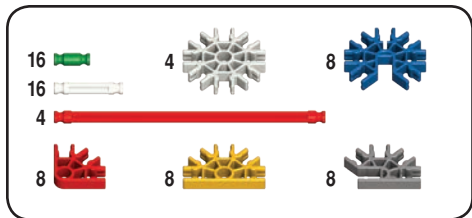

x3

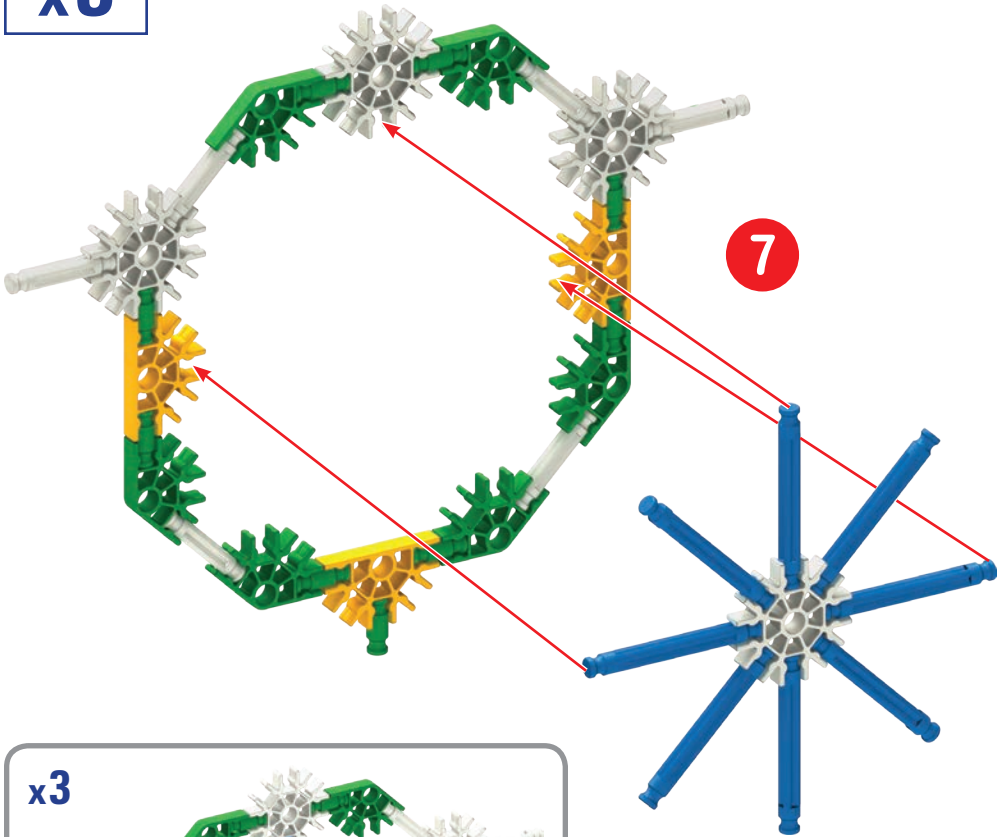

- | | | | |
|----|--|----|--|
| 27 | | 12 | |
| 18 | | | |
| 24 | | | |
| 18 | | 9 | |

- | | | | |
|---|--|---|--|
| 6 | | 3 | |
| 6 | | | |
| 3 | | | |
| 3 | | 6 | |

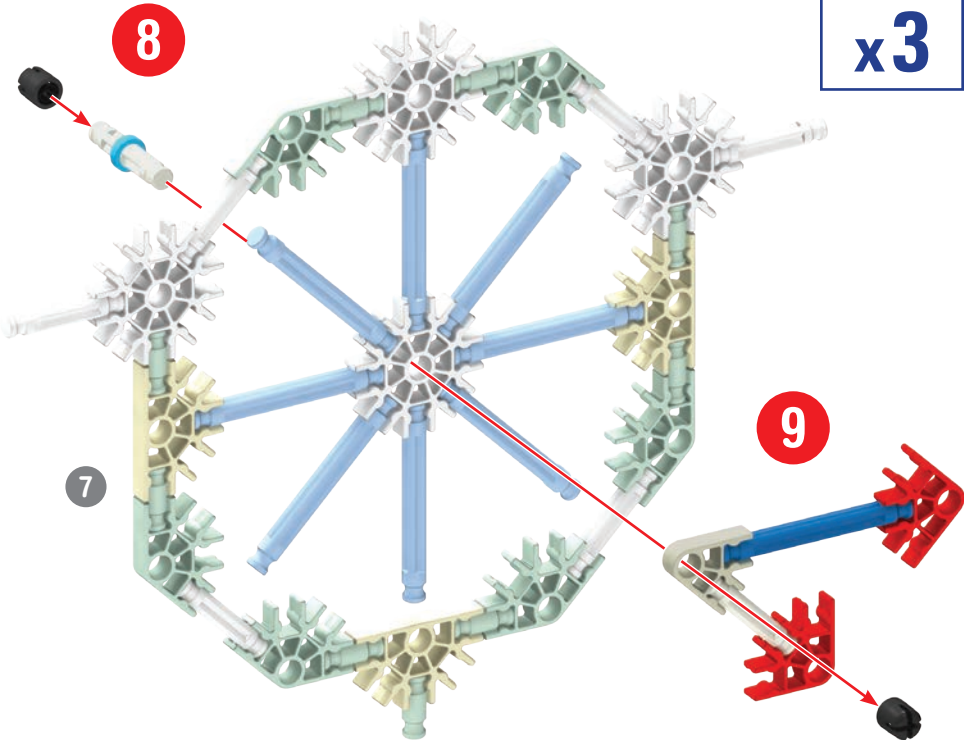

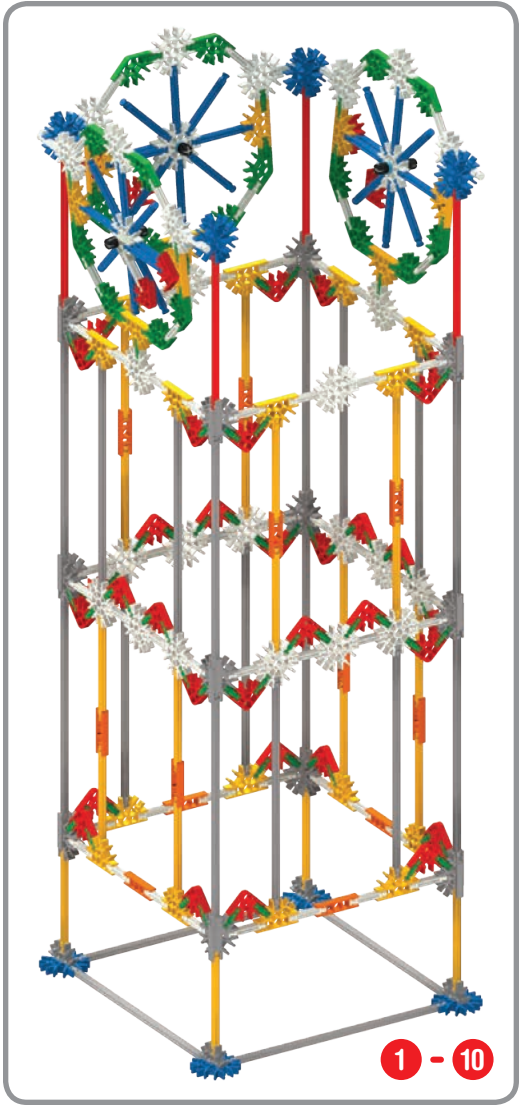
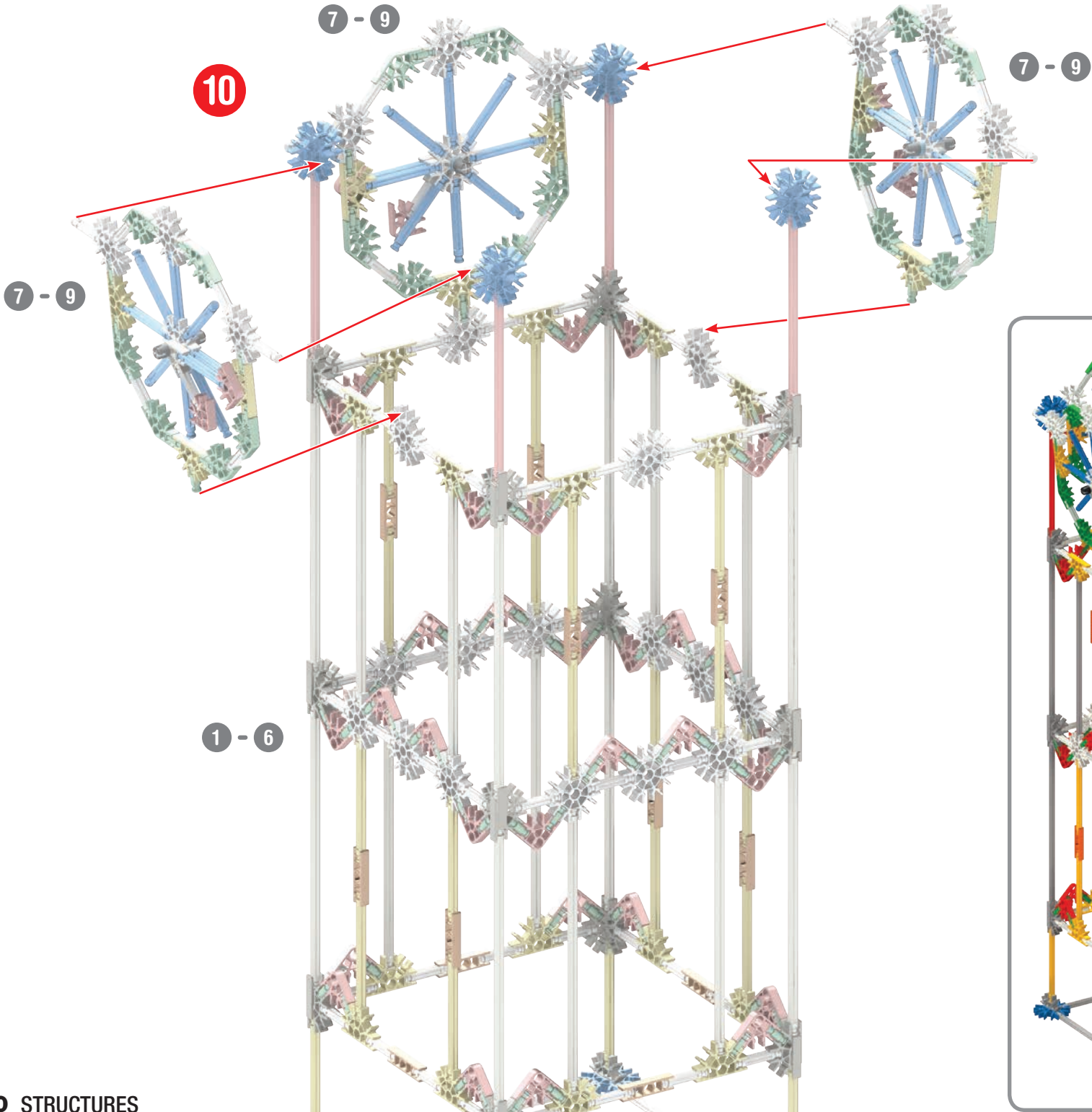

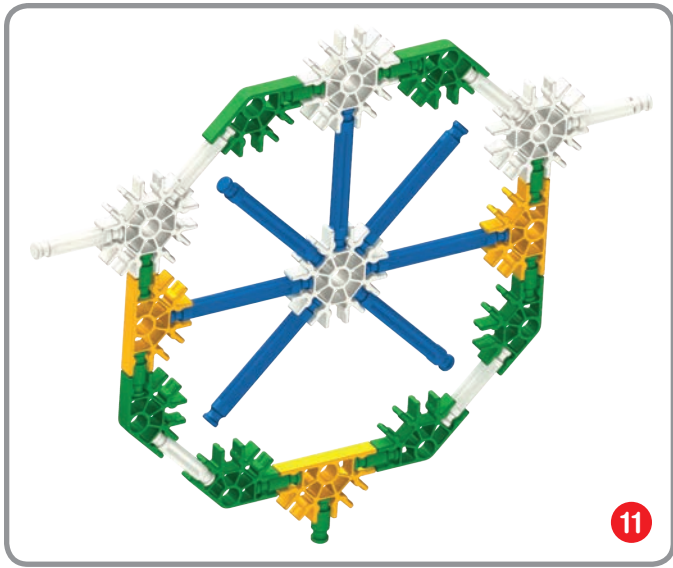

11

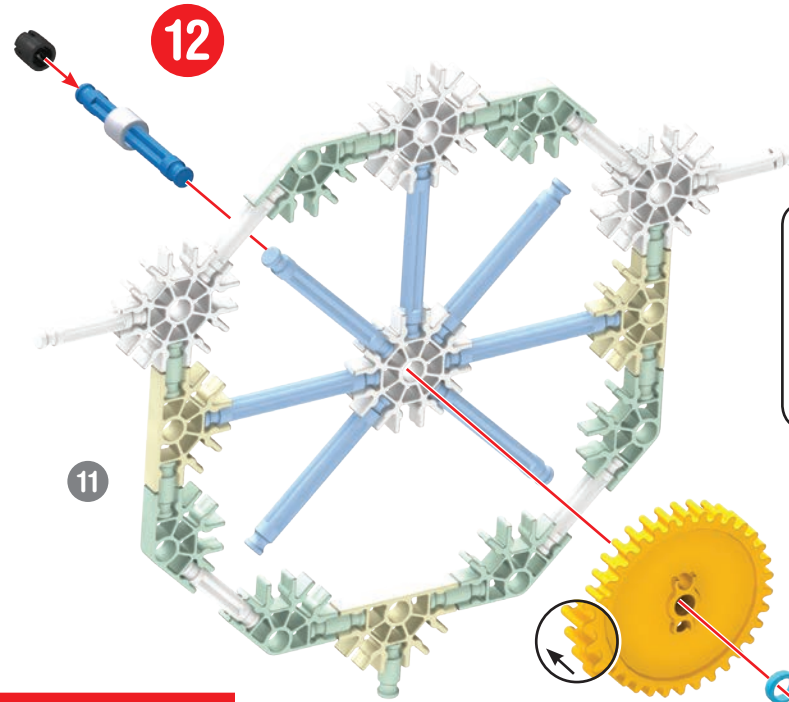

12

11

2		1		
6		1		
1		1		
2				
2				

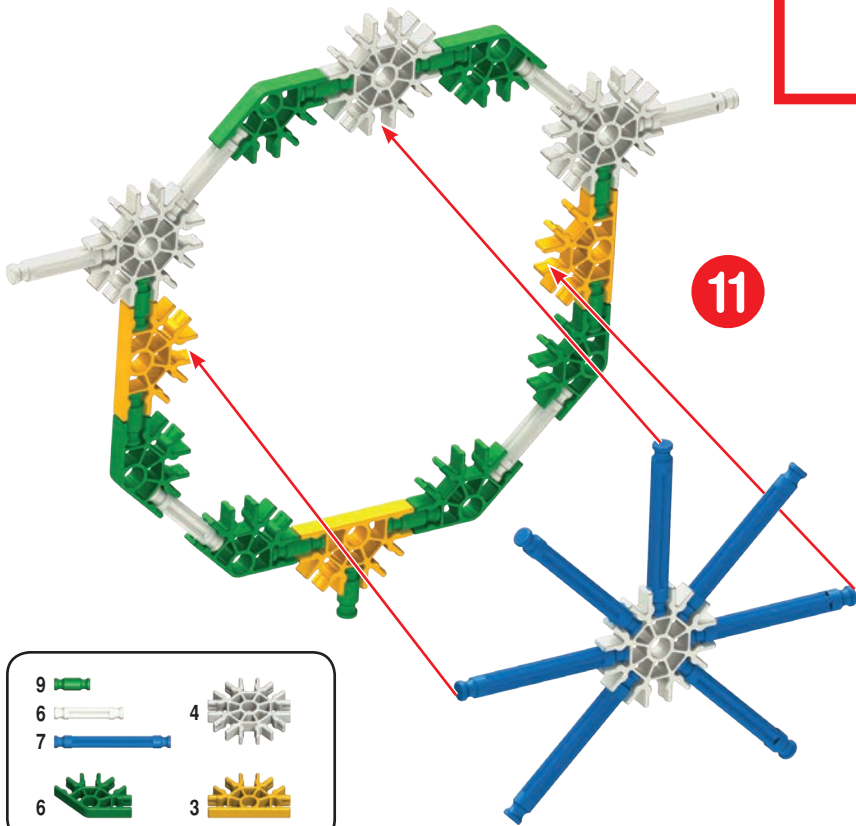

11

9		4	
6			
7			
6		3	

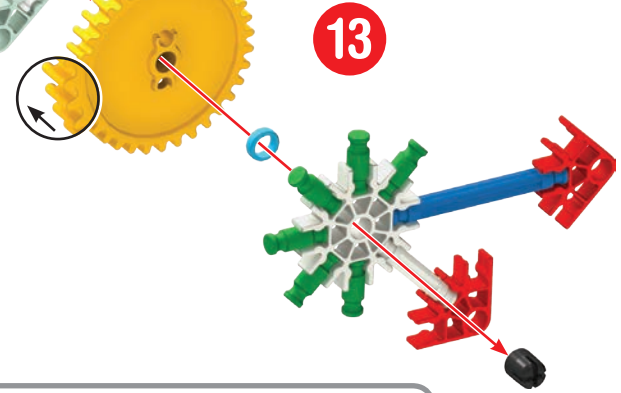

13



11 - 13

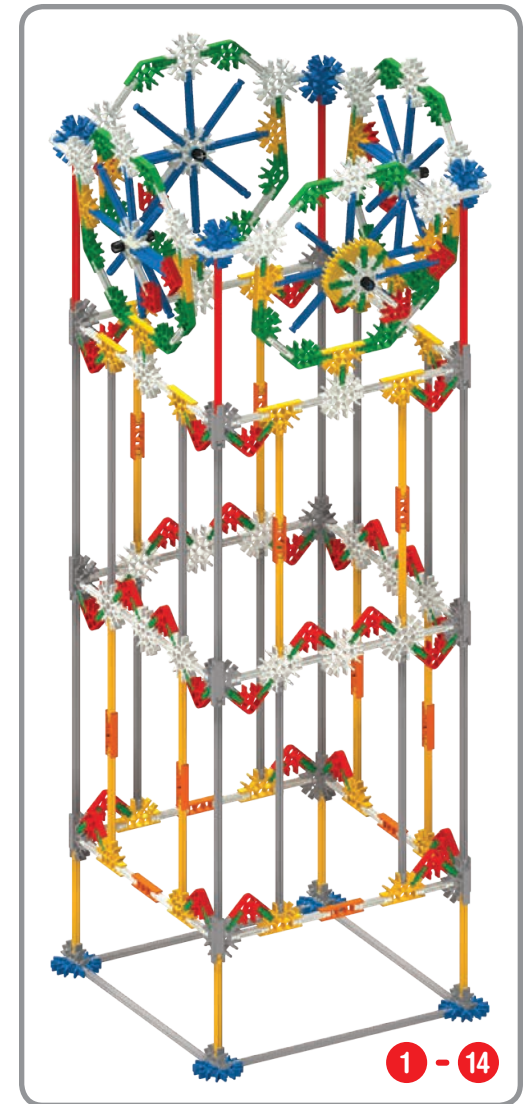
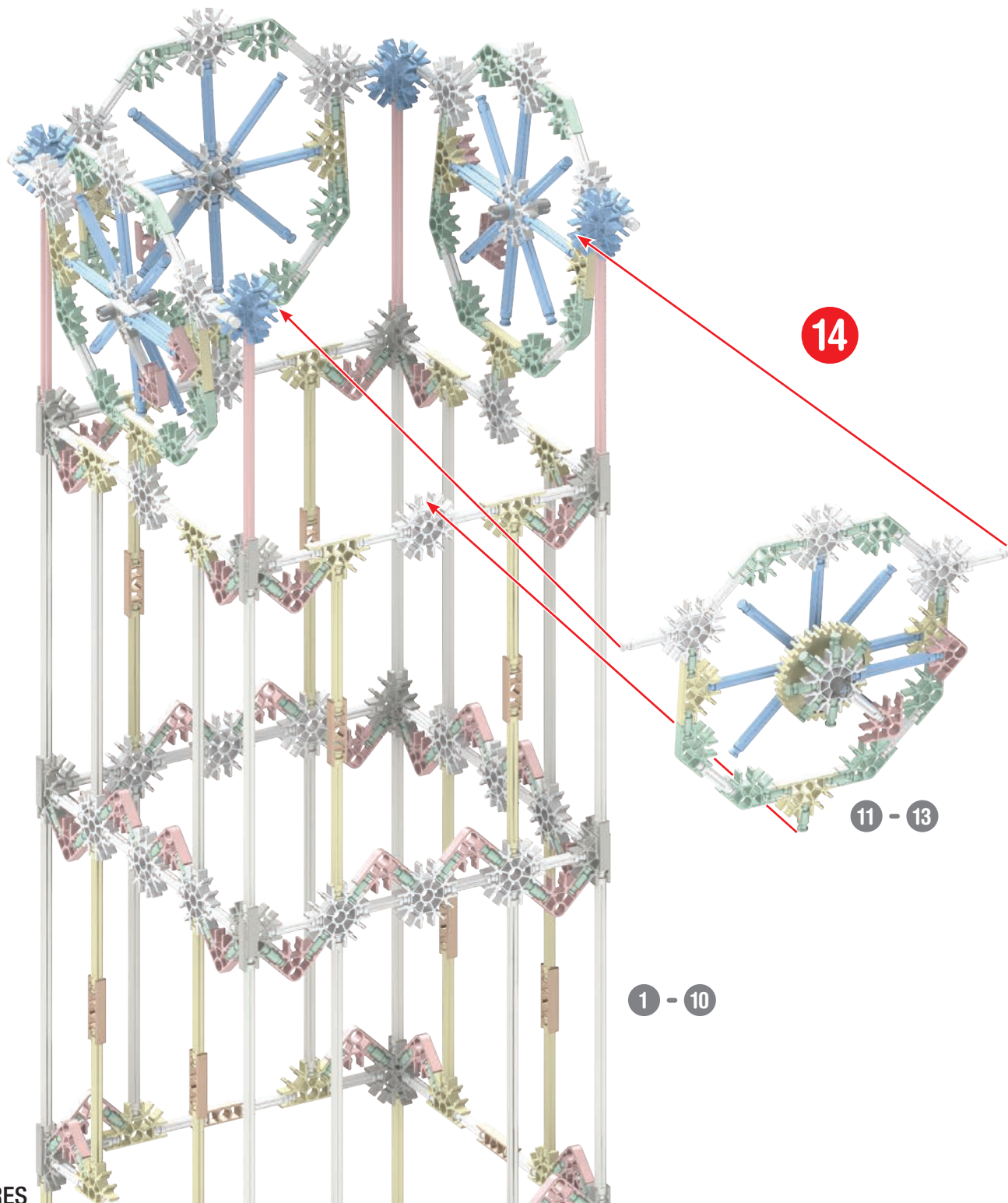

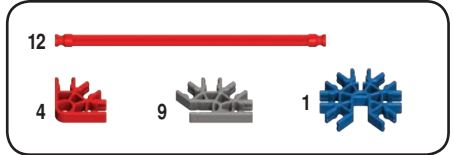
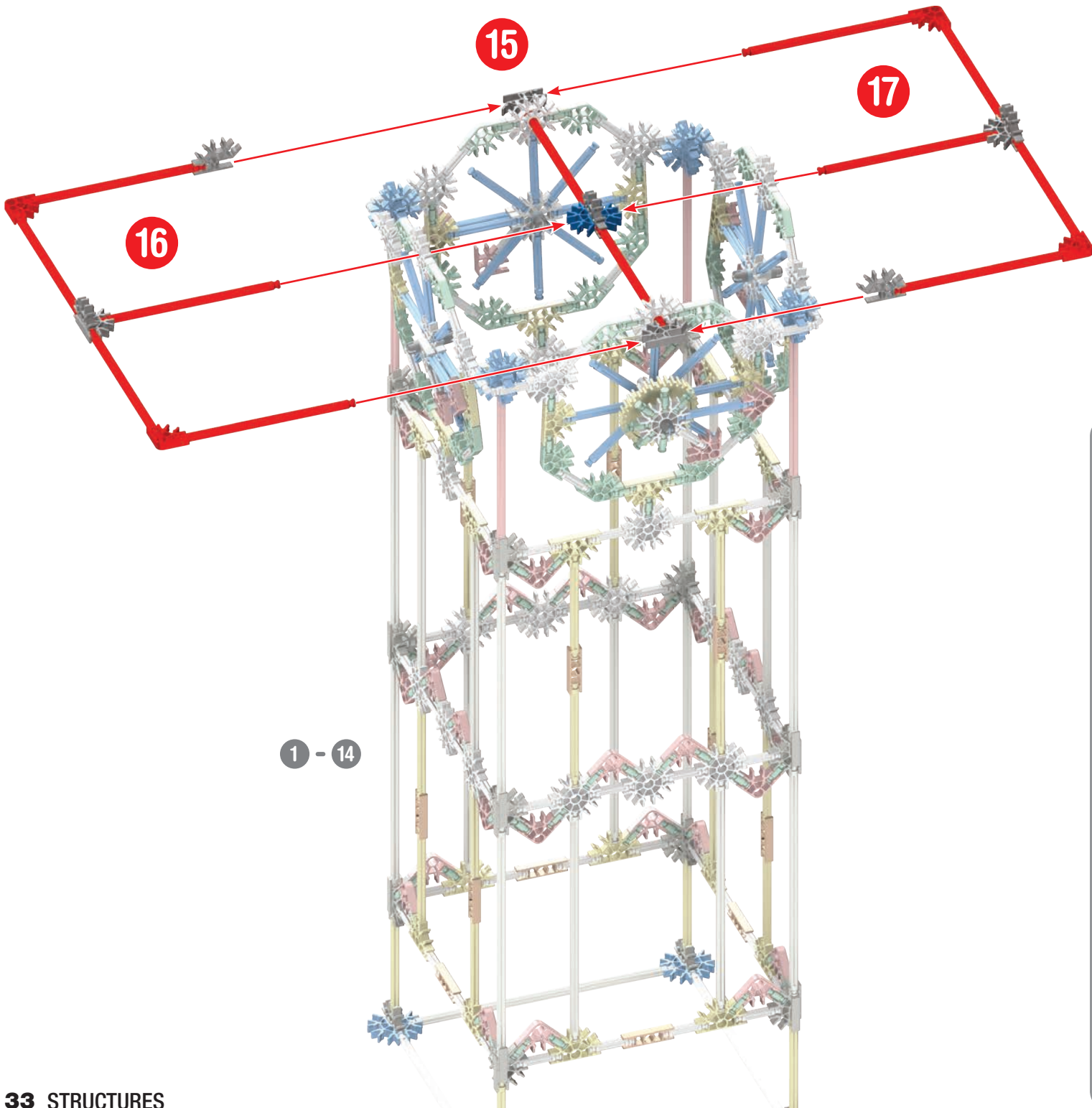

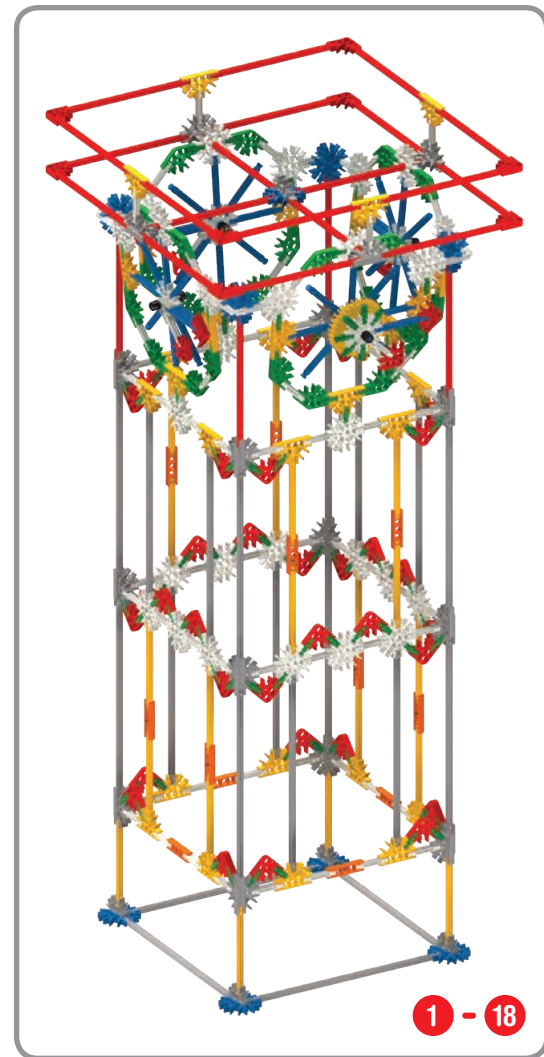
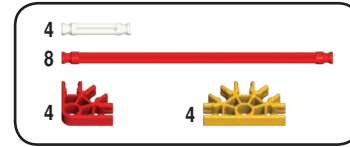
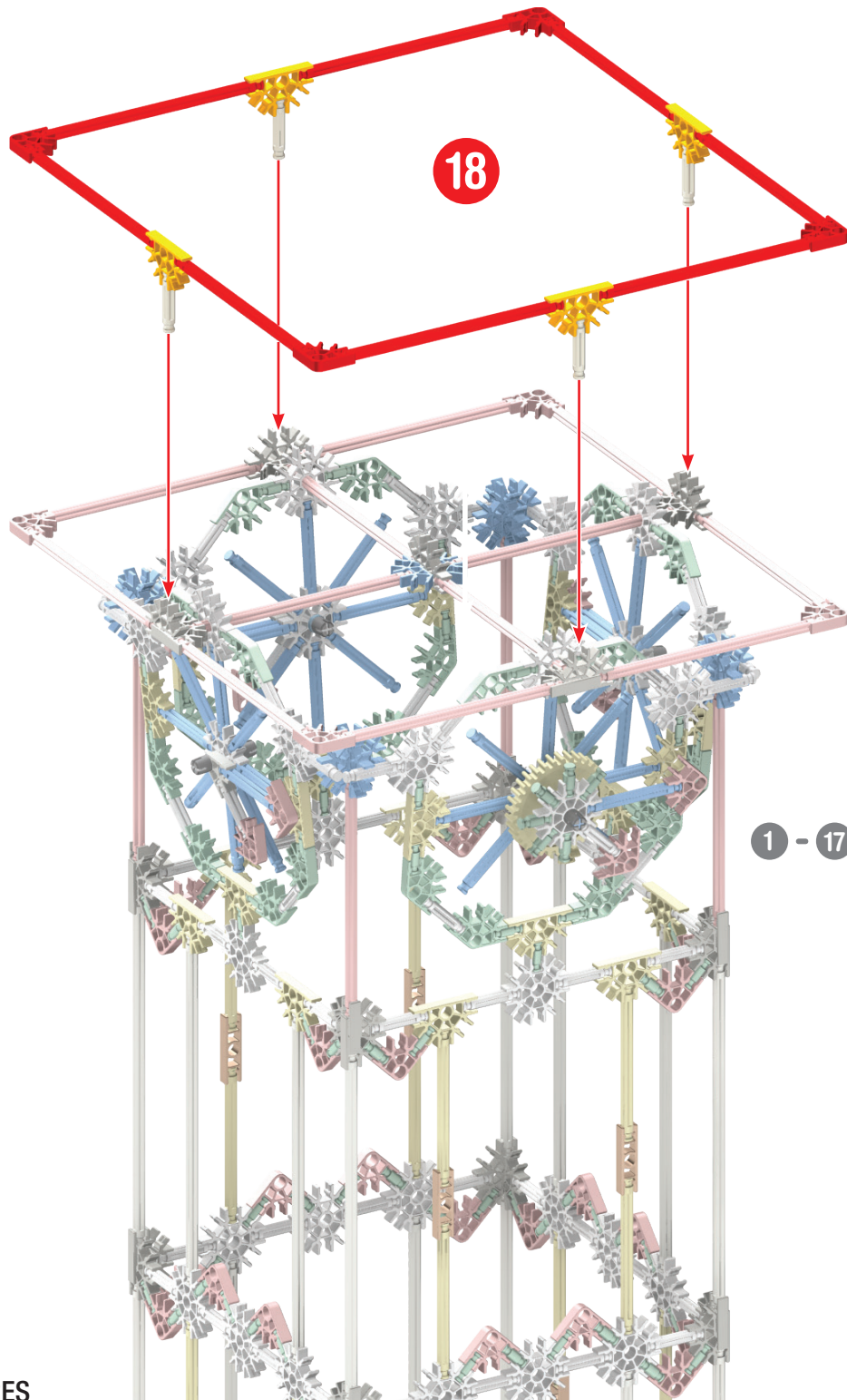

Clock Tower



1 - 20

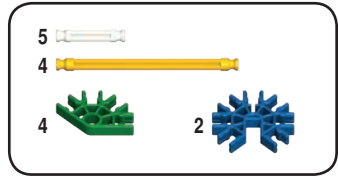

20

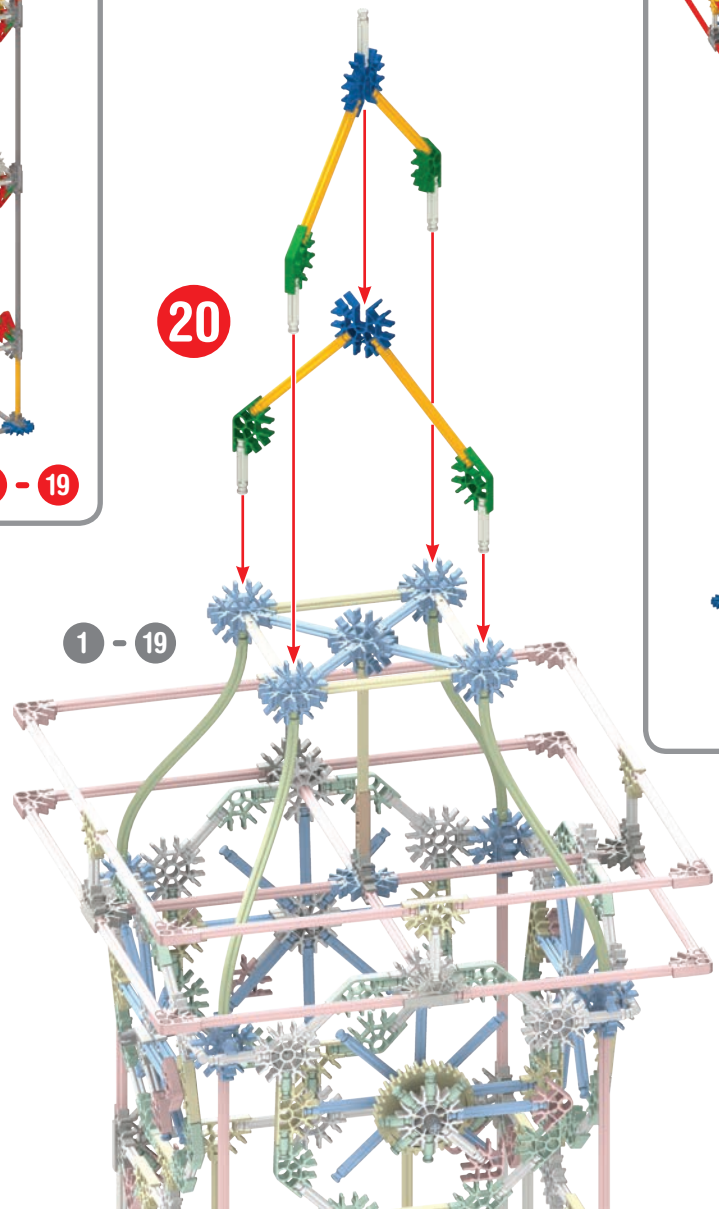

1 - 19



1 - 19

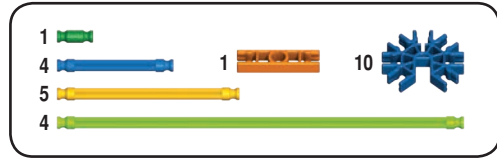

19

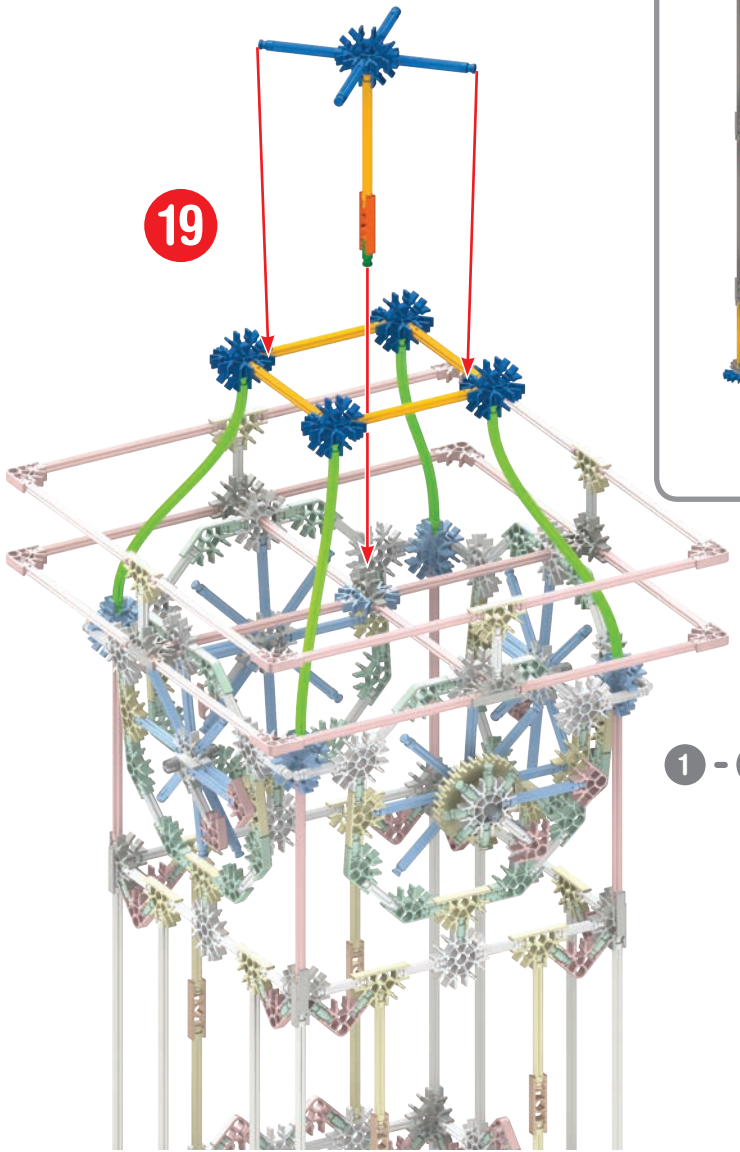

1 - 18

House

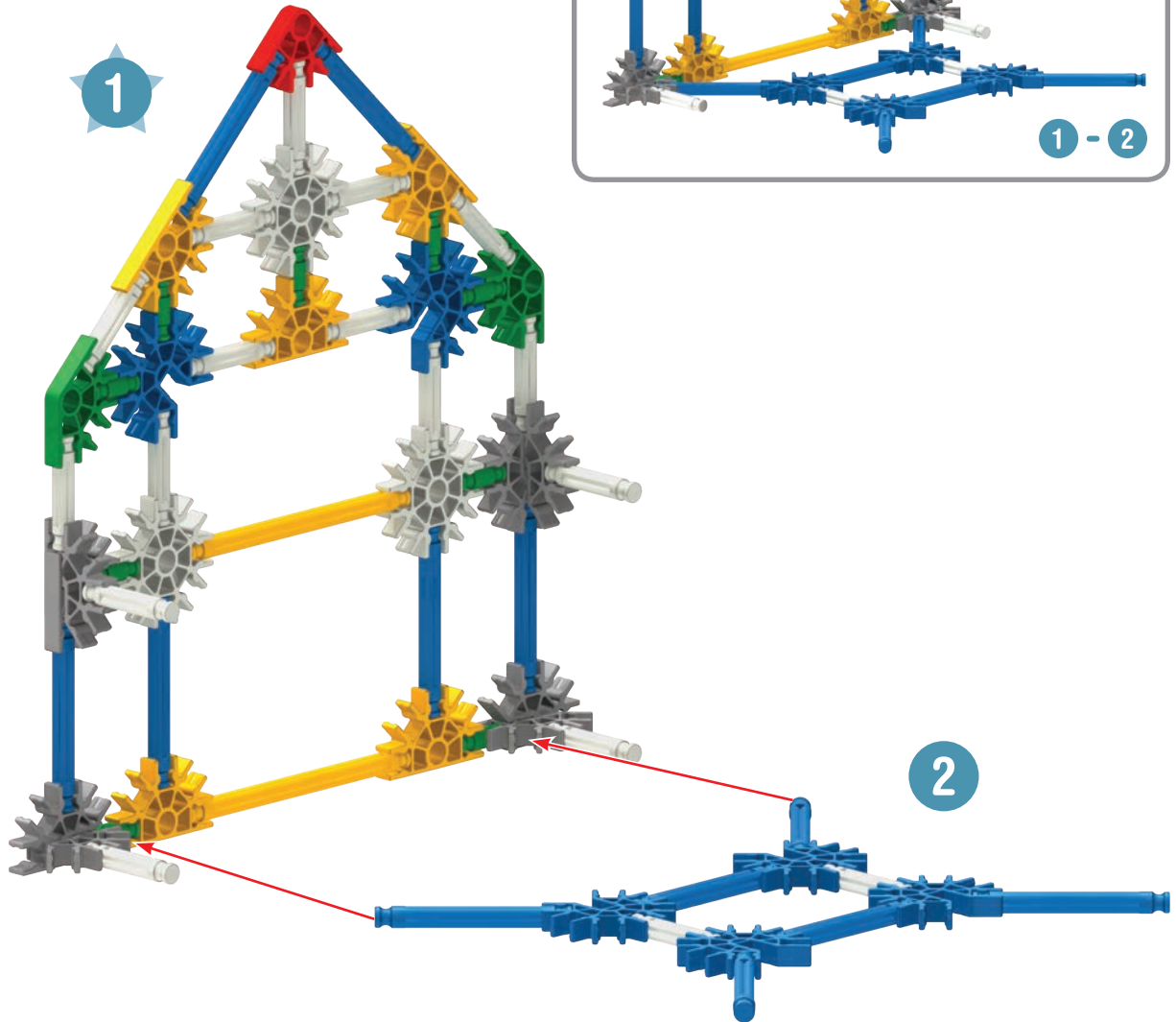
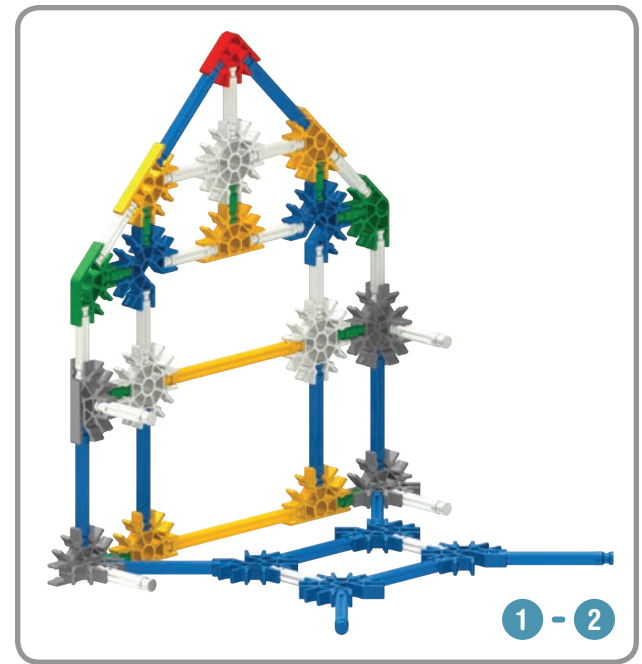
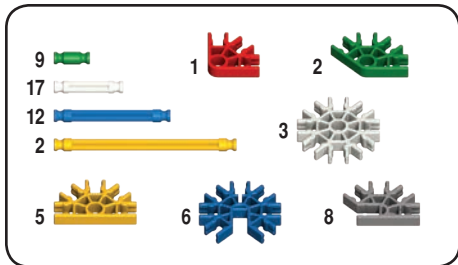
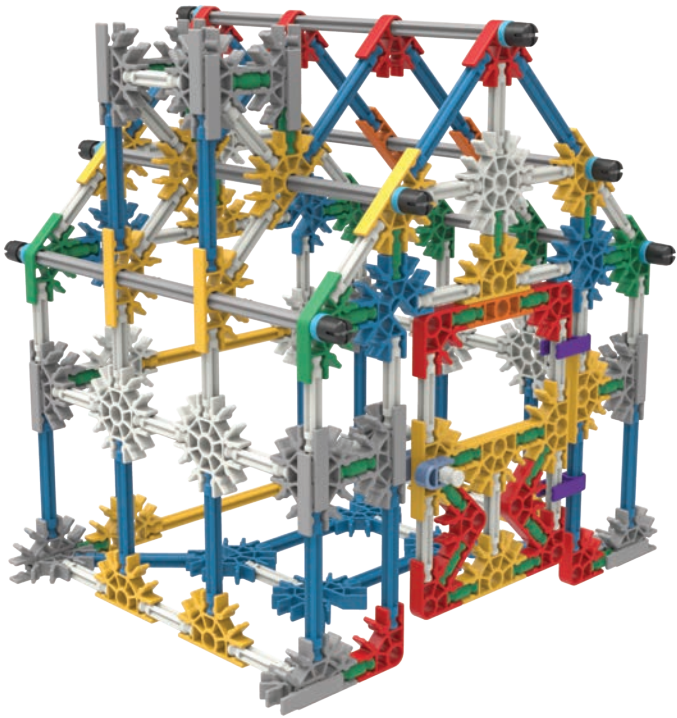

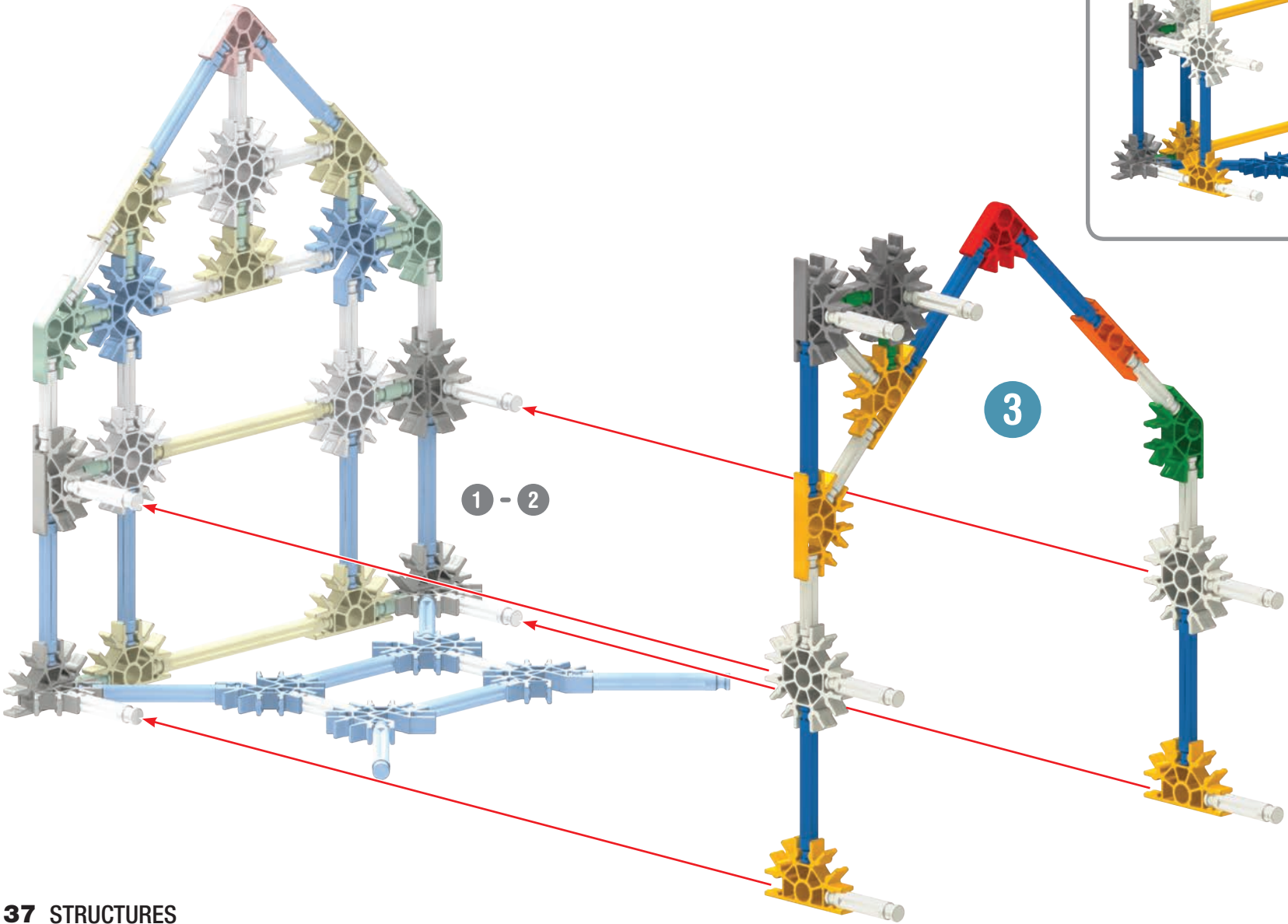
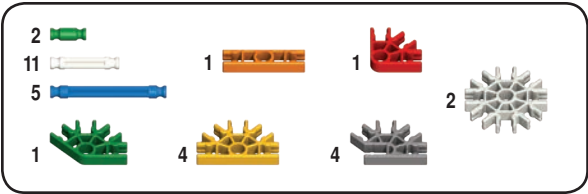

2		1		1		
9						2
5						
1		4		4		

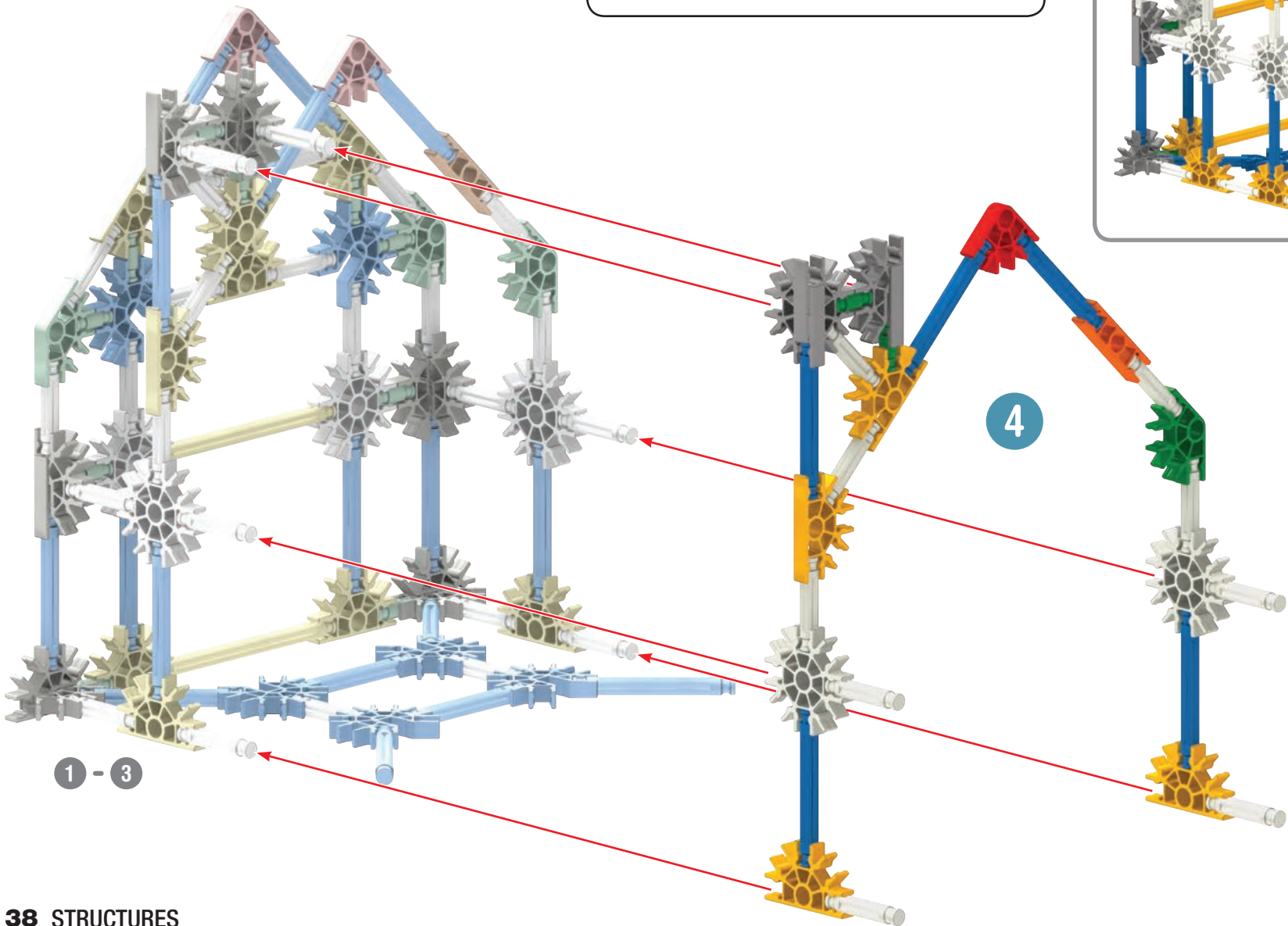

1 - 3

4

1 - 4

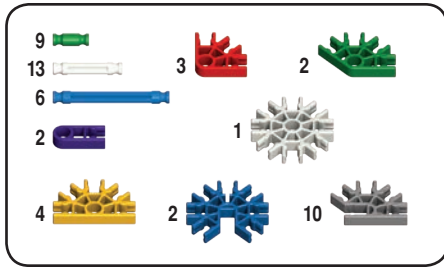

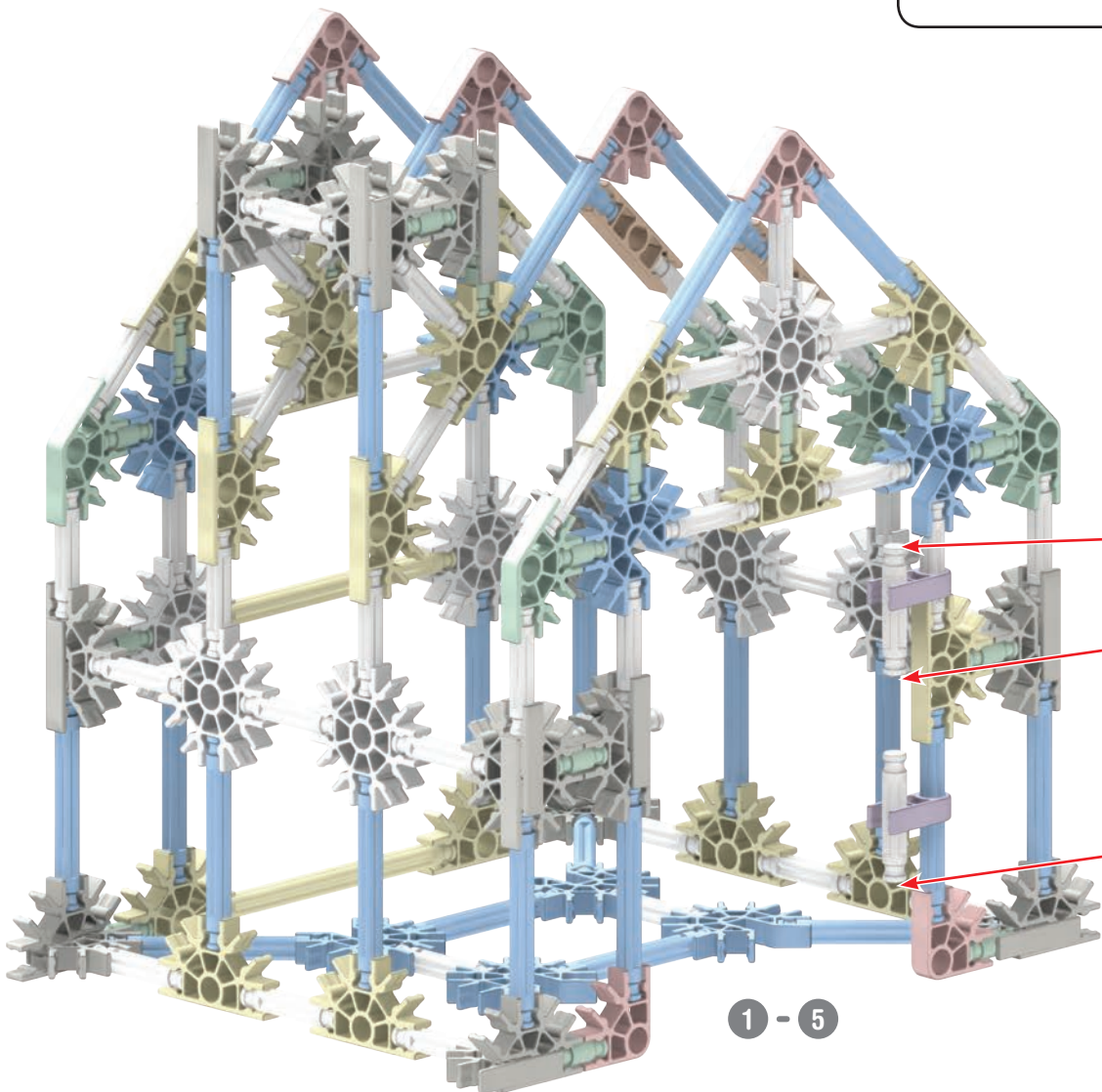

- | | | | |
|----|--|---|--|
| 10 | | 1 | |
| 4 | | | |
| 2 | | 6 | |
| | | 4 | |



6

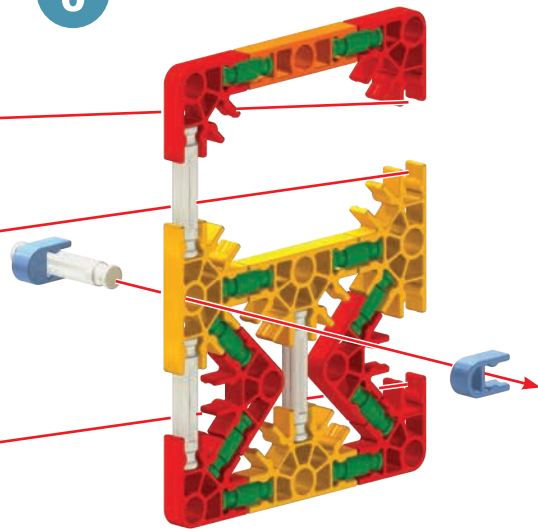

1 - 5

1 - 6

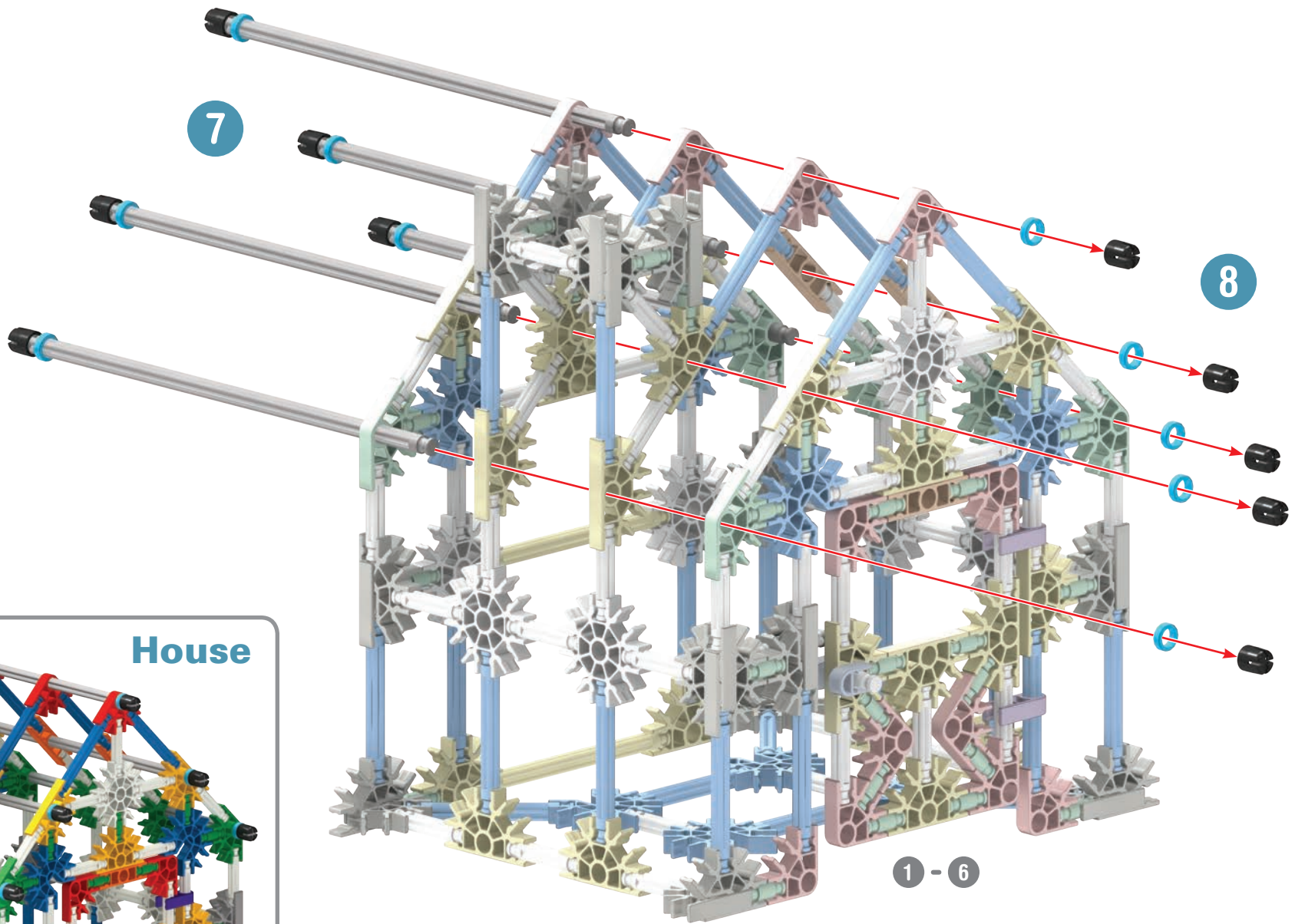
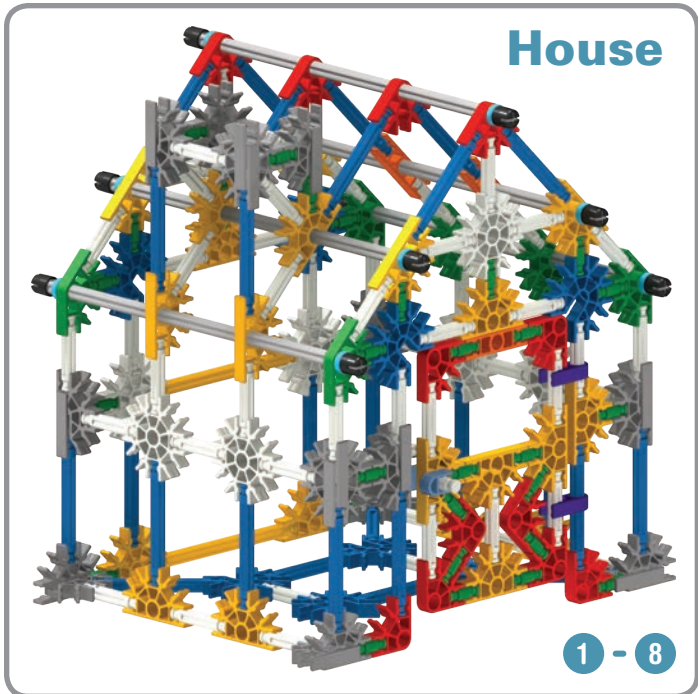

Igloo

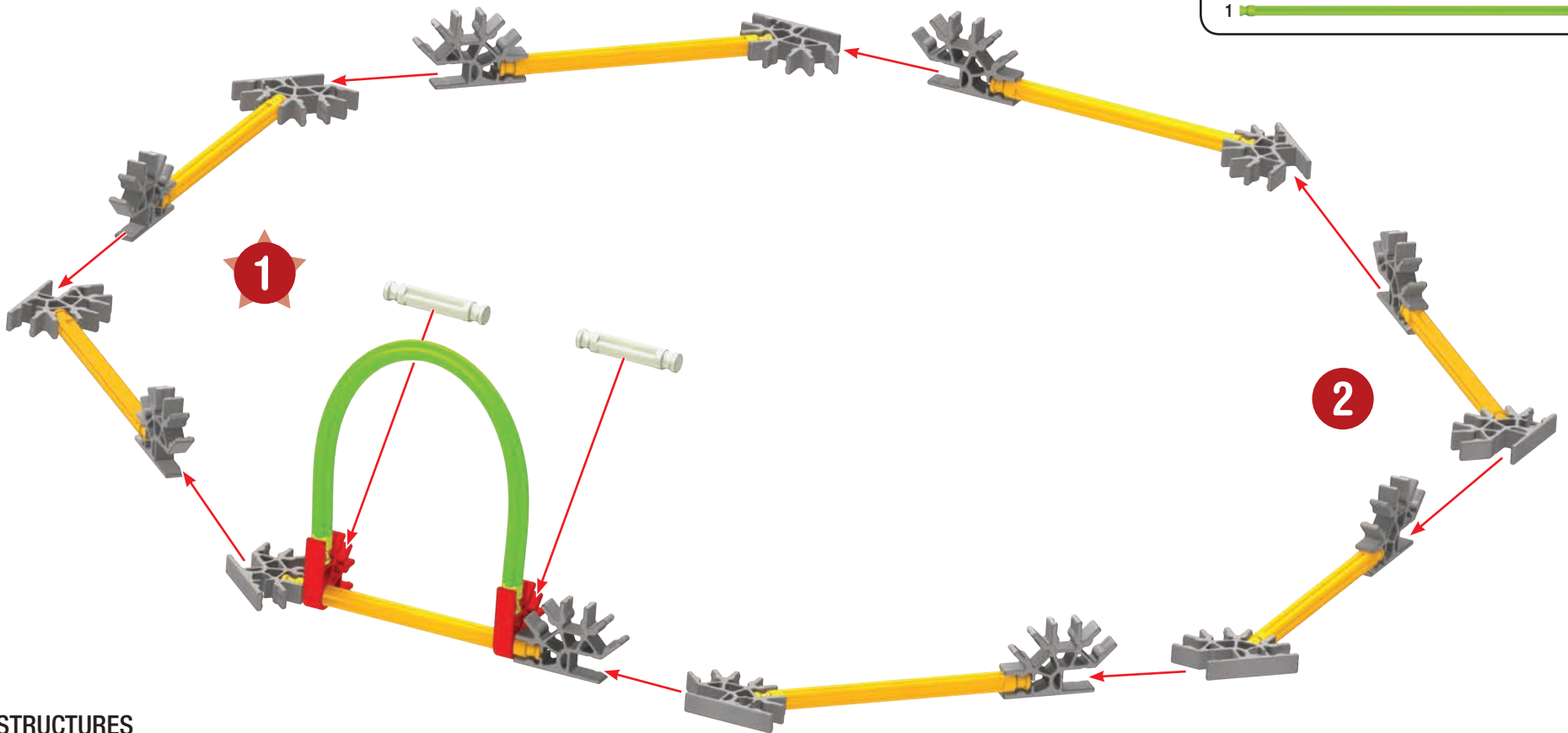
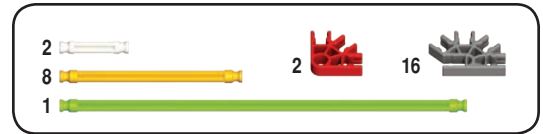
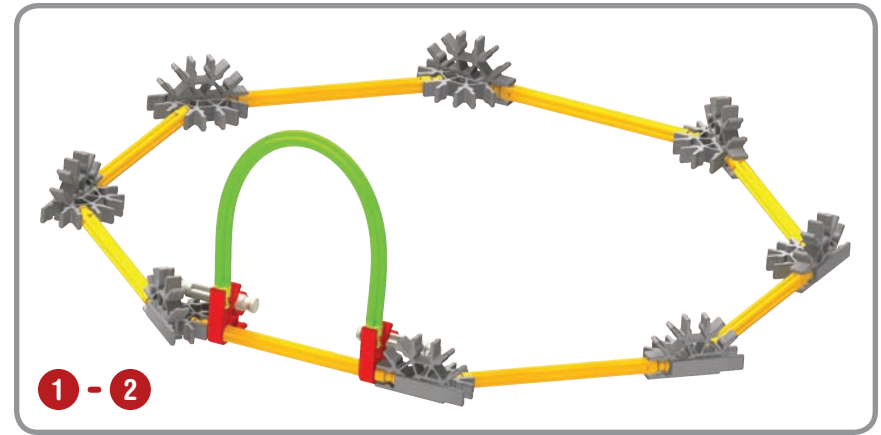
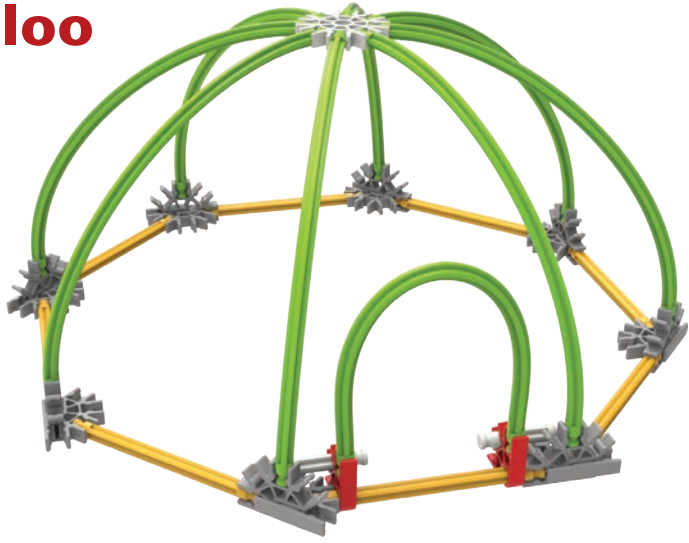

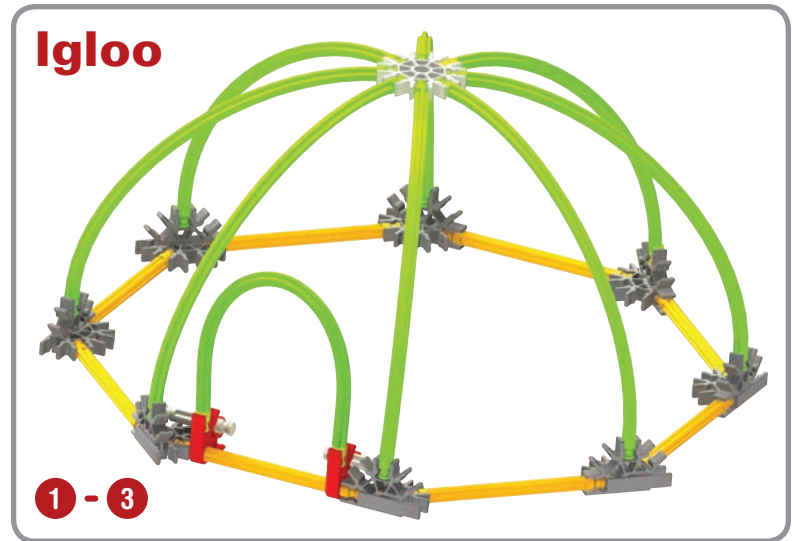
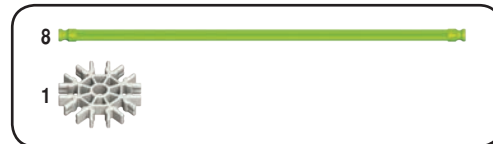
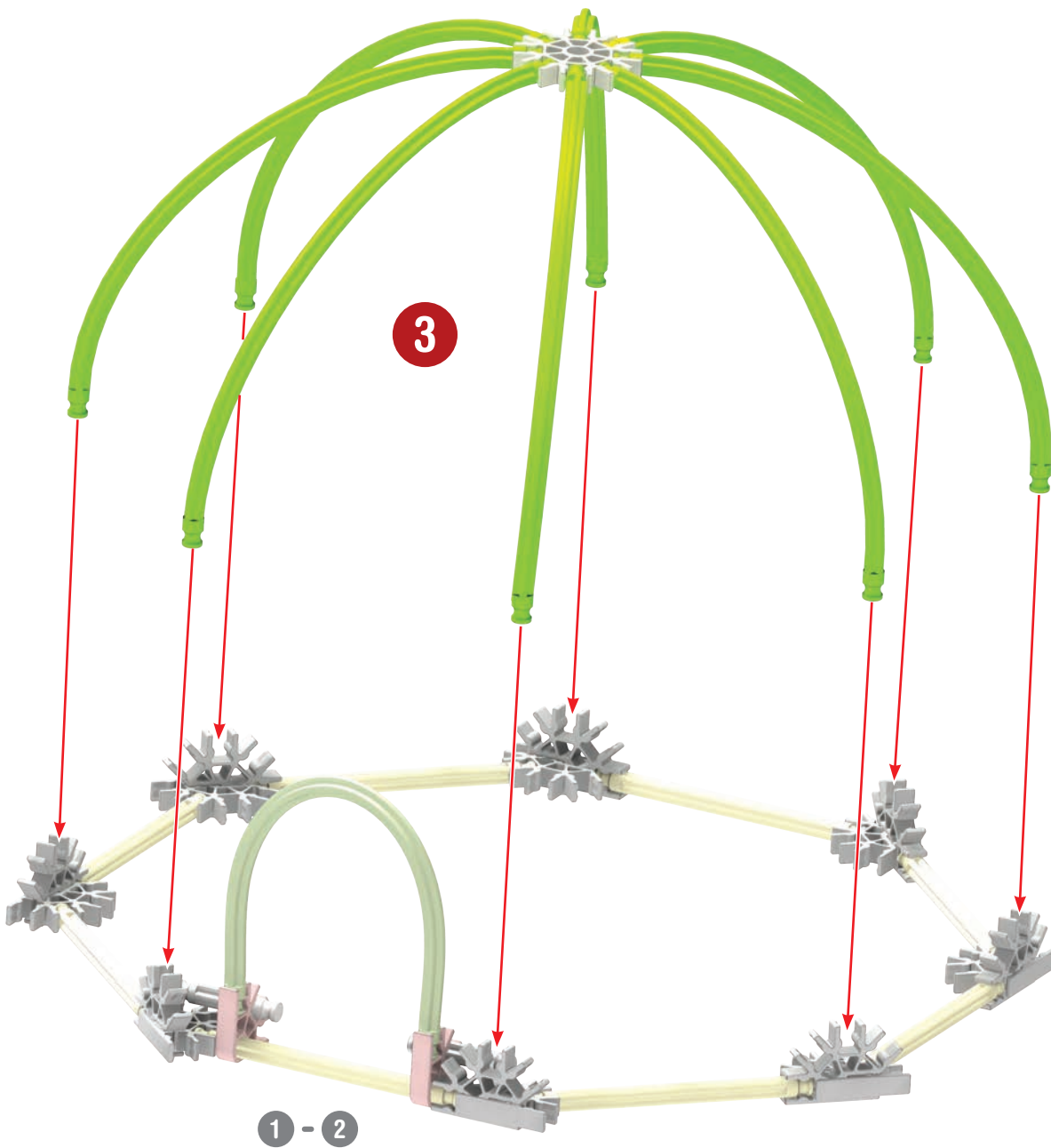

Leaning Tower

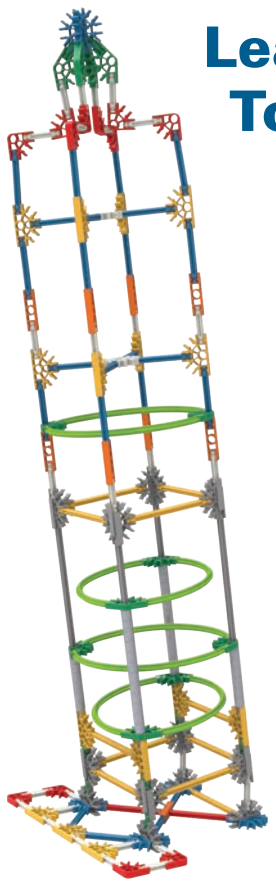

1 - 2

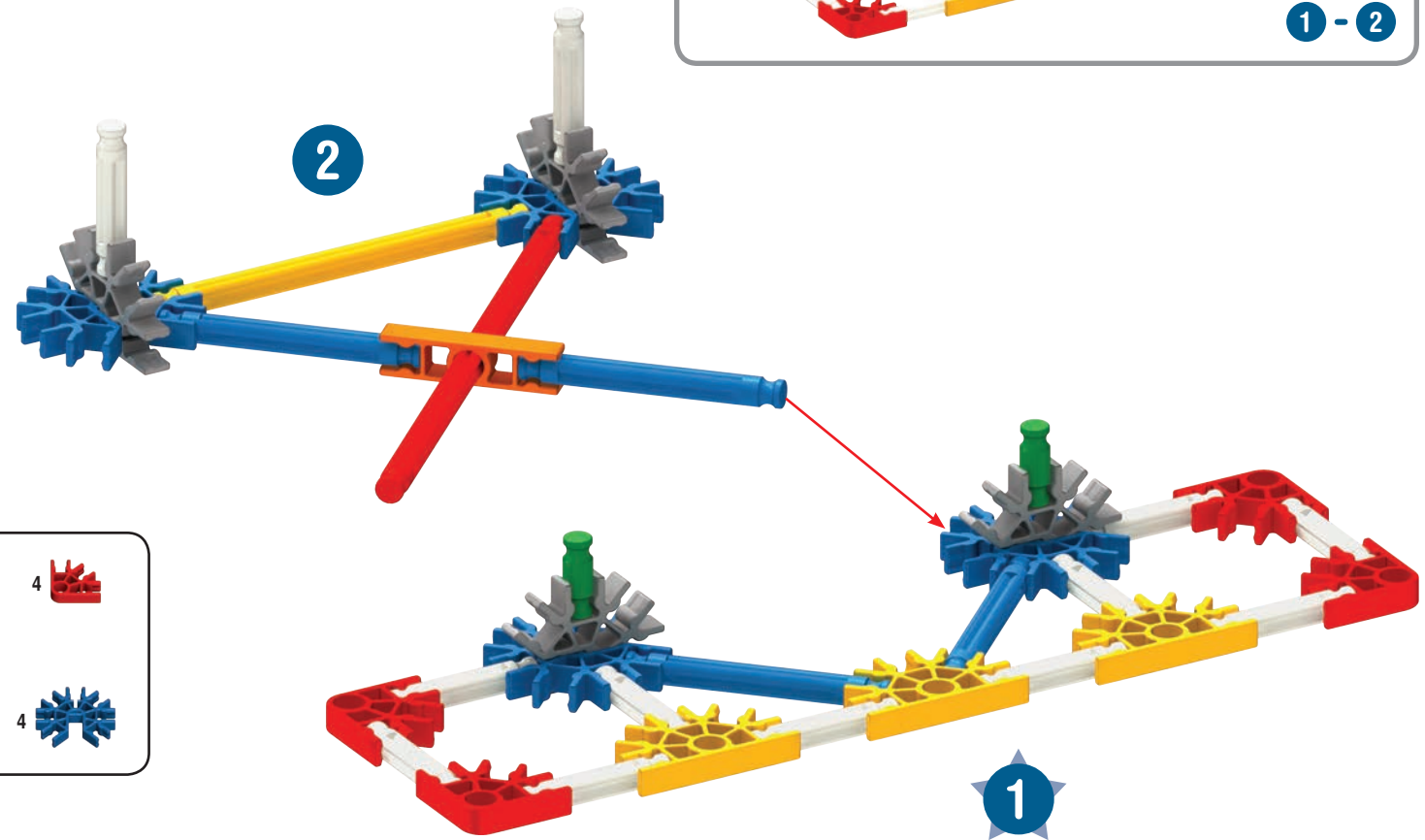

- | | | | | | |
|----|--|---|--|---|--|
| 2 | | 1 | | 4 | |
| 12 | | | | | |
| 4 | | | | | |
| 1 | | | | | |
| 1 | | | | | |
| 3 | | 4 | | 4 | |

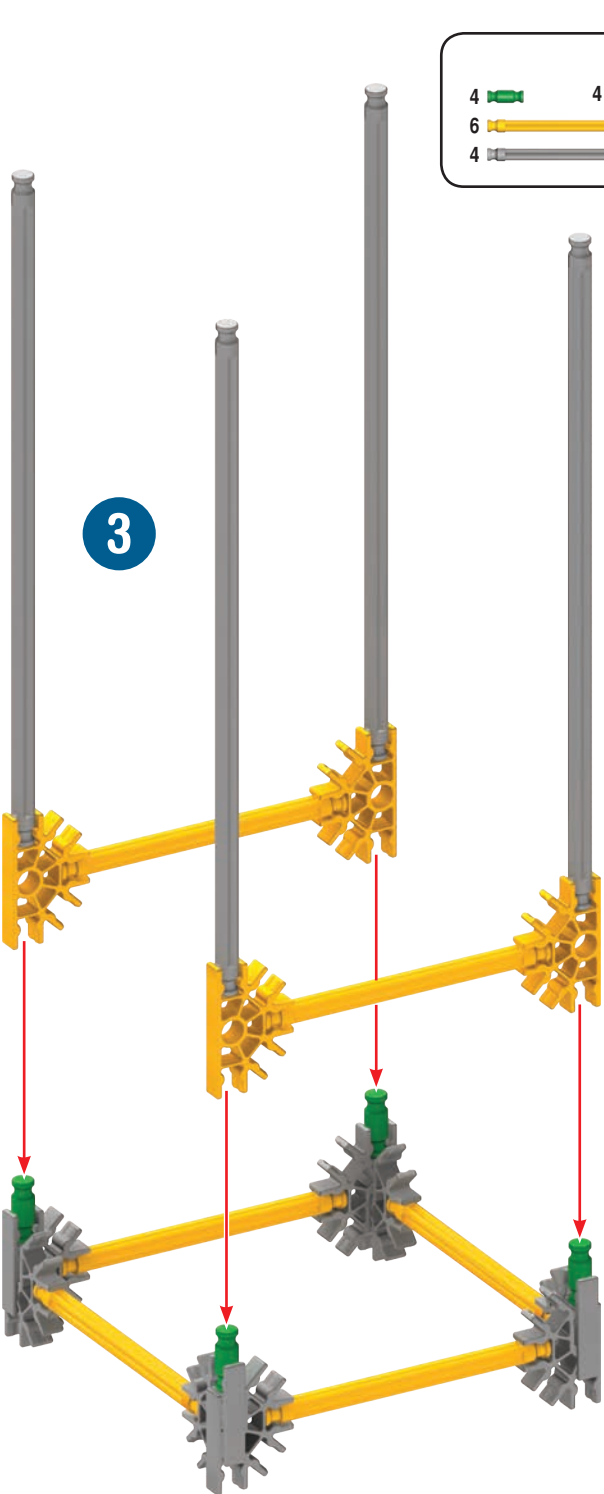

3

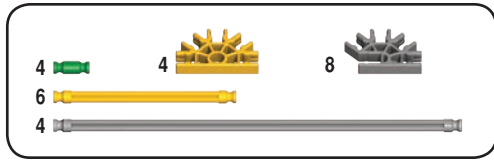

x3

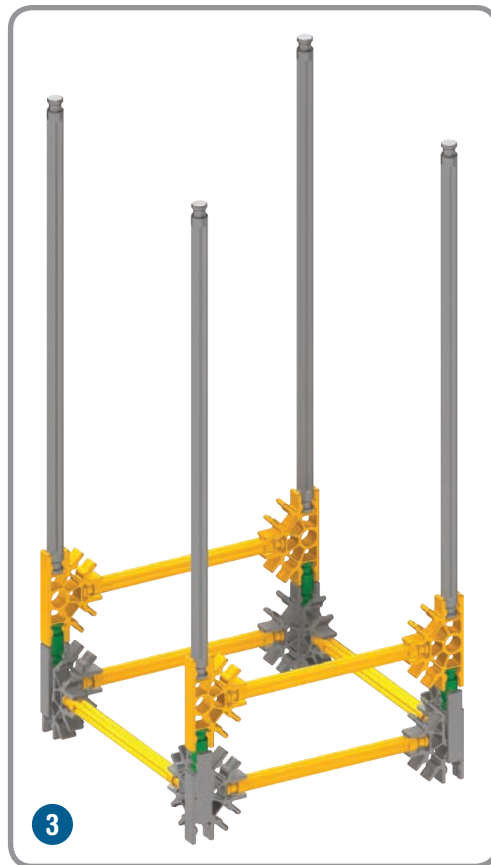

3

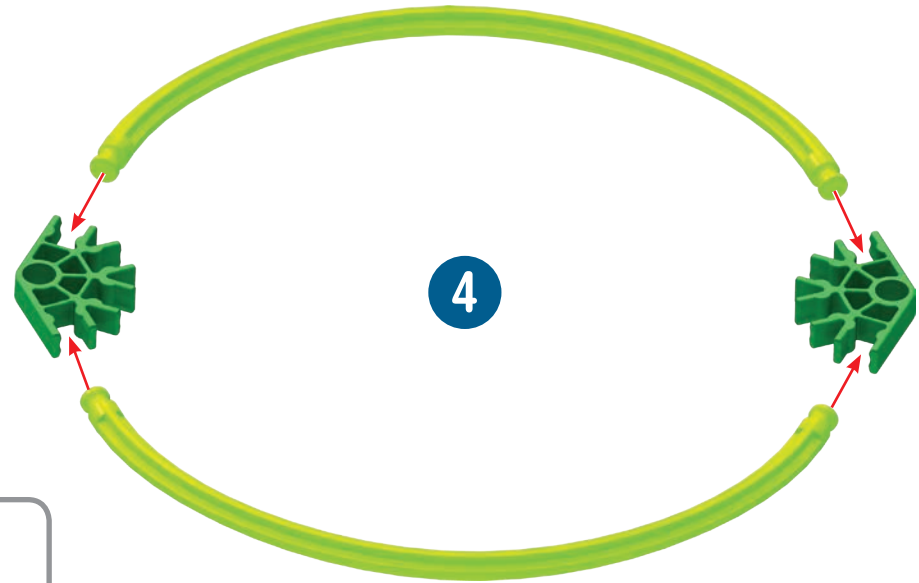

4

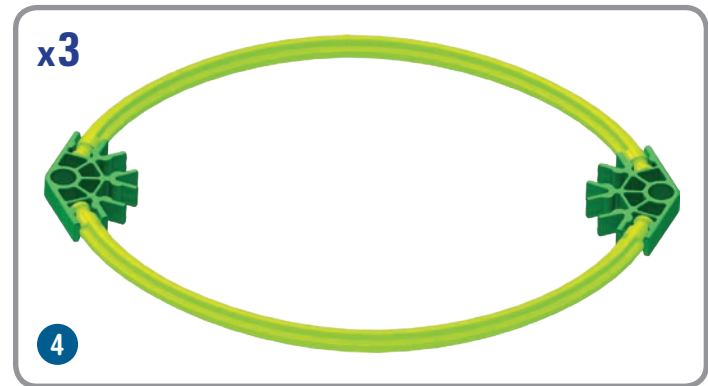

x3

4

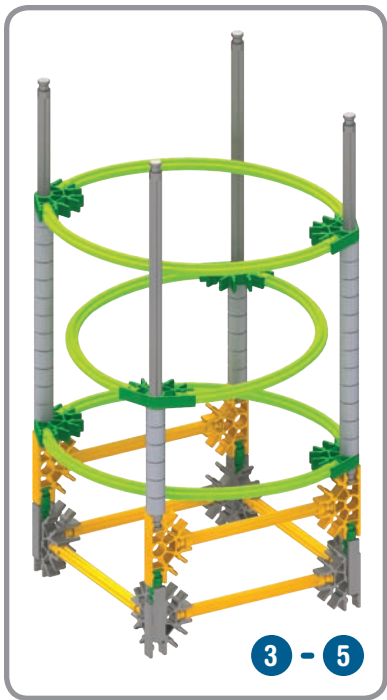

36

5

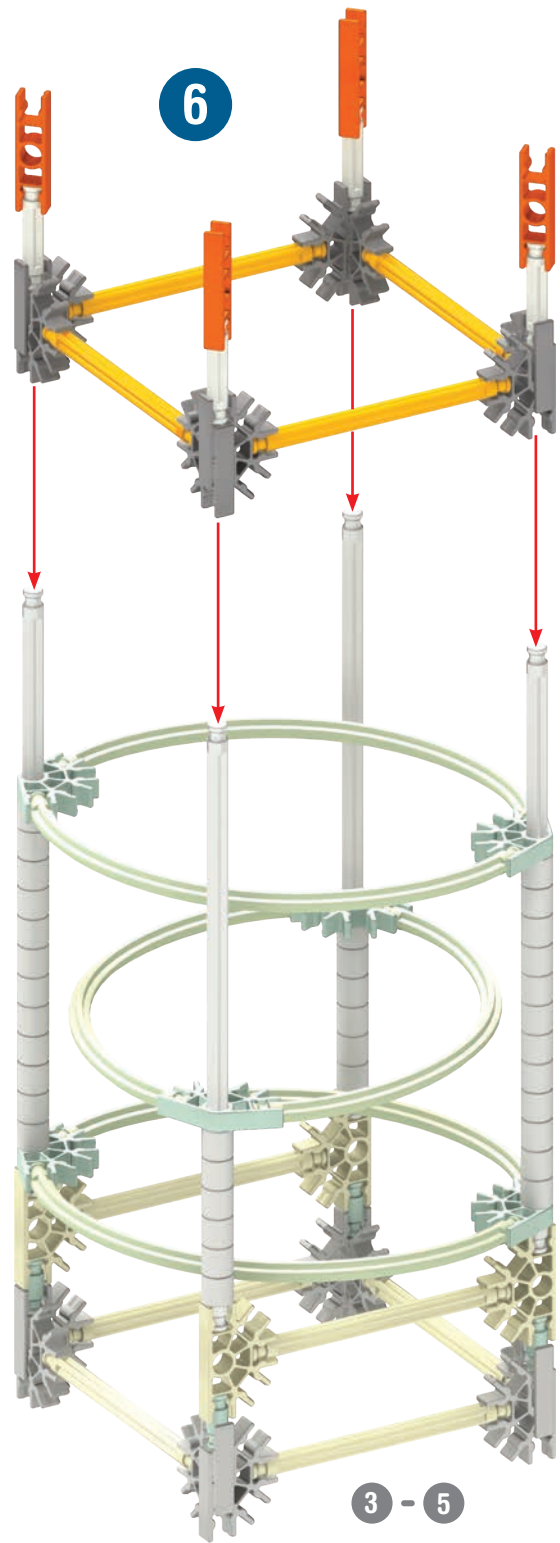
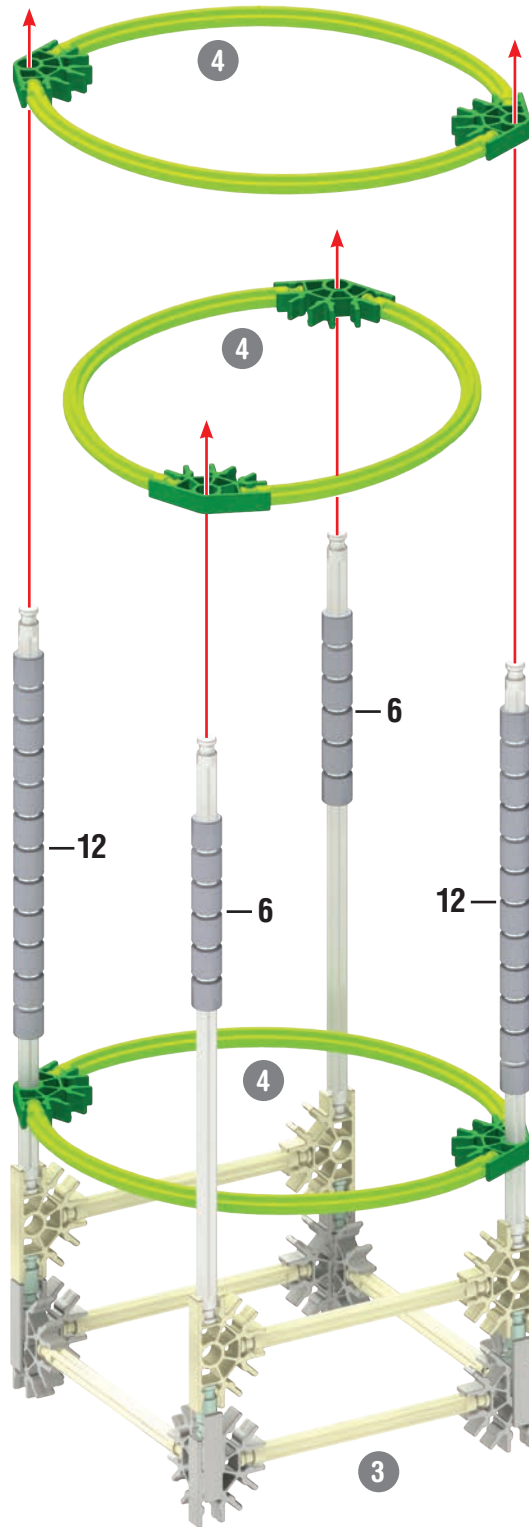

- 4
- 4
- 4
- 8

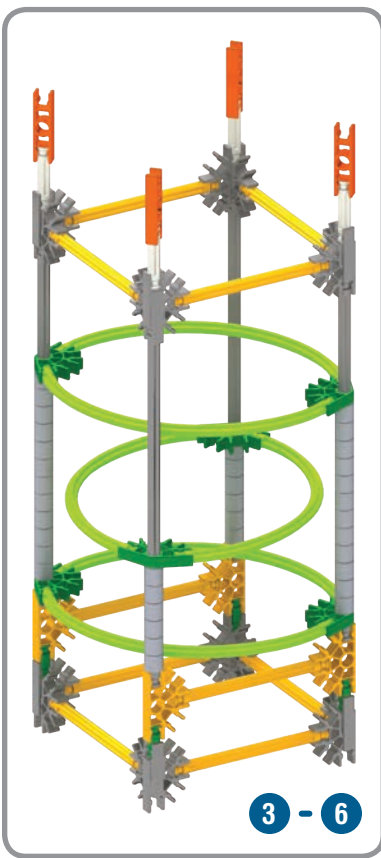

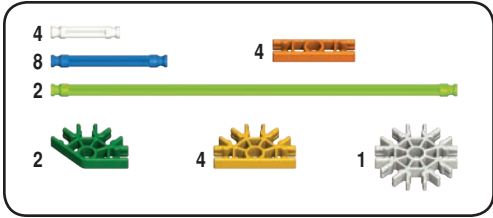

7

3 - 6

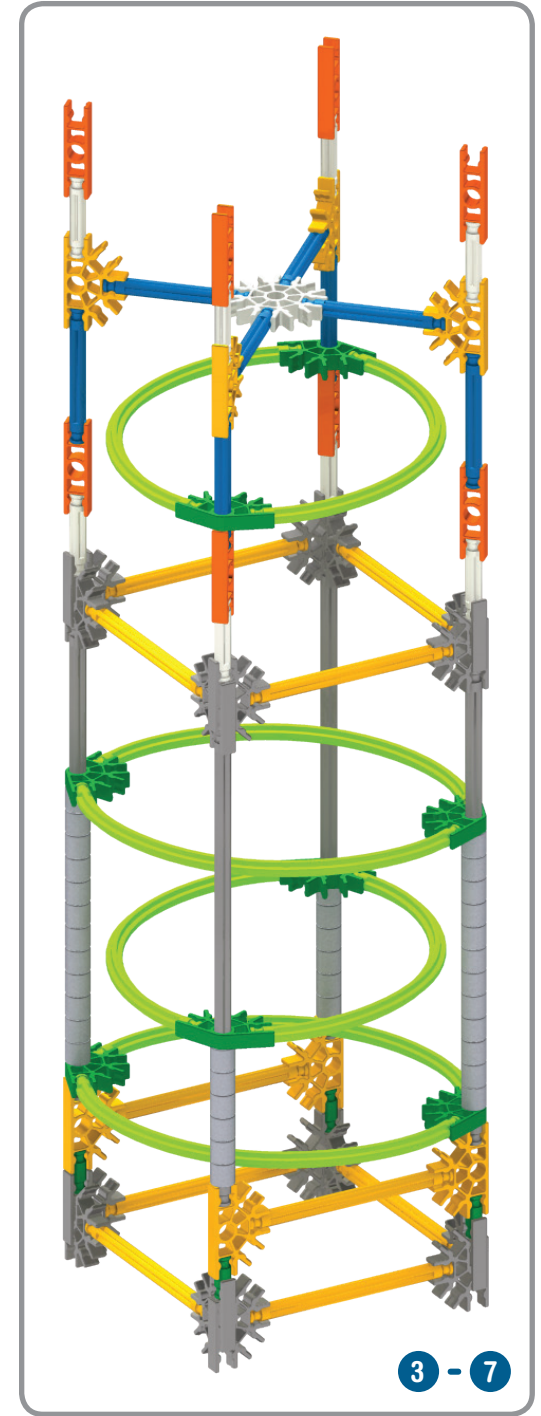
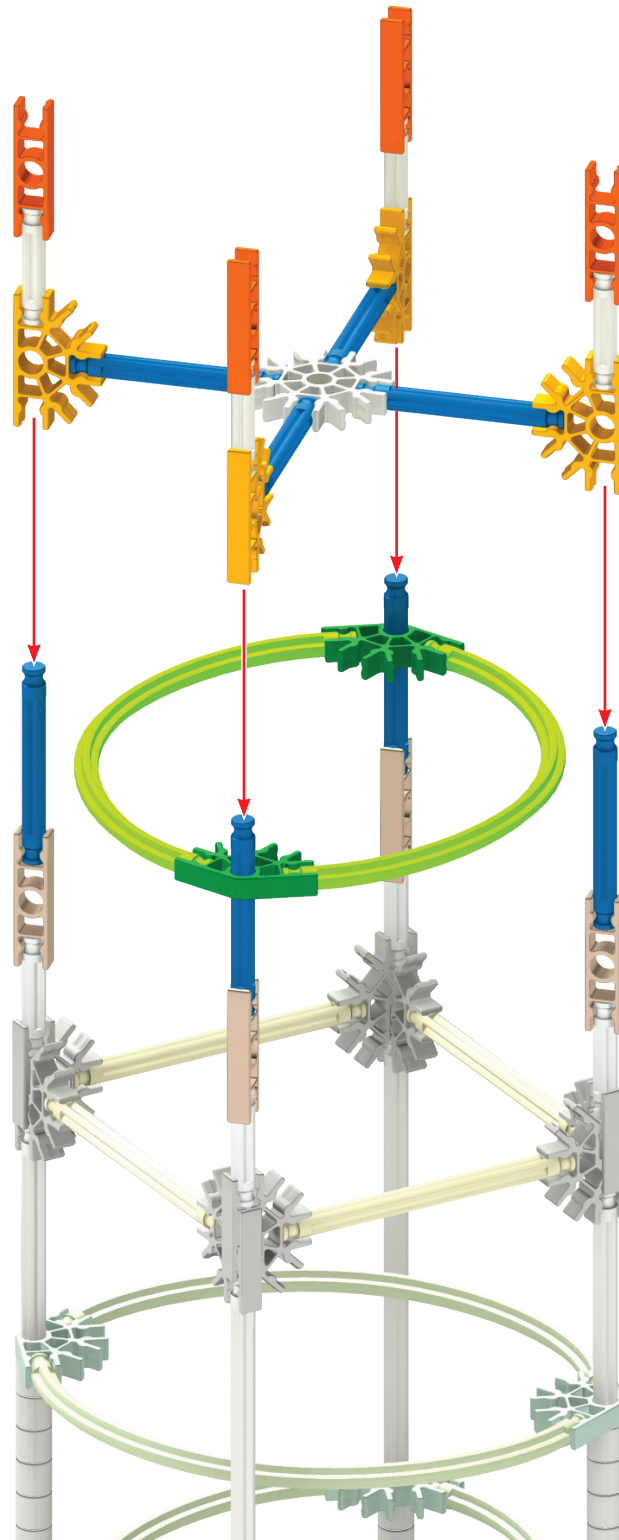

3 - 7

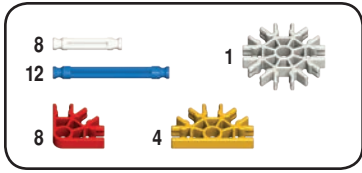

8

3 - 7

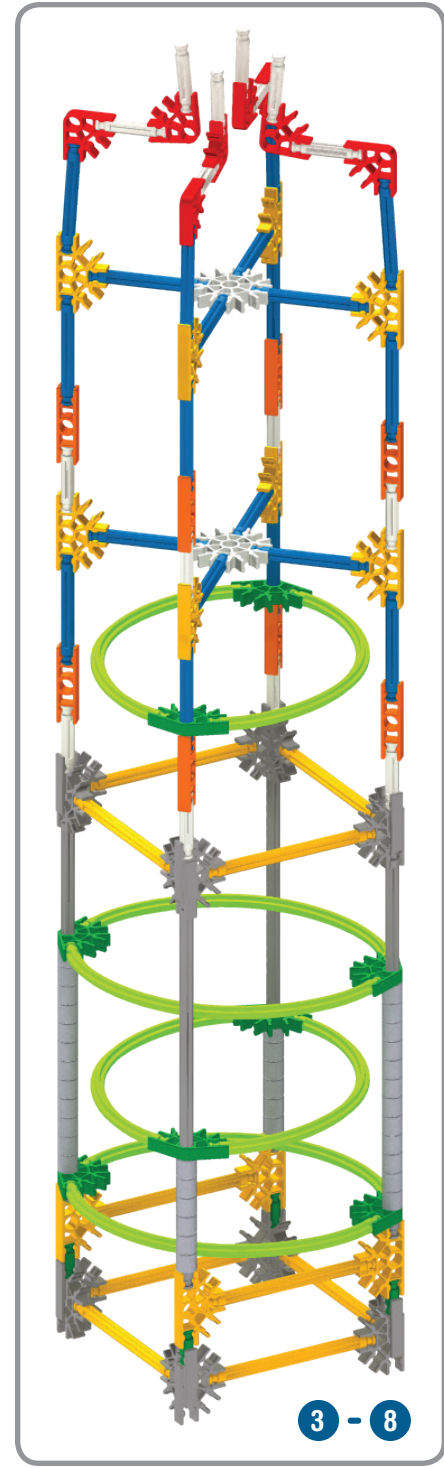
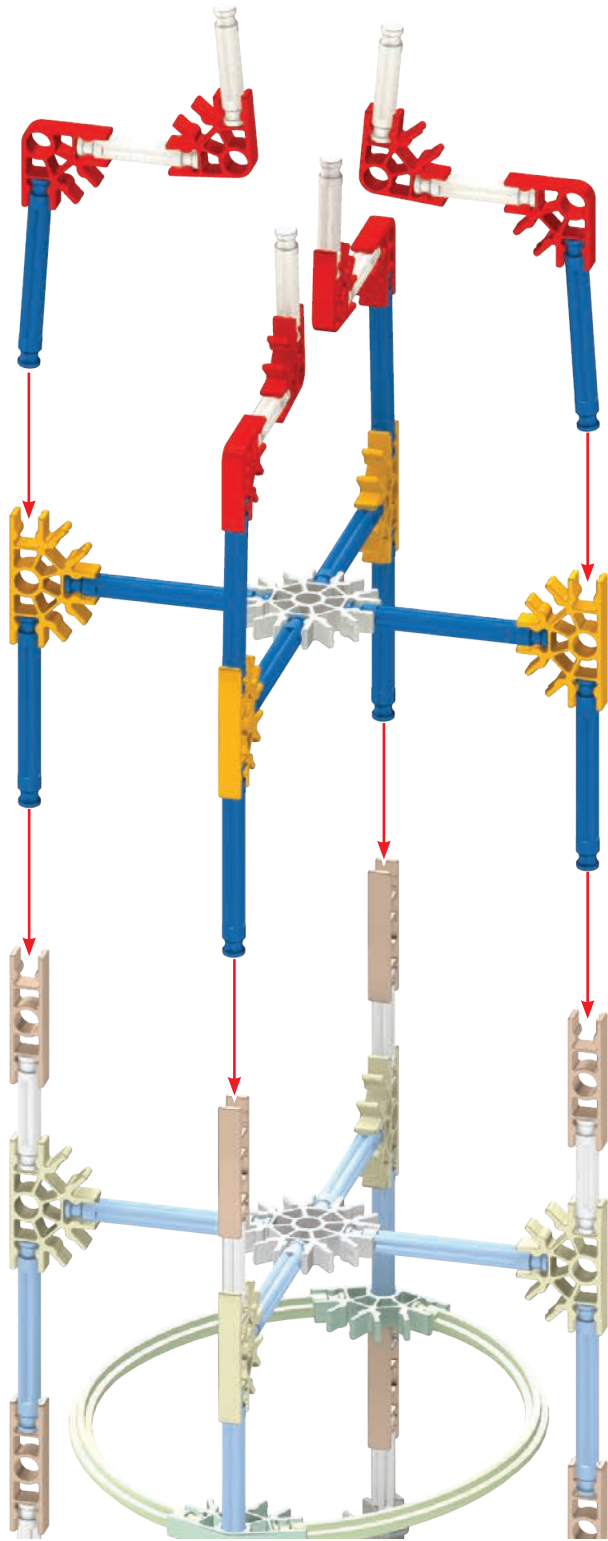

3 - 8

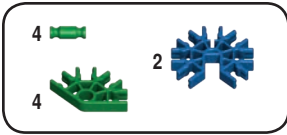

9

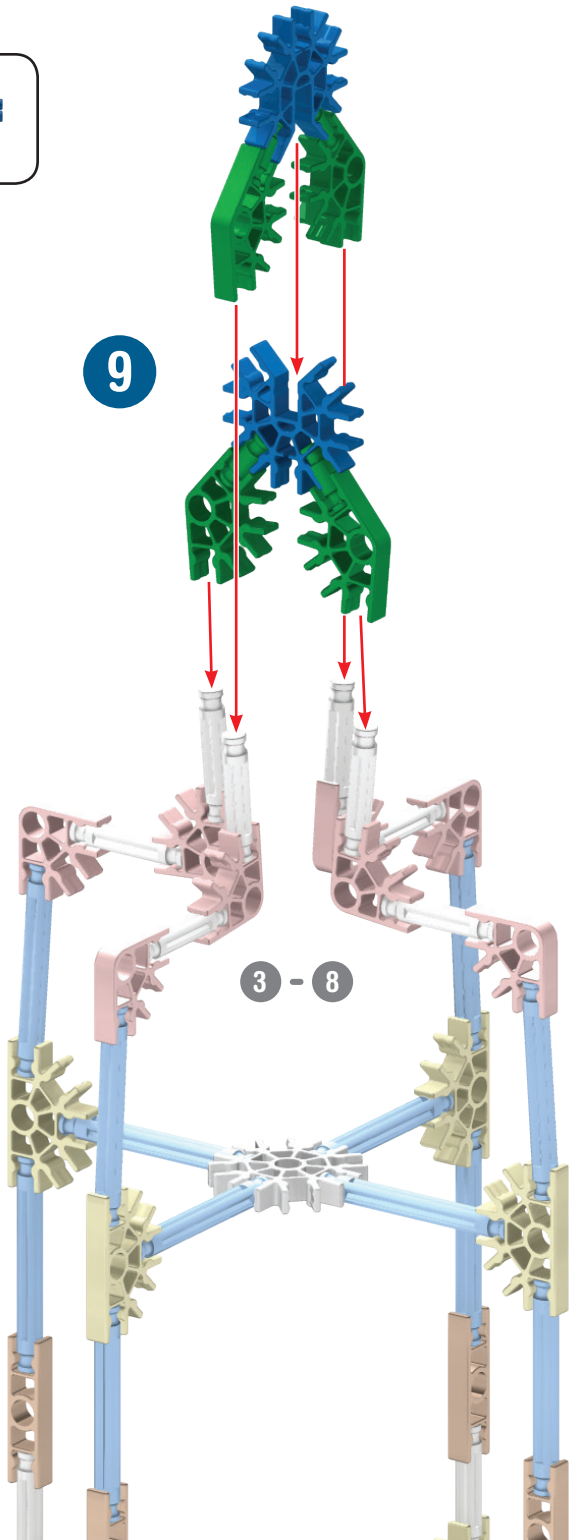

3 - 8

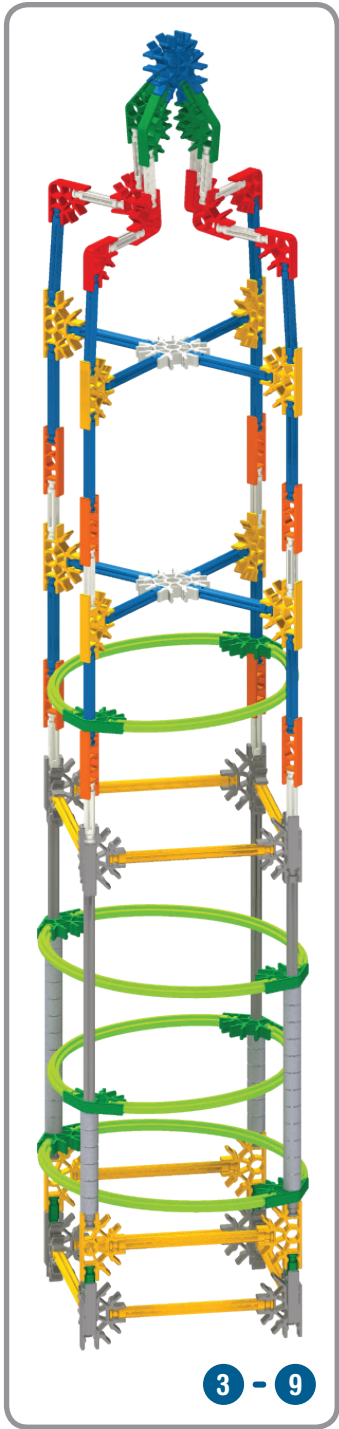

3 - 9

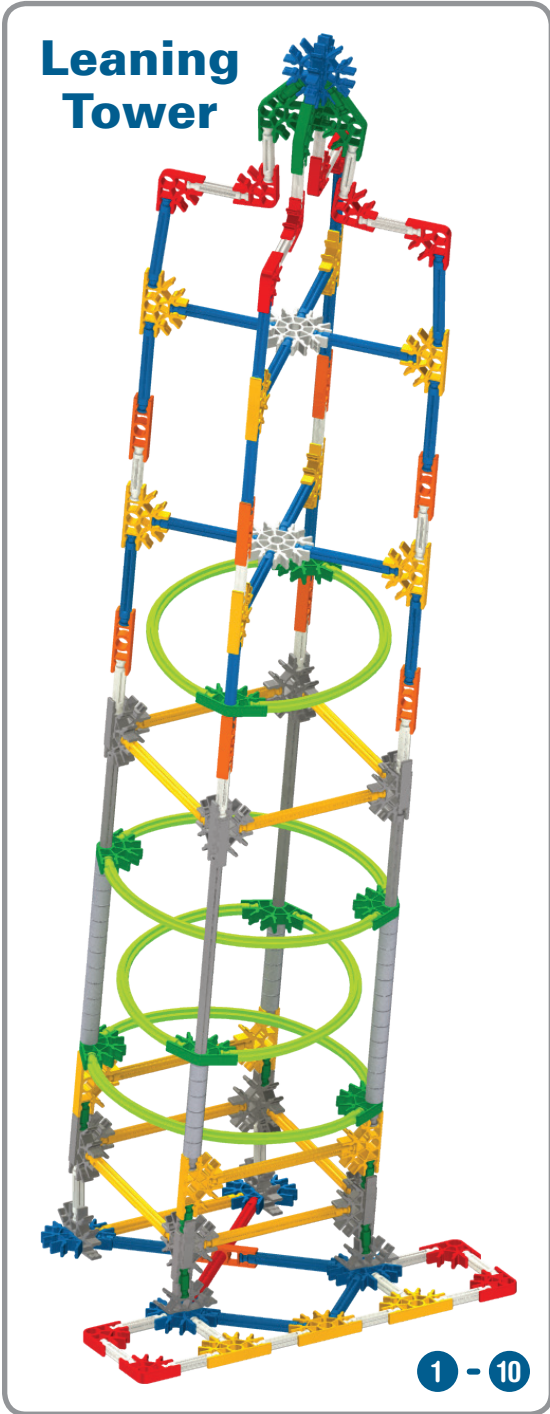
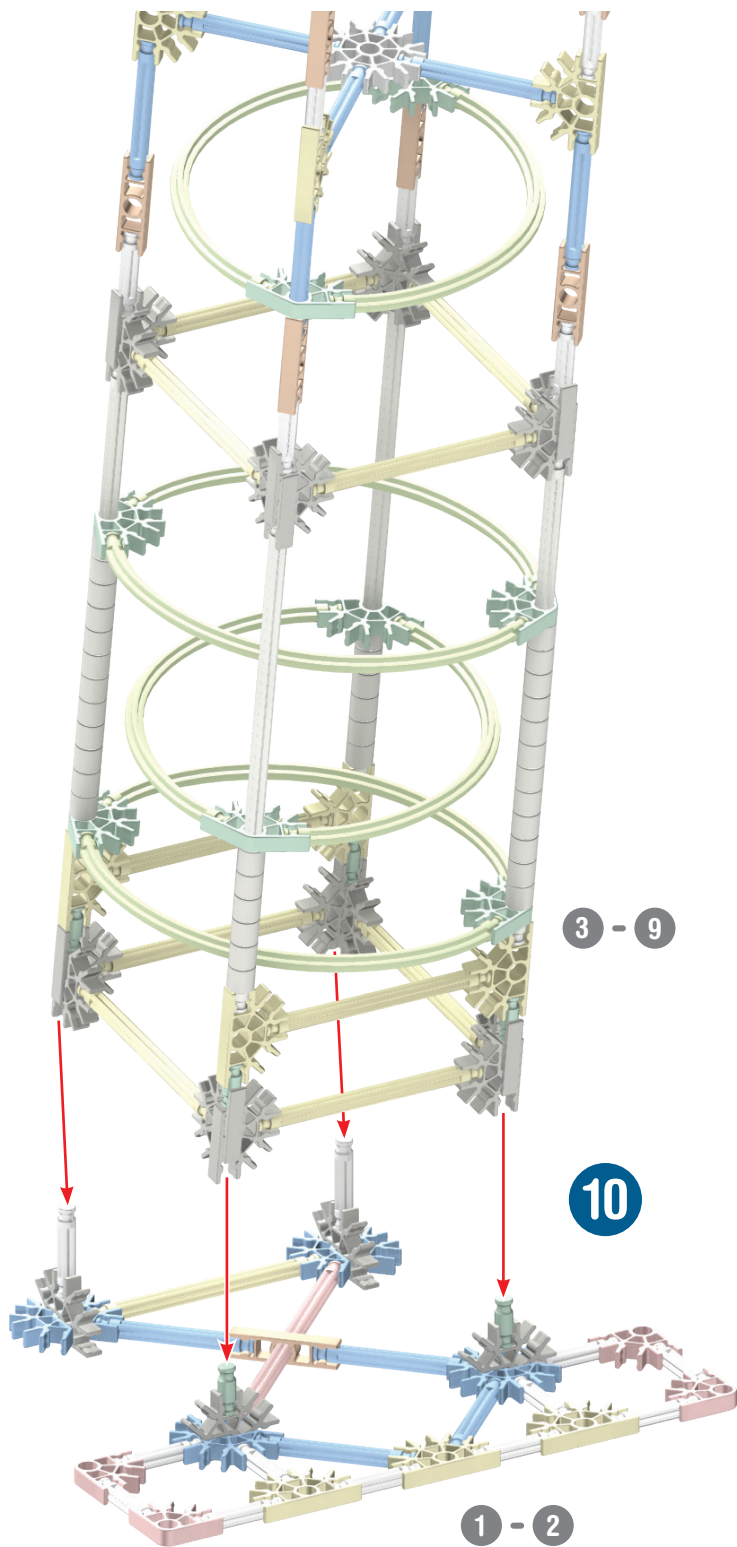

Mayan Pyramid

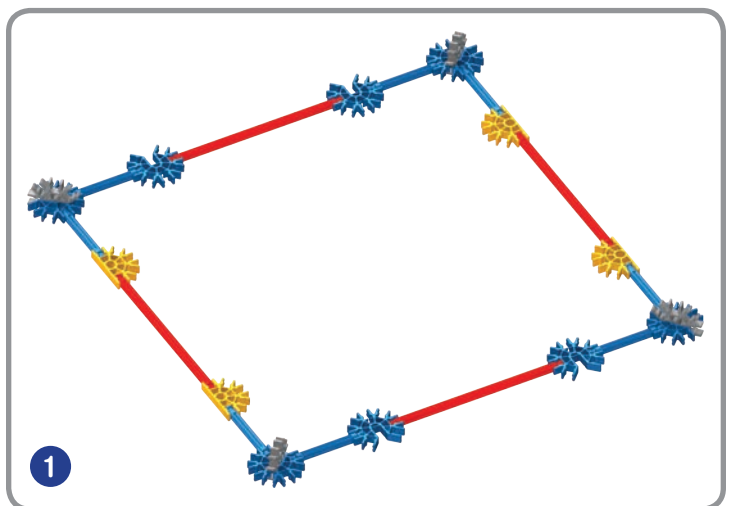
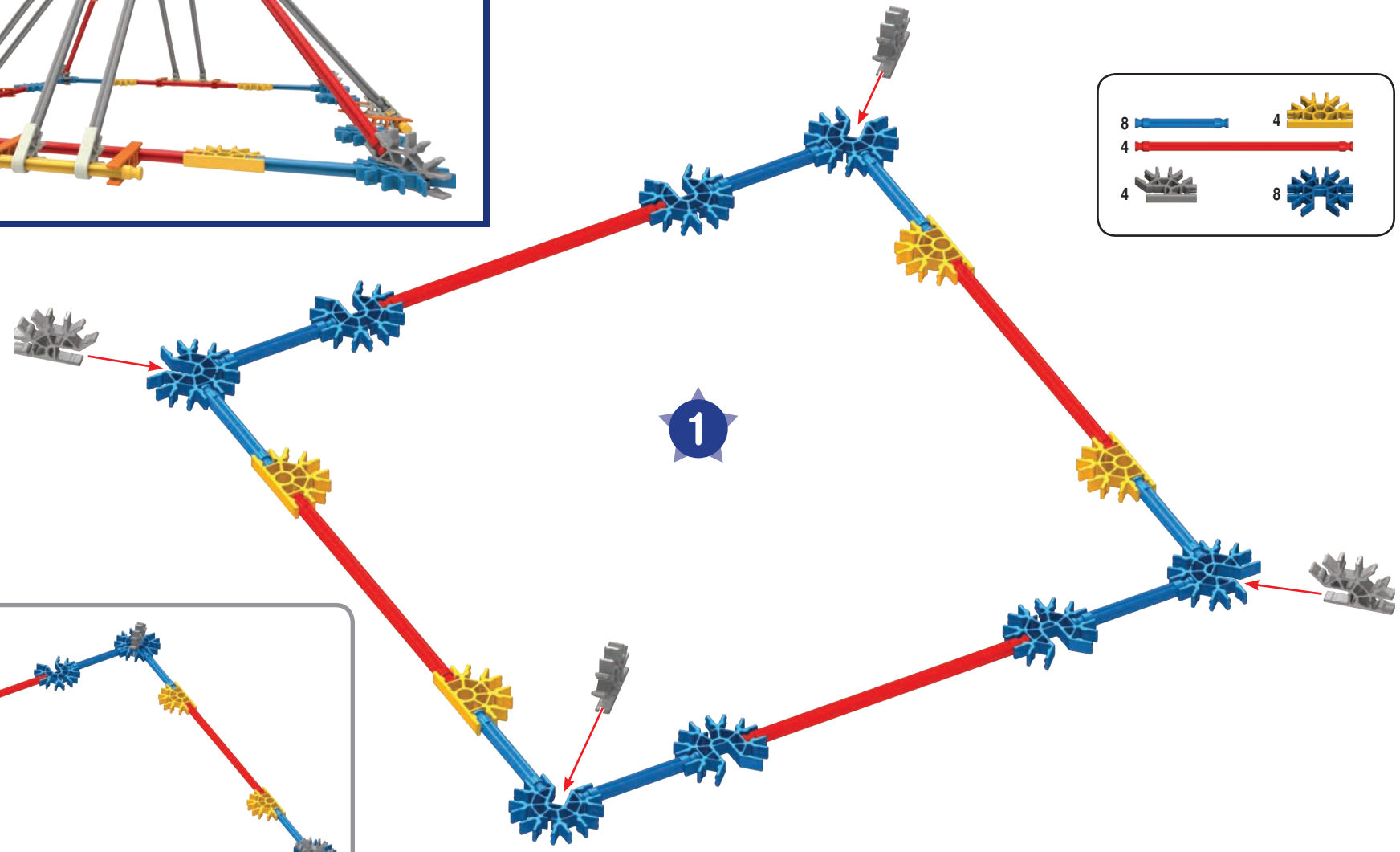
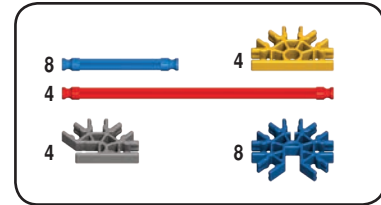

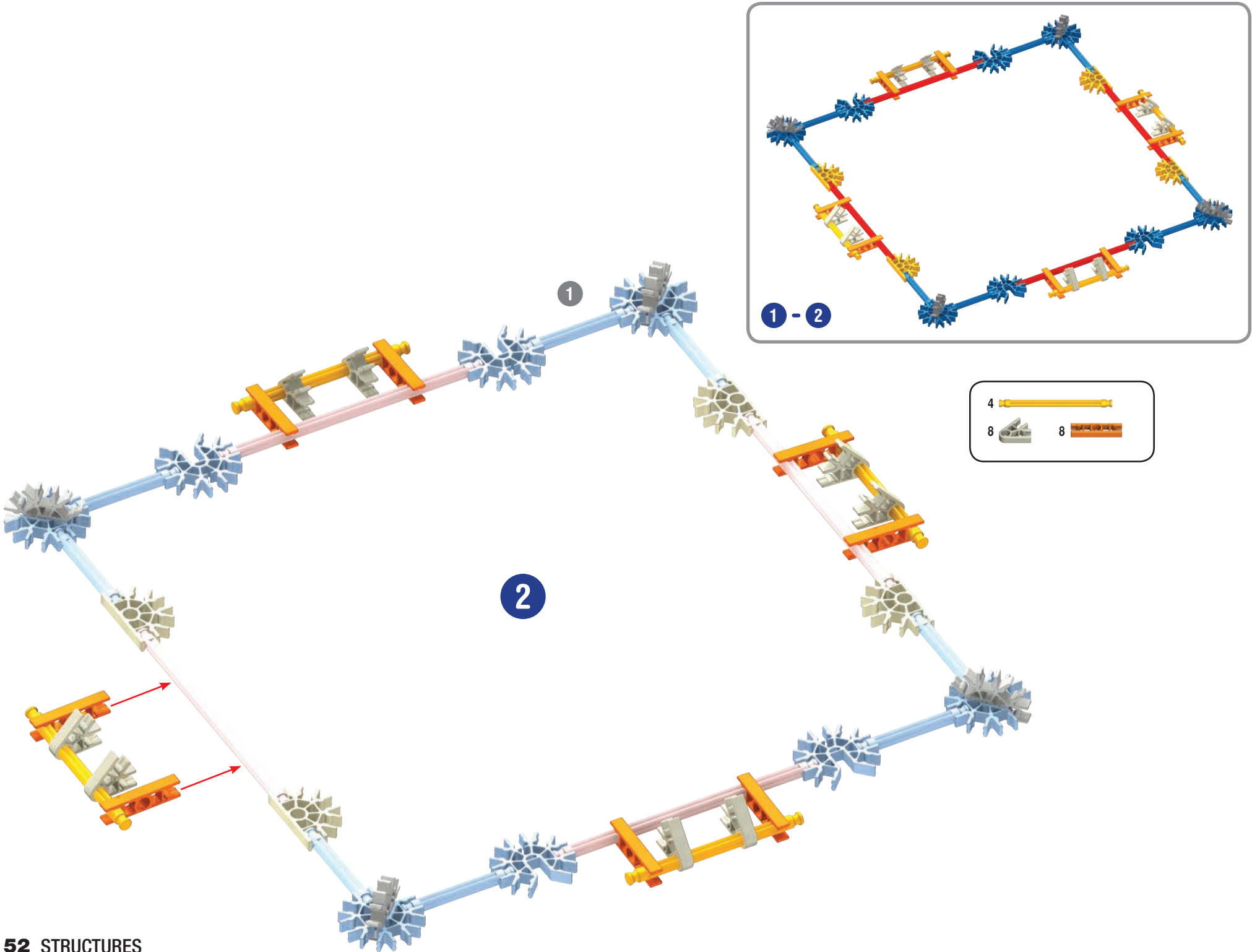

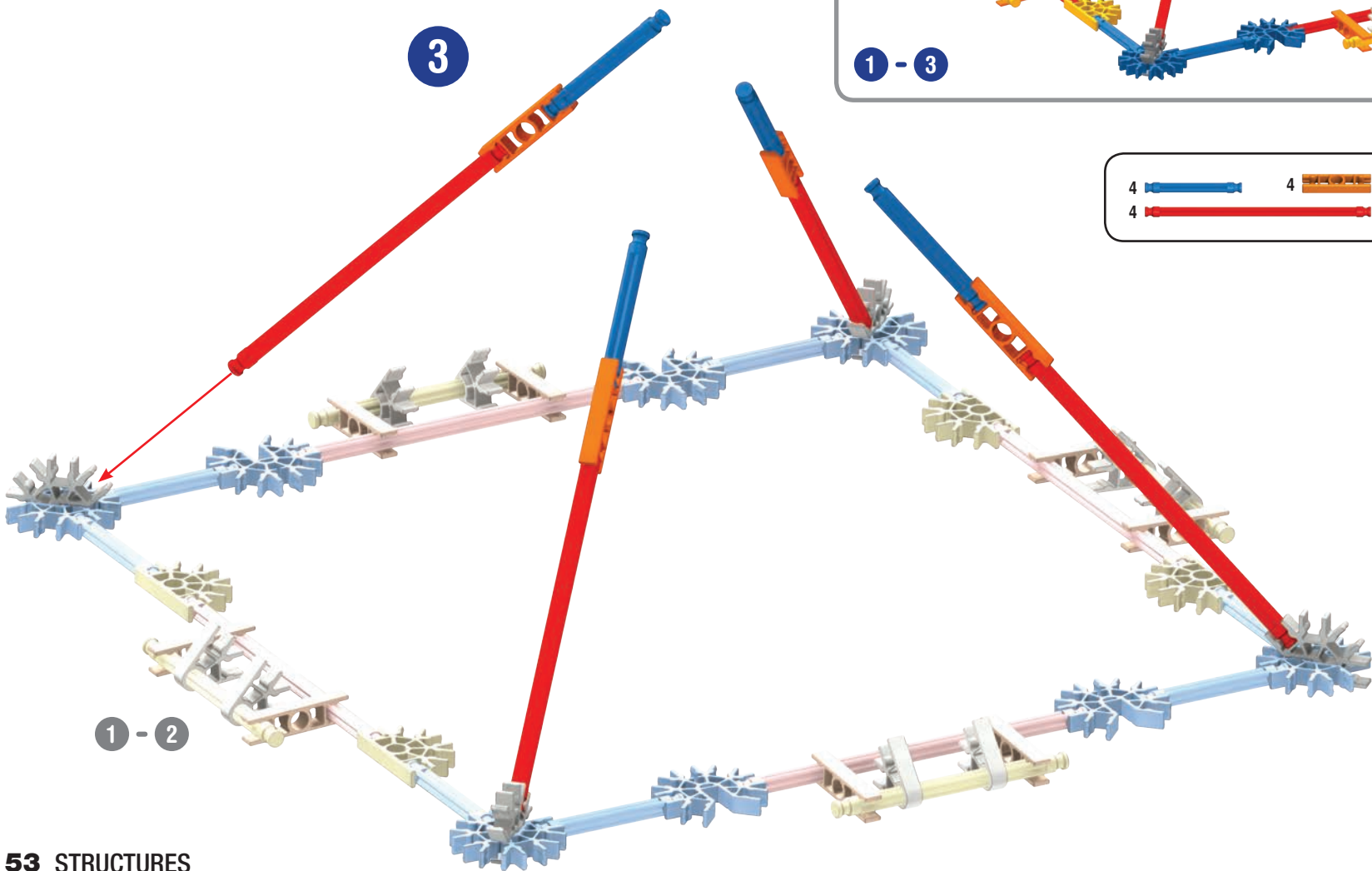
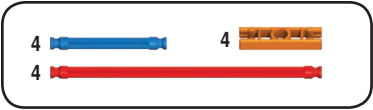
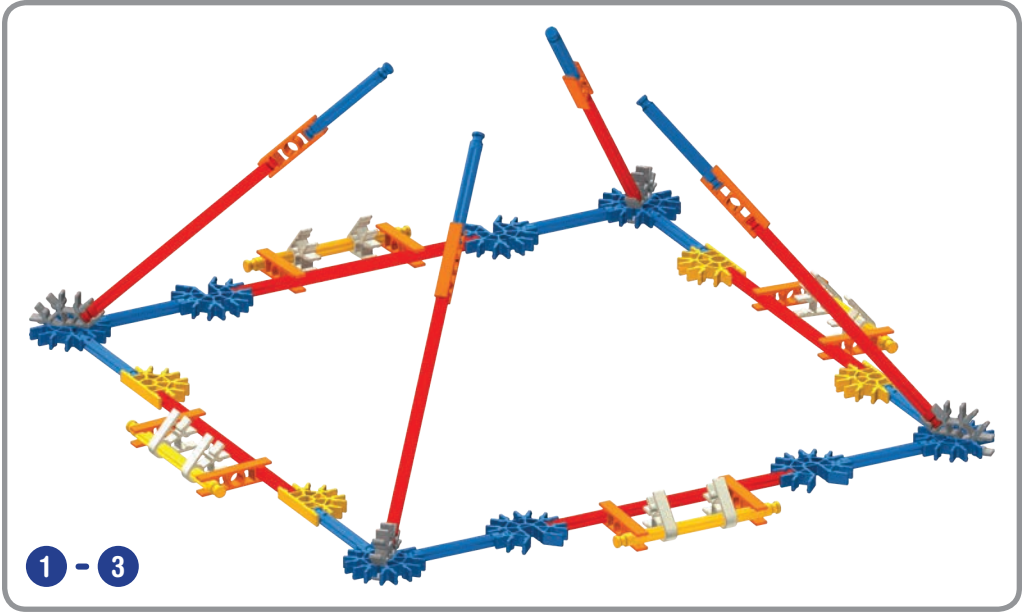

x4

4

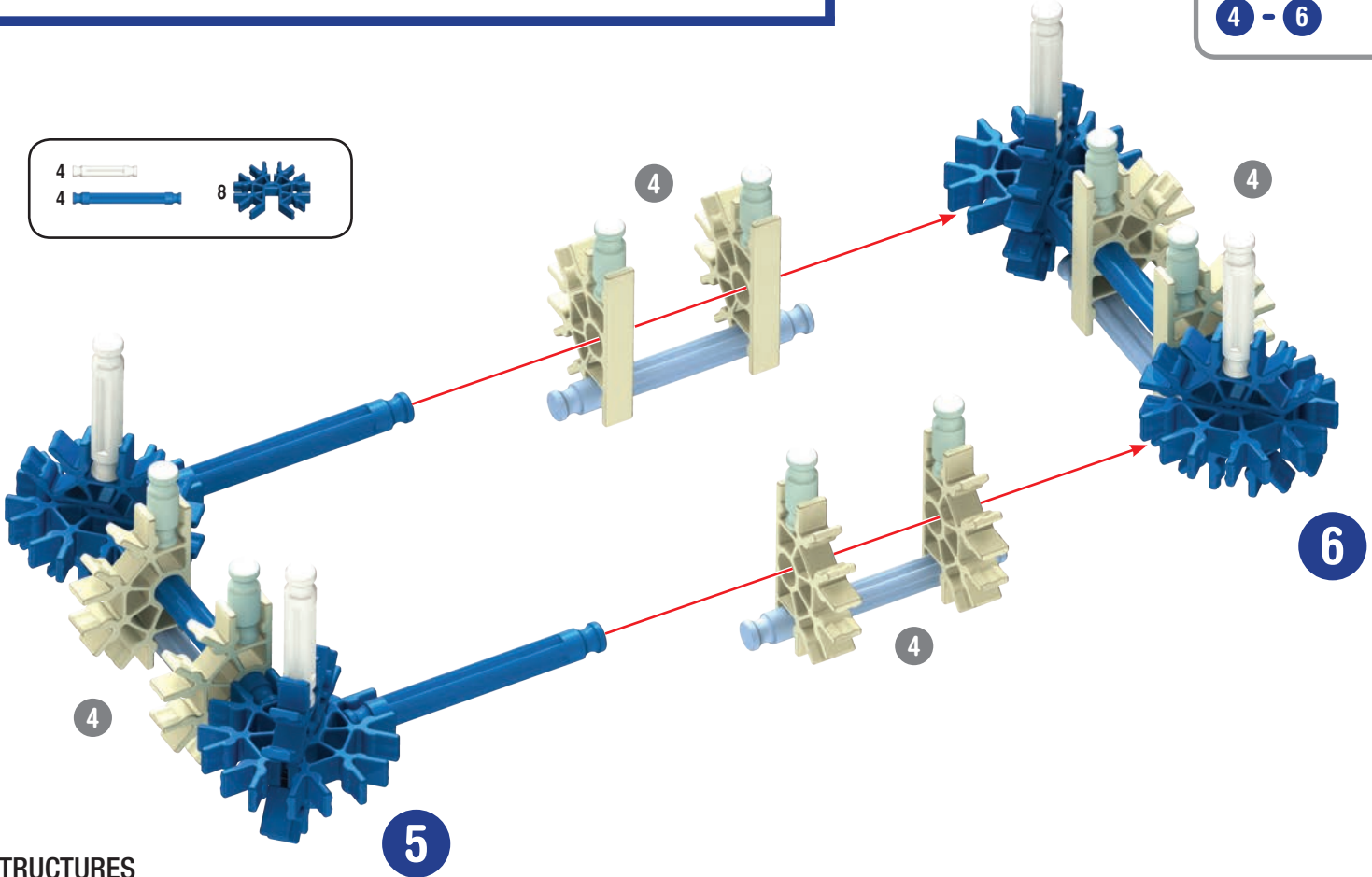
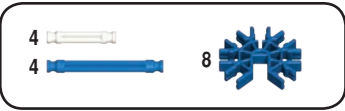
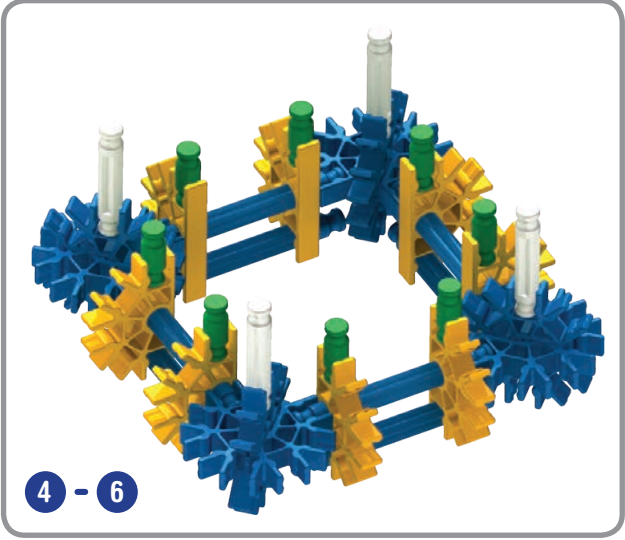
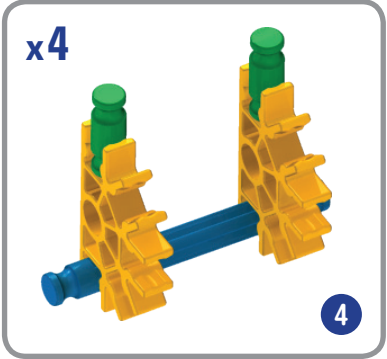
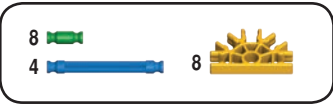
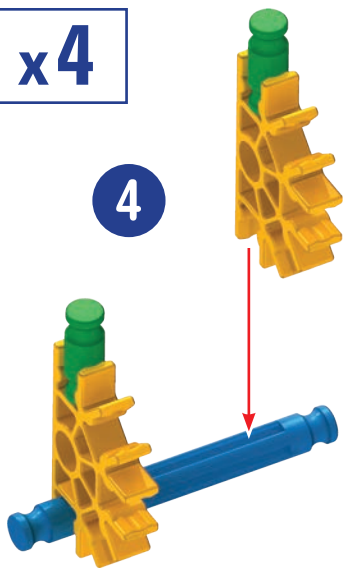

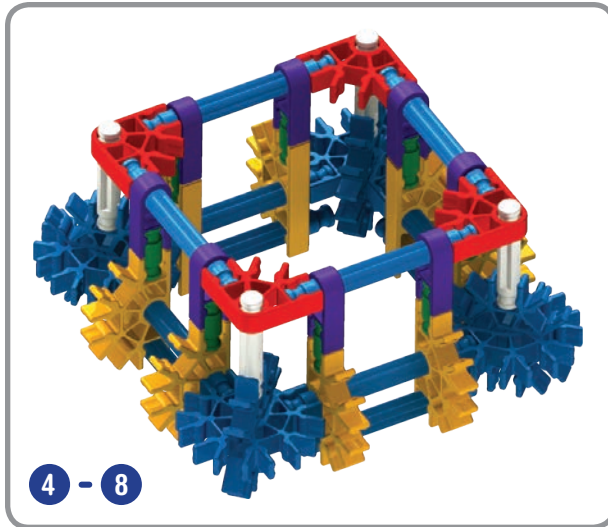
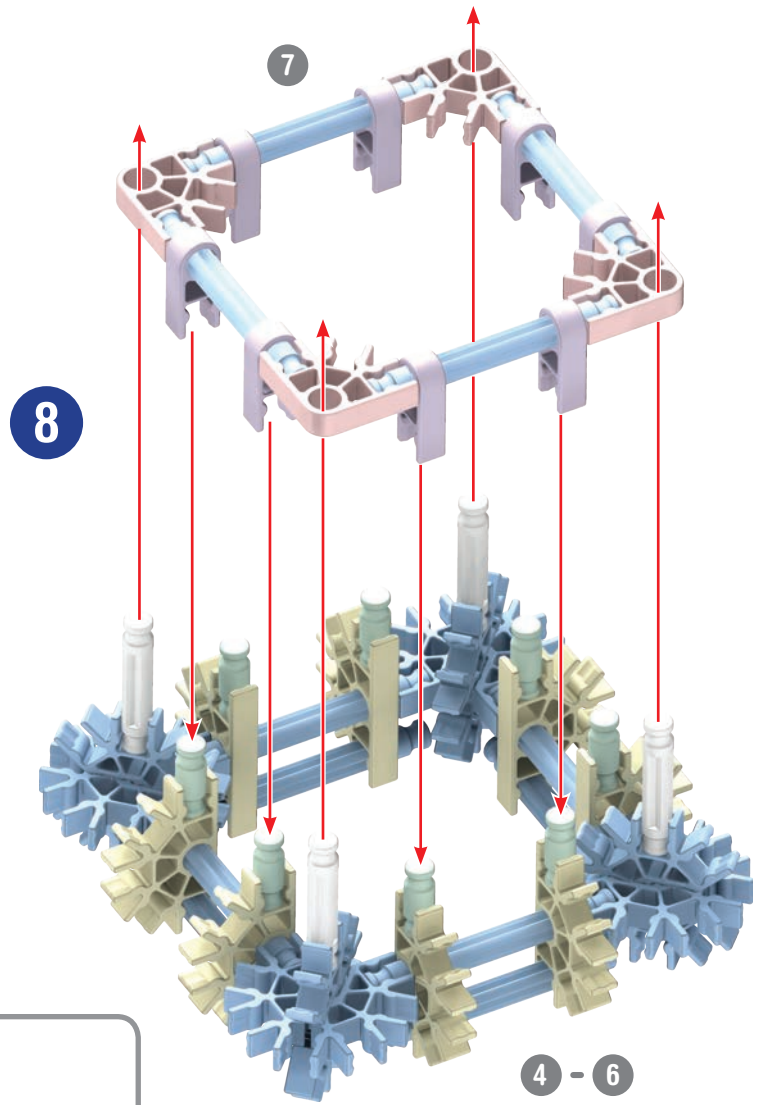
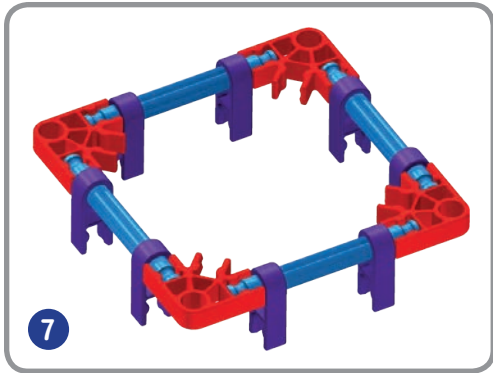
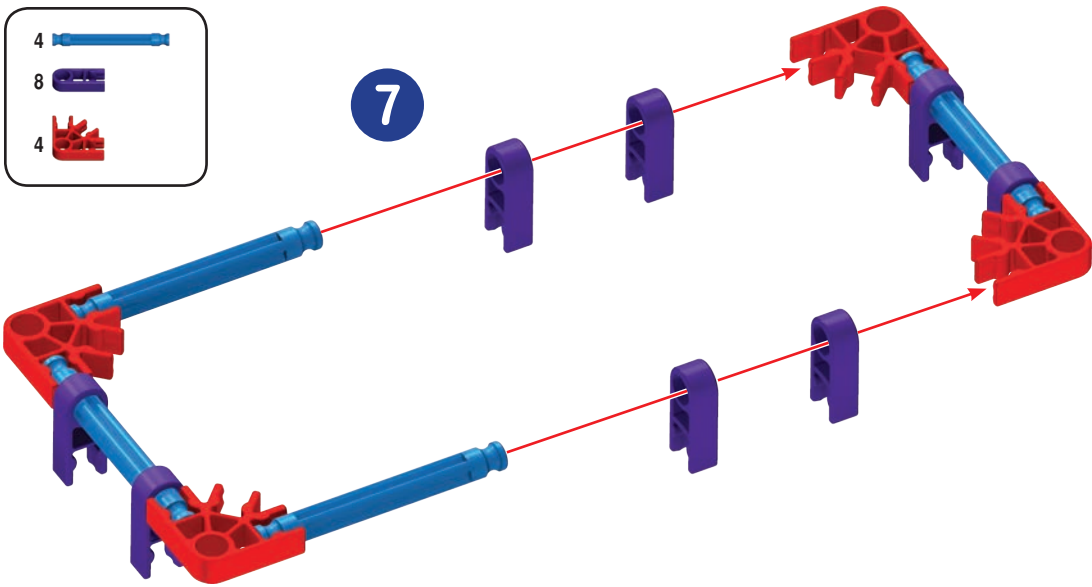
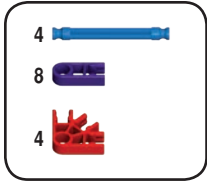

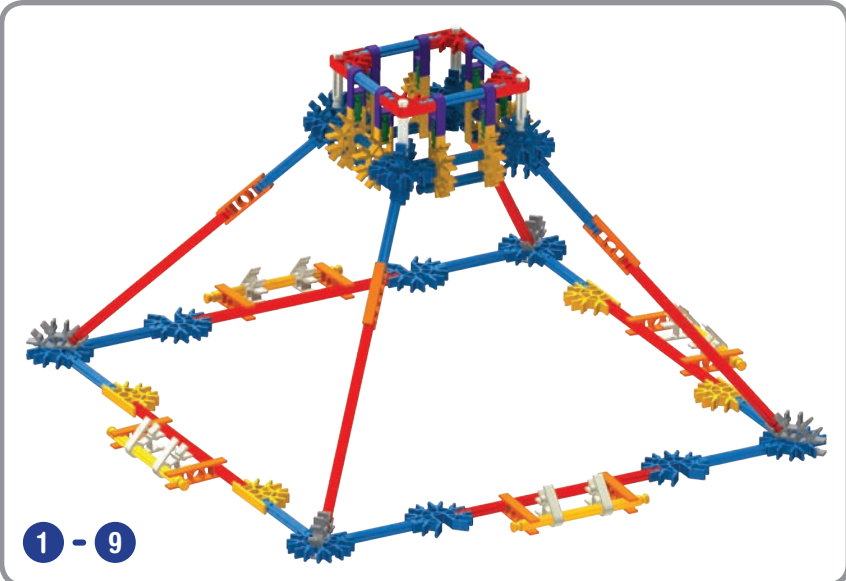
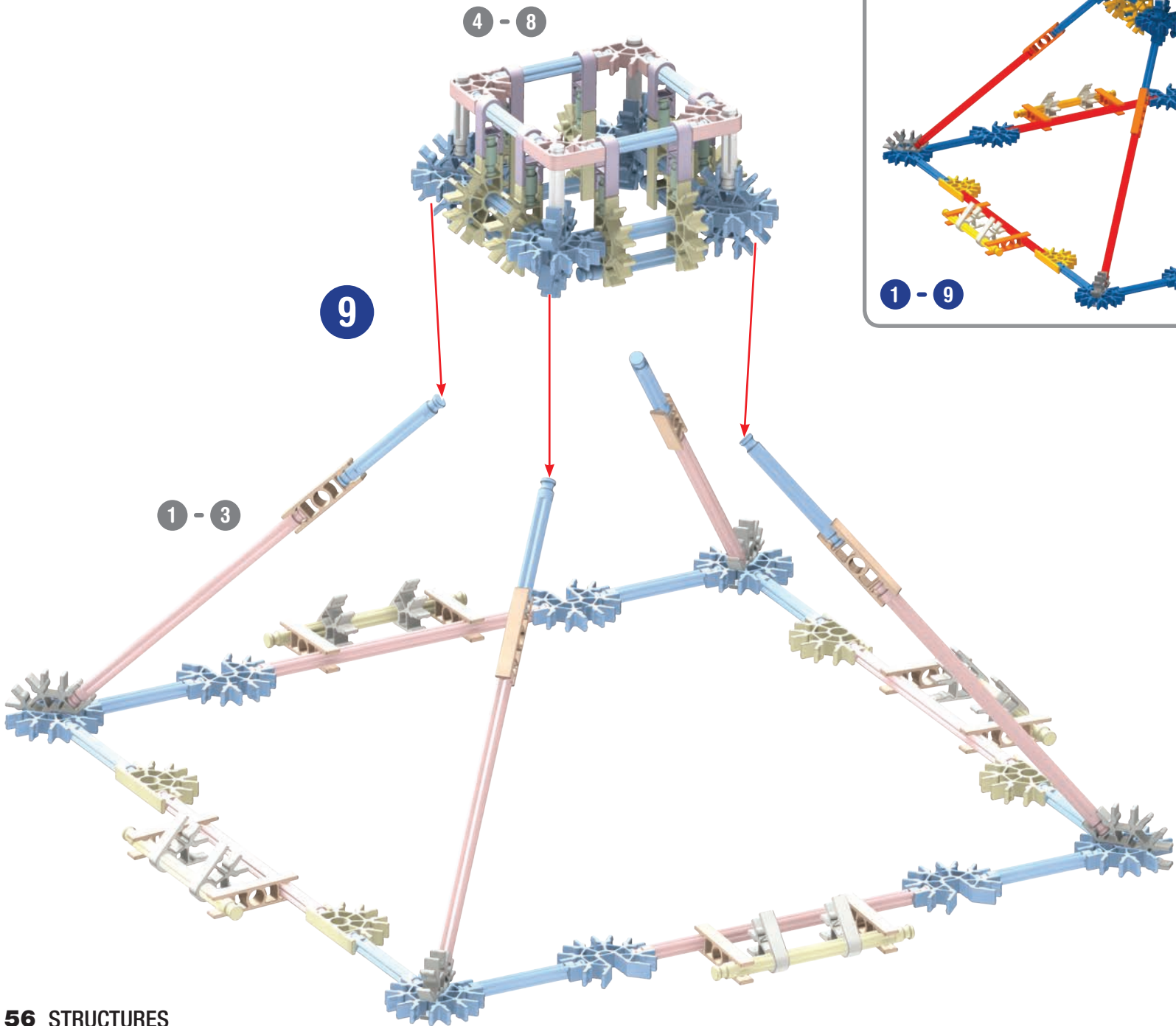

Mayan Pyramid

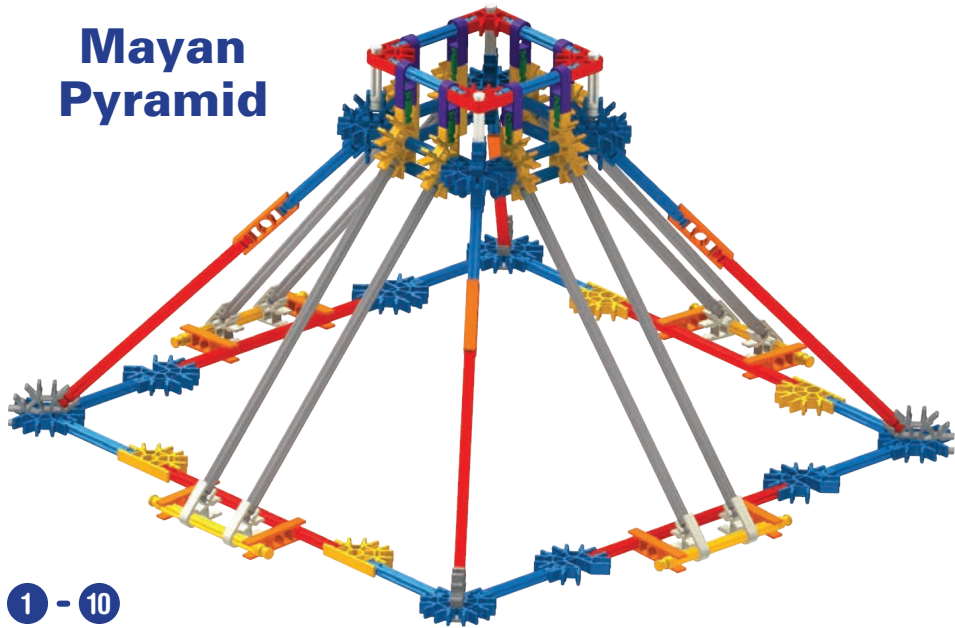

1 - 10

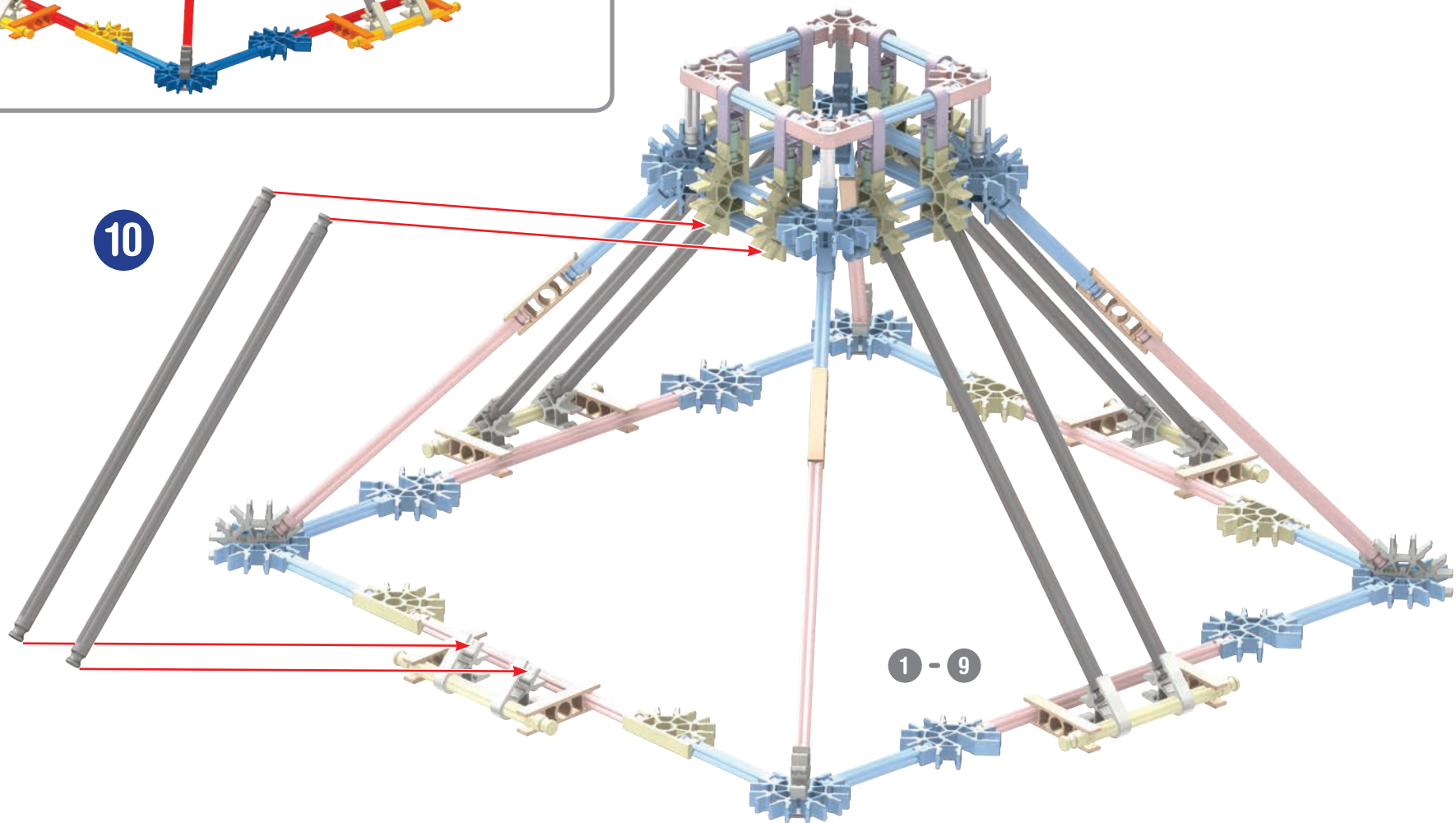

Observation Tower

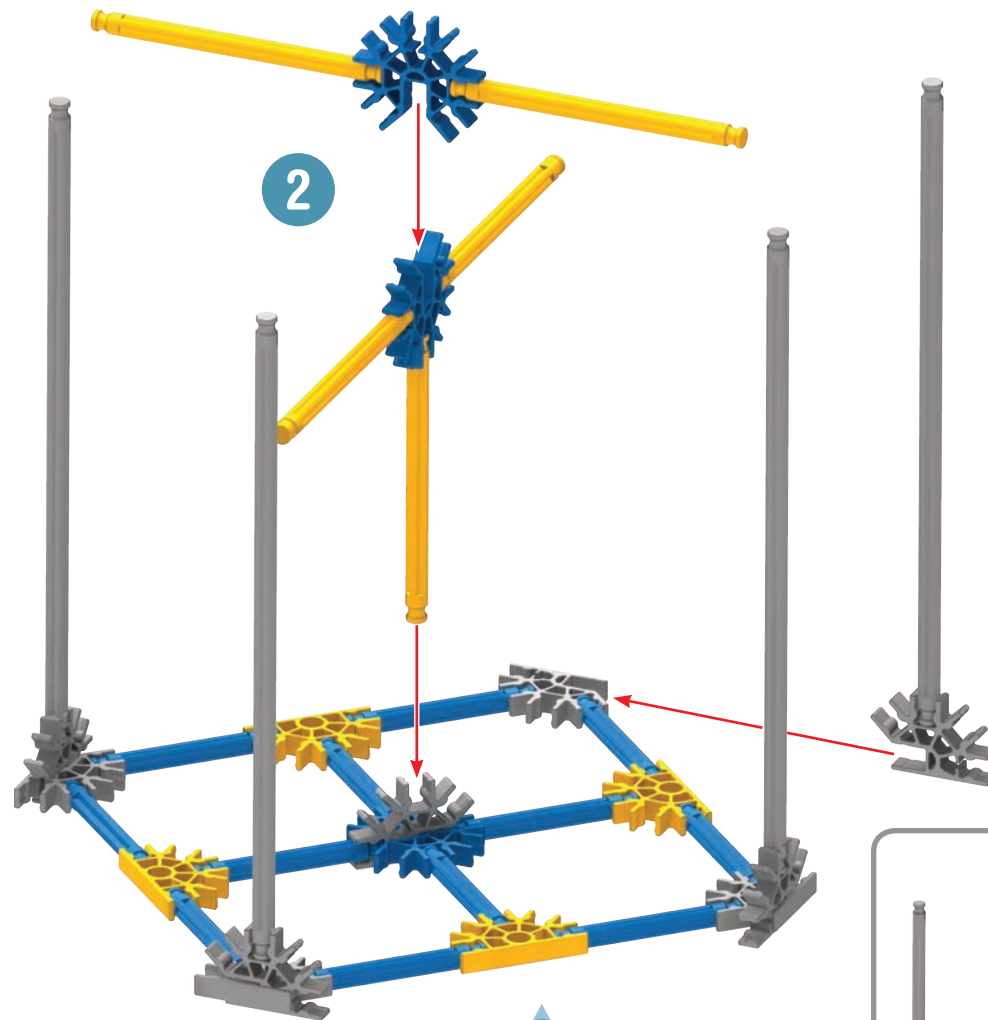
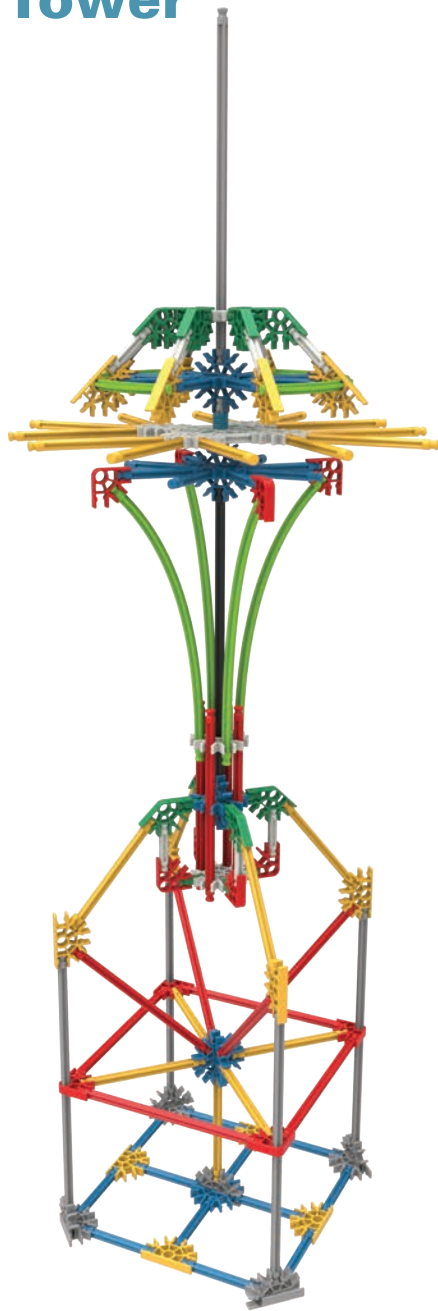

1

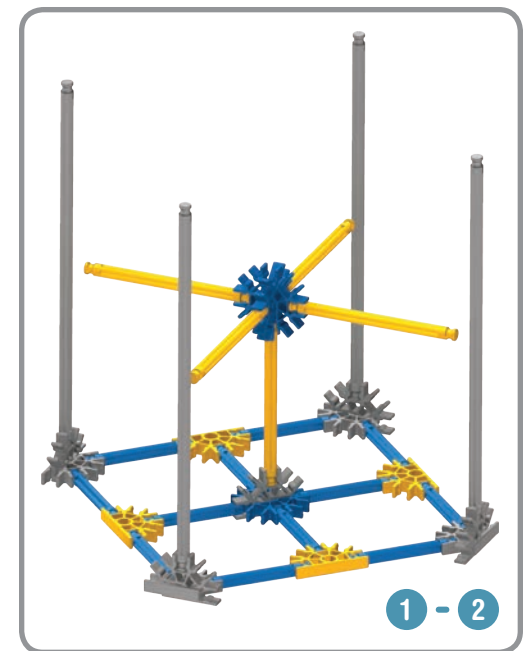
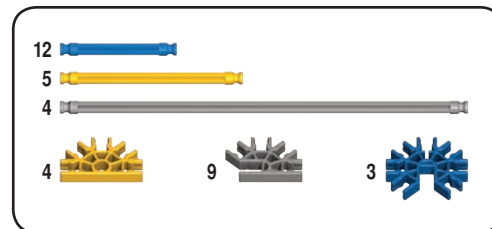

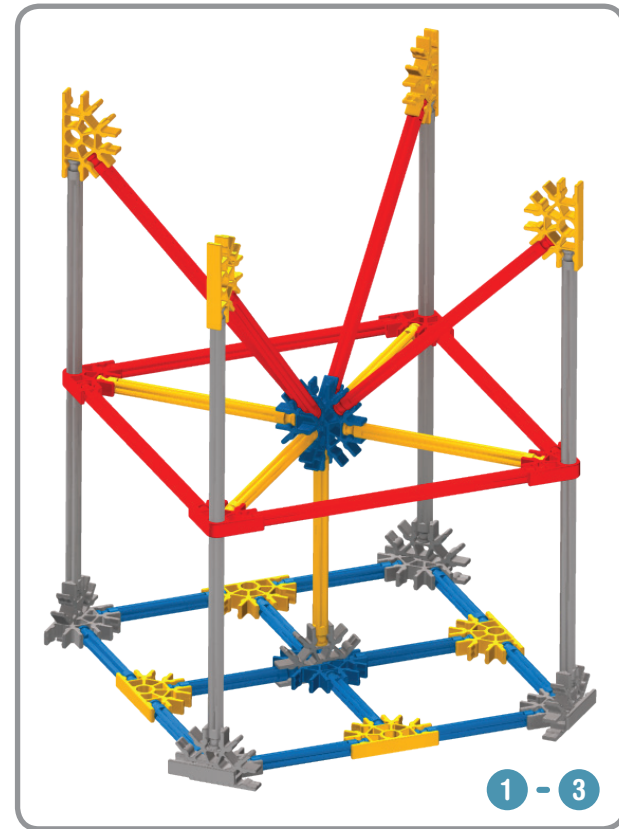
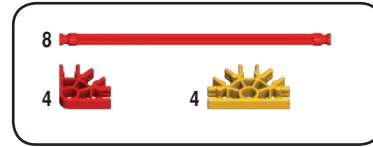
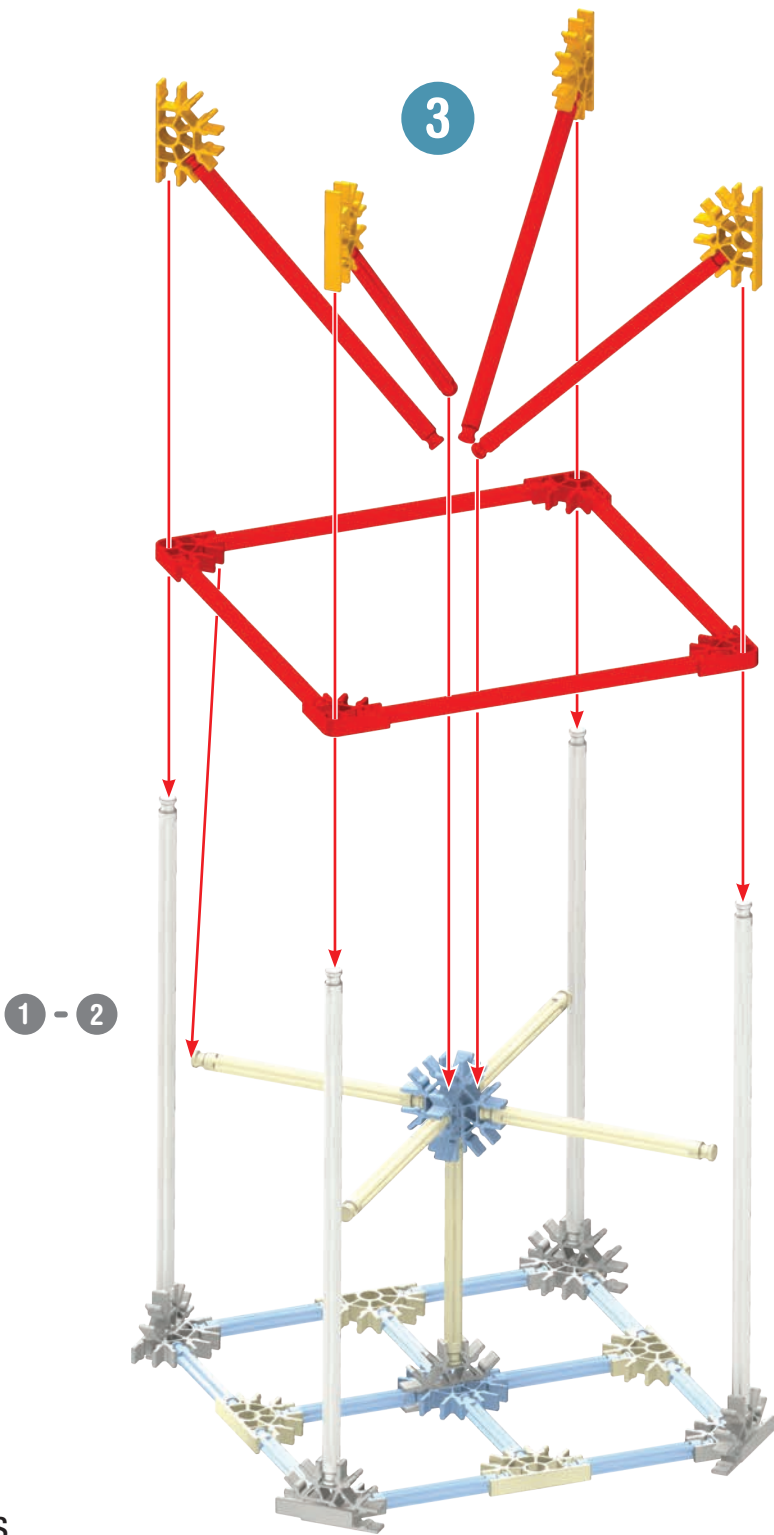



- 4
- 1
- 2
- 2

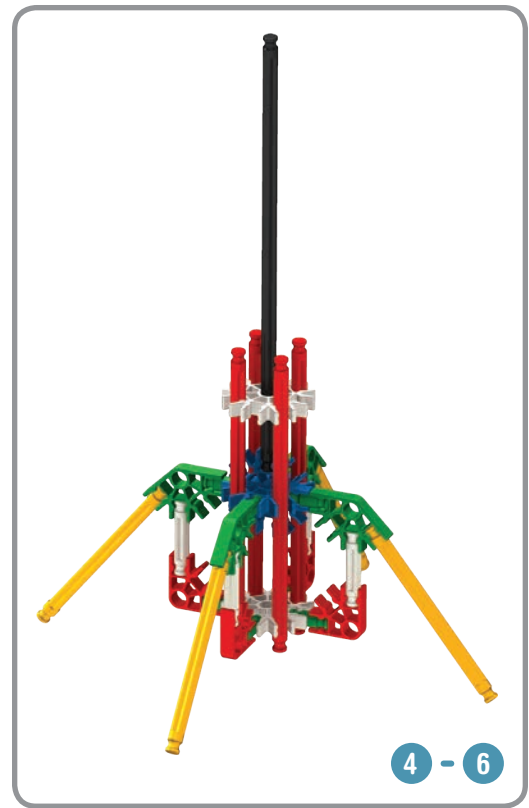
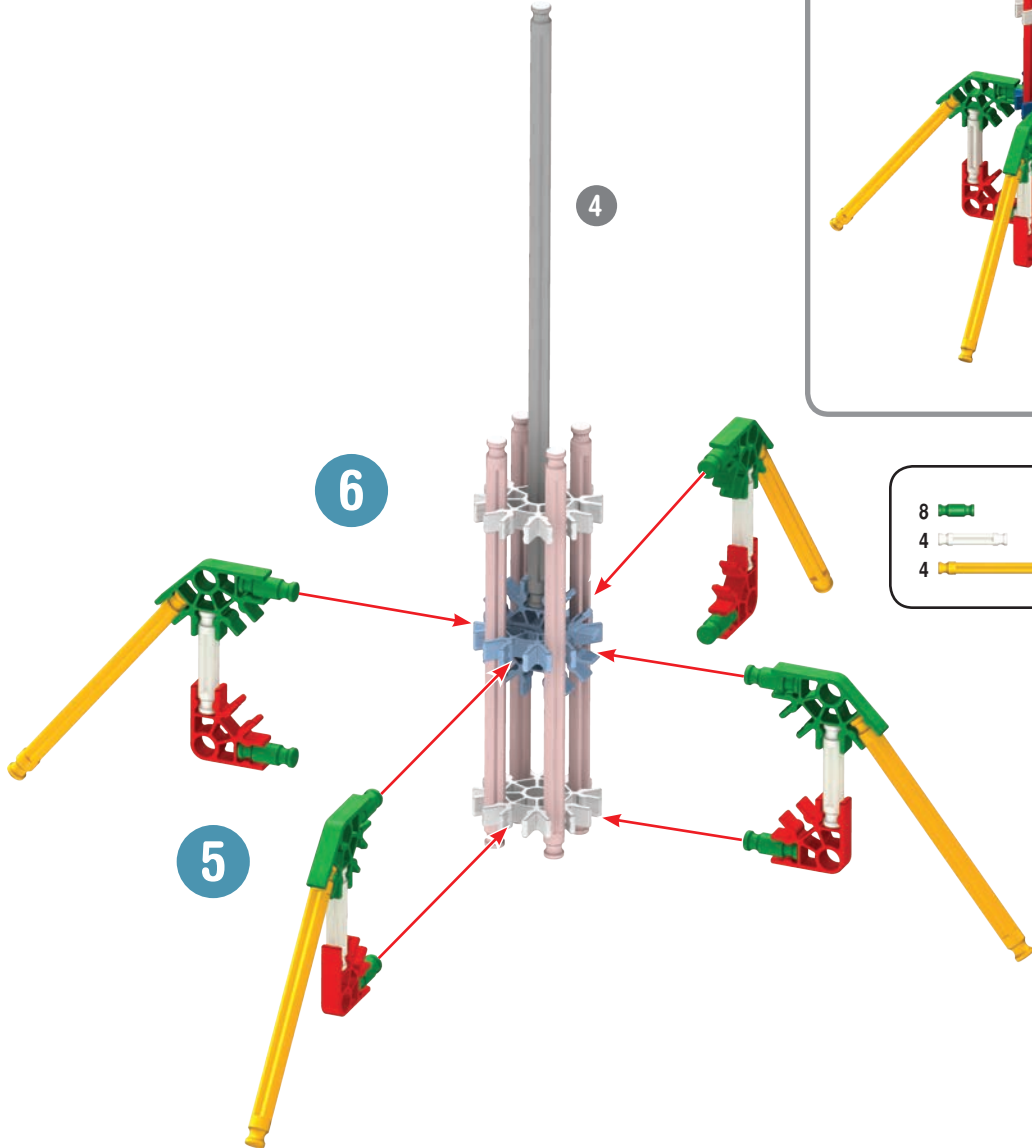
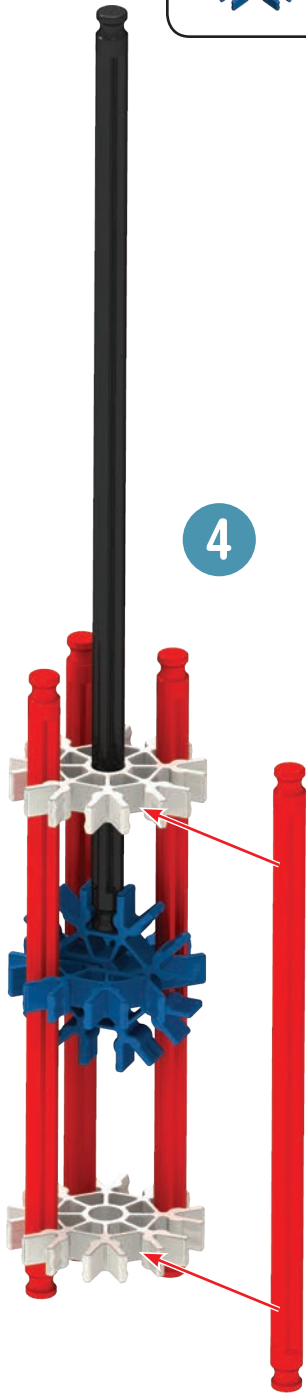



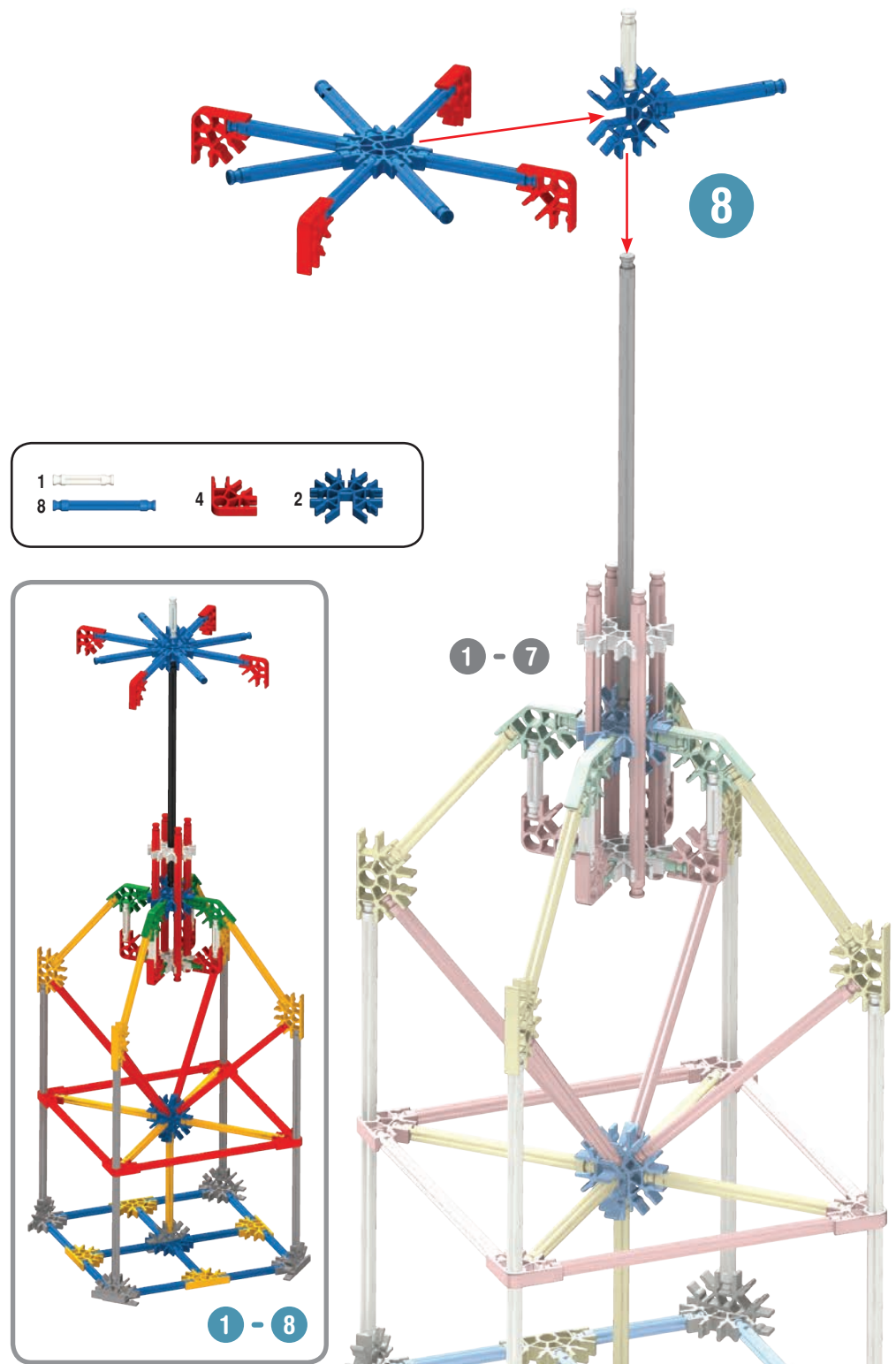
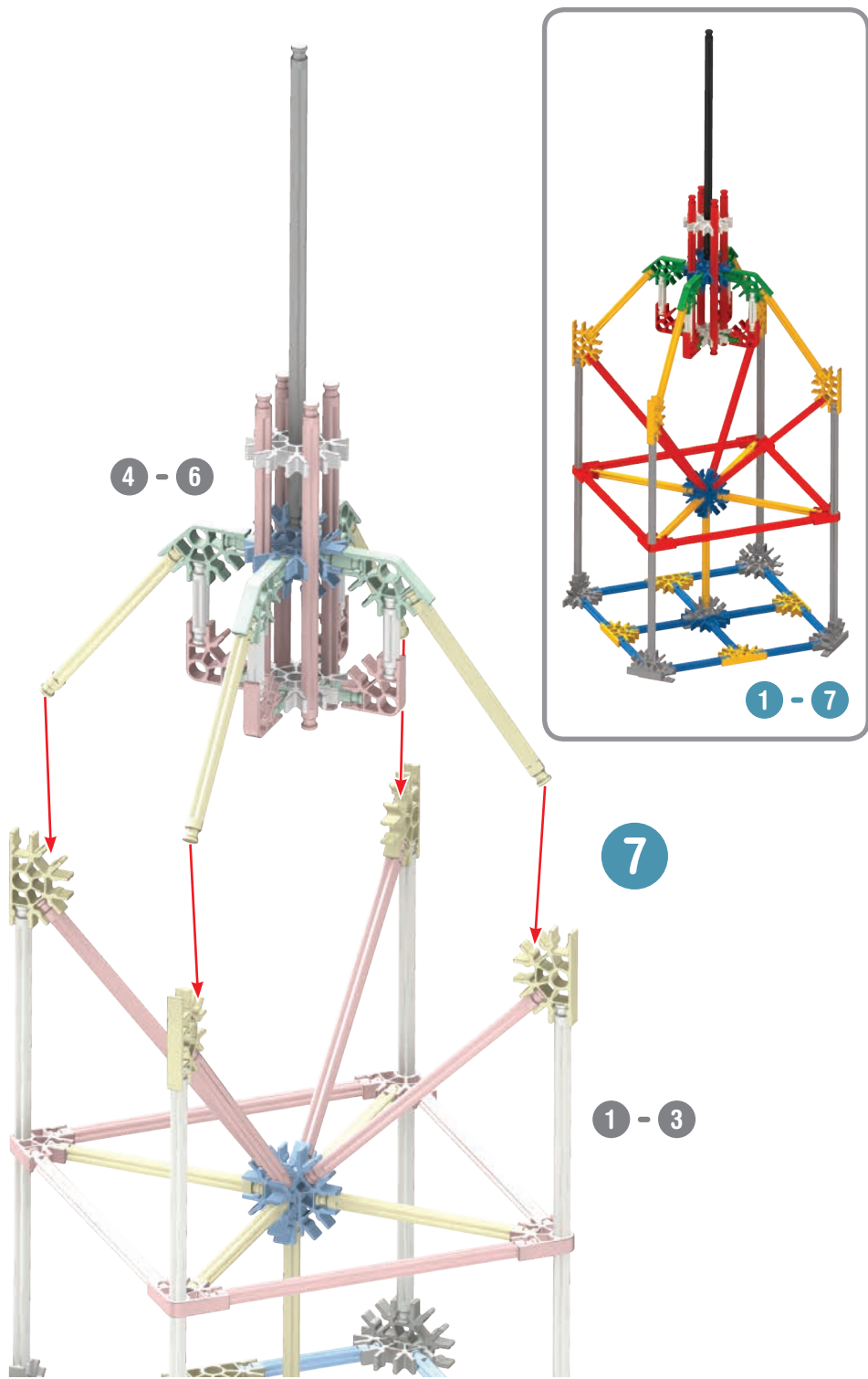

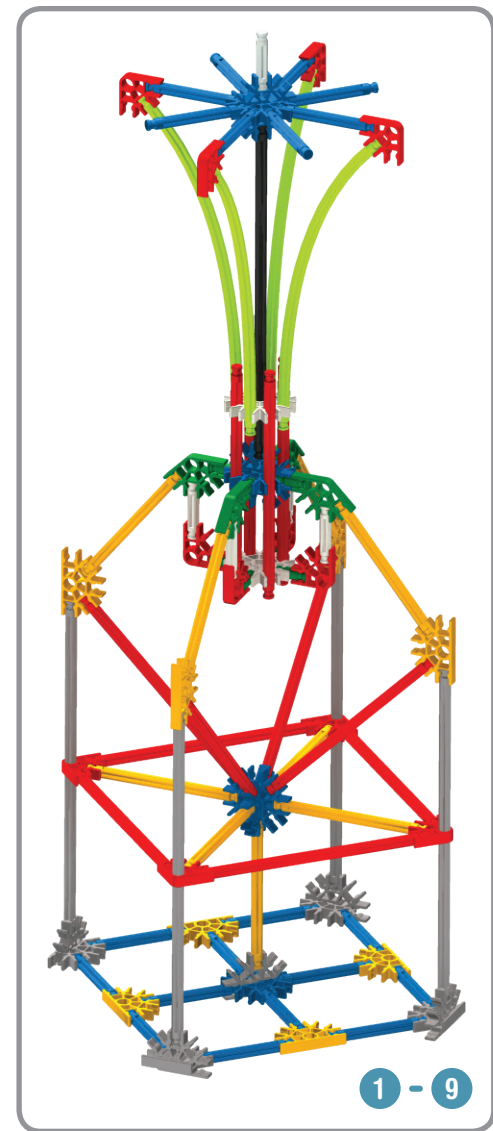
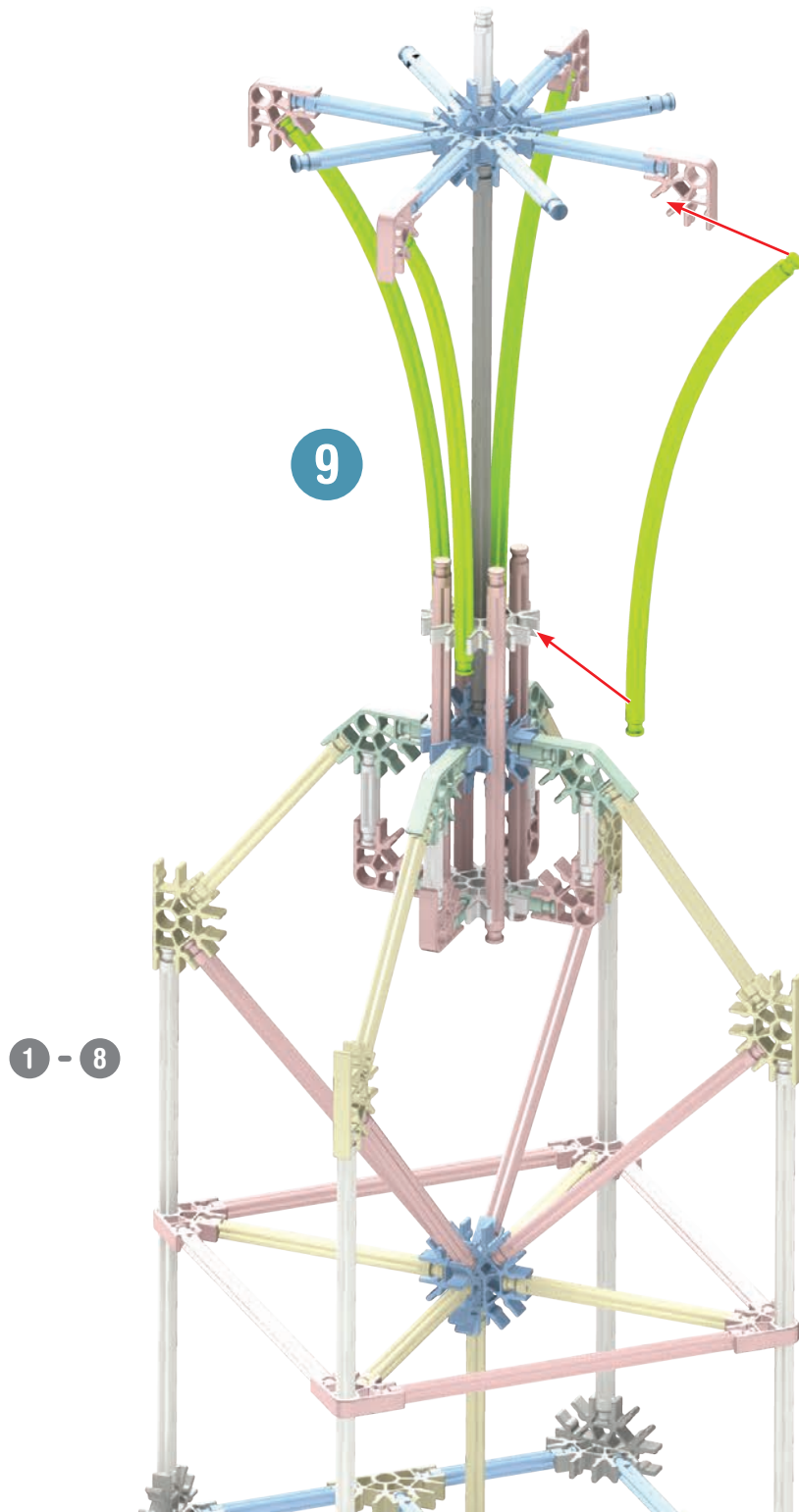
- 8
- 4
- 4
- 4
- 4

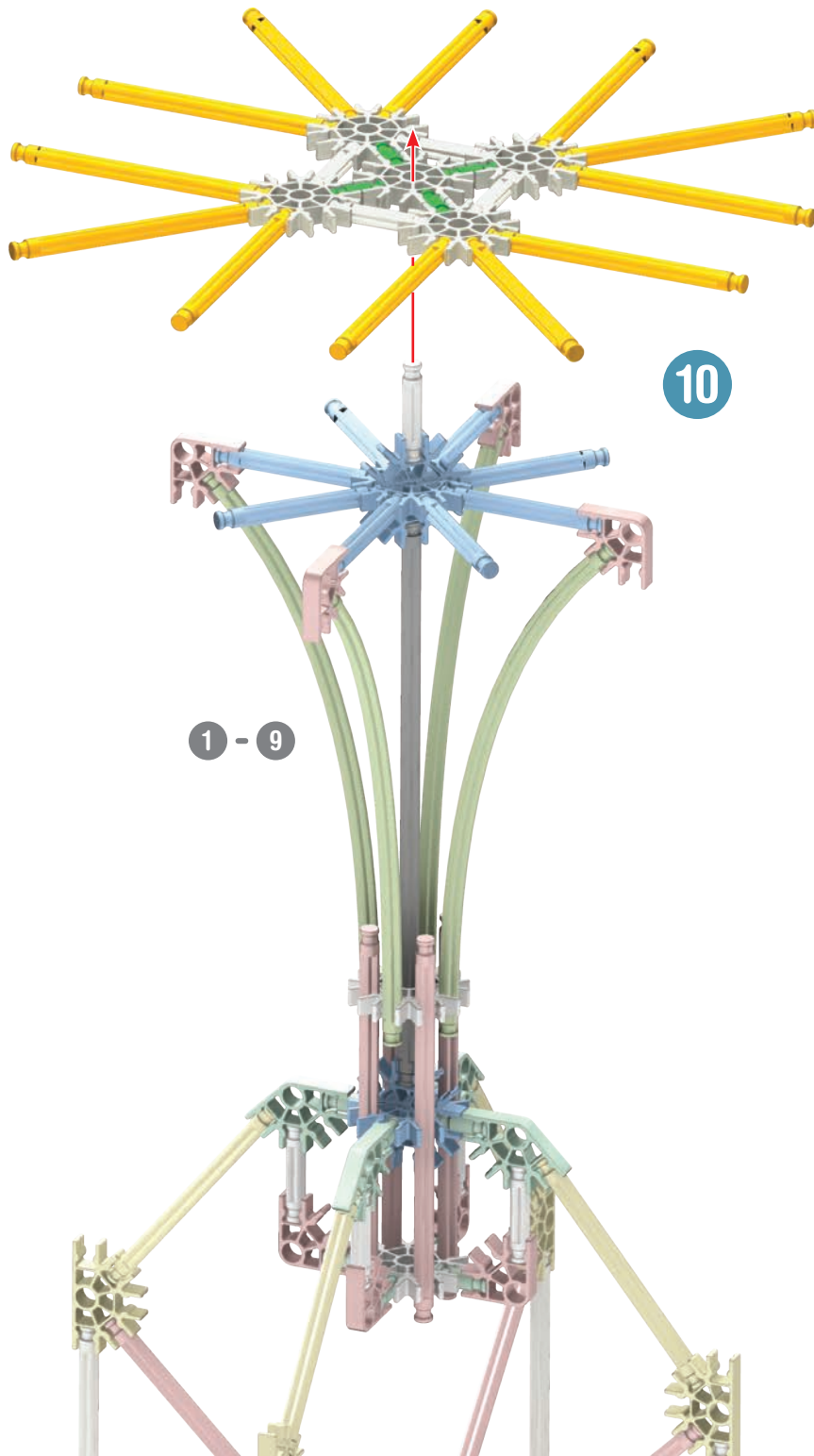







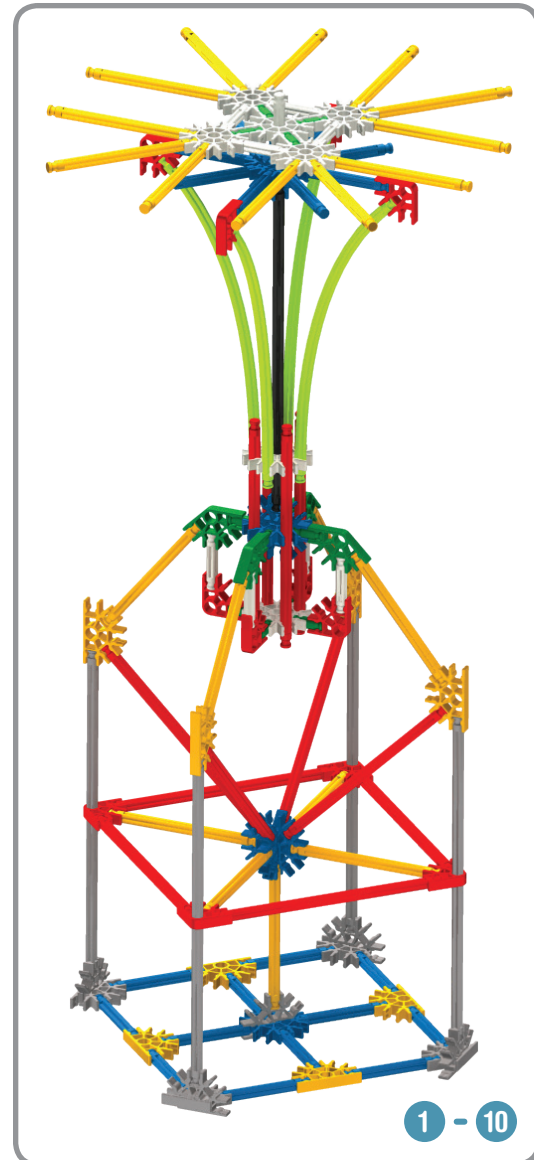

- 4 
 - 4 
 - 12 
- 5 

1 - 9

10



1 - 10

3  8  2 

8 

11

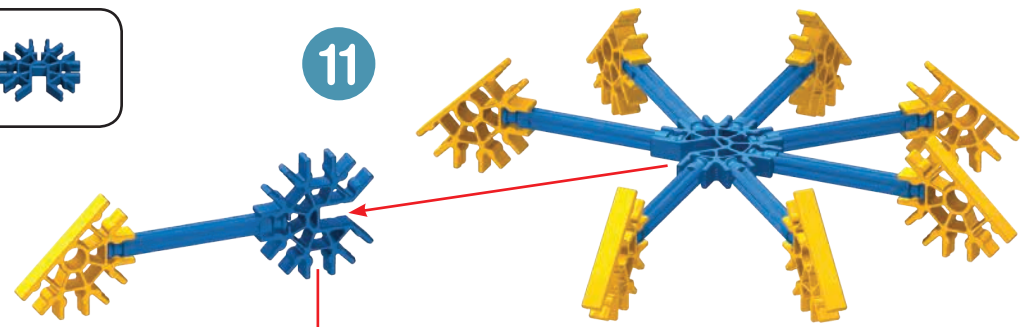

3

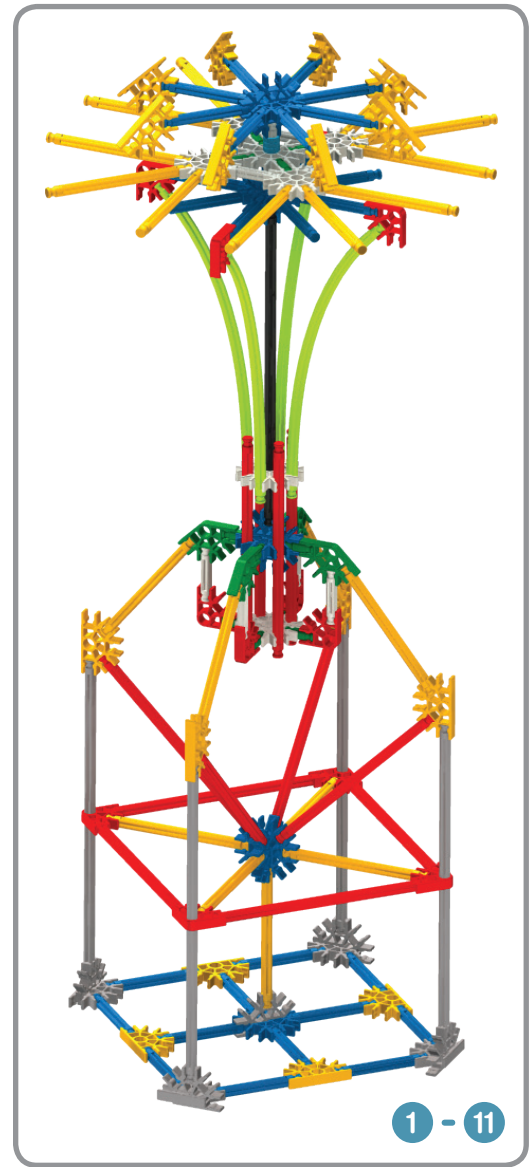
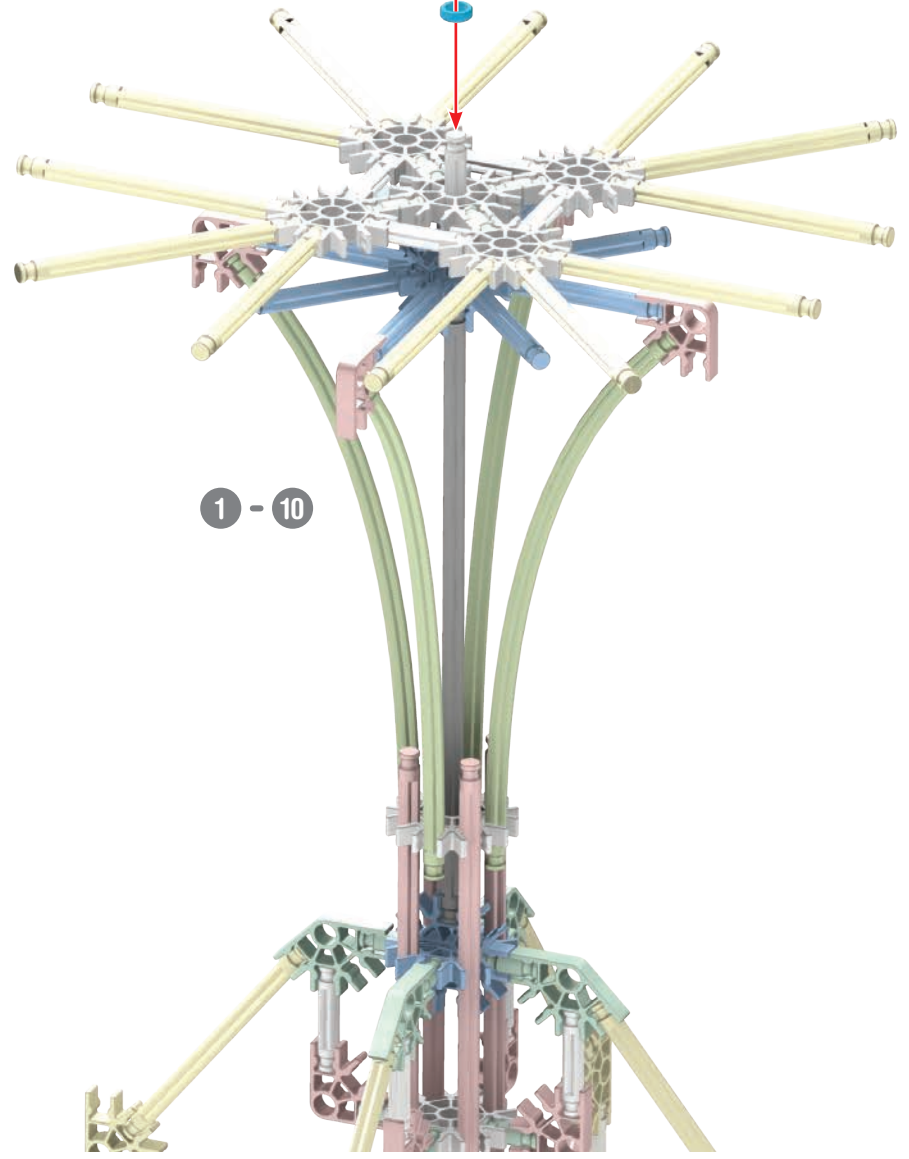

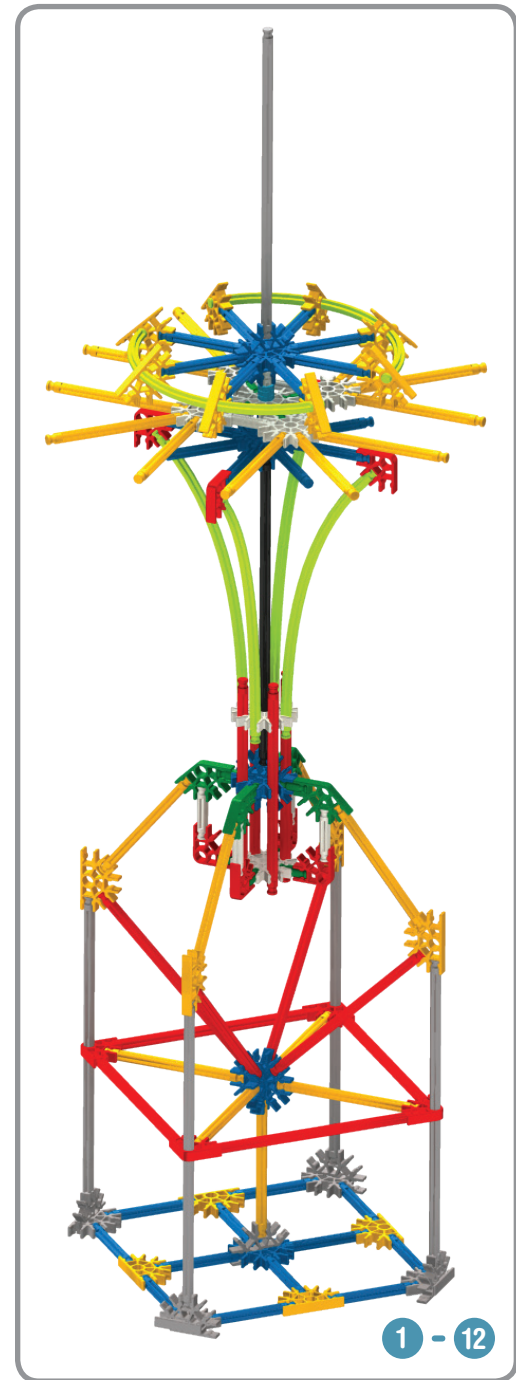
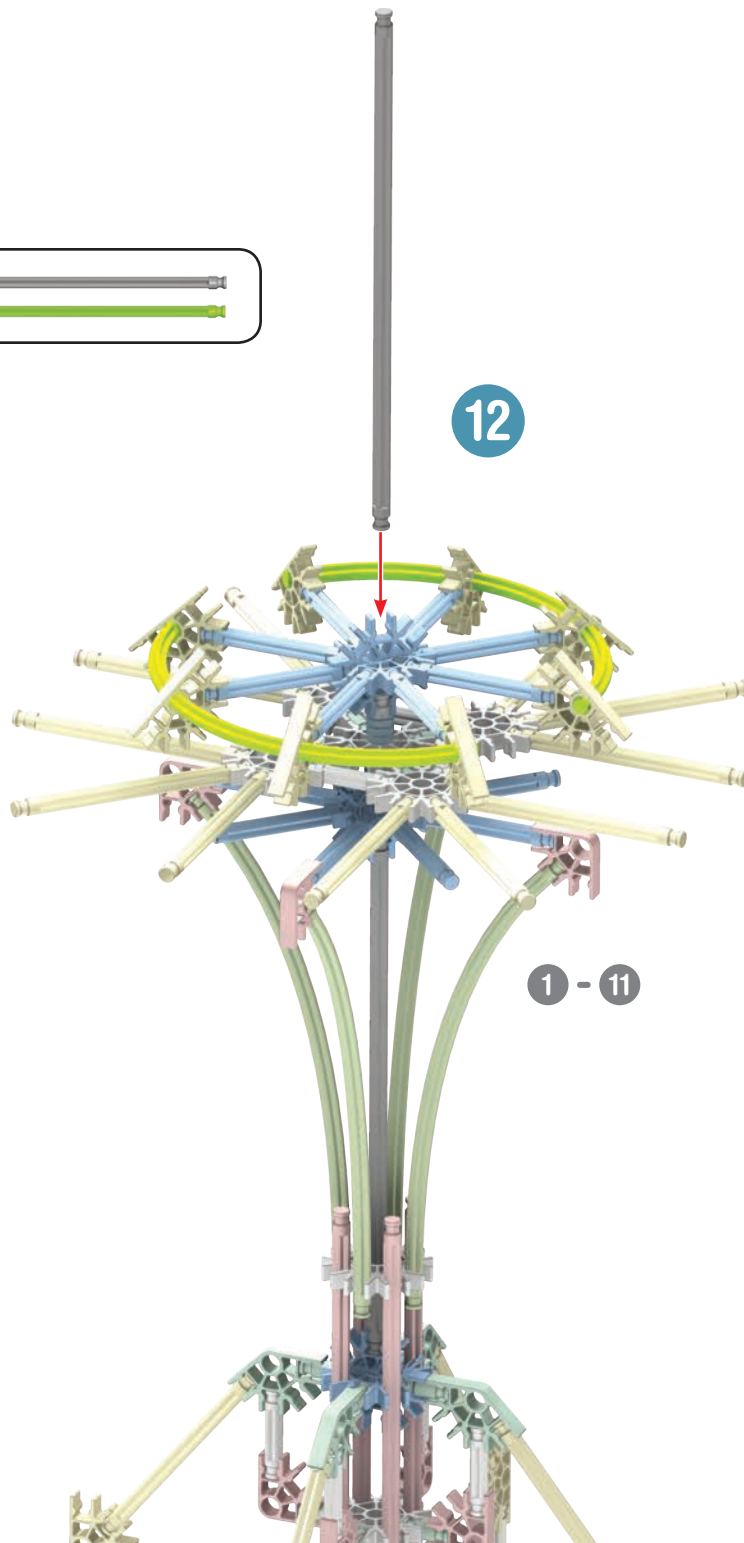

13

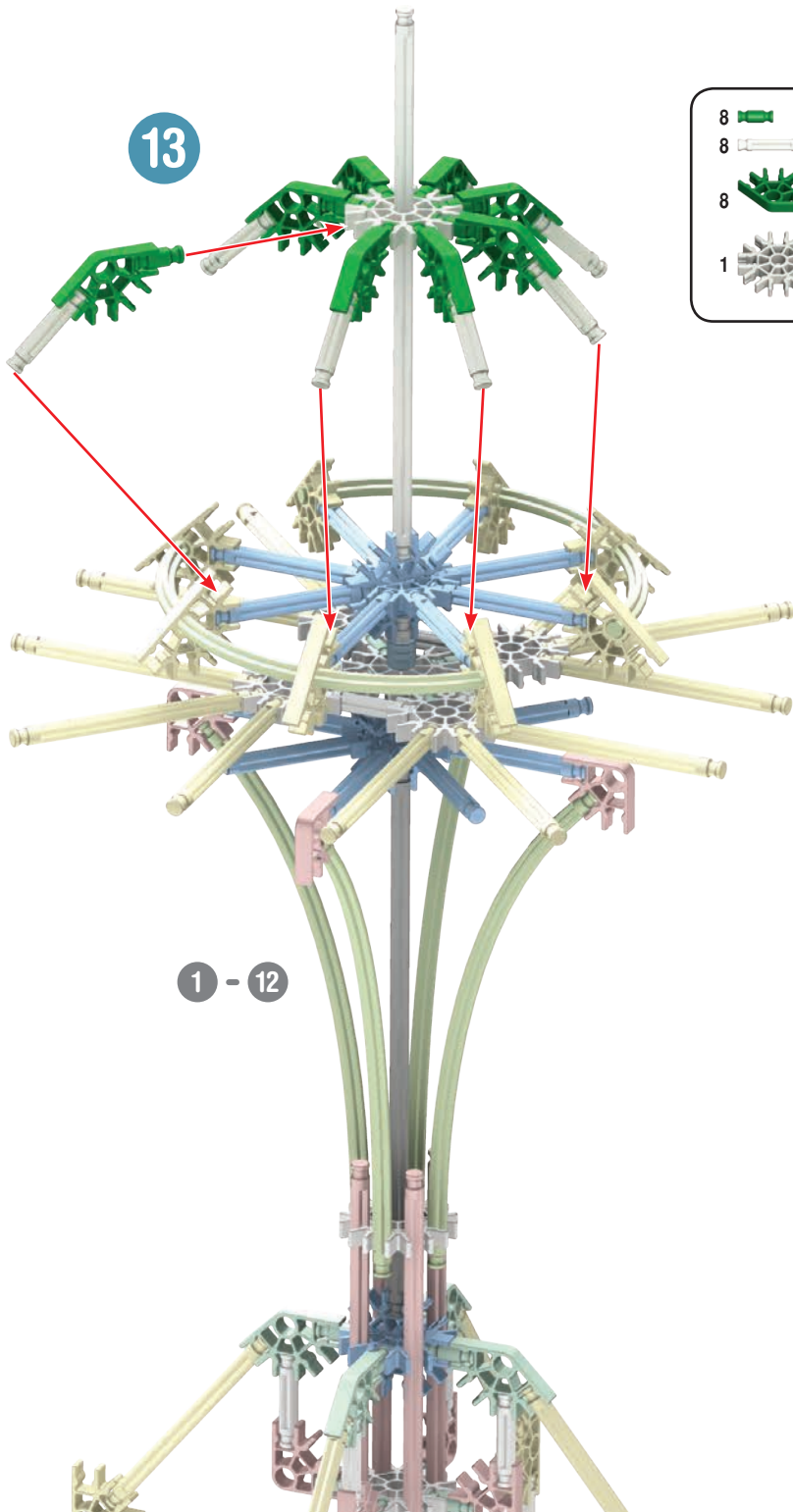

1 - 12

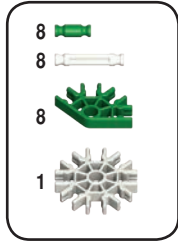

Observation Tower

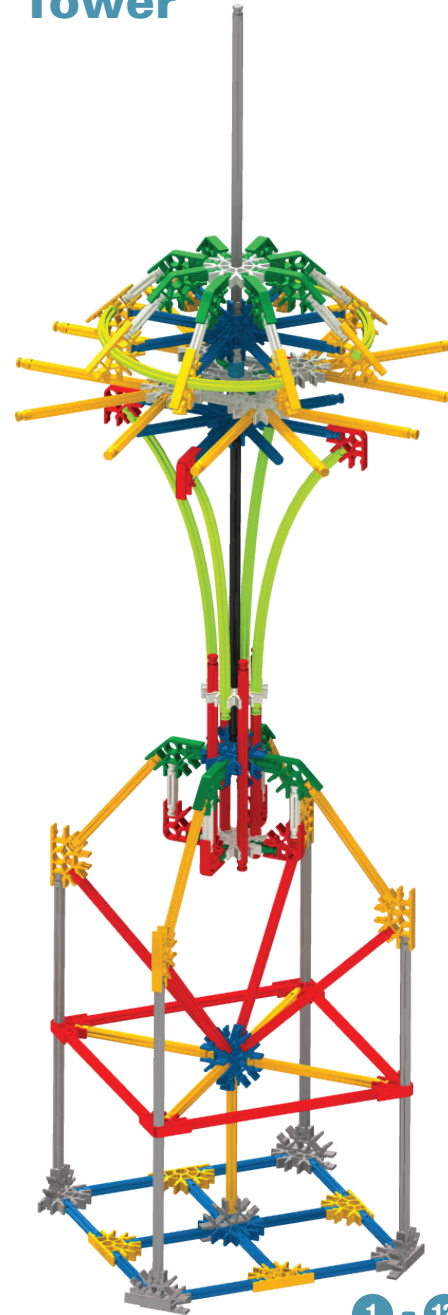

1 - 13

Palace

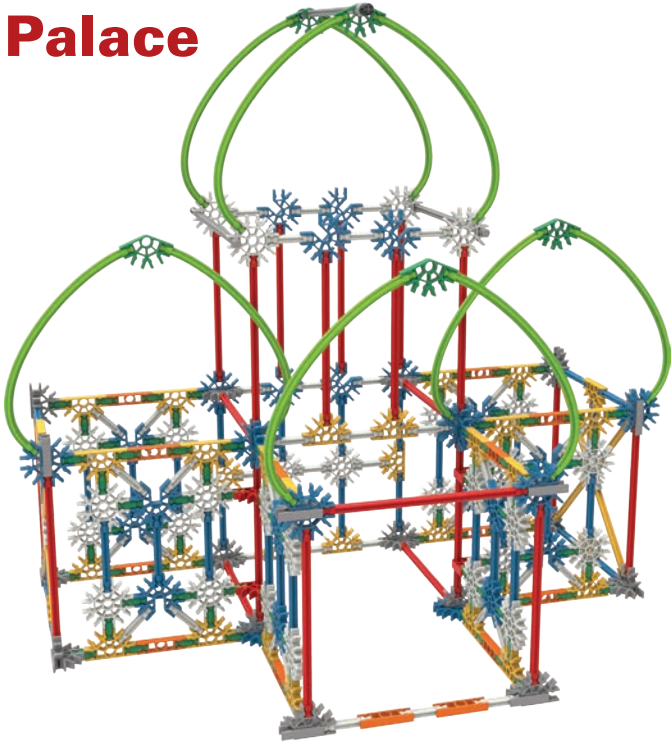

1

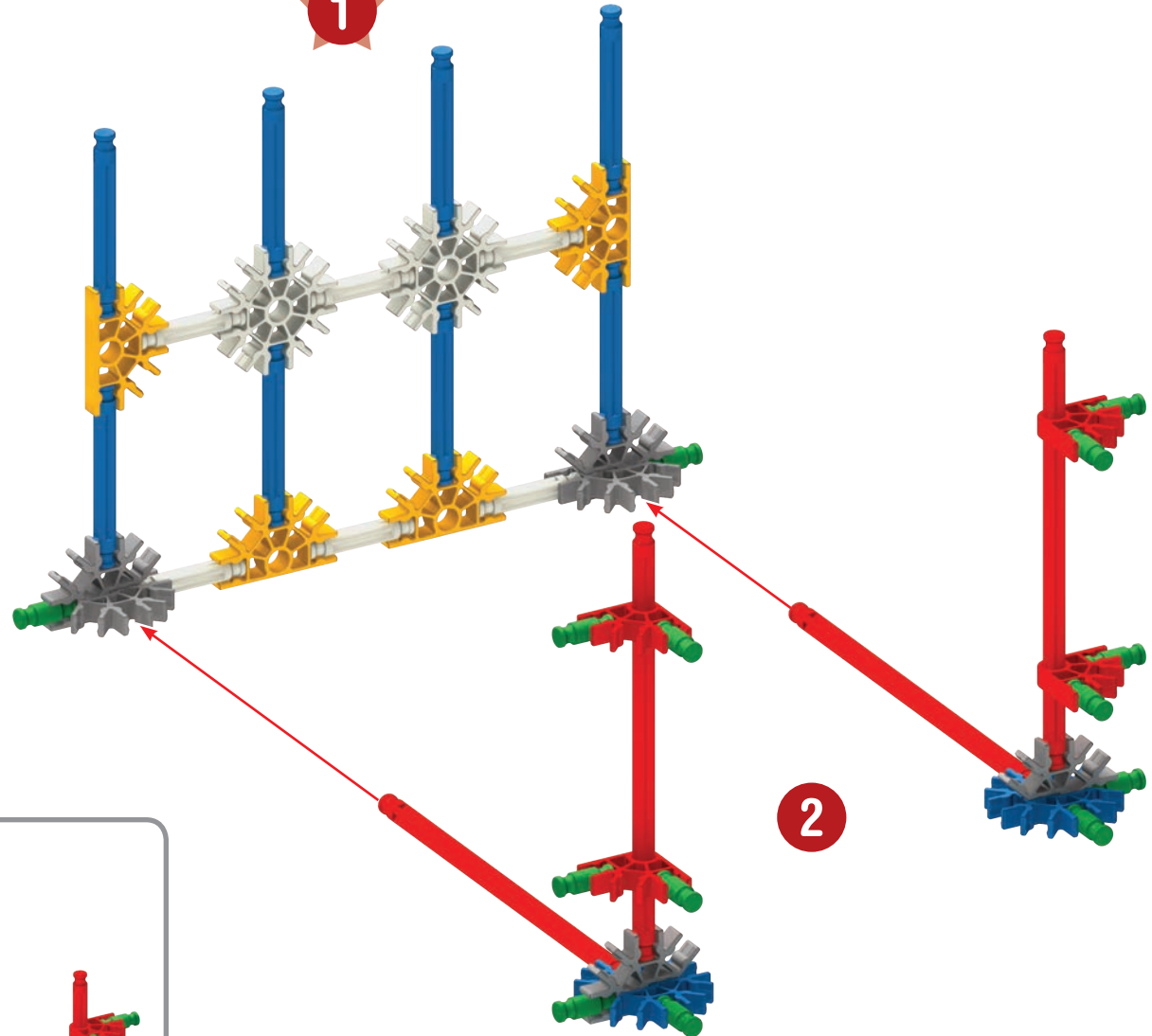

2

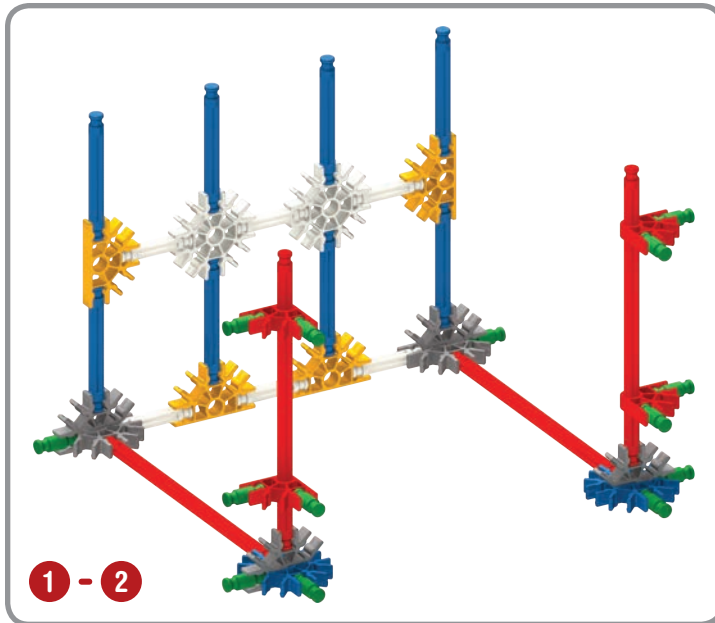

1 - 2

14		4		4	
6		8		4	
6		2		2	

3

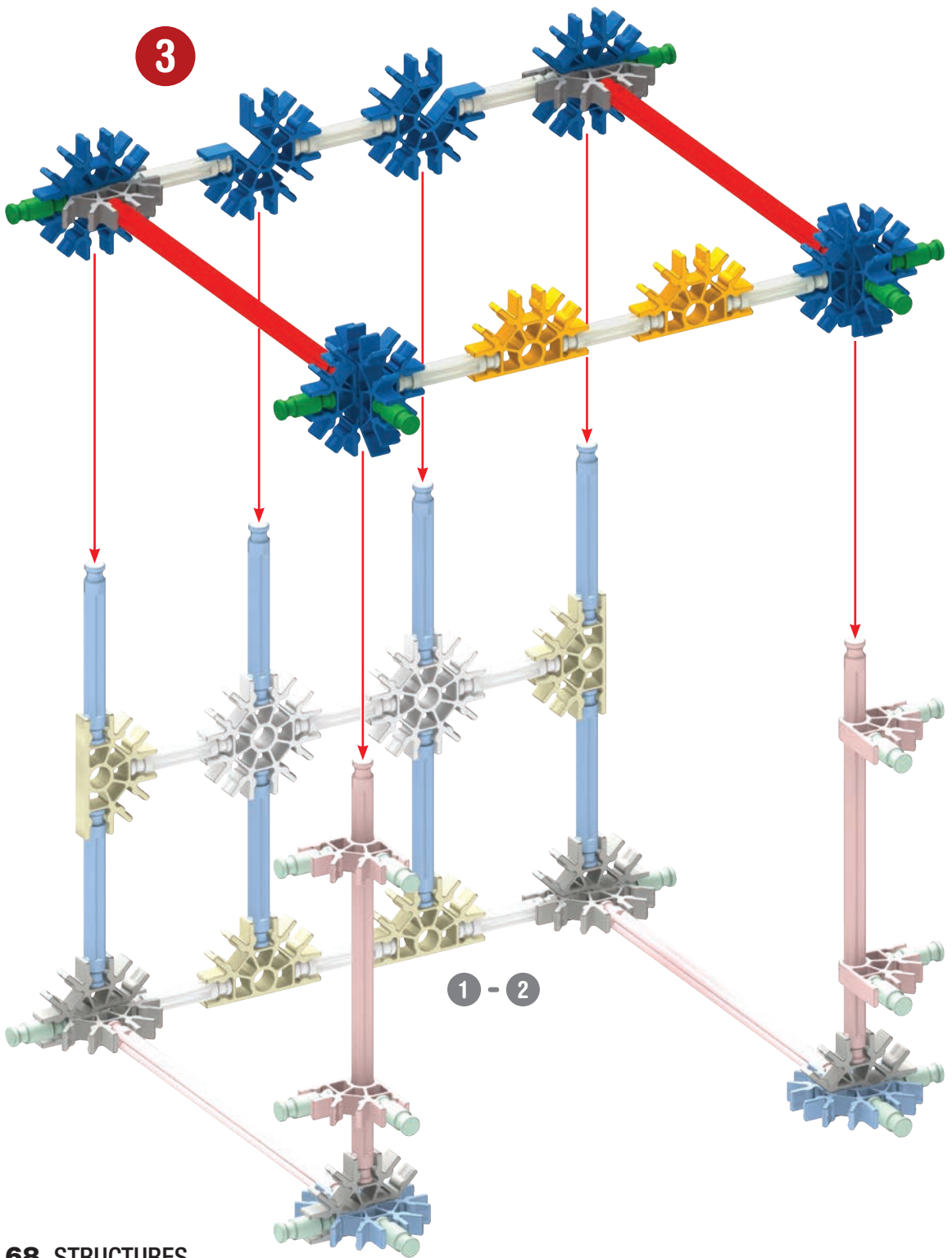

6		2	
6			
2			
2		8	

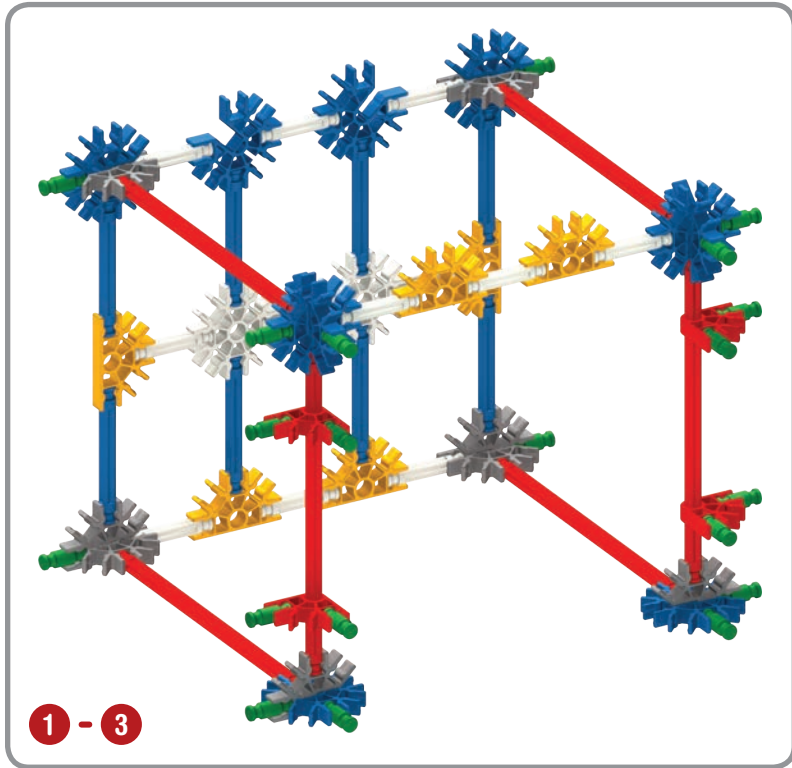

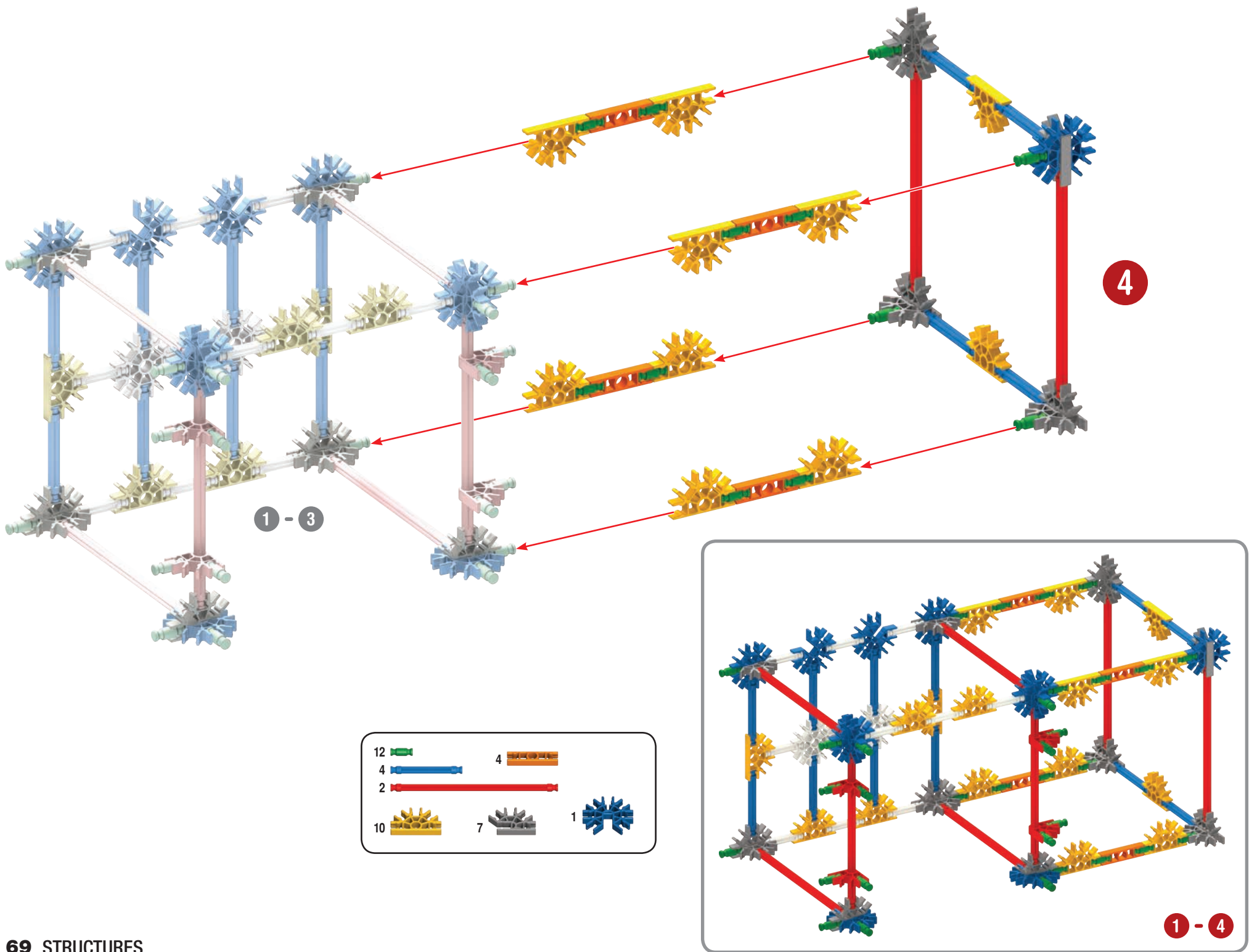

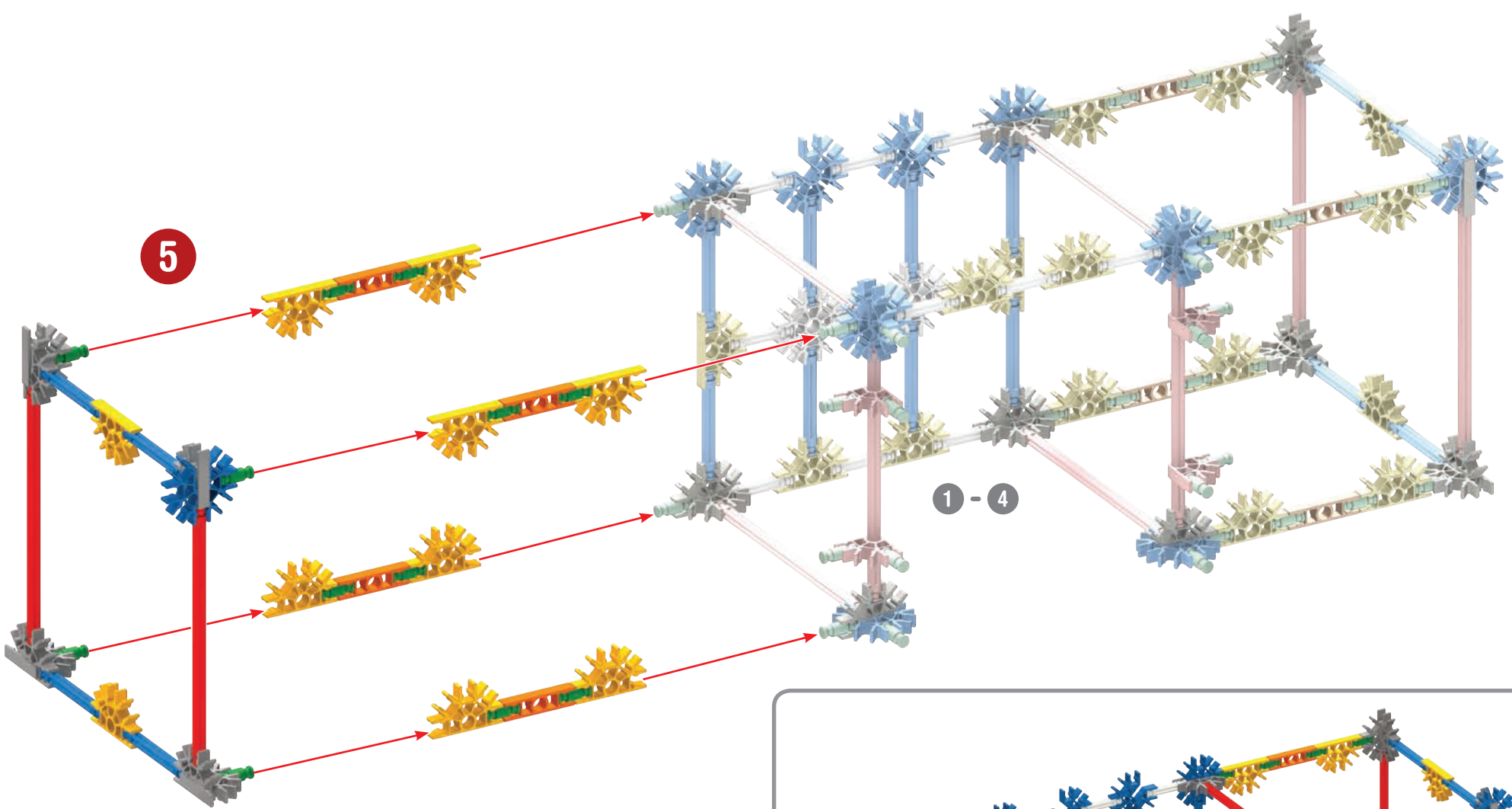

5

1 - 4

12		4	
4			
2			
10		7	
		1	

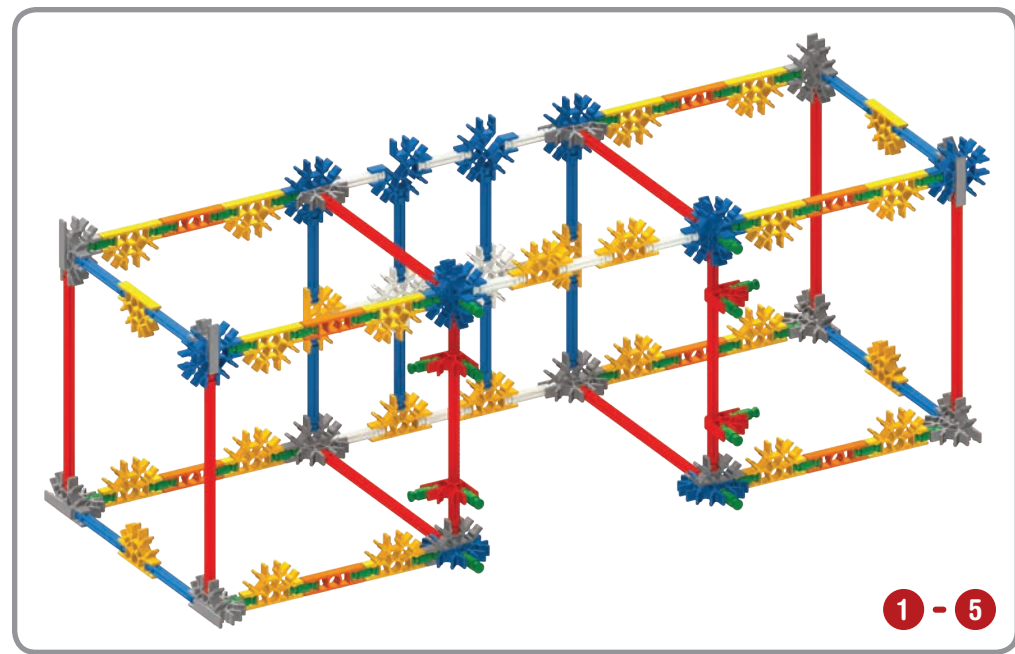

1 - 5

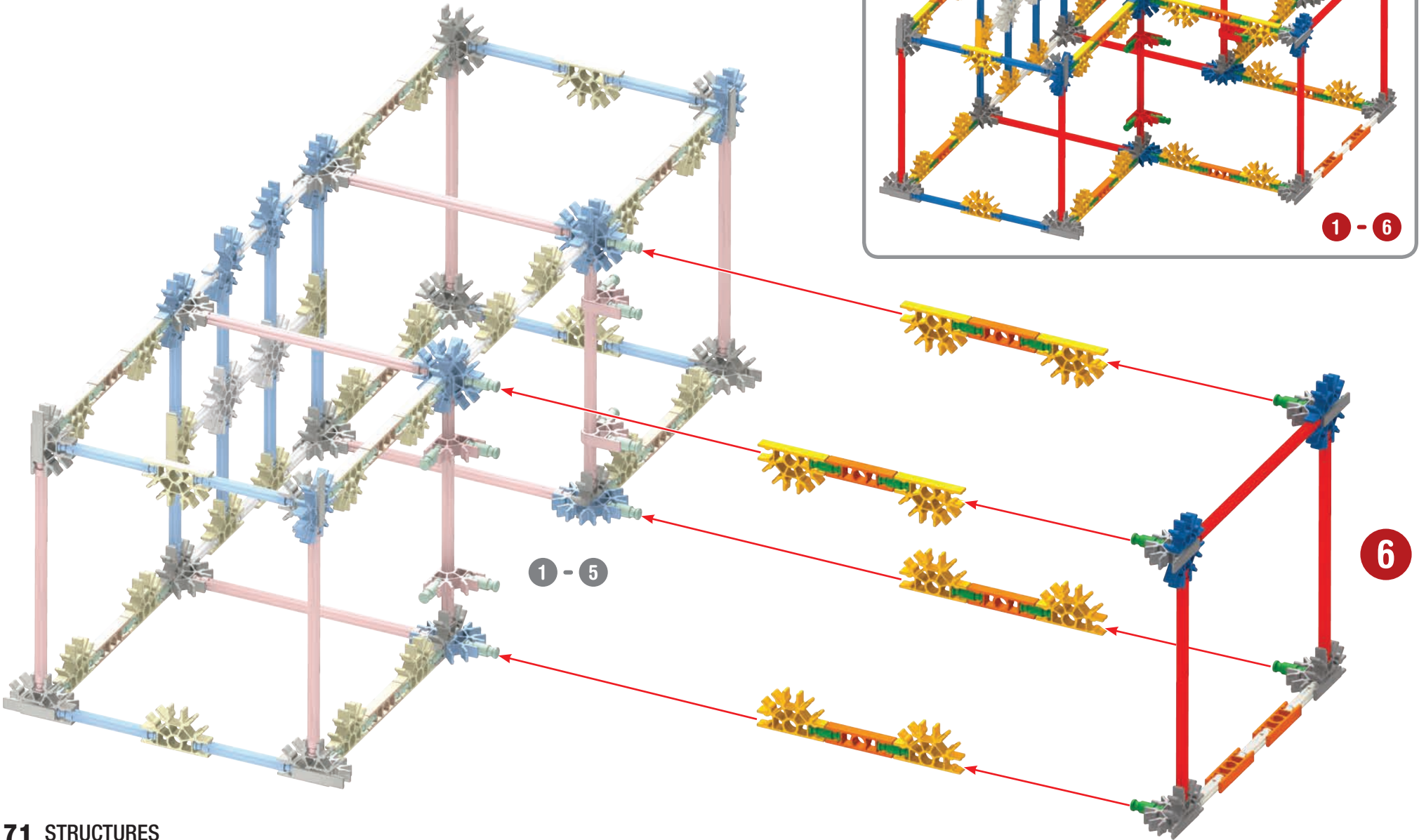
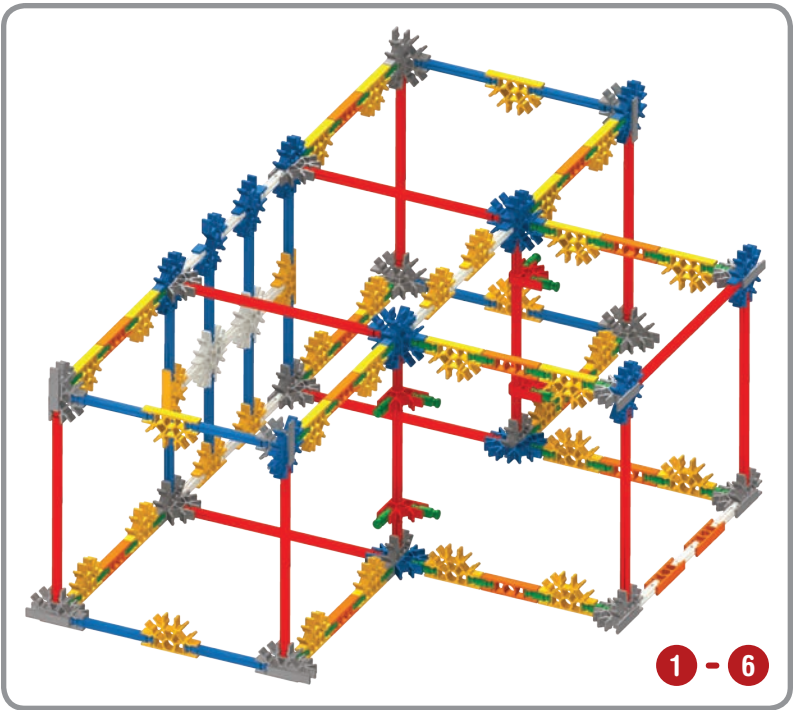
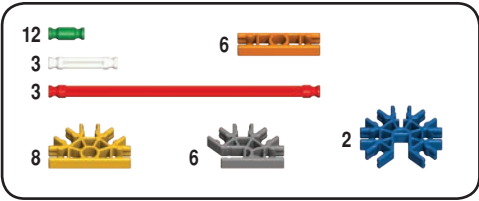

x2

7

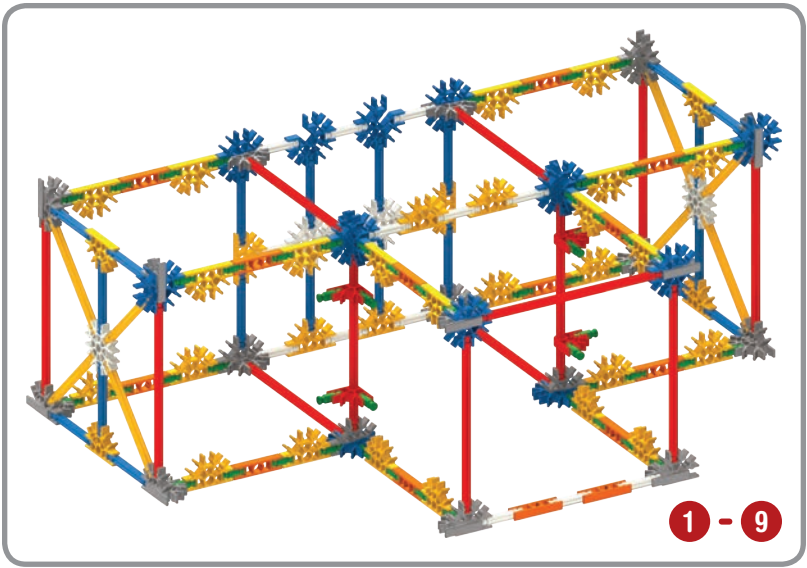
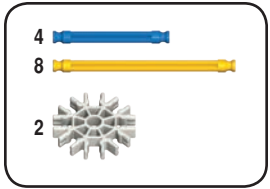
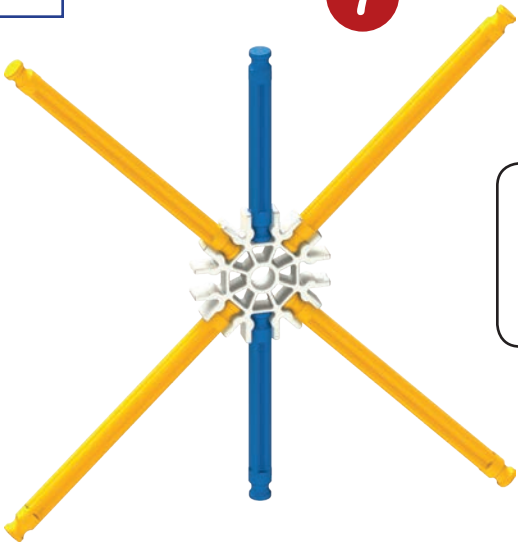

8

7

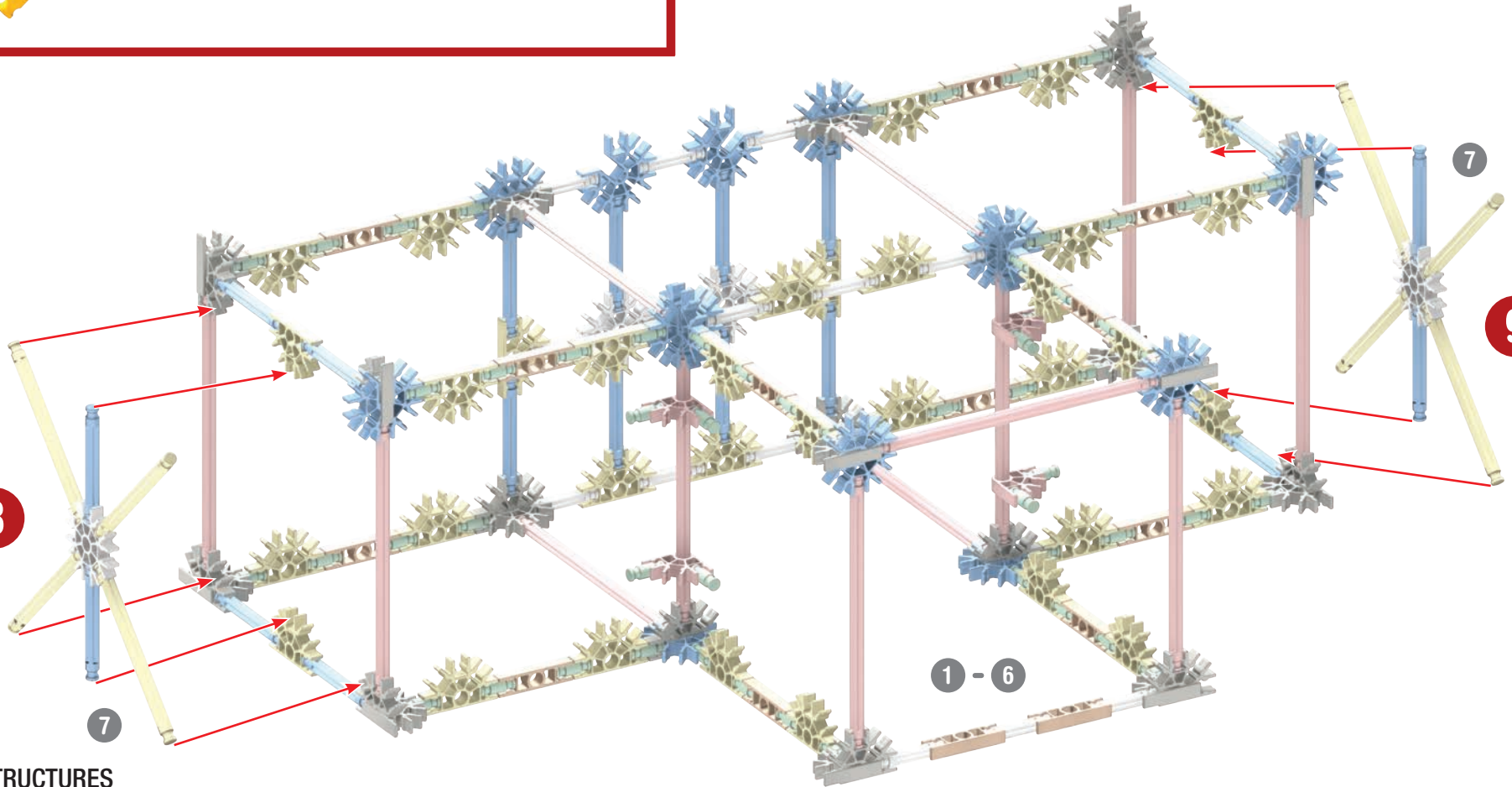

9

1 - 6

x6

10

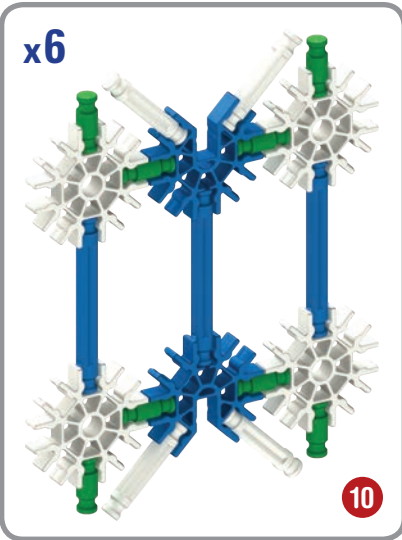
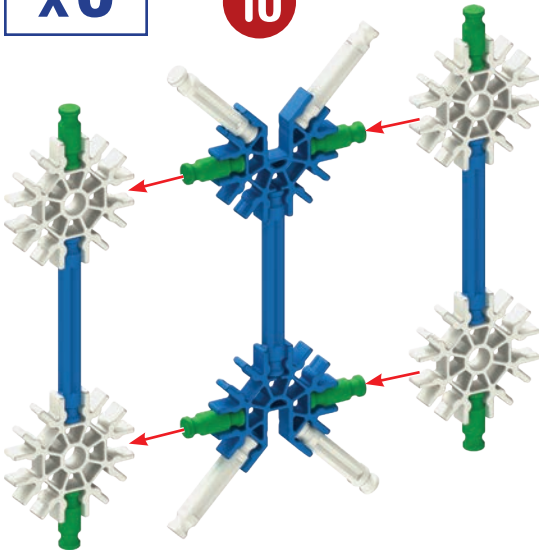

x6

10

- 48 12 24
- 24
- 18

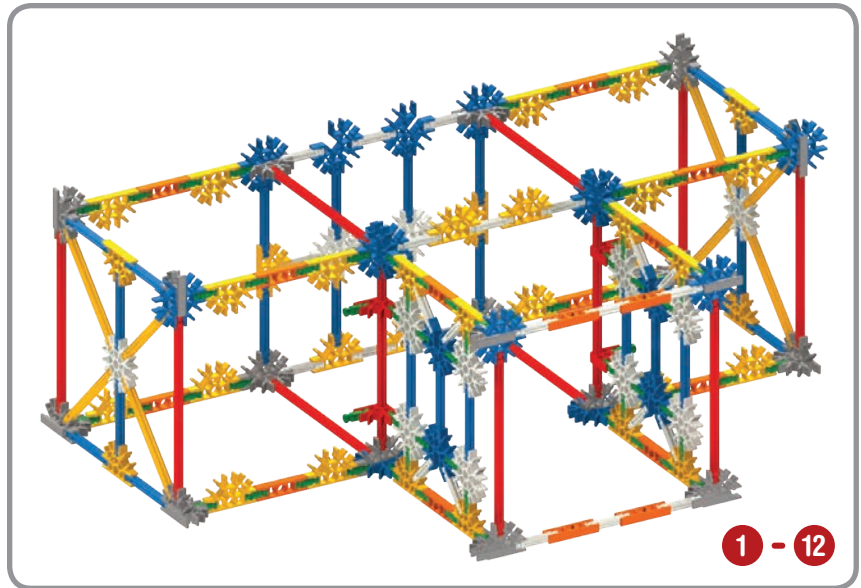
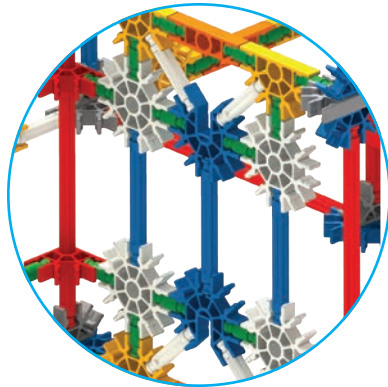
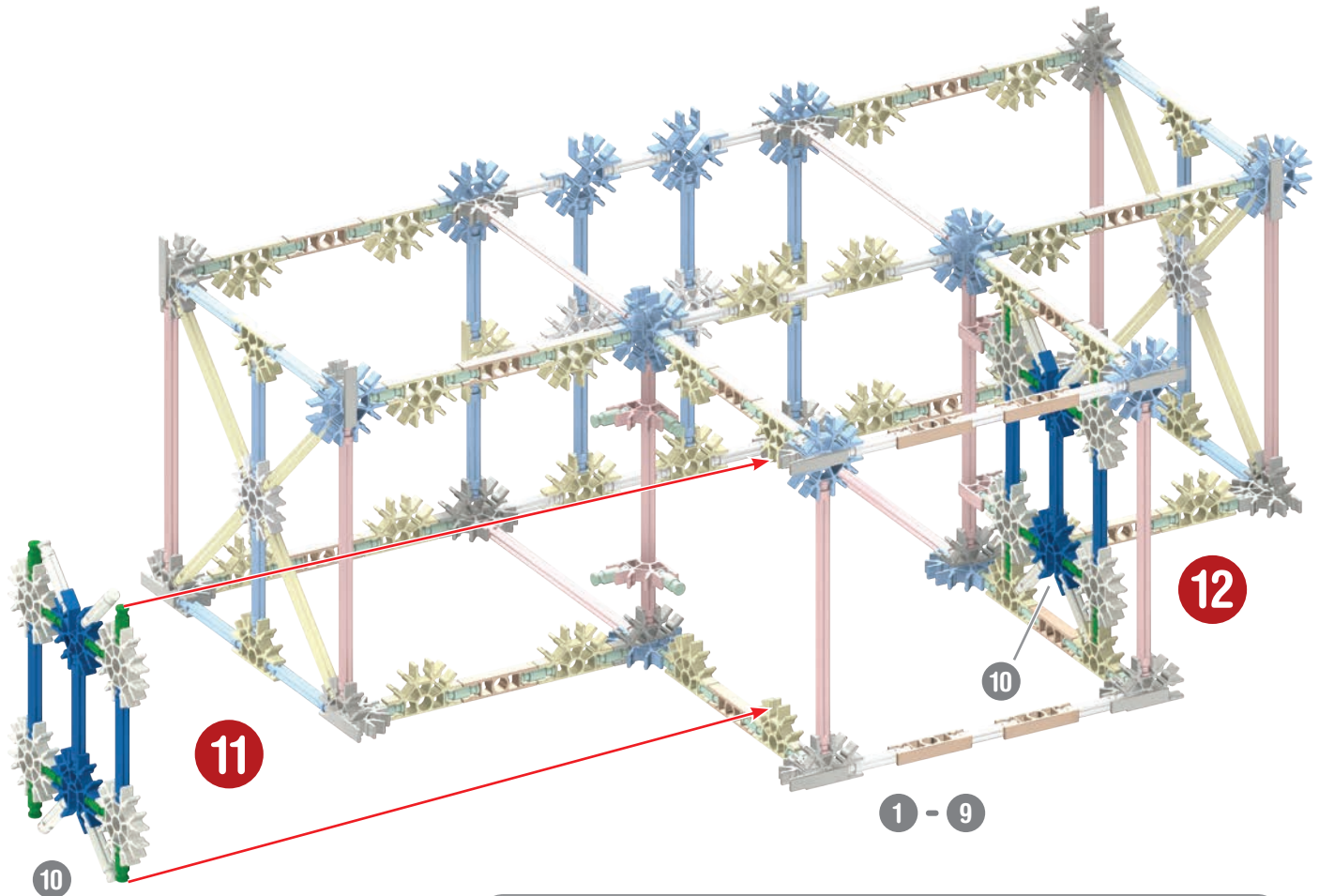

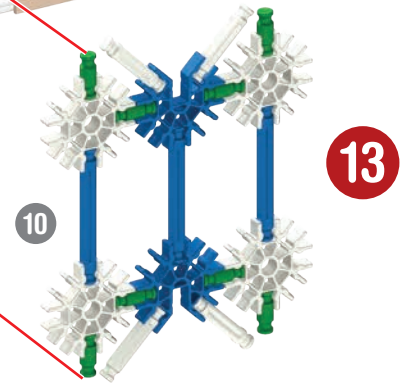
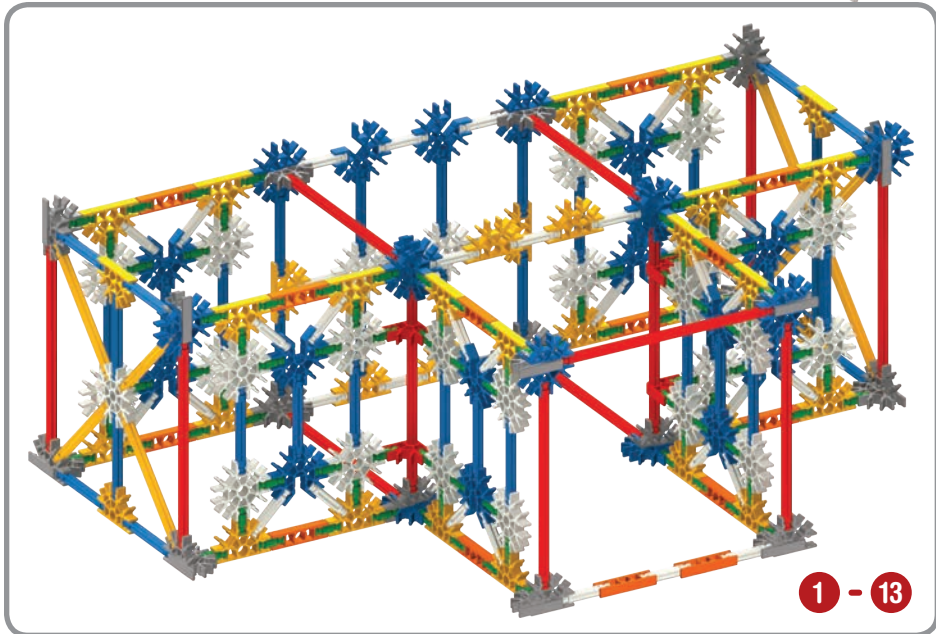
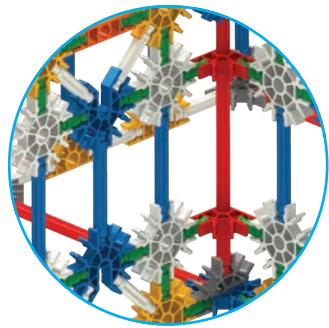
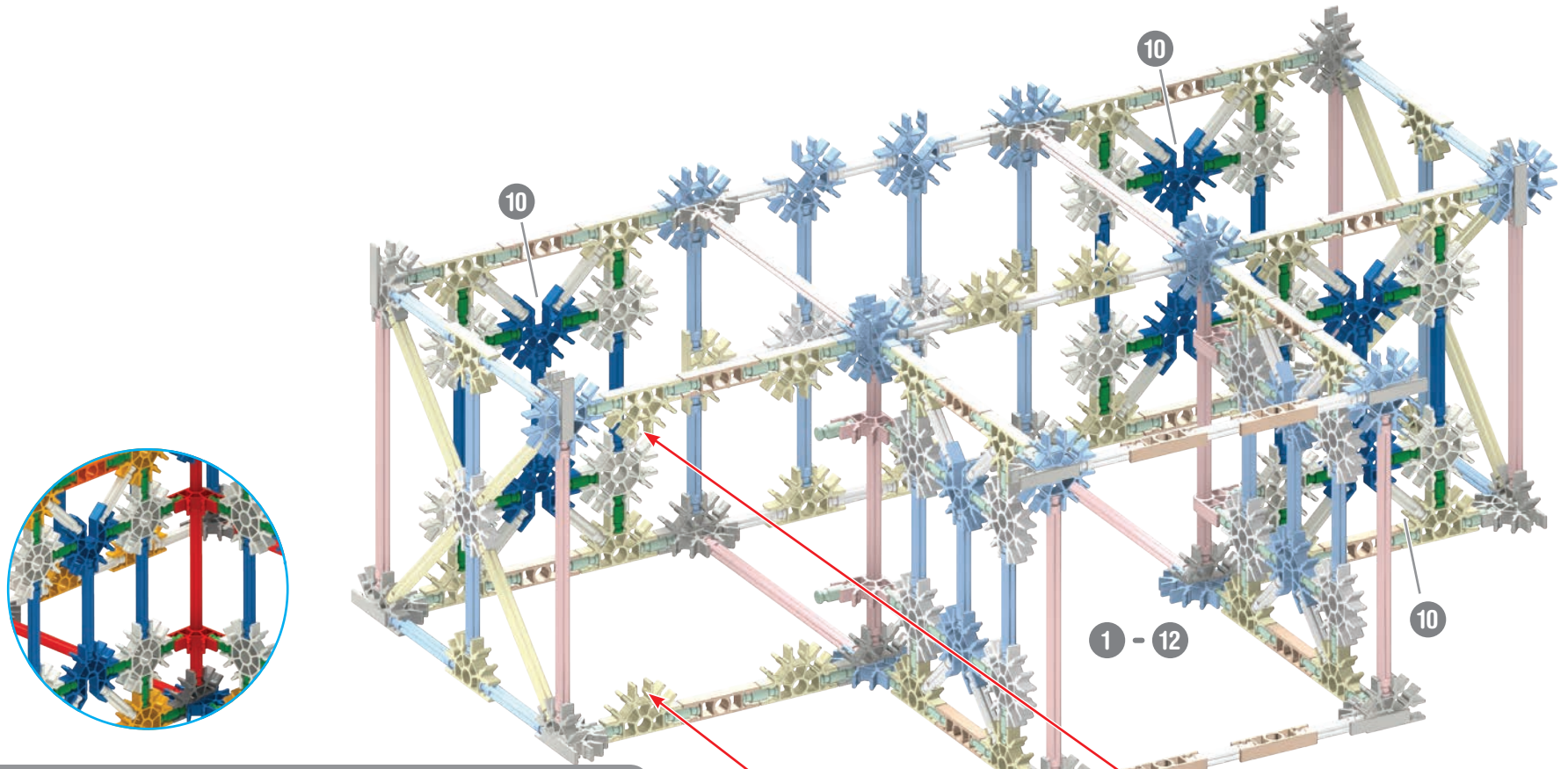

14

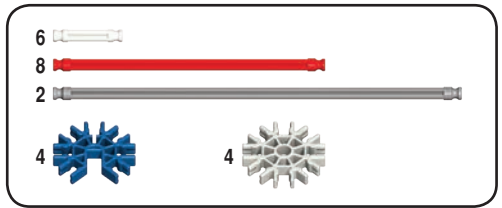
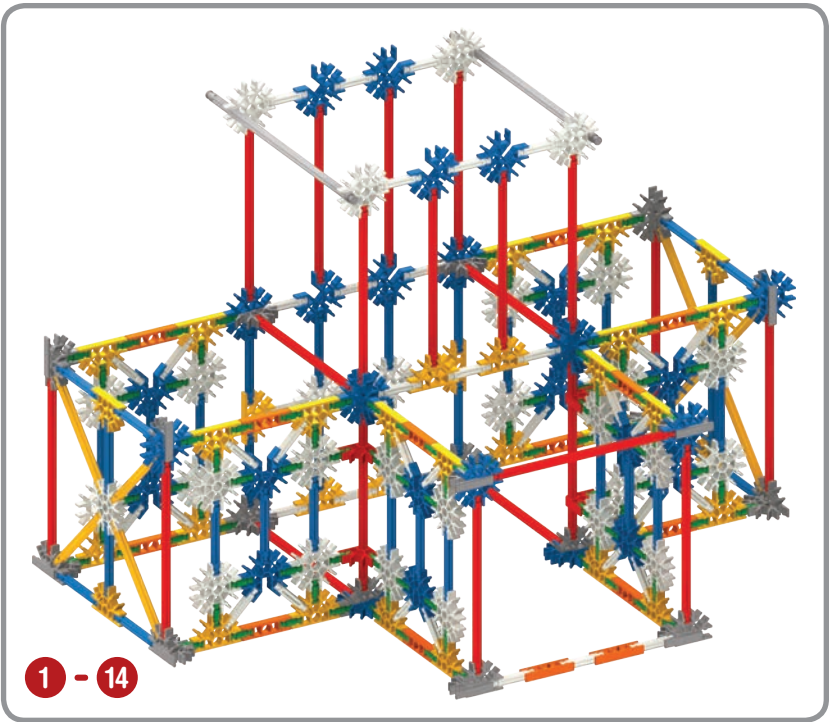
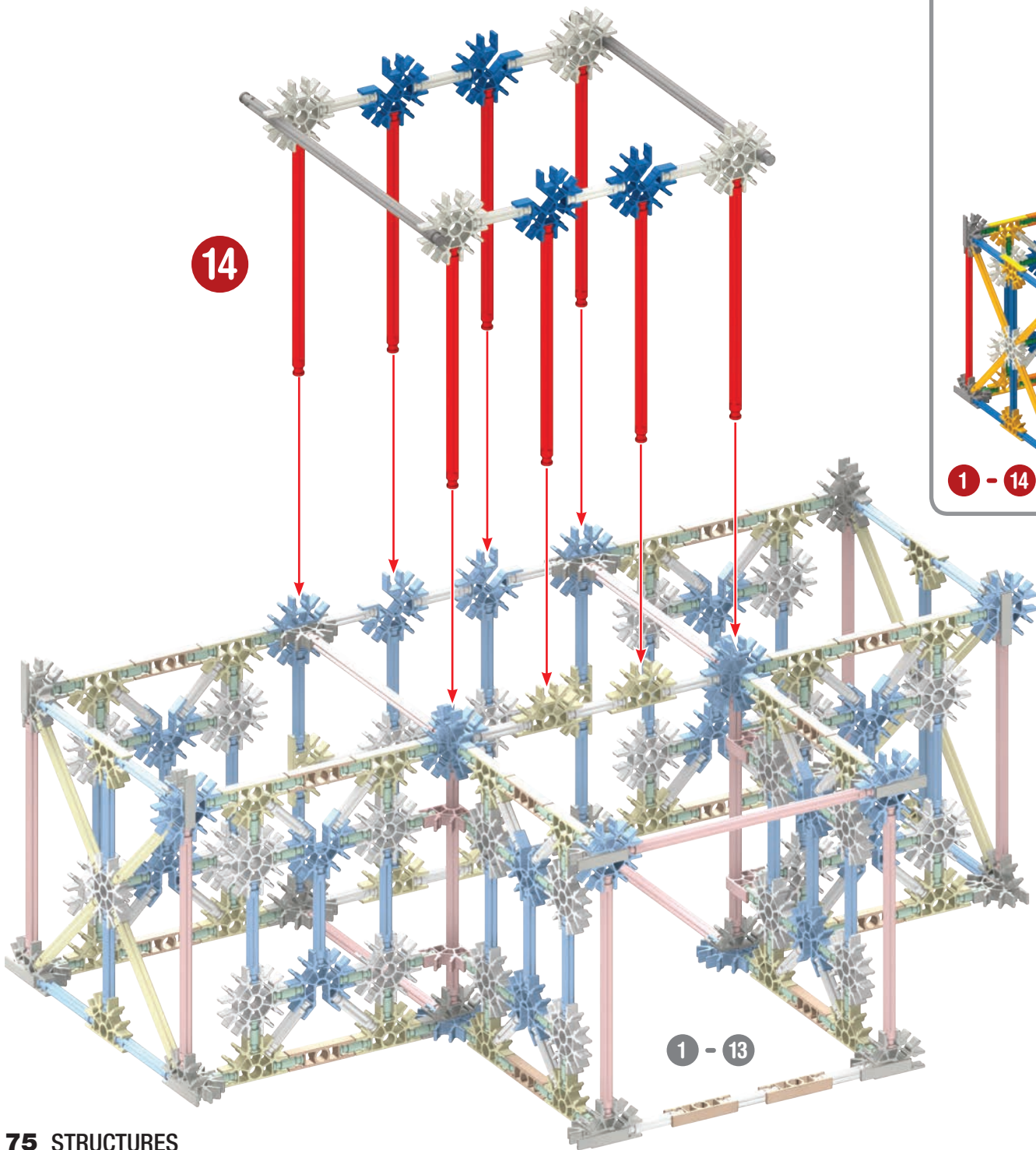

1 - 13

Palace

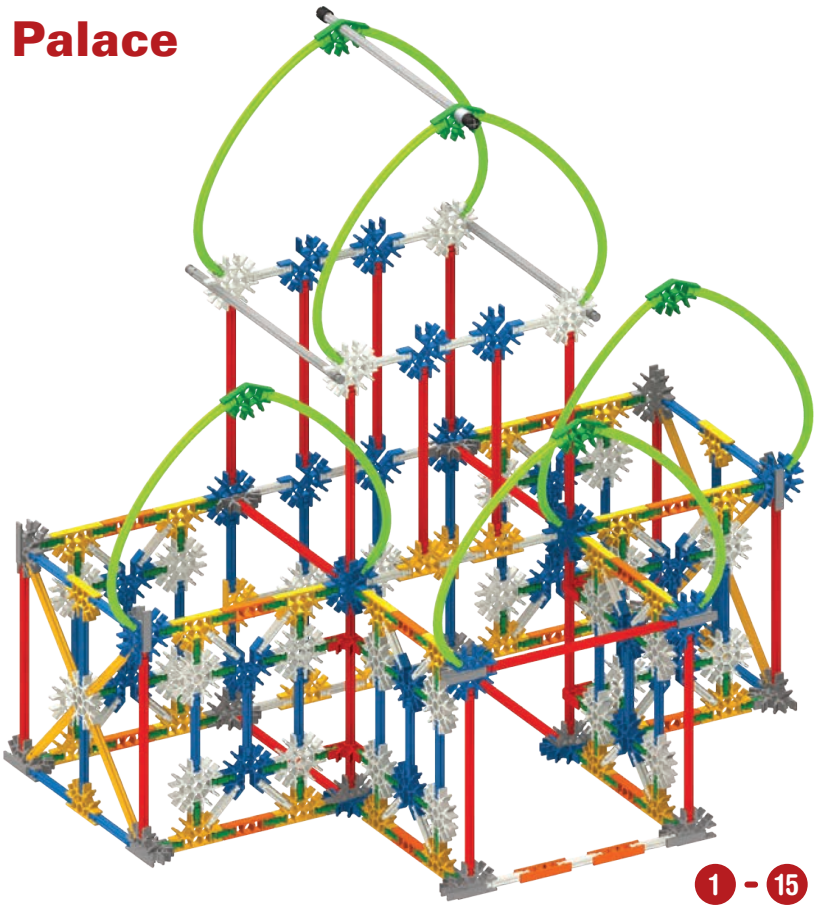

- 2
- 1
- 5
- 1
- 10

1 - 14

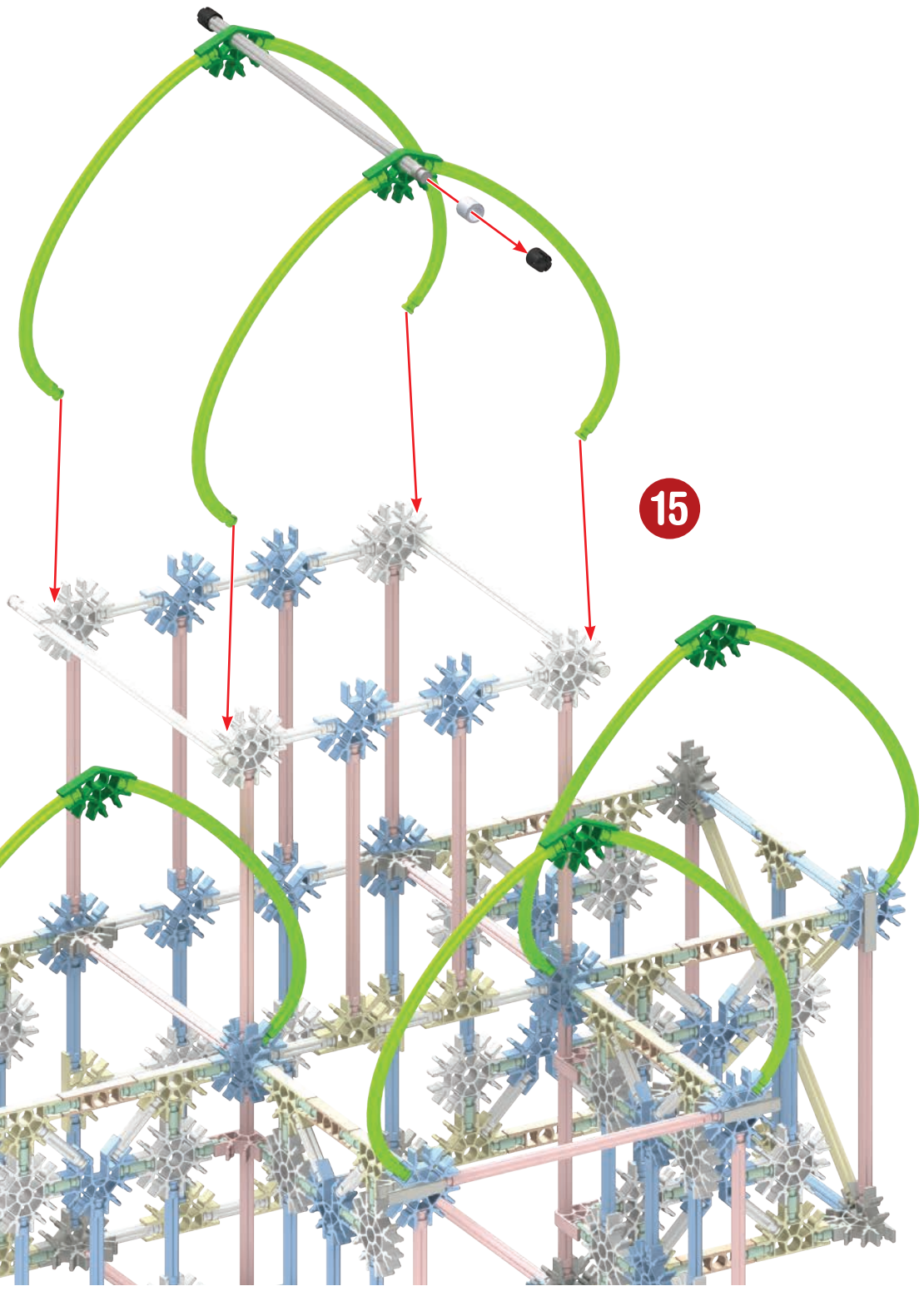

Pyramid

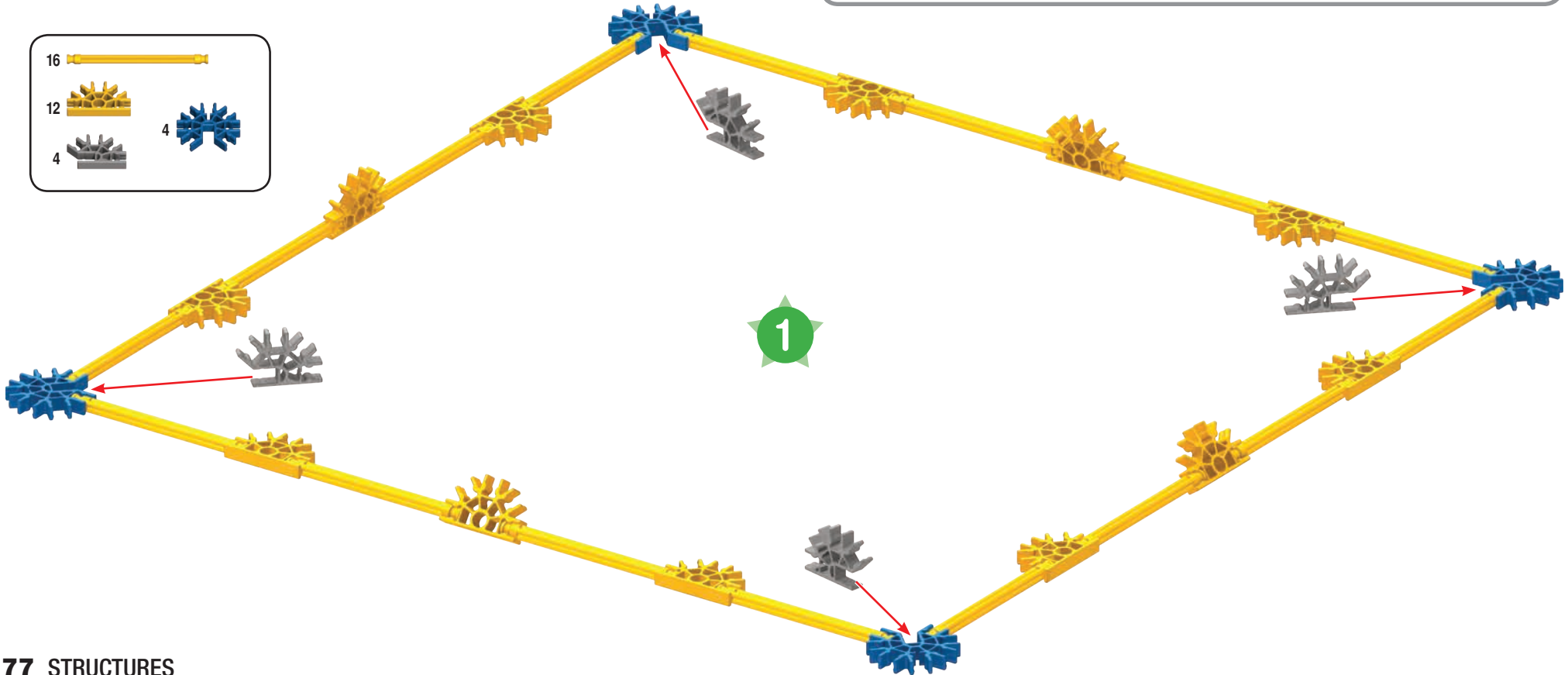
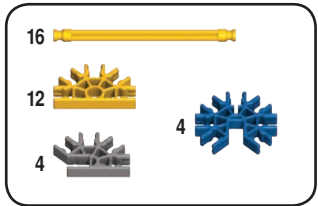
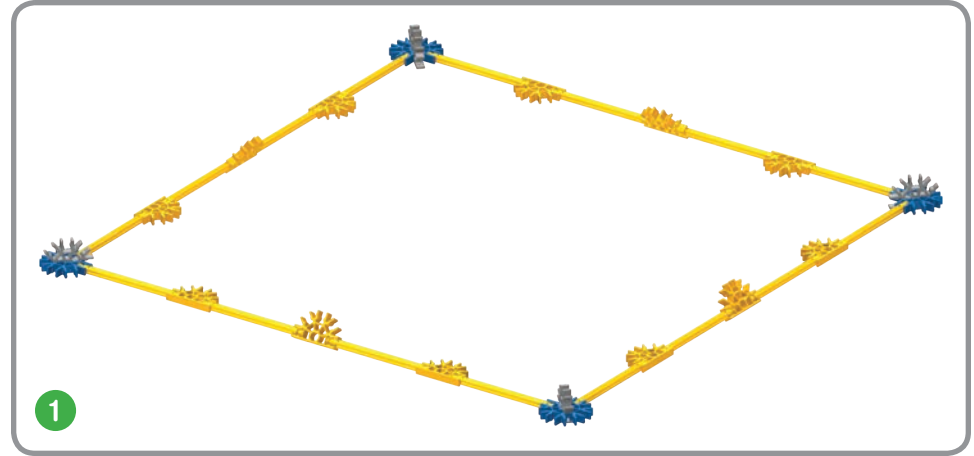
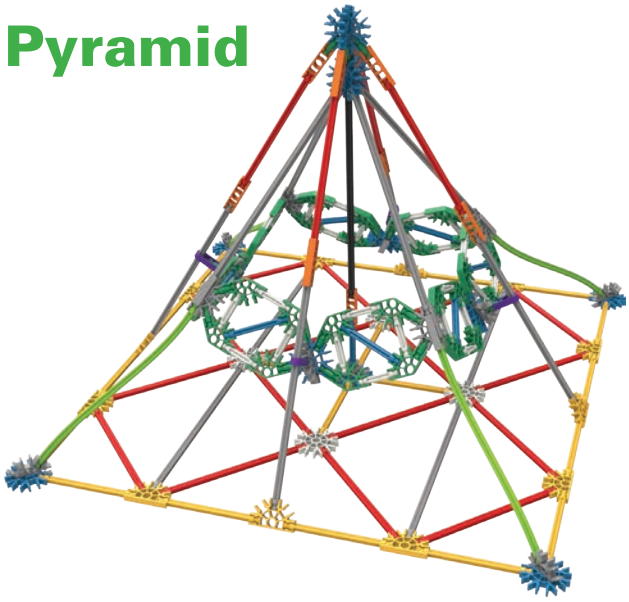

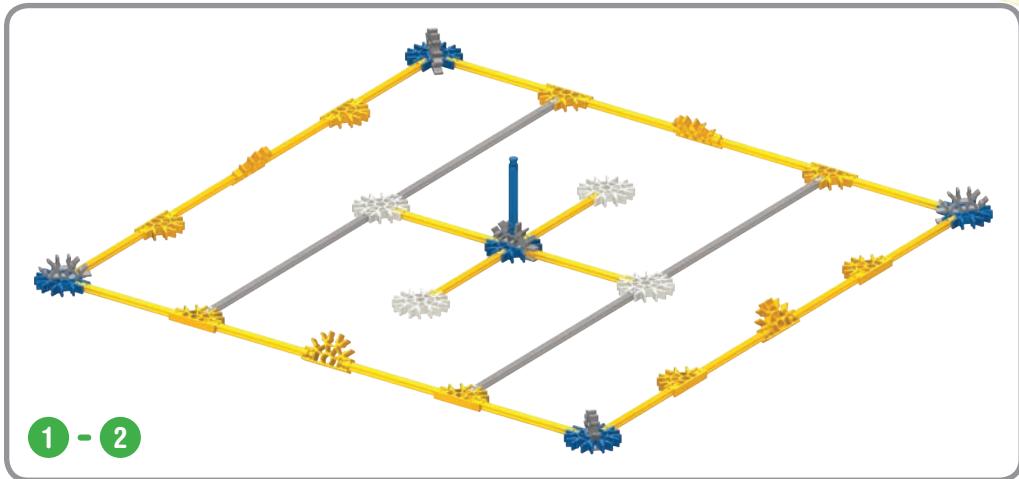
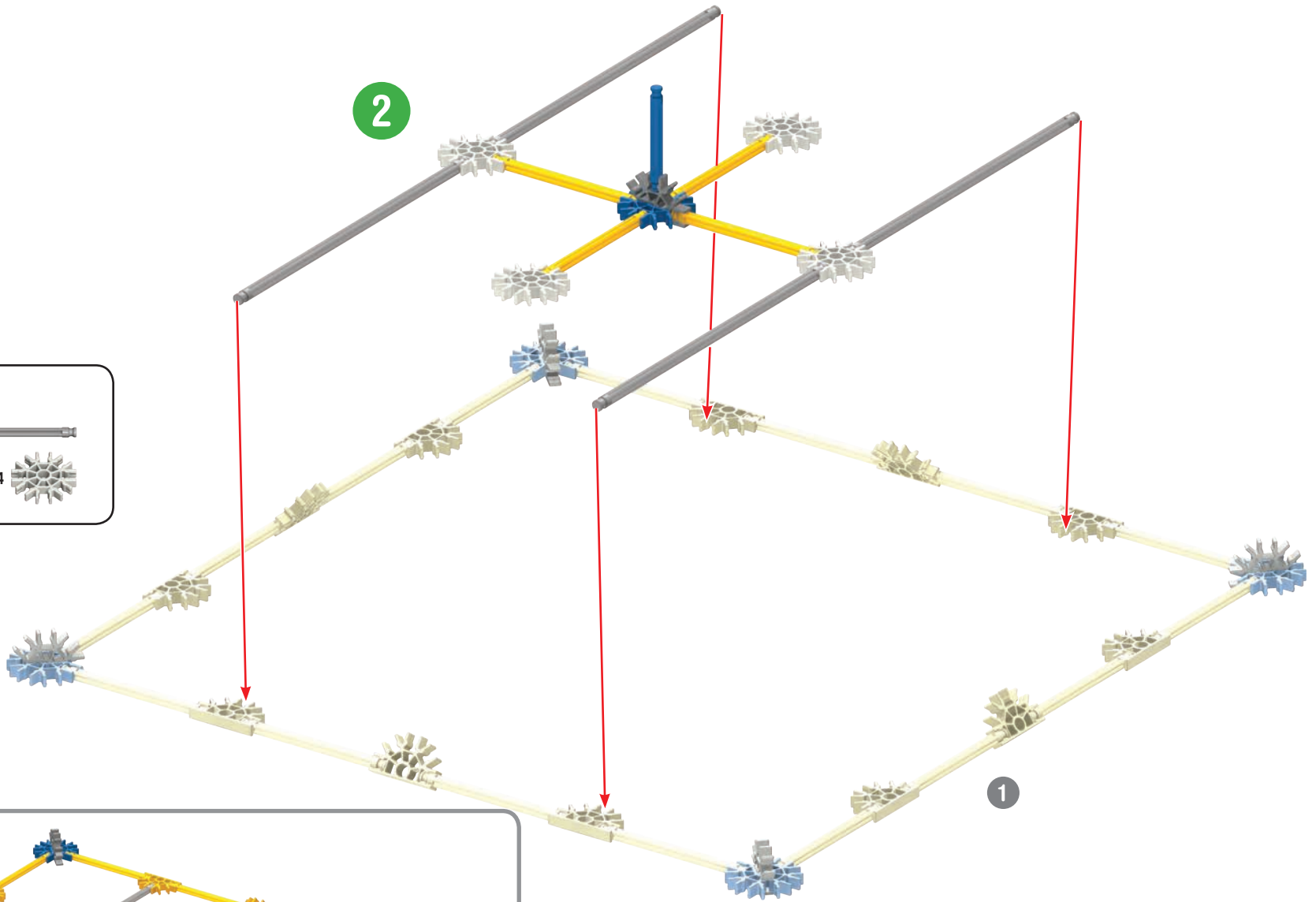
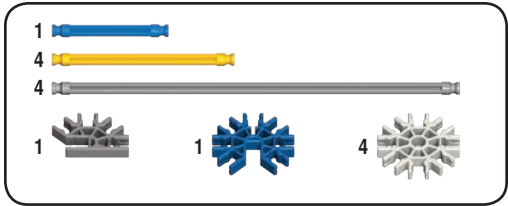

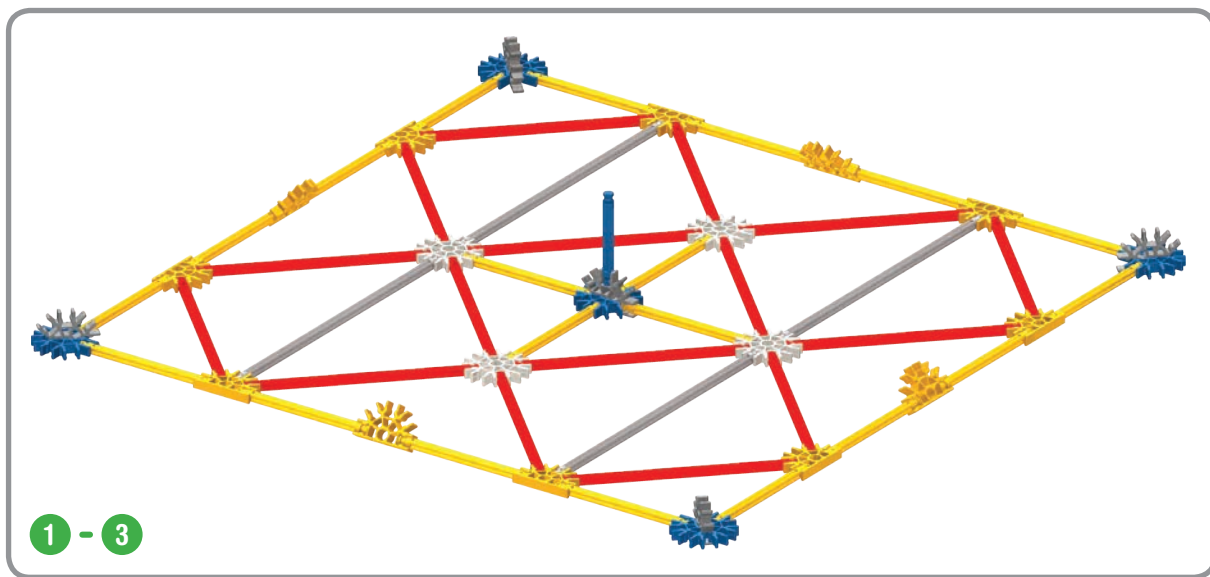
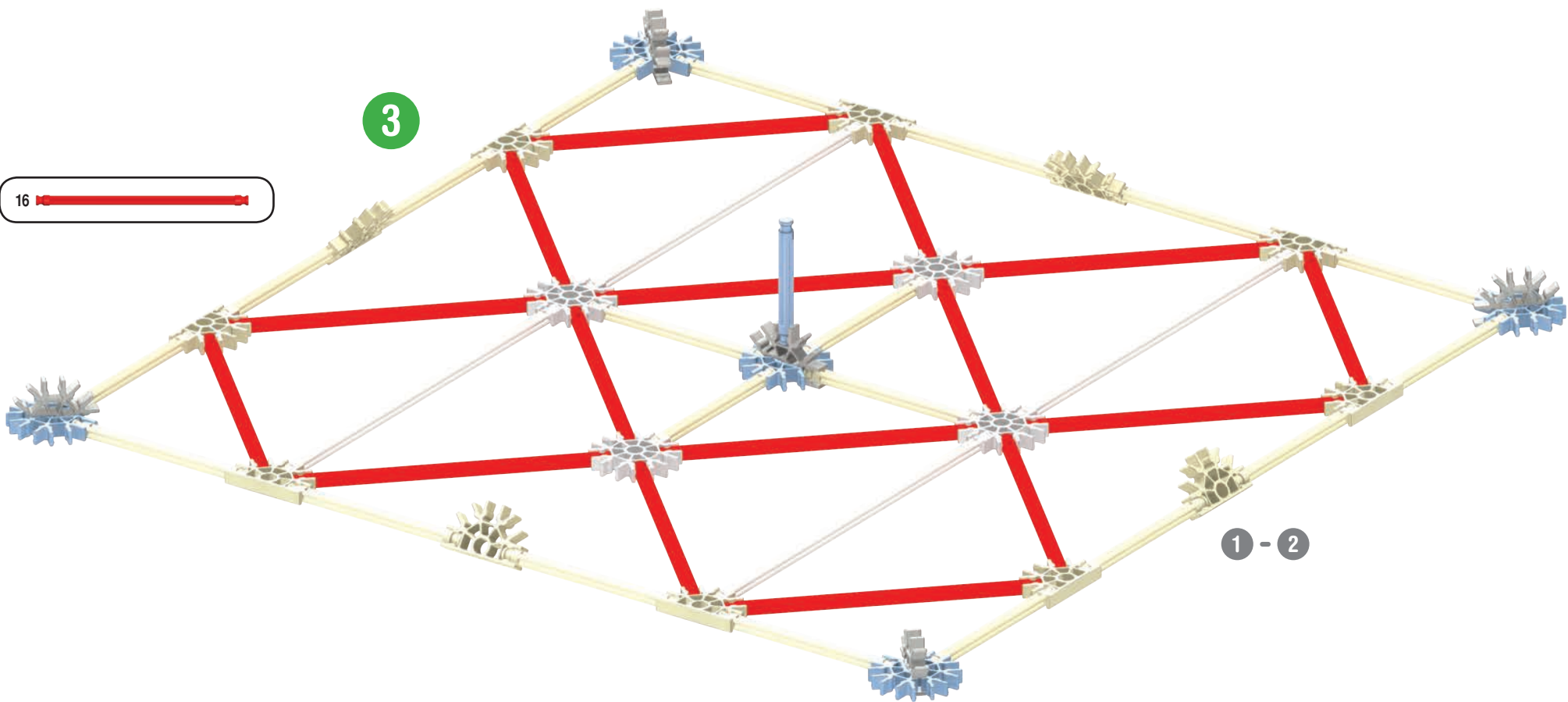

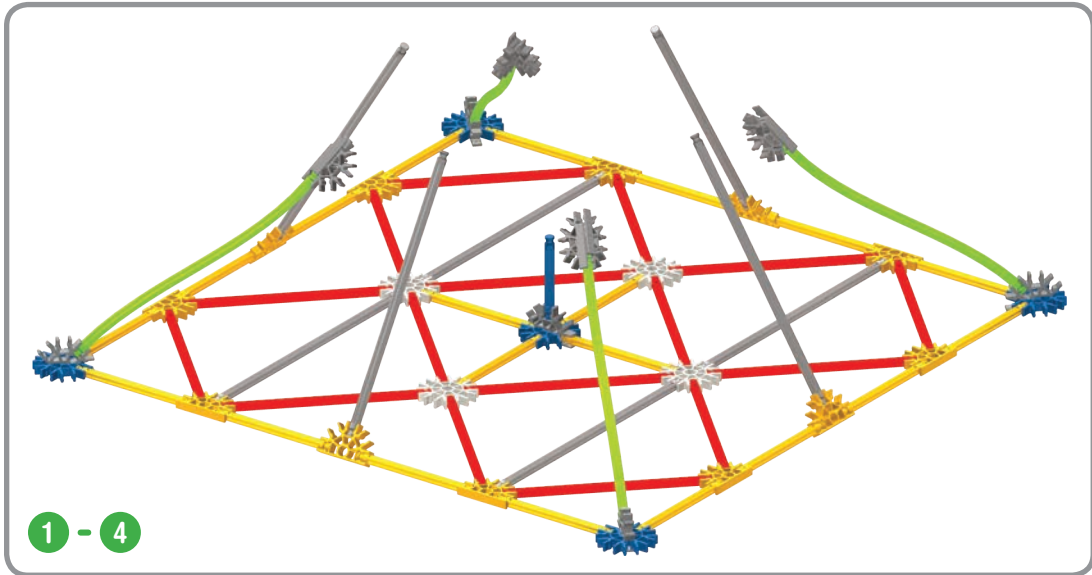
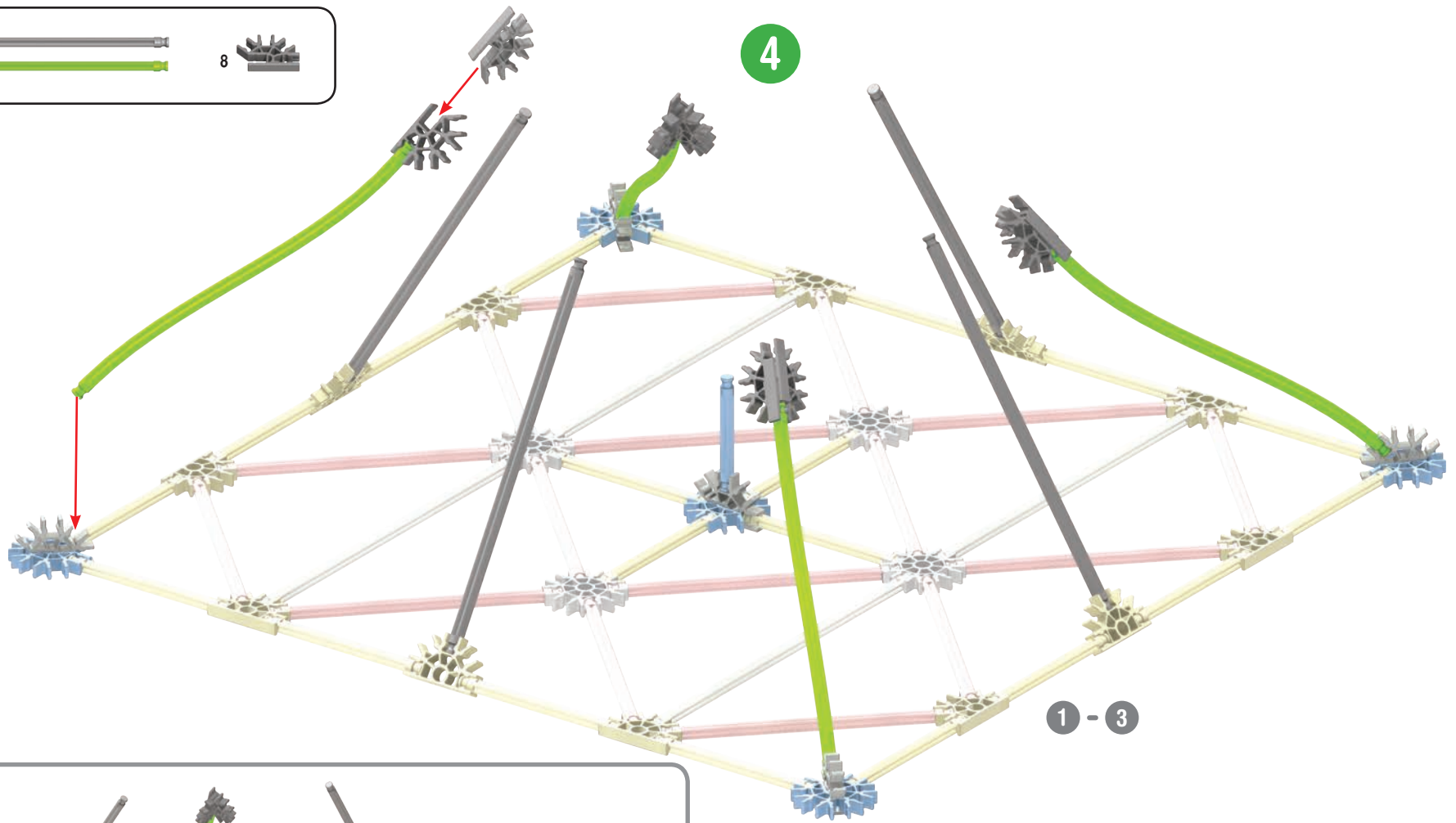

x4

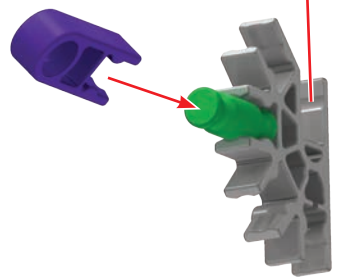
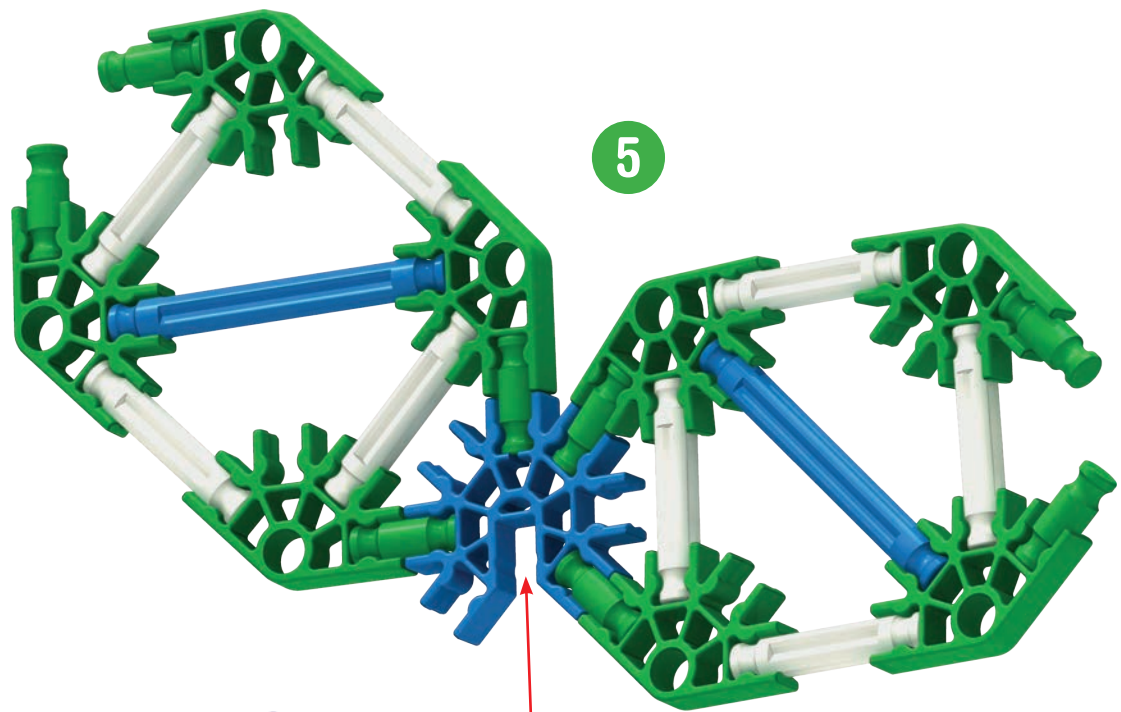

- | | | | | | |
|----|--|---|--|---|--|
| 36 | | 4 | | 4 | |
| 32 | | | | | |
| 8 | | | | | |
| 32 | | 4 | | | |

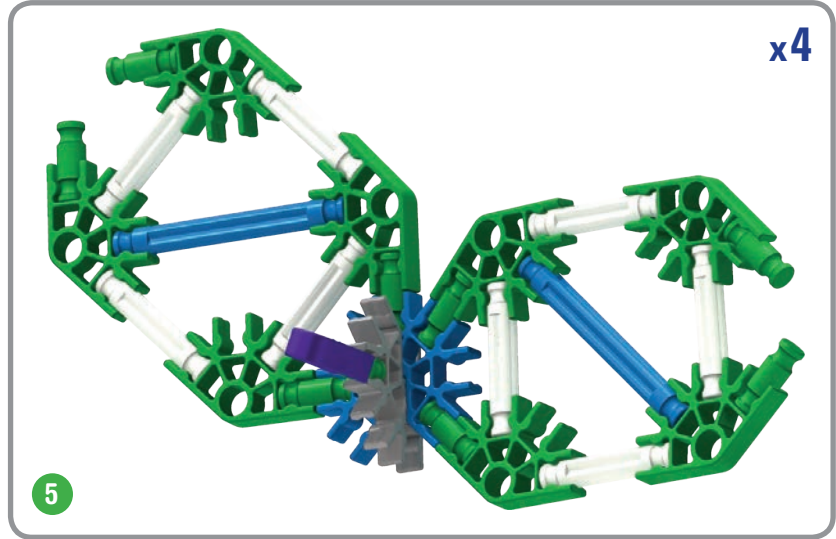

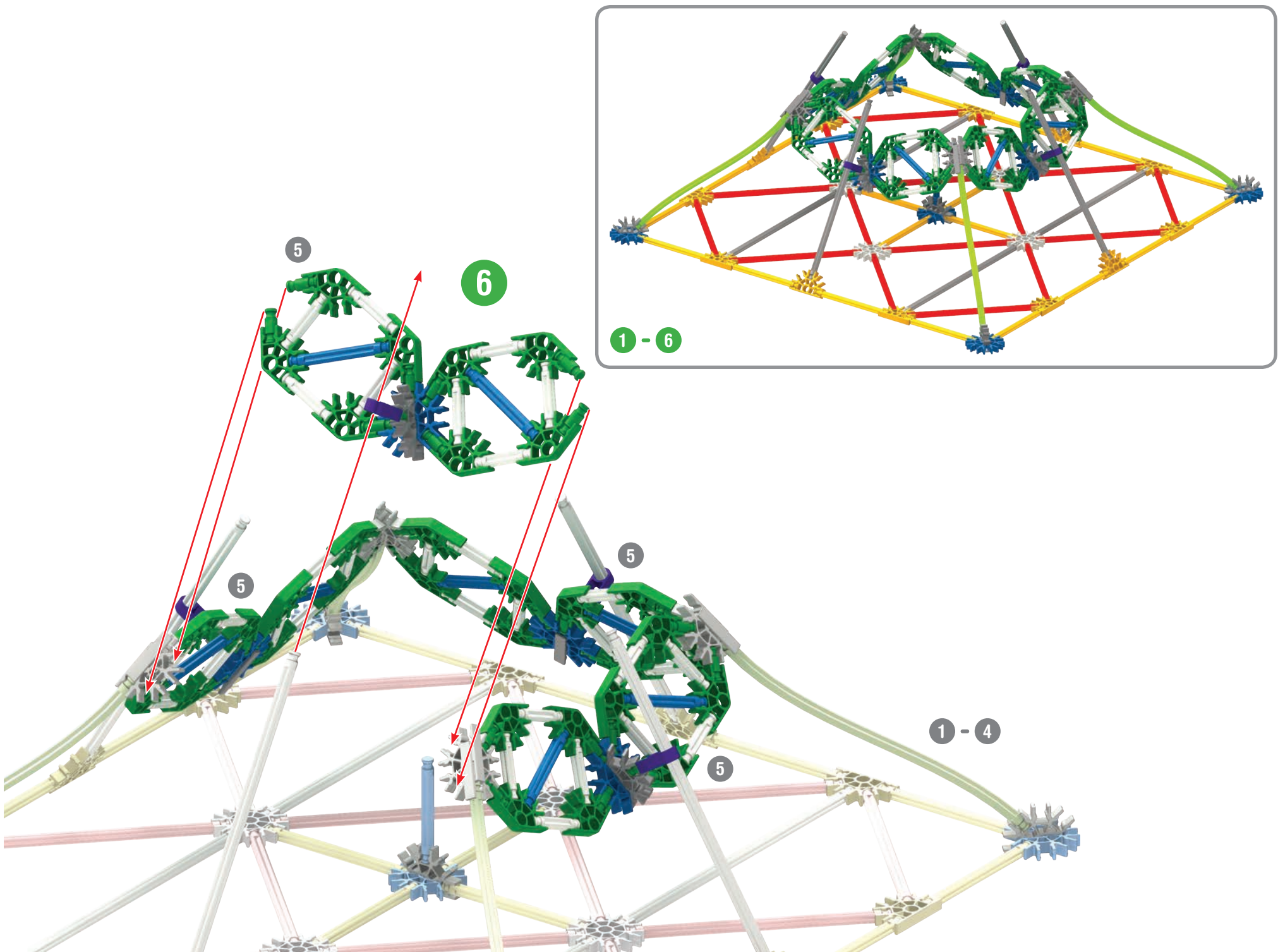

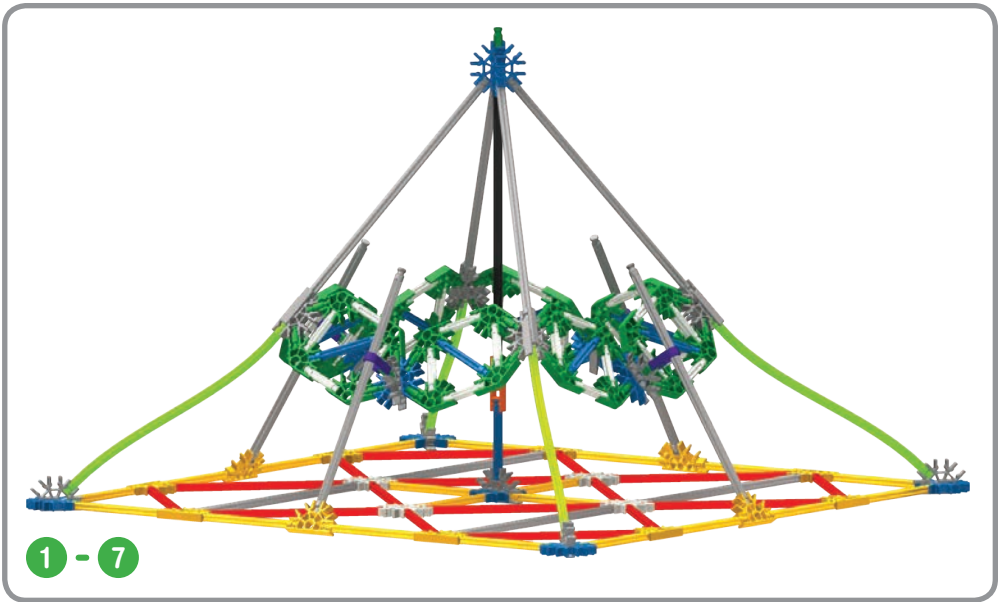
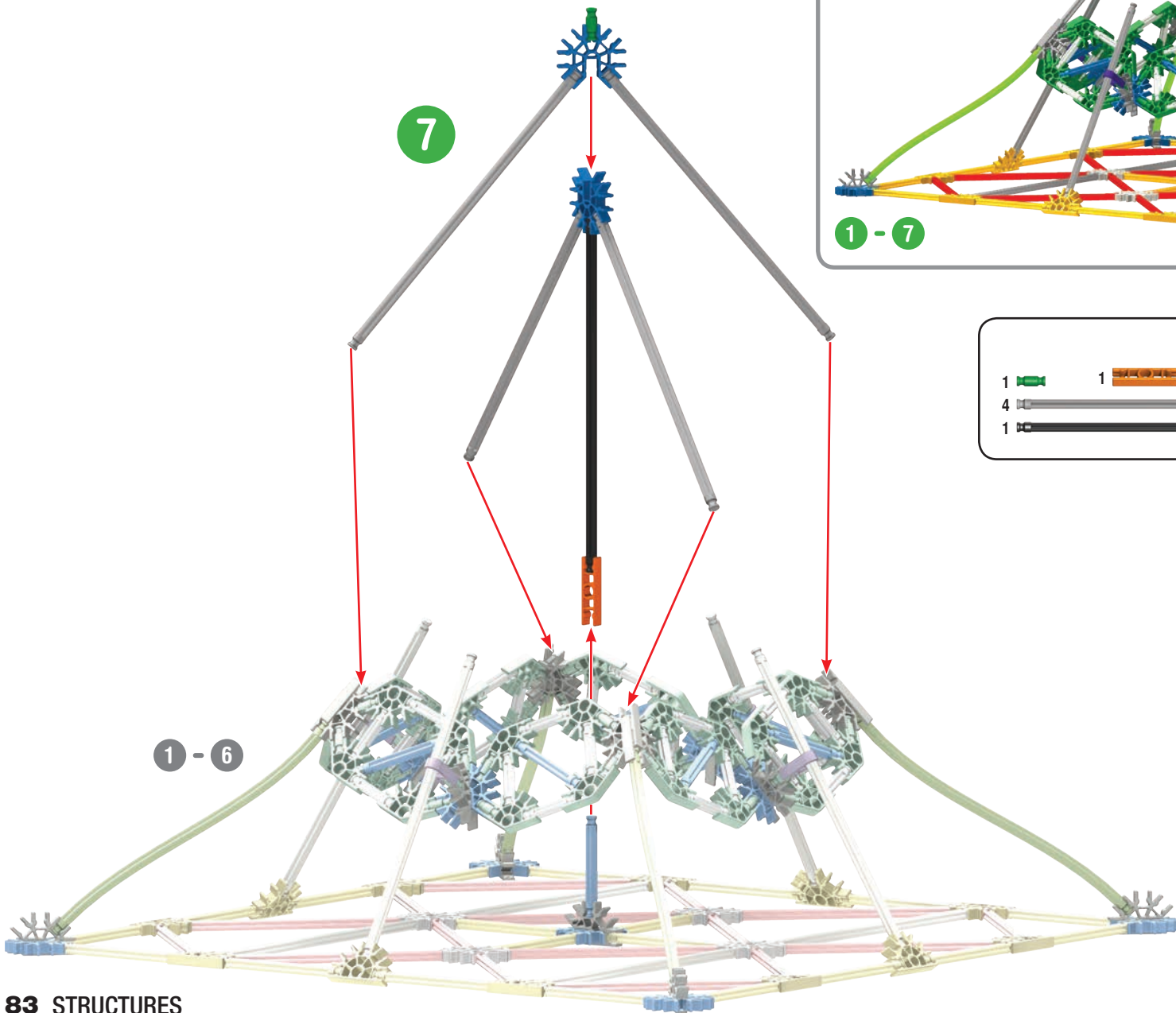

- | | | |
|---|---|---|
| 1 | 1 | 2 |
| 4 | | |
| 1 | | |

Pyramid

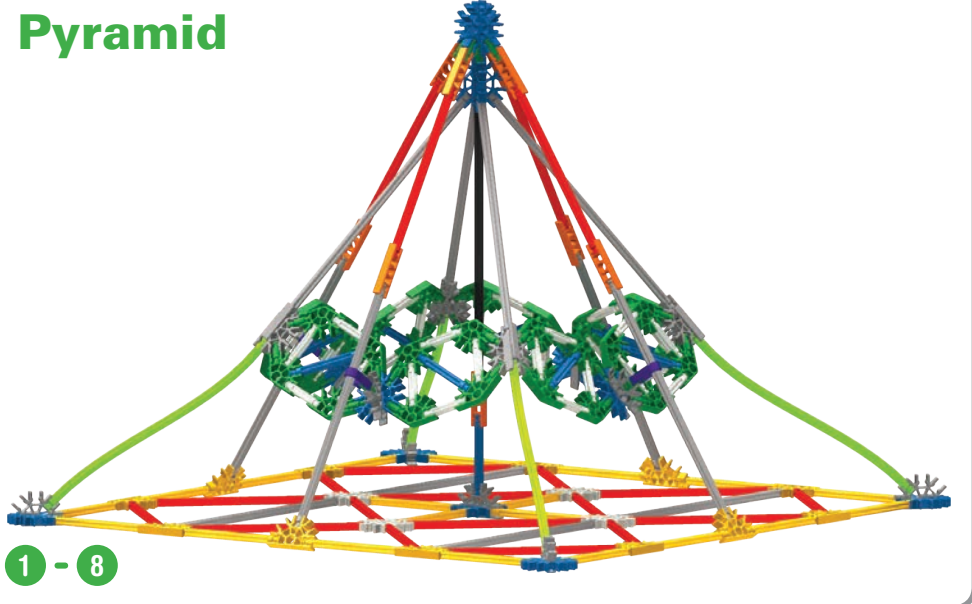

8

4 8 2

4

This parts list box contains three items: a green 4-way connector (quantity 4), an orange 8-way connector (quantity 8), and a blue 2-way connector (quantity 2). Below these items are two red arrows pointing to the right, indicating the direction of assembly.

1 - 7

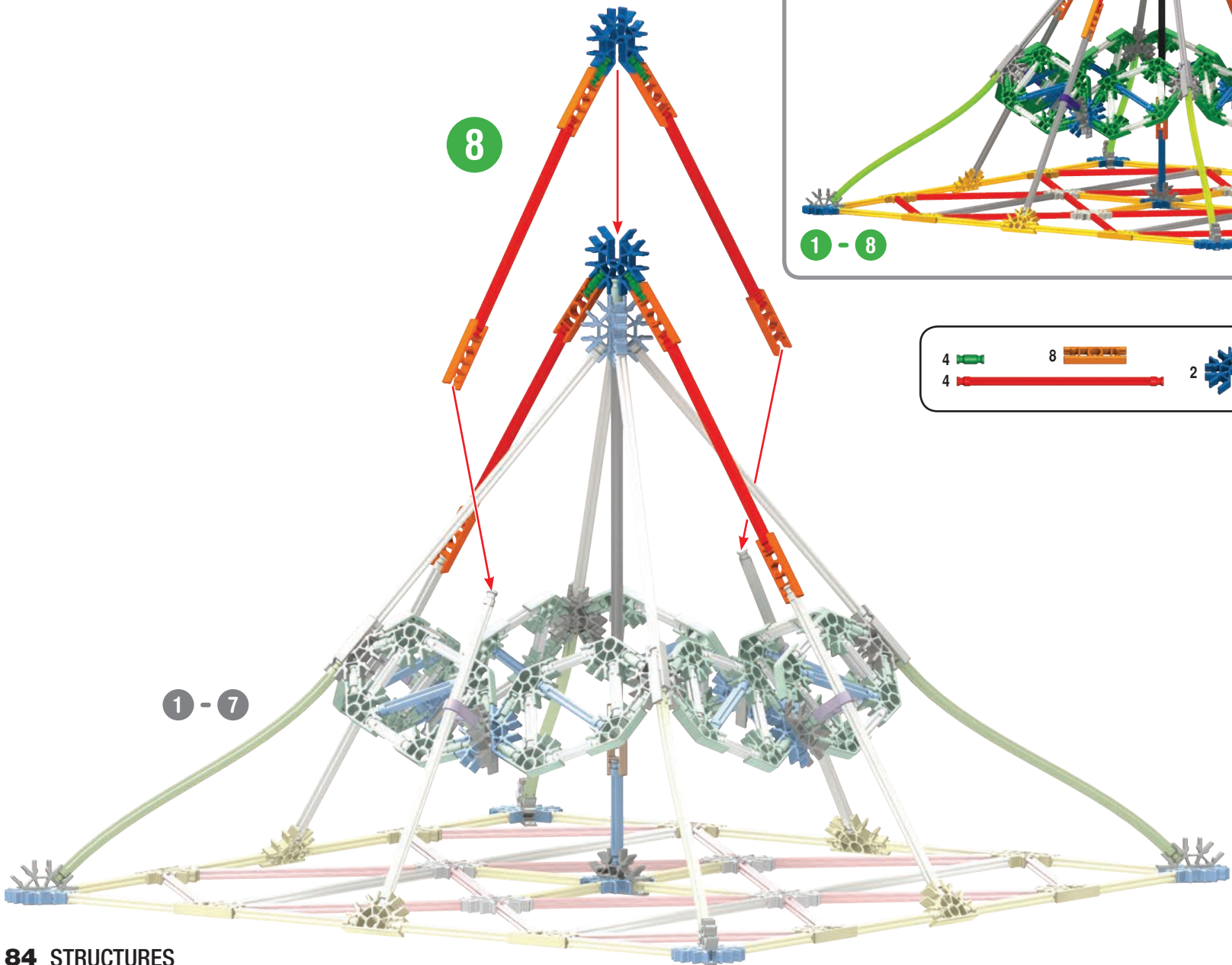

Treehouse

x2

8		12		12	
16					
4					

1

2

x2

1 - 2

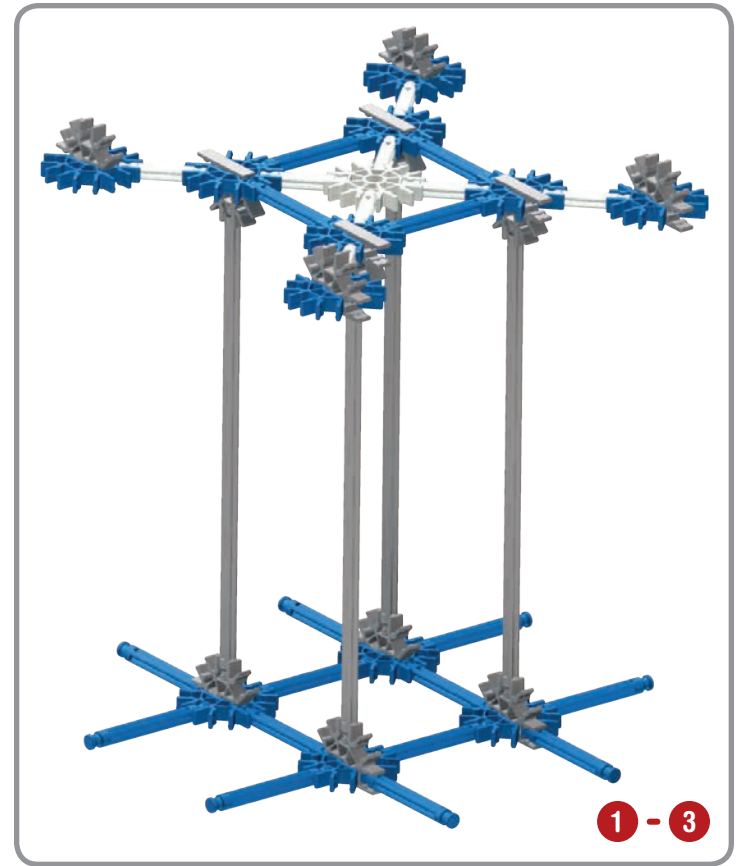
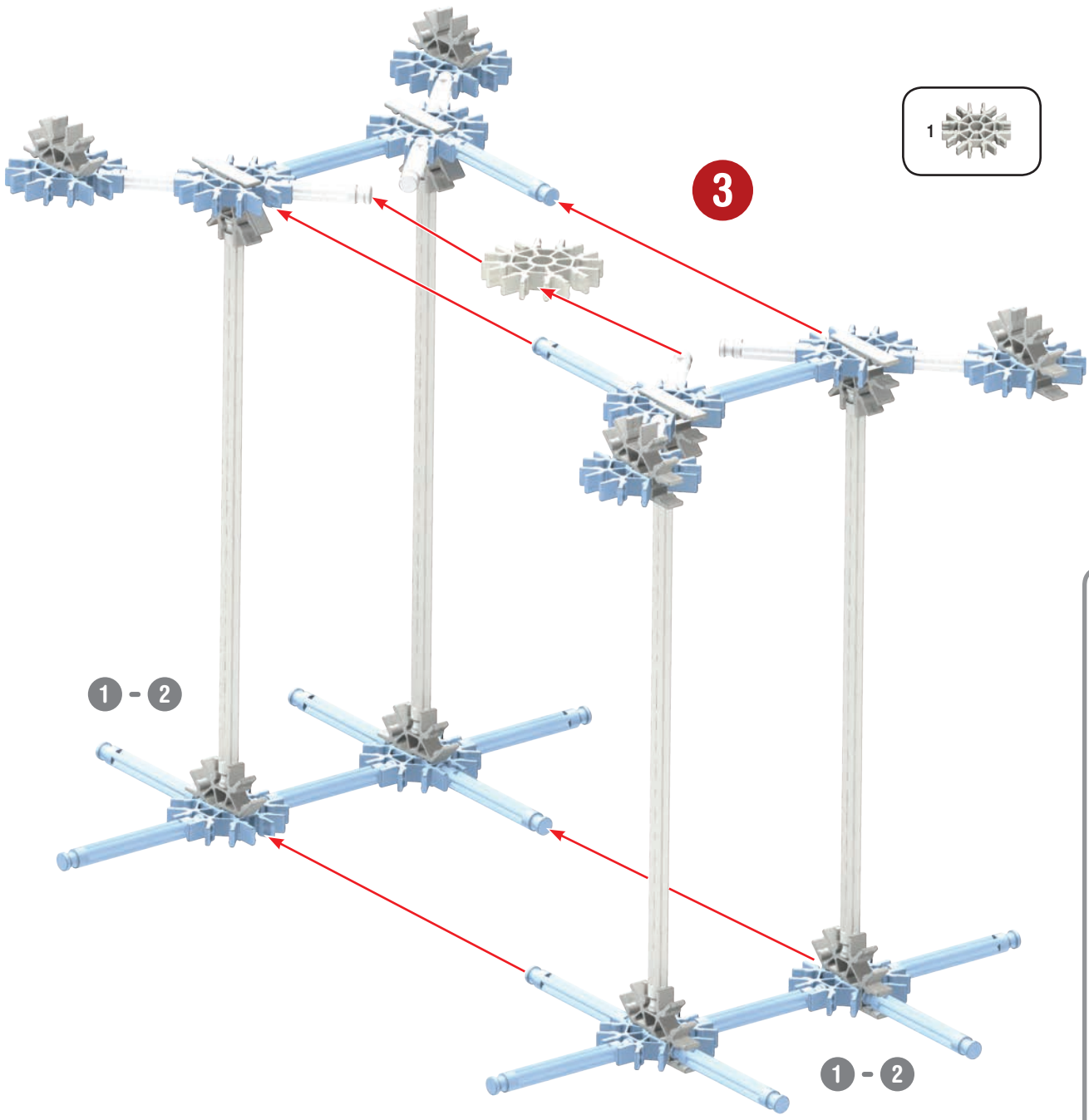

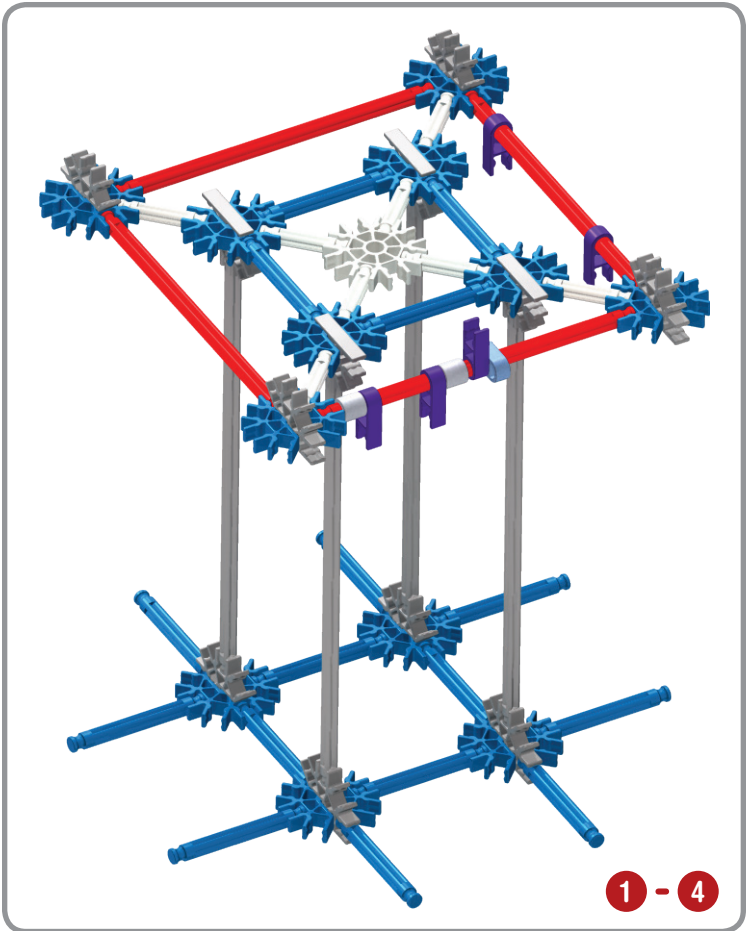
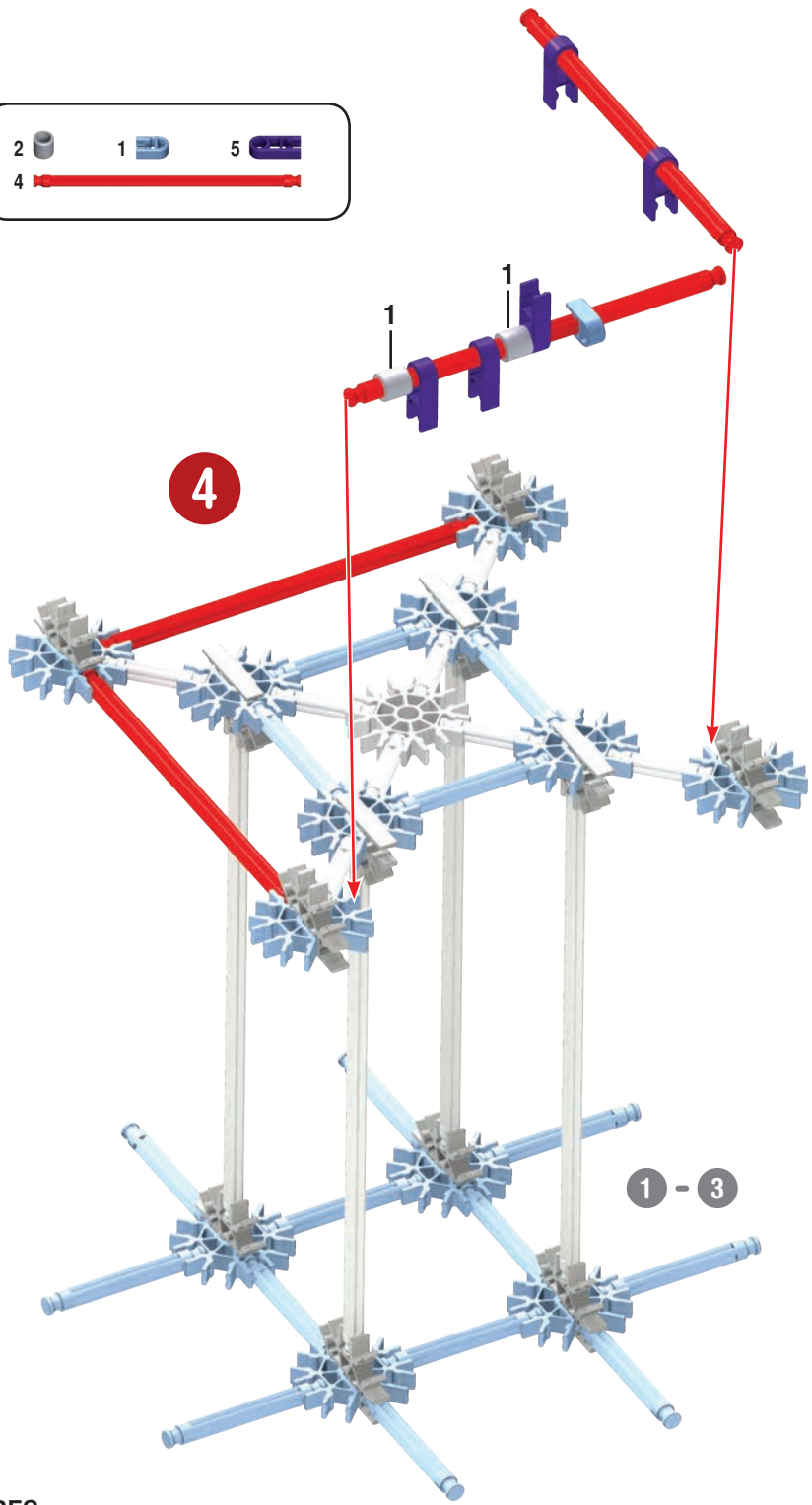
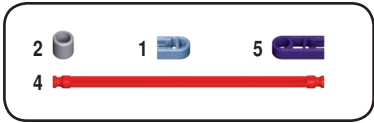

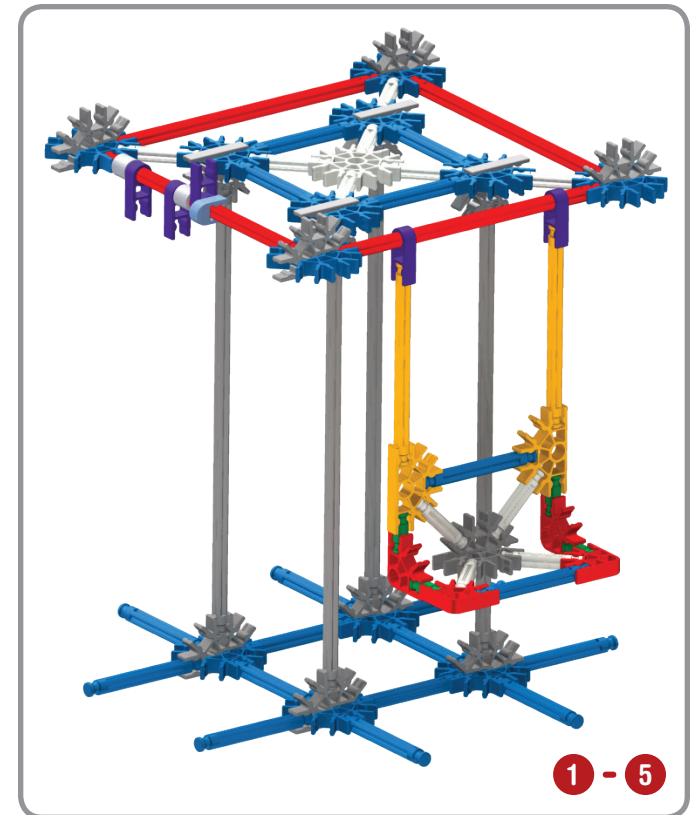
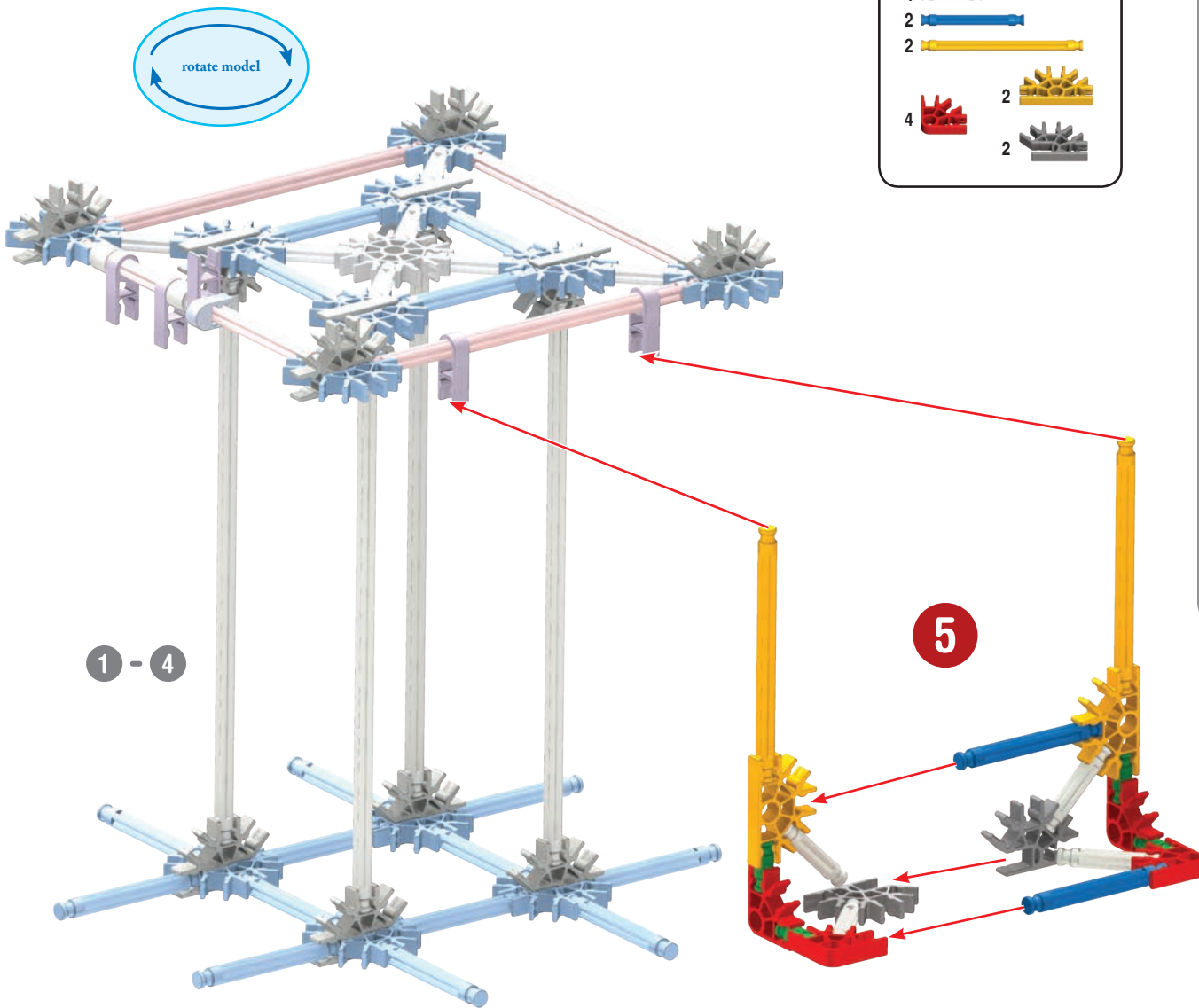

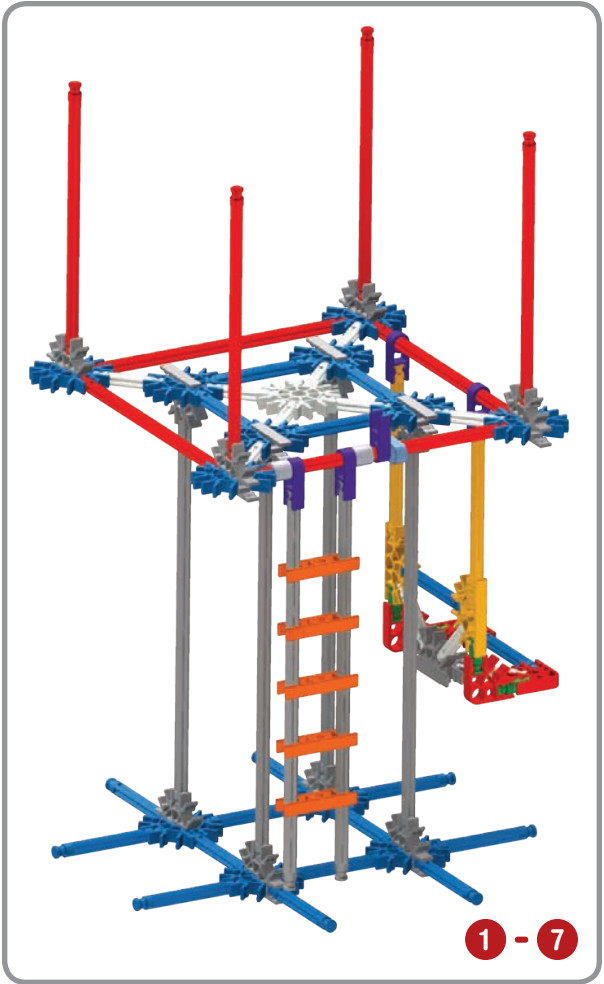
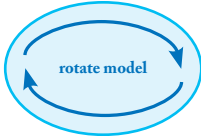
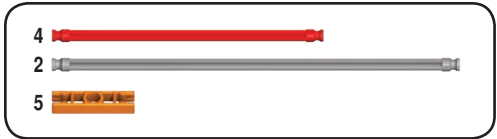
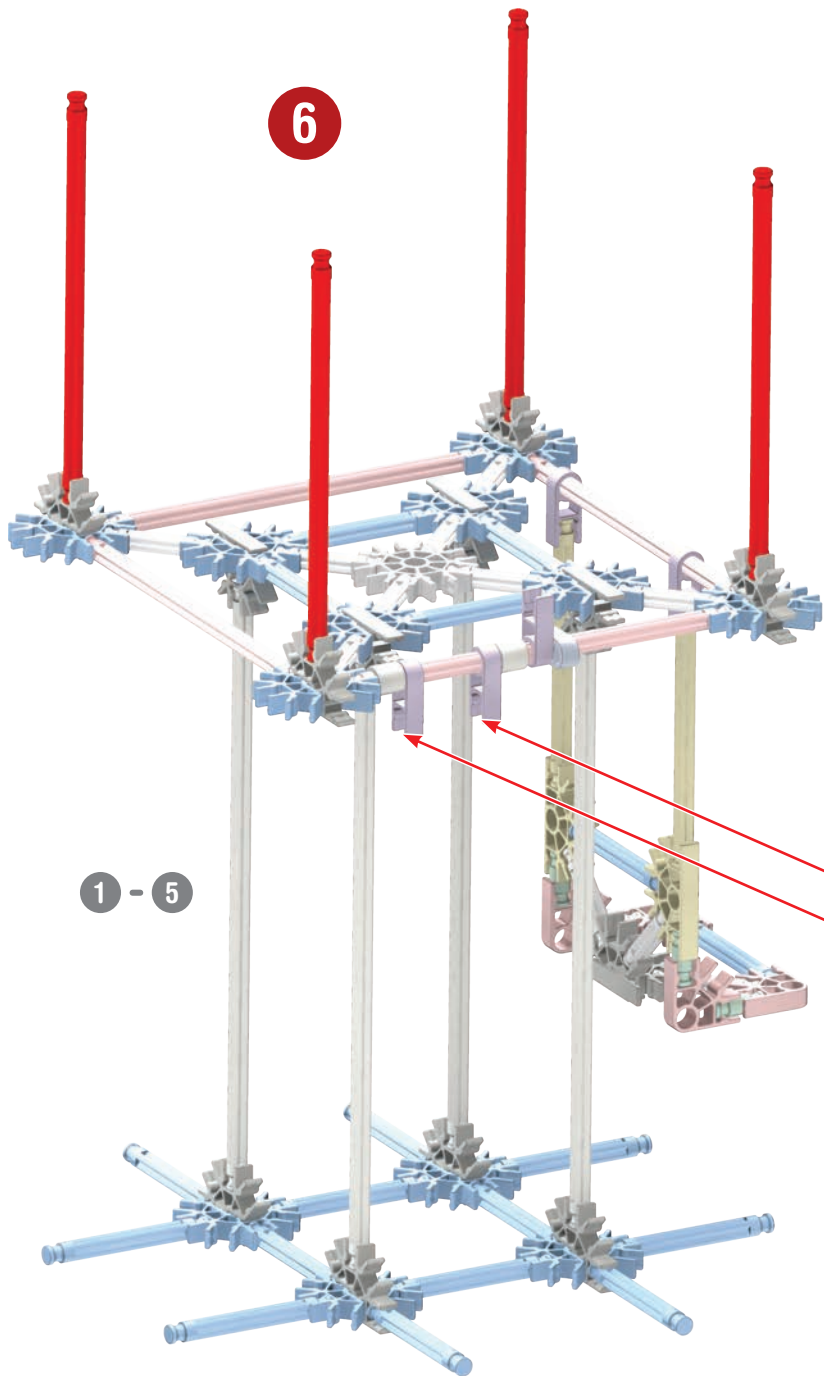

8

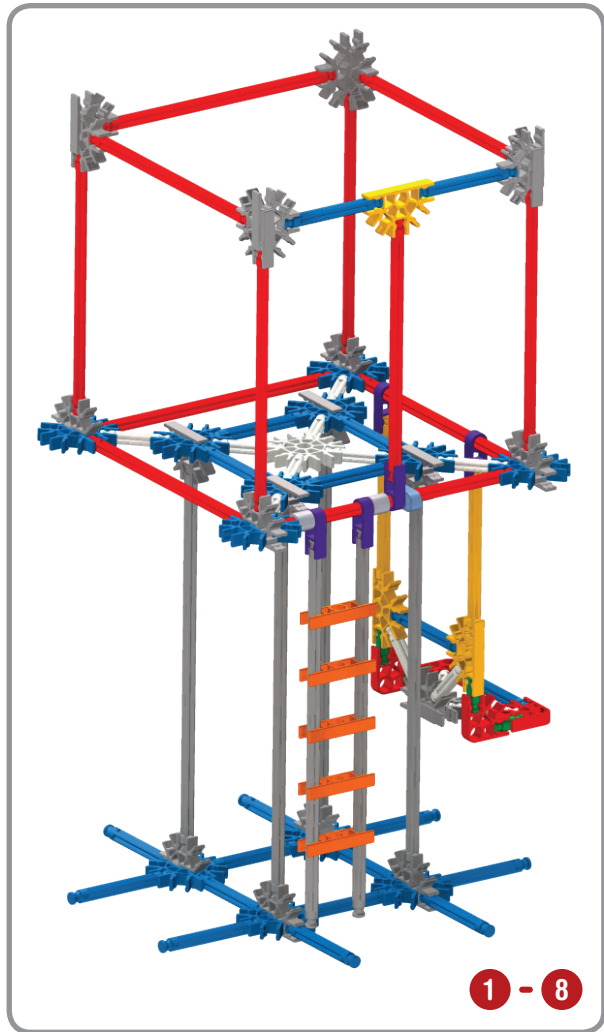
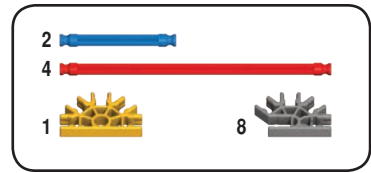
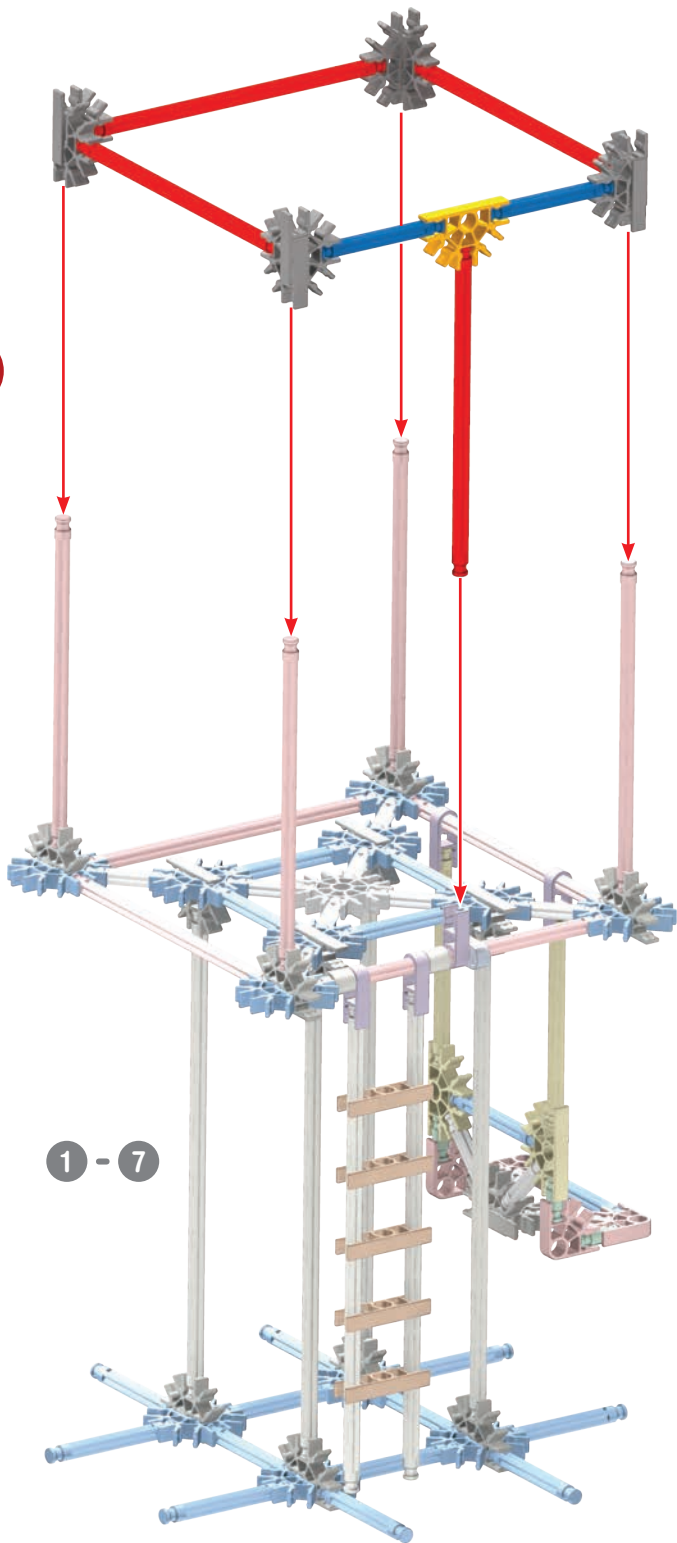

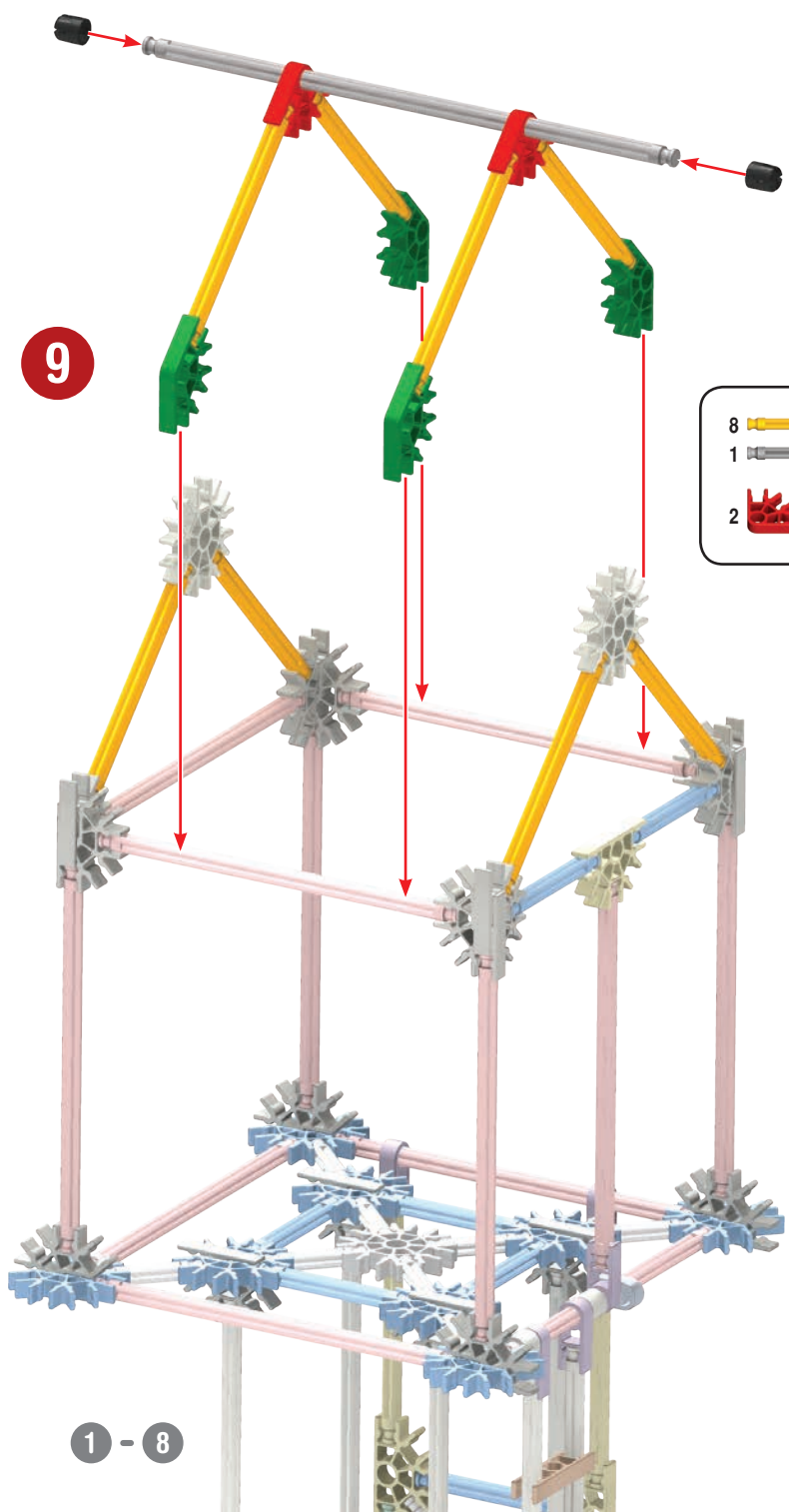

x3

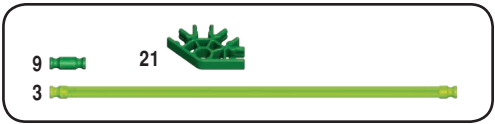
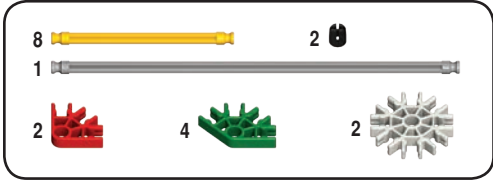

10

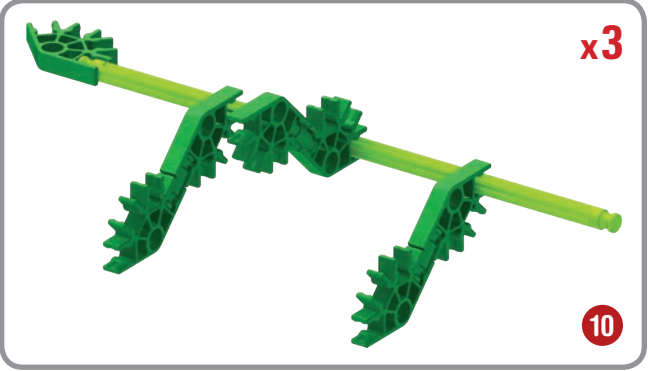
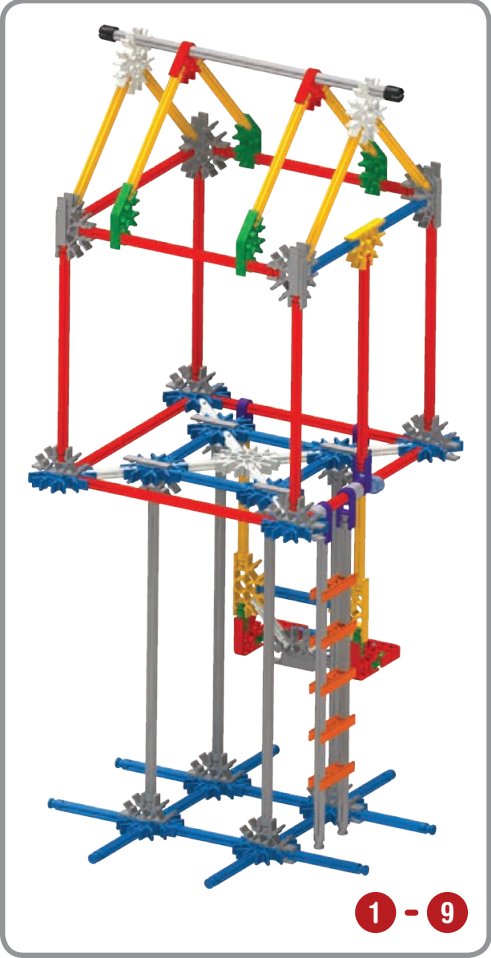
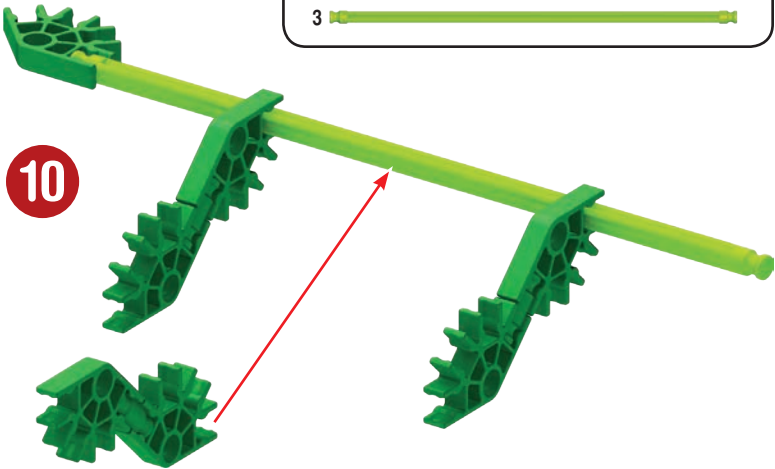

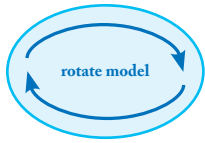

11

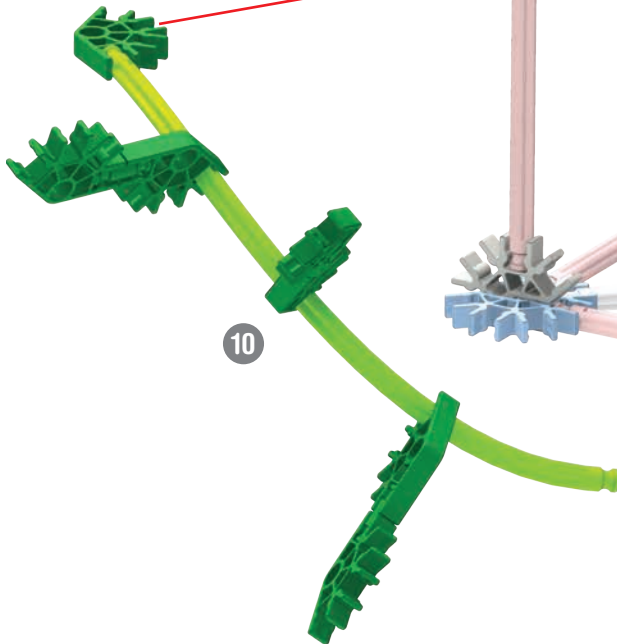

10

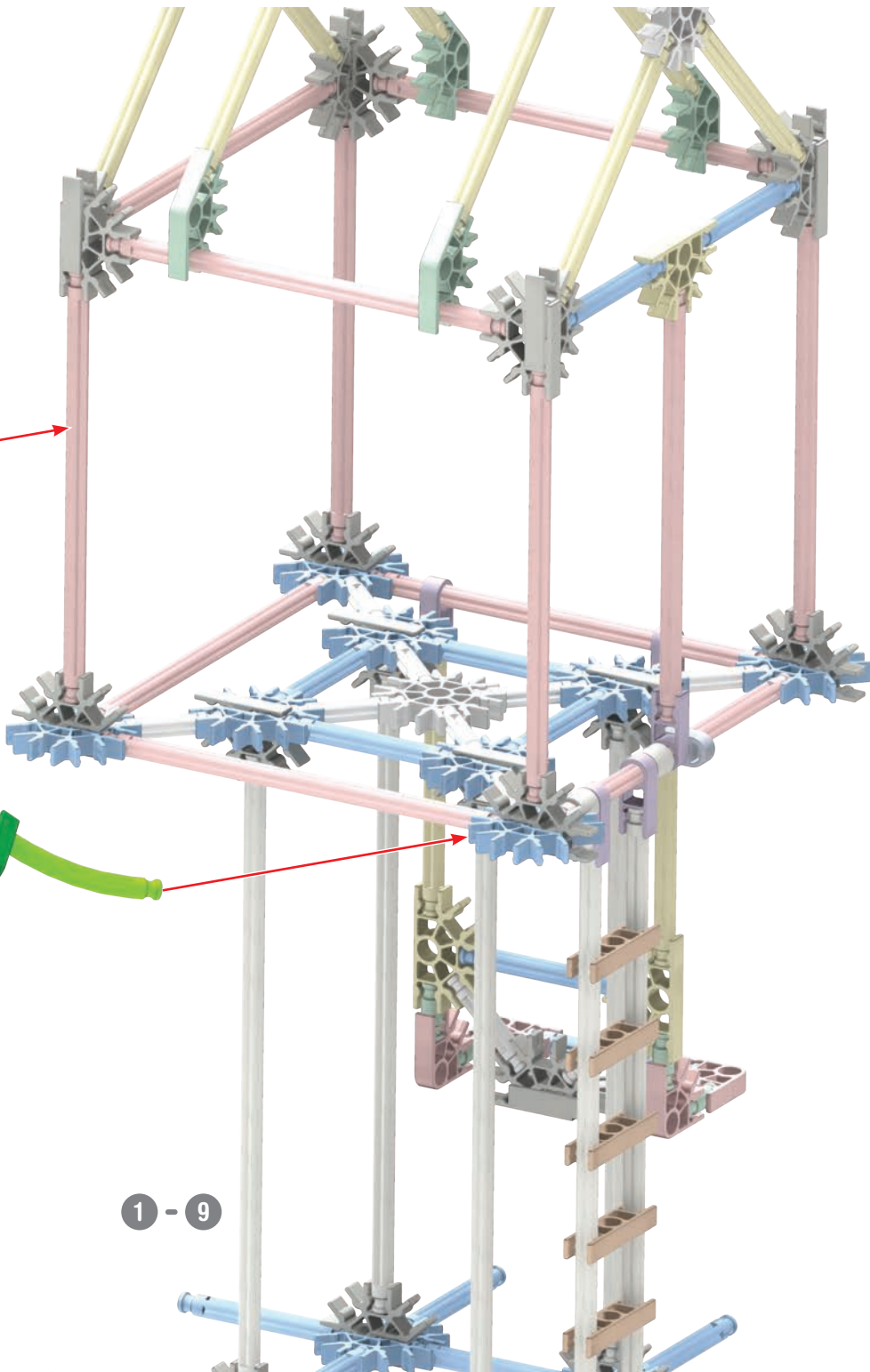

1 - 9

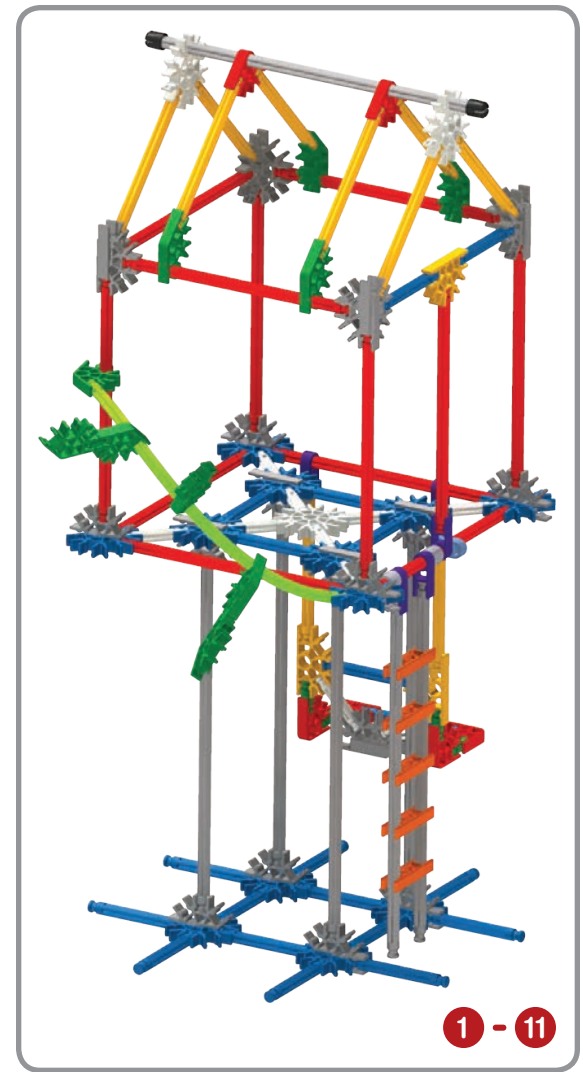

1 - 11

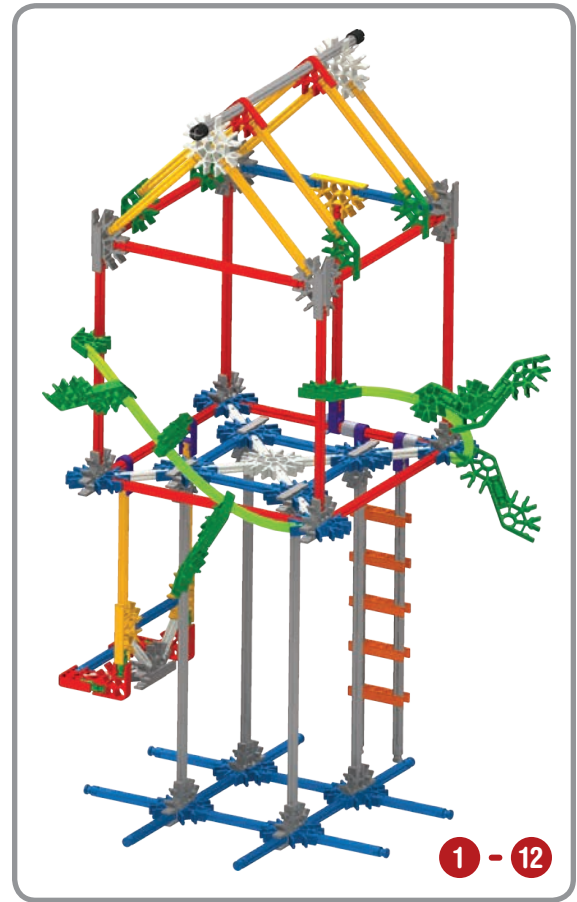
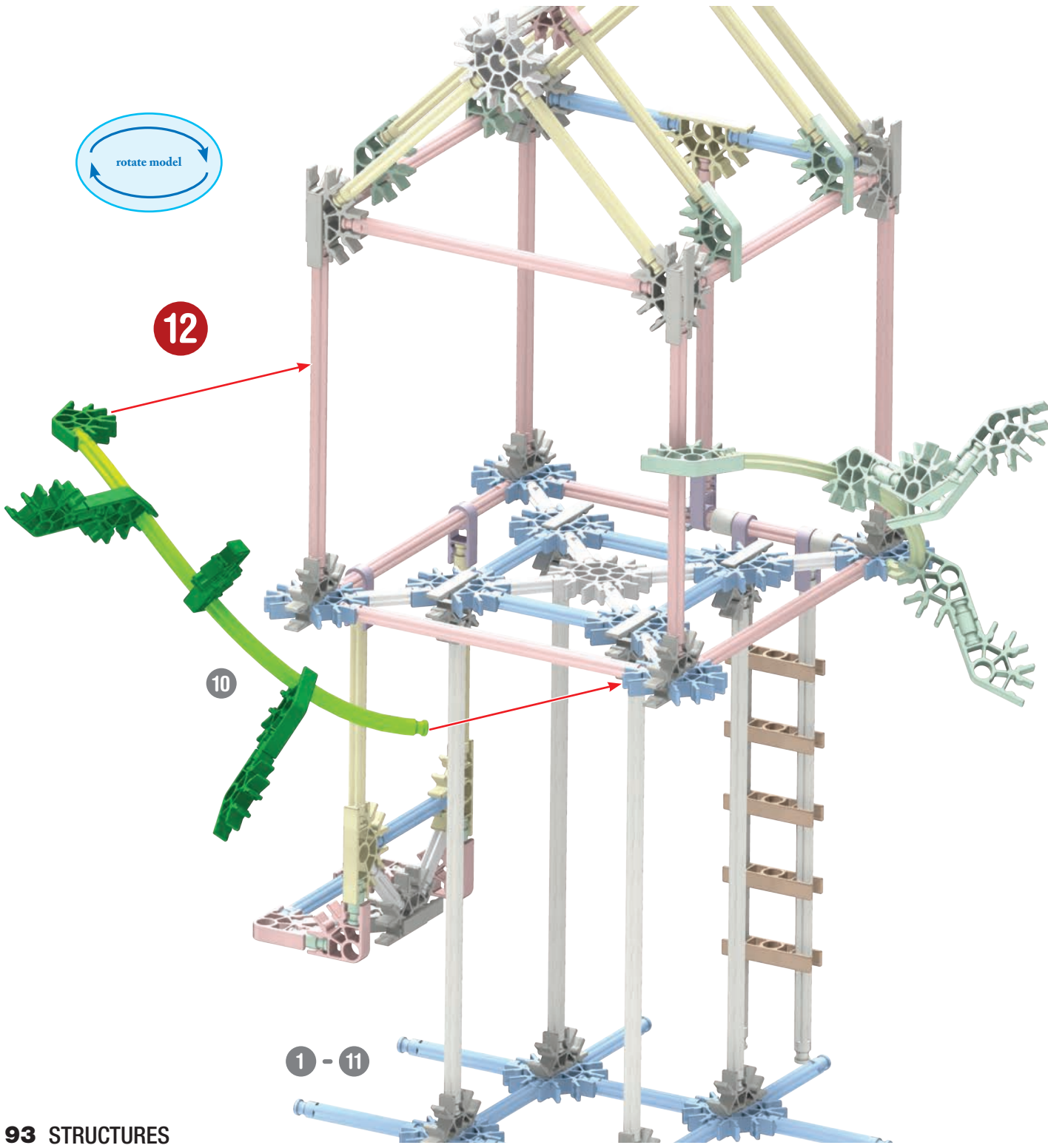
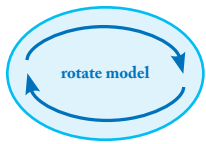

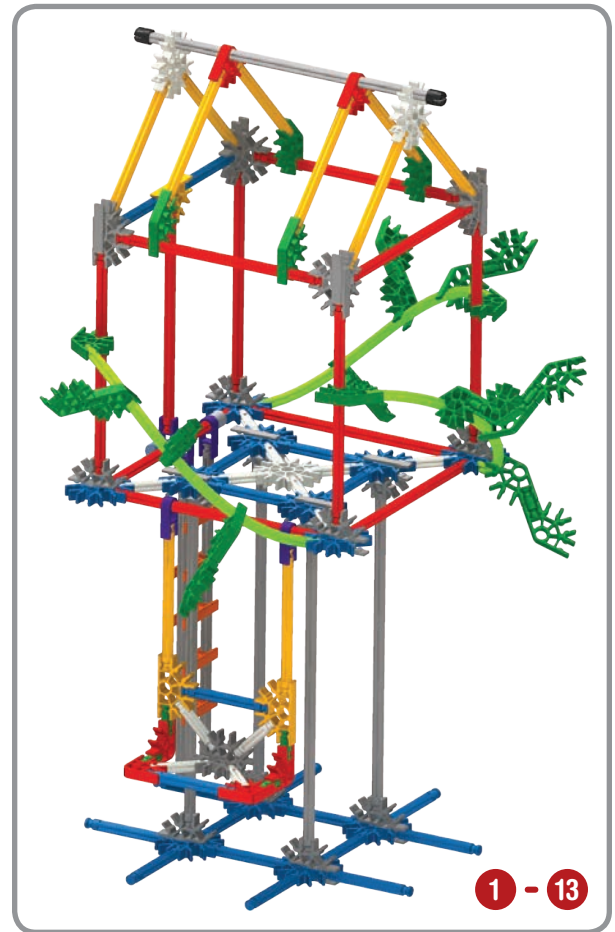
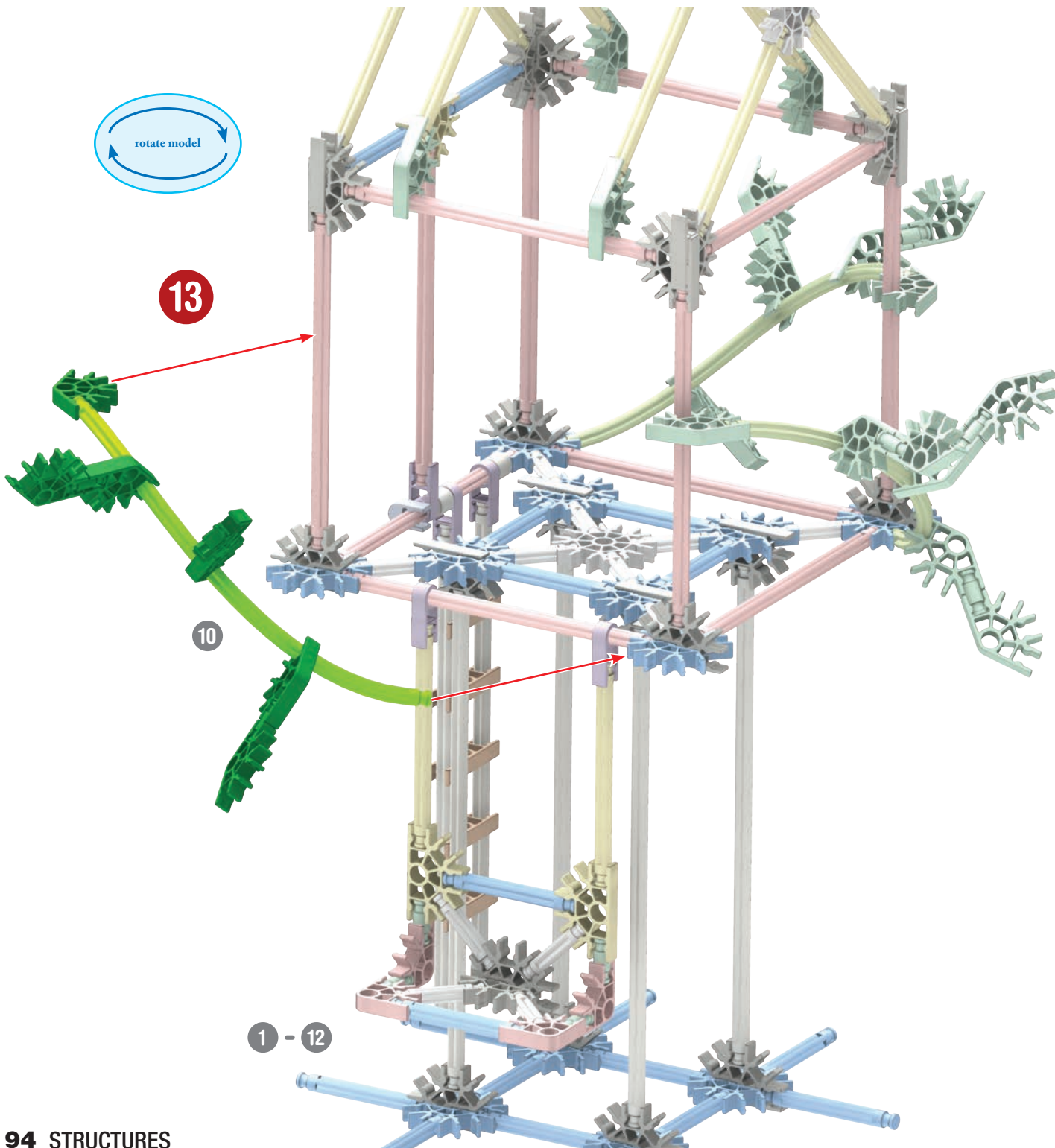

x4

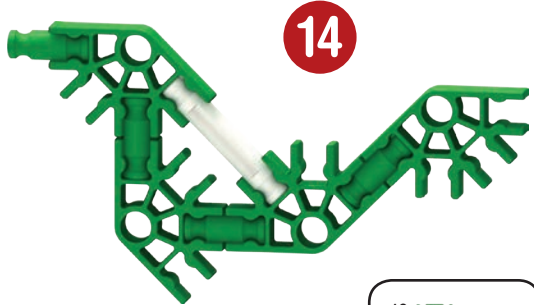

14

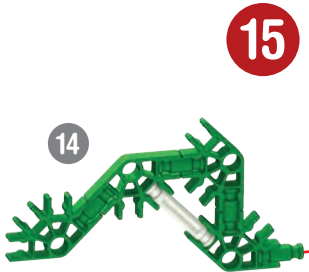
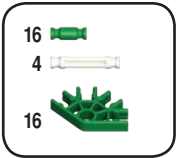

15

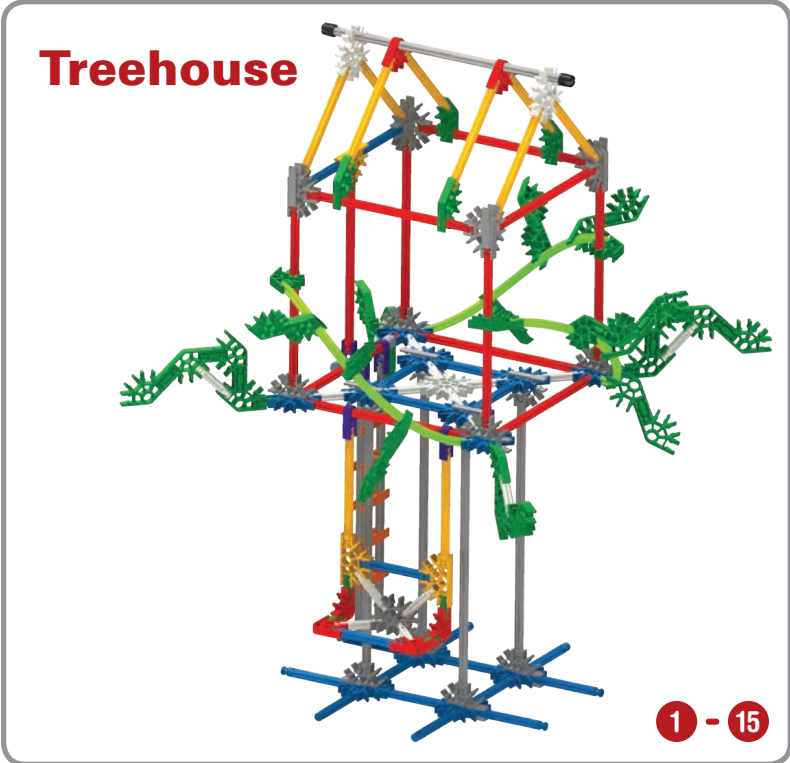
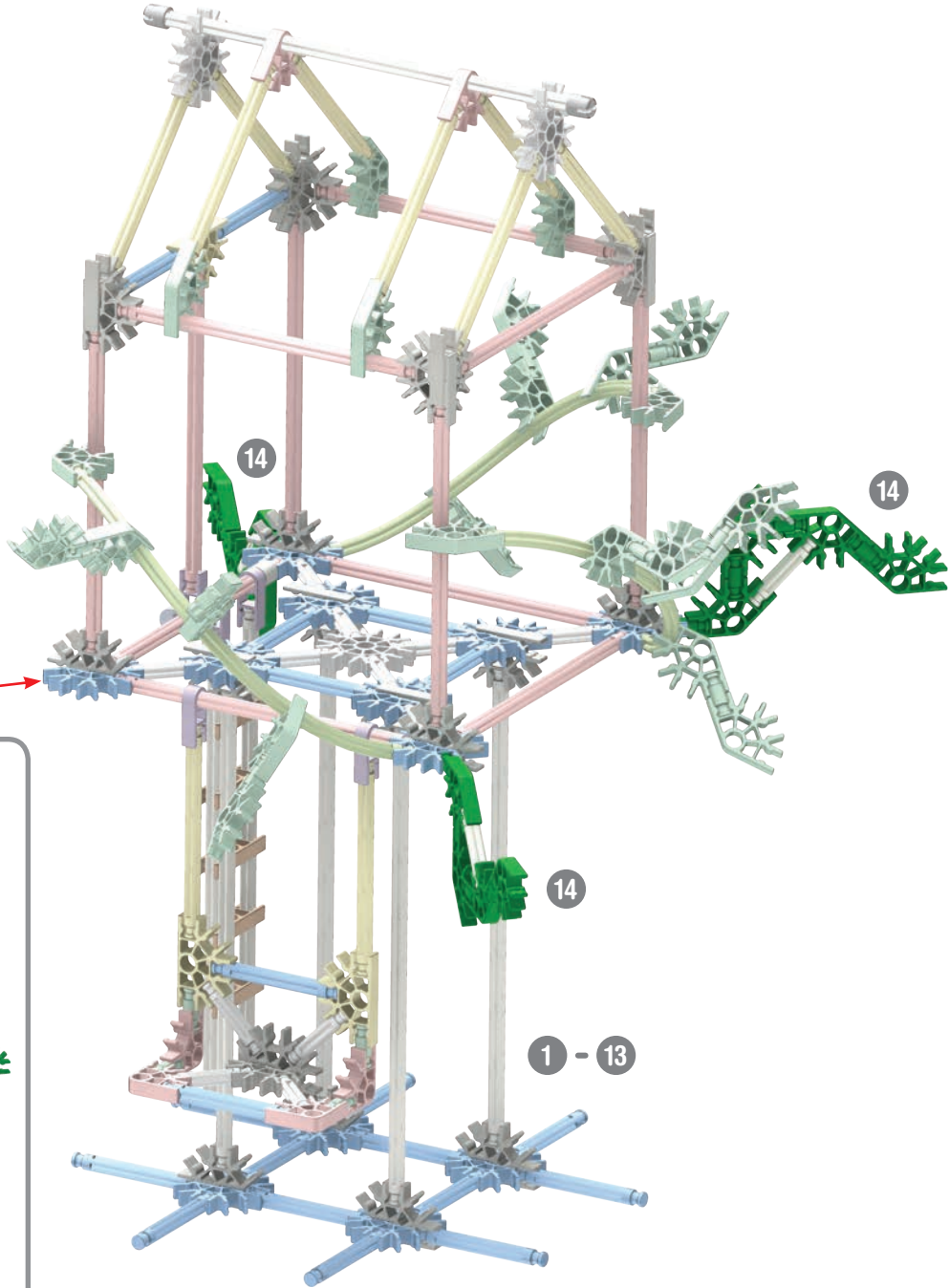

Treehouse

1 - 15

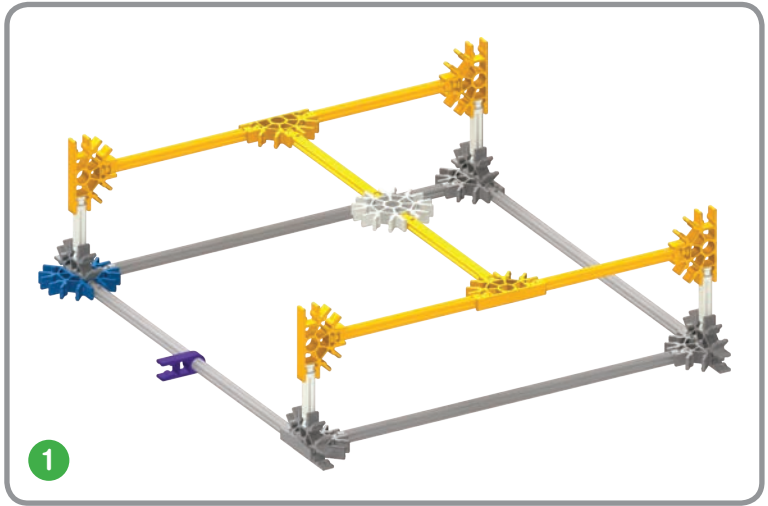
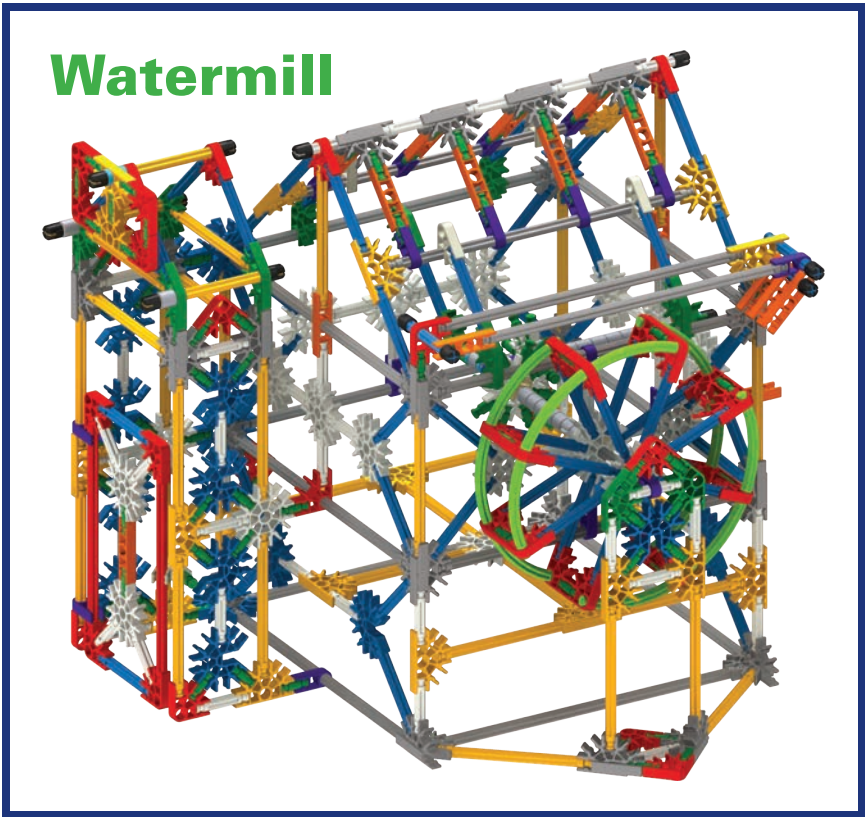
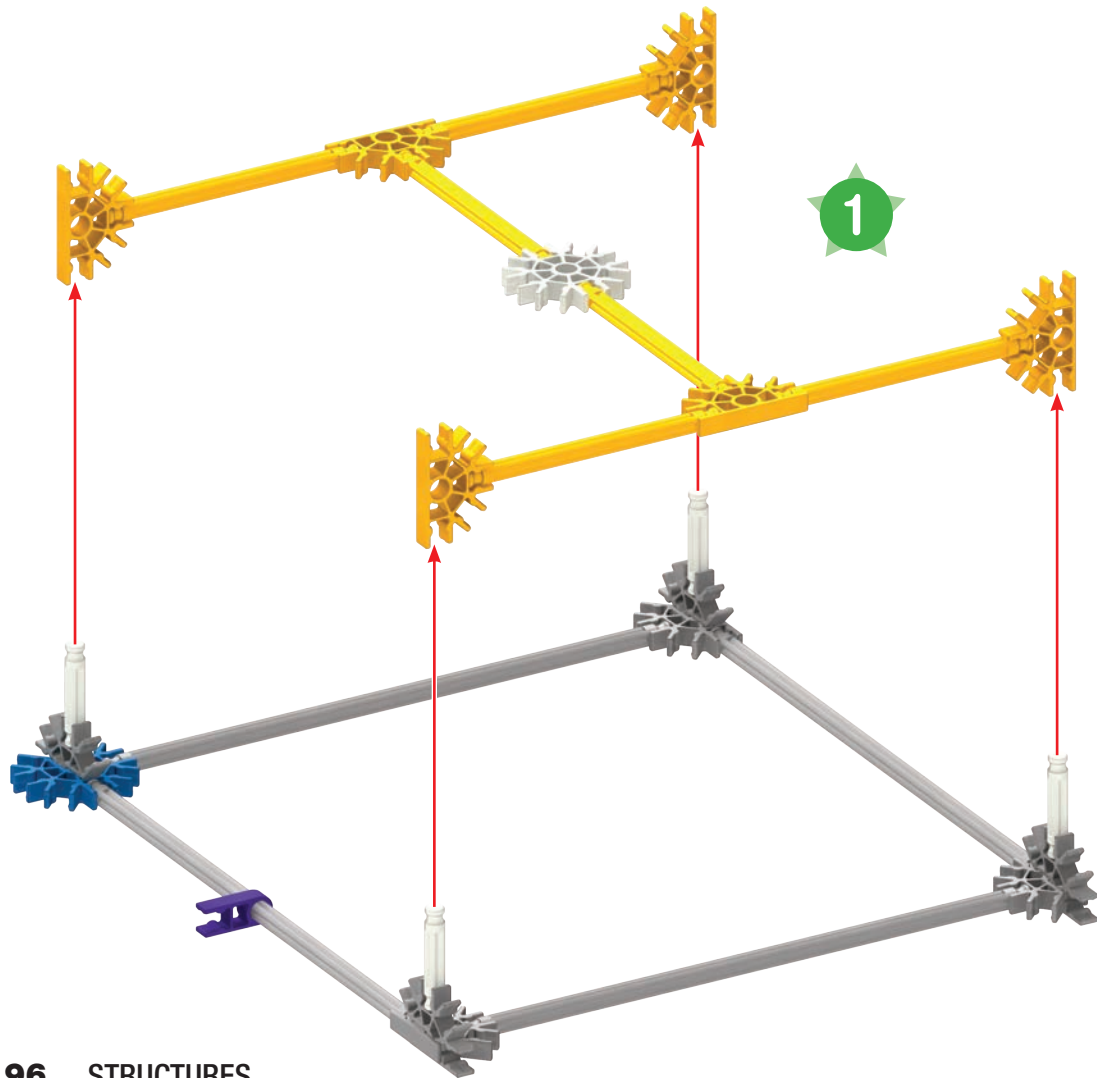
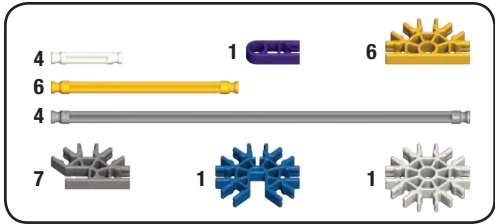

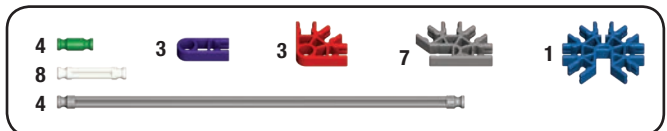
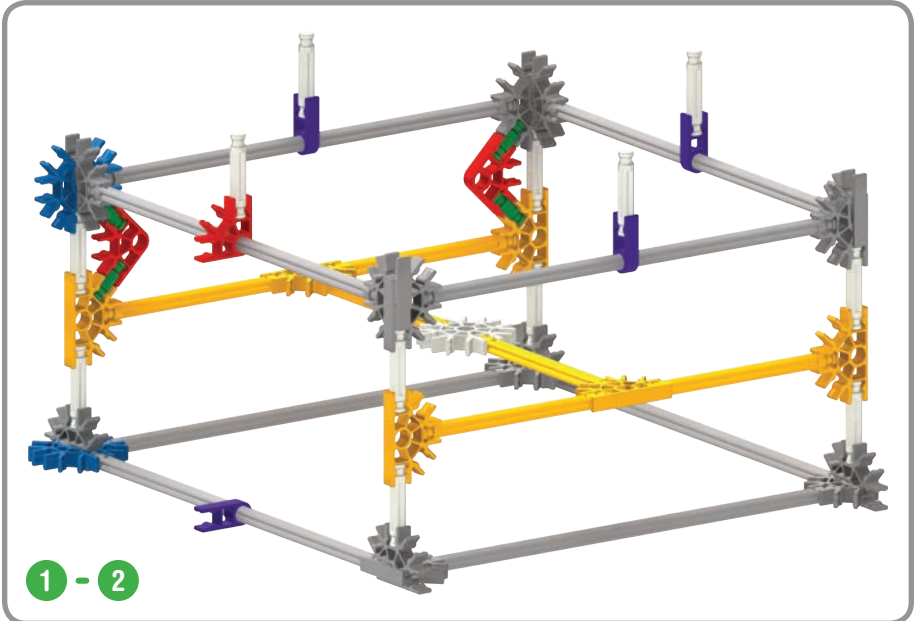
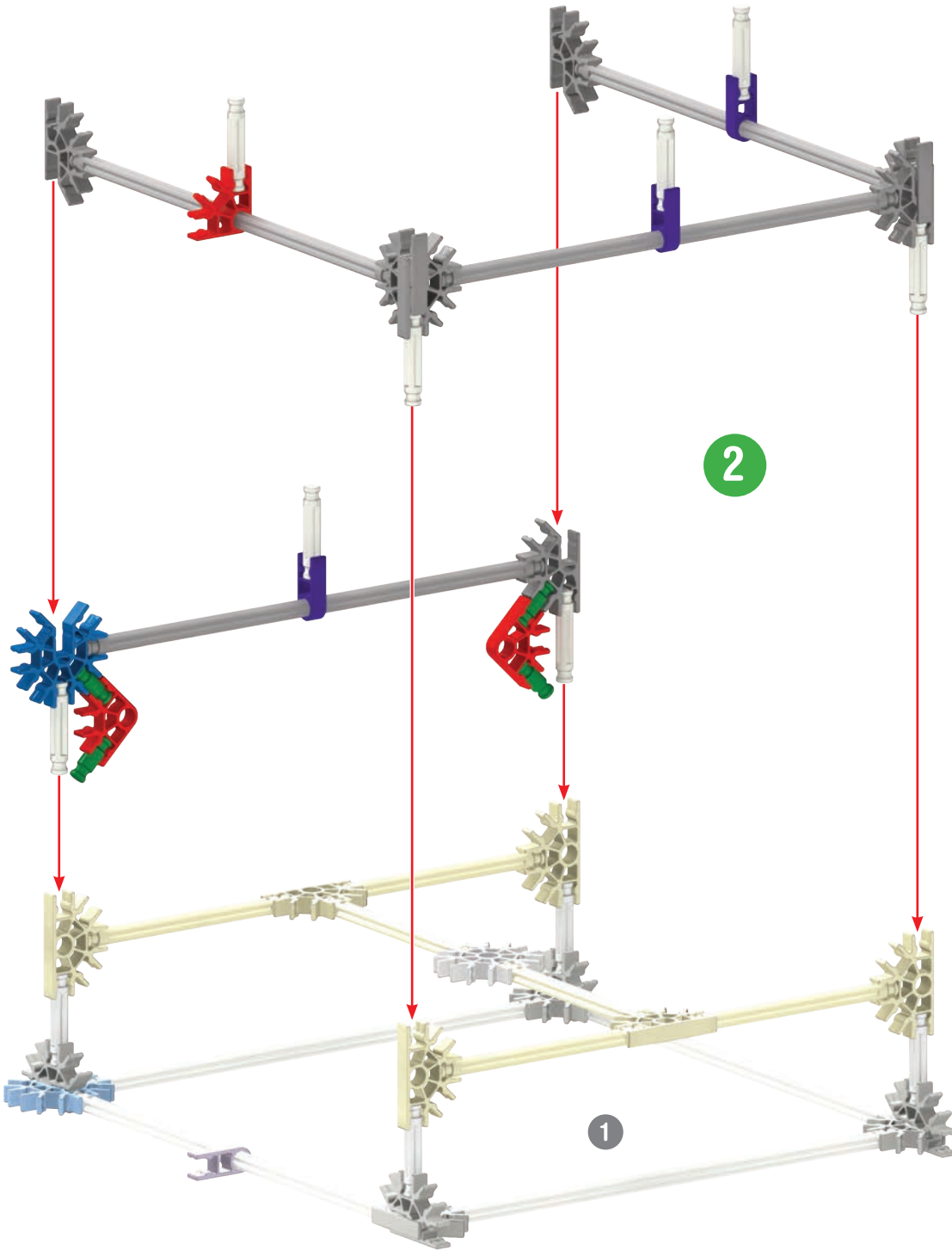

4		2		4	
8					
2					

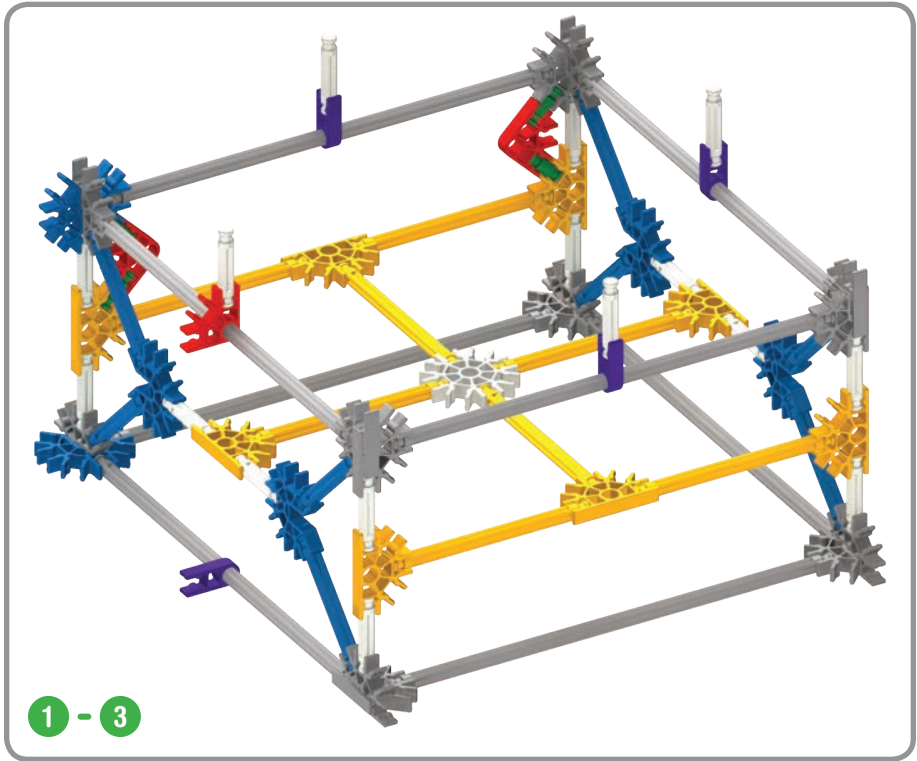
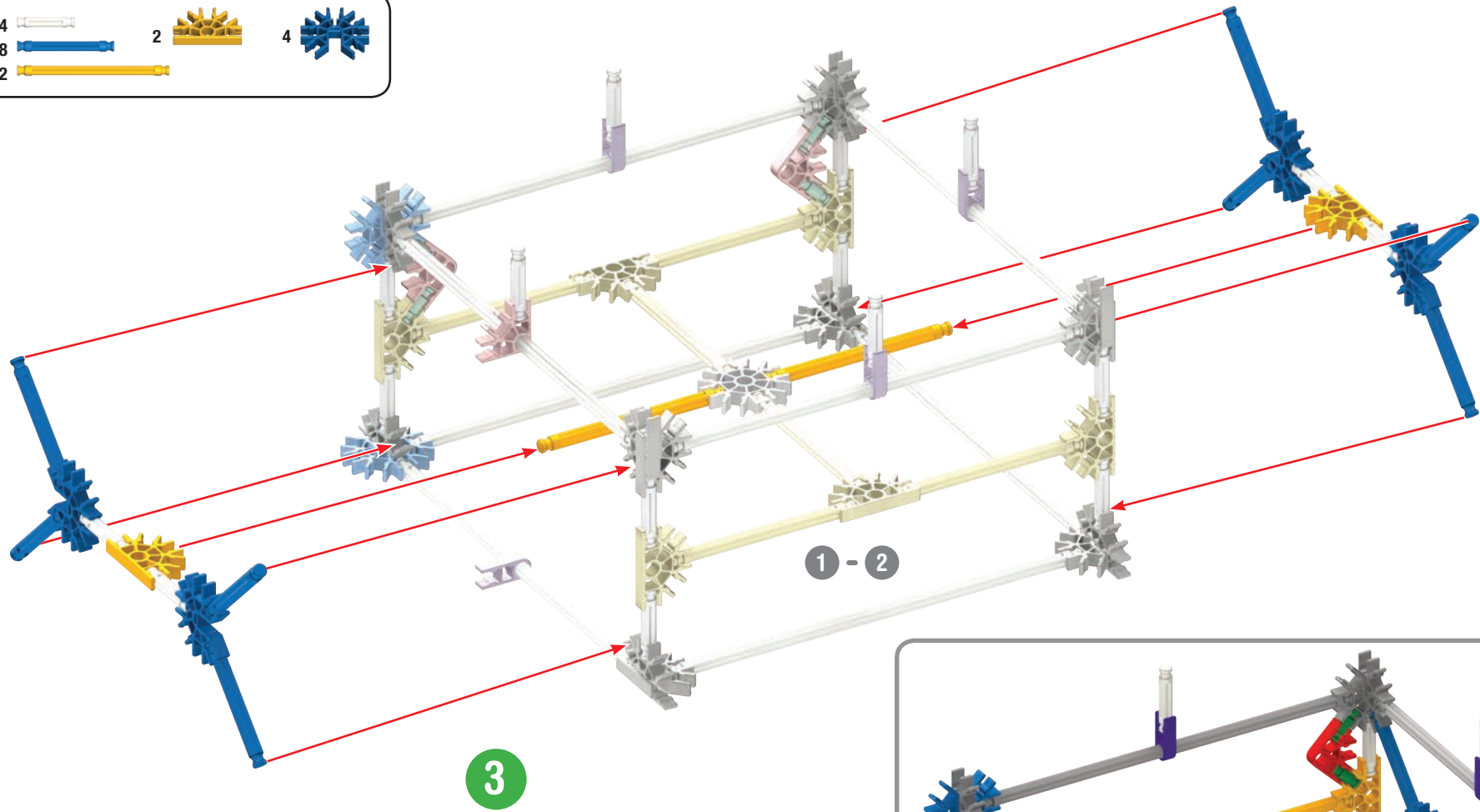

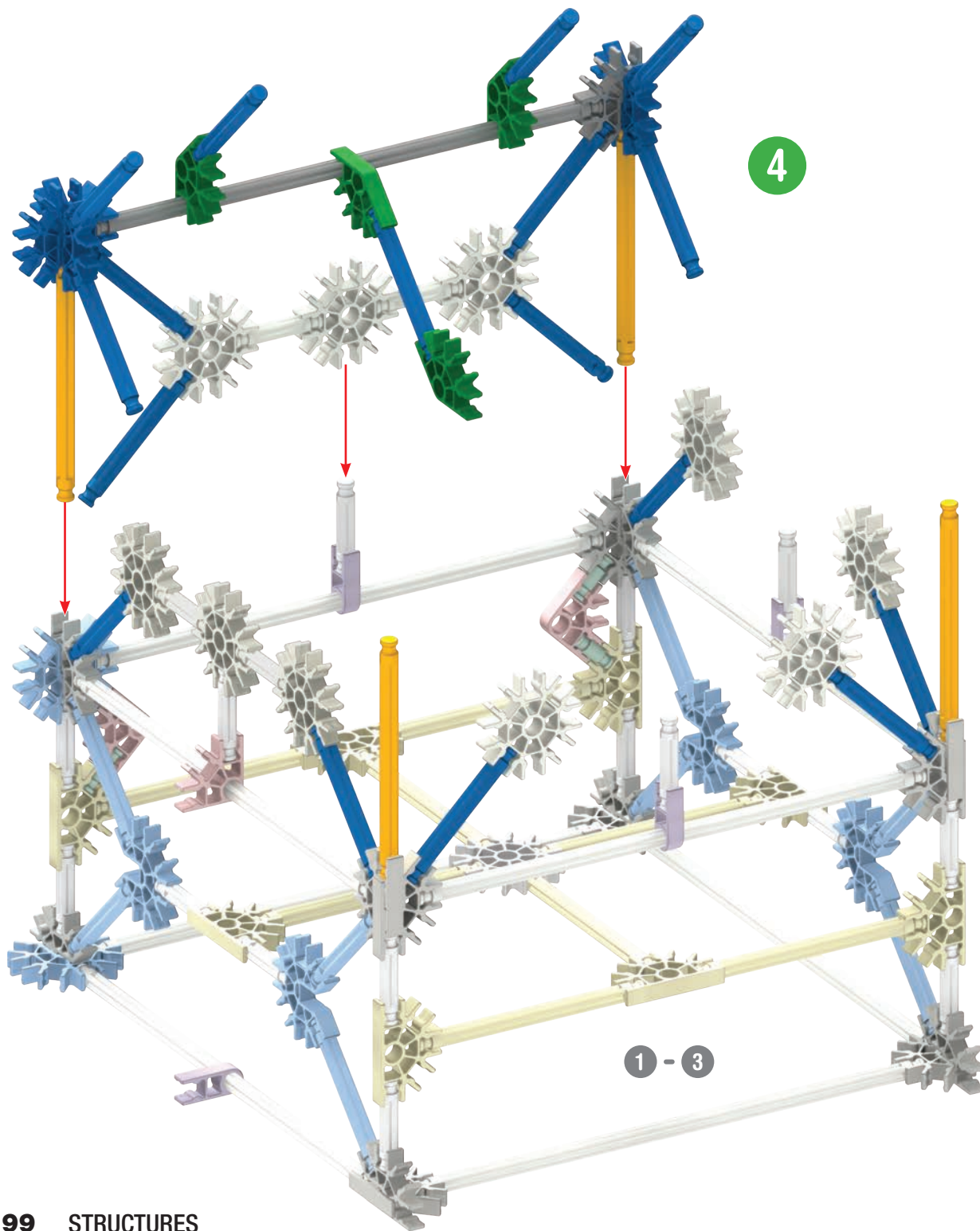

4

1 - 3

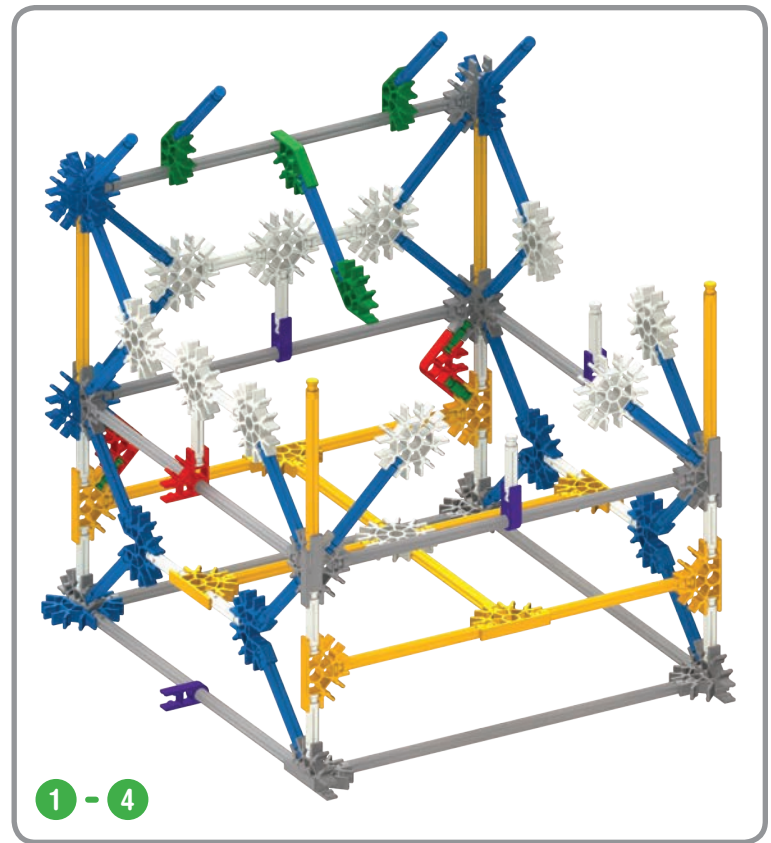

1 - 4

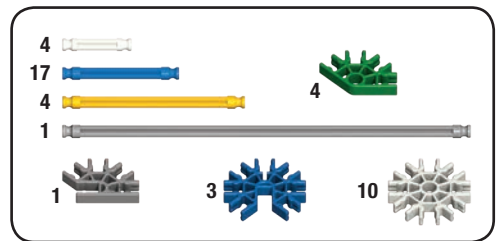

- 8 2 10 2 1
- 2
- 1

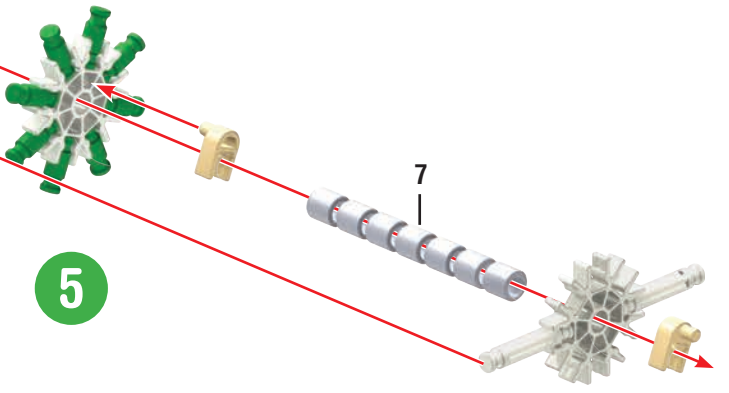
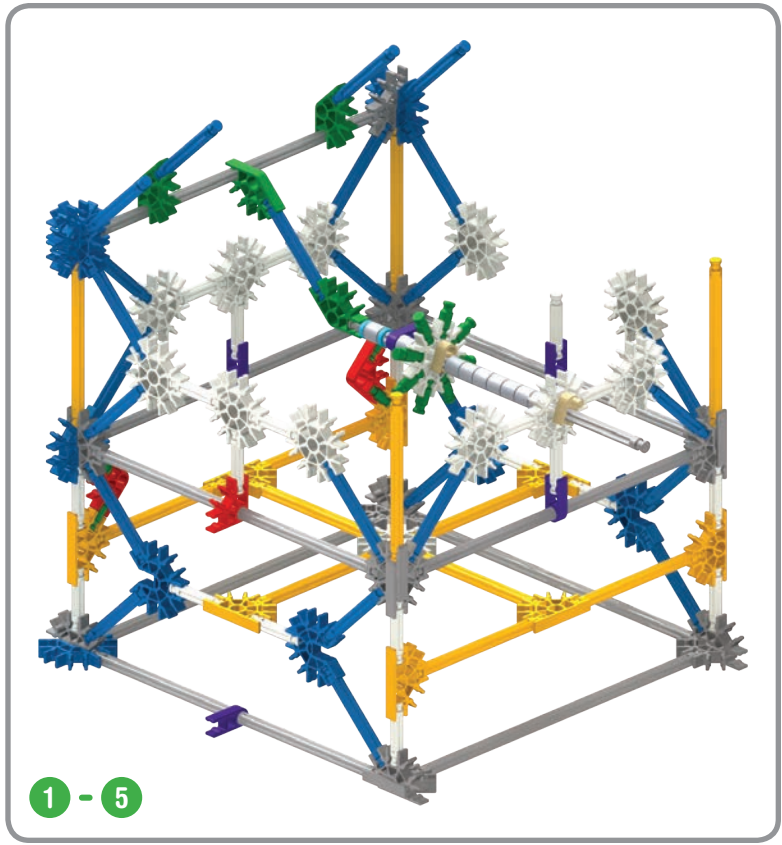
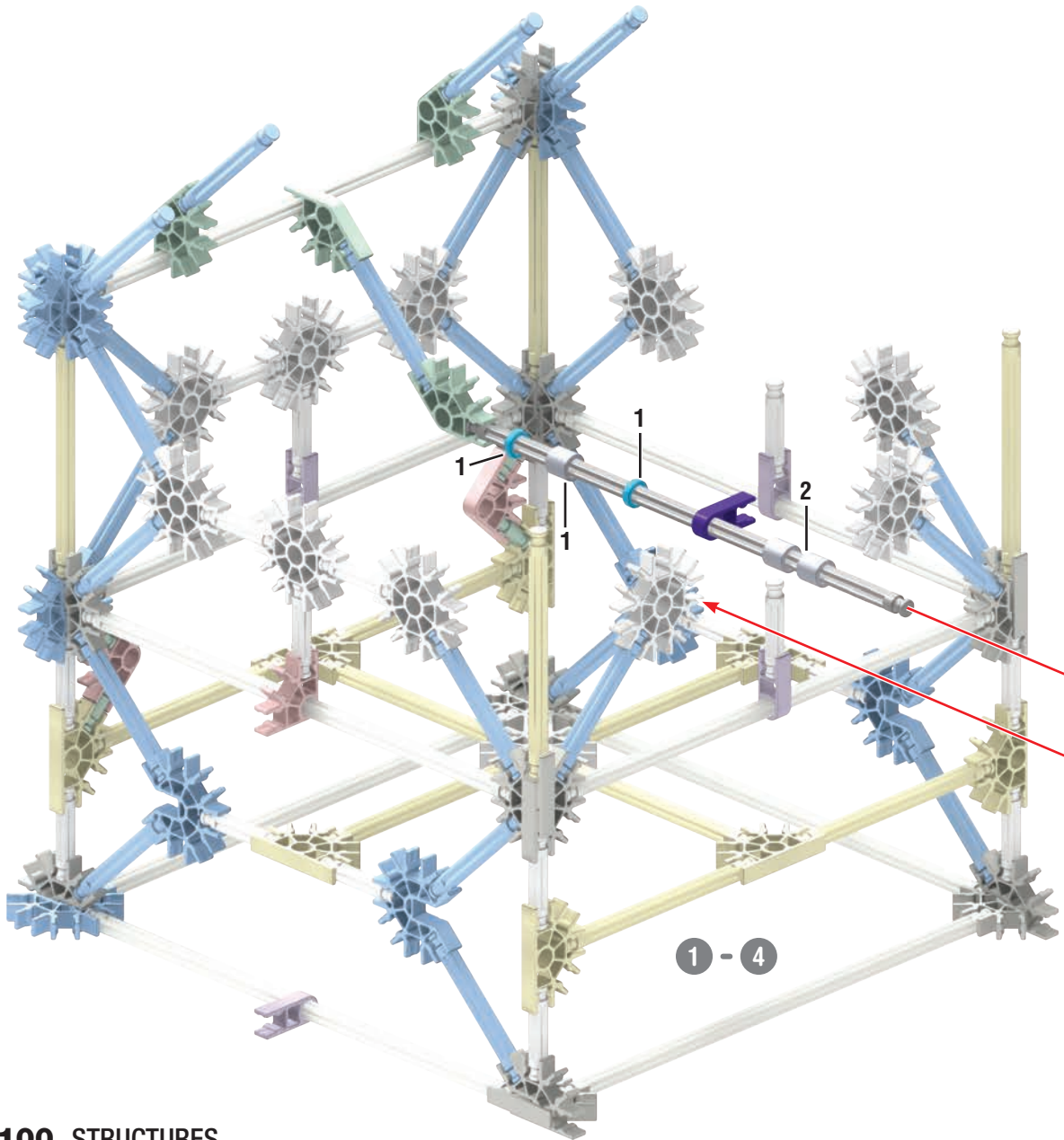

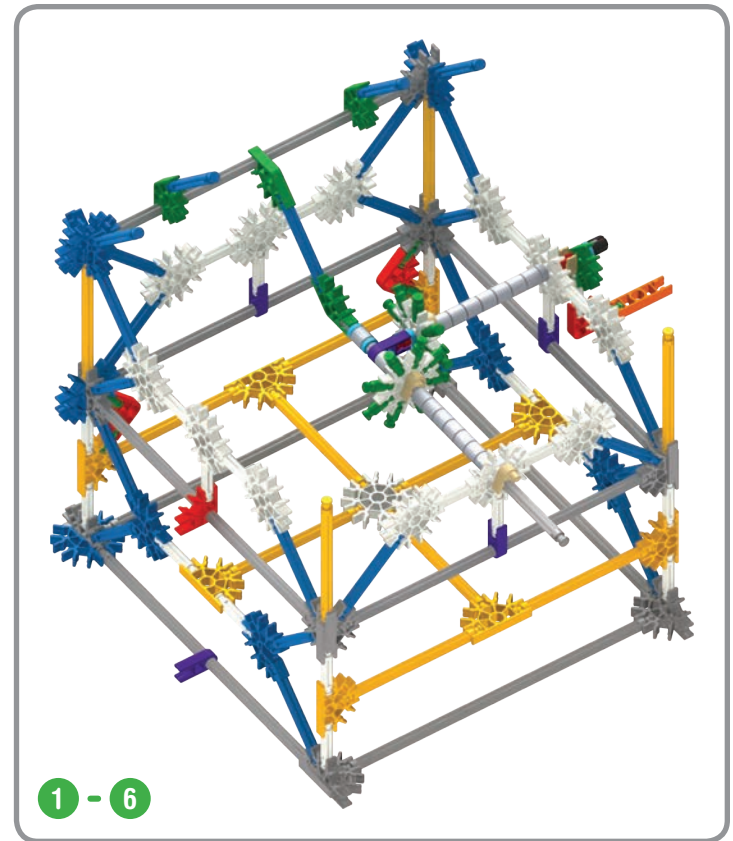
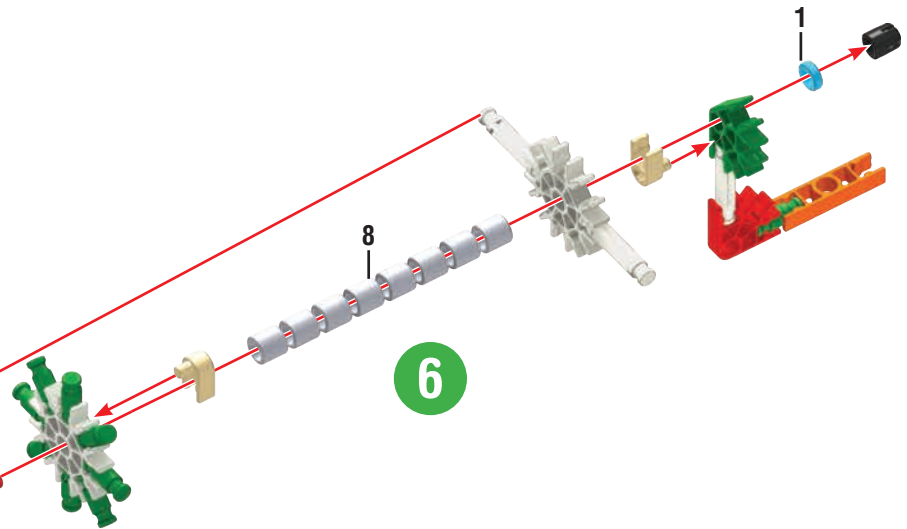
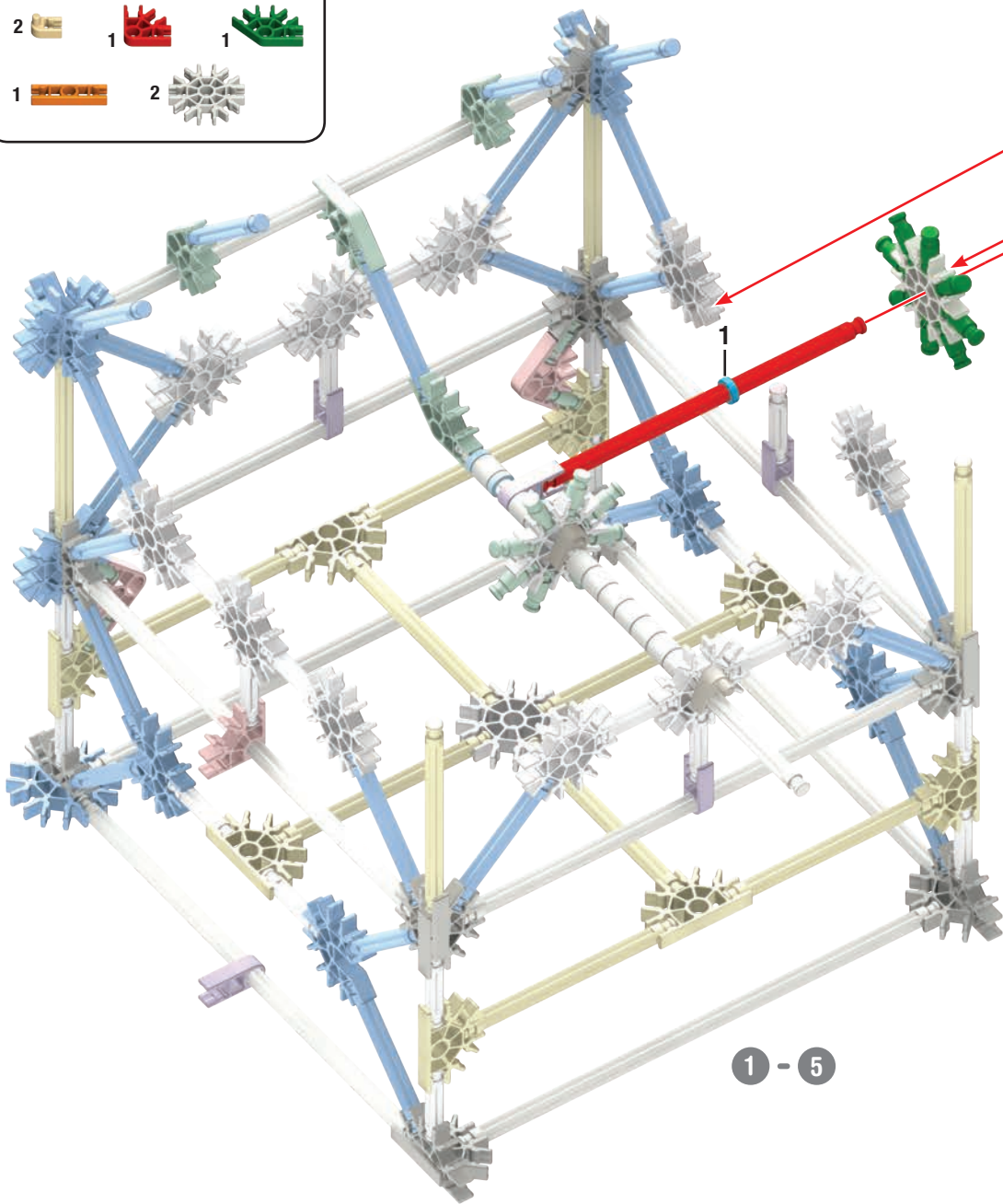
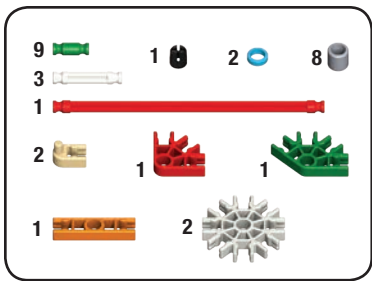

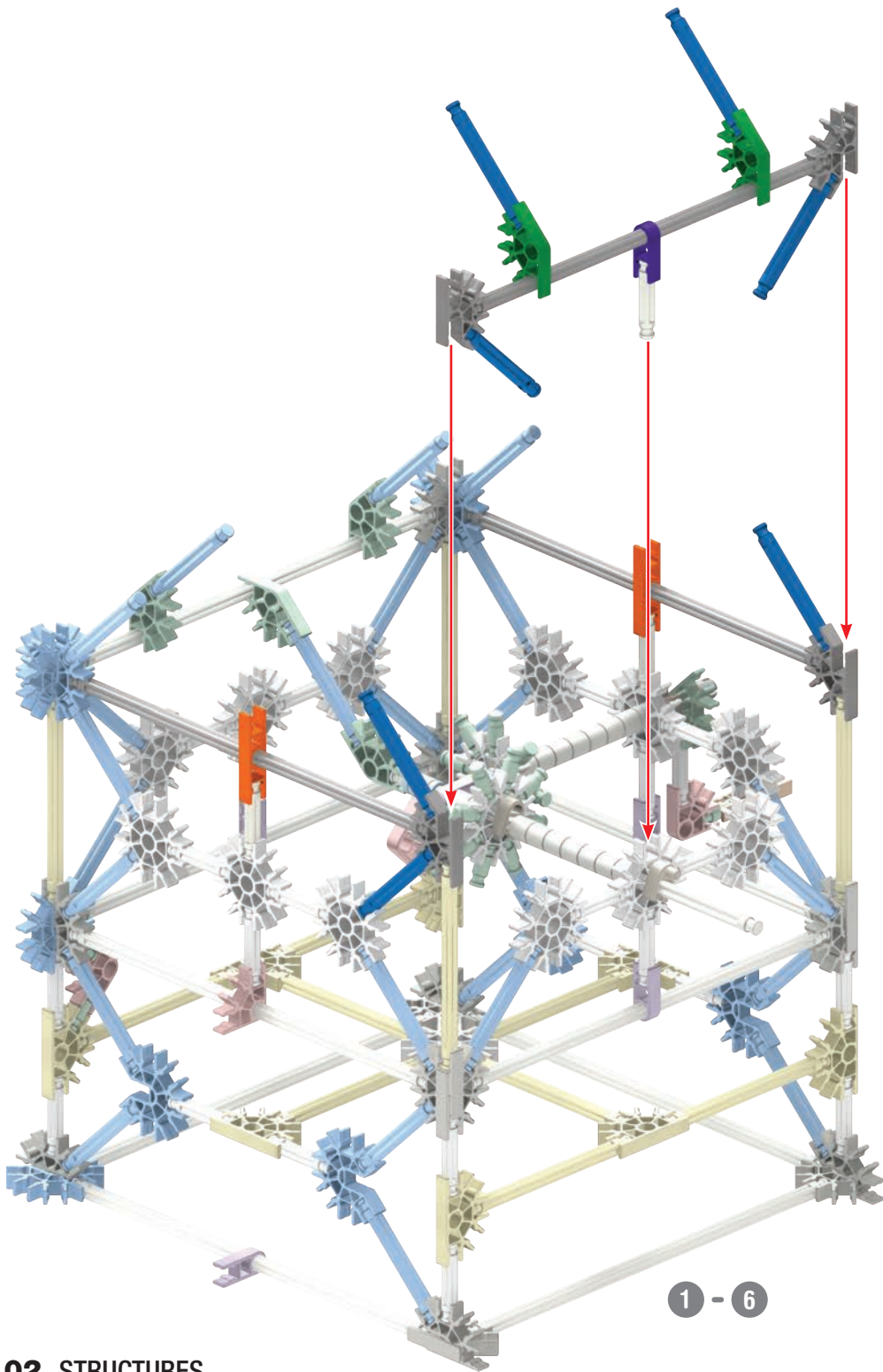

7

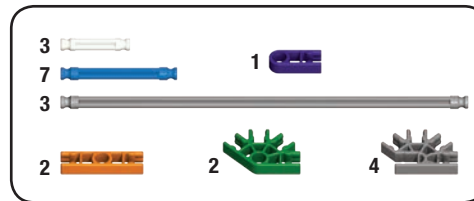
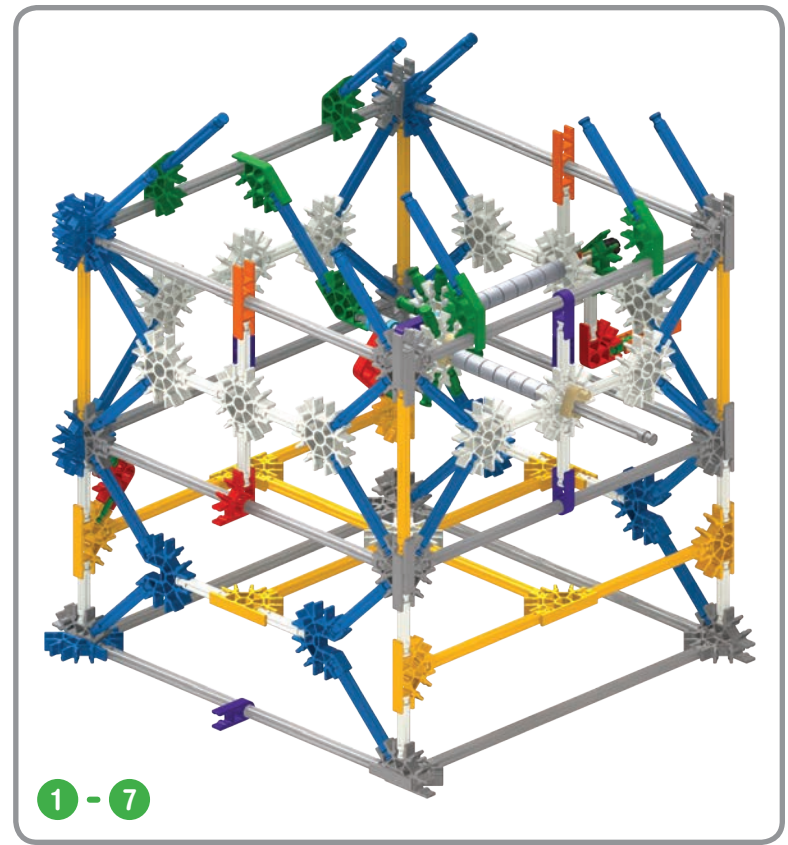

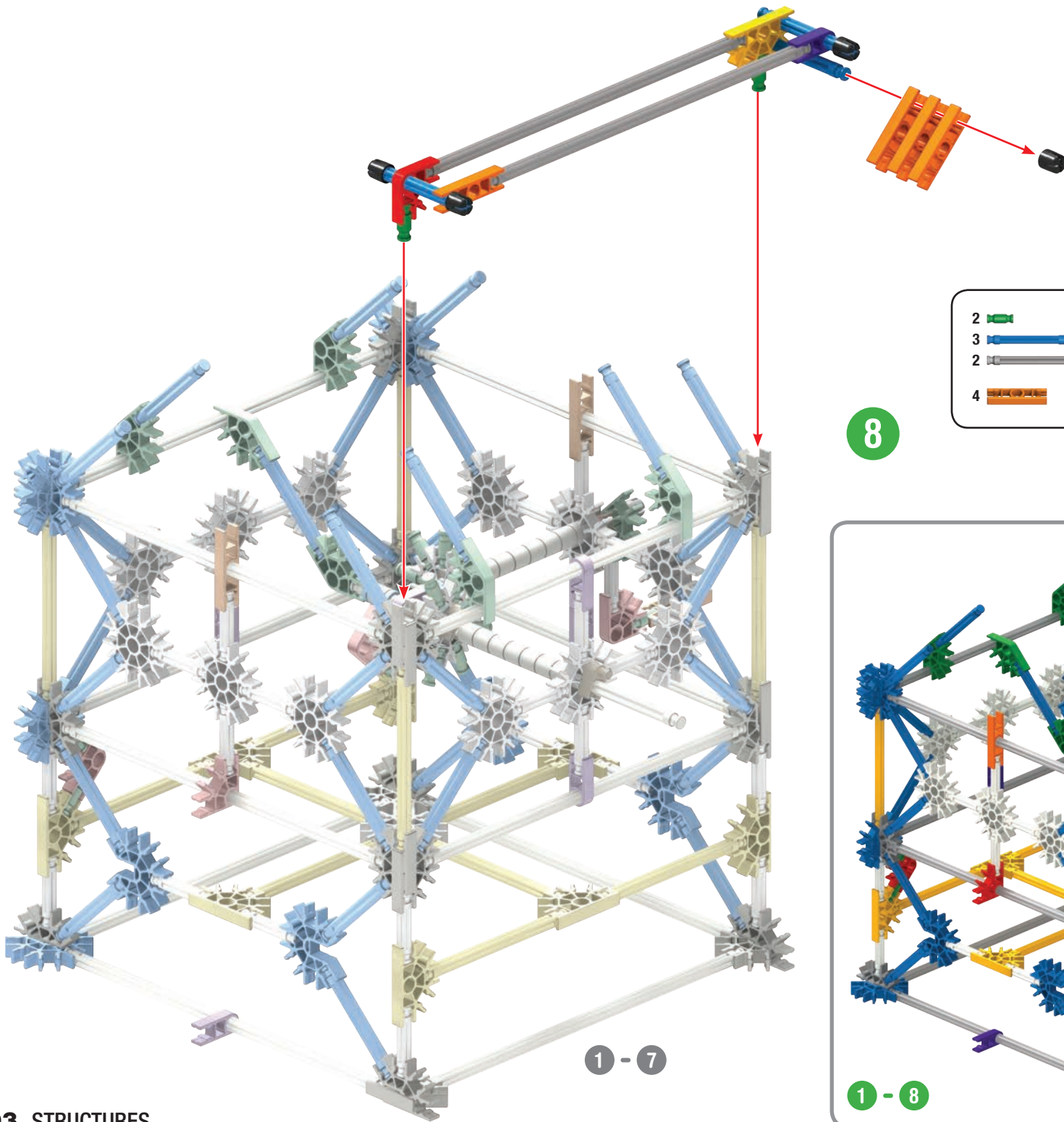

2		4		1	
3					
2					
4		1		1	

8

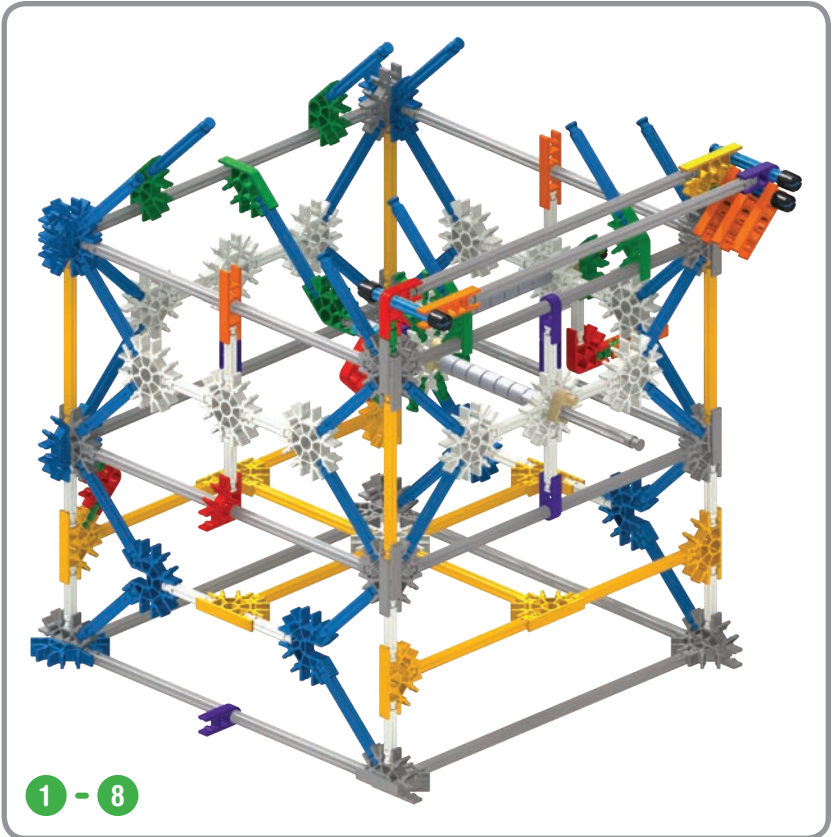

1 - 8

1 - 7

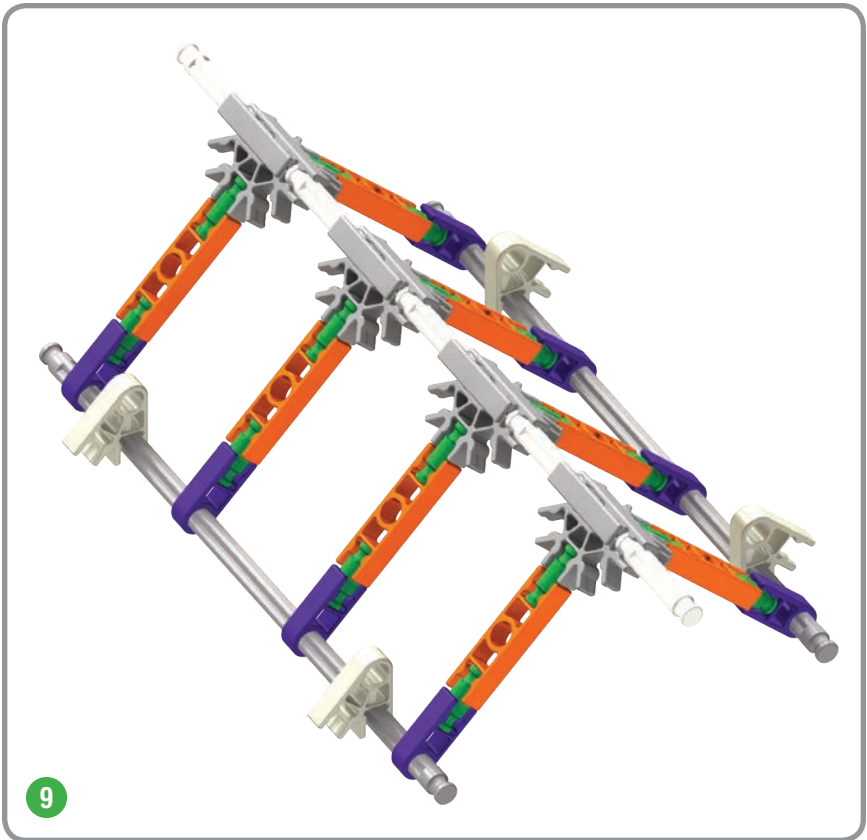
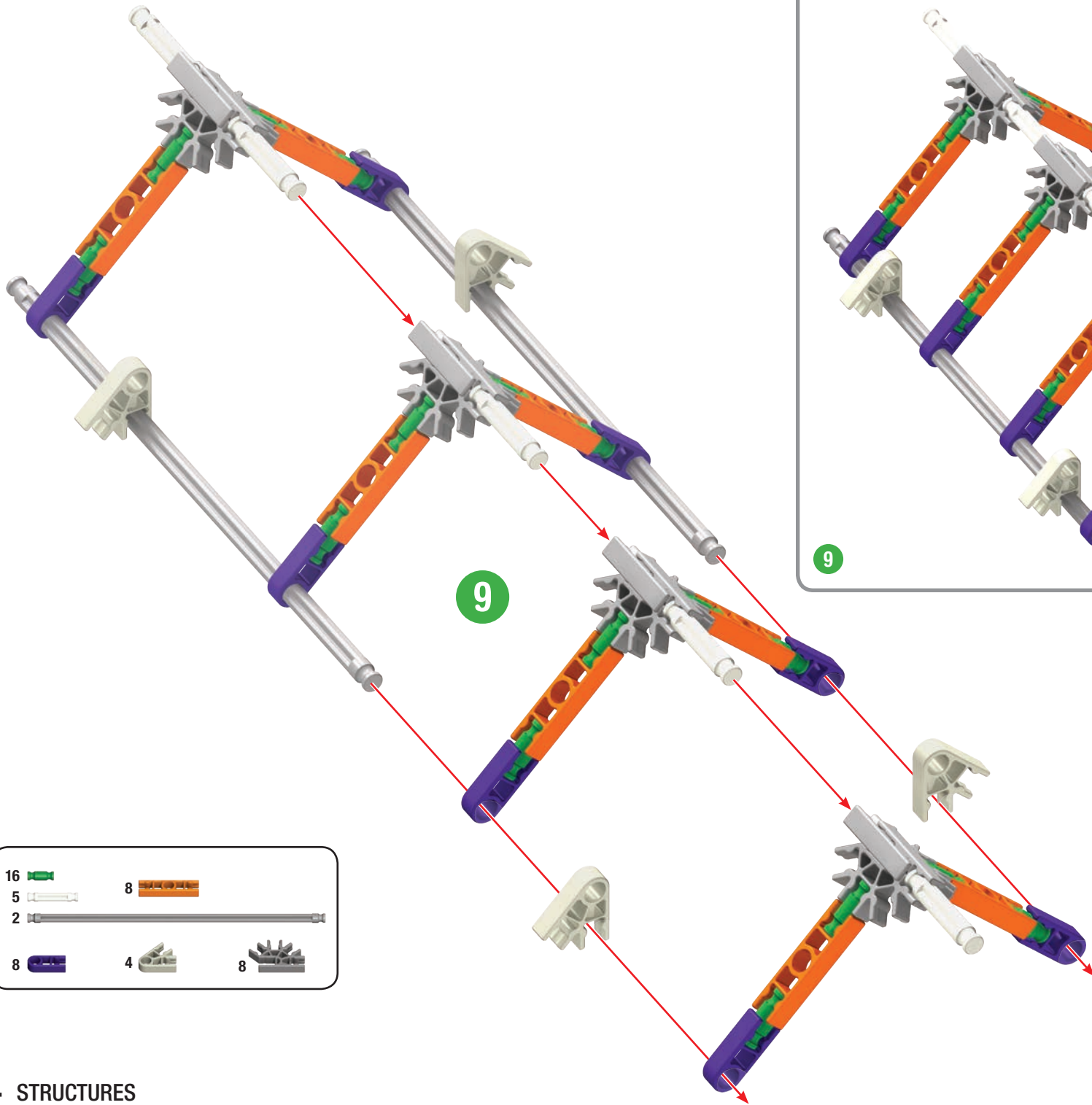

- | | | | |
|----|--|---|--|
| 16 | | 8 | |
| 5 | | | |
| 2 | | | |
| 8 | | 4 | |
| | | 8 | |

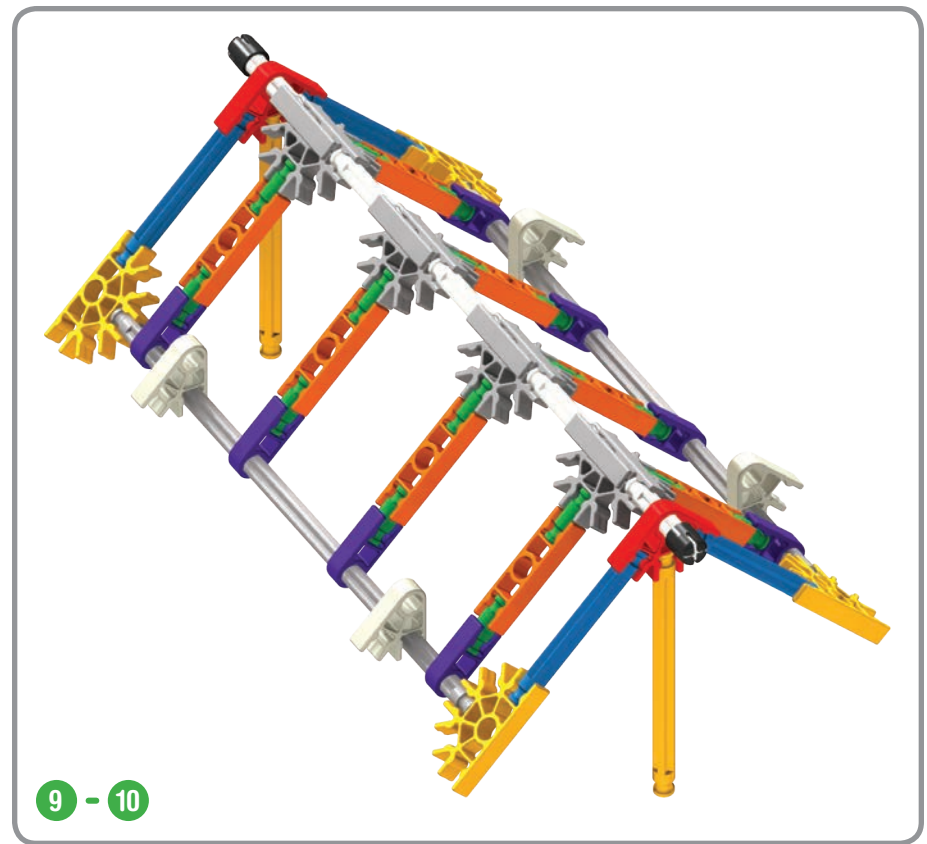
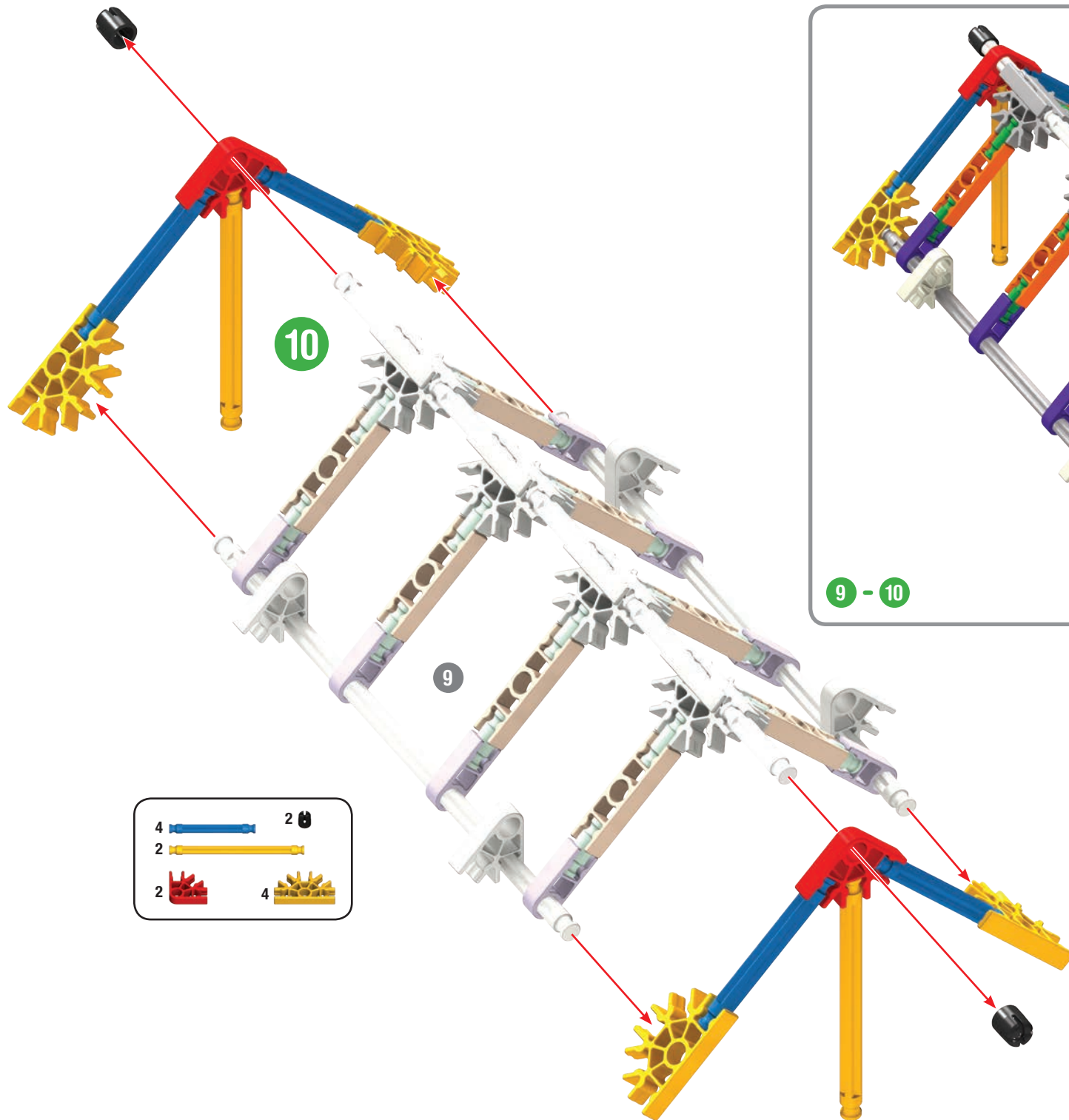

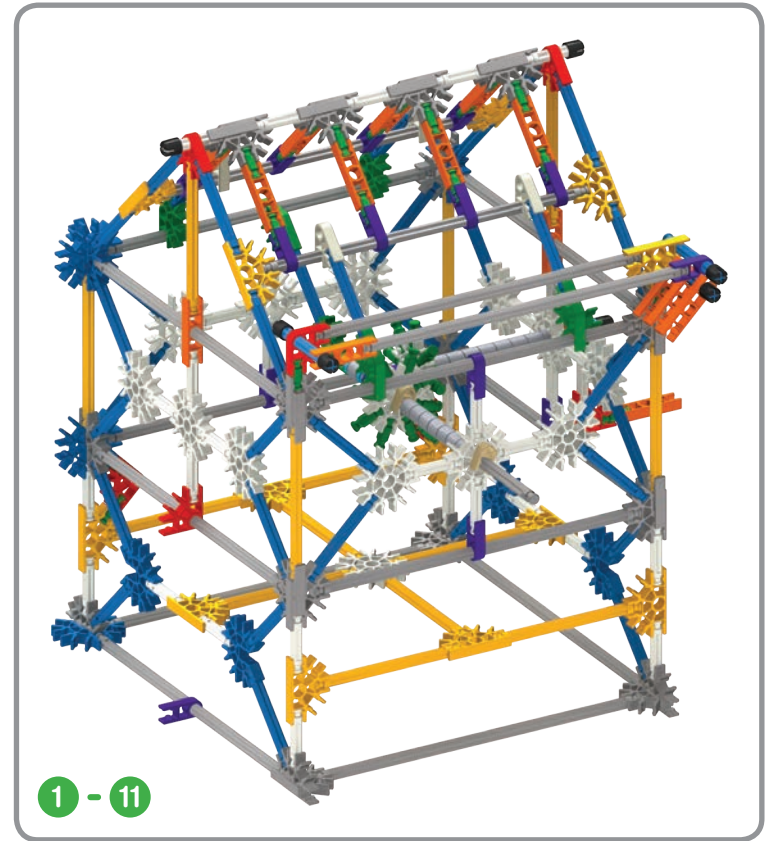
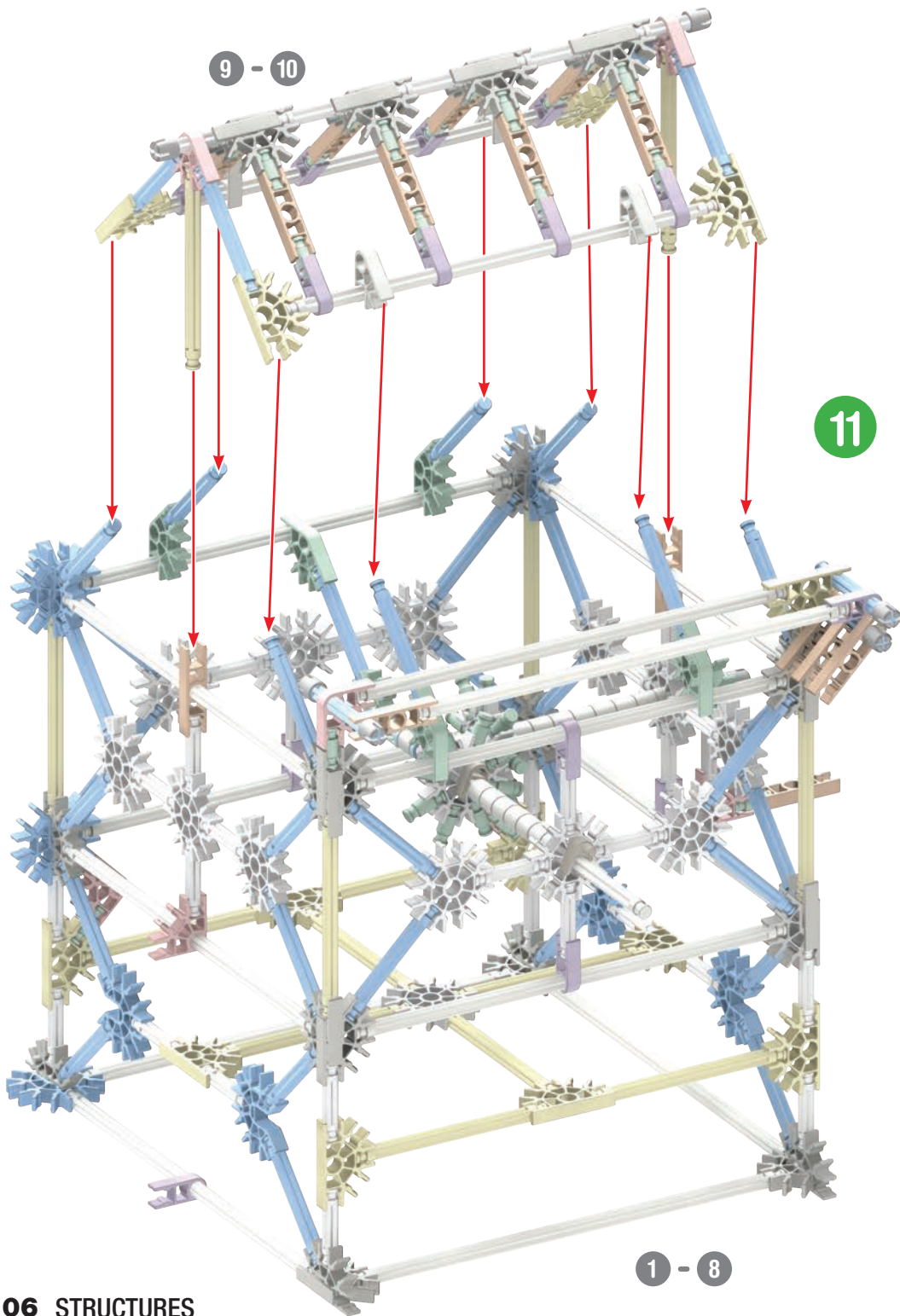

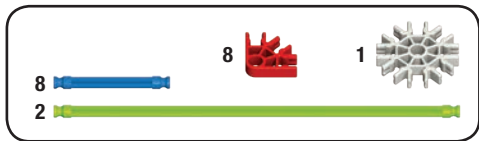

12

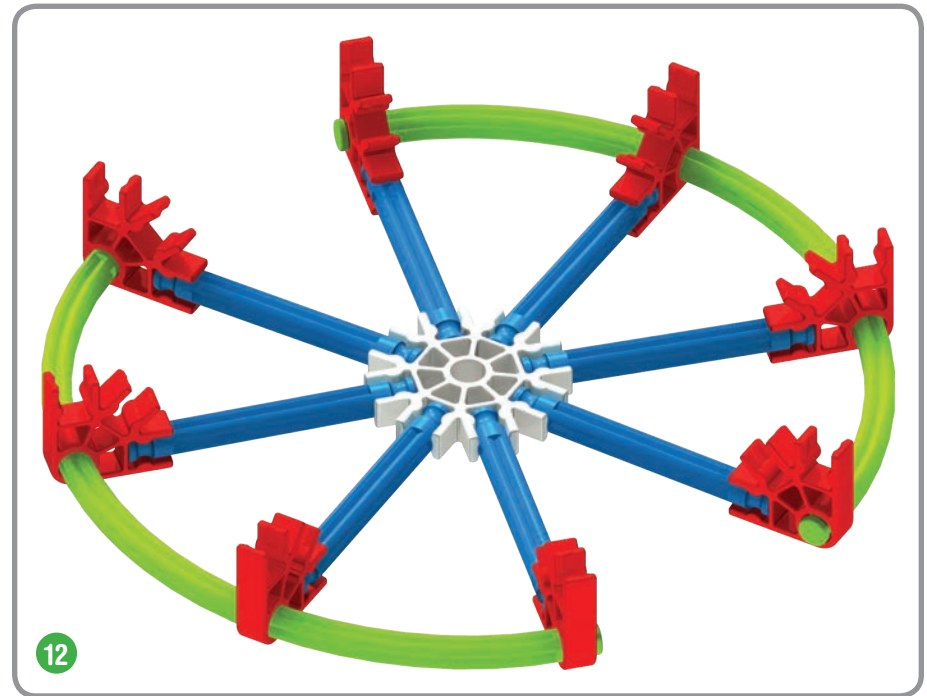
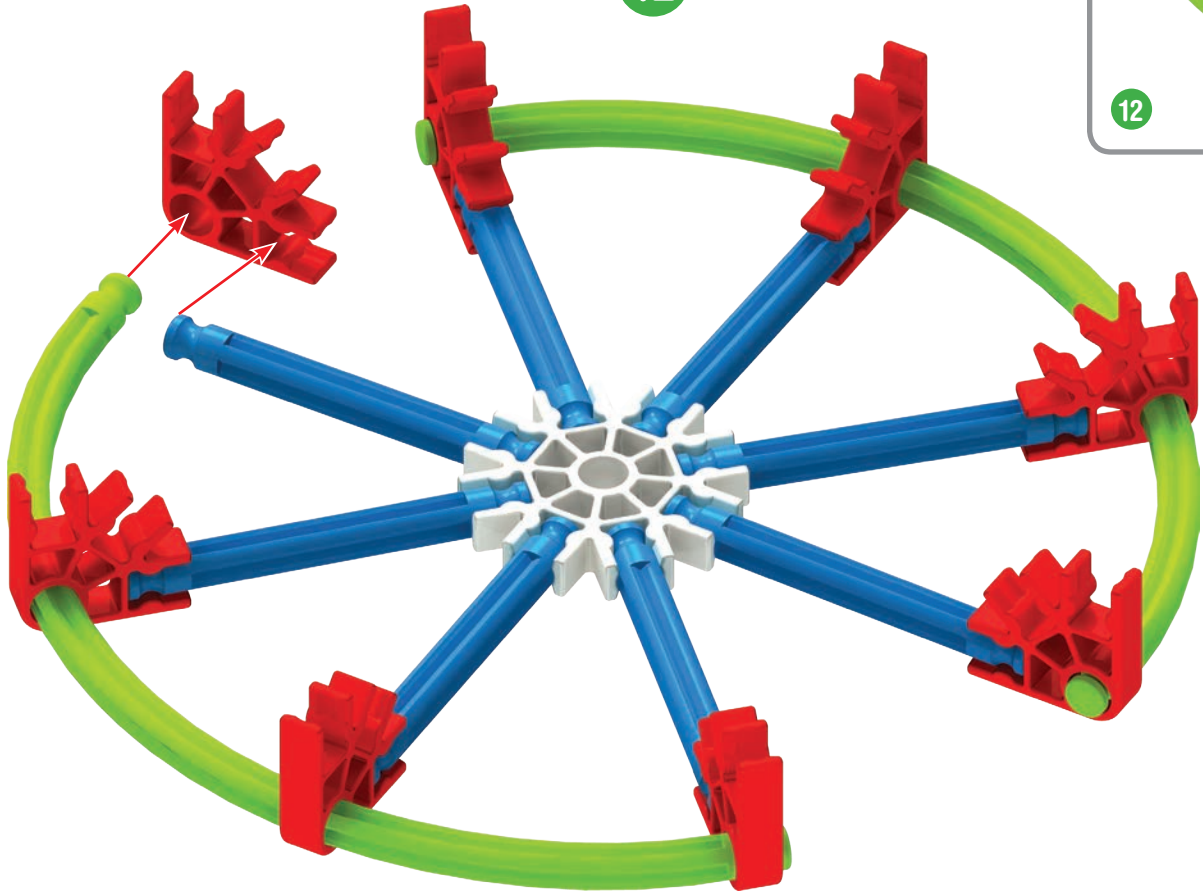

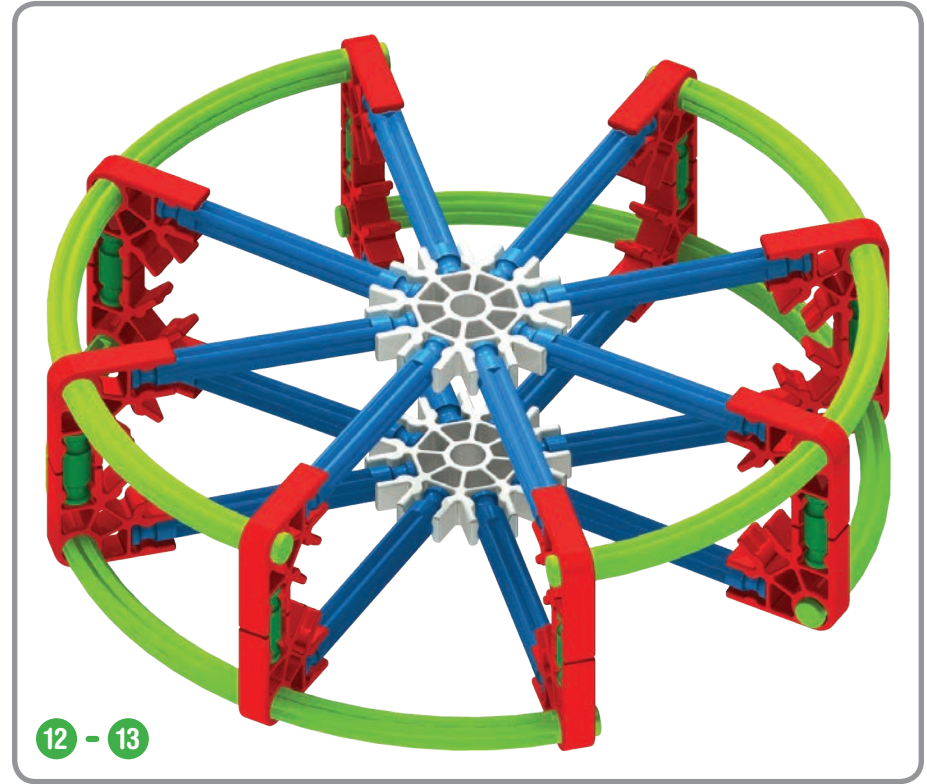
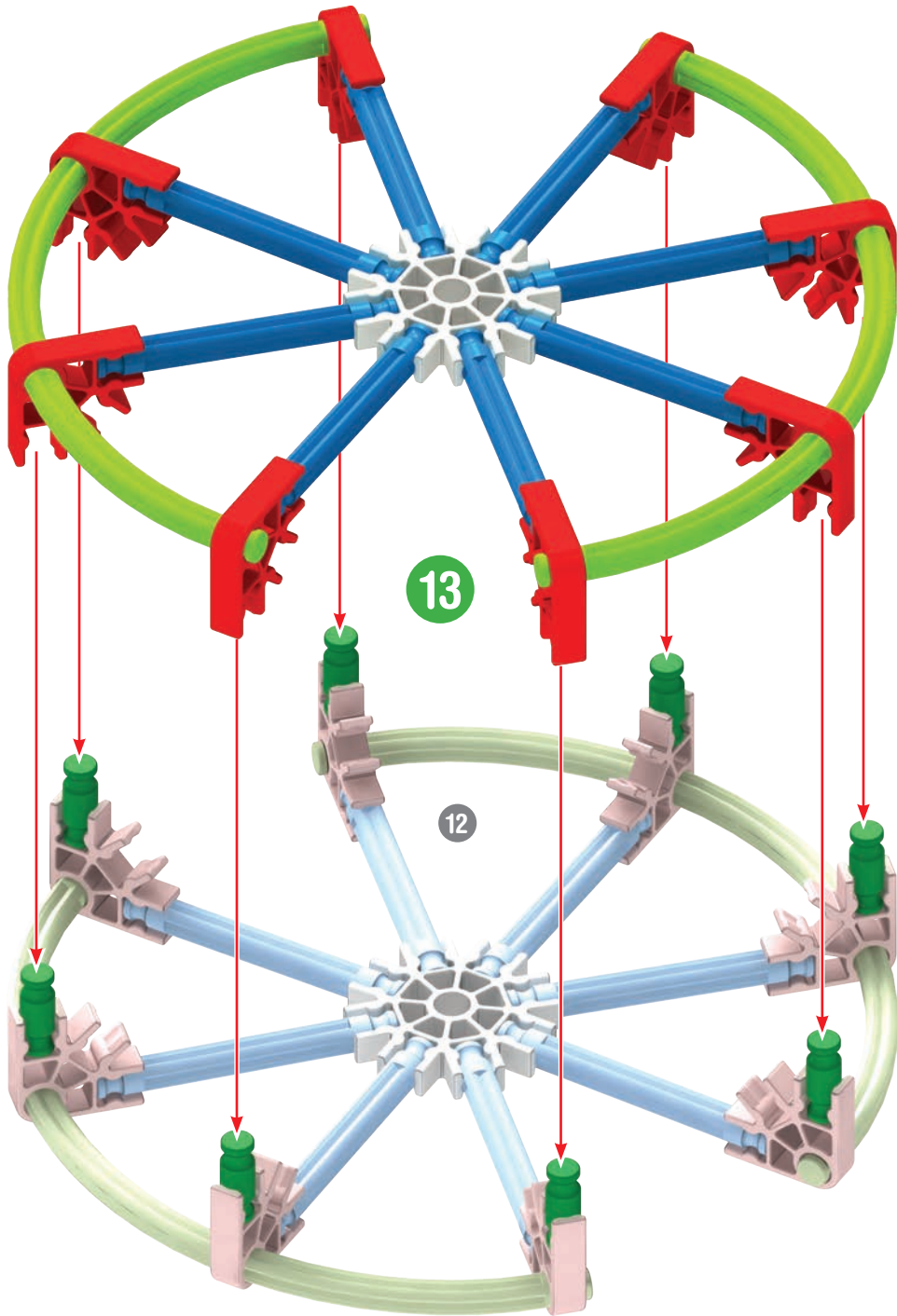

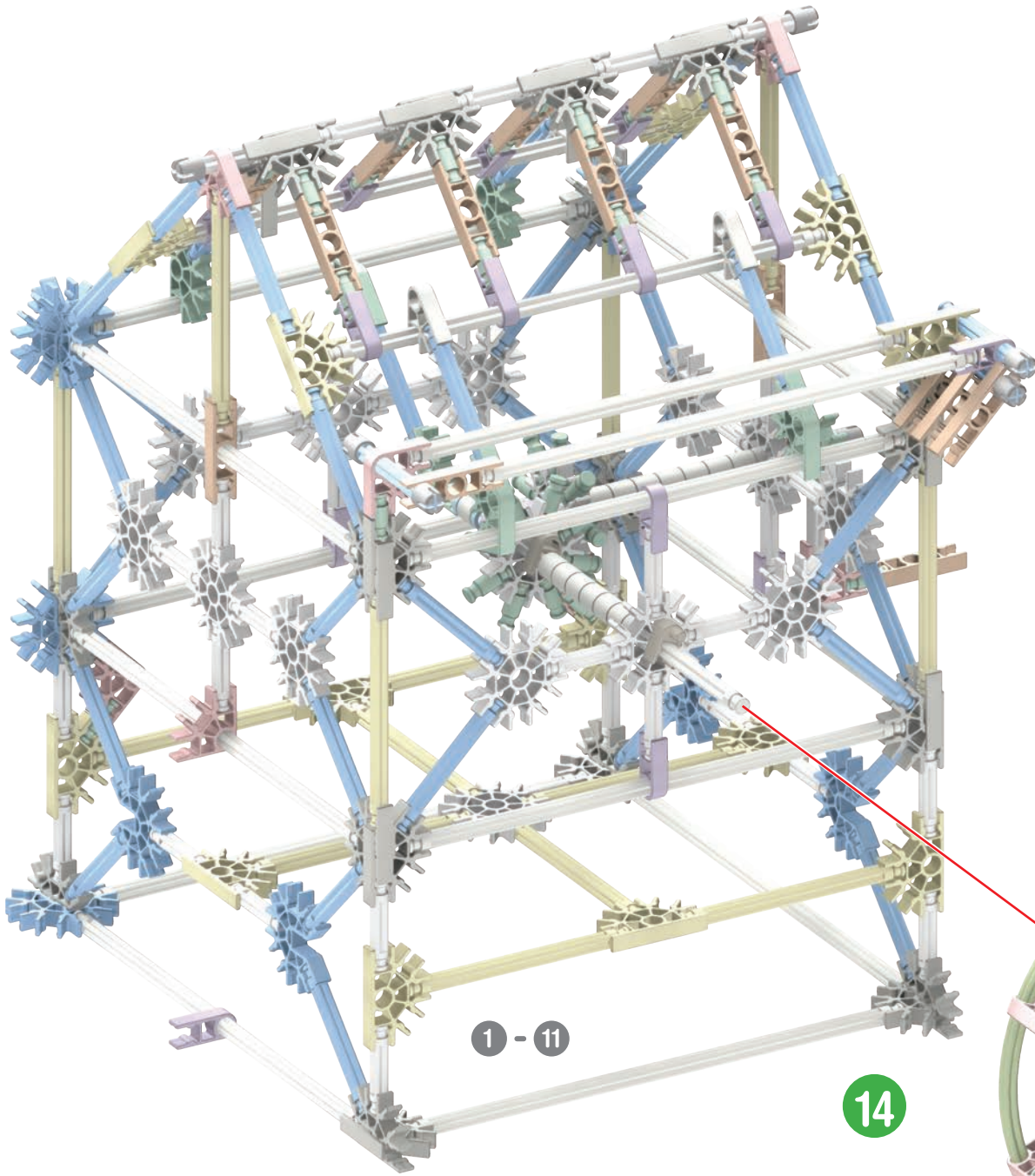

1 - 11

14

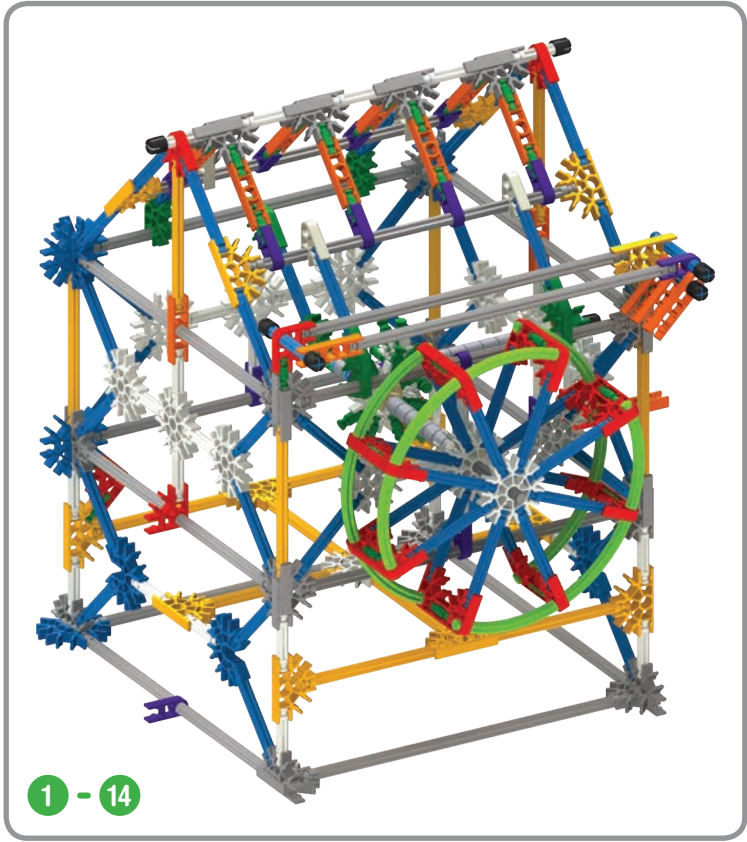

1 - 14

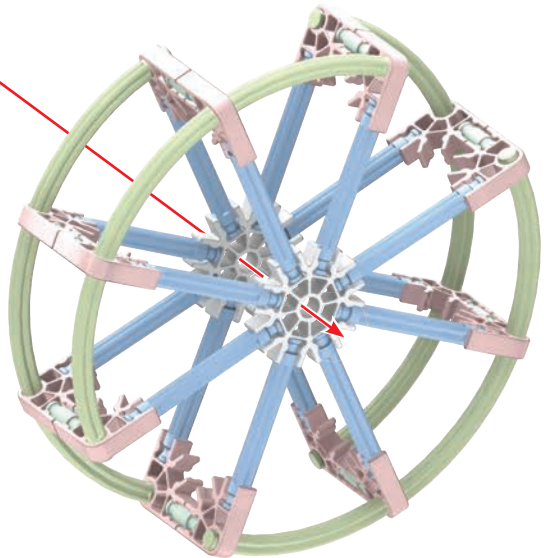

12 - 13

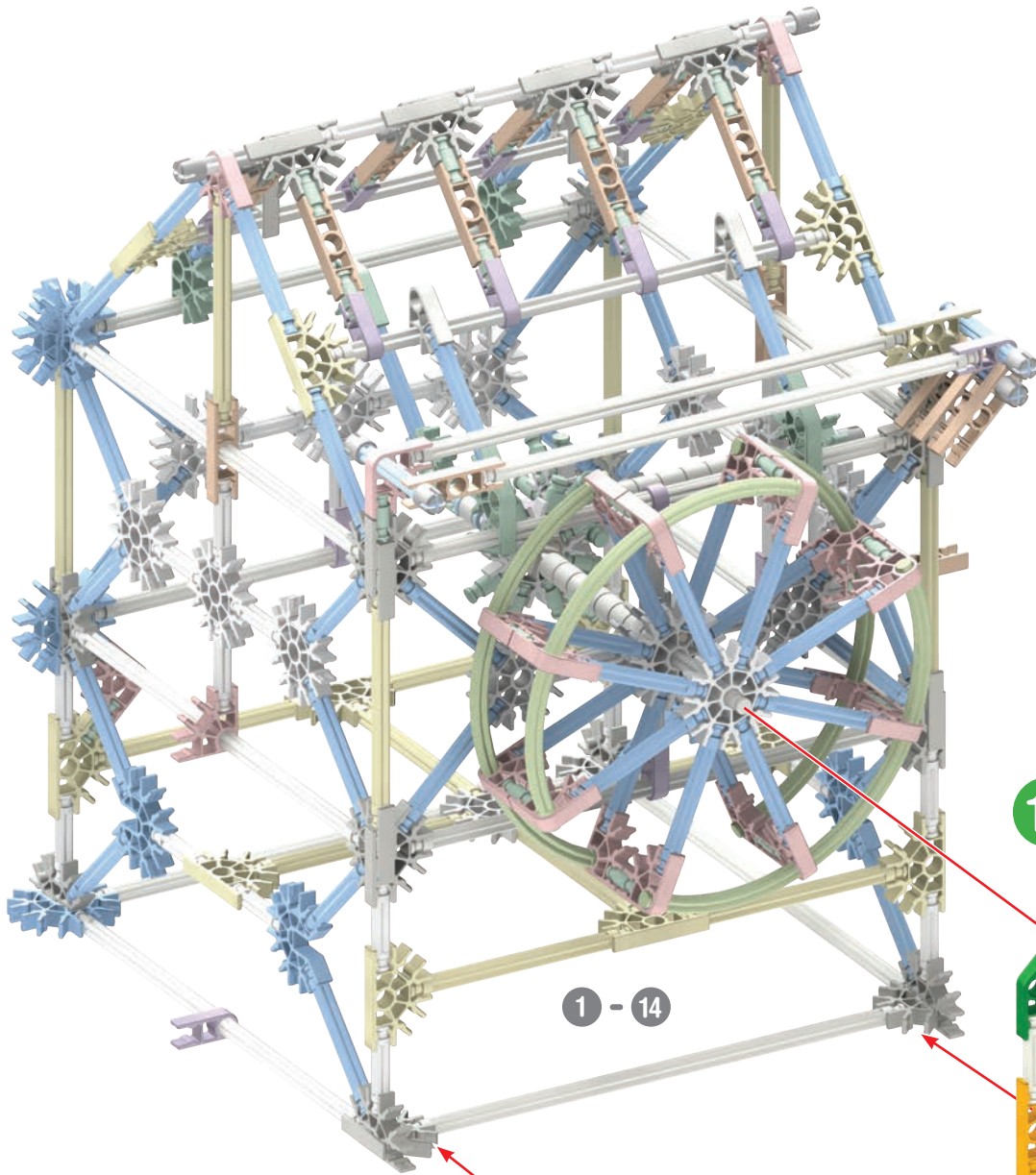

1 - 14

15

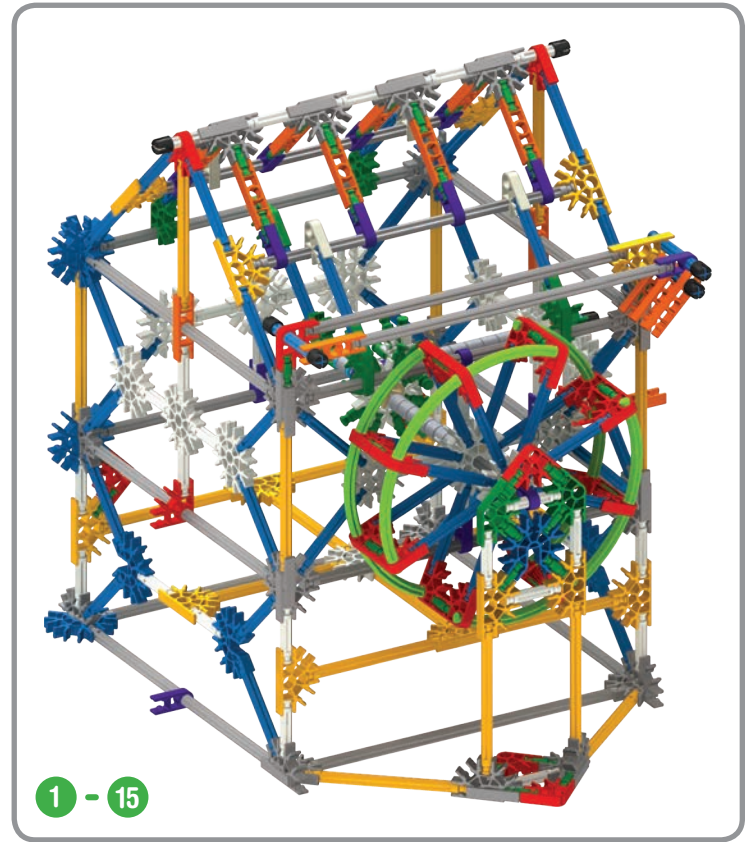

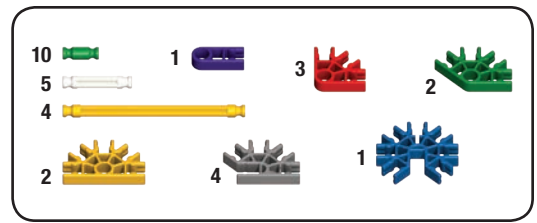

1 - 15

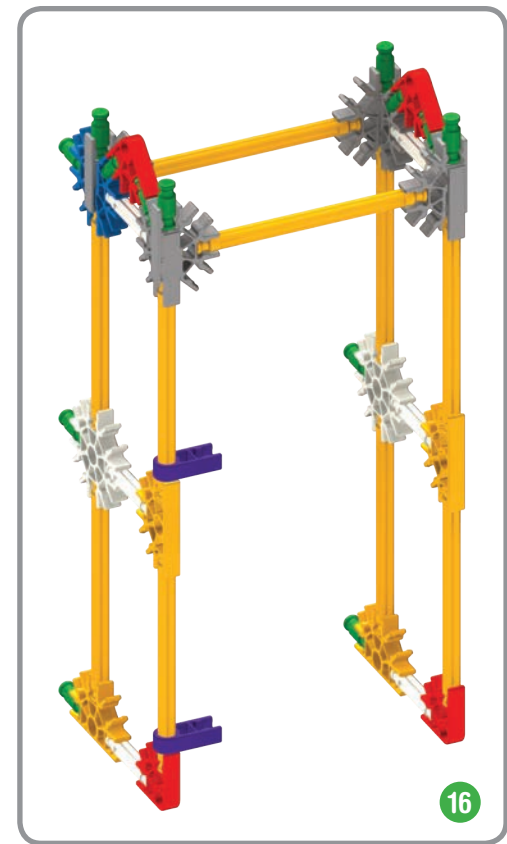
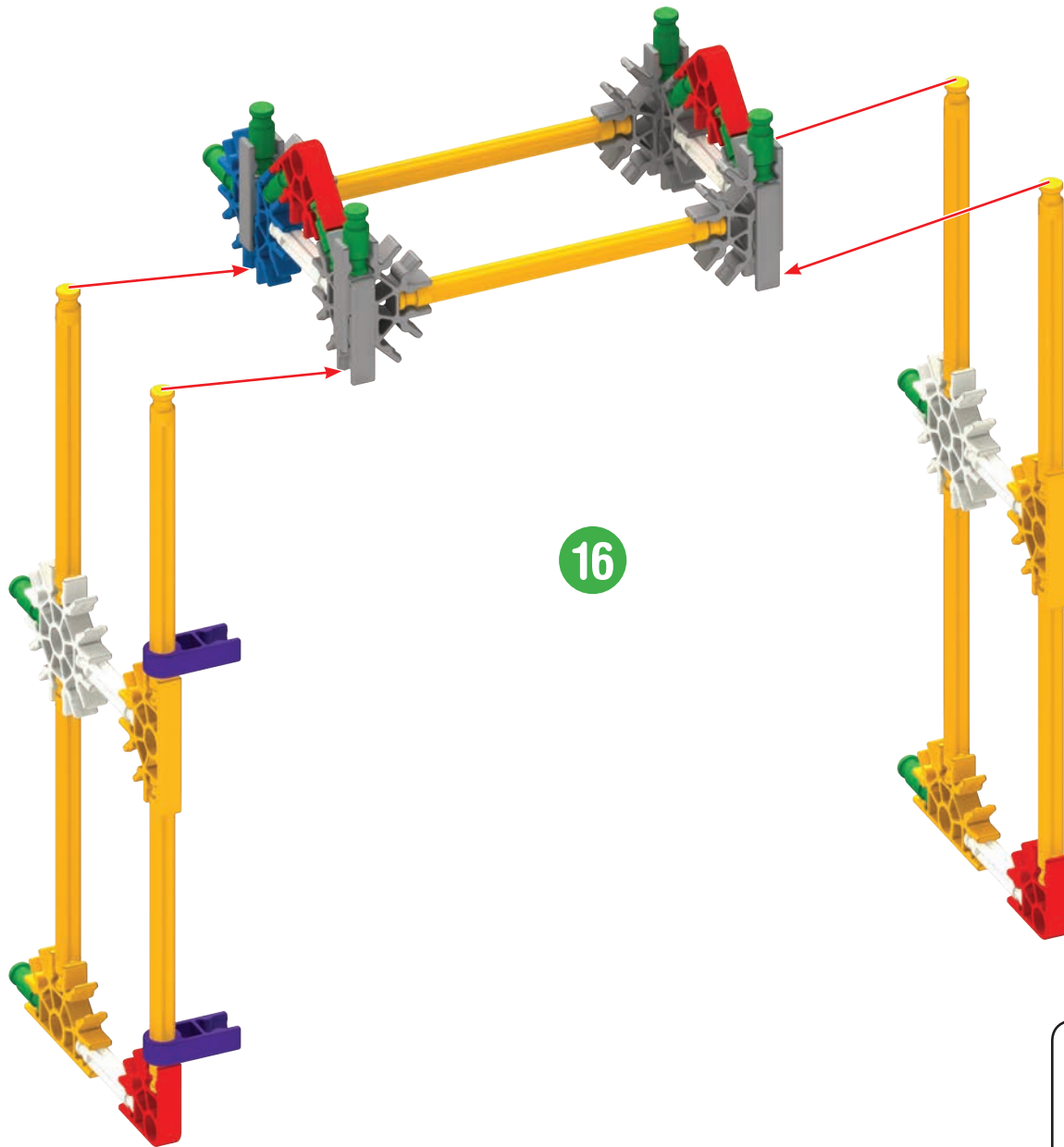



- | | | | | | | | |
|----|--|---|--|---|--|---|--|
| 13 | | 2 | | 4 | | 2 | |
| 6 | | | | | | | |
| 10 | | | | | | | |
| 4 | | 7 | | 1 | | | |

16		8	
4			

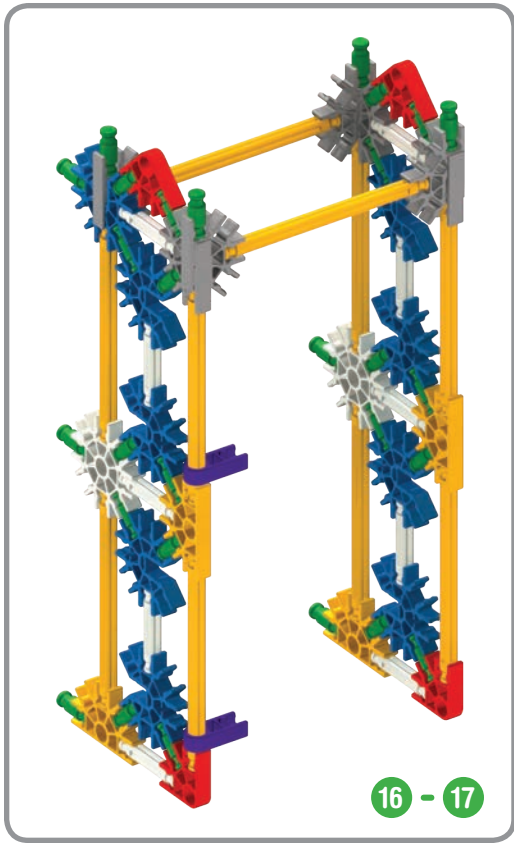
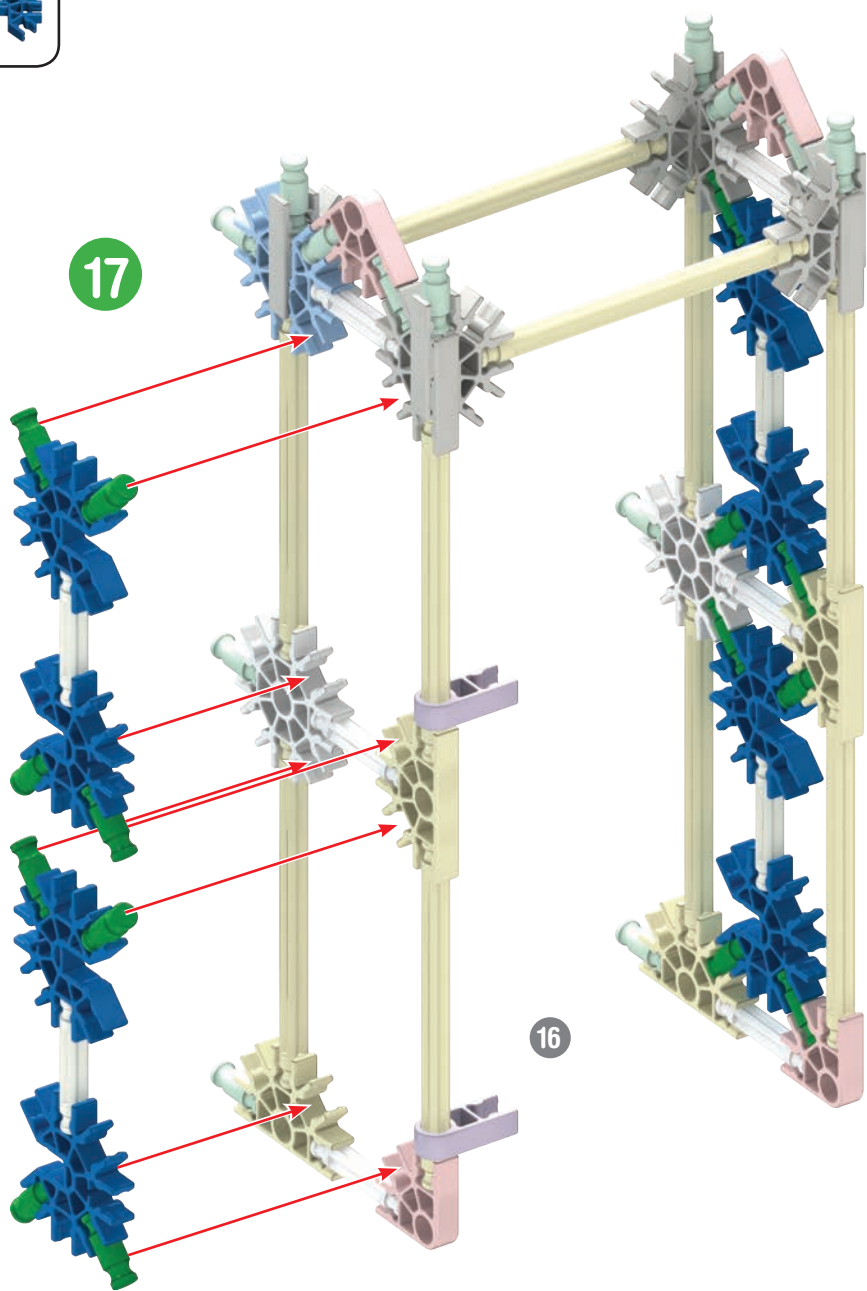

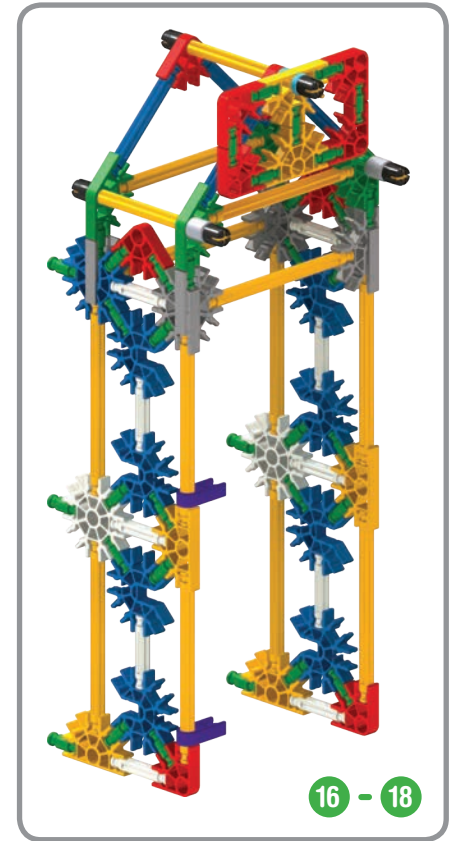
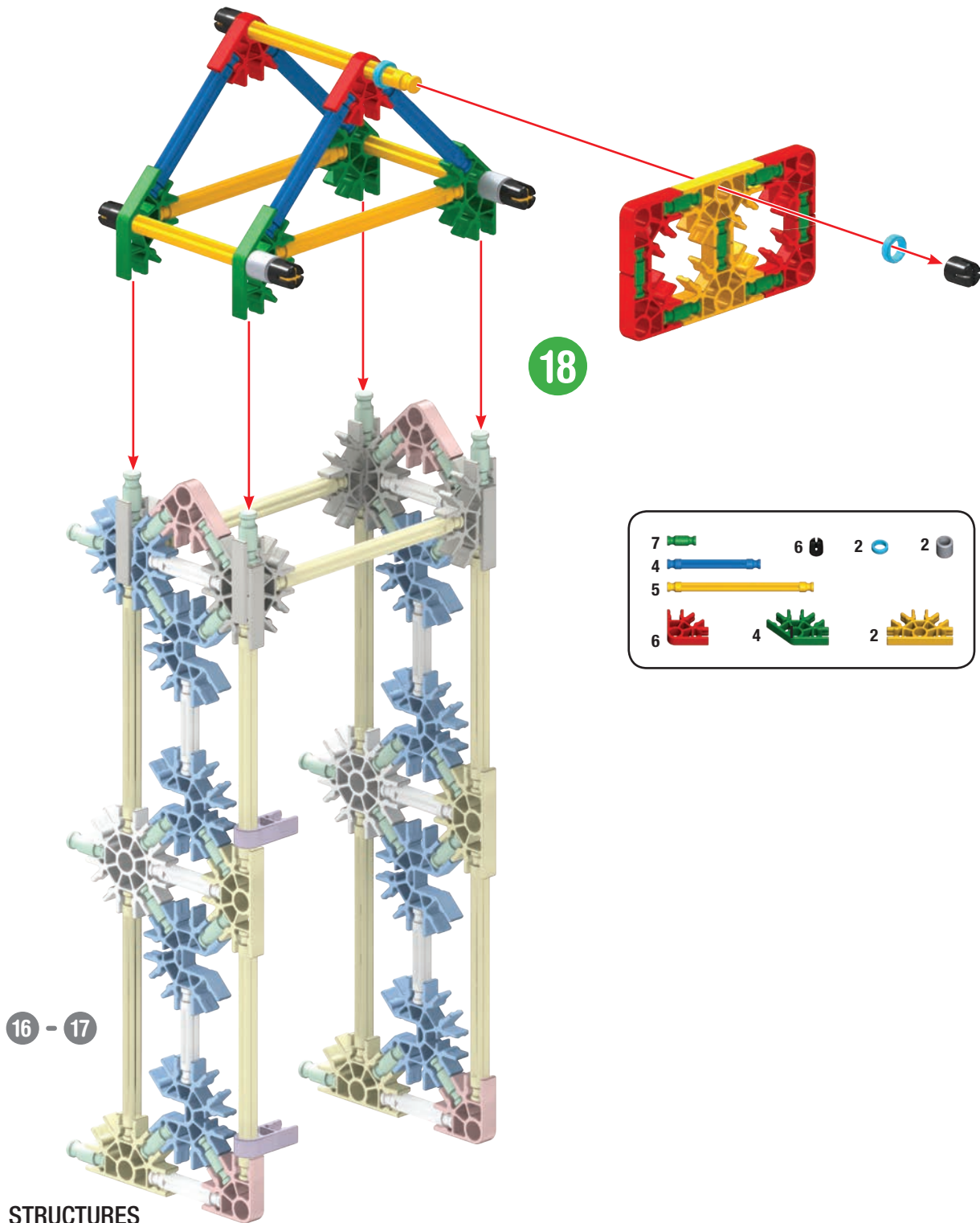

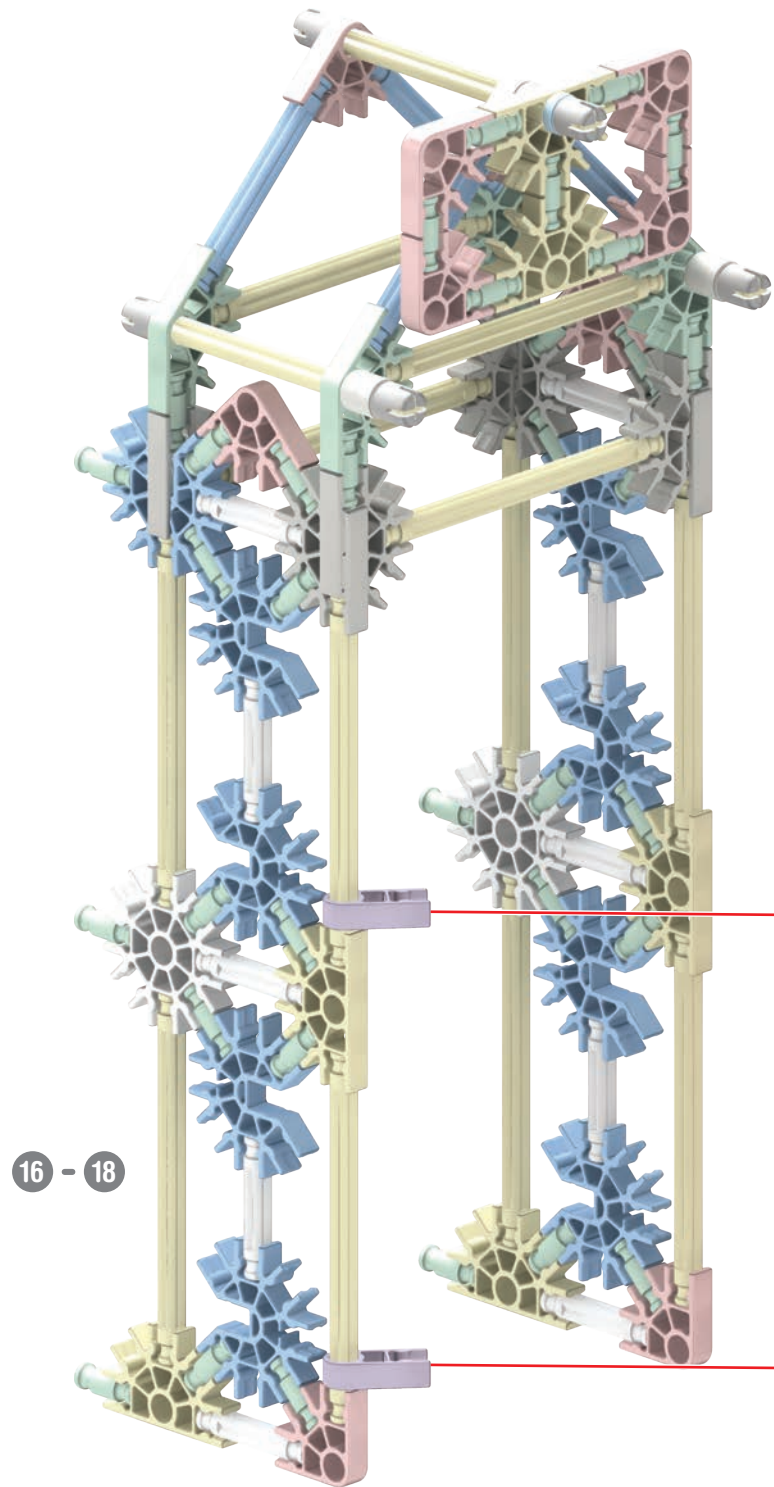

16 - 18

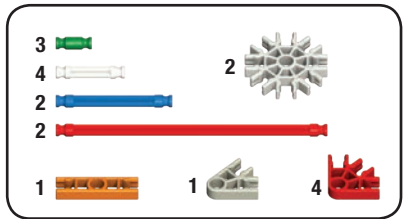

19

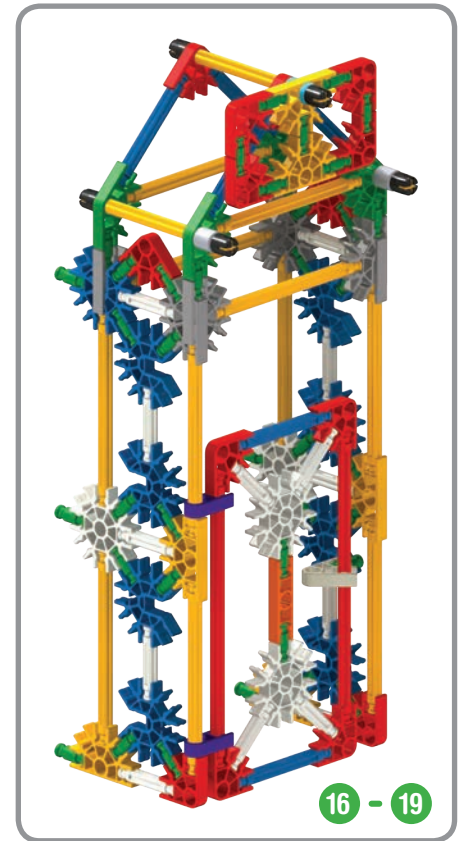
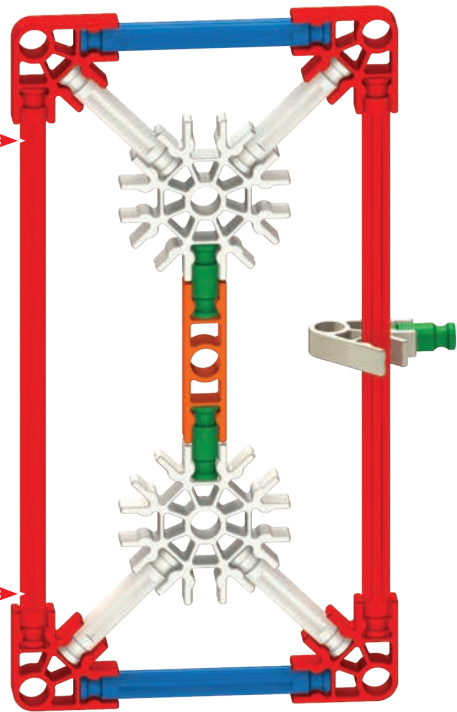

16 - 19

Watermill

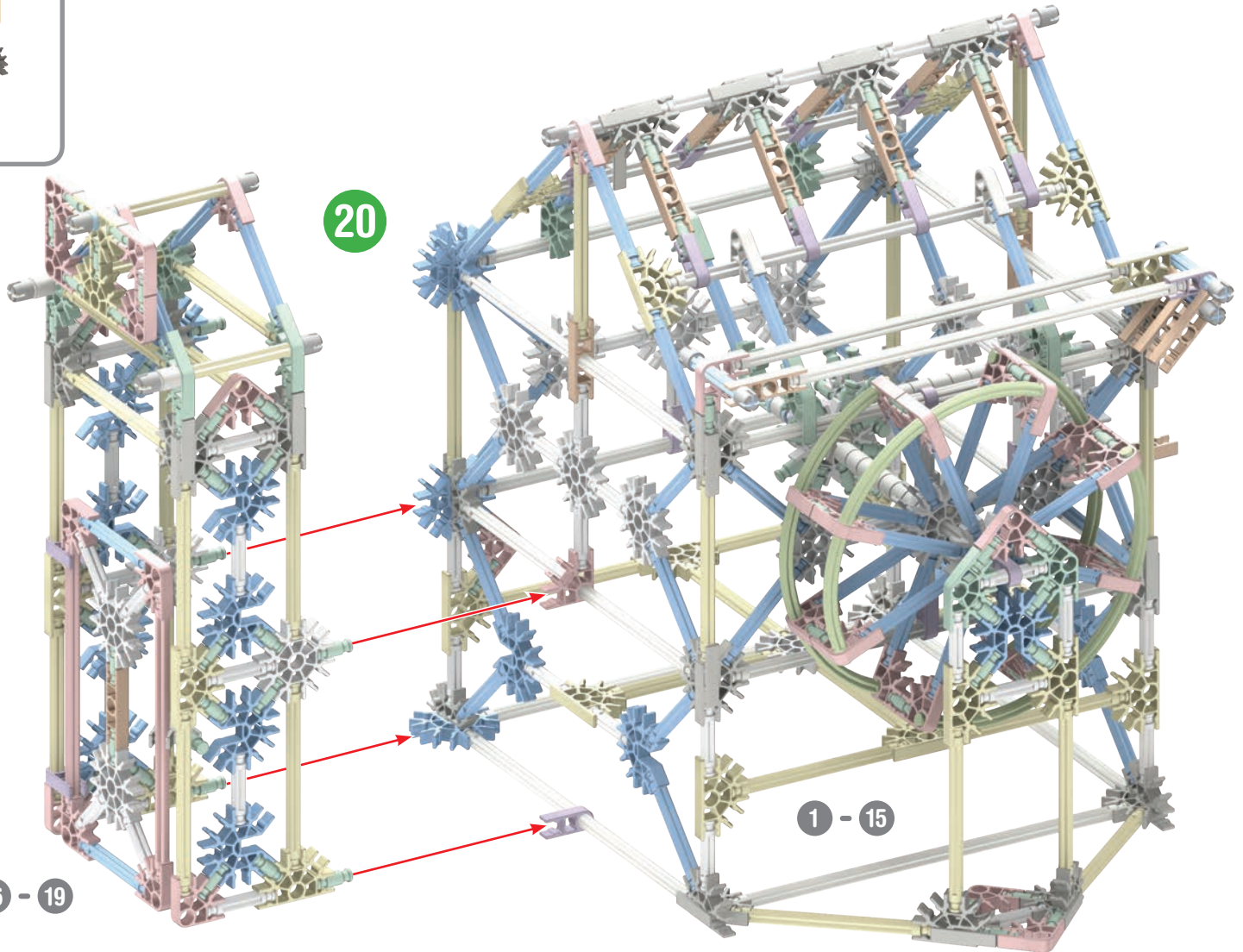
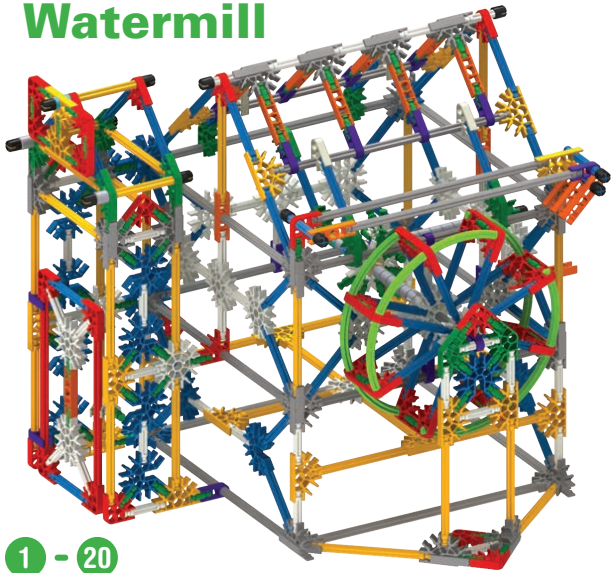

16 - 19

1 - 15