

15426

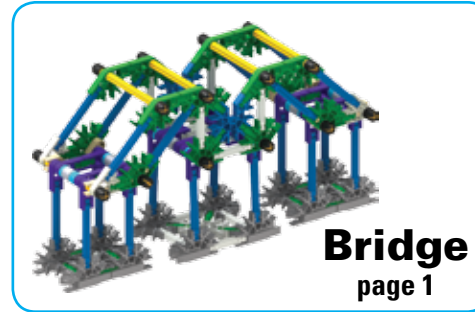

100 MODEL ULTRA
BUILDING SET

STRUCTURES



Bridge
page 1

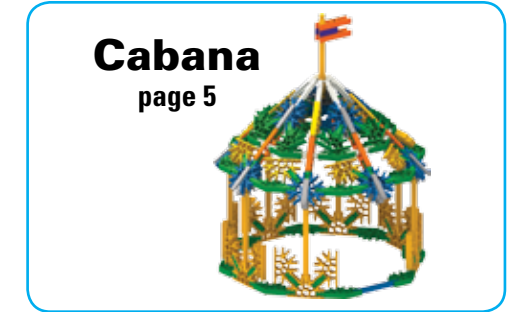

Cabana
page 5



Car Wash
page 10



Castle
page 22



Clock Tower
page 25



House
page 36

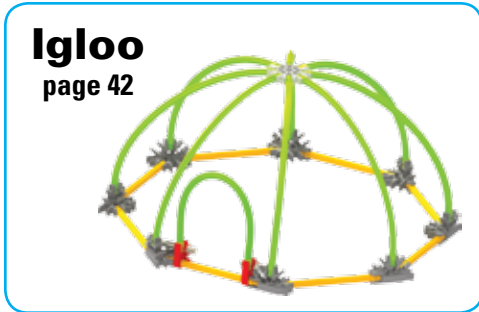

Igloo
page 42

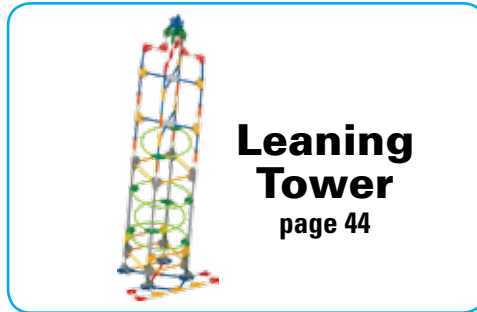

Leaning Tower
page 44

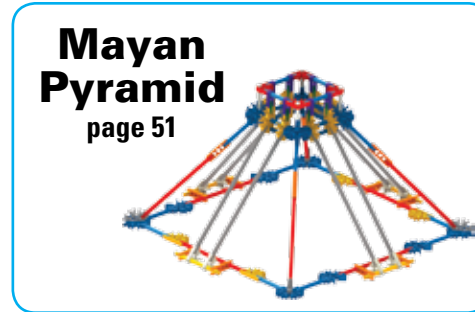

Mayan Pyramid
page 51



Observation Tower
page 58

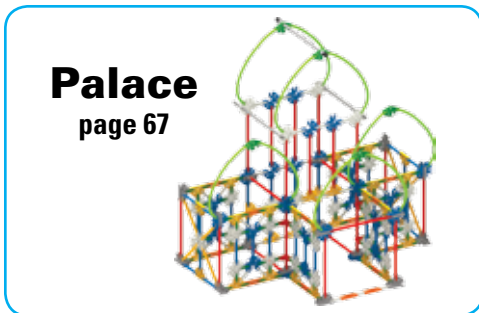

Palace
page 67

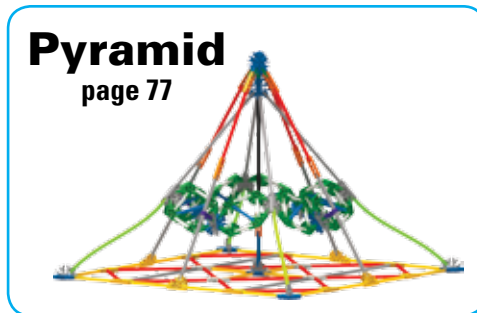

Pyramid
page 77



Treehouse
page 85

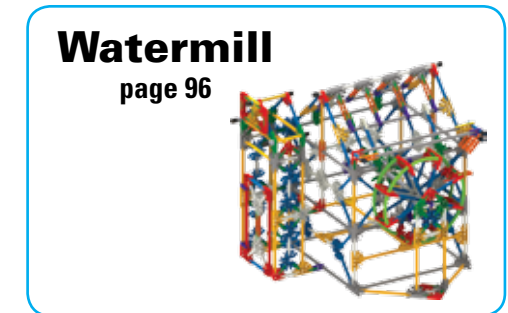

Watermill
page 96

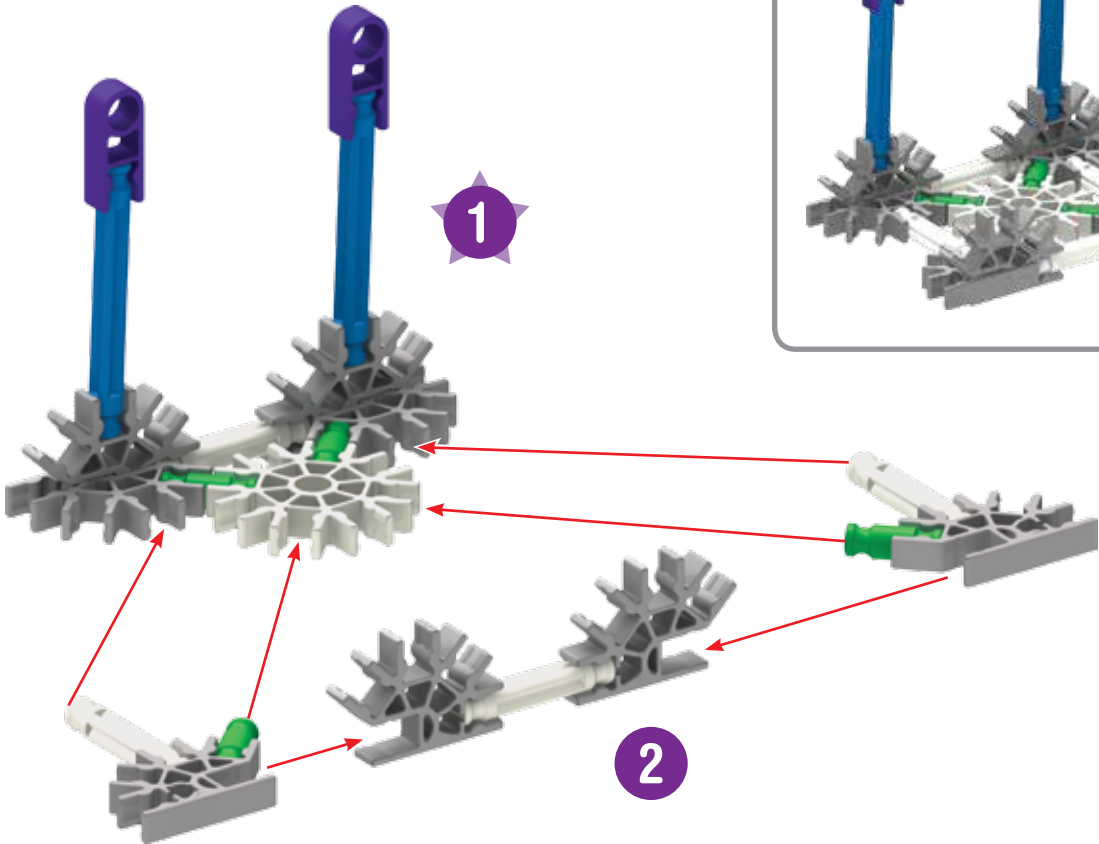
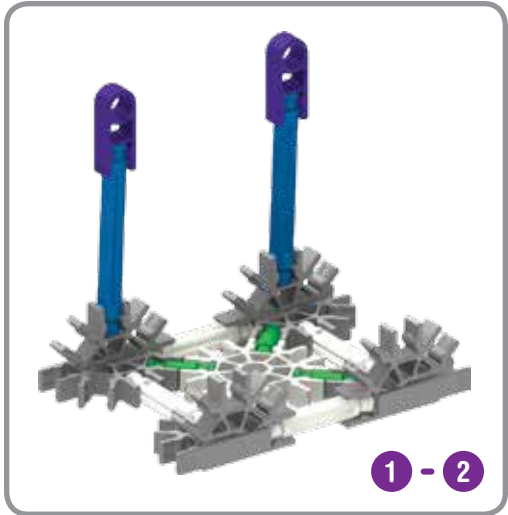

- 4
- 4
- 2
- 2
- 8
- 1

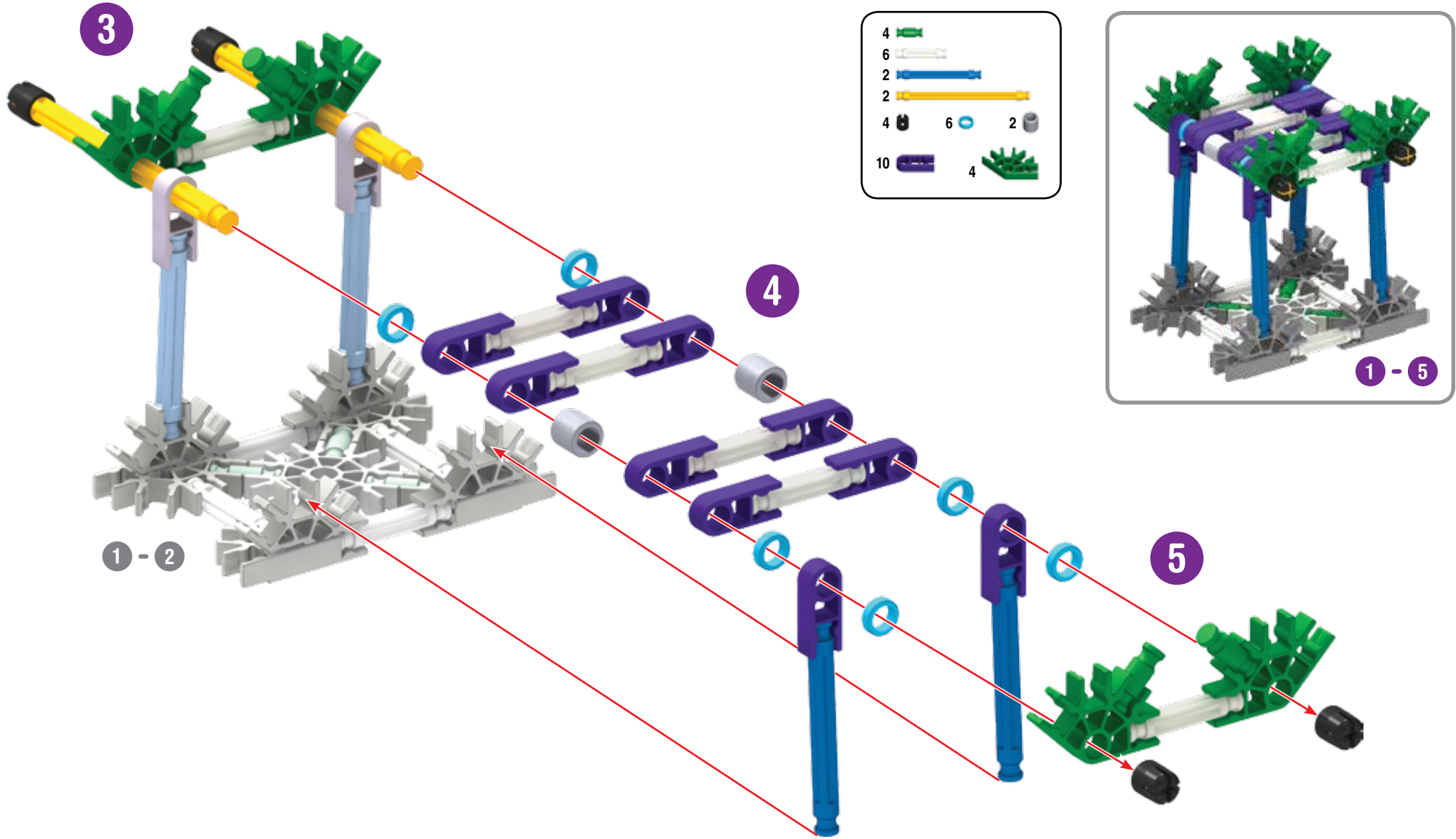



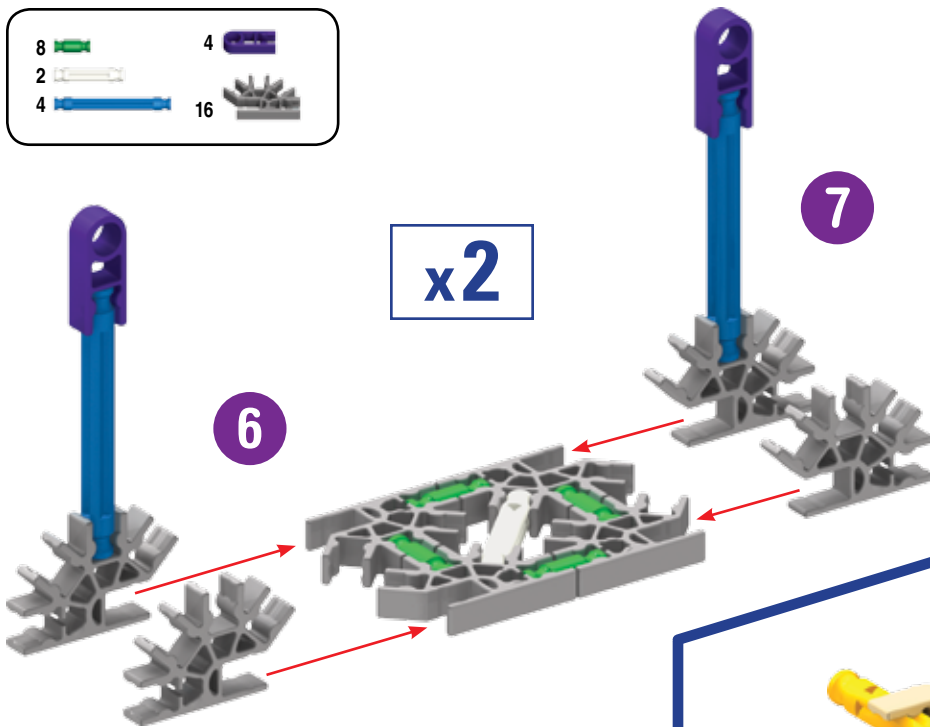

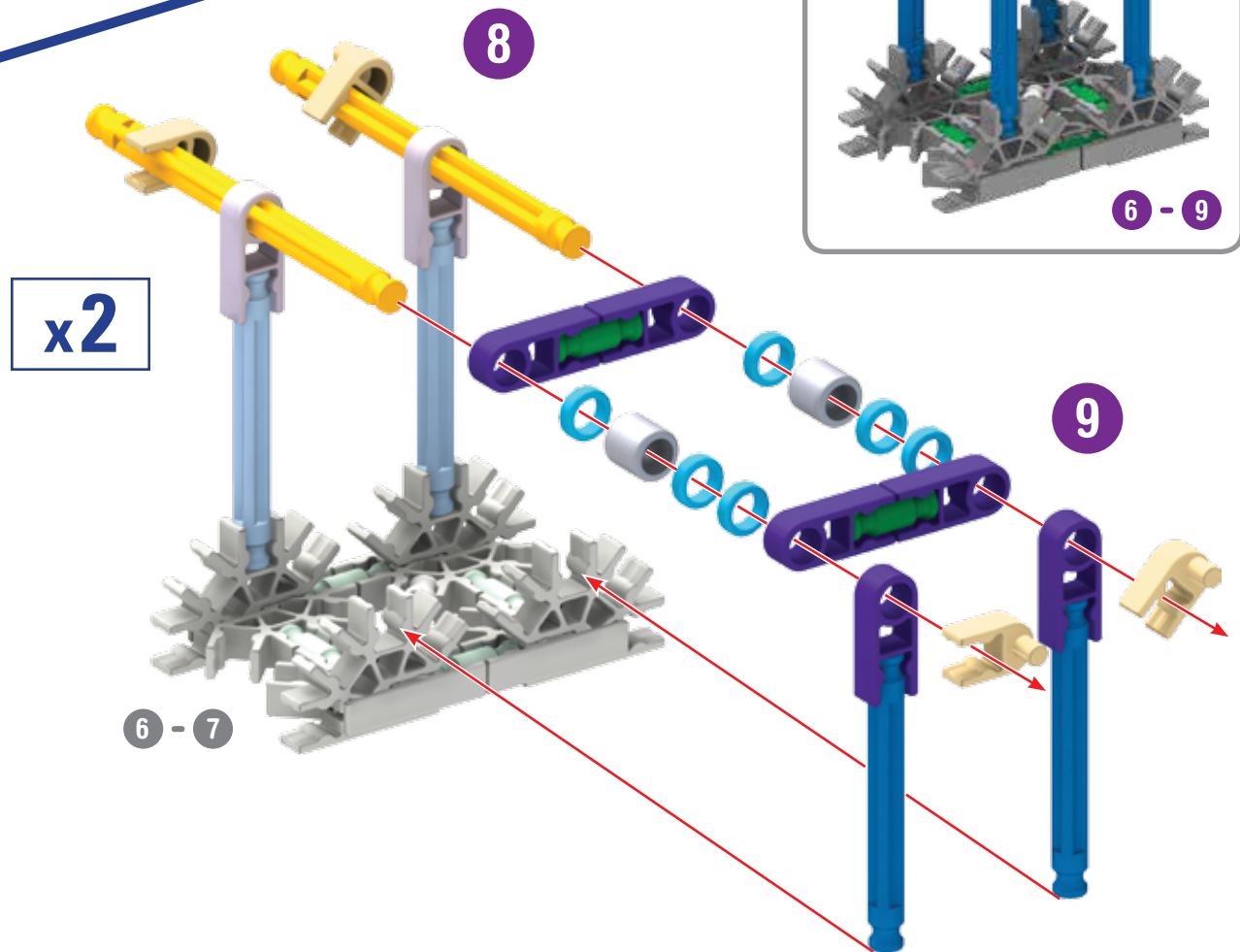
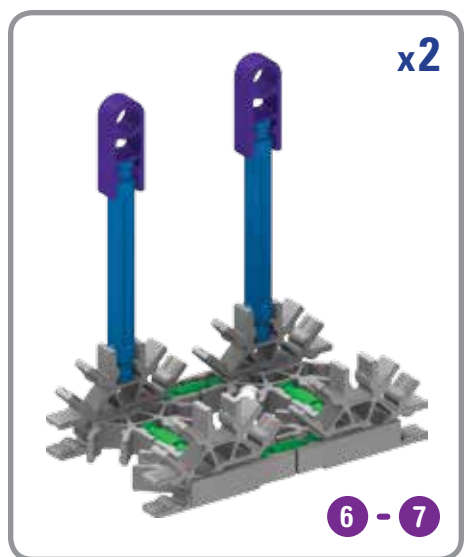

- | | | | |
|---|--|----|--|
| 8 | | 4 | |
| 2 | | | |
| 4 | | 16 | |



- | | | | | | |
|---|--|----|--|---|--|
| 4 | | 12 | | 4 | |
| 4 | | | | | |
| 8 | | 12 | | | |



- 12 
- 4 
- 8 
- 4 
- 12 
- 2 

x2

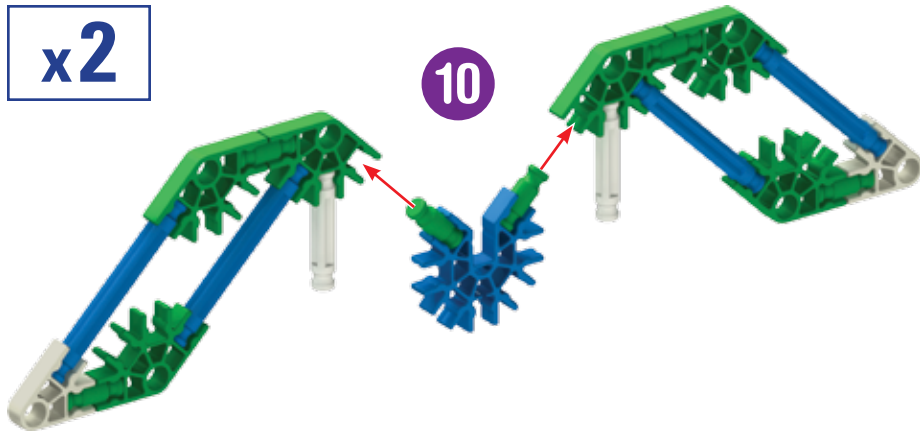

Bridge

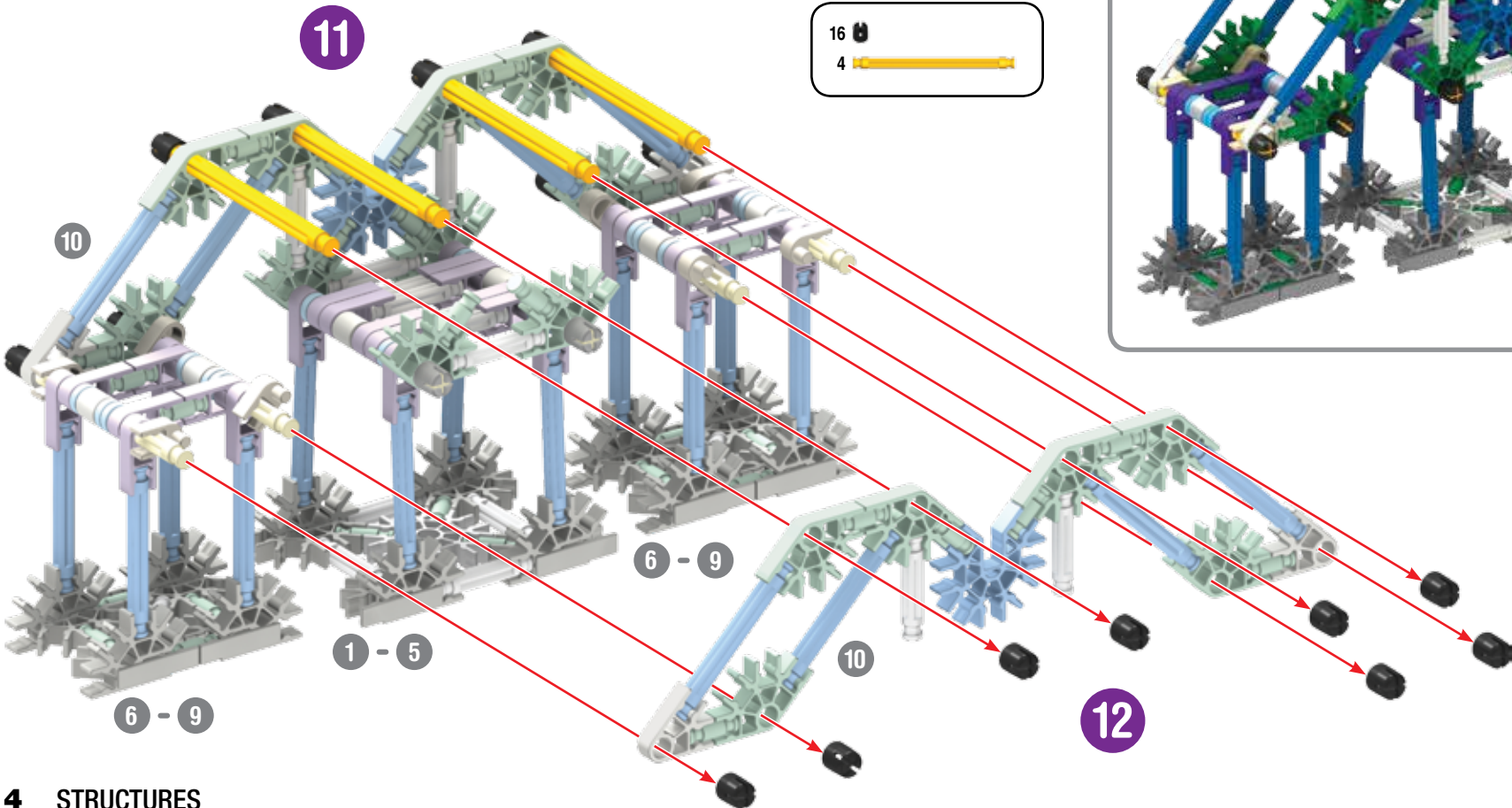
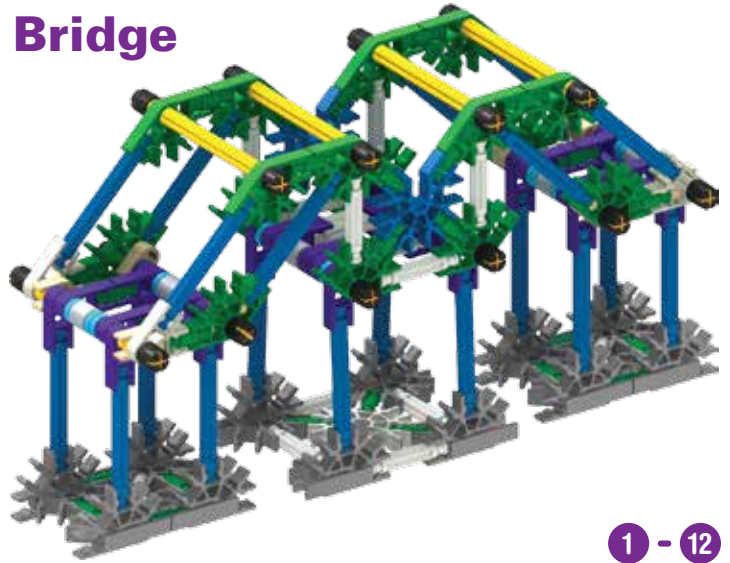

Cabana



x7

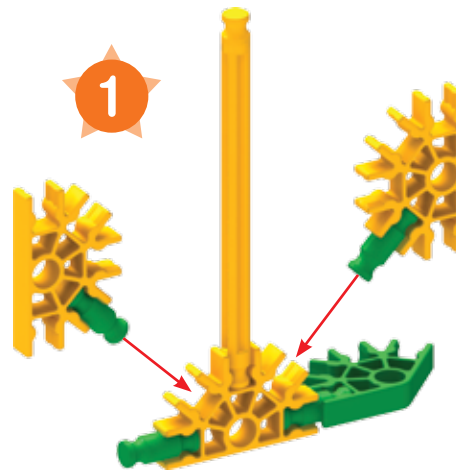

1

- 28
- 7
- 7
- 21

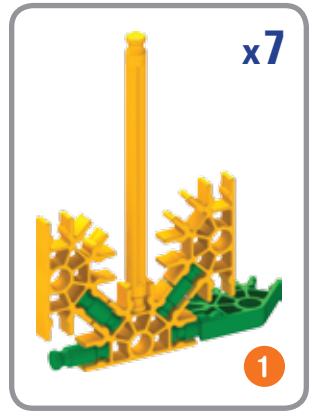

x7

1

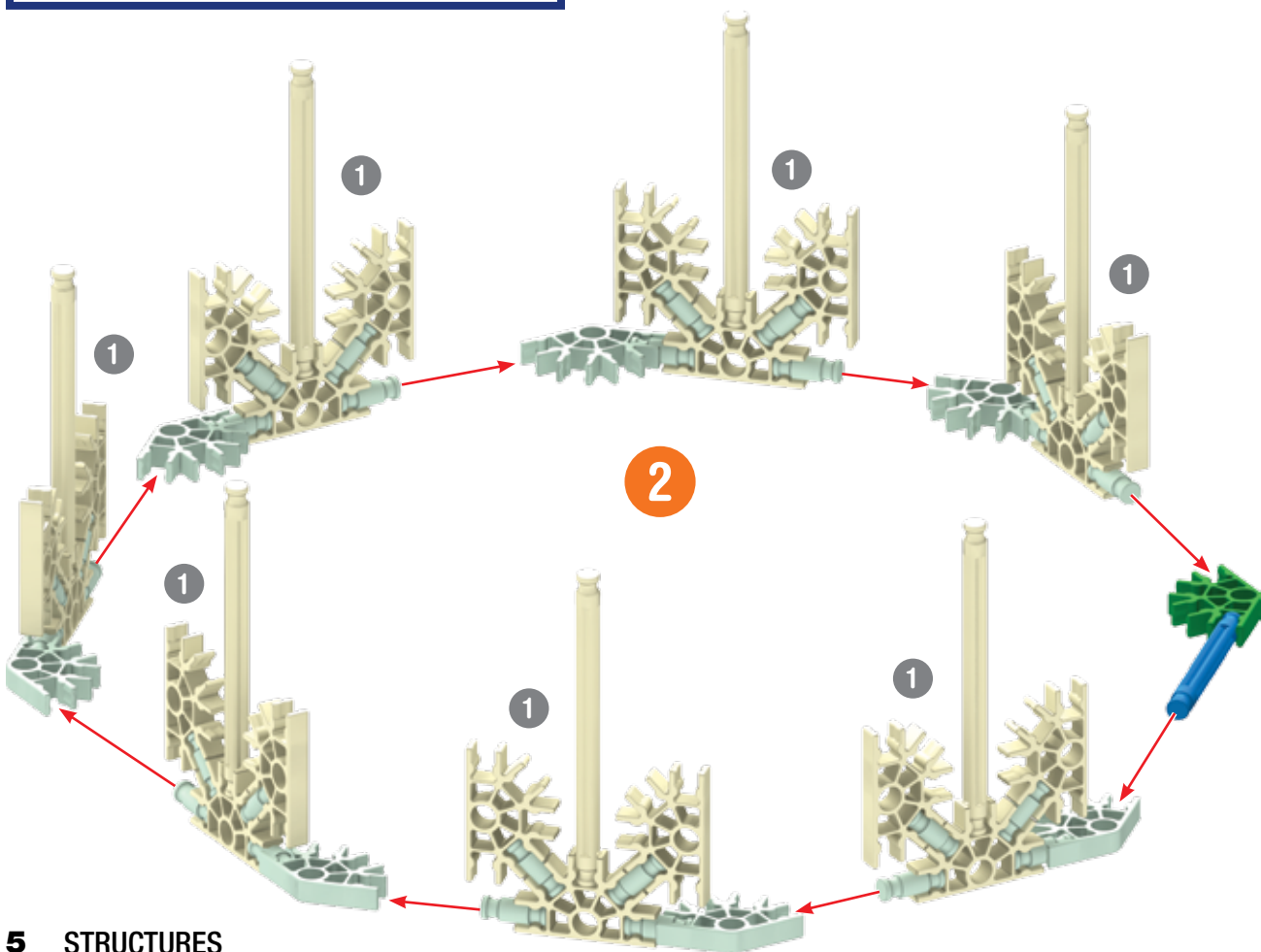

2

- 1
- 1

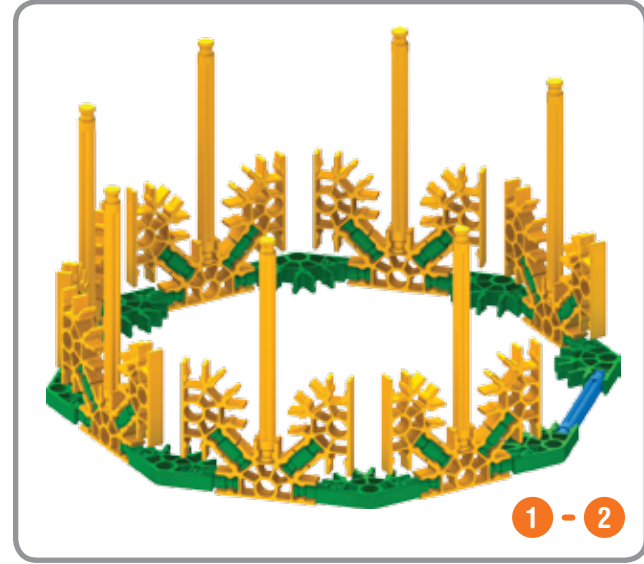

1 - 2

x8

40		8	
8		8	
8		16	
8		8	

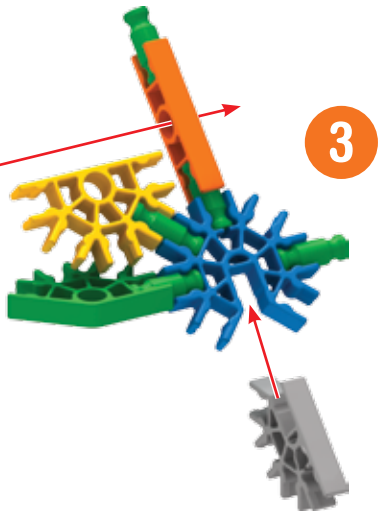

x8

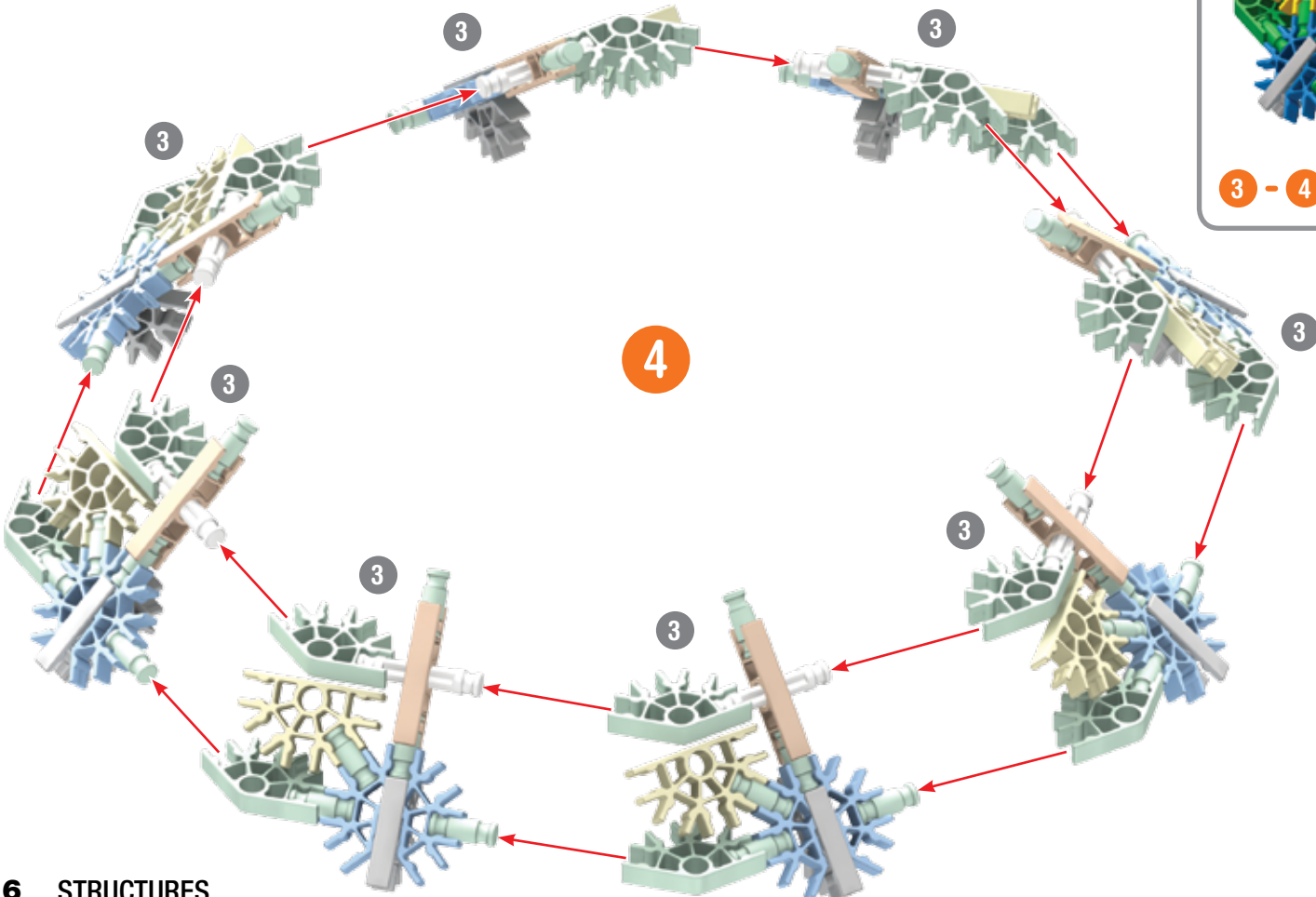

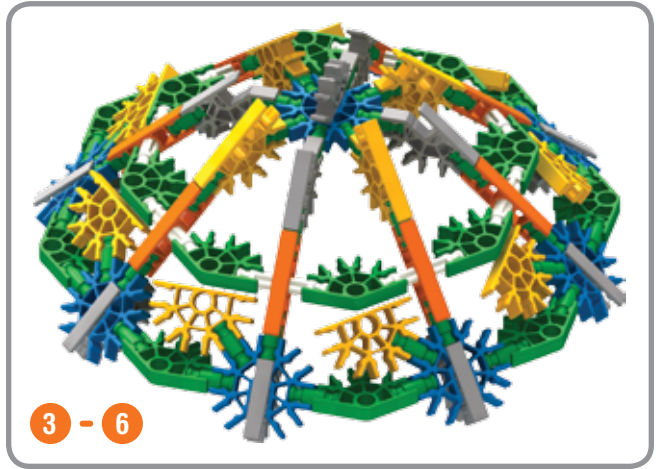
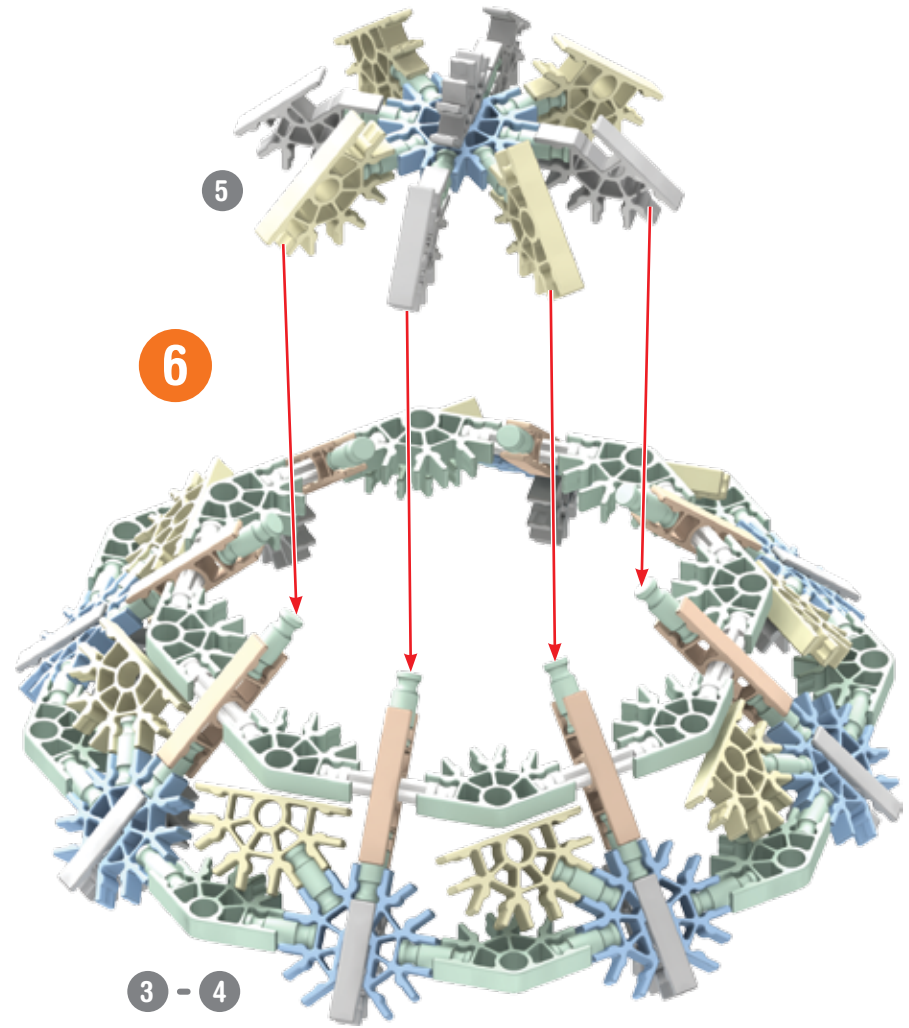
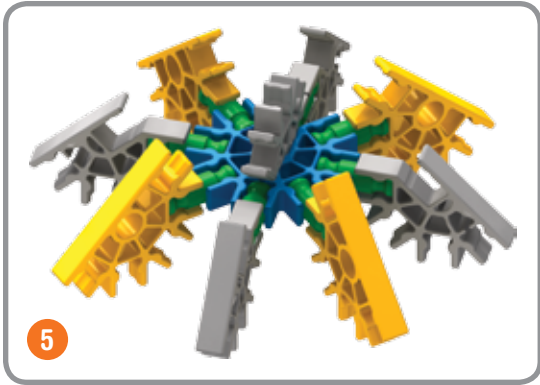
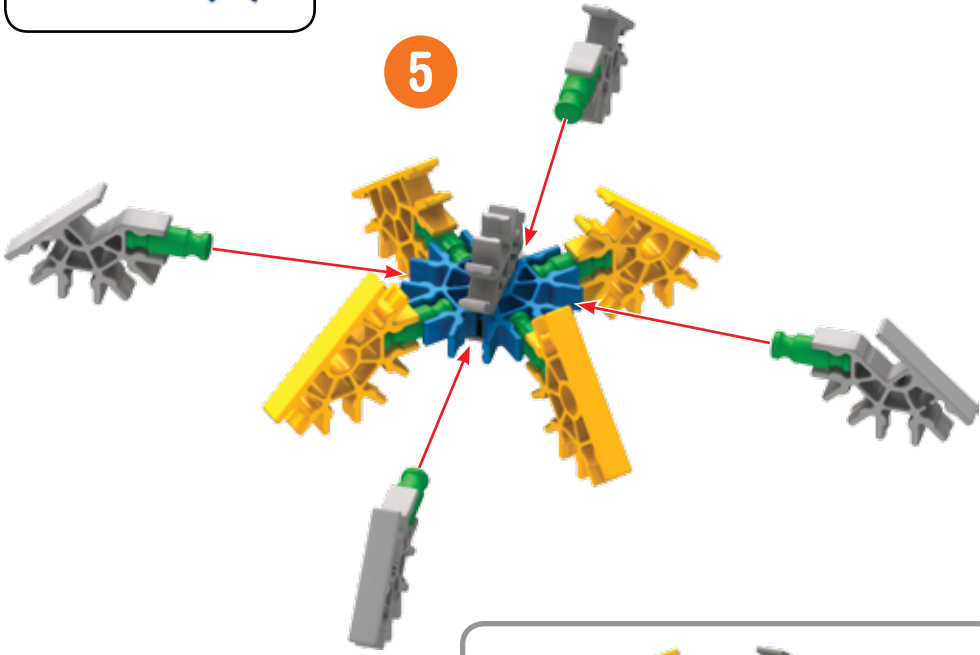
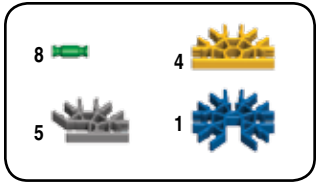

x4

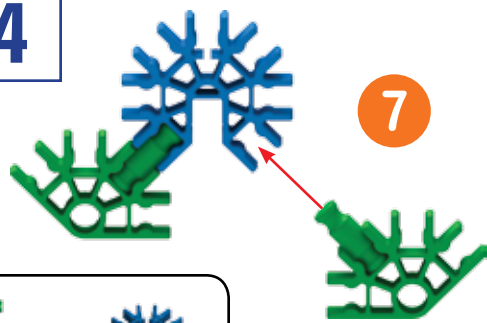

7

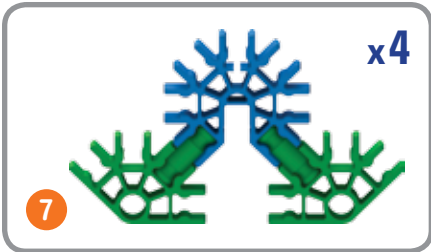

x4

7

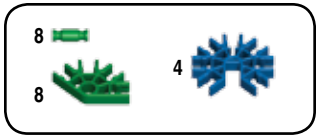

8

8

4

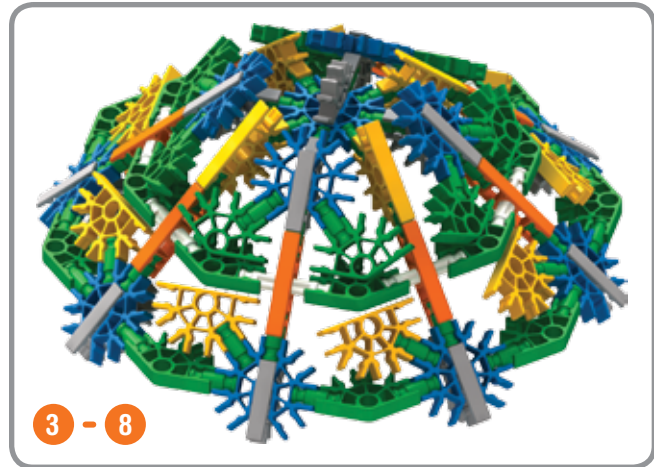

3 - 8

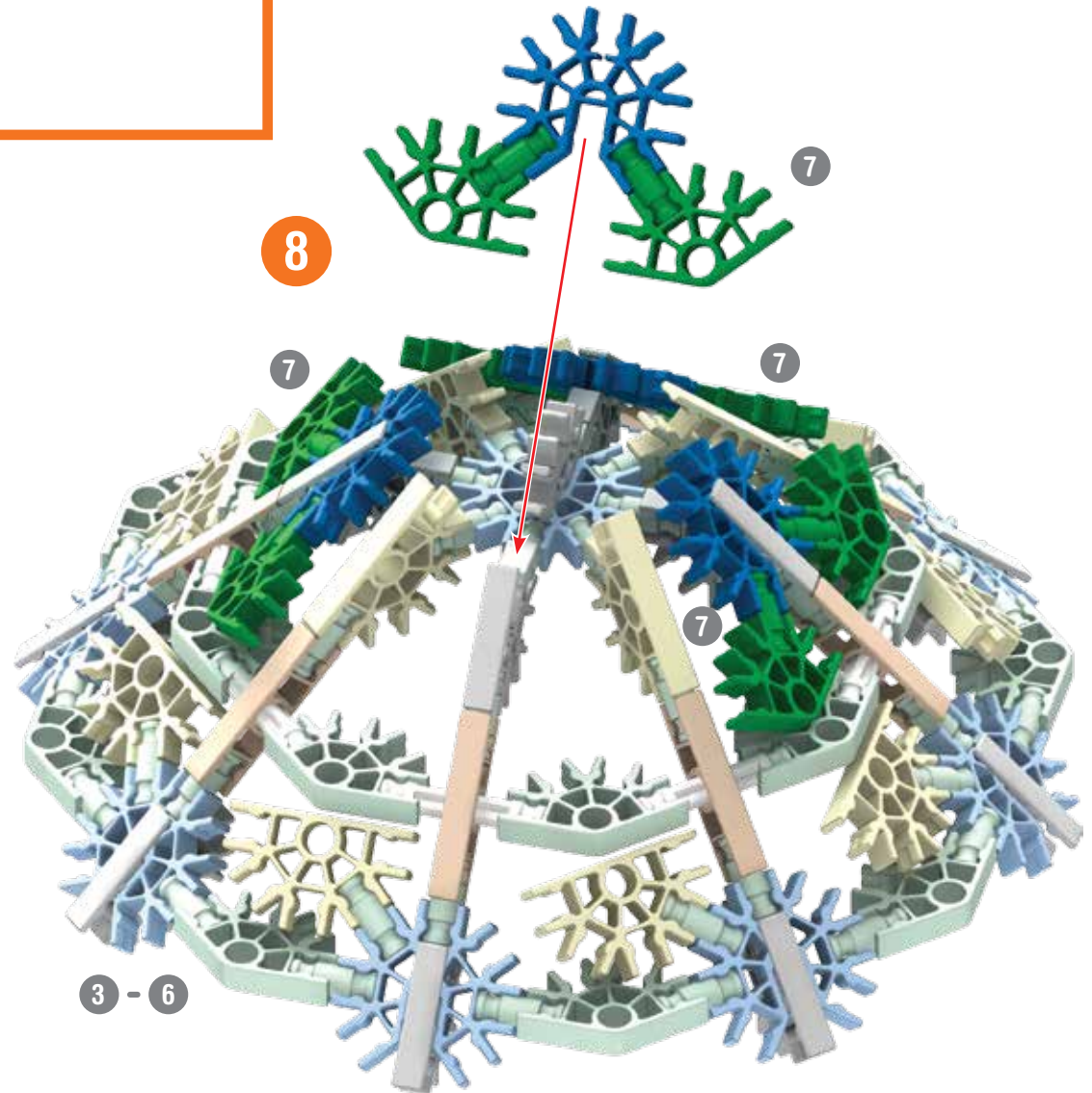





8

7

7

7

3 - 6

- 8 
- 1 
- 1  2 

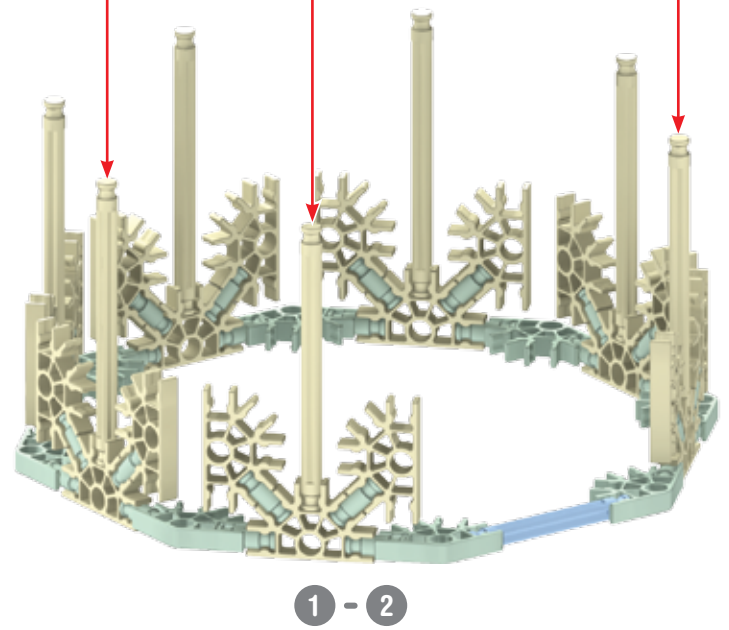
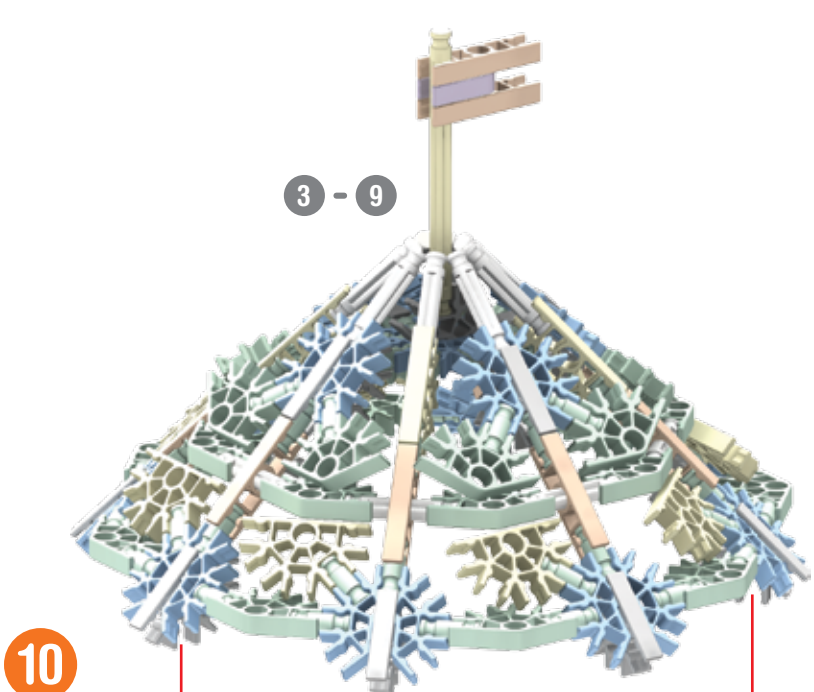
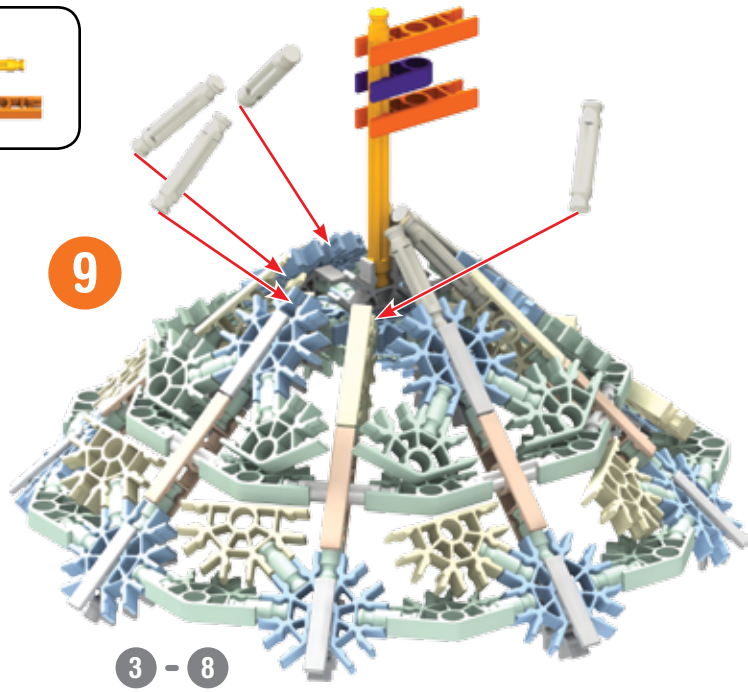

Car Wash

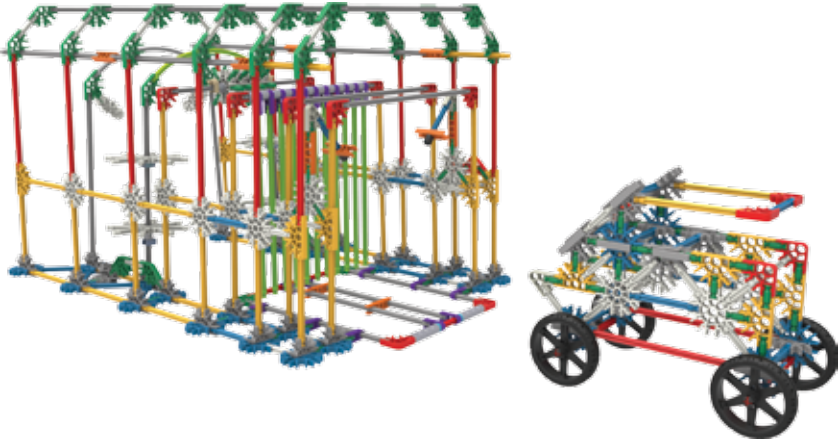

12		2		2		12	
6							
4							
2							
4							
2		8		10		2	
						12	

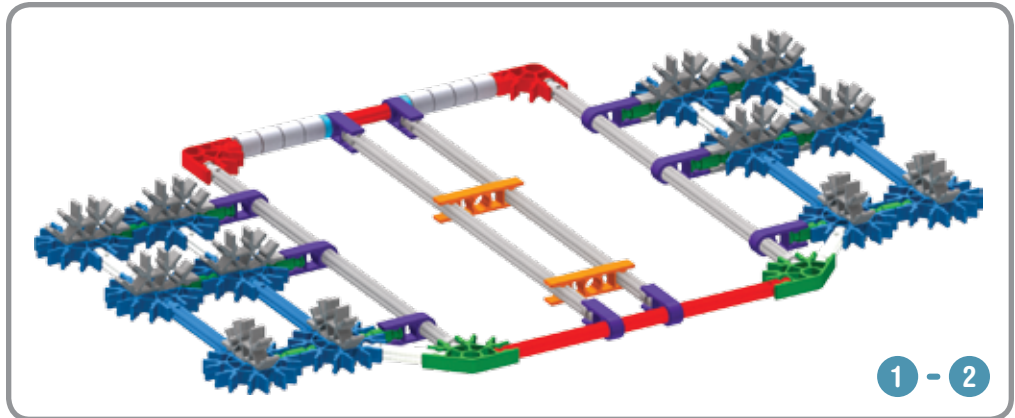
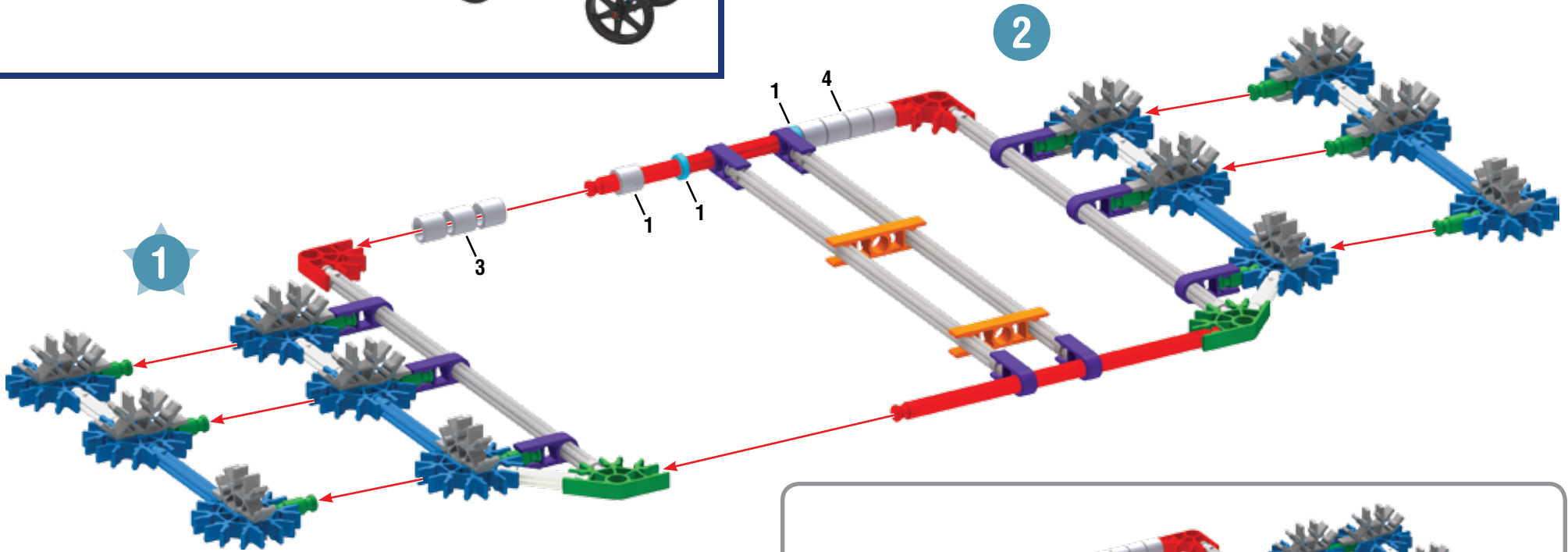

1 - 2

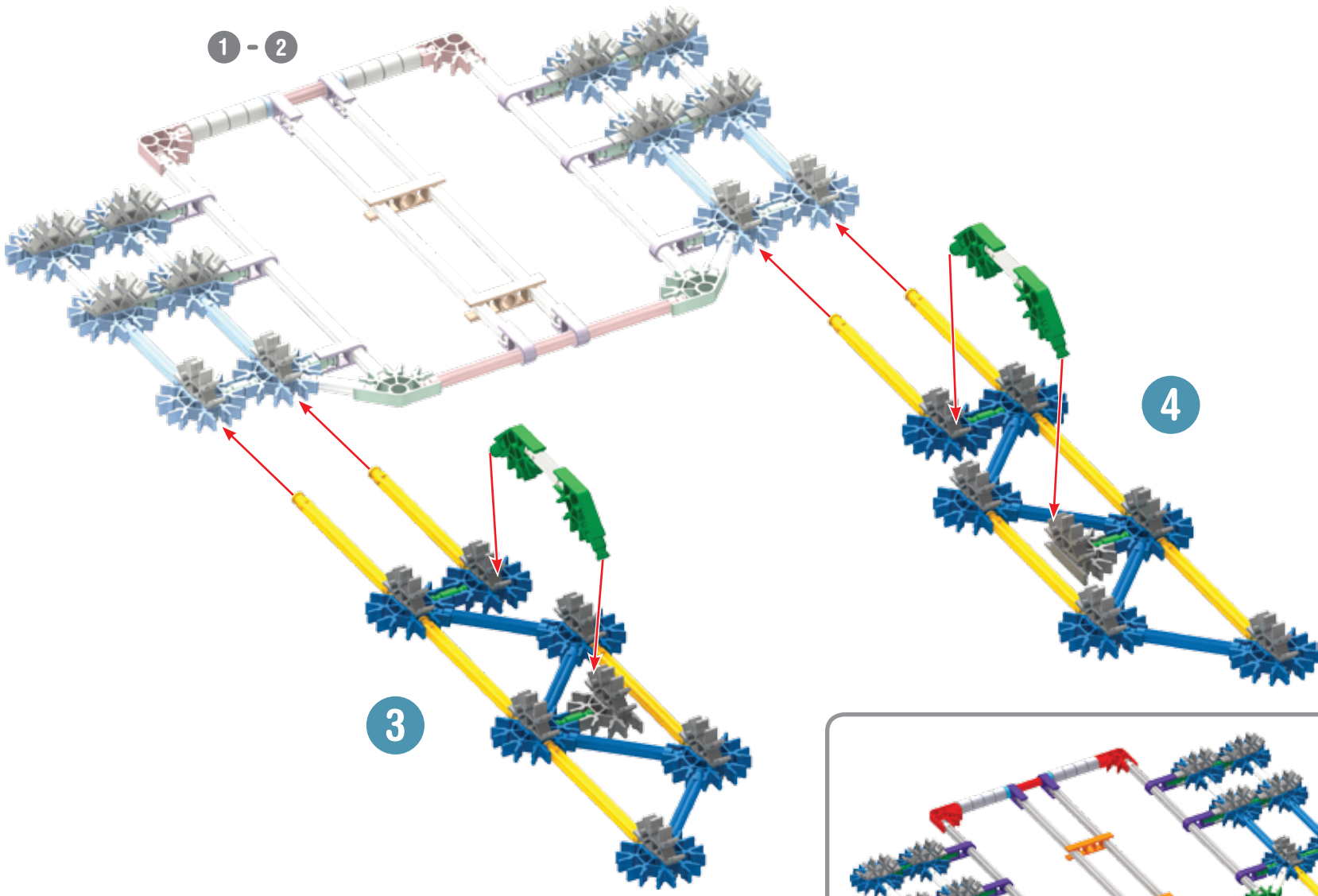

3

4

8		12		4	
2					
8				16	
10					

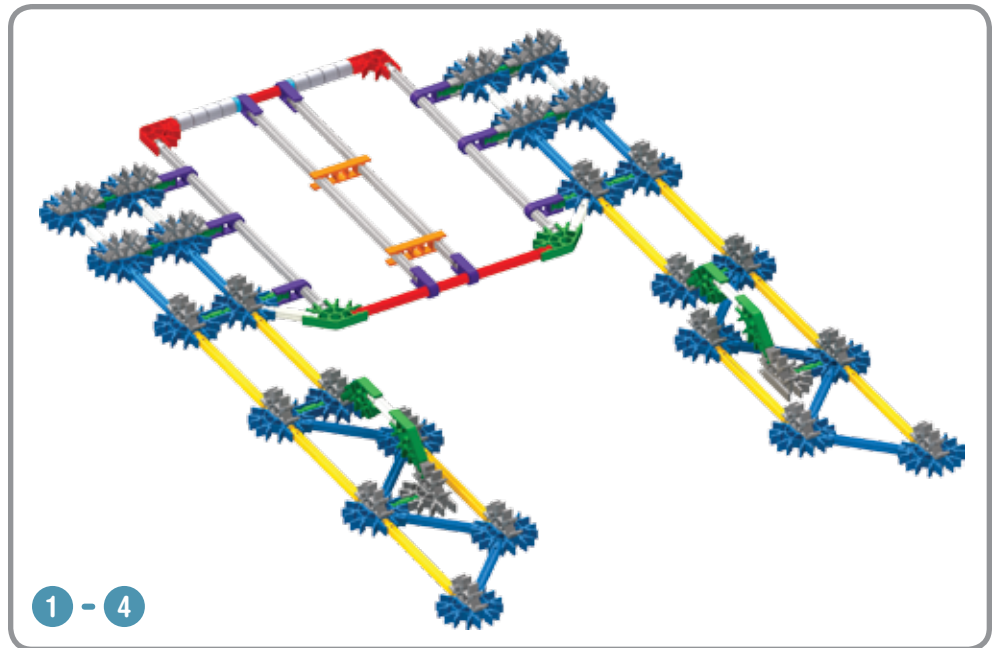

1 - 4

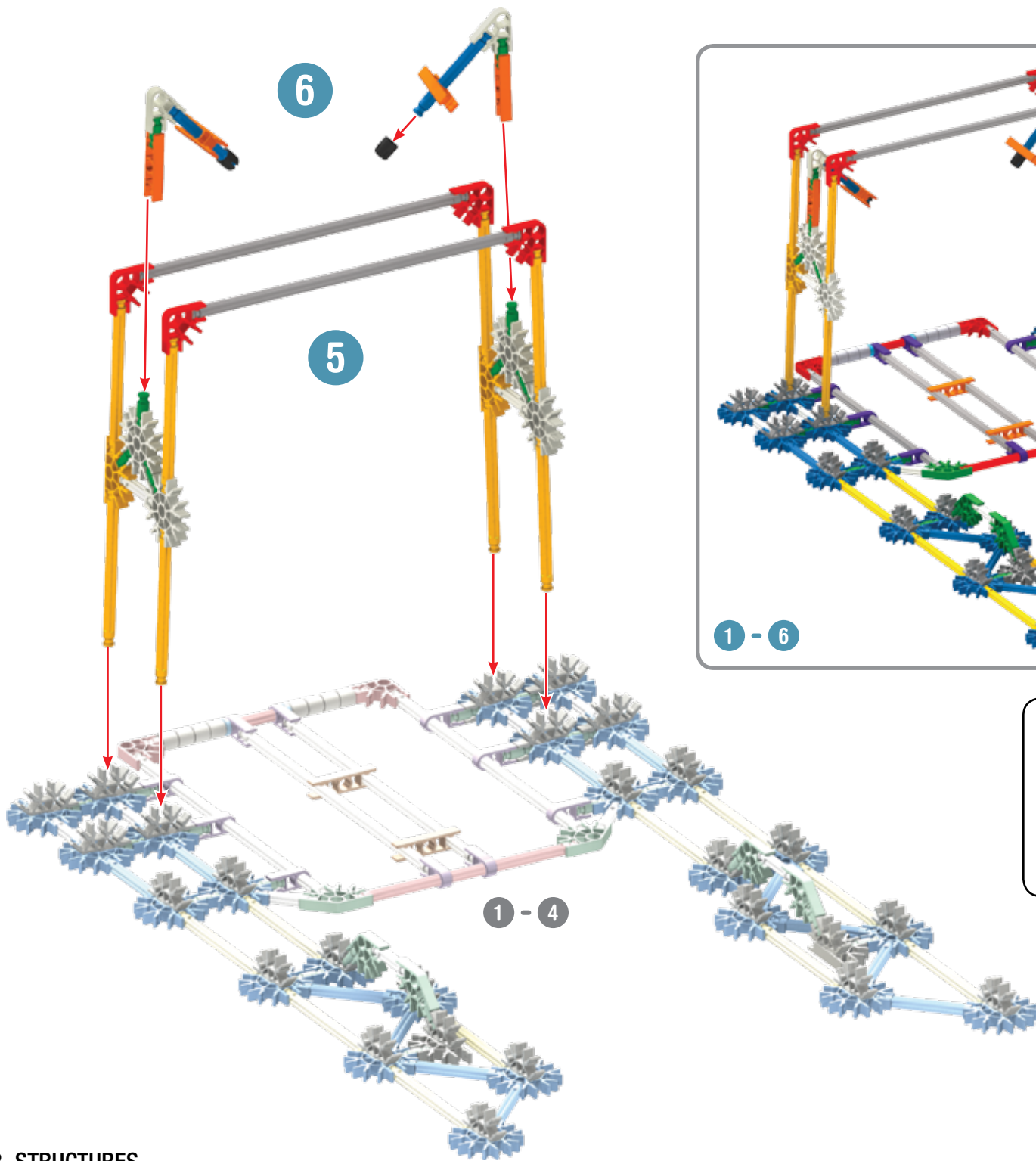

6

5

1 - 4

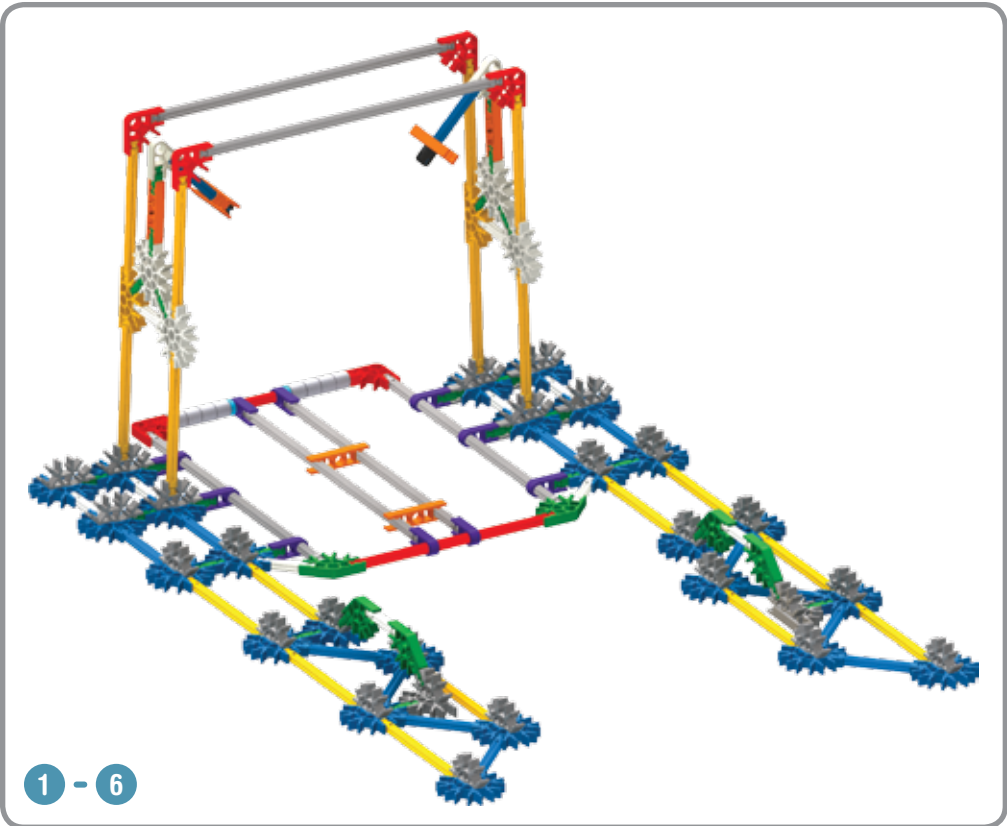

1 - 6

- | | | | | | |
|---|--|---|--|---|--|
| 8 | | 2 | | 4 | |
| 2 | | | | | |
| 2 | | | | | |
| 8 | | 2 | | | |
| 2 | | | | | |
| 4 | | 2 | | 4 | |

8

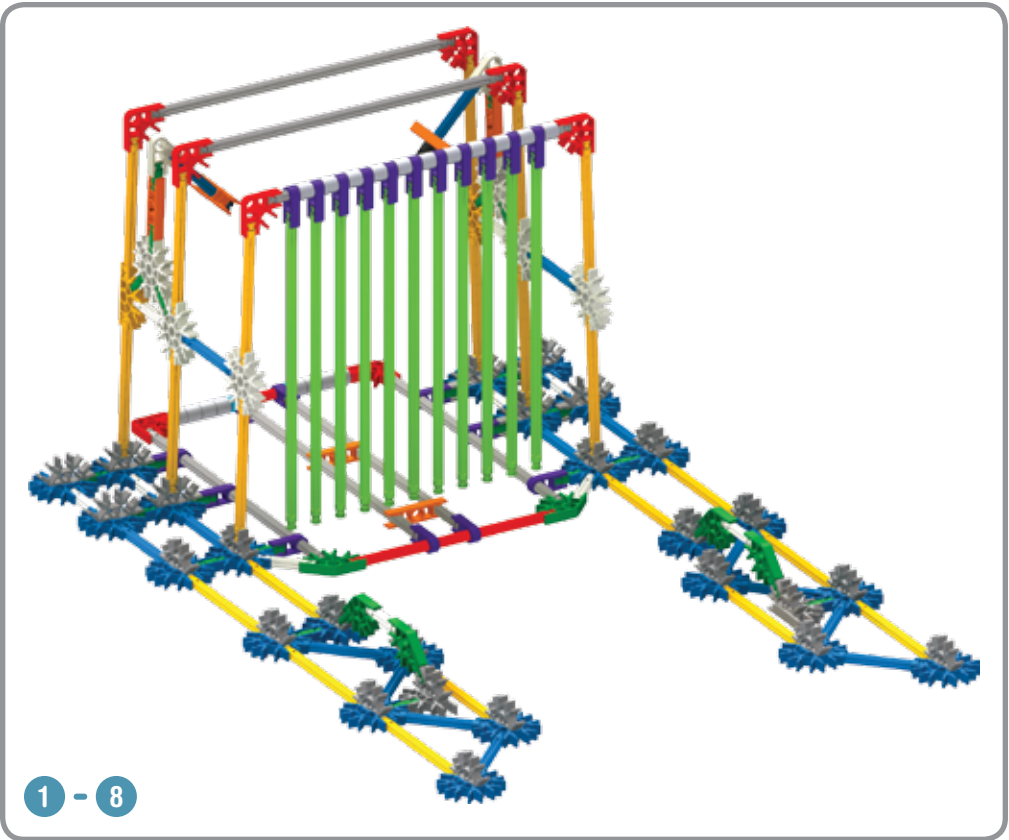
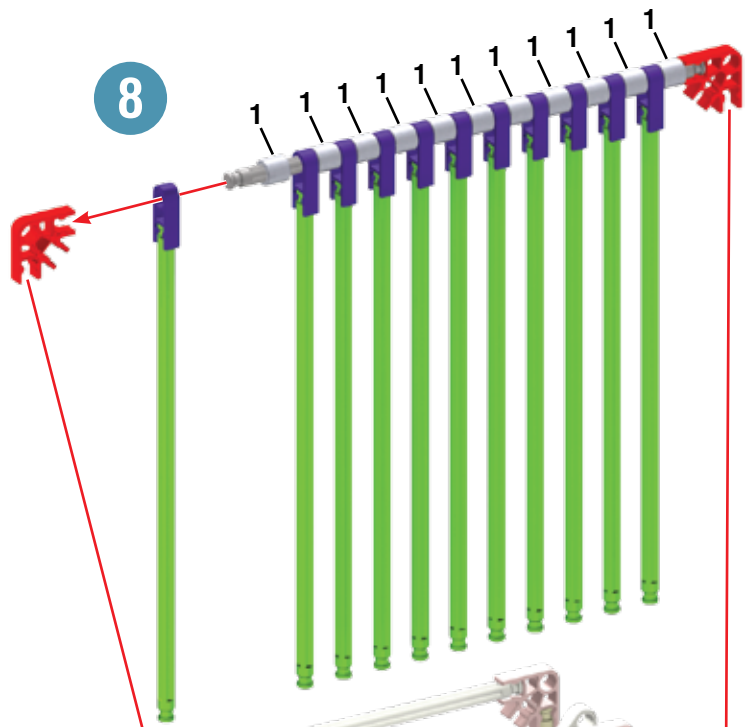

7

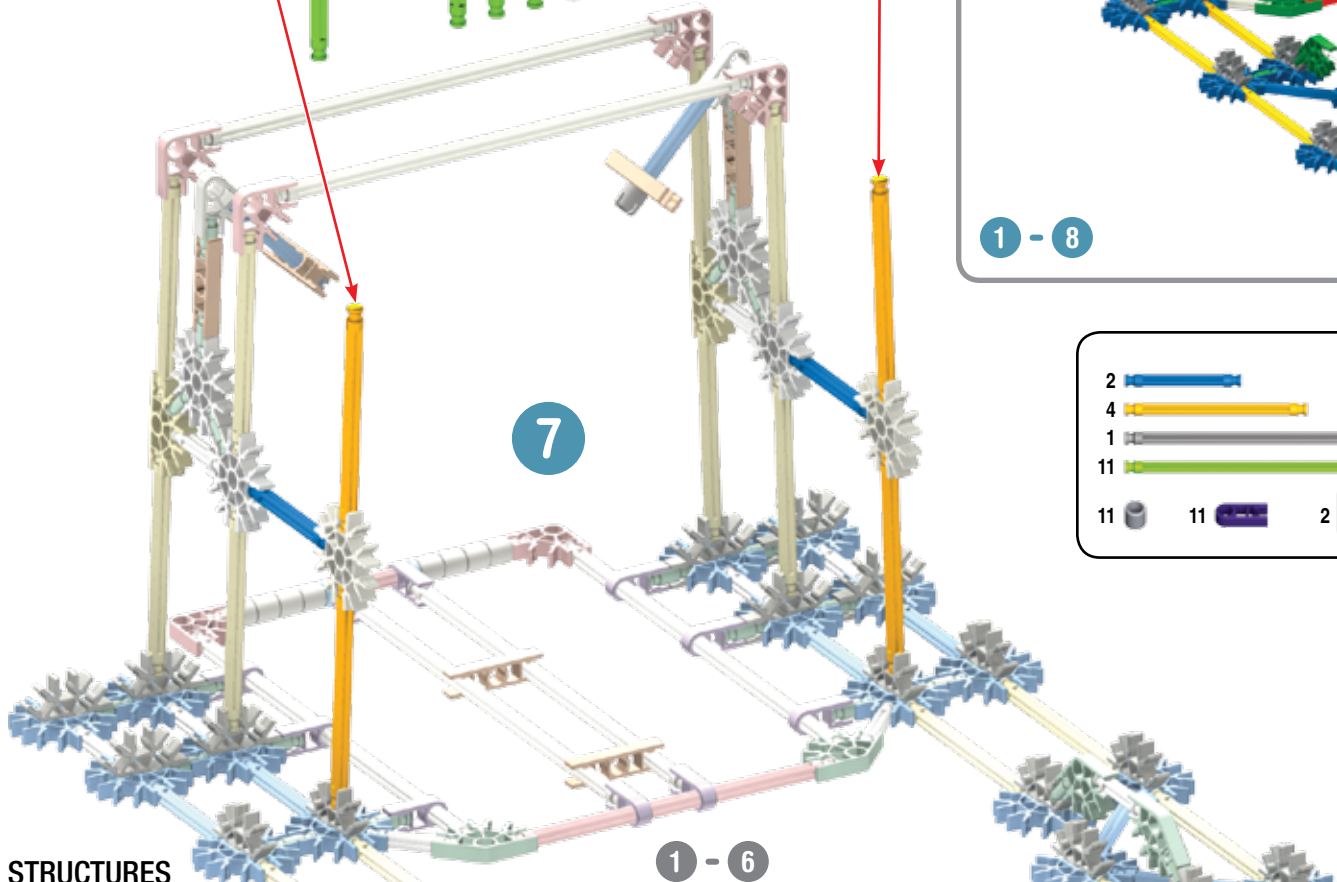

- | | | | |
|----|--|----|--|
| 2 | | 2 | |
| 4 | | | |
| 1 | | | |
| 11 | | | |
| 11 | | 11 | |
| | | 2 | |

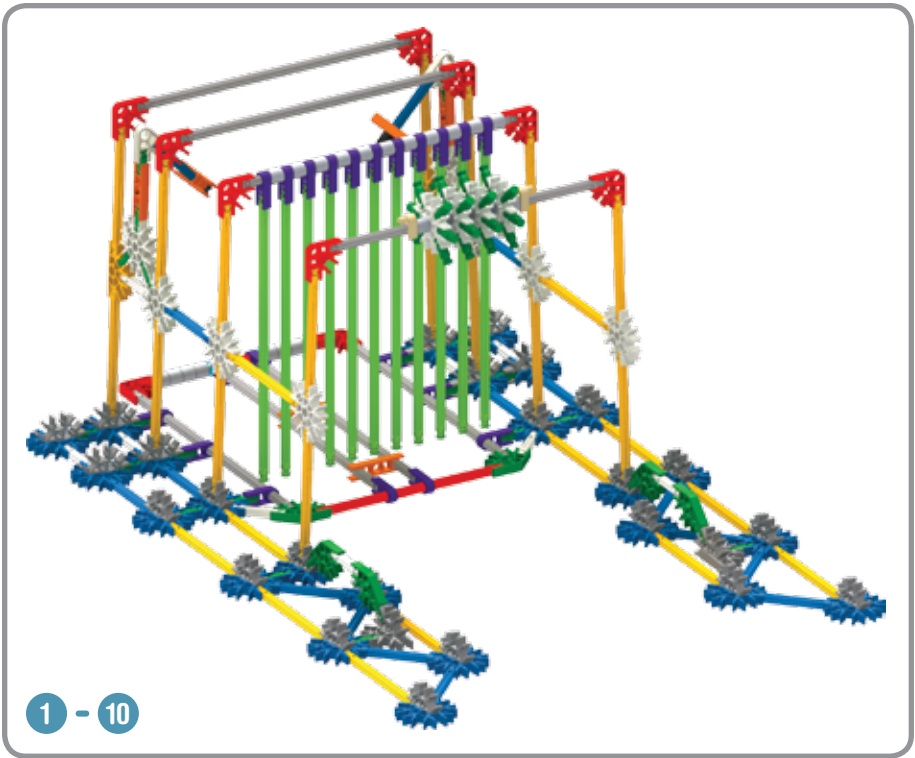
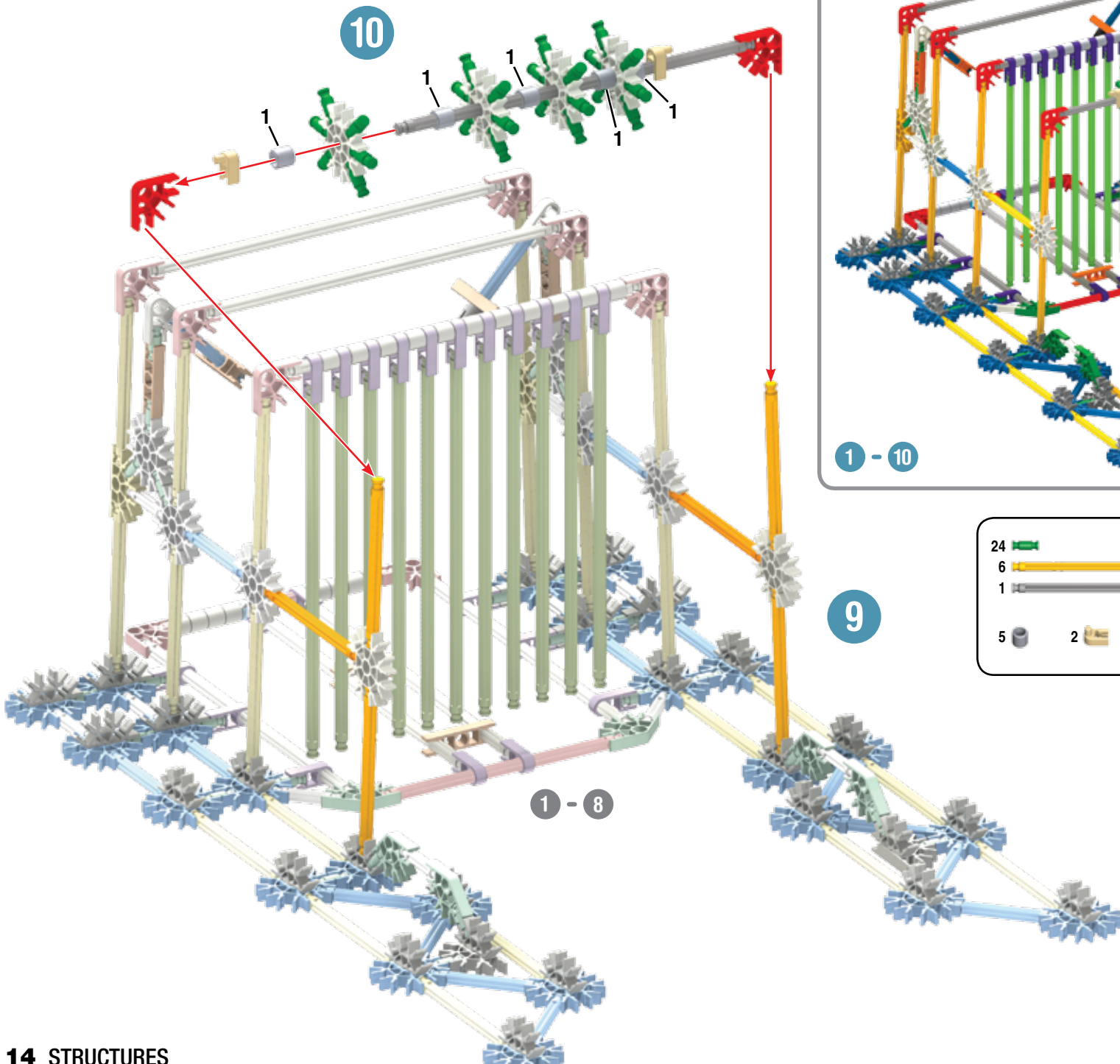

- 9
- | | |
|----|--|
| 24 | |
| 6 | |
| 1 | |
| 5 | |
| 2 | |
| 2 | |
| 6 | |

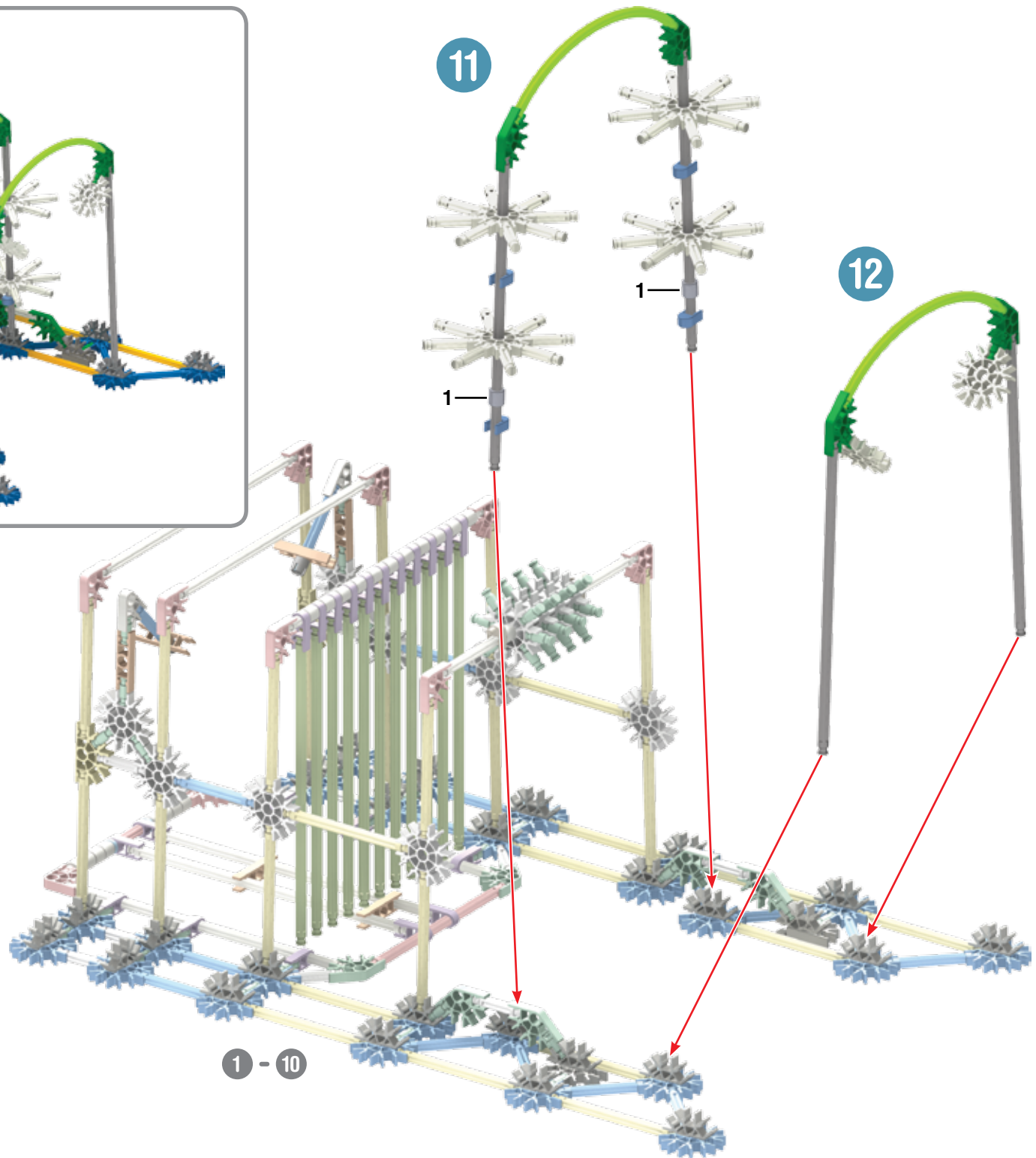
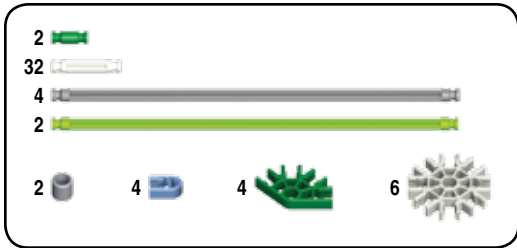
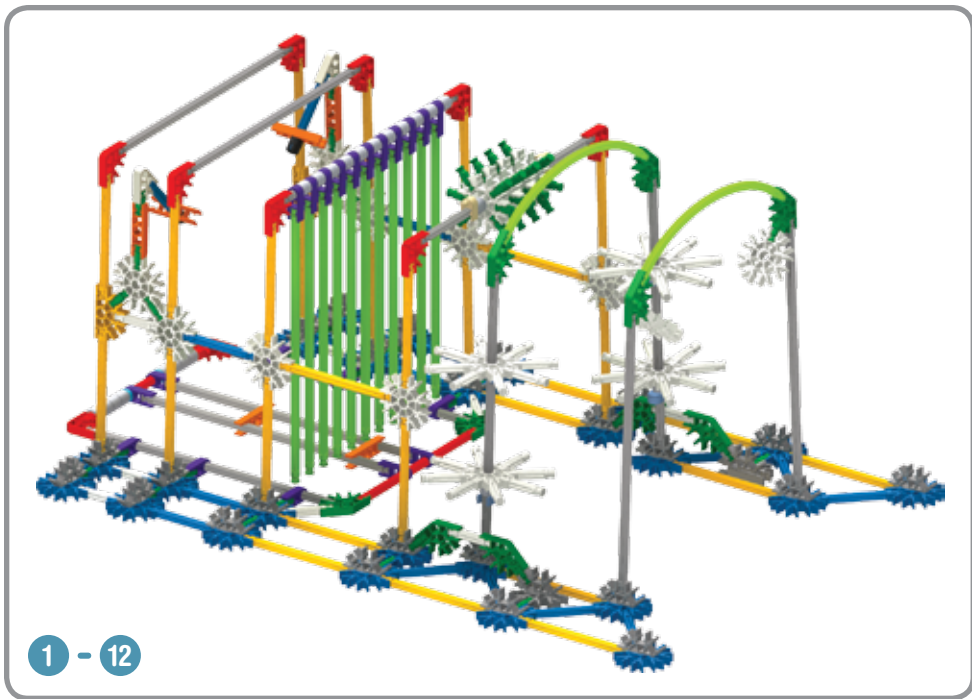

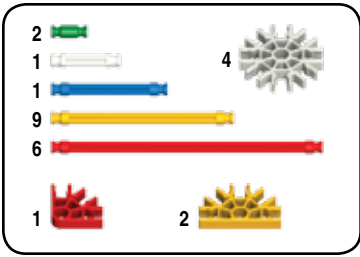

13

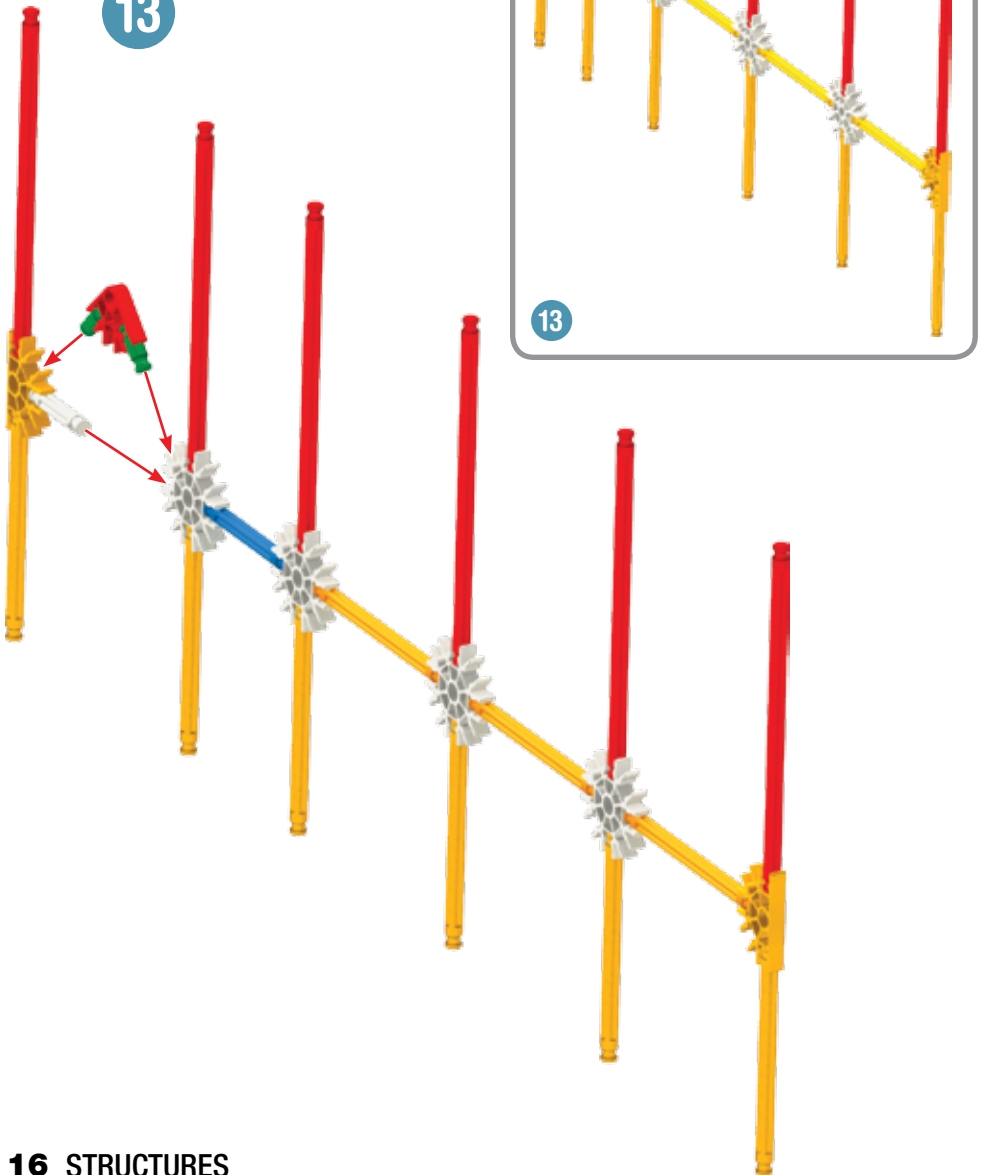

13

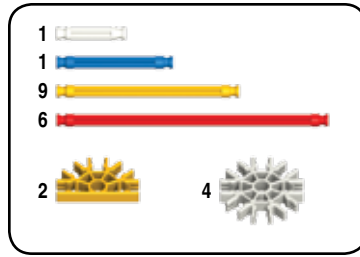

14

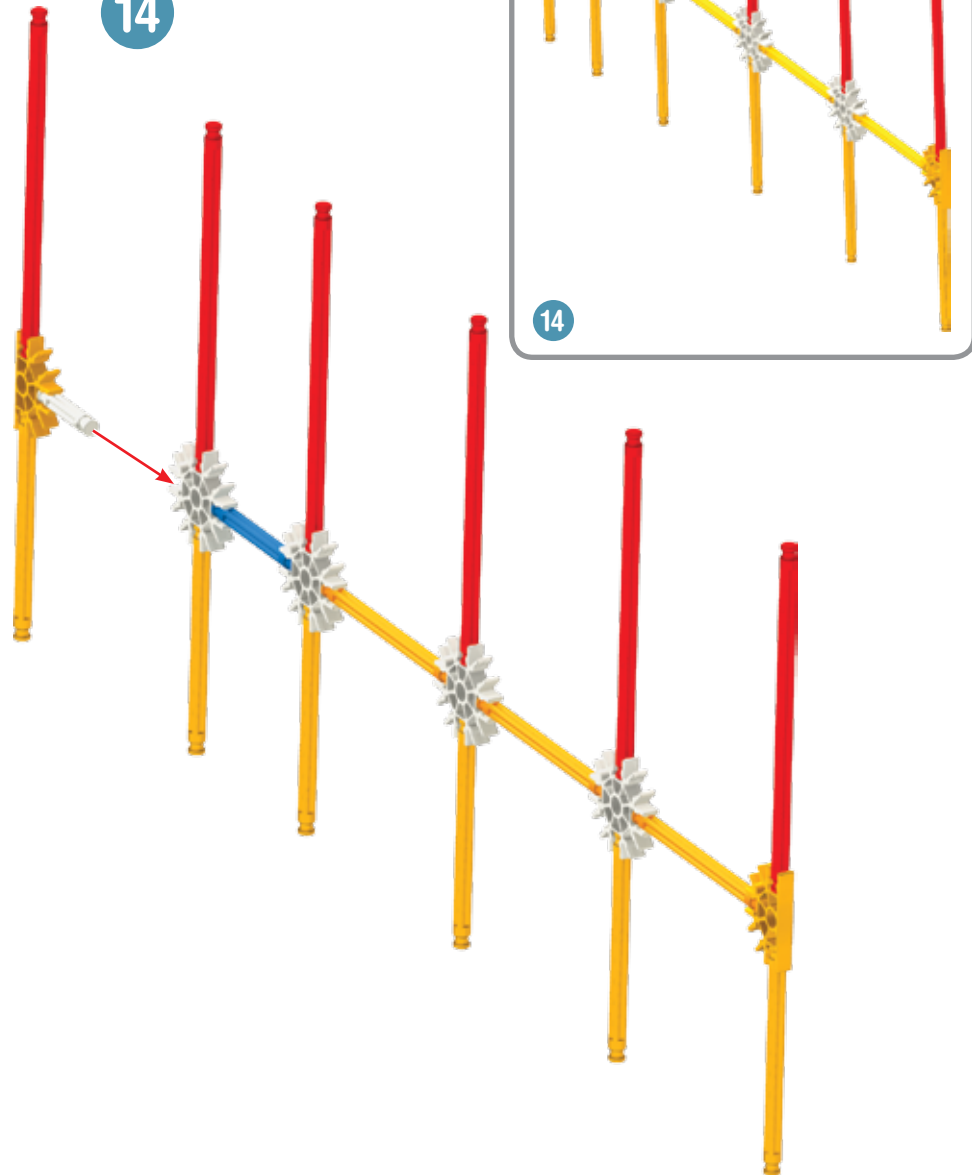

14

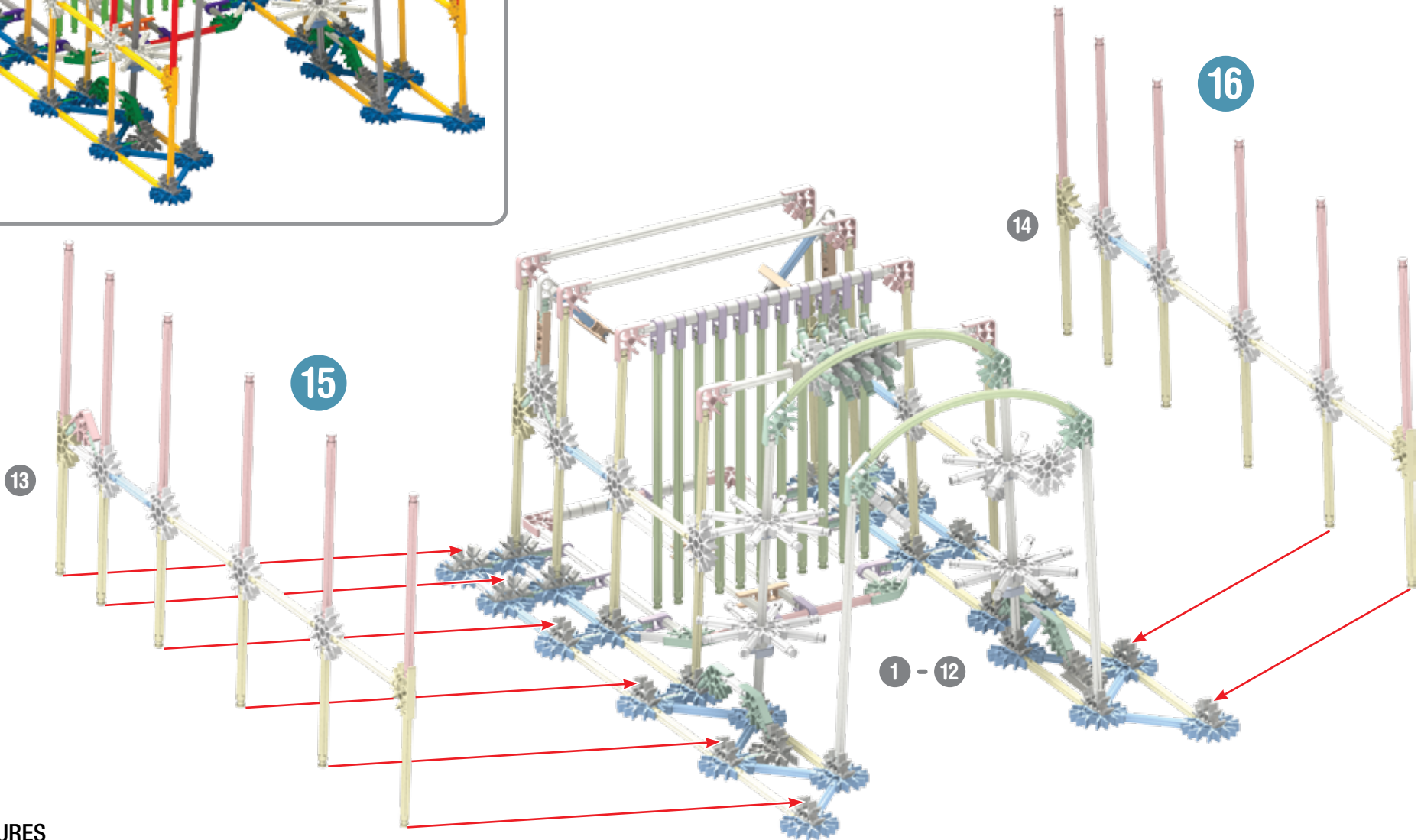
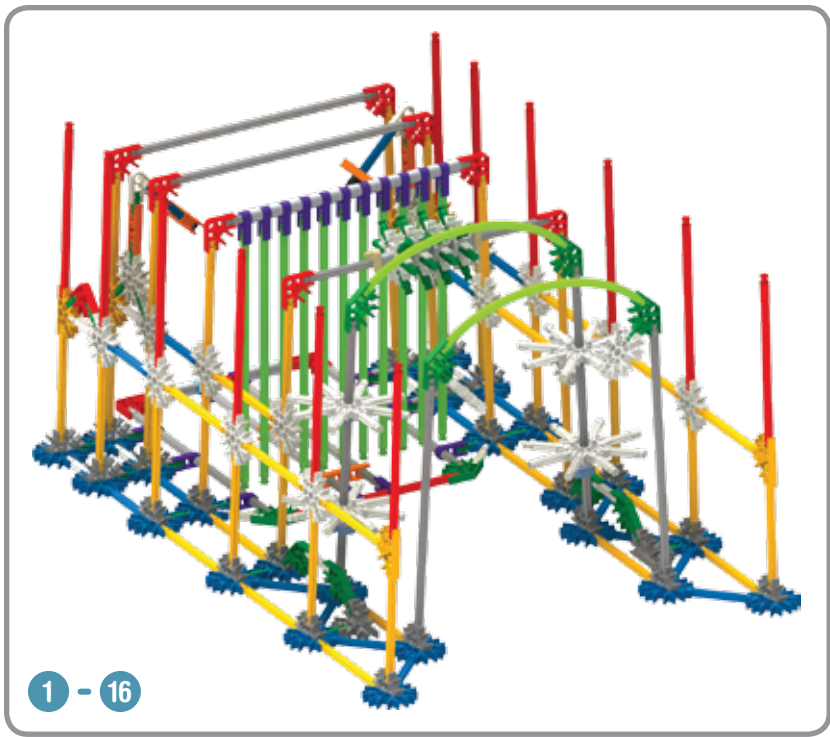

x6

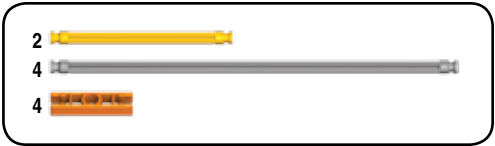
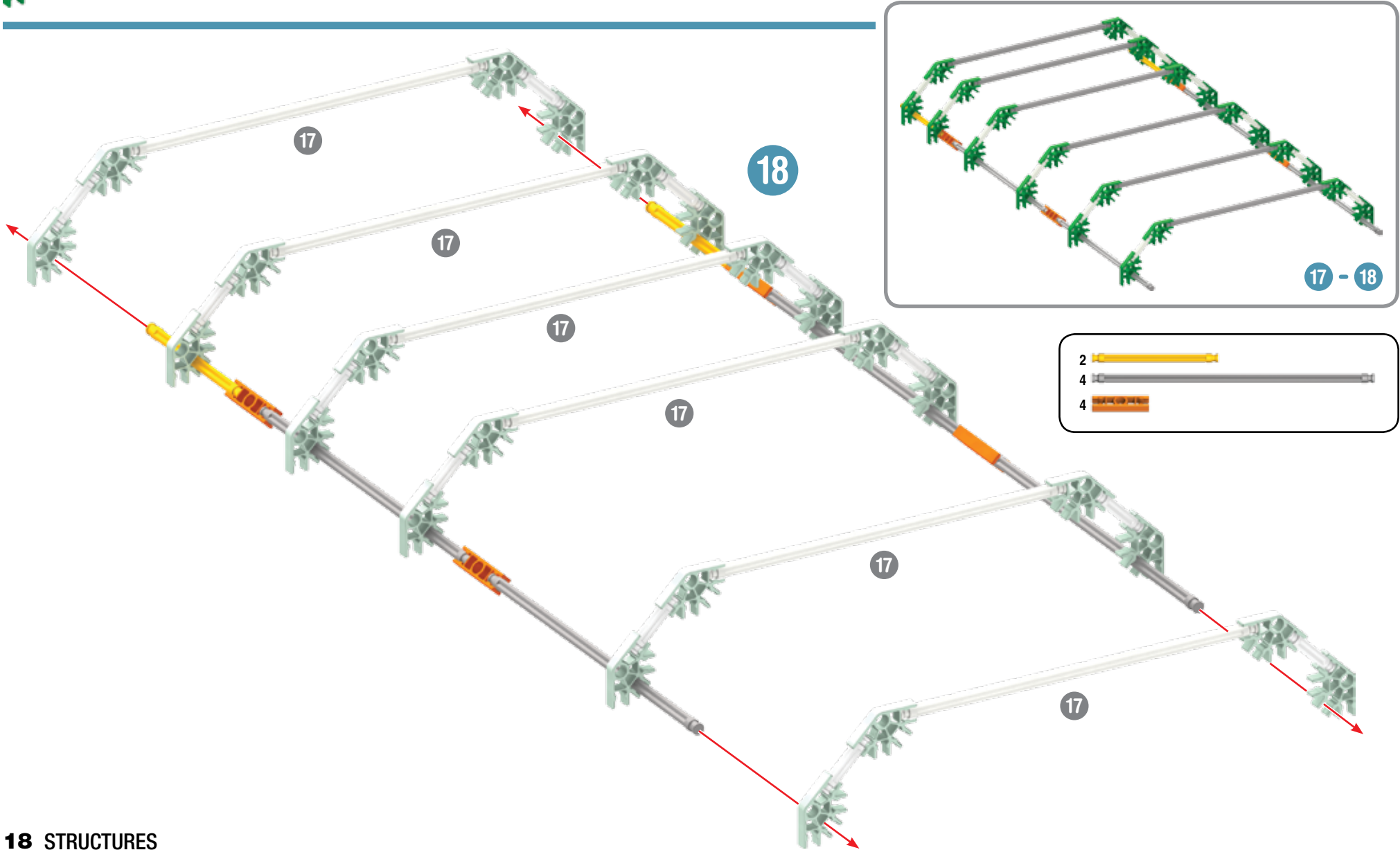
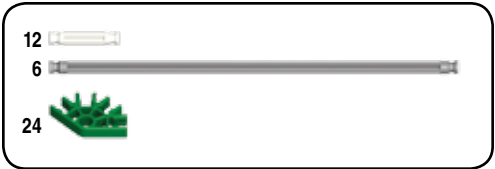

17 - 18

19

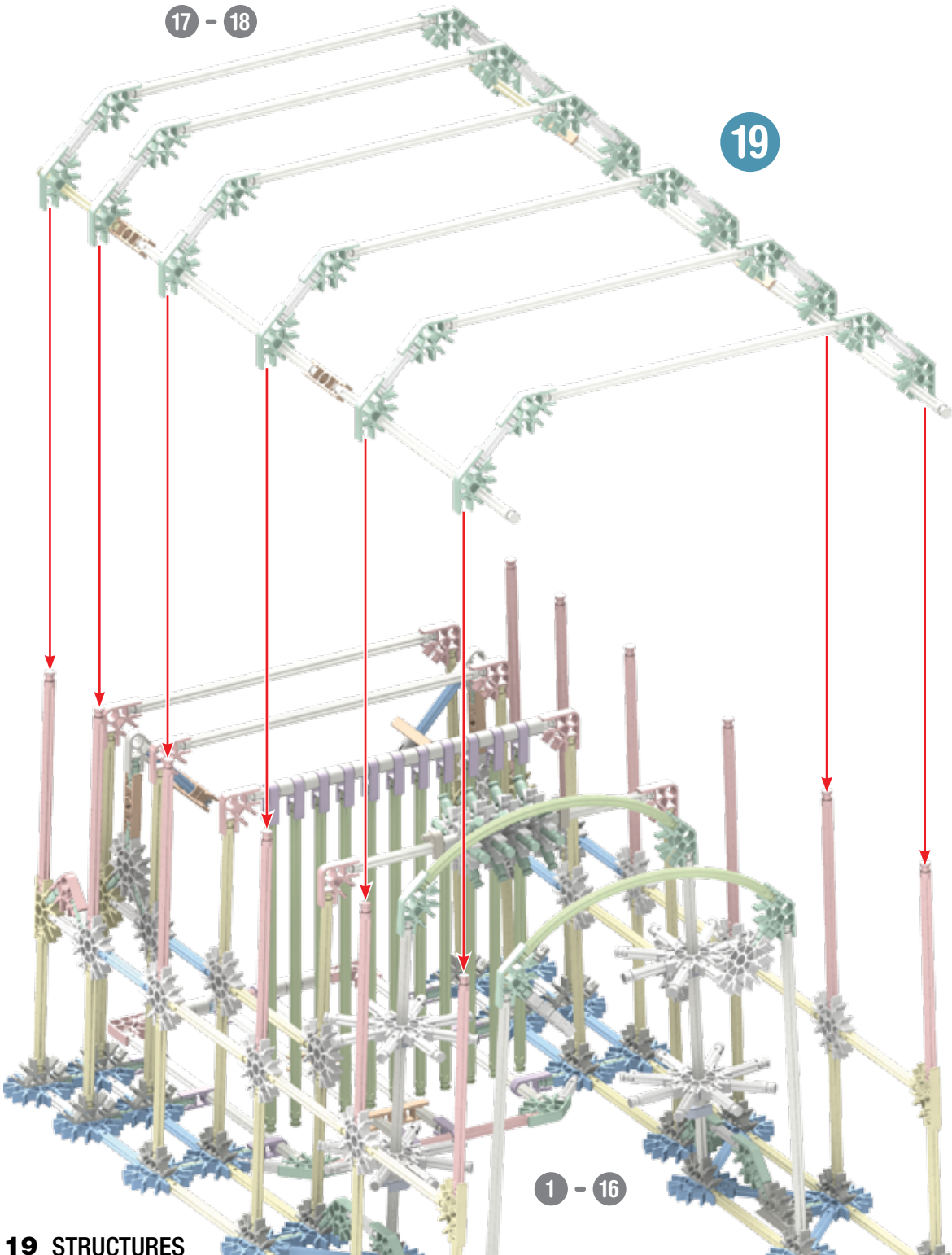

1 - 16

19 STRUCTURES

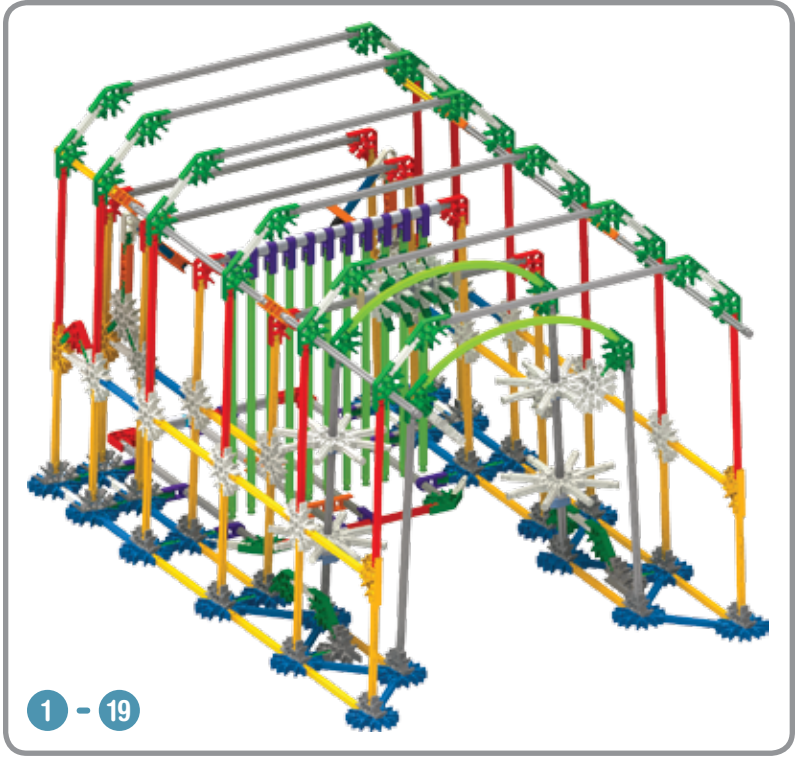

1 - 19

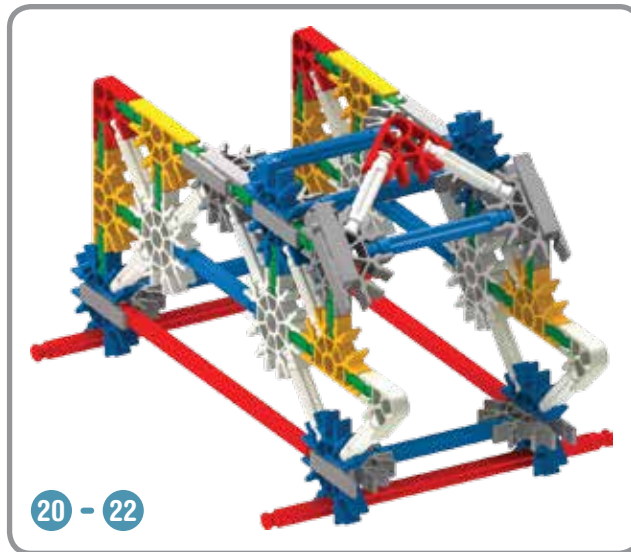
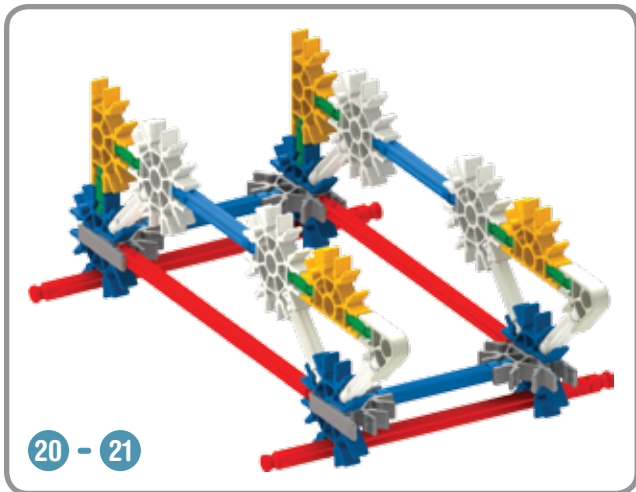
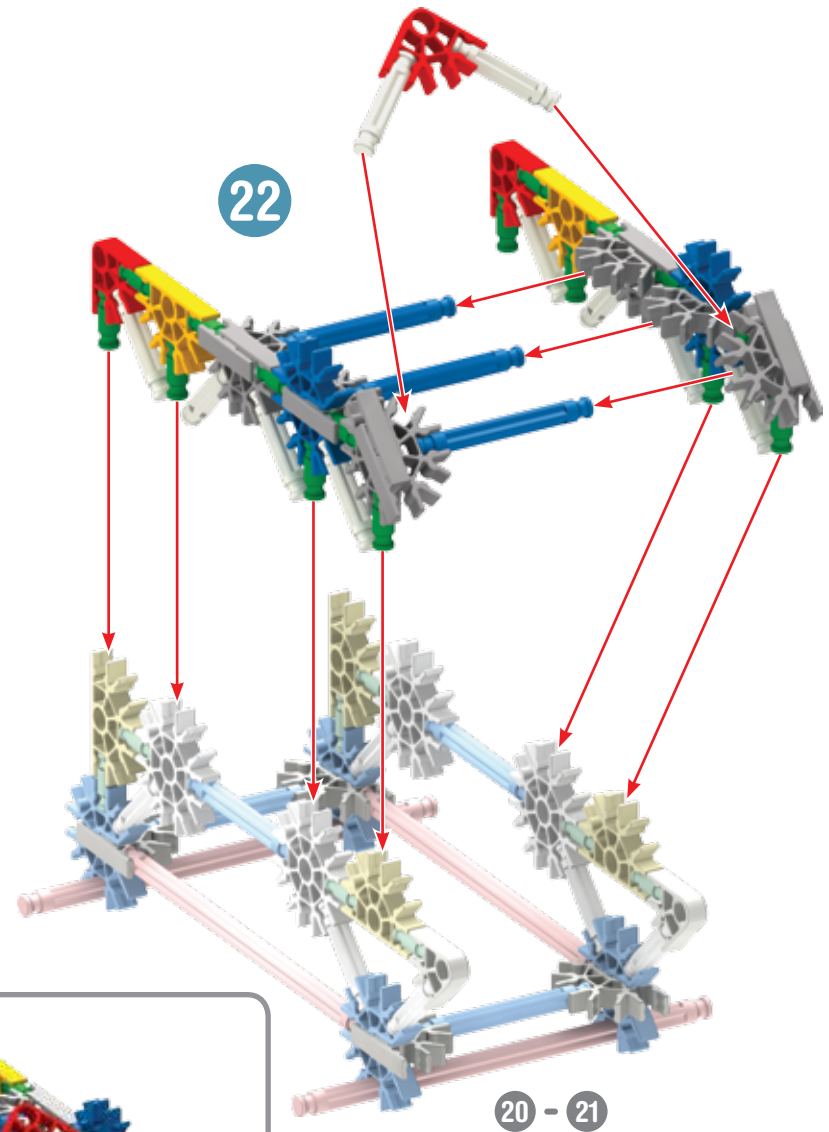
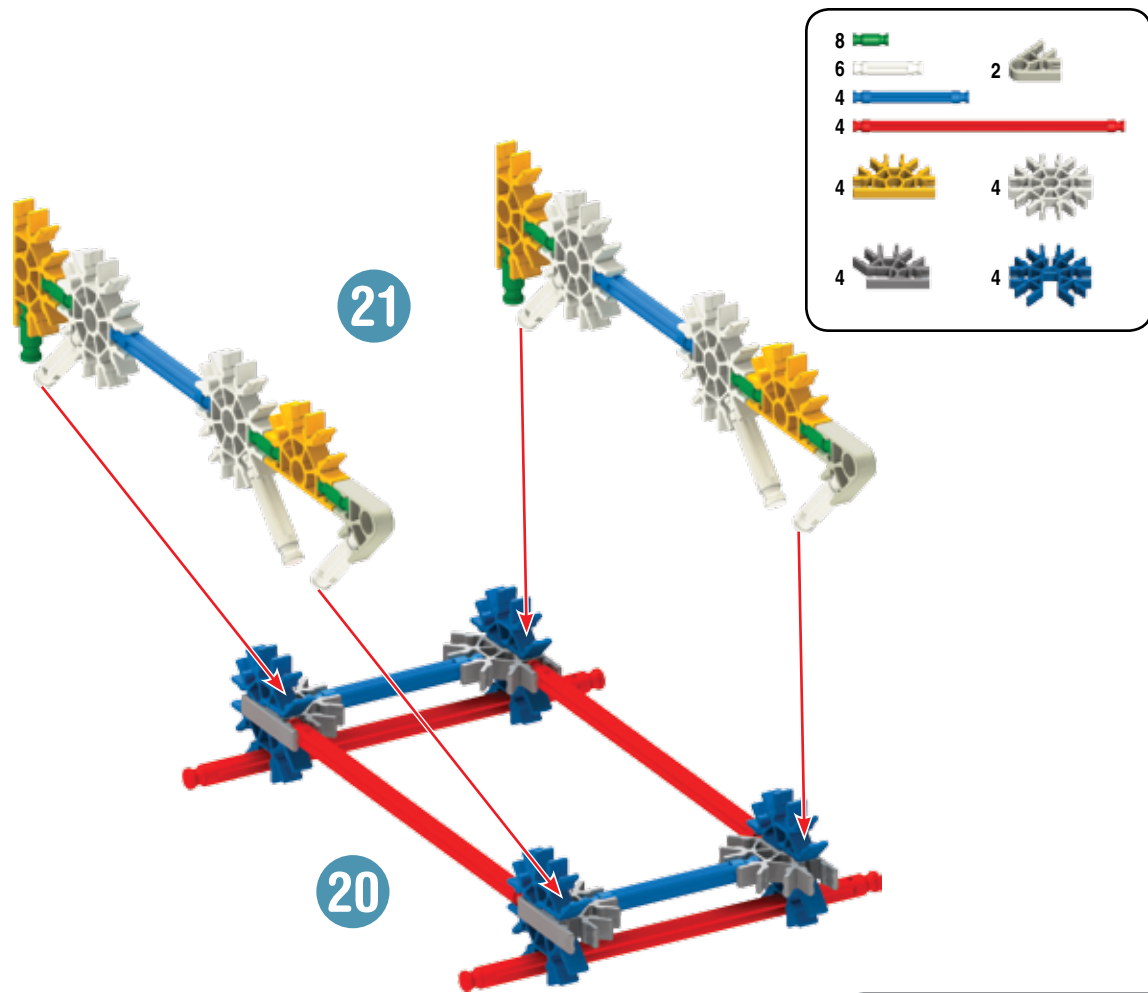

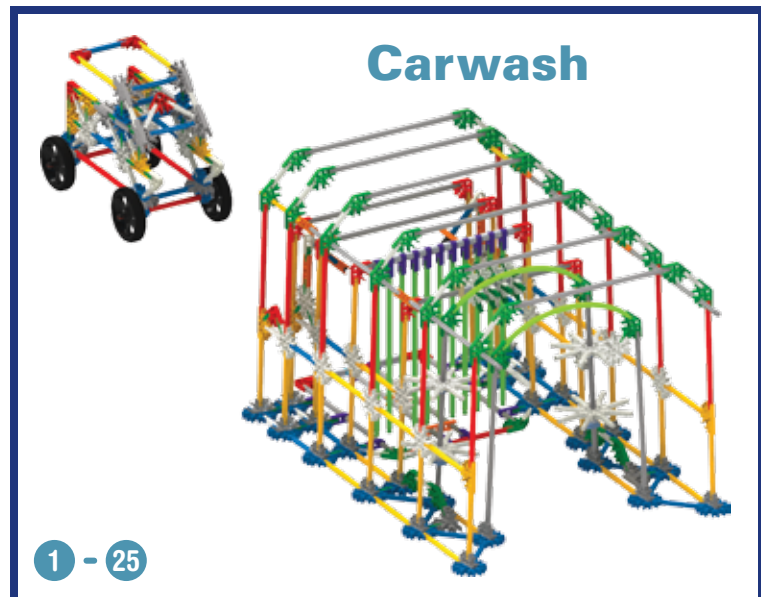
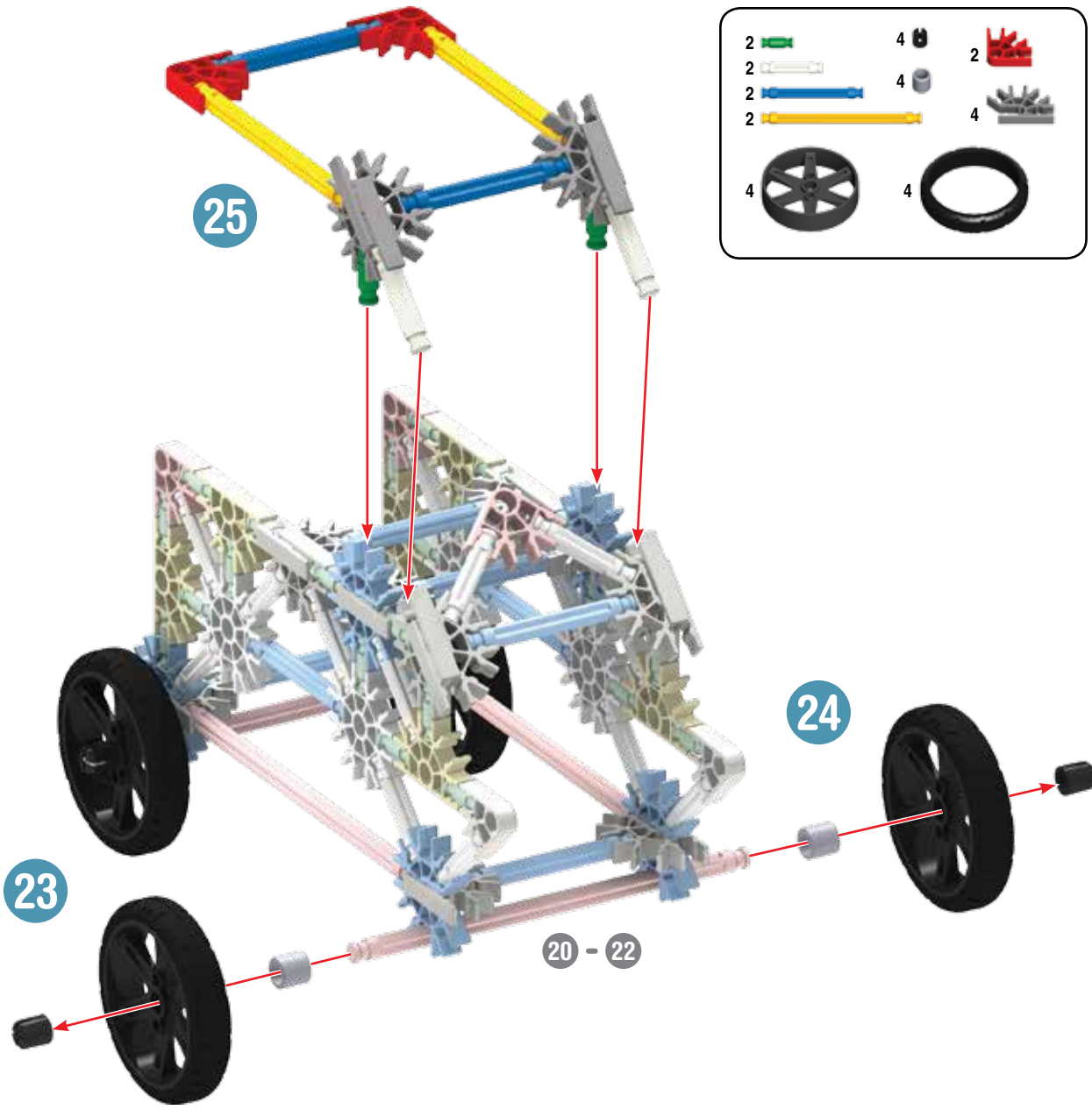

Castle

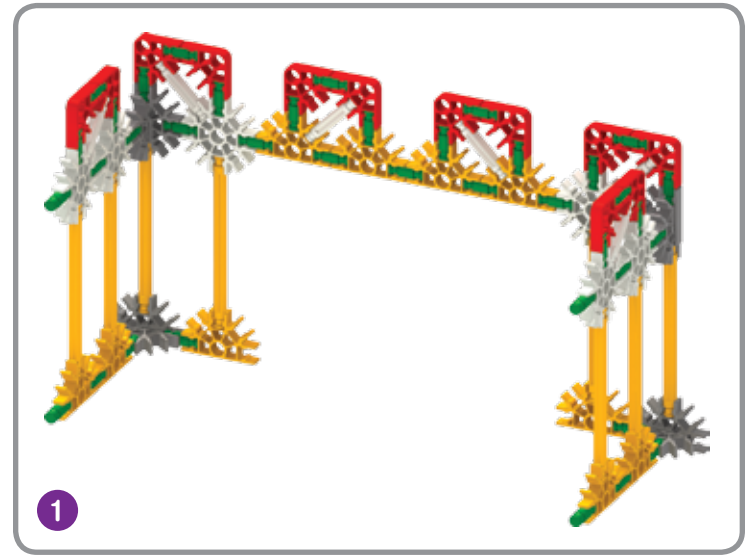

- | | | | | |
|----|--|----|--|--|
| 39 | | 12 | | |
| 6 | | | | |
| 8 | | 6 | | |
| 10 | | 8 | | |

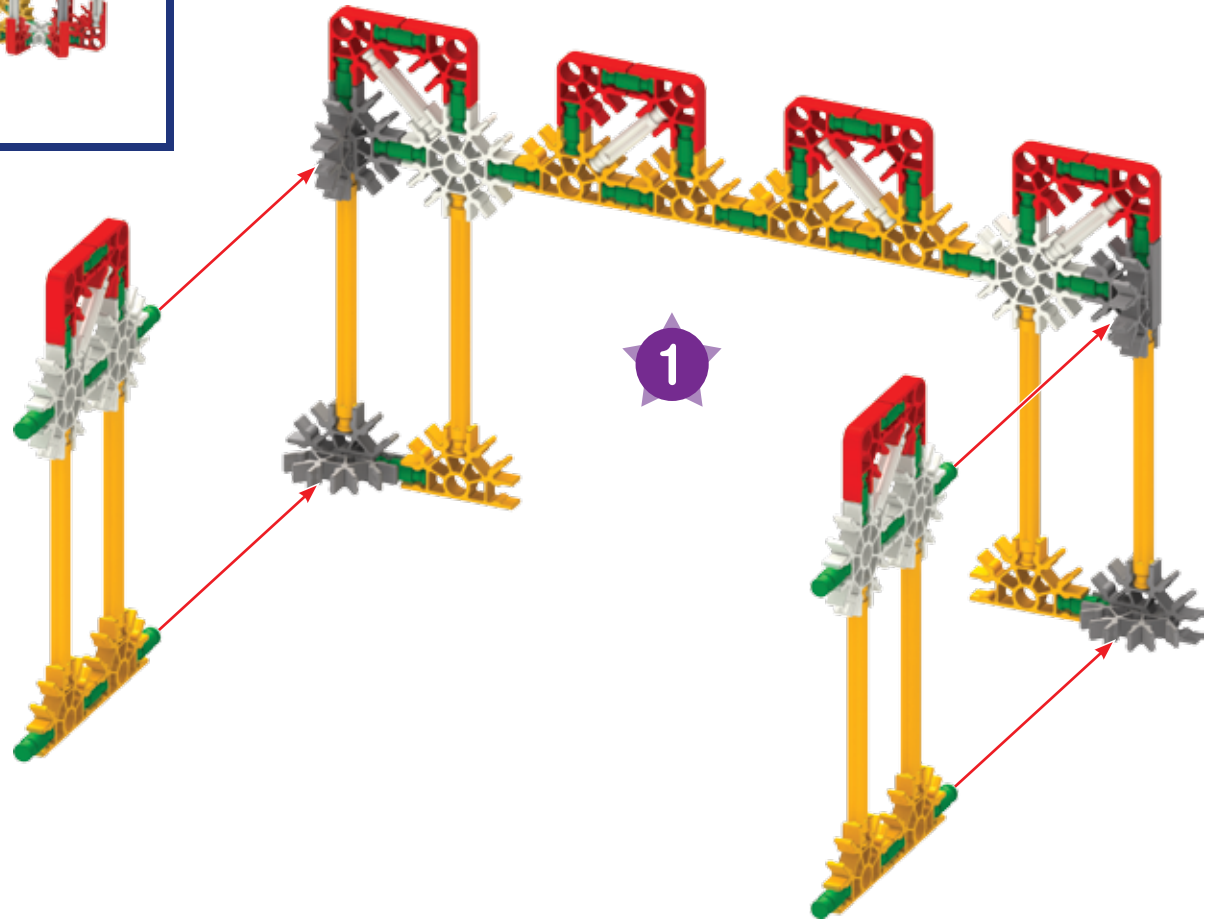

x2

- 20
- 24
- 8
- 4
- 12
- 10
- 14
- 4

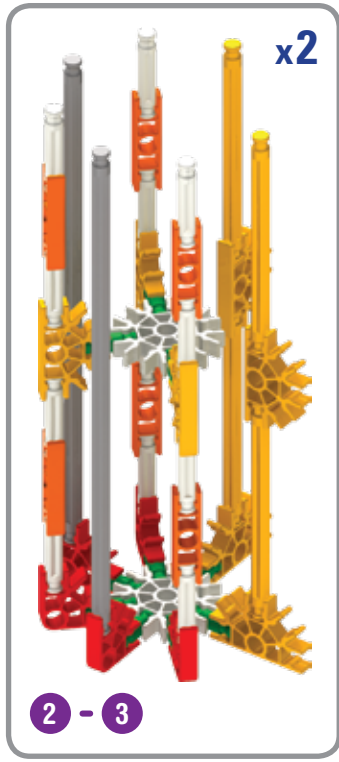
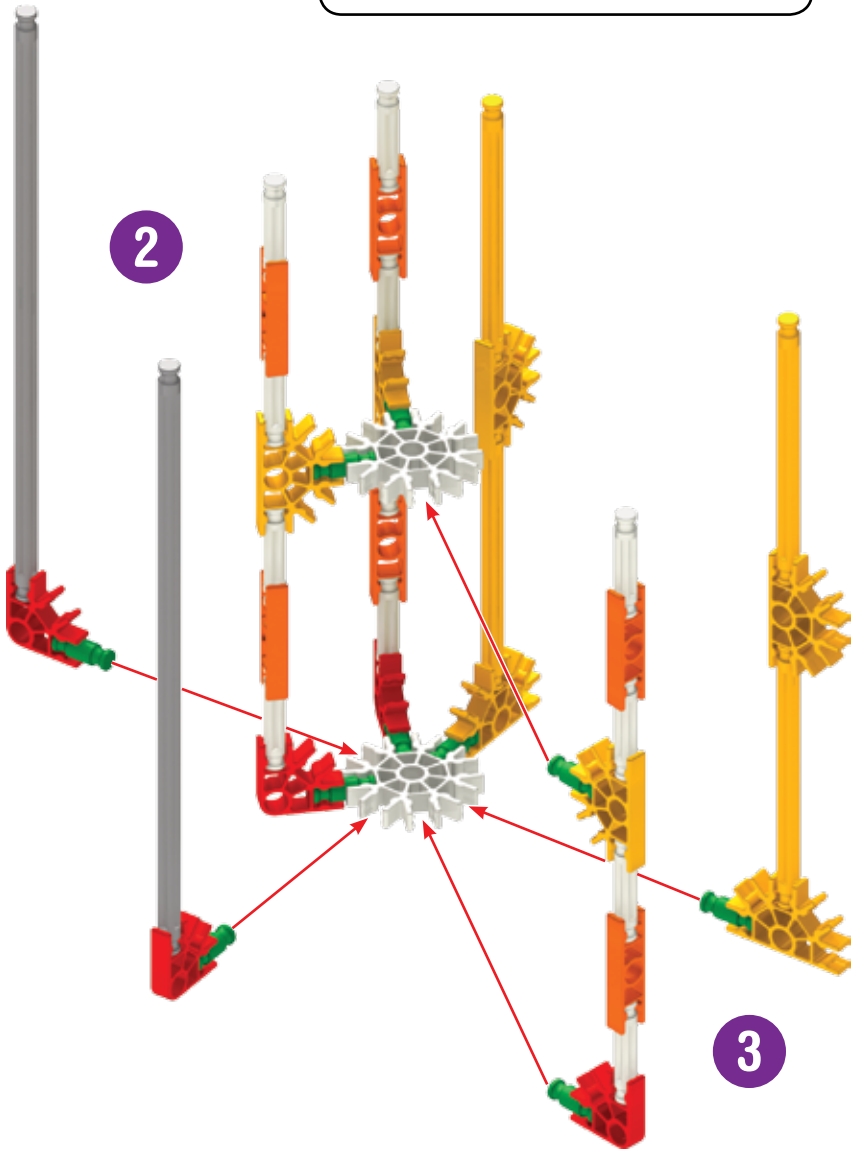

x2

4

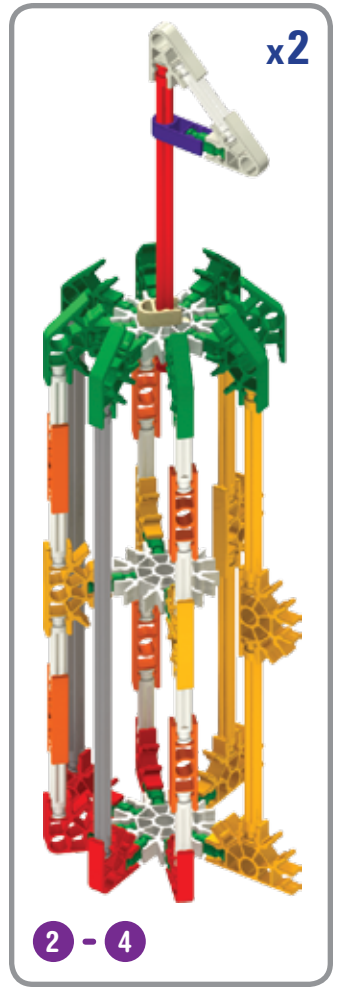
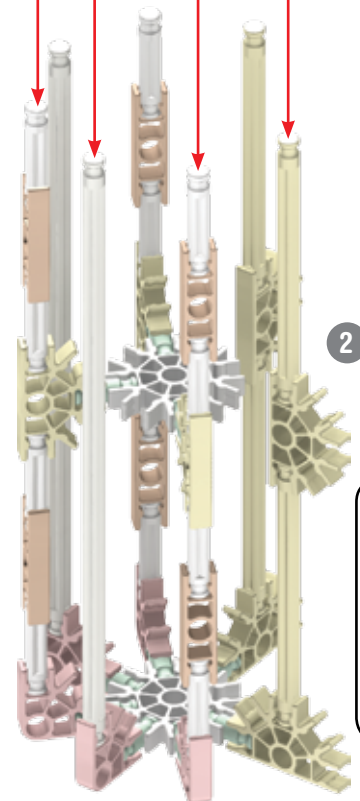

2 - 3

- 18
- 2
- 2
- 16
- 4
- 4
- 2
- 2

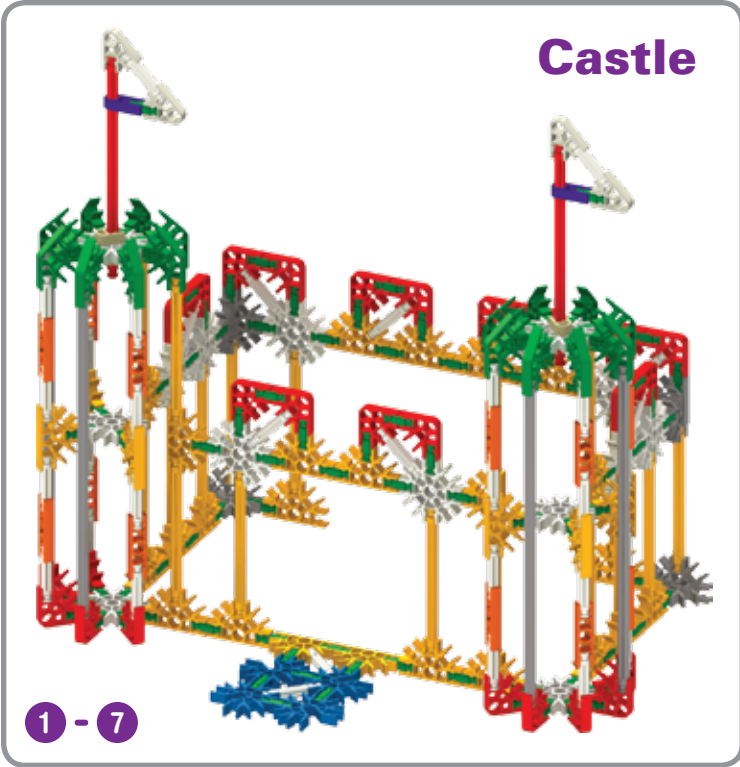
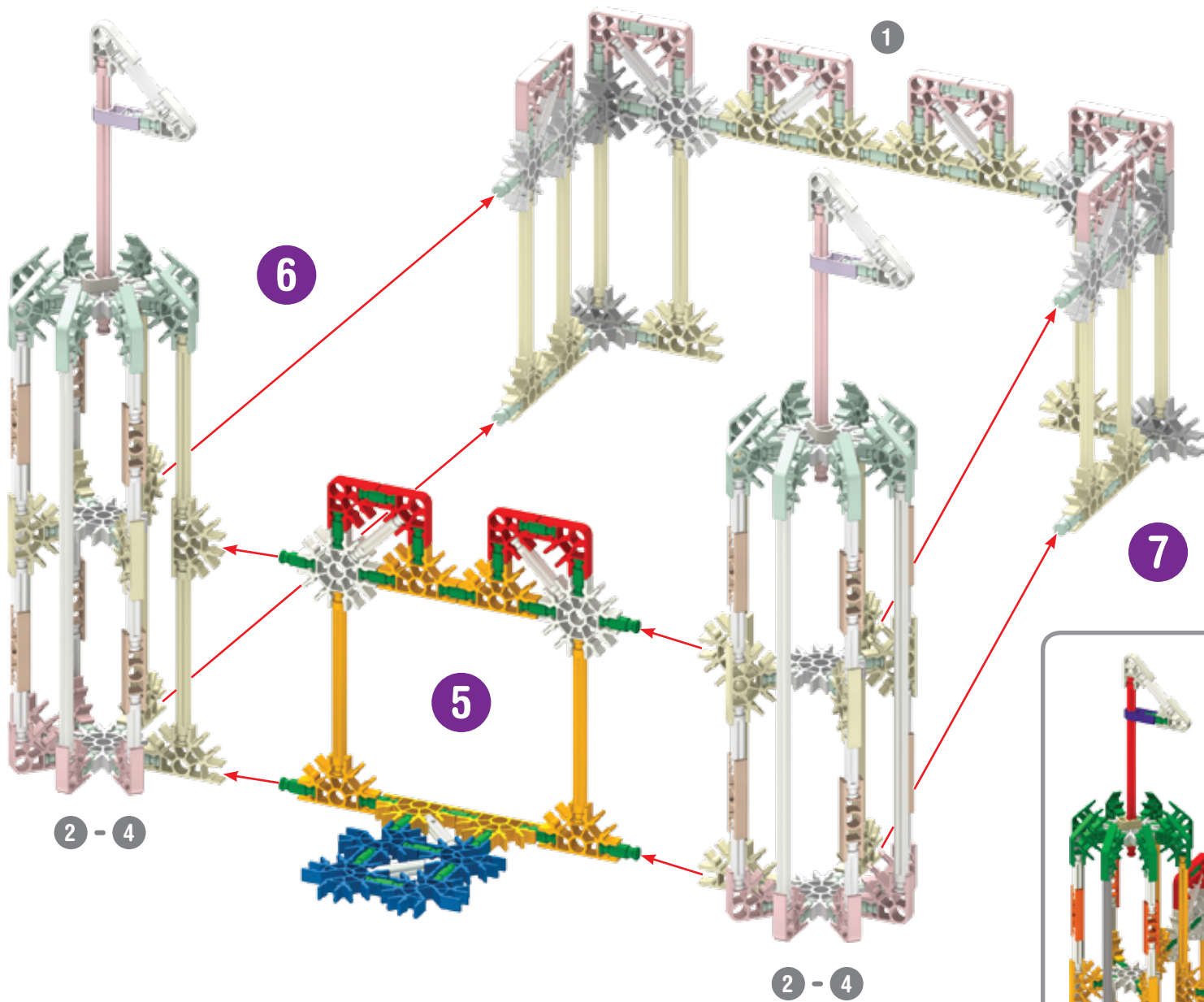

- | | | | | |
|----|--|---|--|--|
| 22 | | 4 | | |
| 4 | | | | |
| 2 | | | | |
| 6 | | 4 | | |



Clock Tower

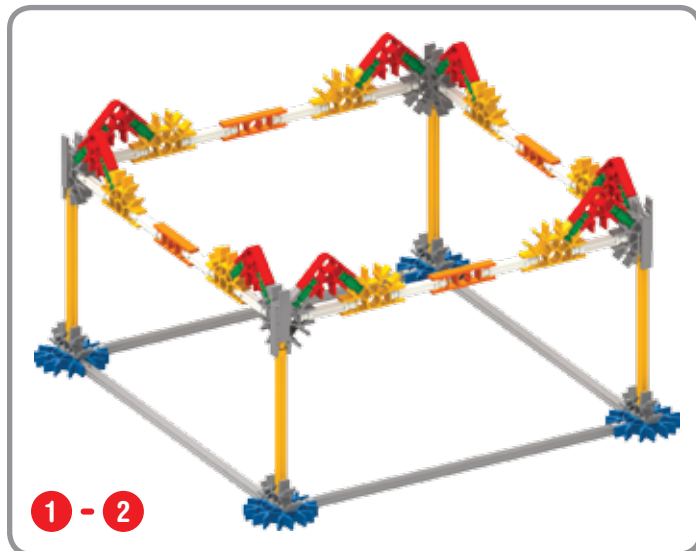
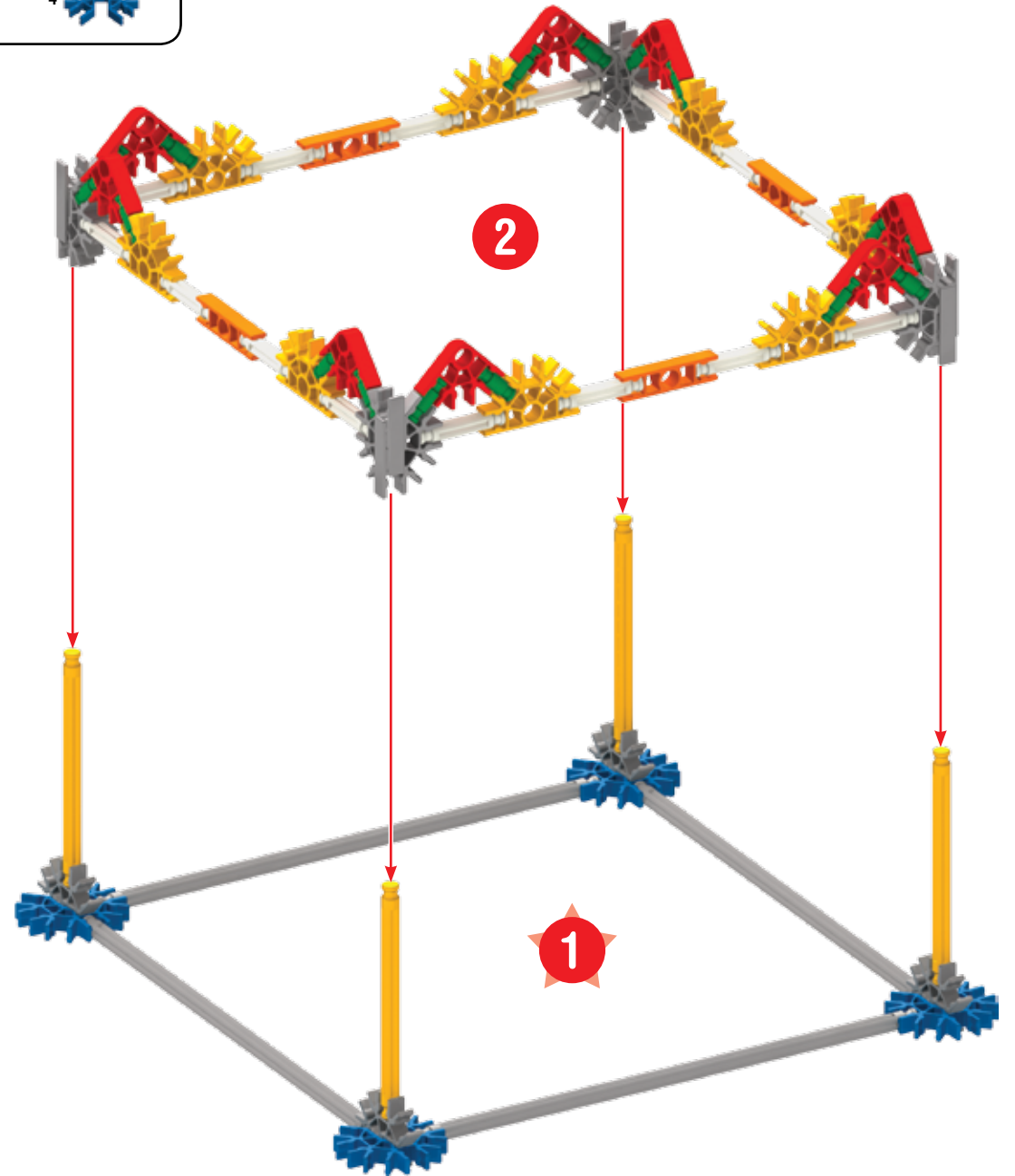

- | | | | | | |
|----|--|----|--|---|--|
| 16 | | 8 | | 8 | |
| 16 | | | | | |
| 4 | | | | | |
| 4 | | | | | |
| 4 | | 12 | | 4 | |

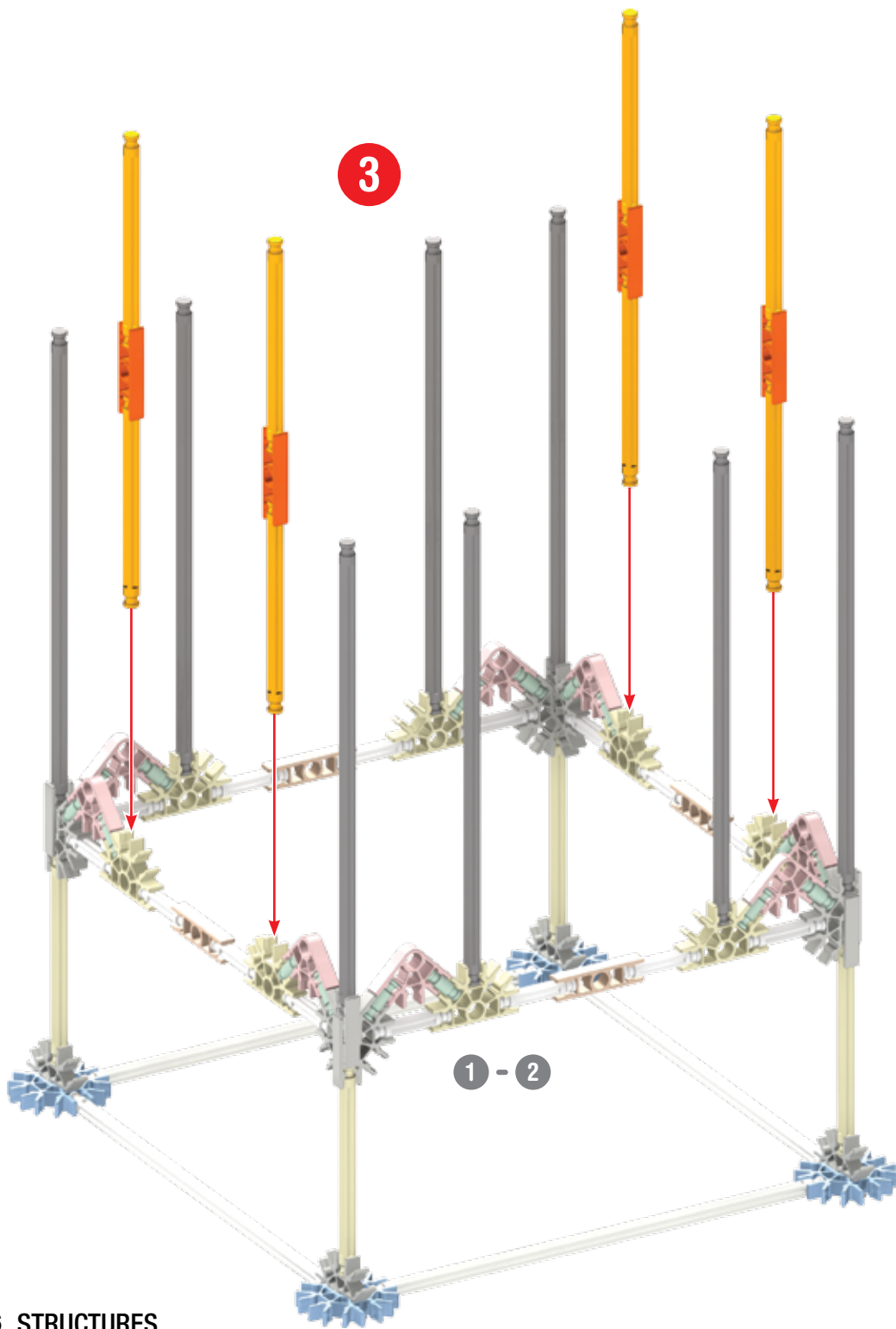



- 8 
- 8 
- 4 

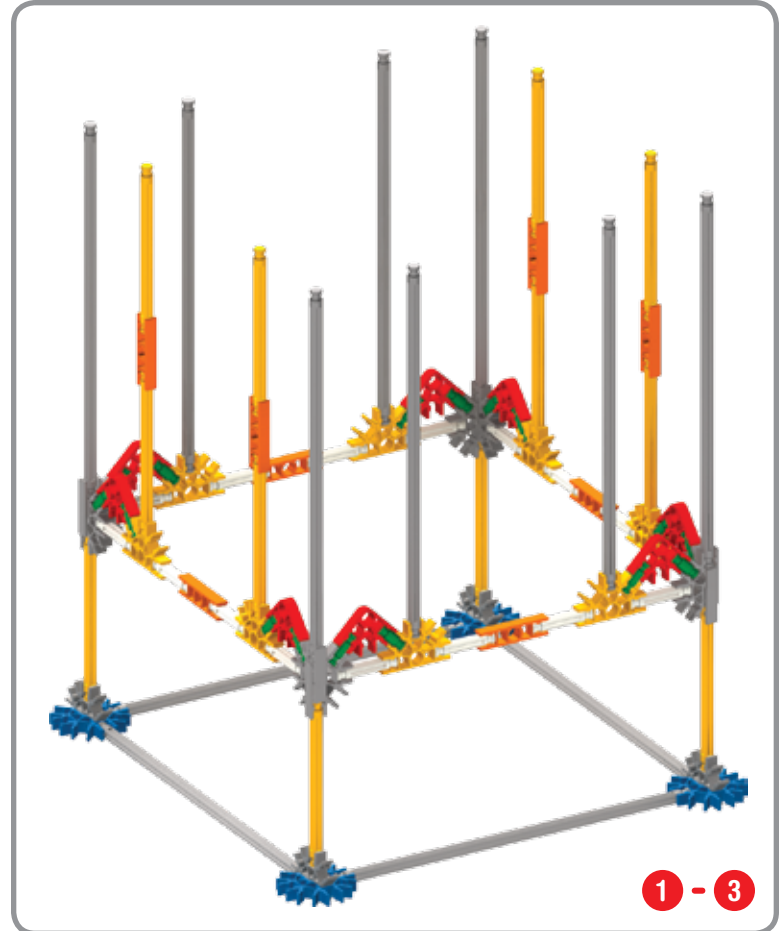

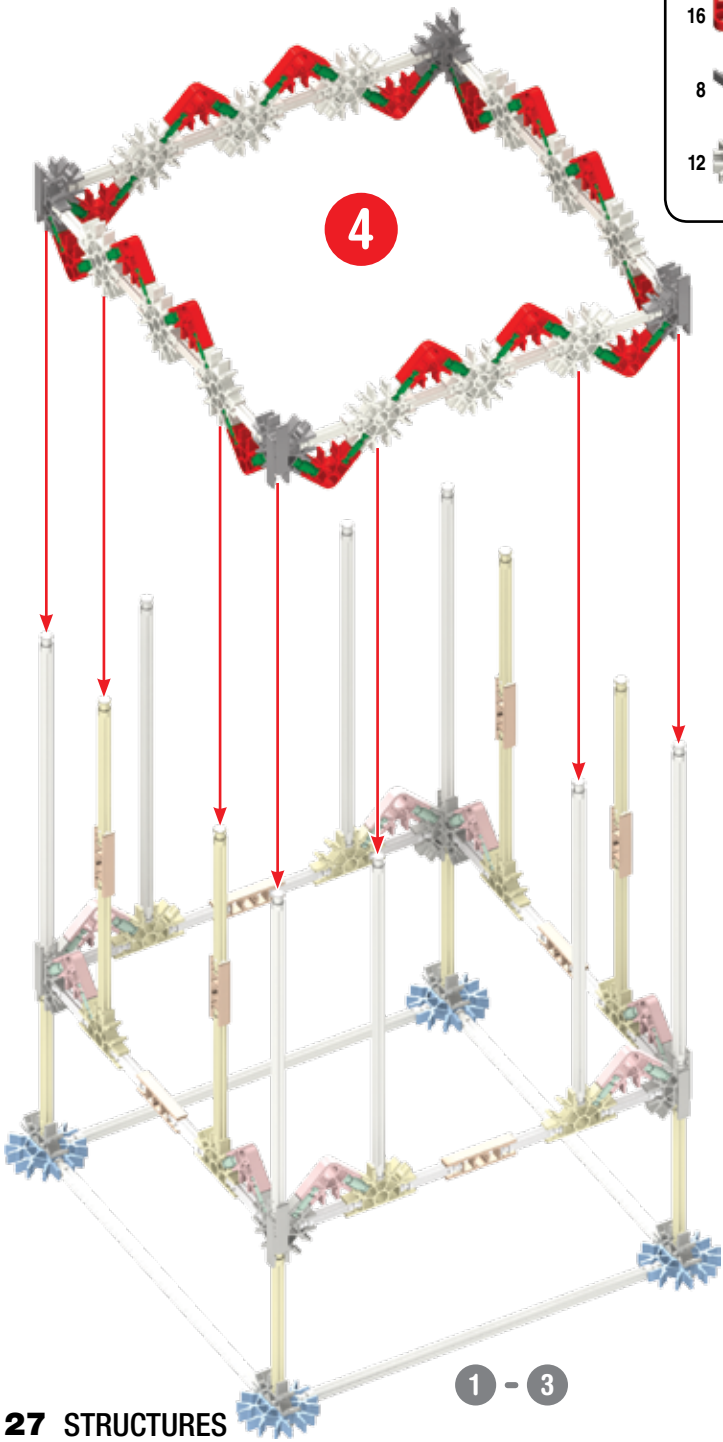

- 32
- 16
- 16
- 8
- 12

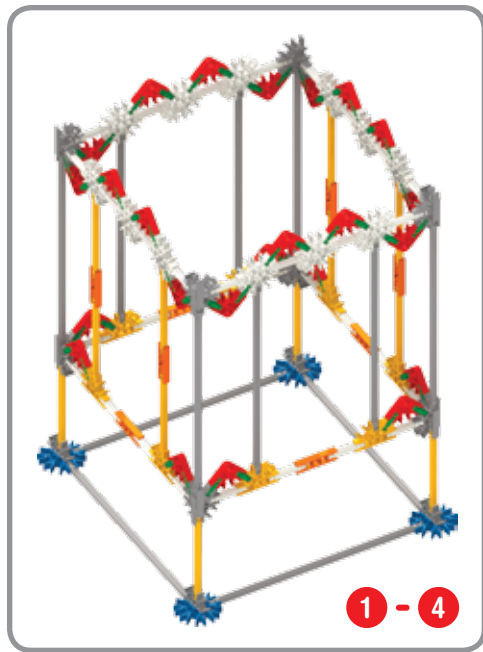
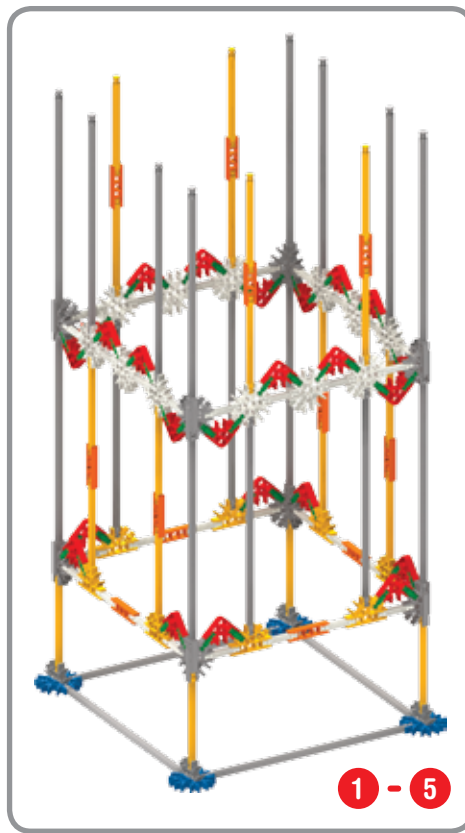

- 8
- 8
- 4



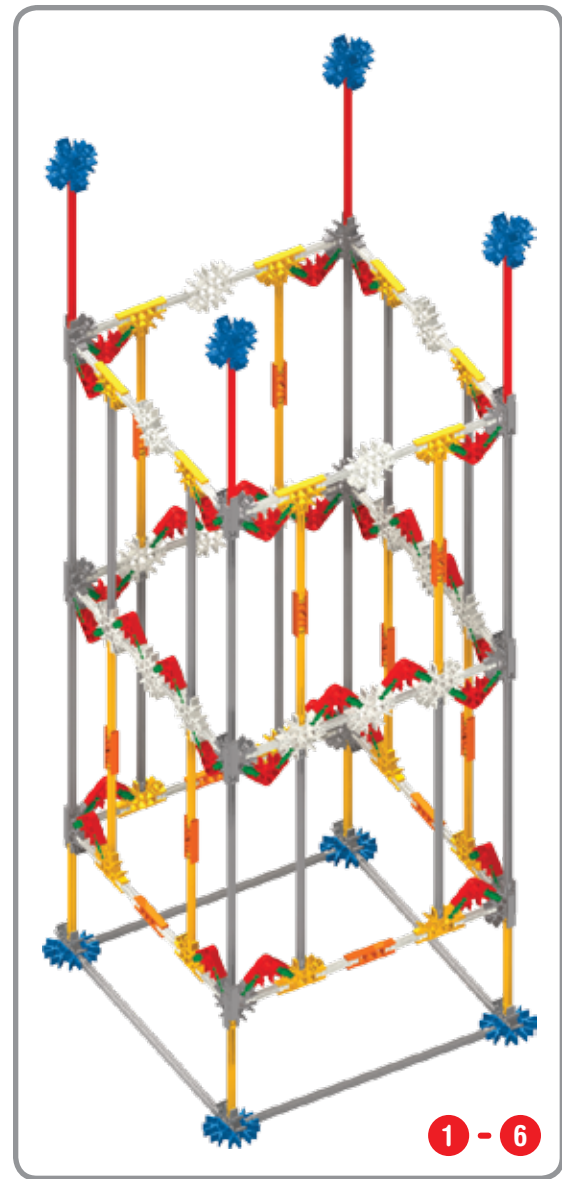
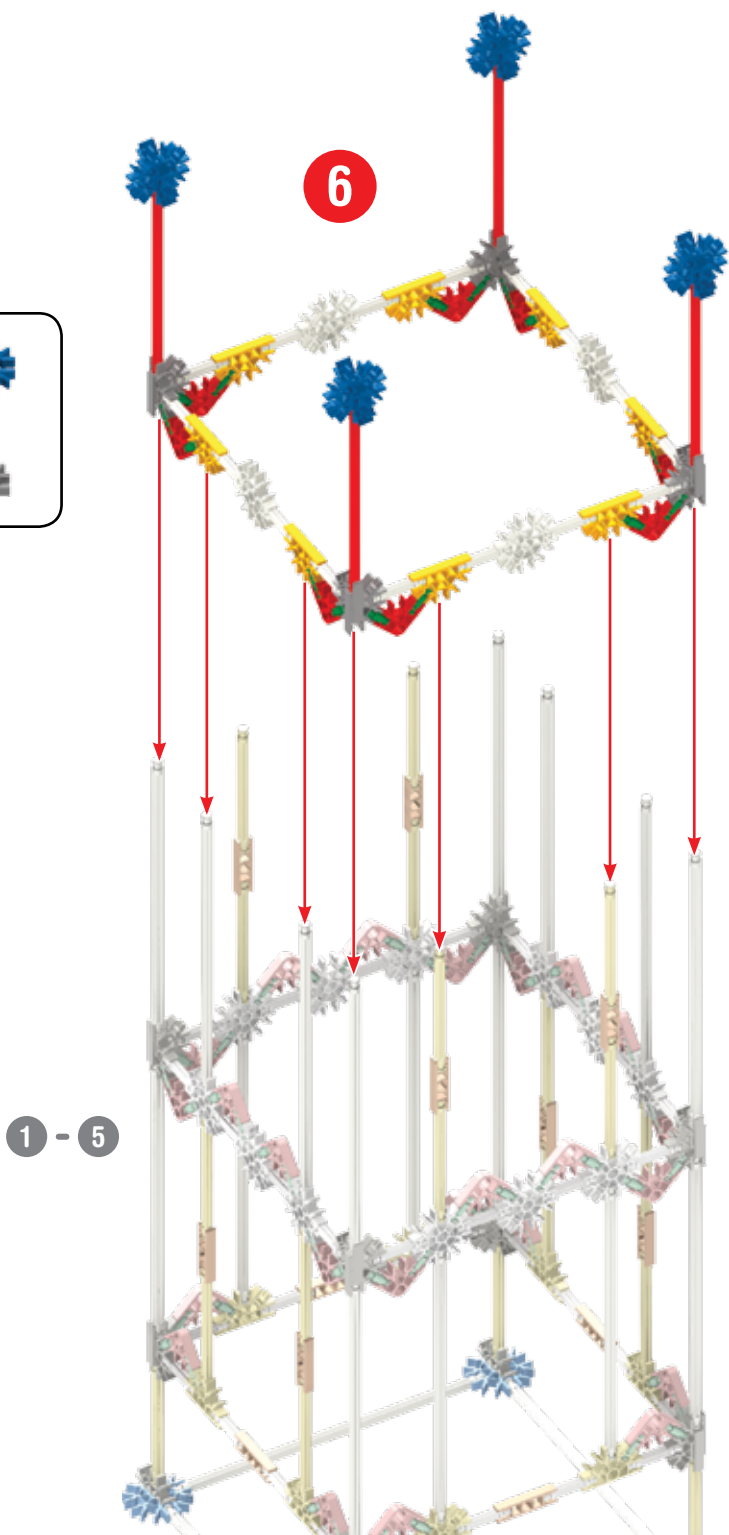
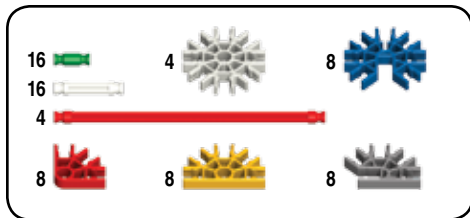

x3

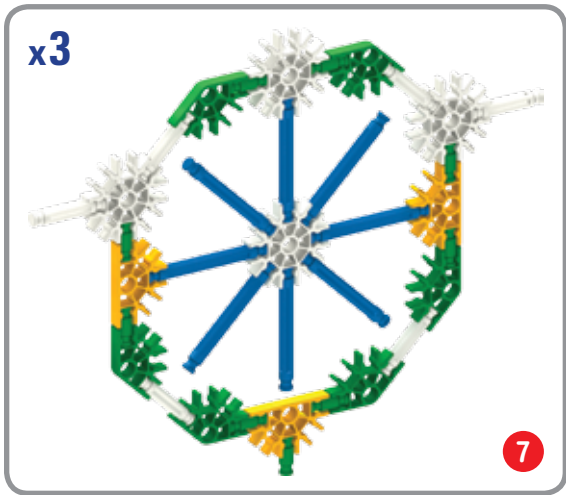
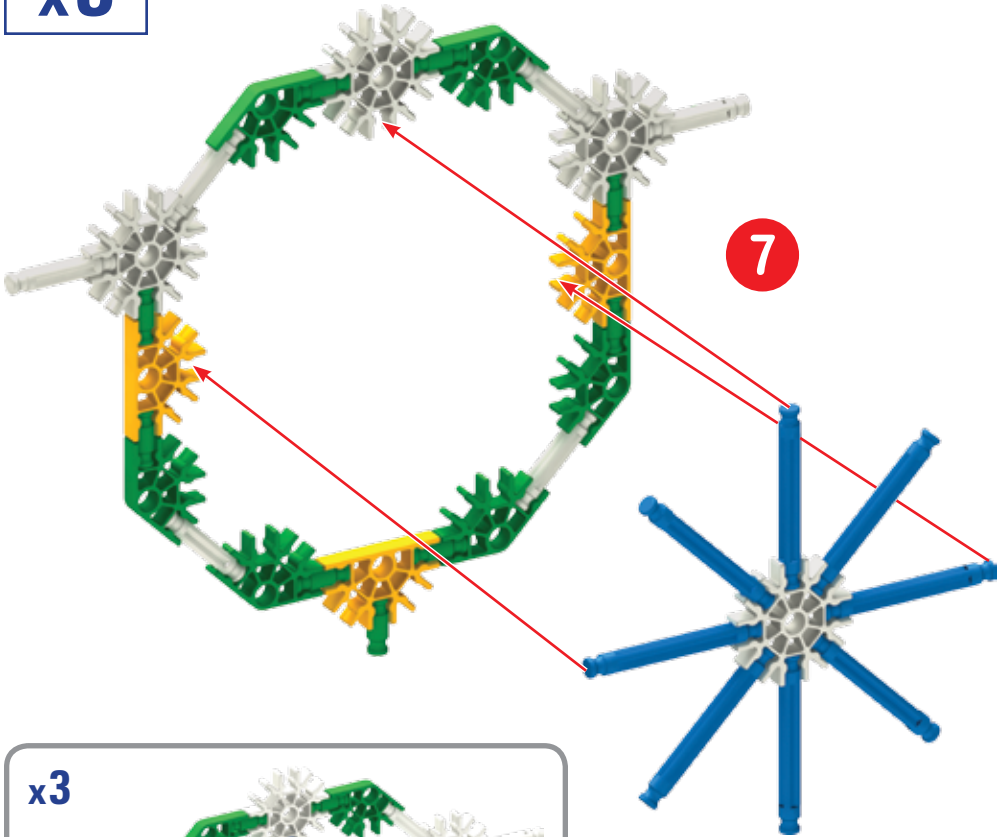

27		12	
18			
24			
18		9	

6		3	
6			
3			
3		6	

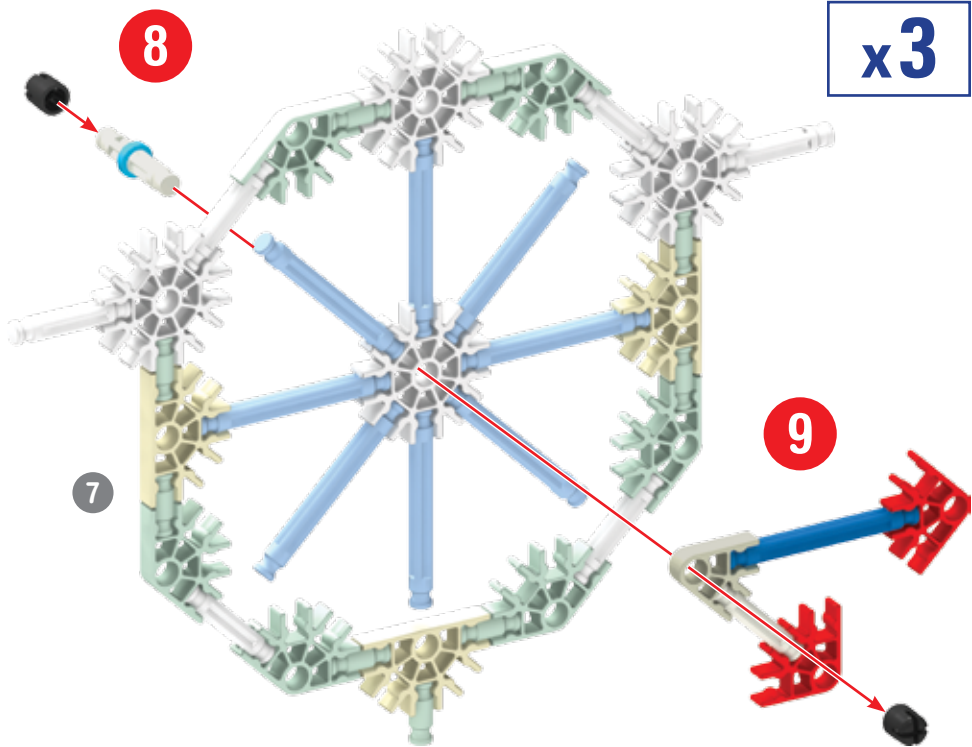

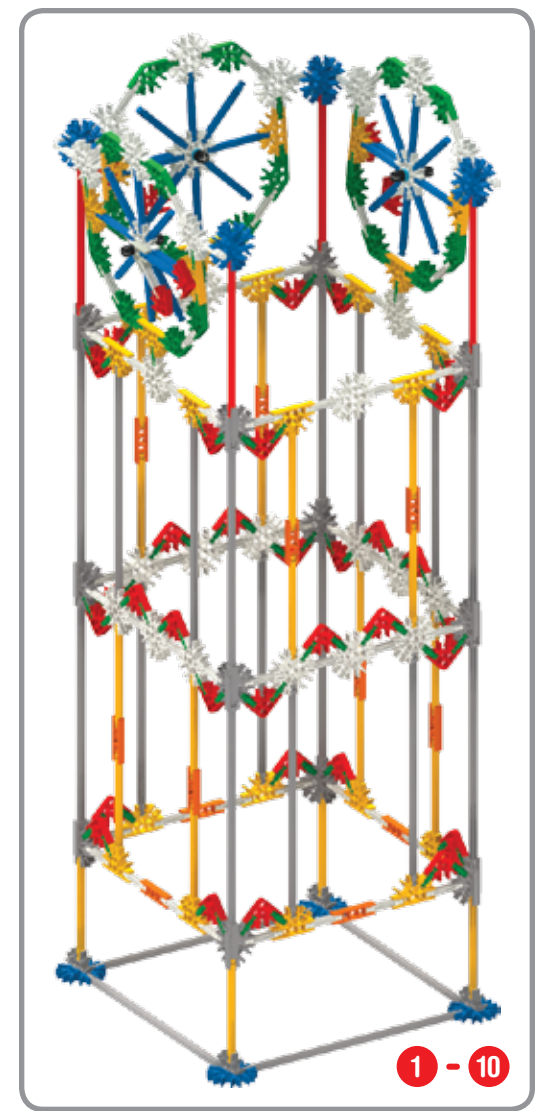
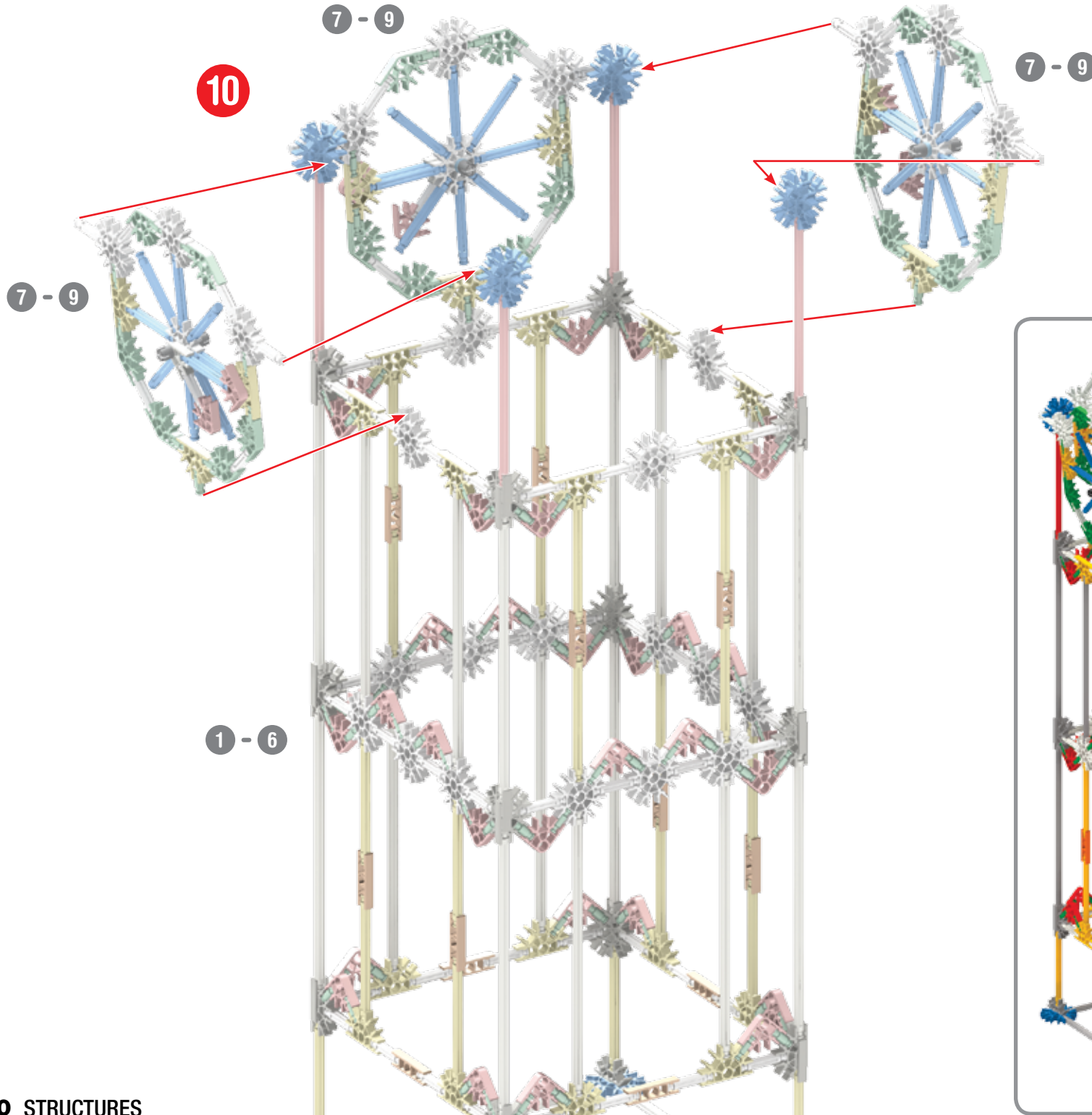

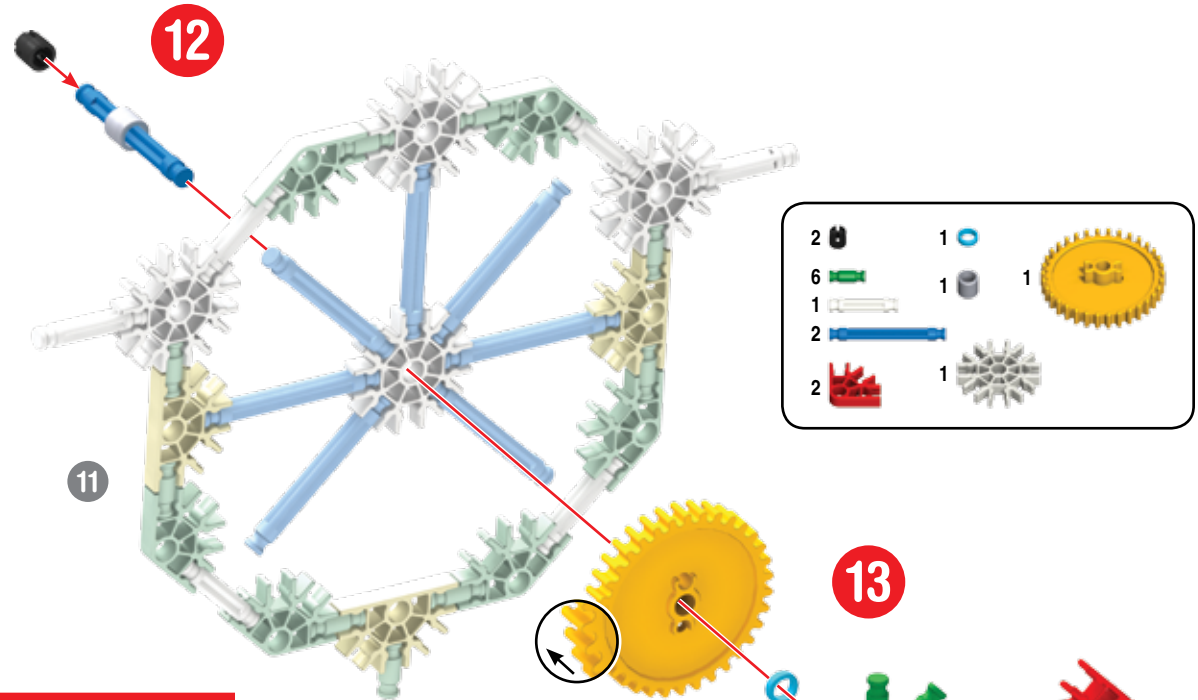
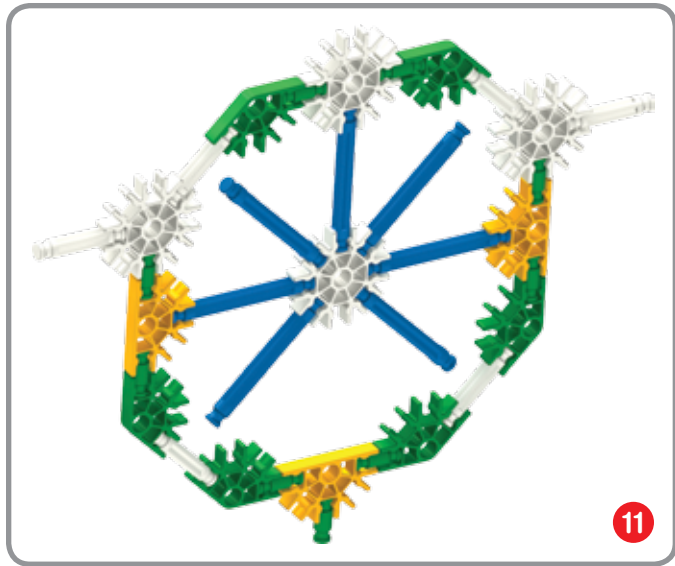

2	1	1	
6	1	1	1
1			1
2			1
2			1

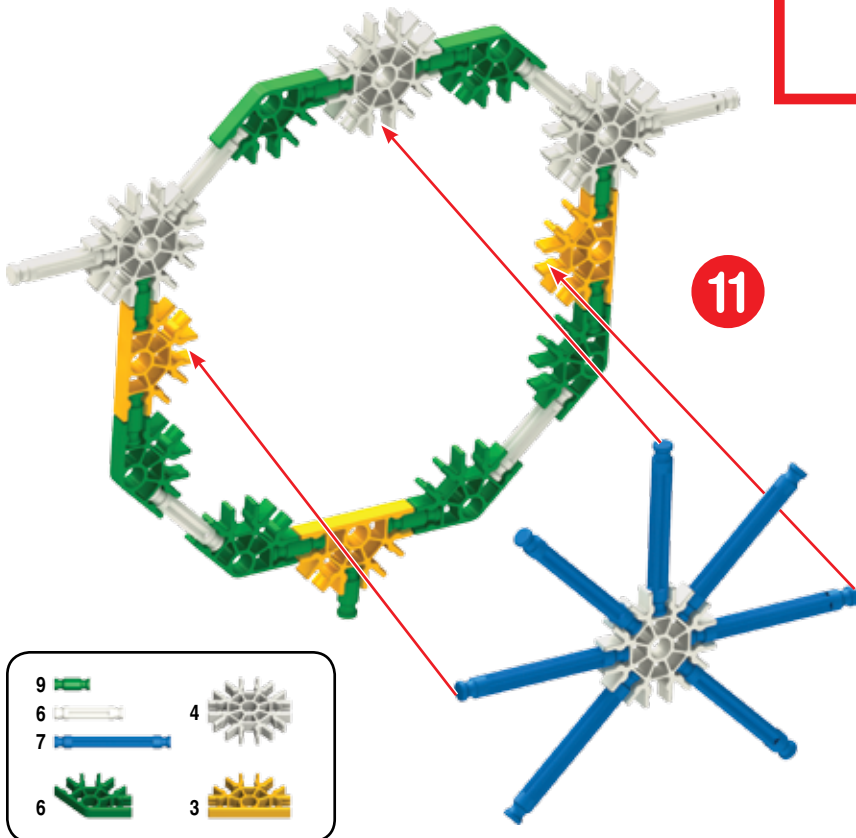
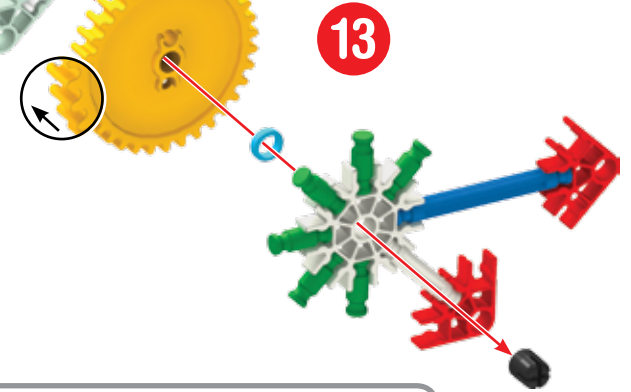

9	4	
6		1
7		1
6		1



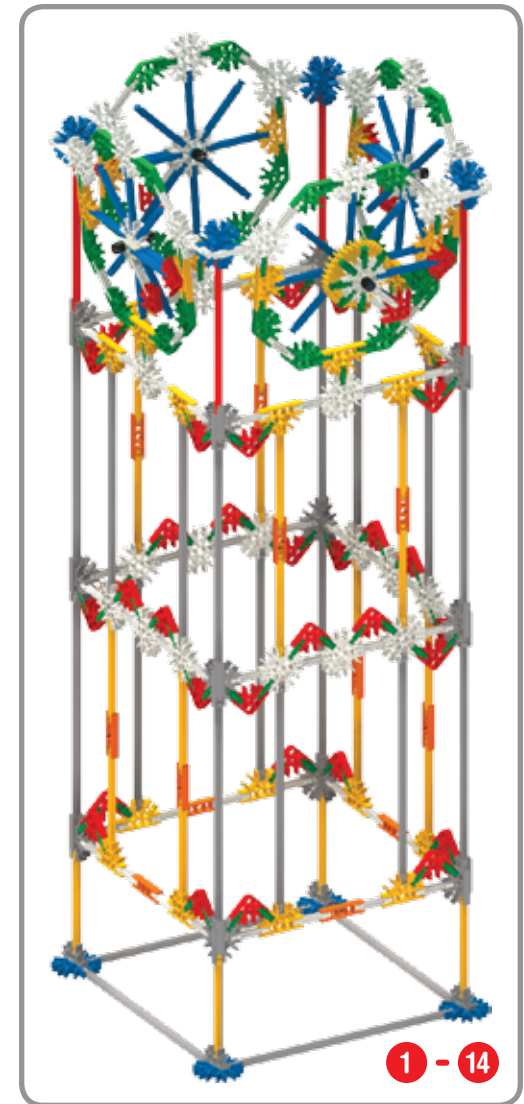
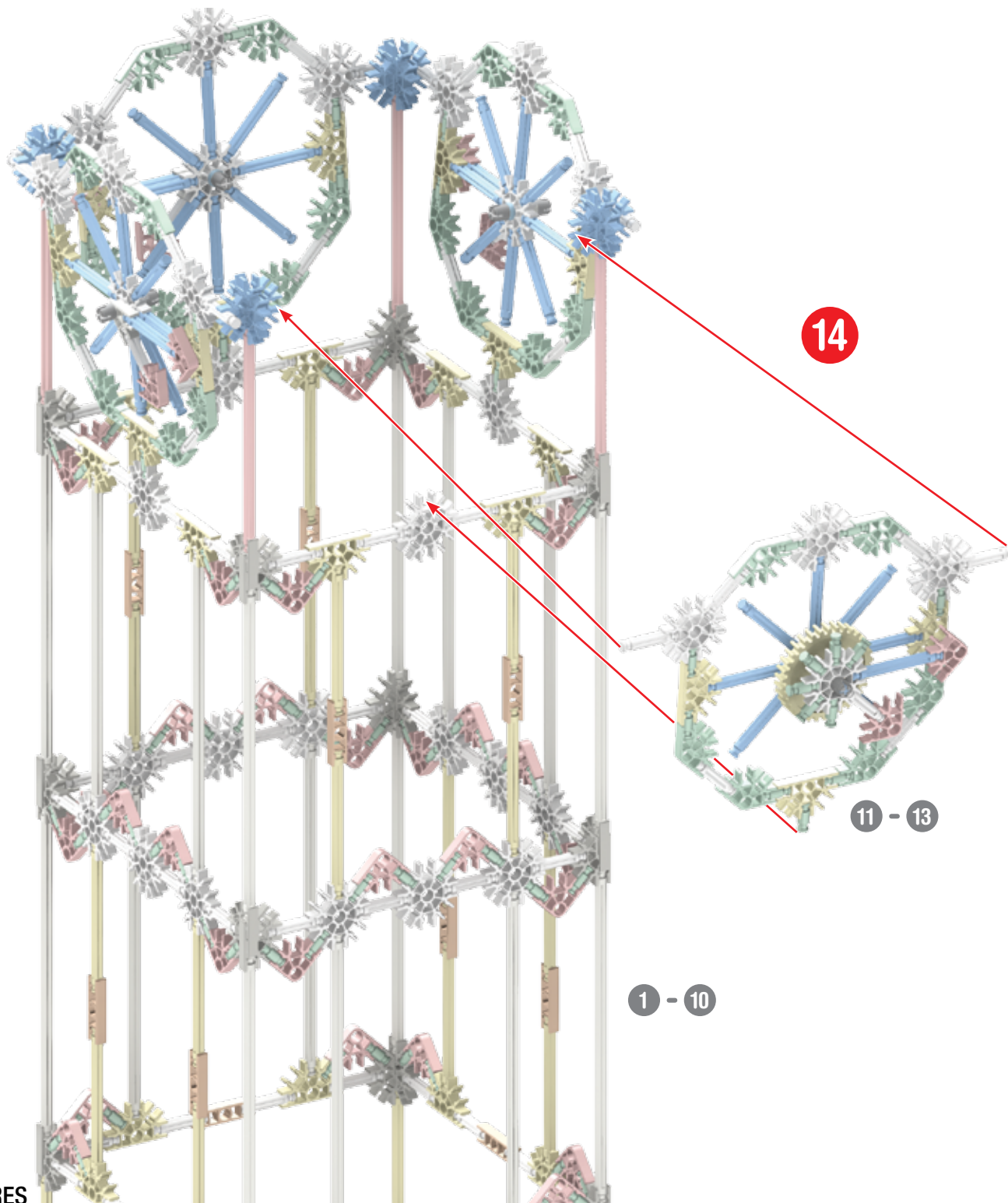

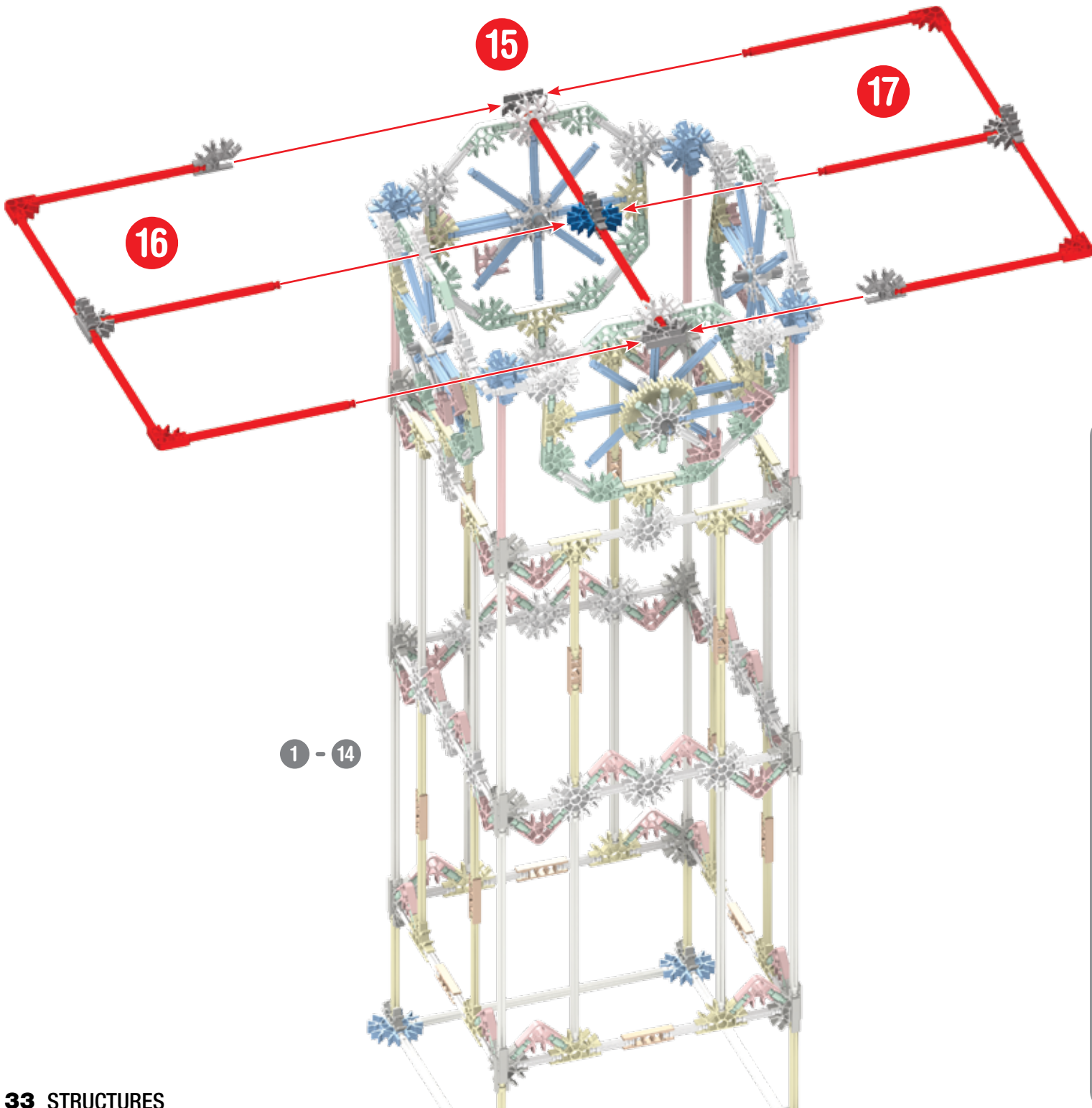

1 - 14

12	
4	
9	
1	



1 - 17

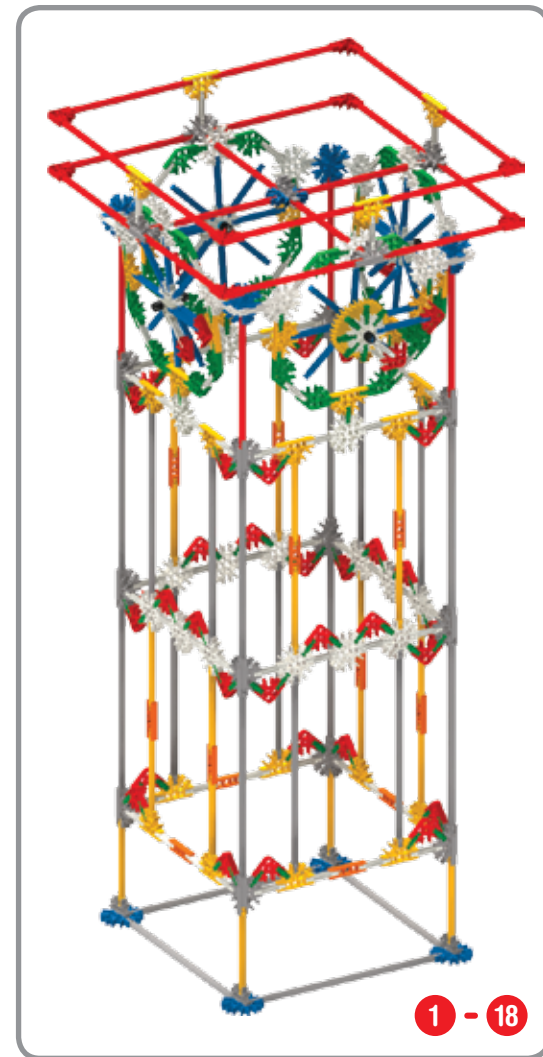
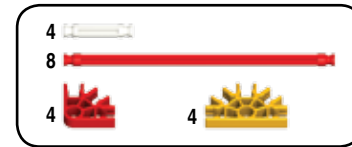
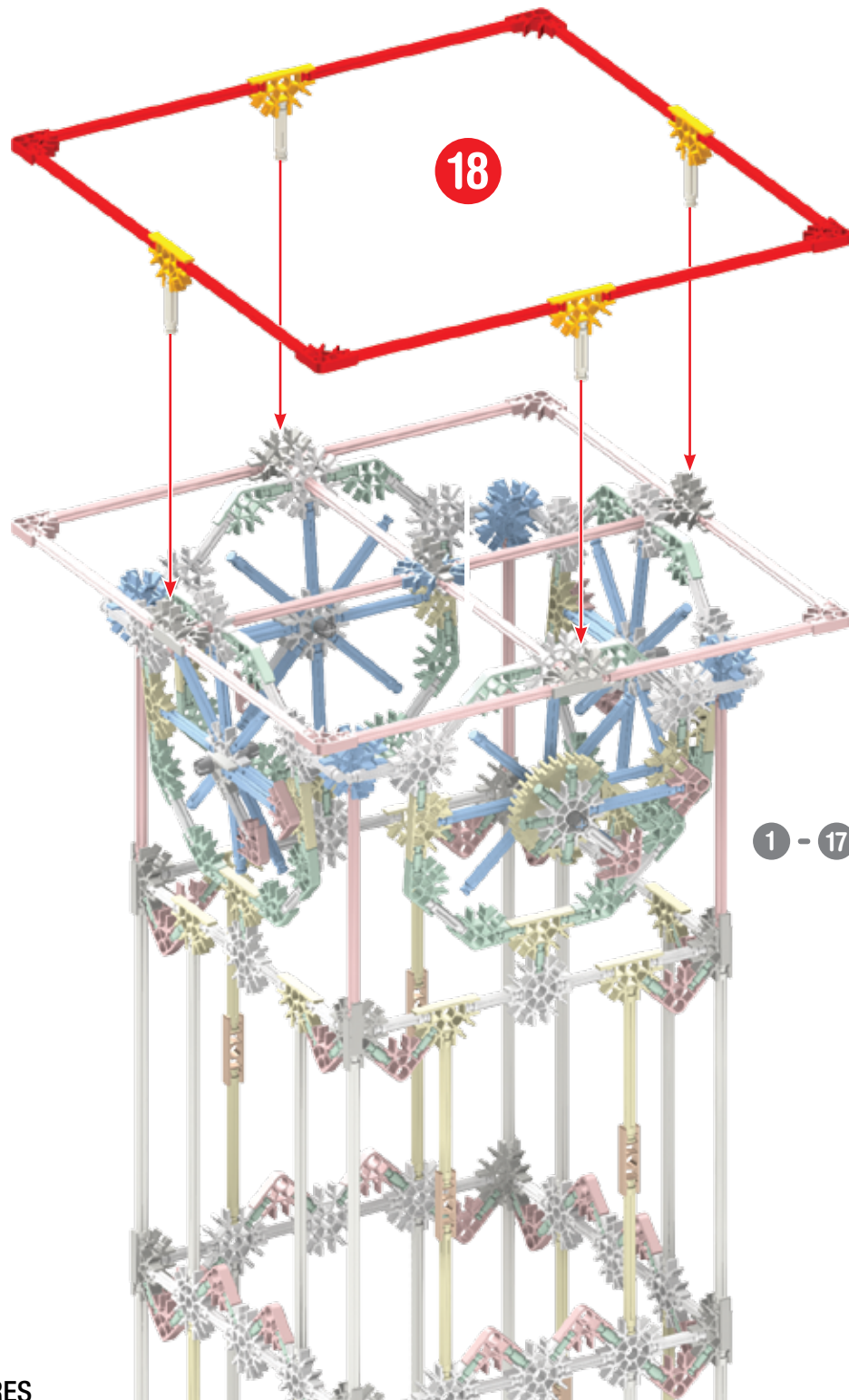

Clock Tower

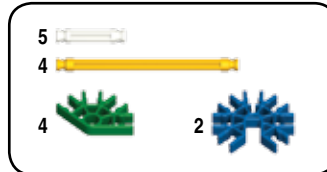

20

1 - 19

1 - 20



1 - 19

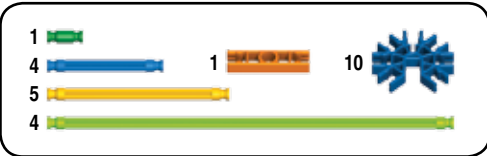

19

1 - 18

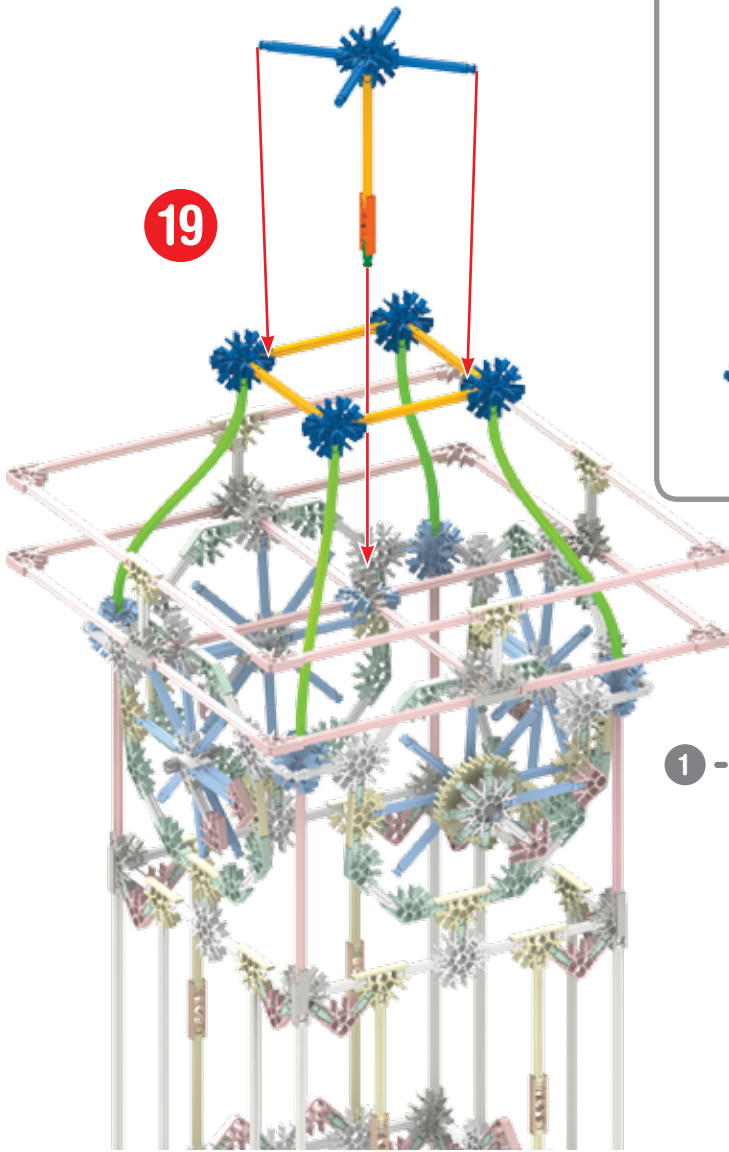

House

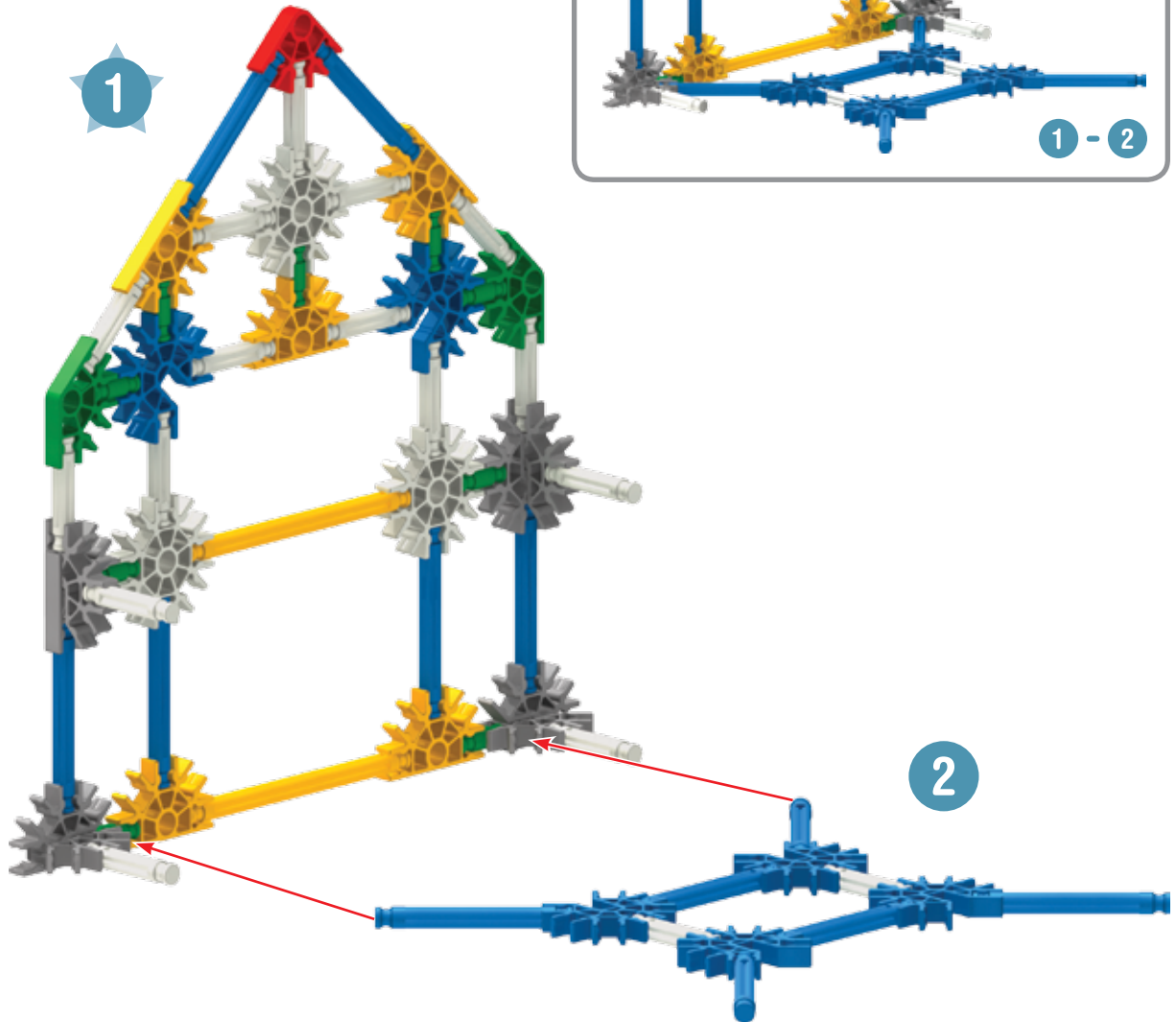
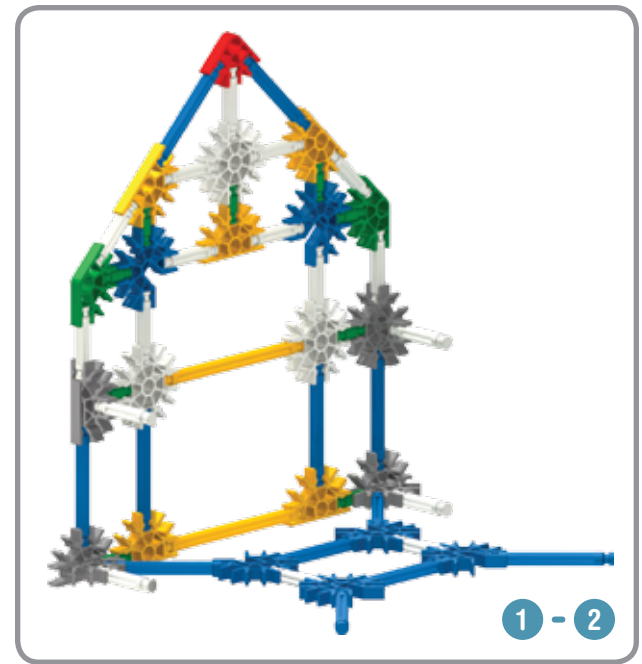
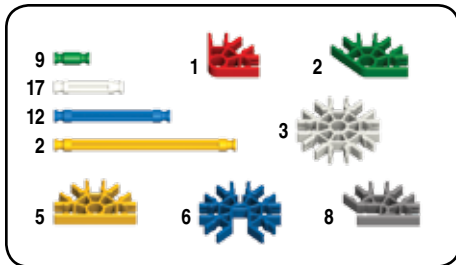
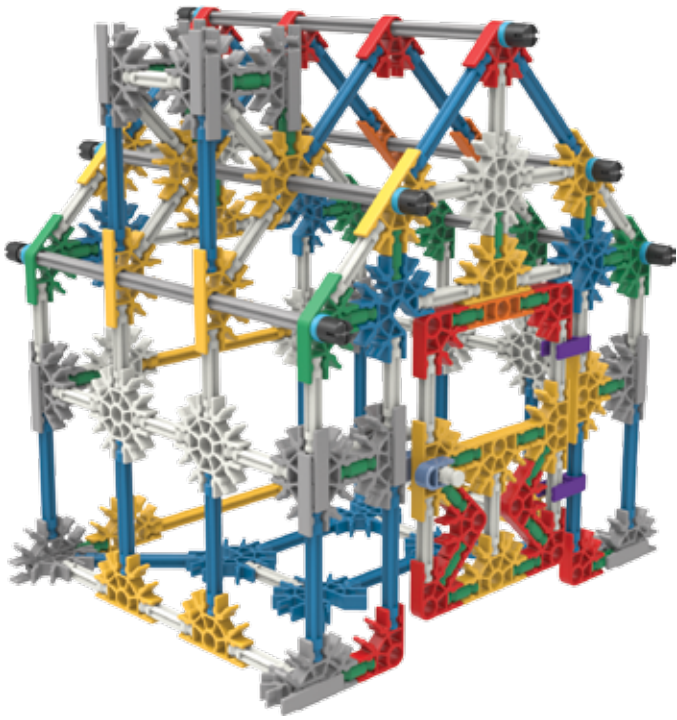

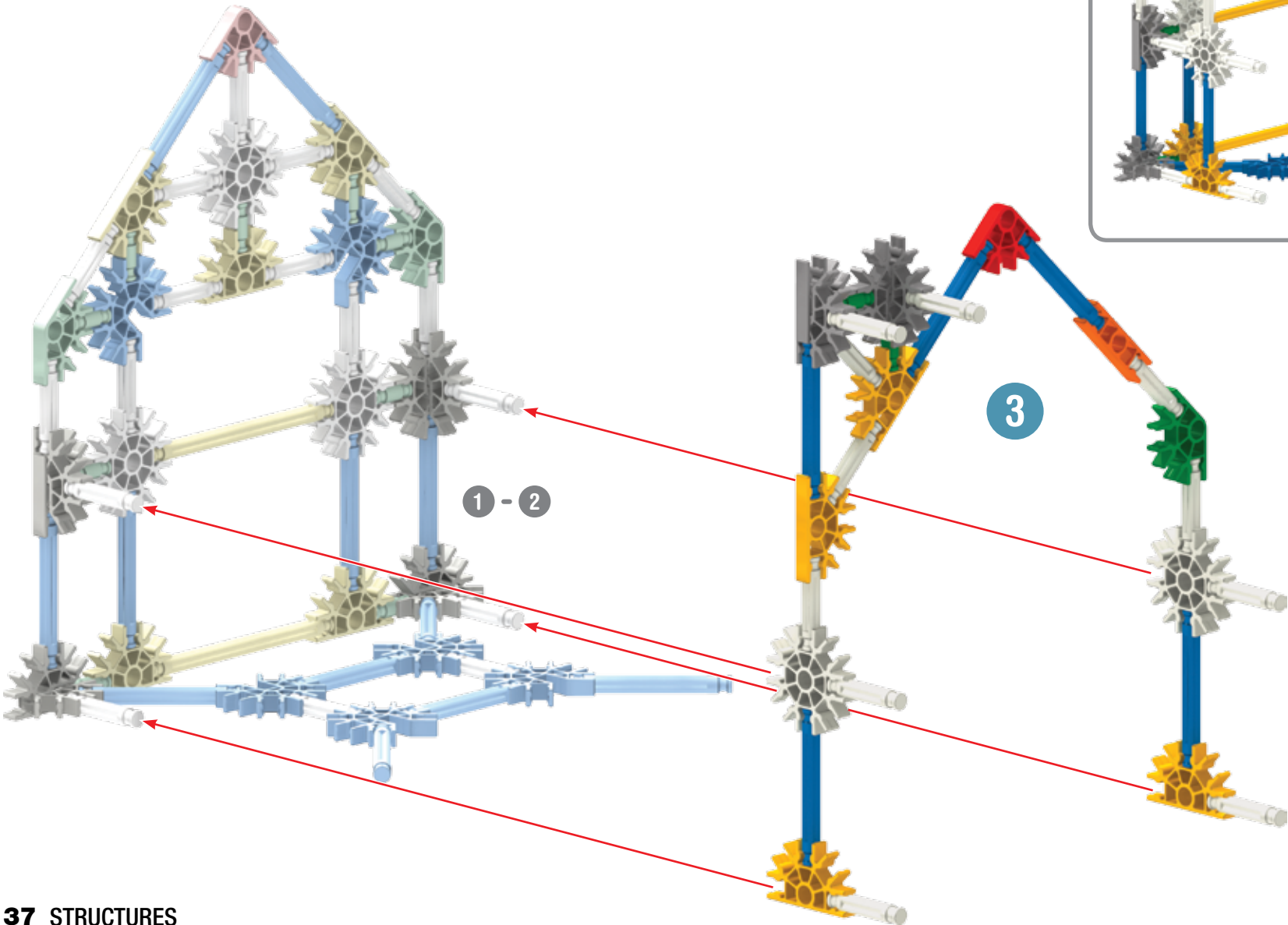
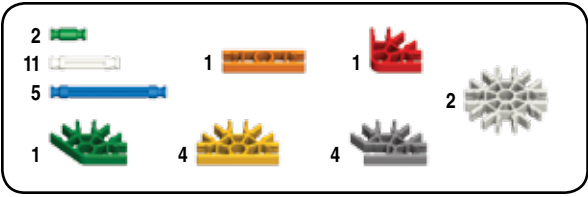

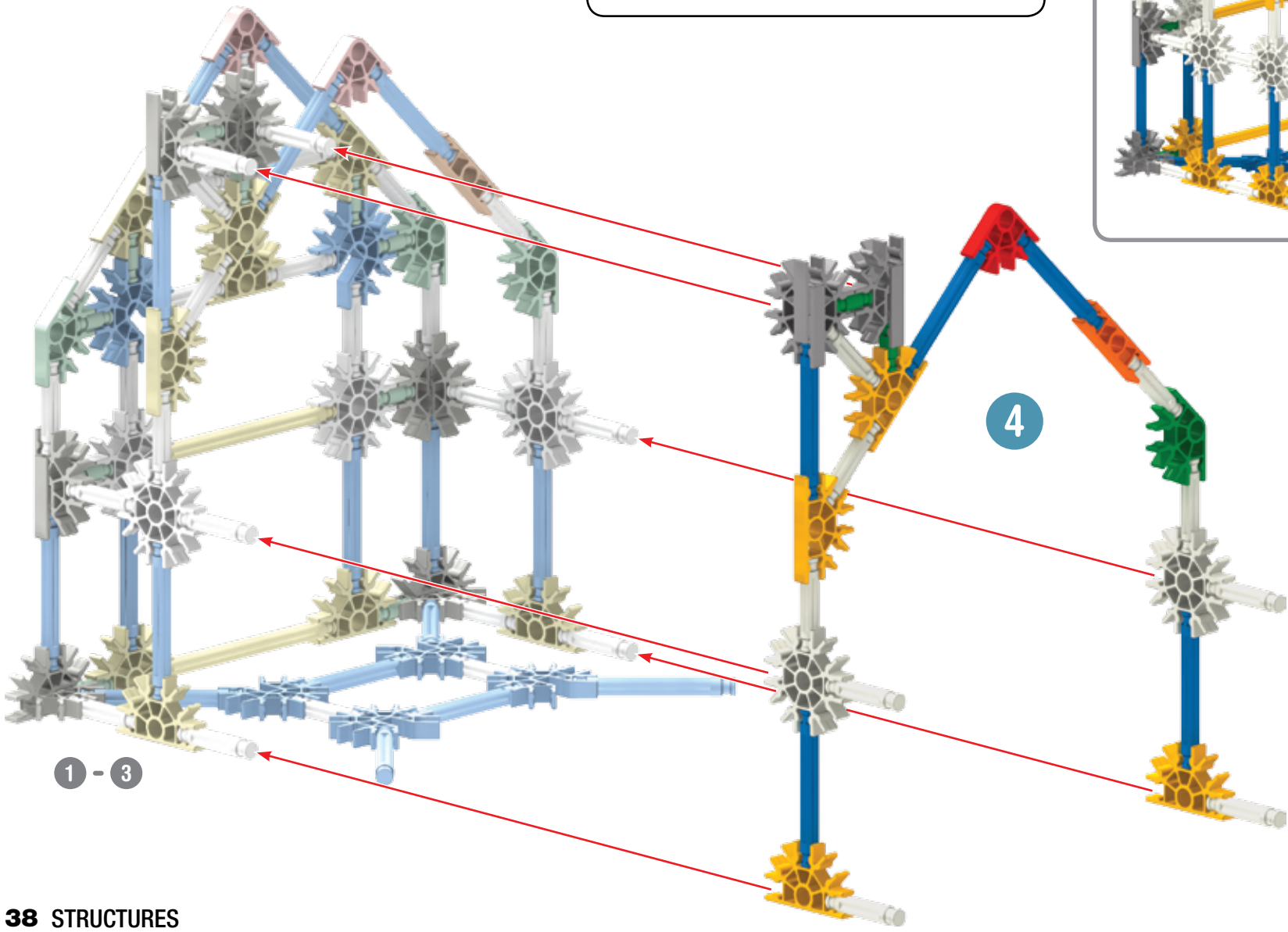
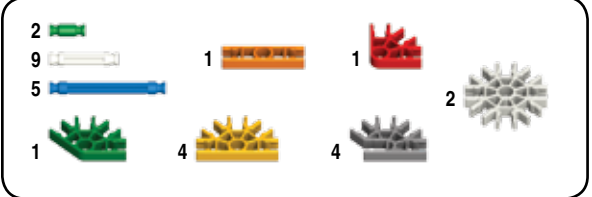

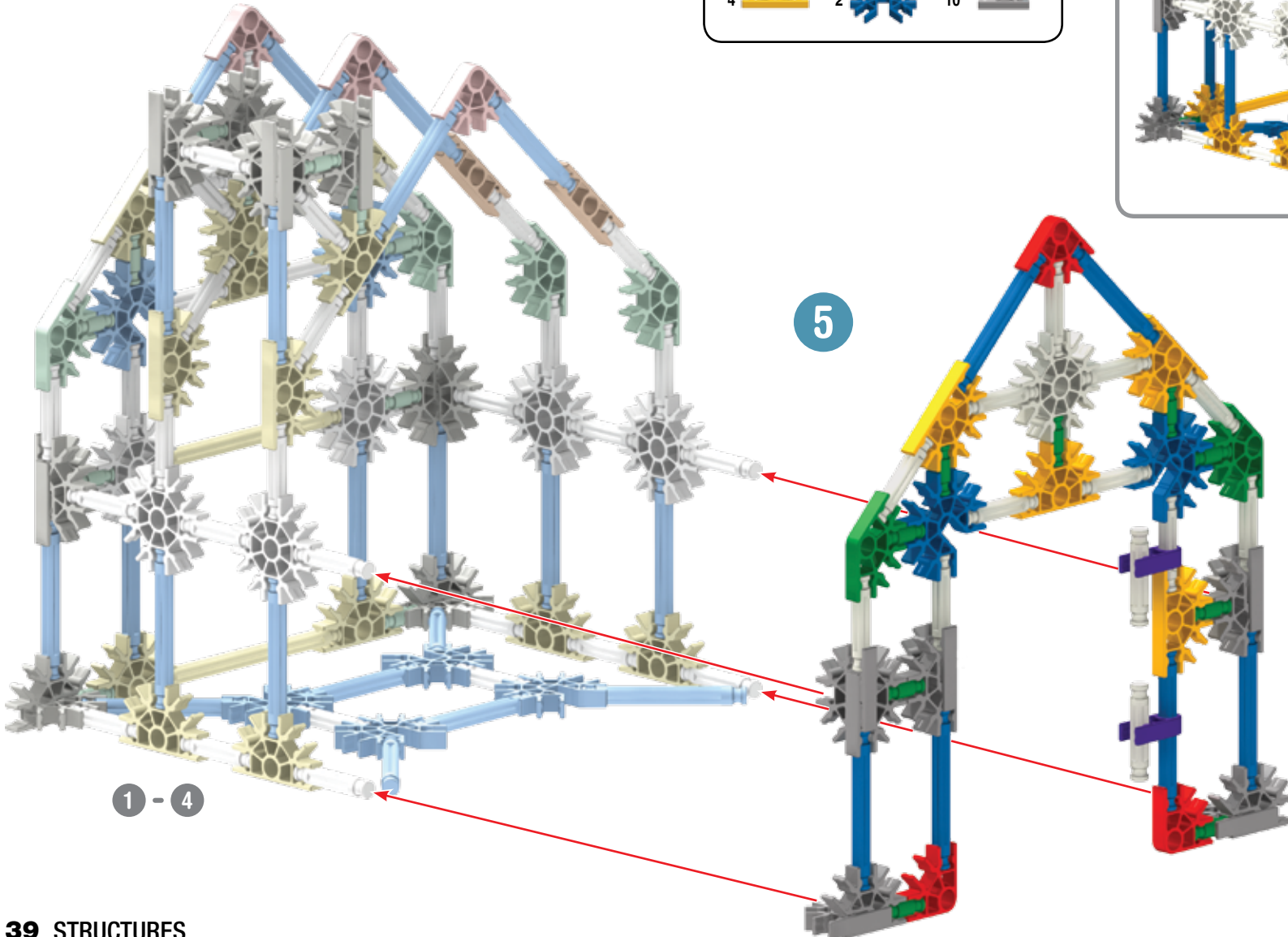
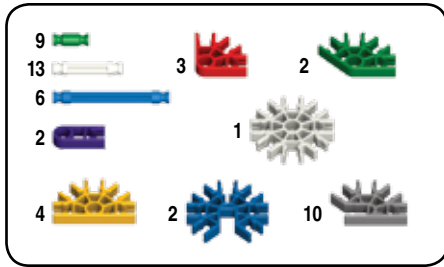

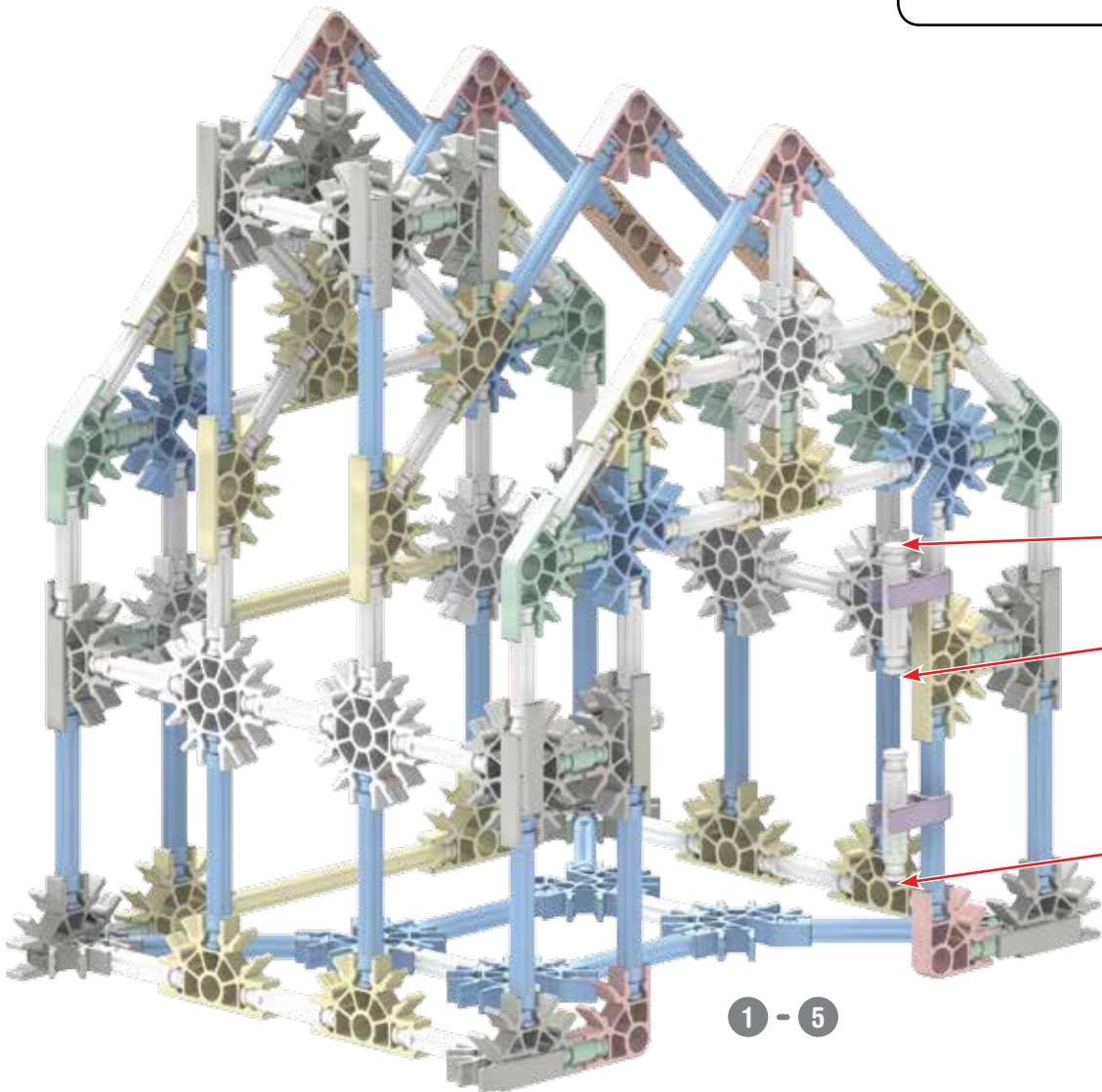

- | | | | |
|----|--|---|--|
| 10 | | 1 | |
| 4 | | | |
| 2 | | 6 | |
| | | 4 | |





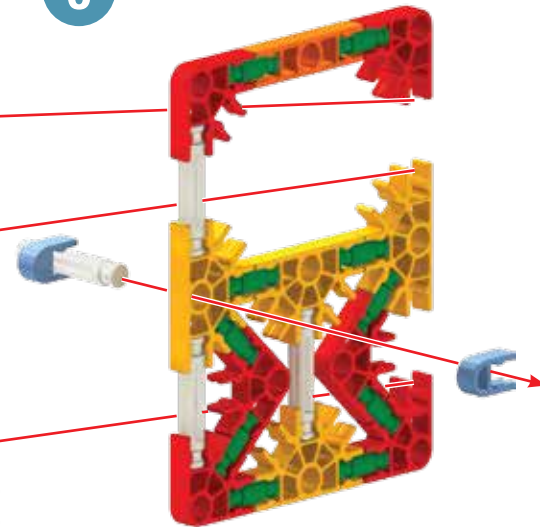

6

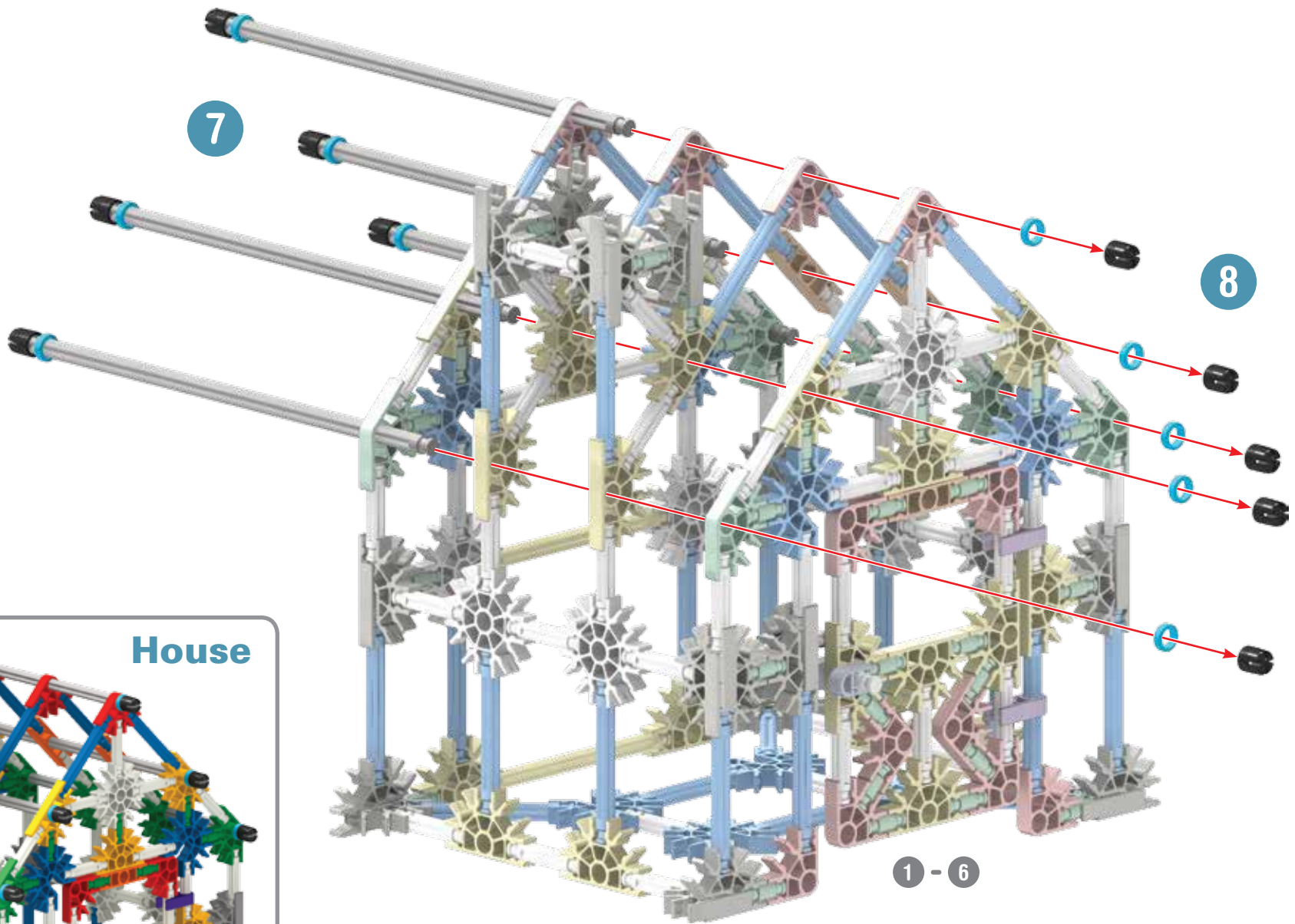

1 - 5



10		10	
5			

Igloo

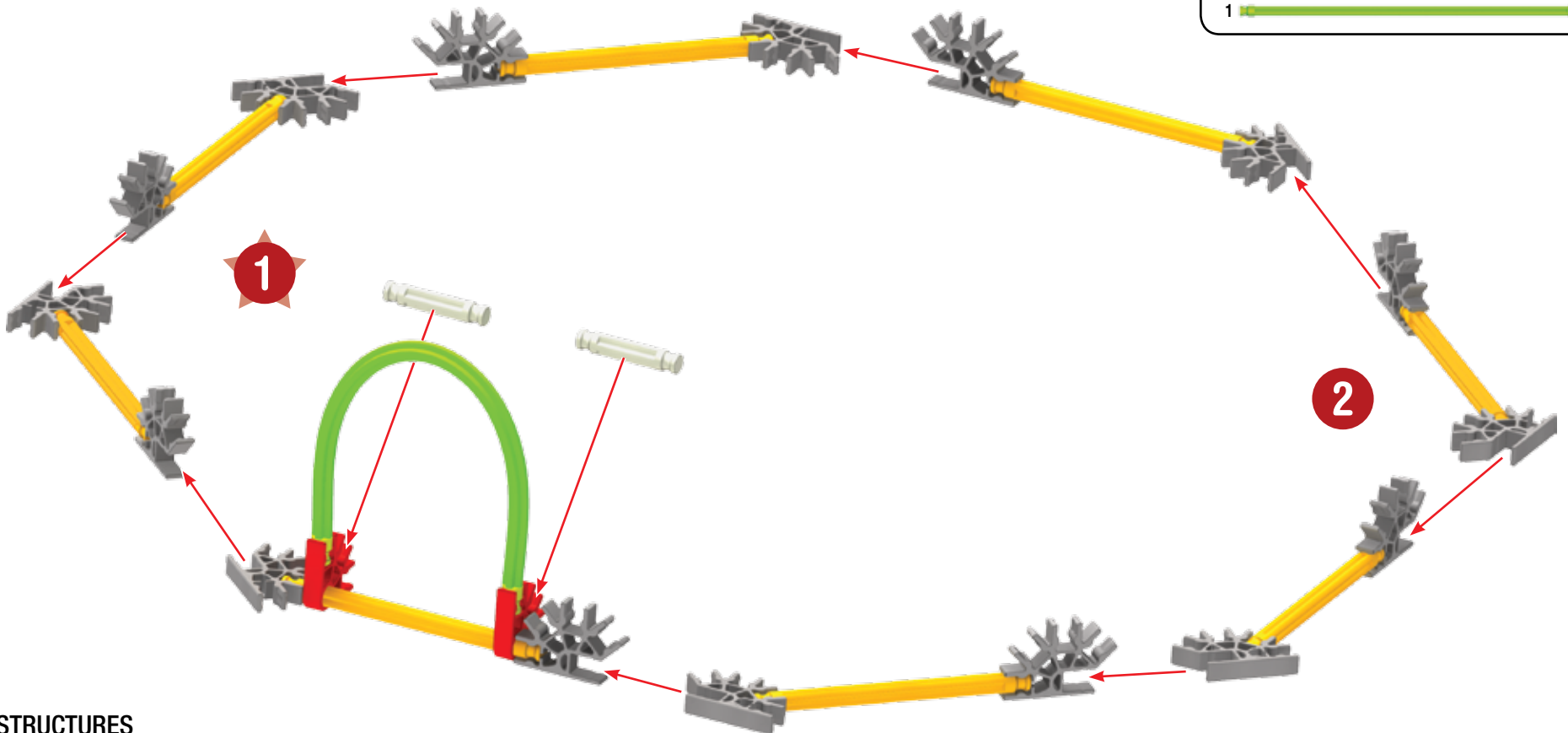
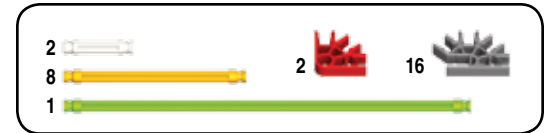
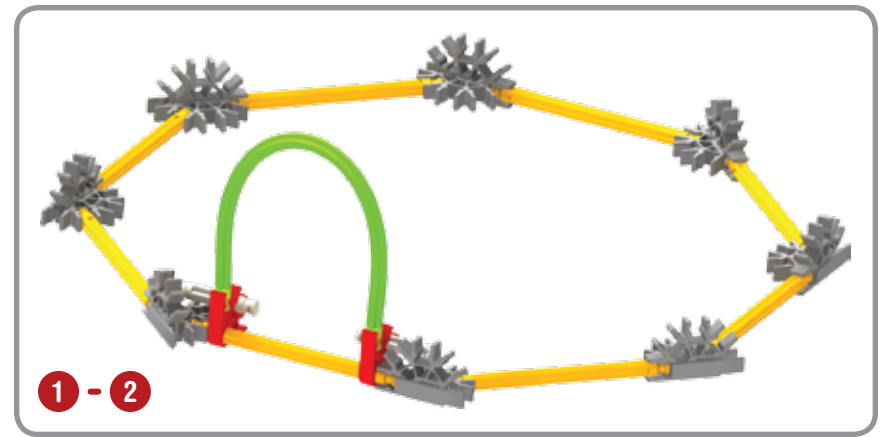
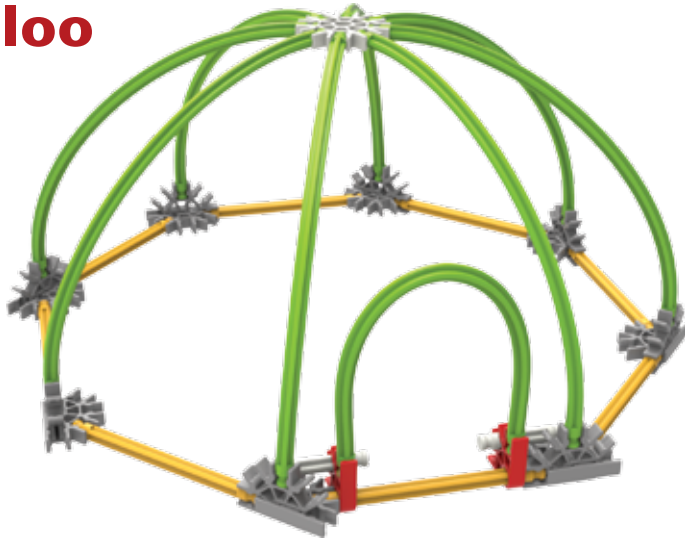

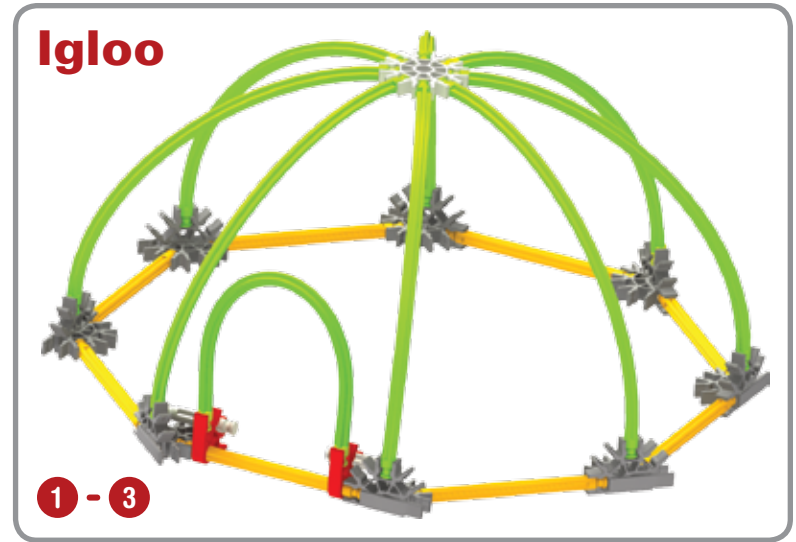
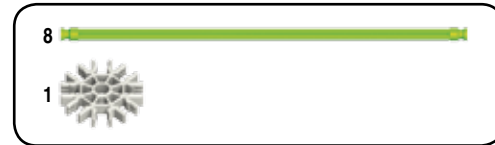
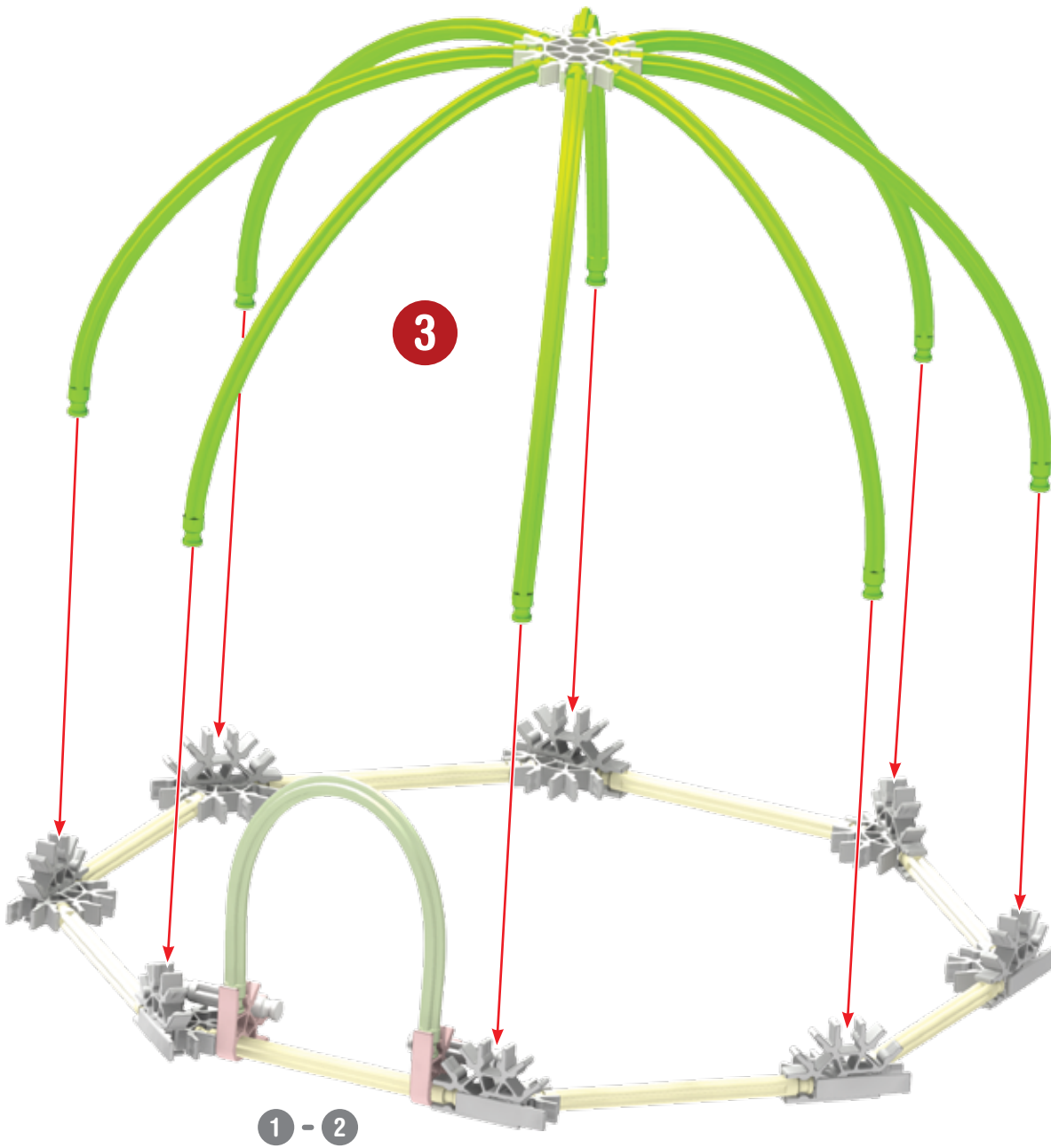

Leaning Tower

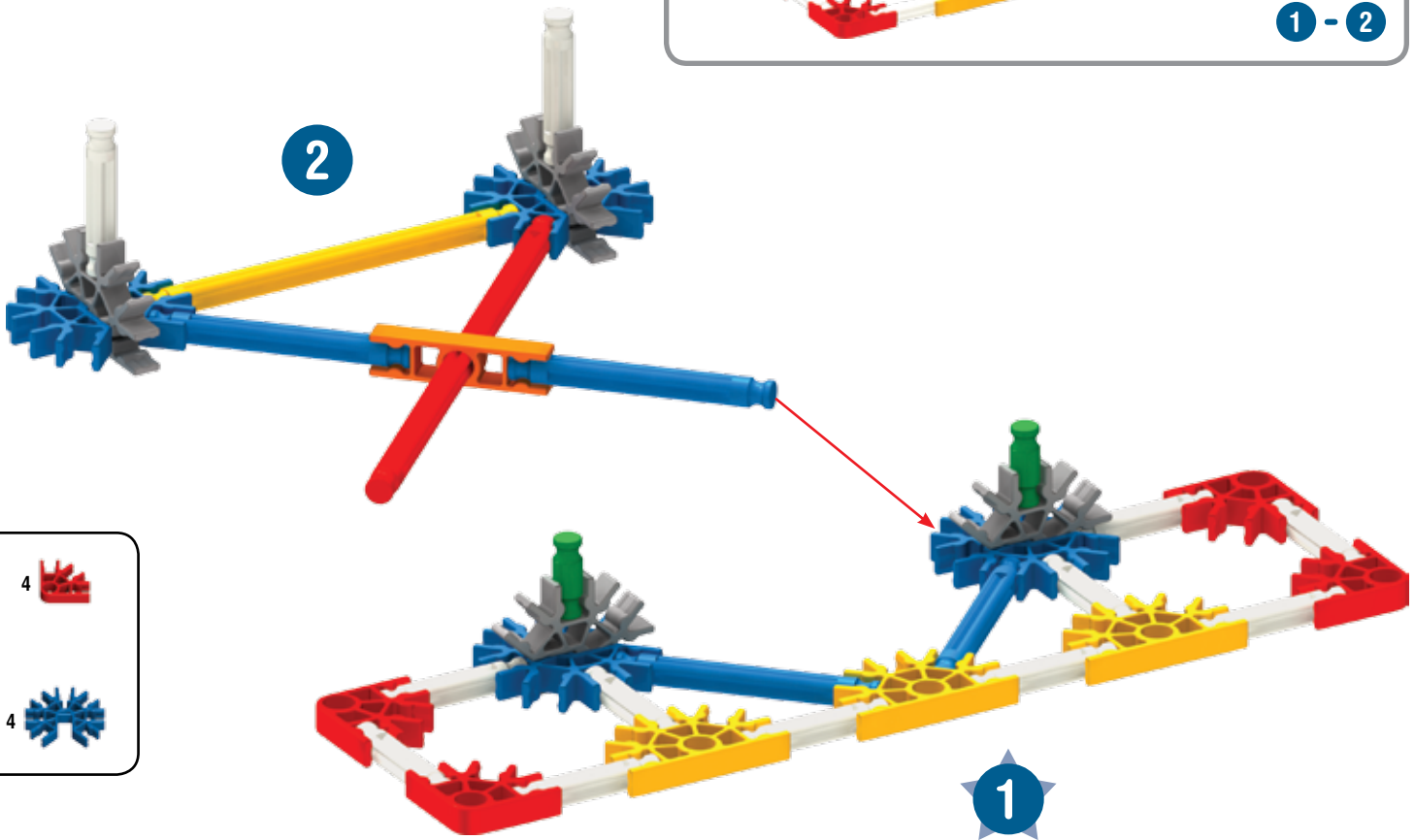
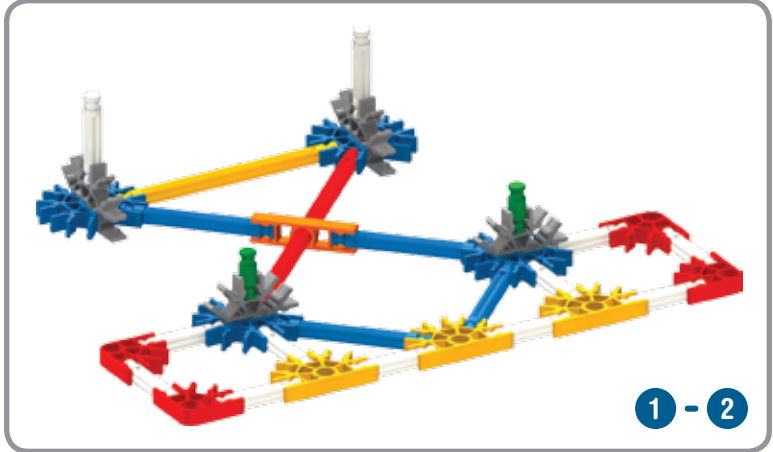
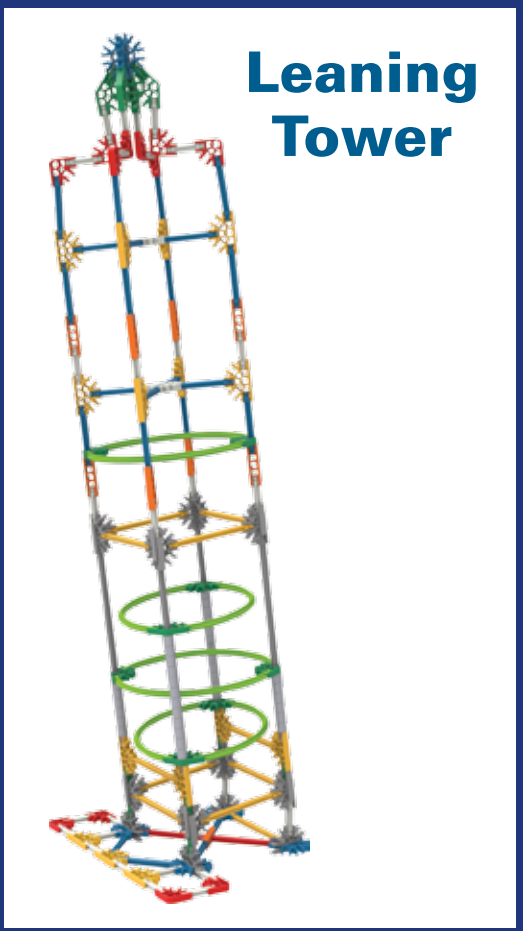

- | | | | | | |
|----|--|---|--|---|--|
| 2 | | 1 | | 4 | |
| 12 | | | | | |
| 4 | | | | | |
| 1 | | | | | |
| 1 | | | | | |
| 3 | | 4 | | 4 | |

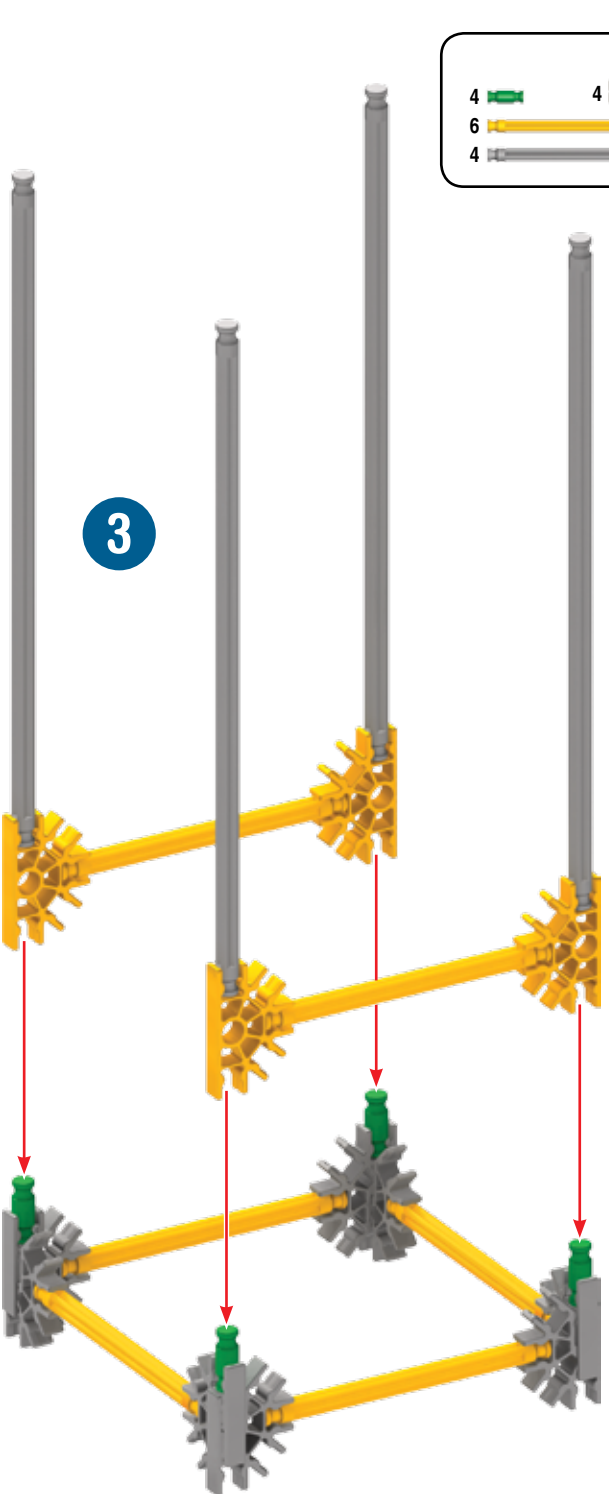

3

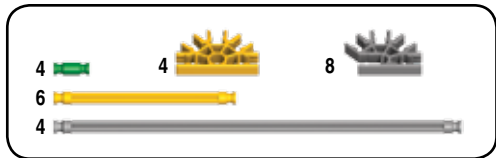

x3

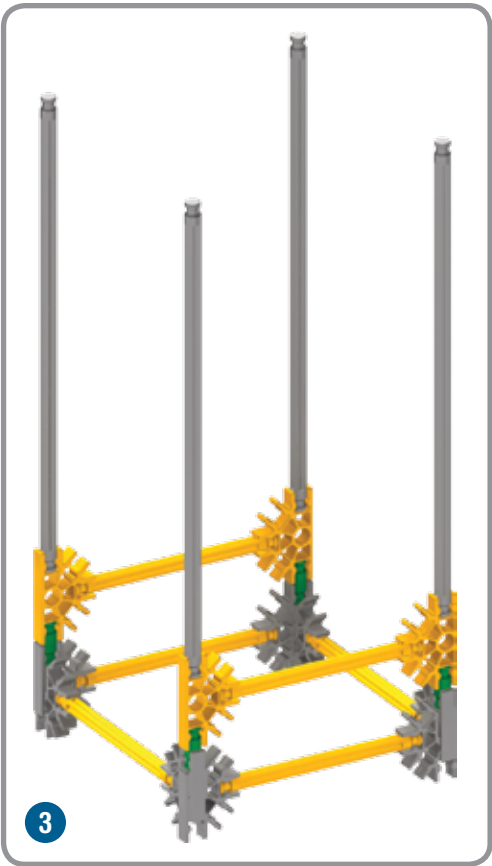

3

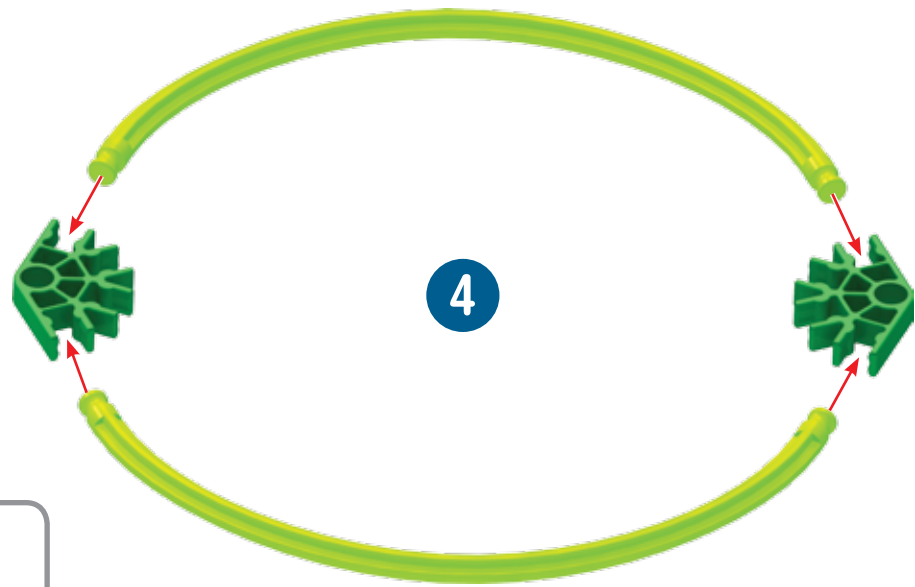

4

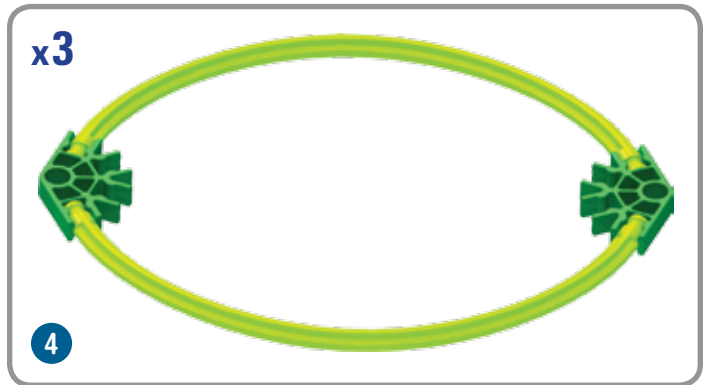

x3

4

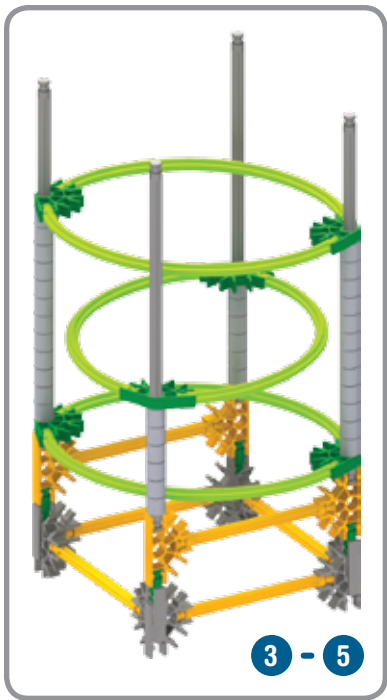

36 

5

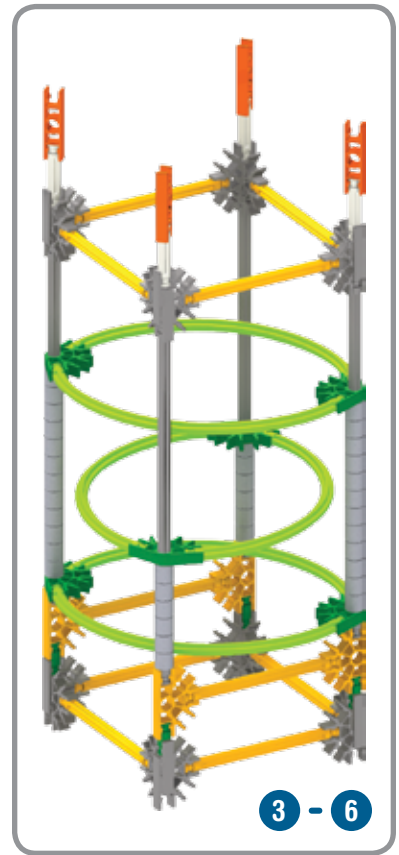
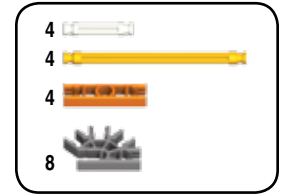
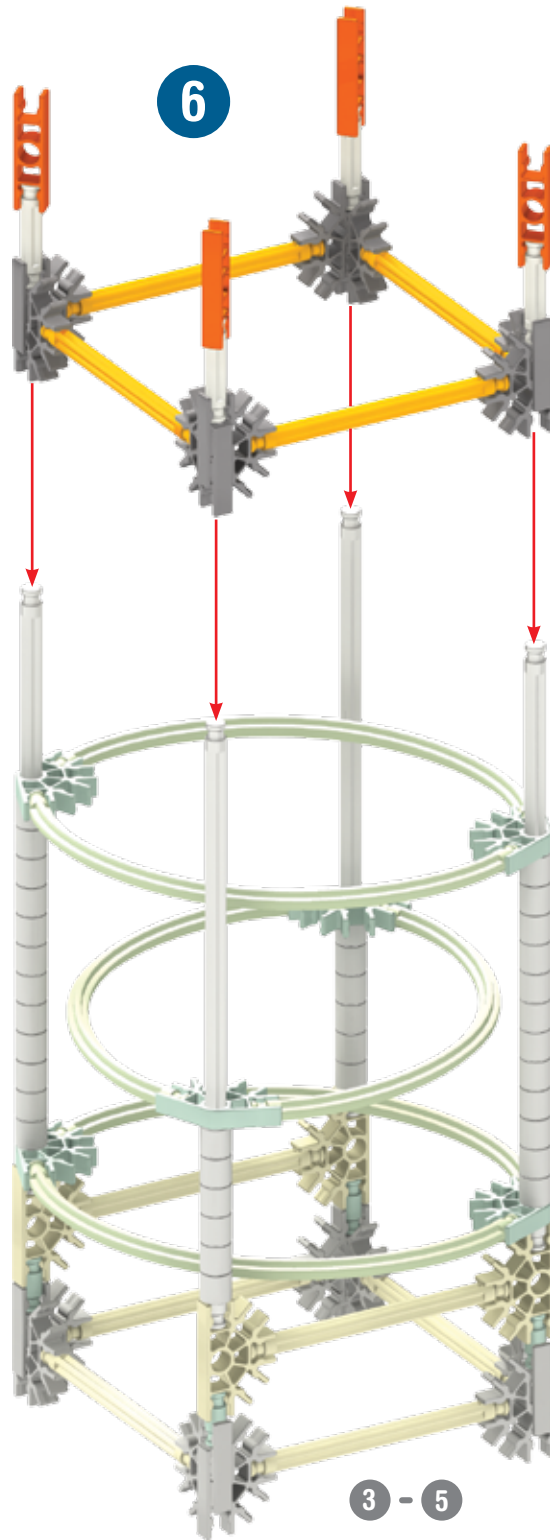
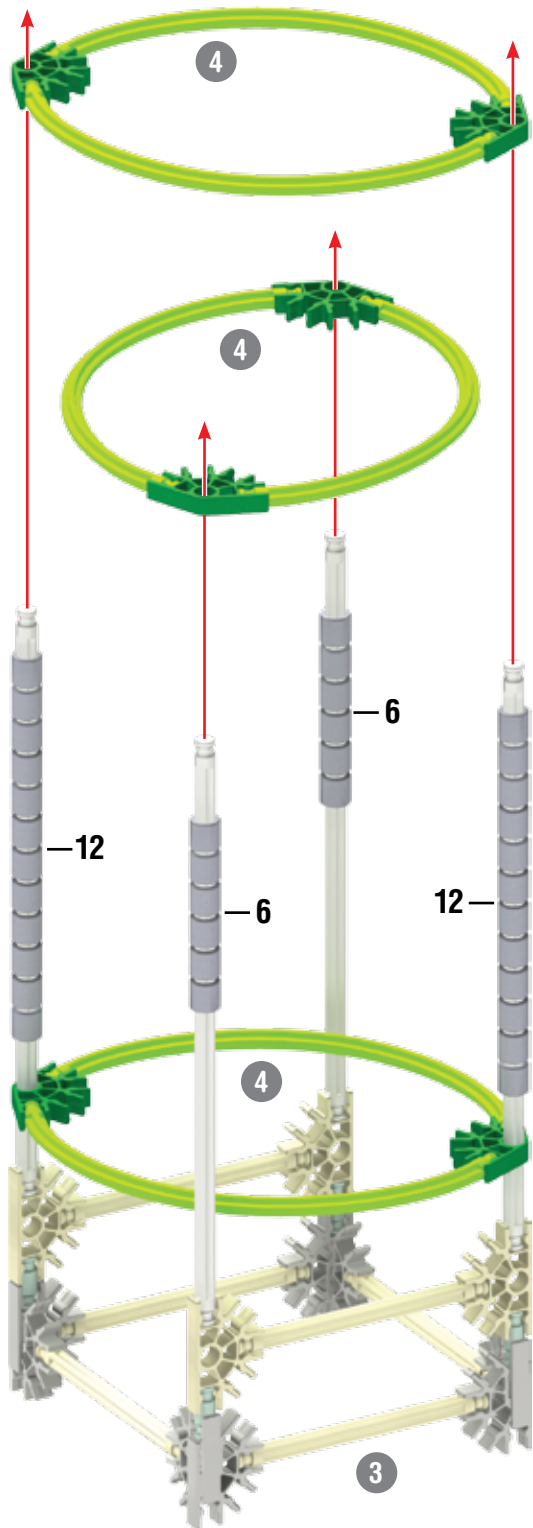

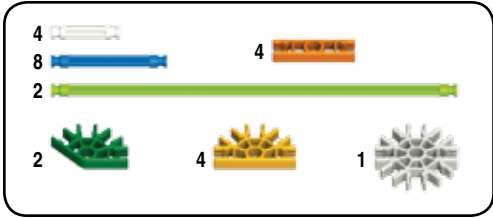

7

3 - 6

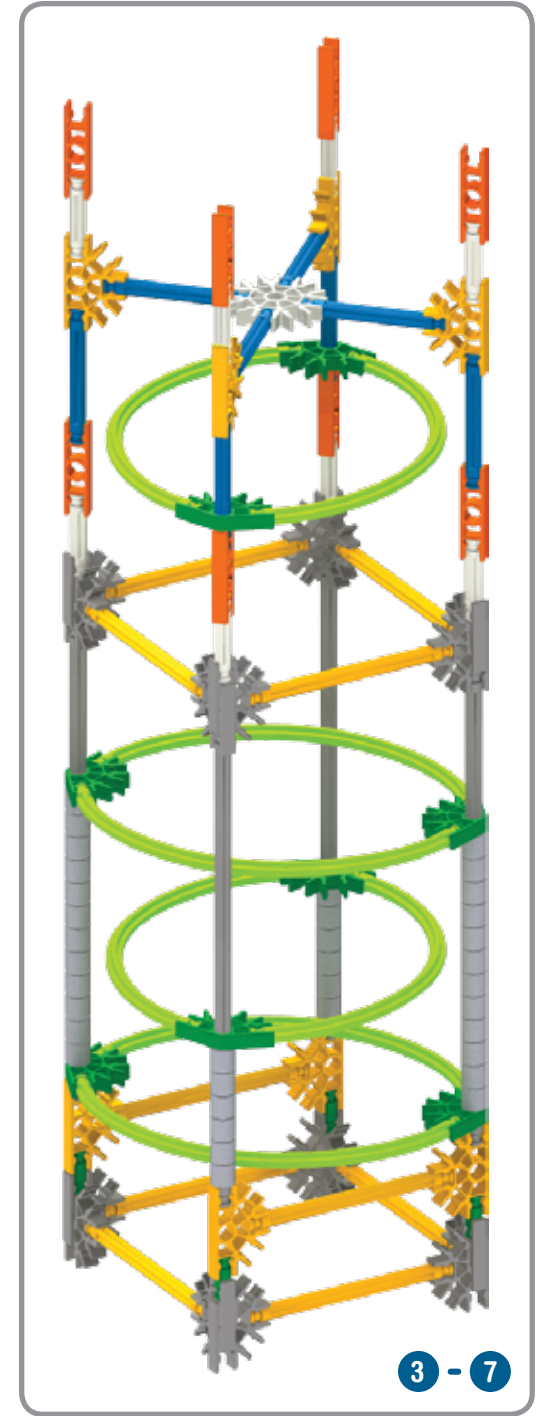
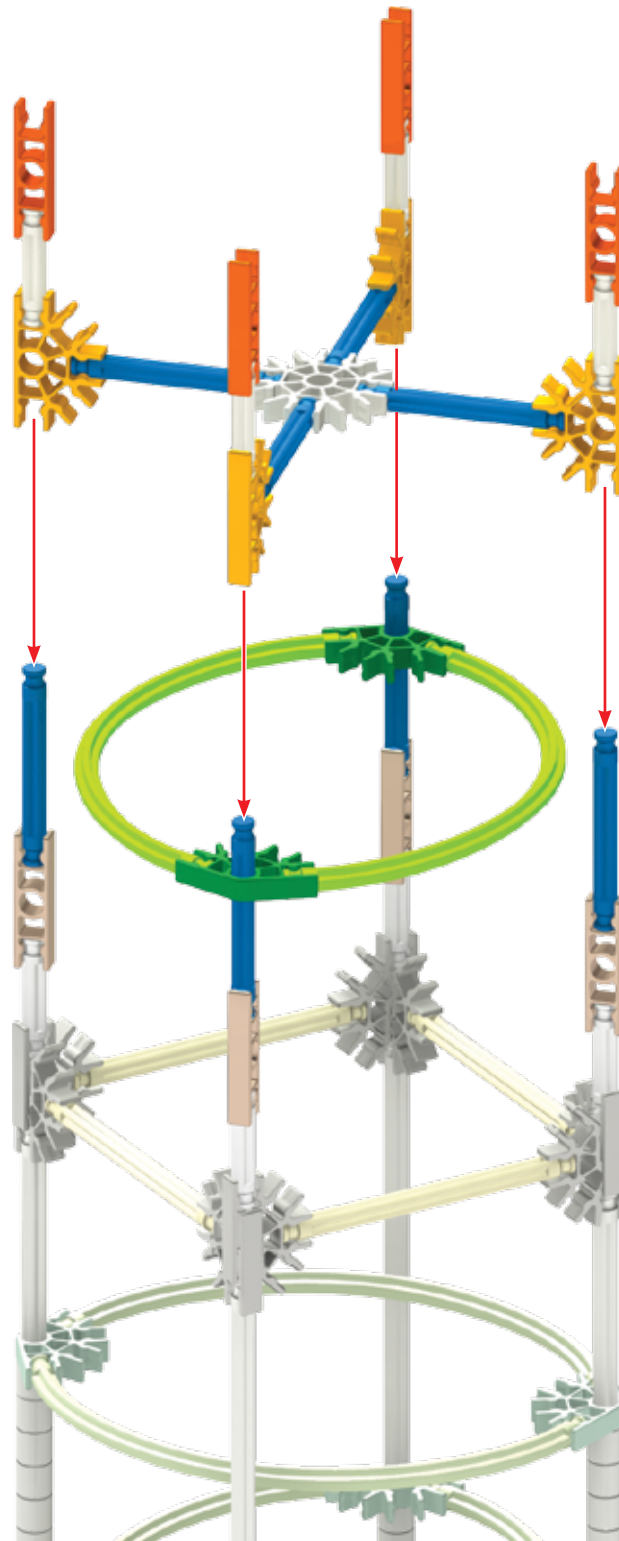

3 - 7

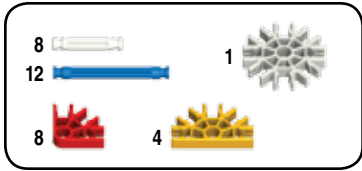

8

3 - 7

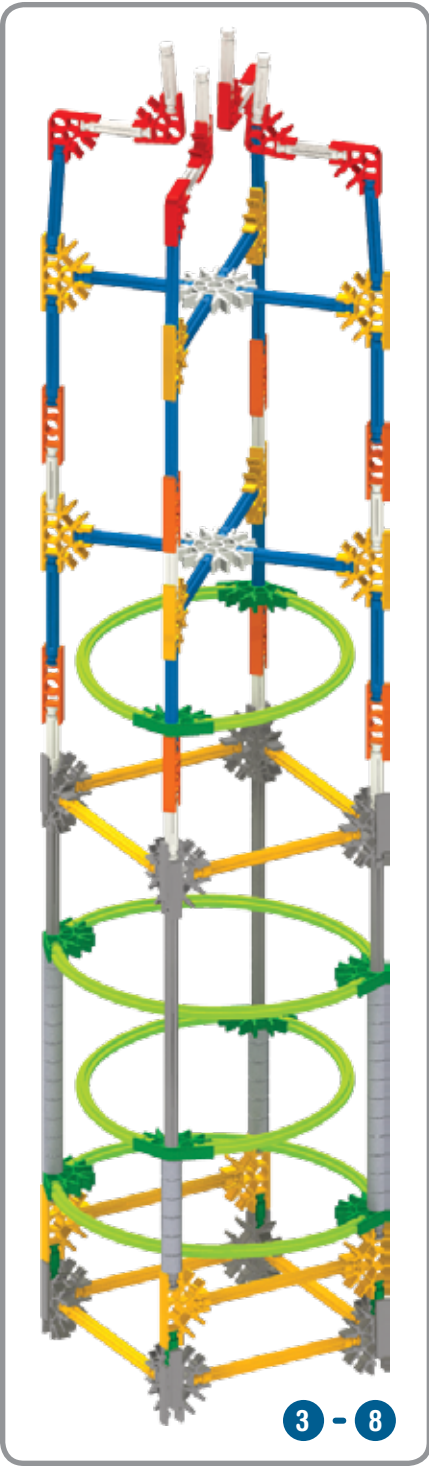
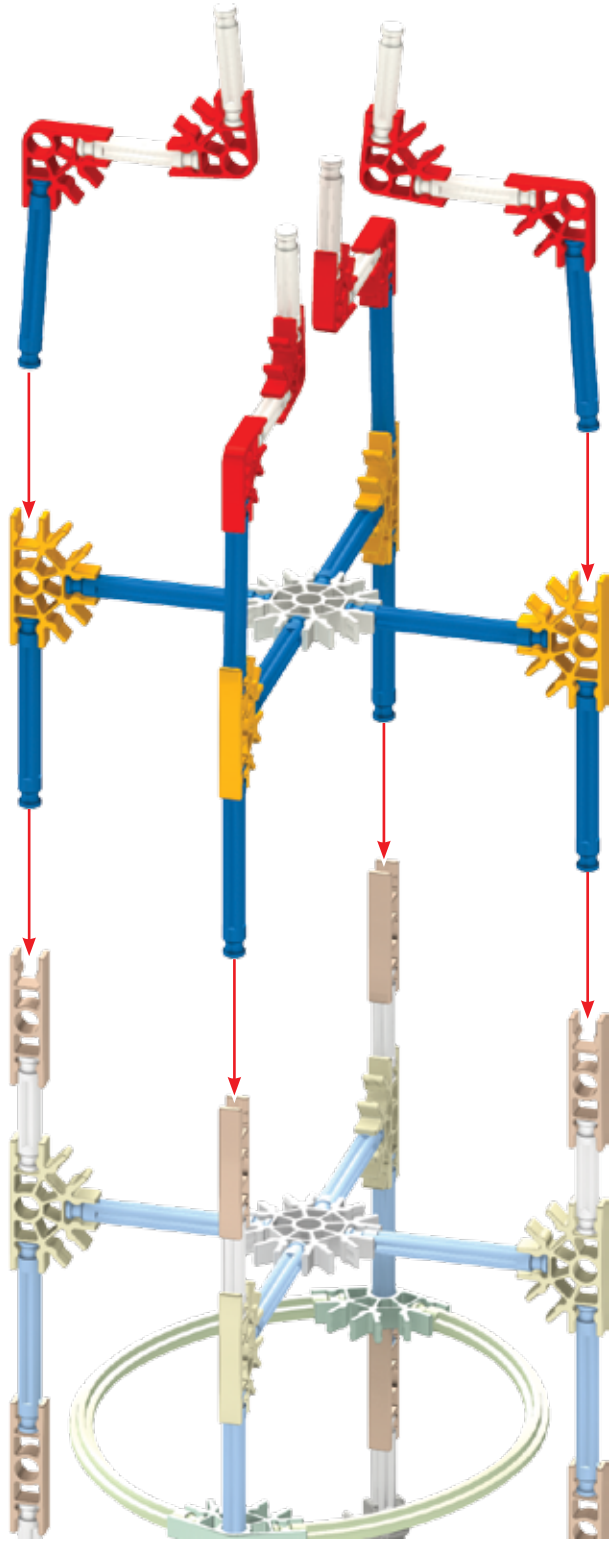

3 - 8

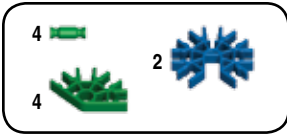

9

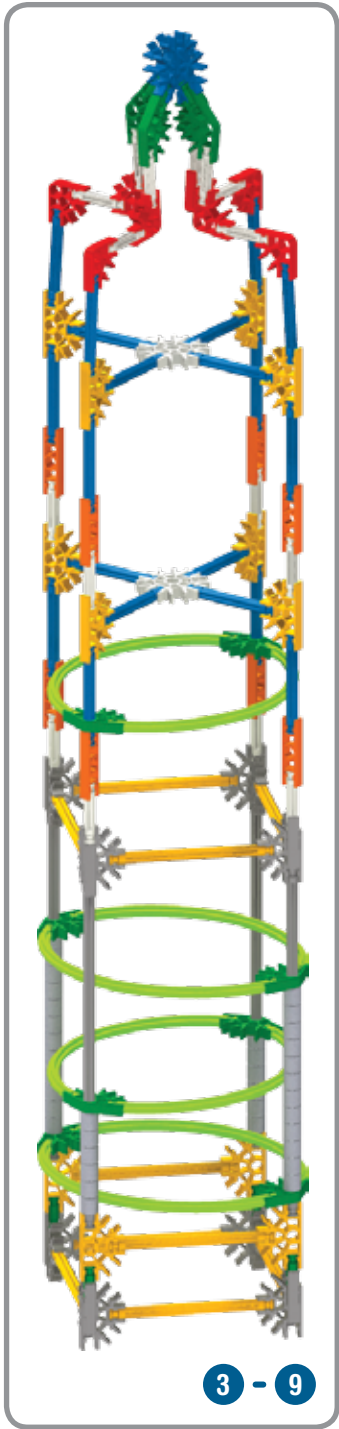
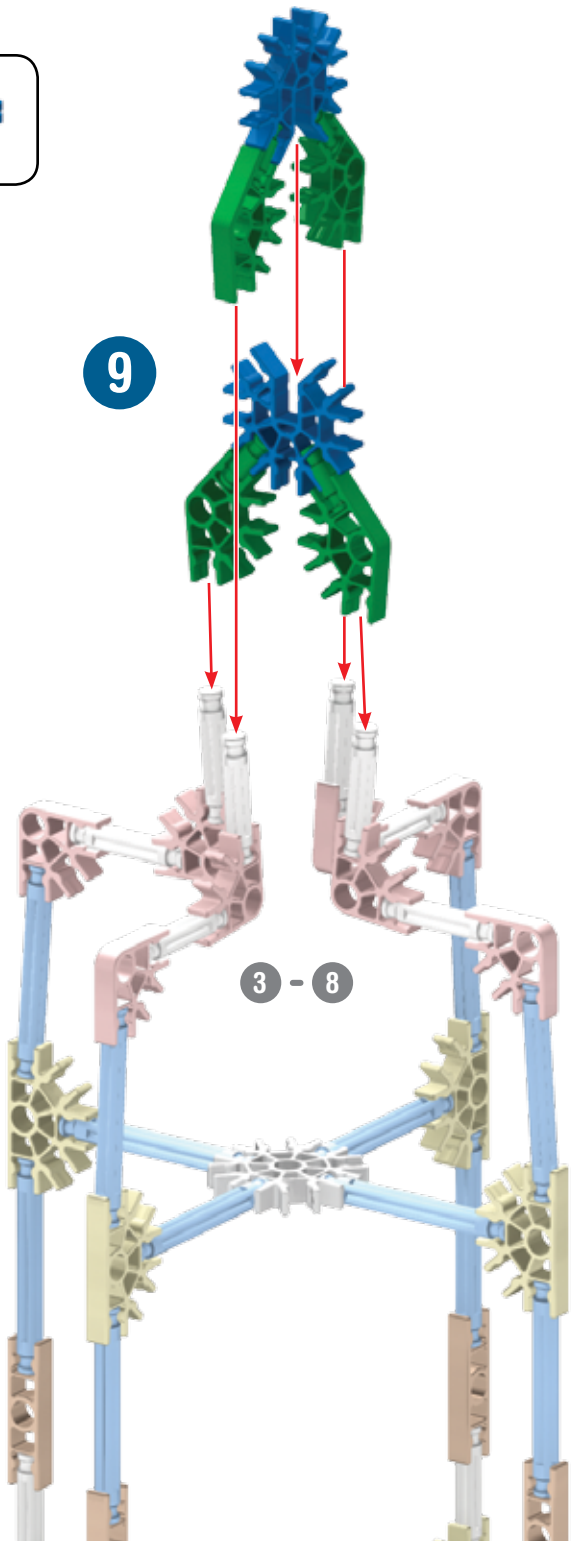

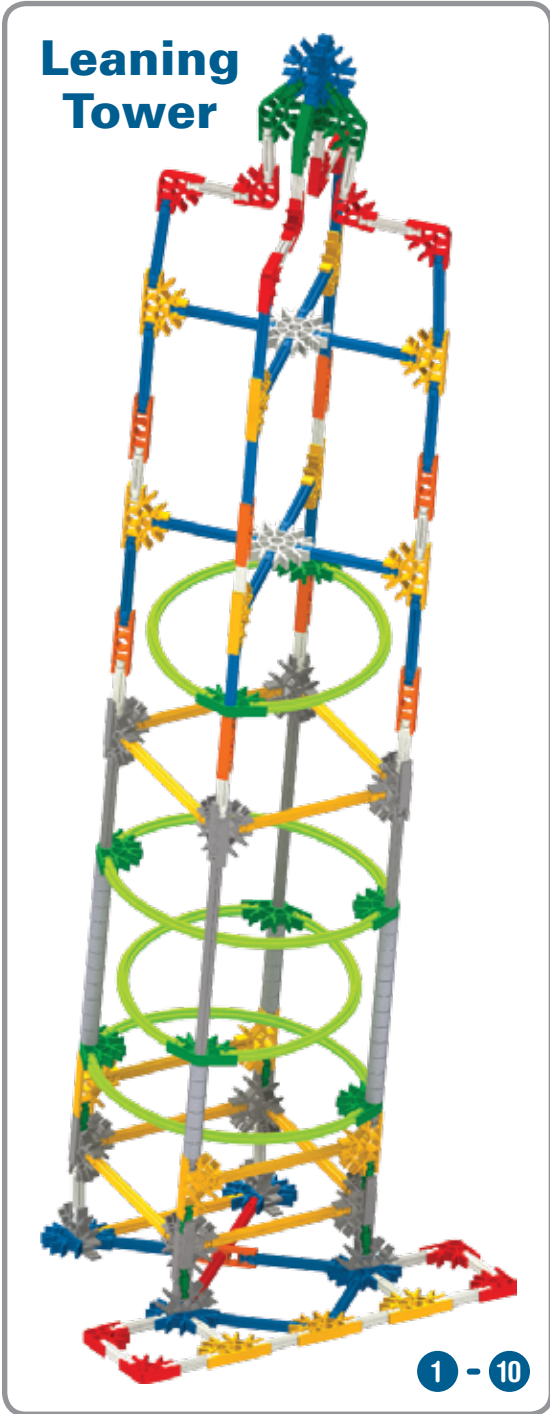
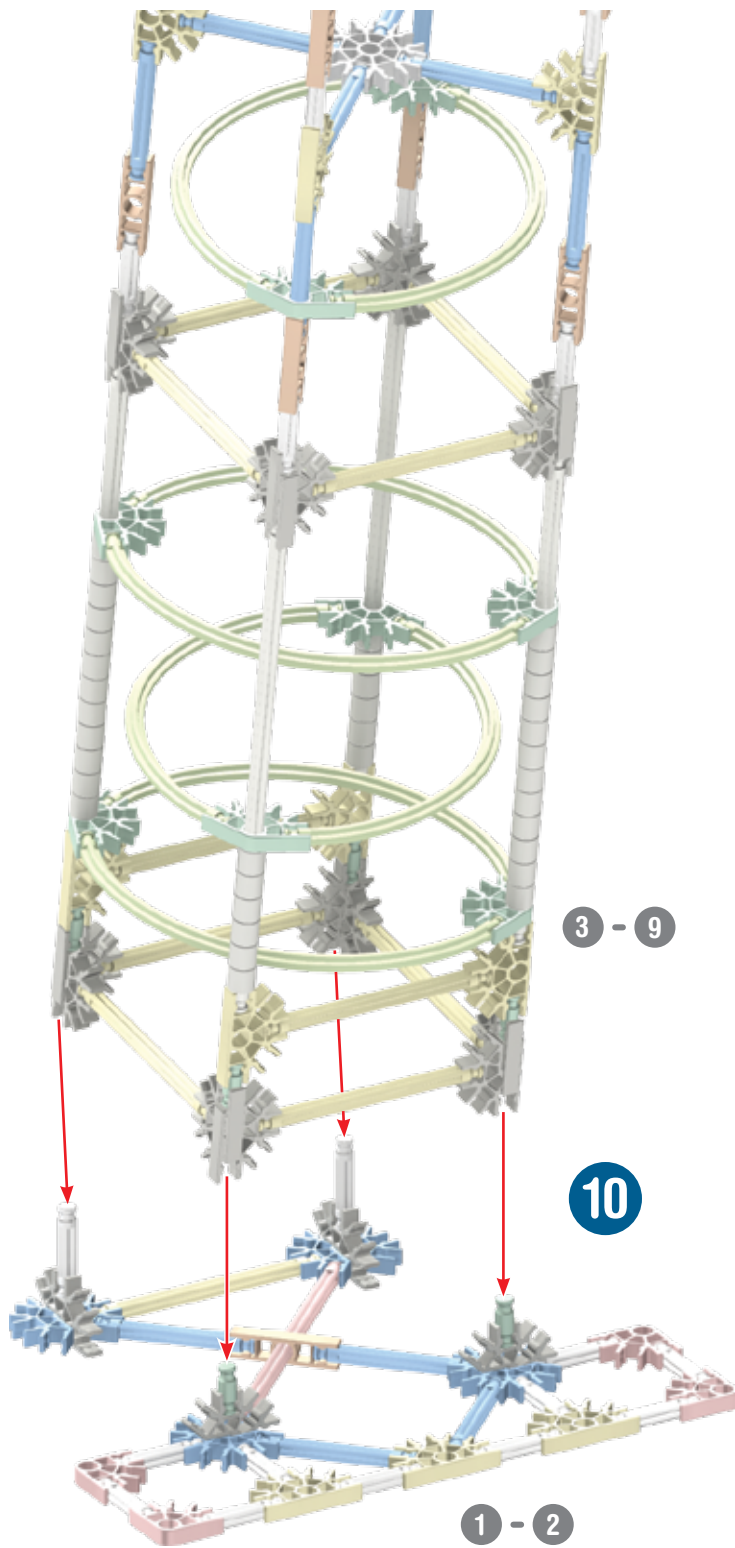

Mayan Pyramid

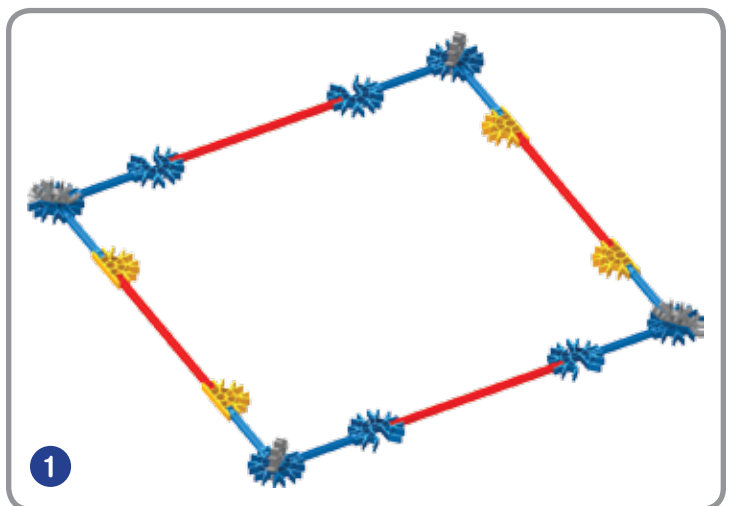
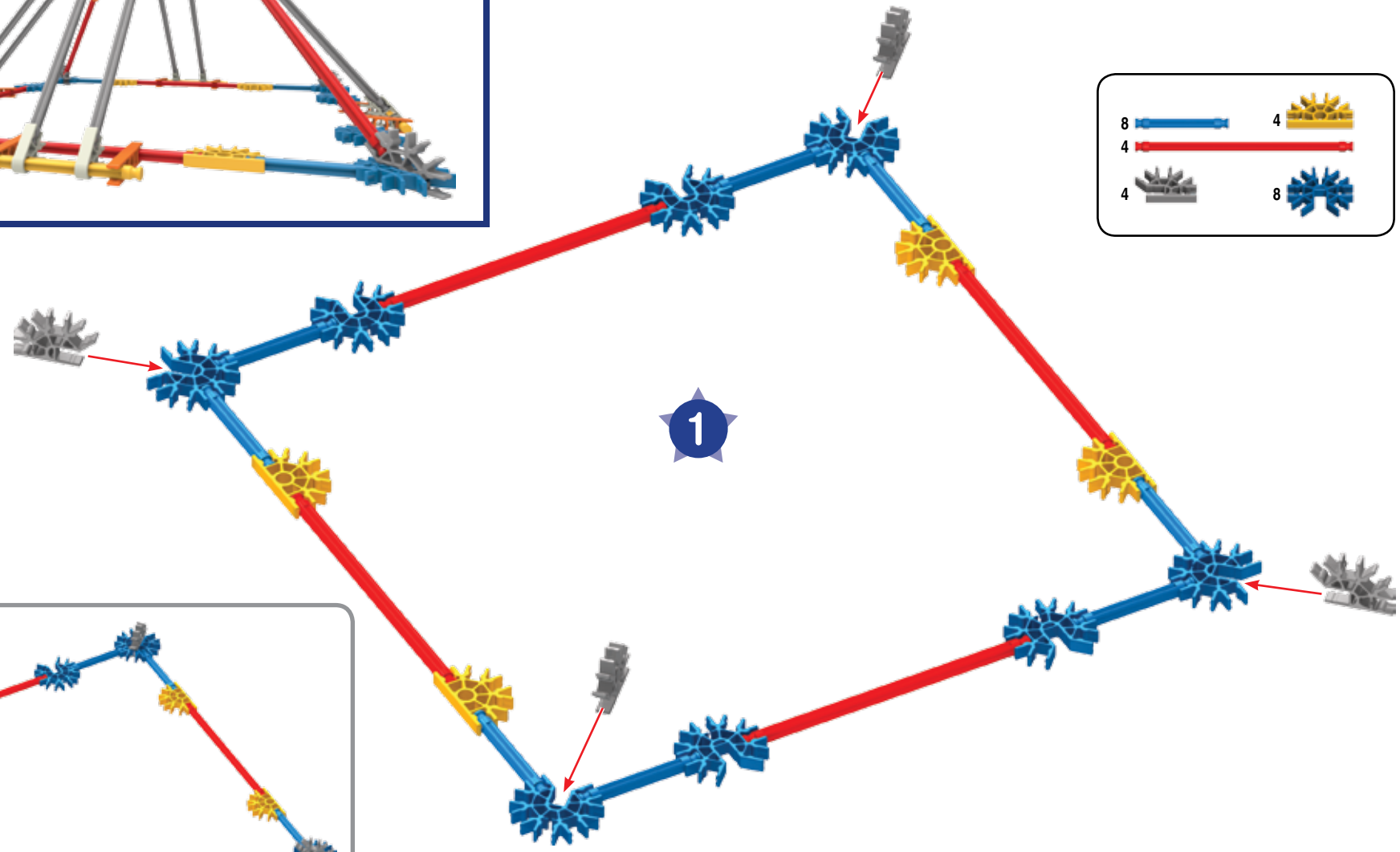
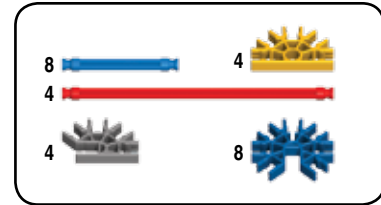

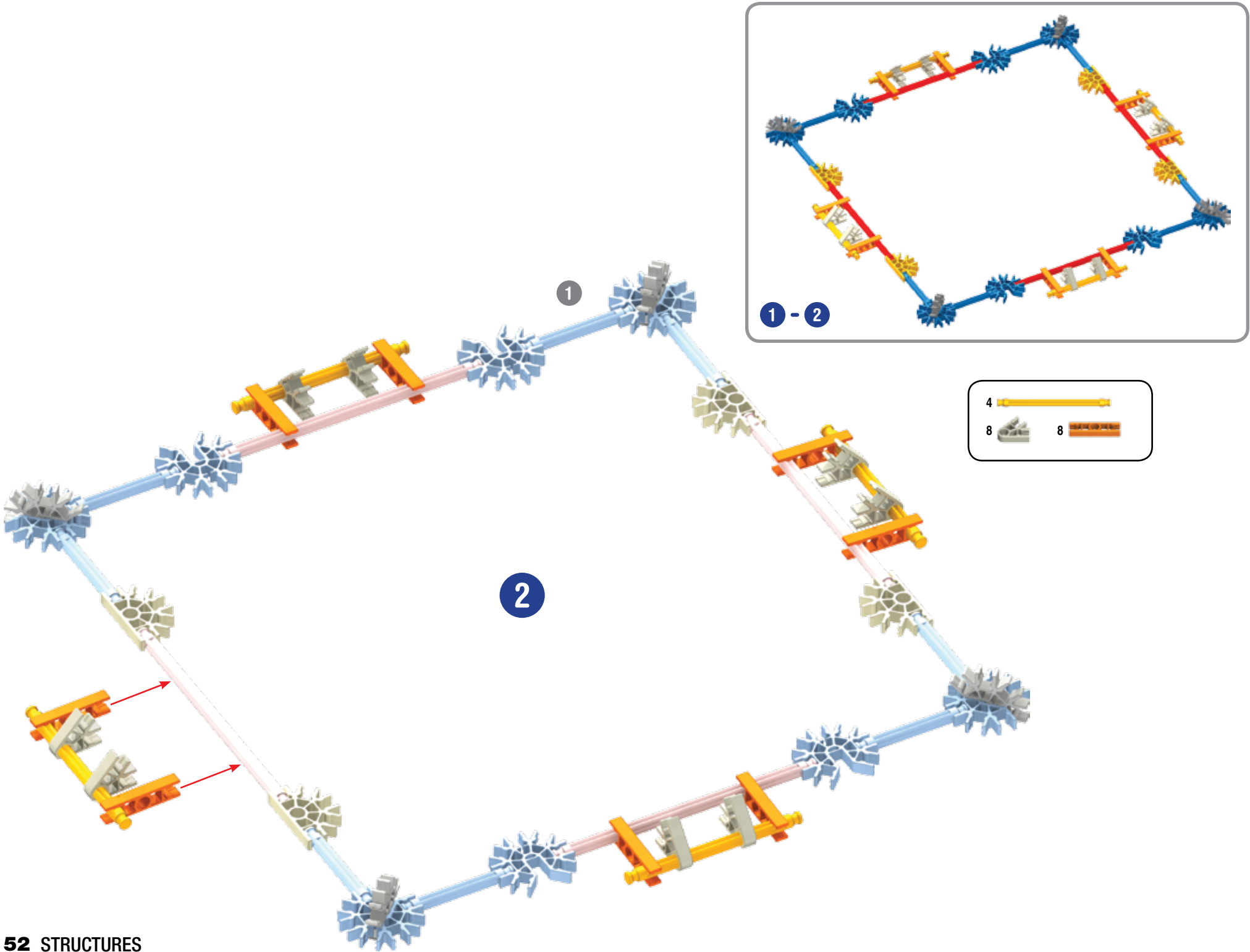

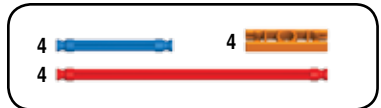
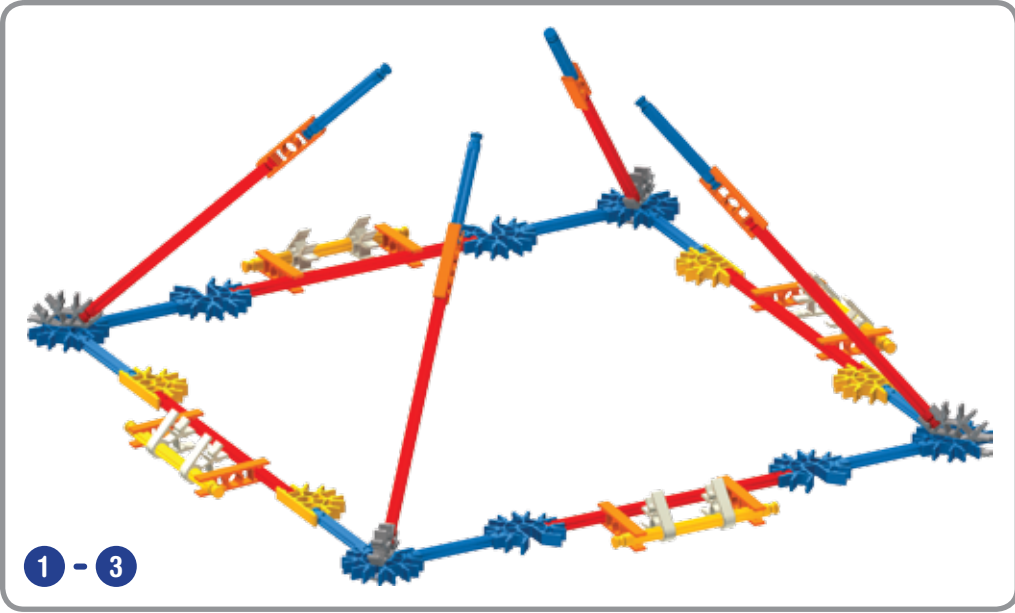
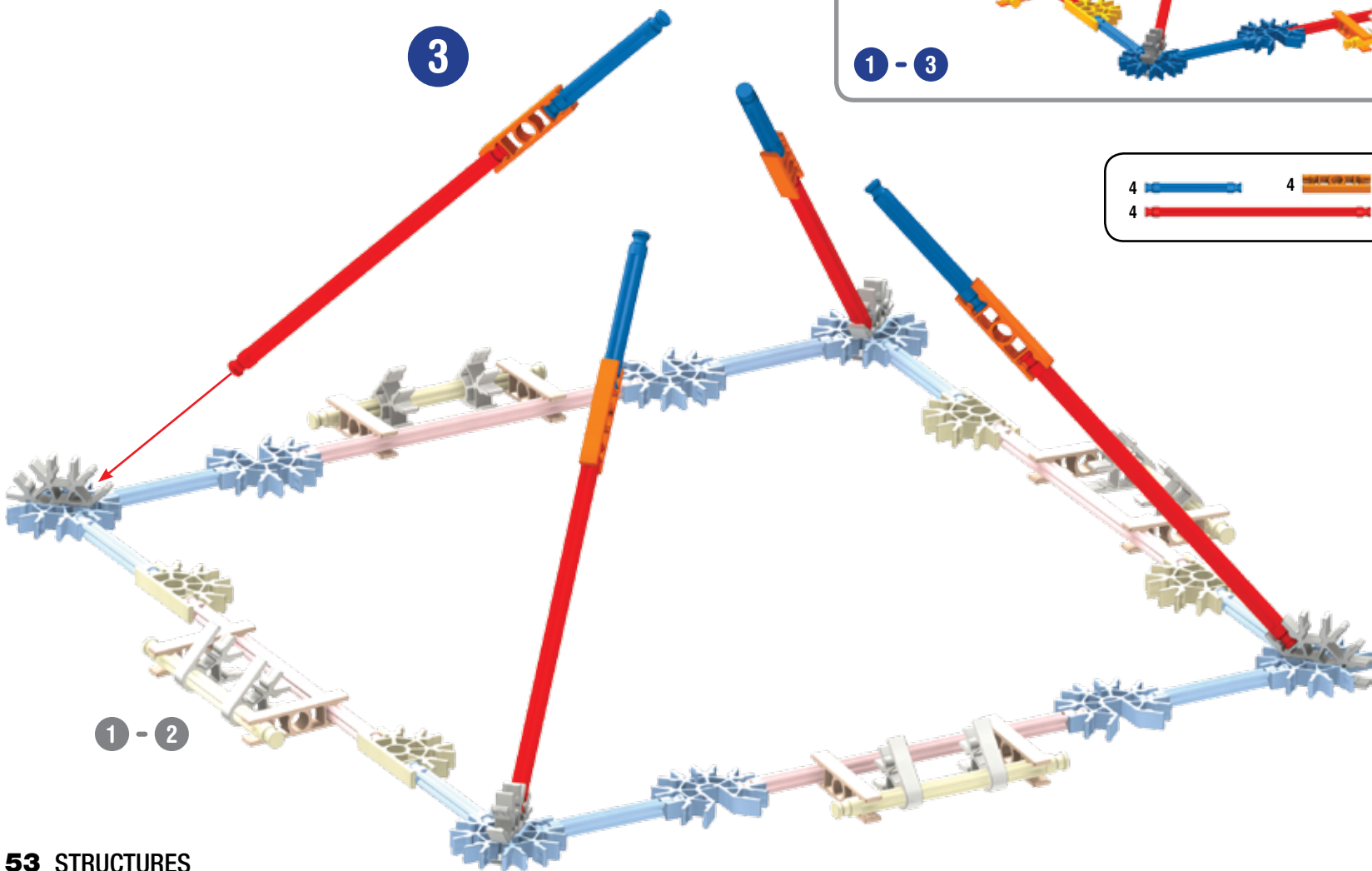

x4

4

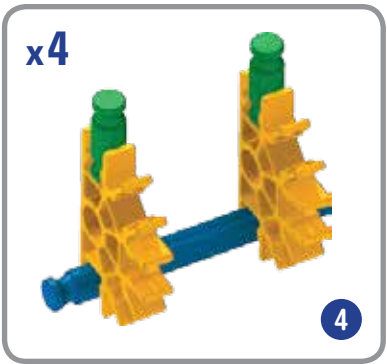
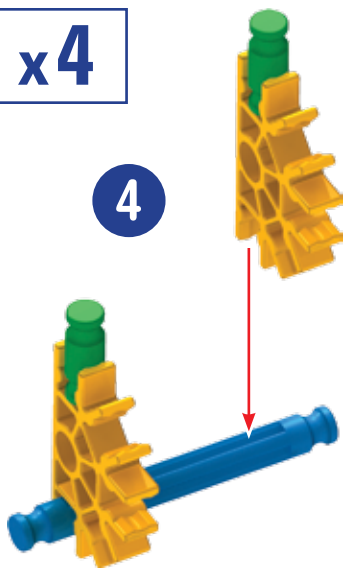

x4

4

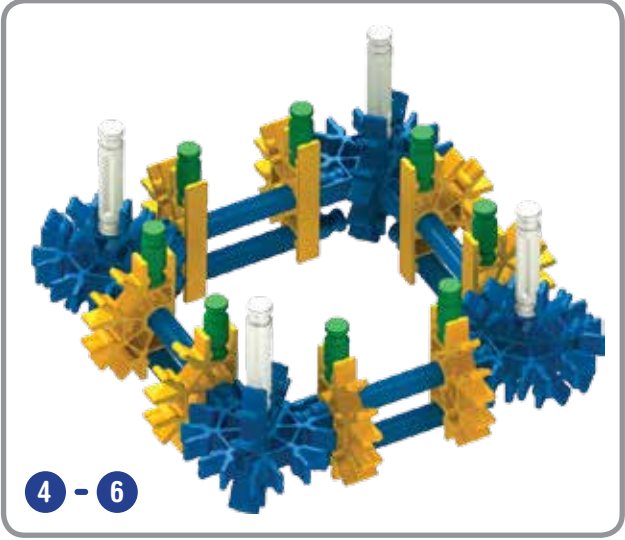

4 - 6

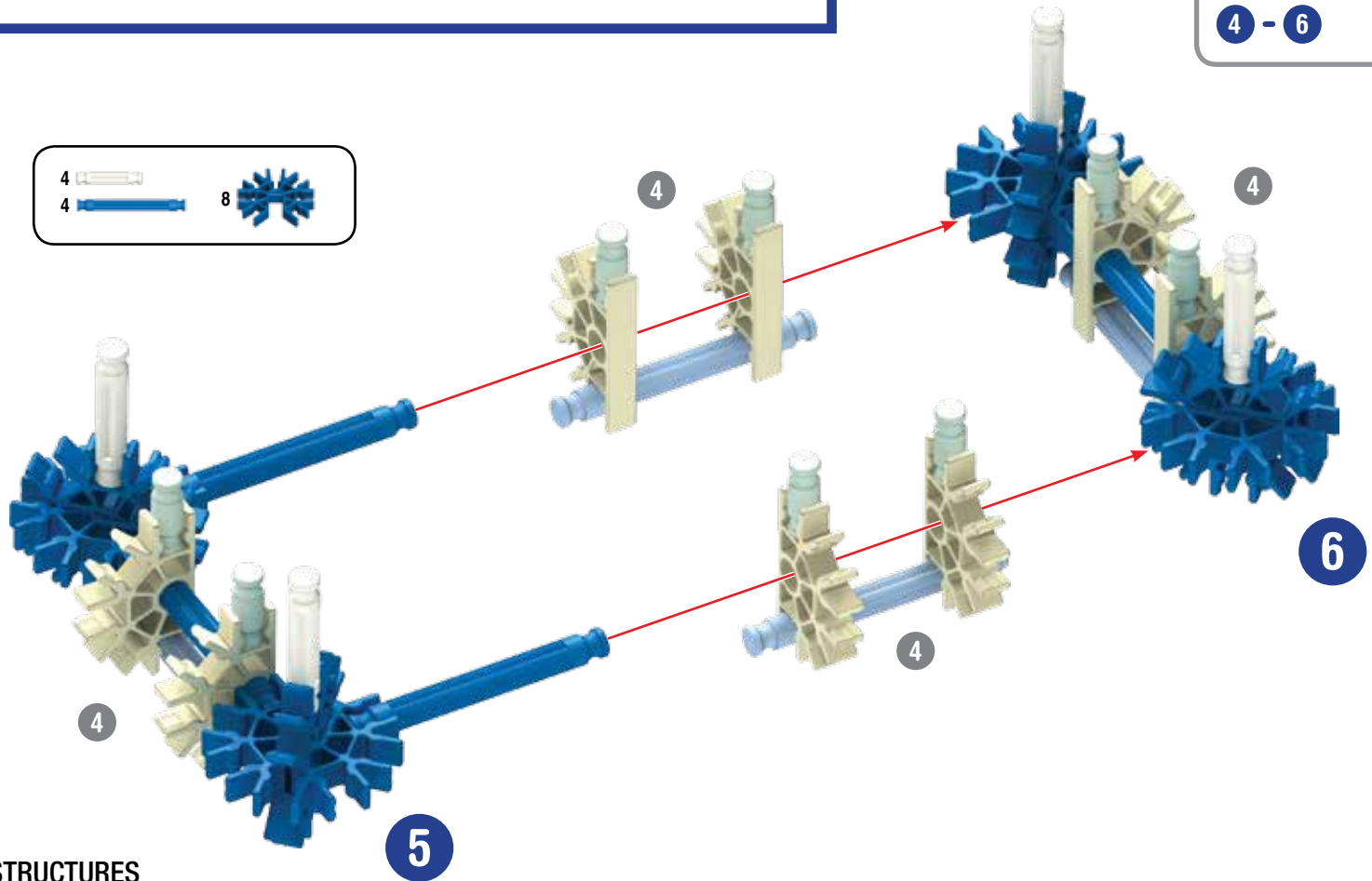
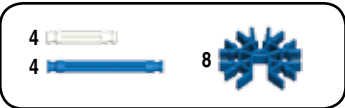

4

4

4

6

4

5

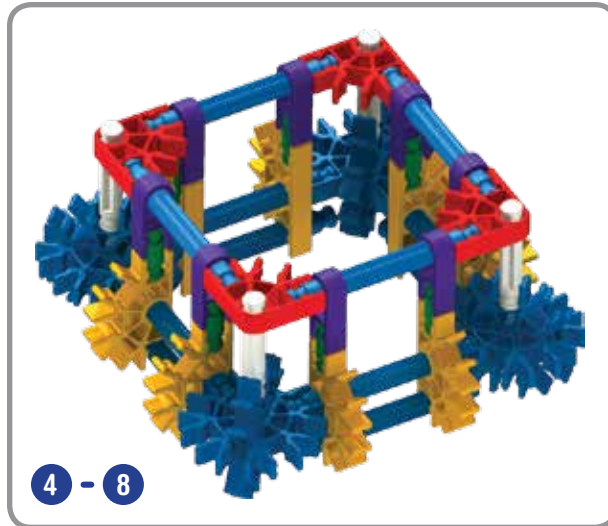
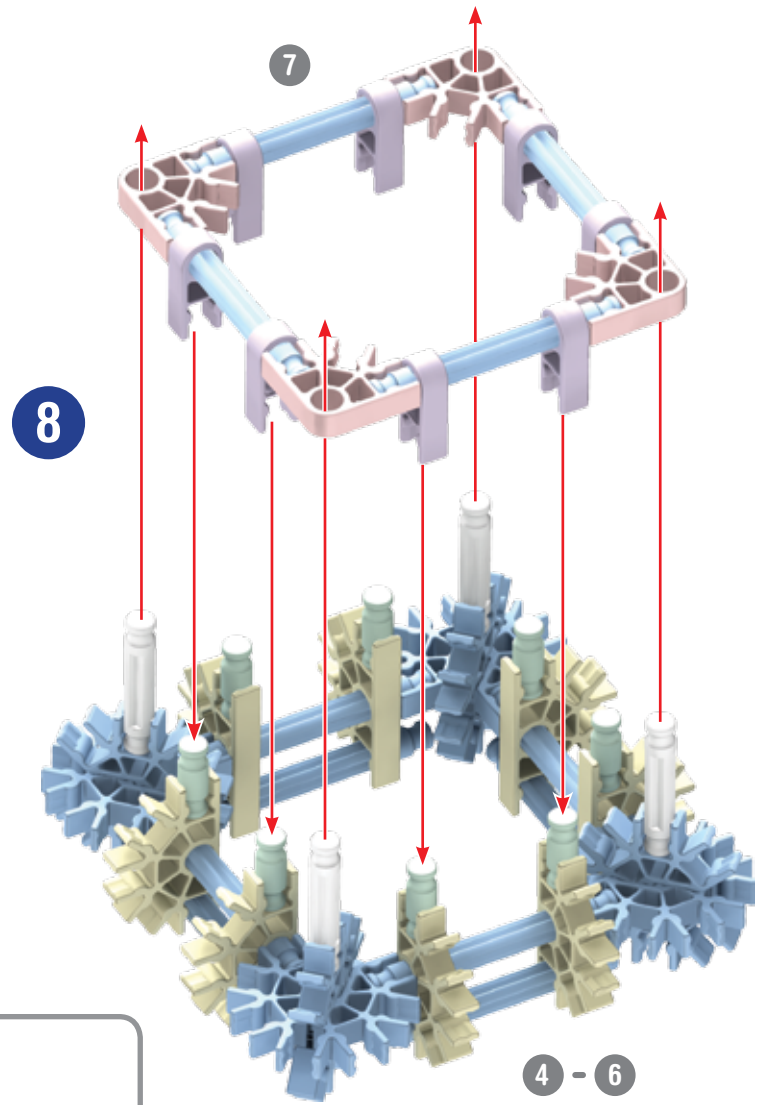
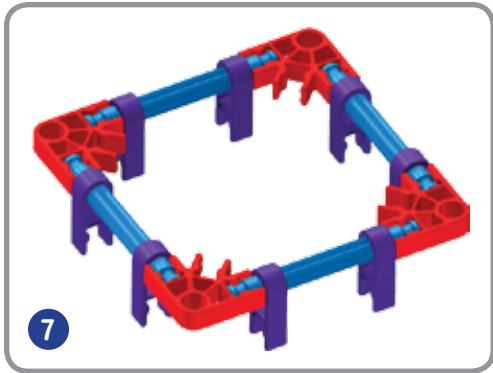
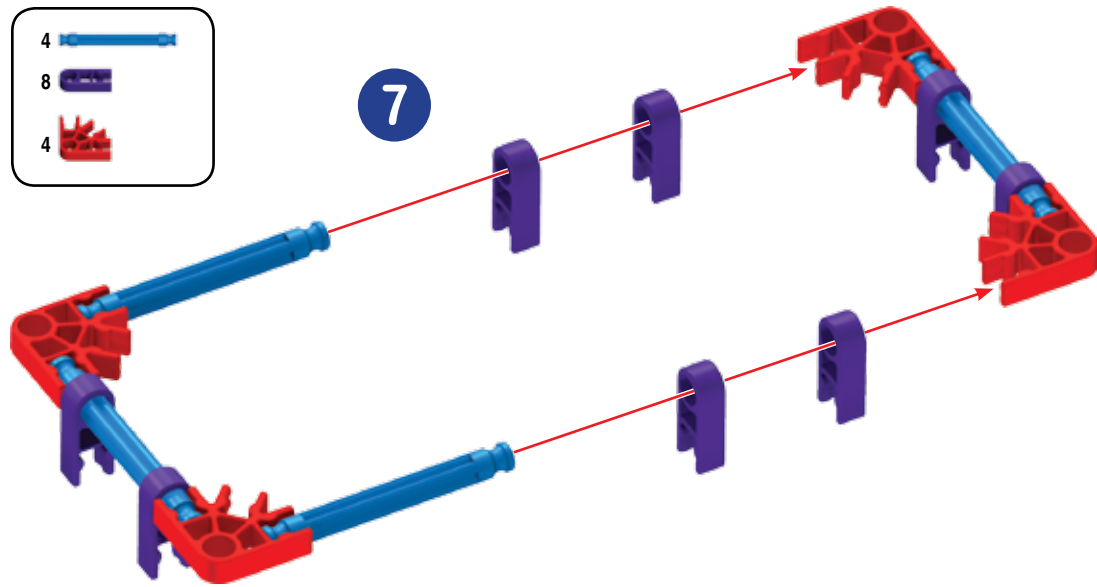
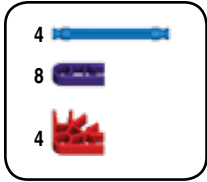

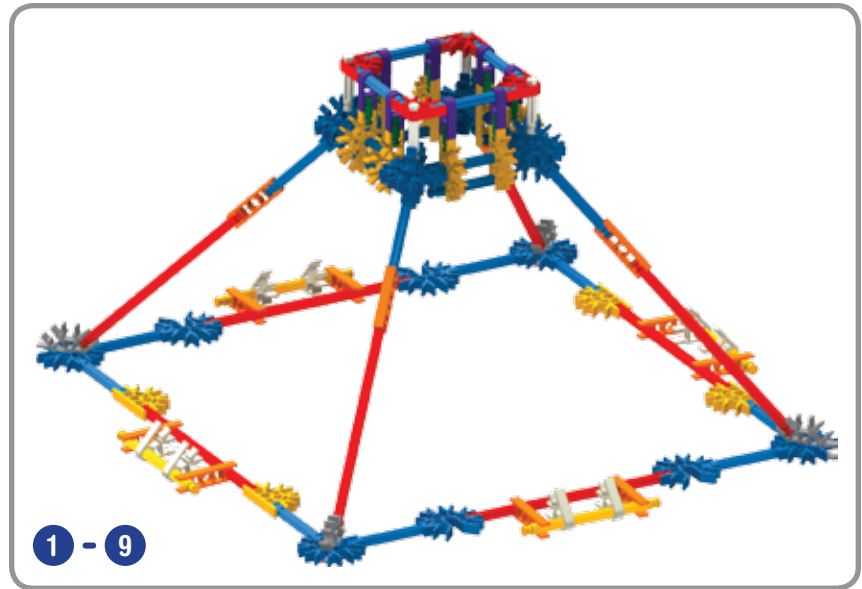
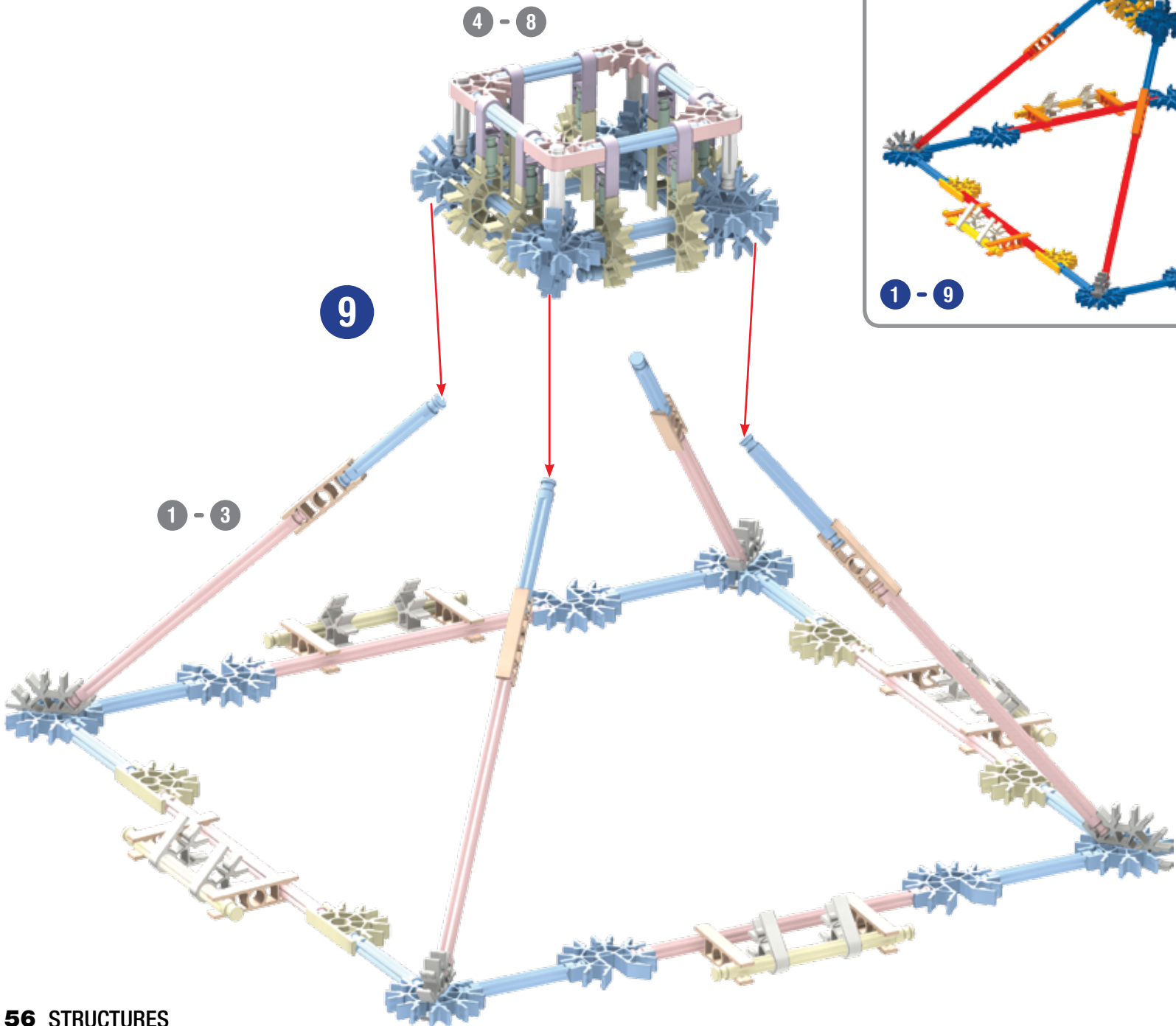

Mayan Pyramid

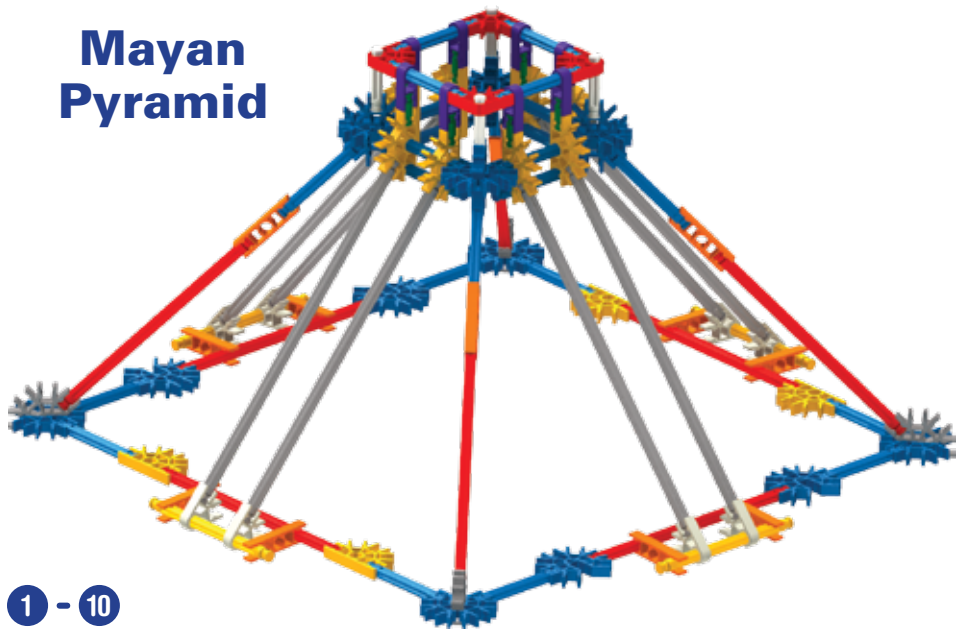

1 - 10



10

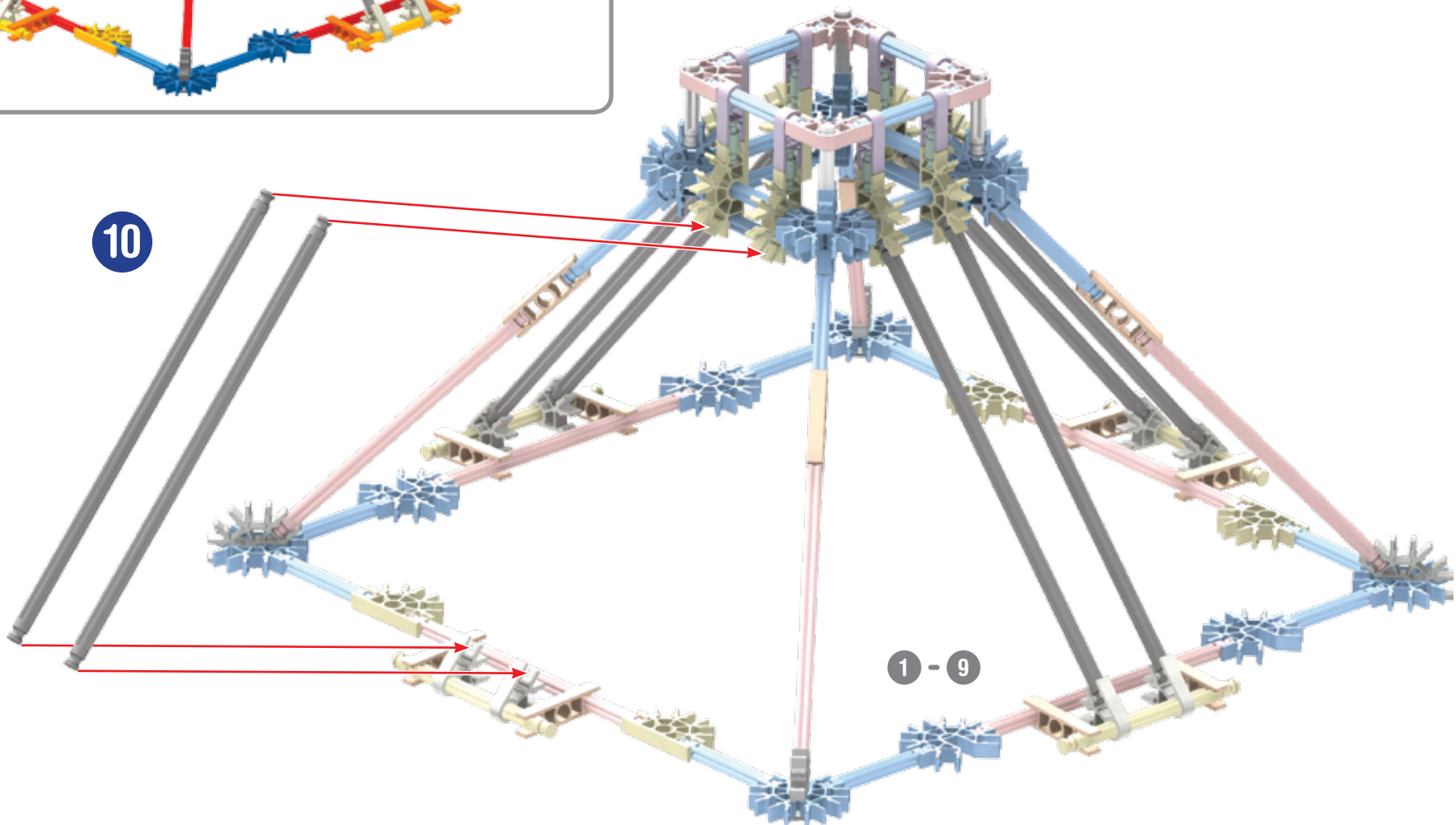

1 - 9

Observation Tower

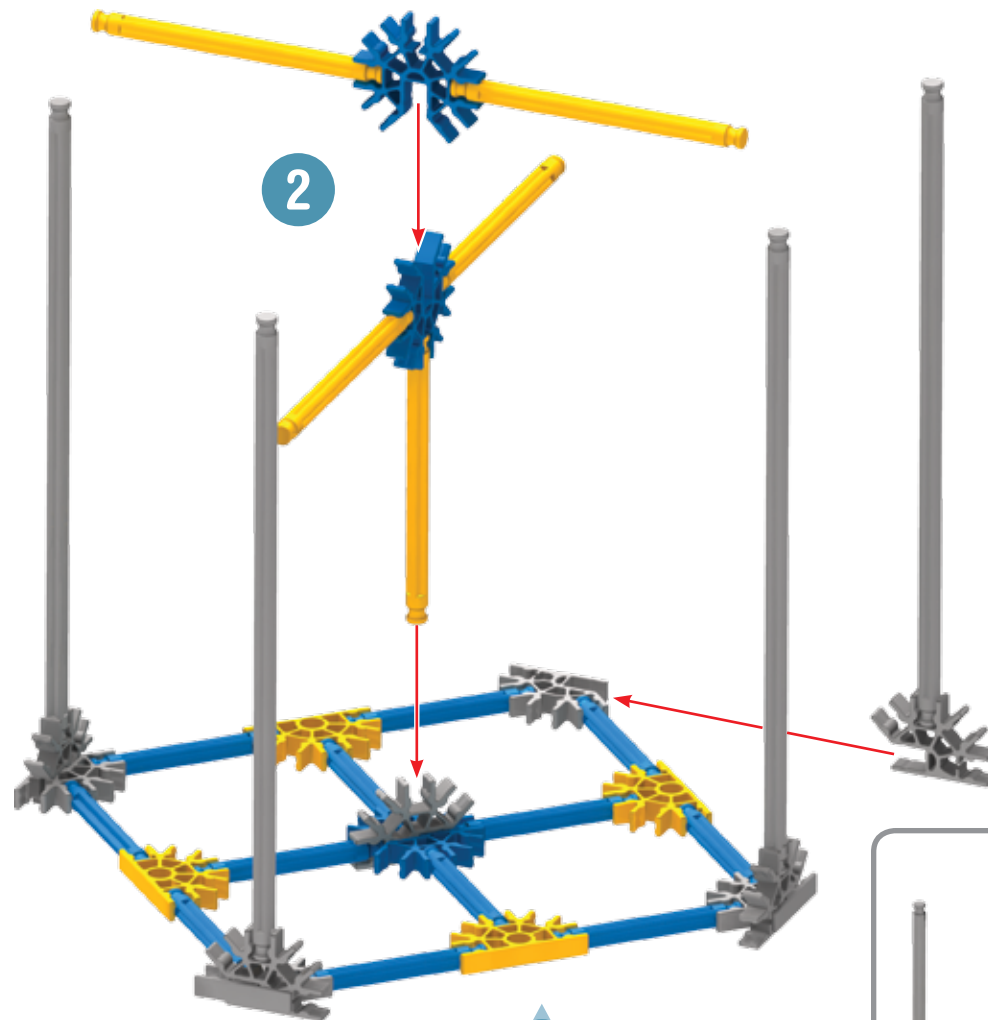
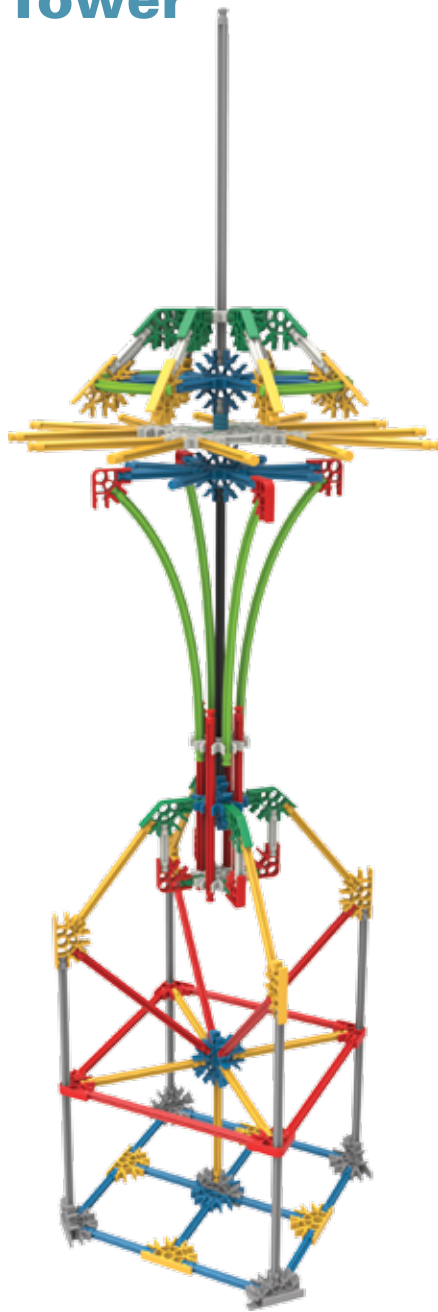

1

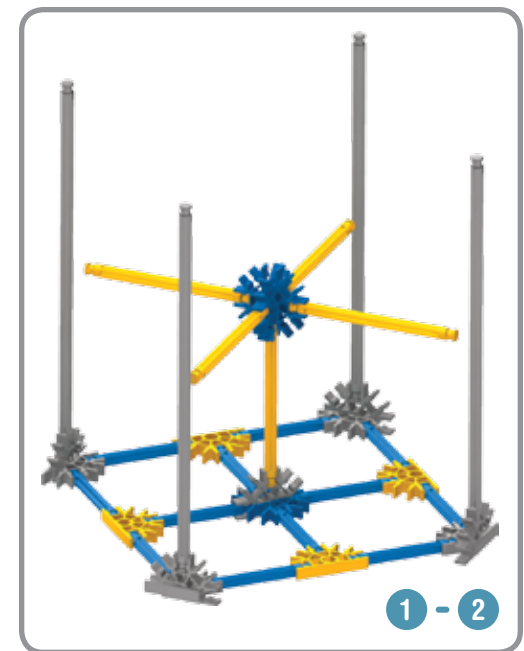
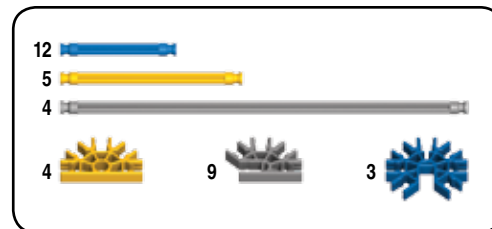

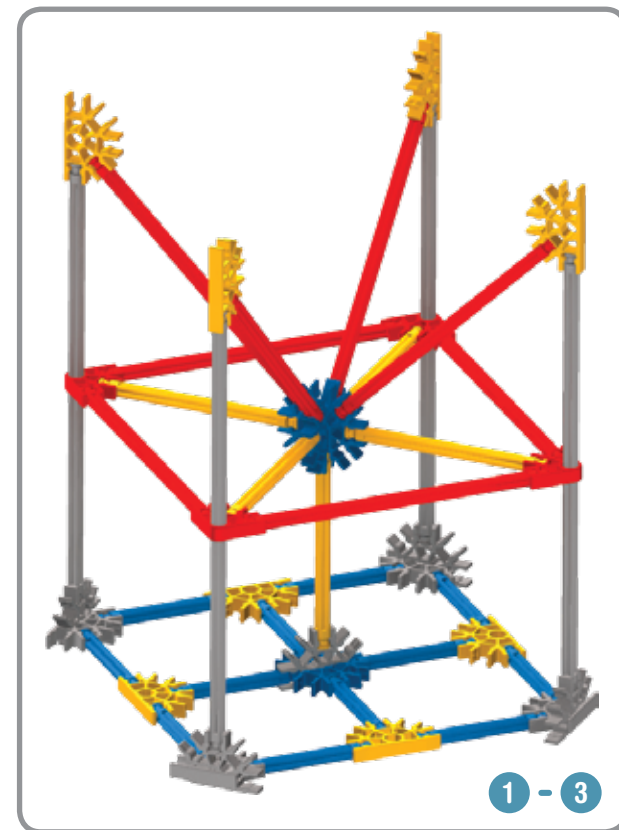
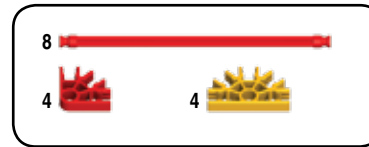
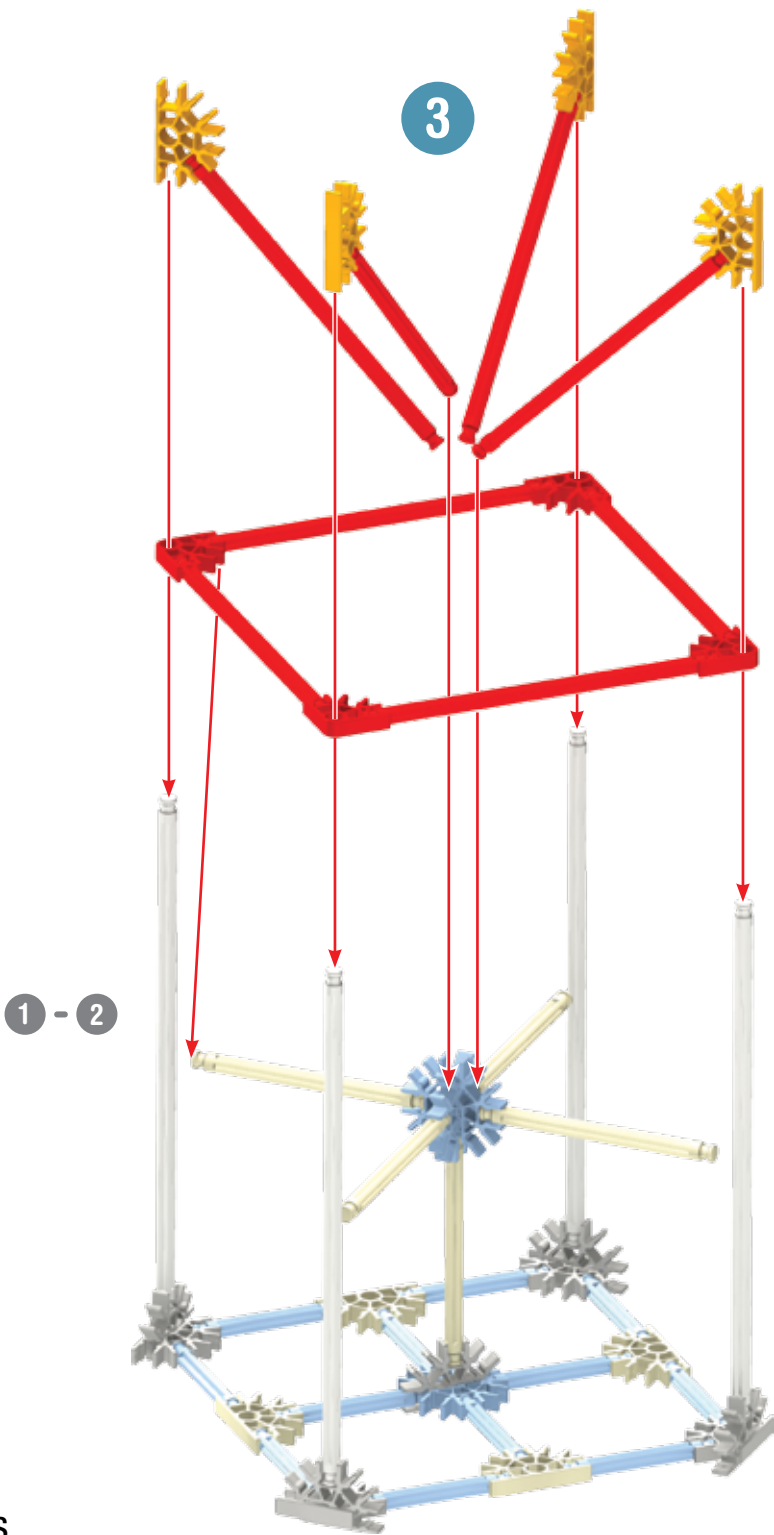

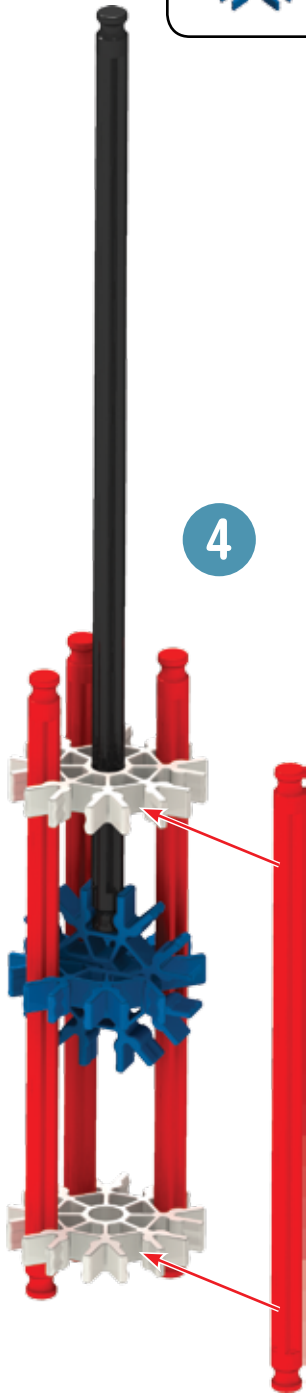
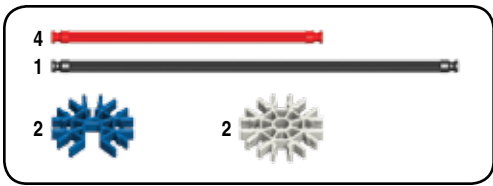
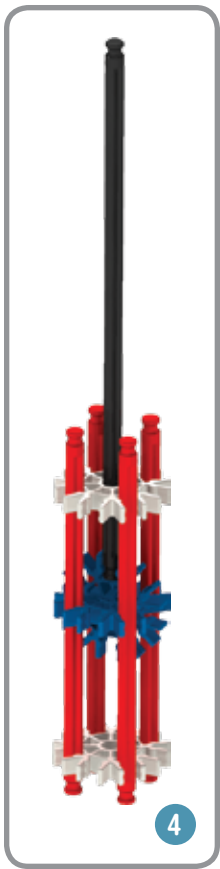

4

4

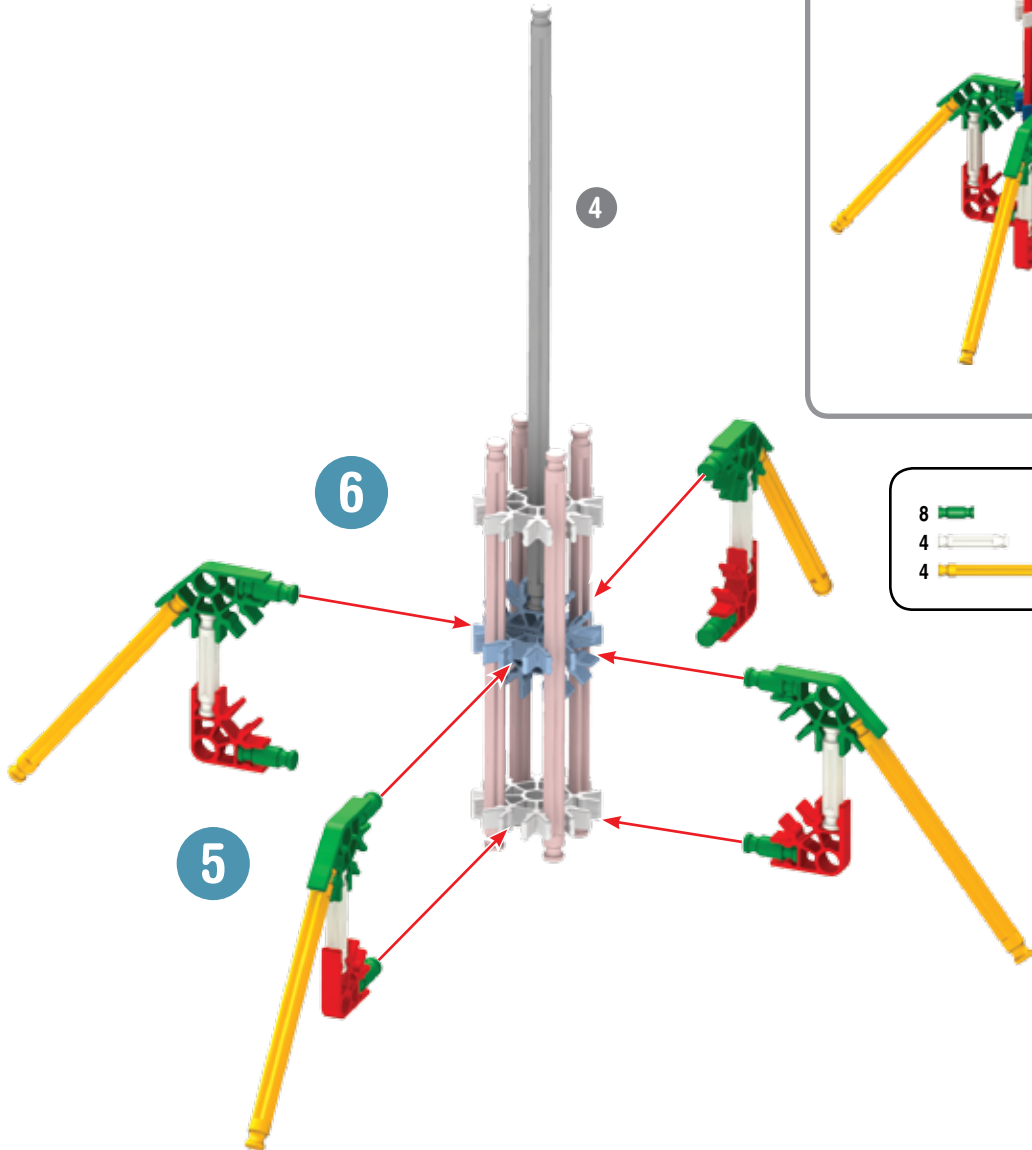

4

6

5

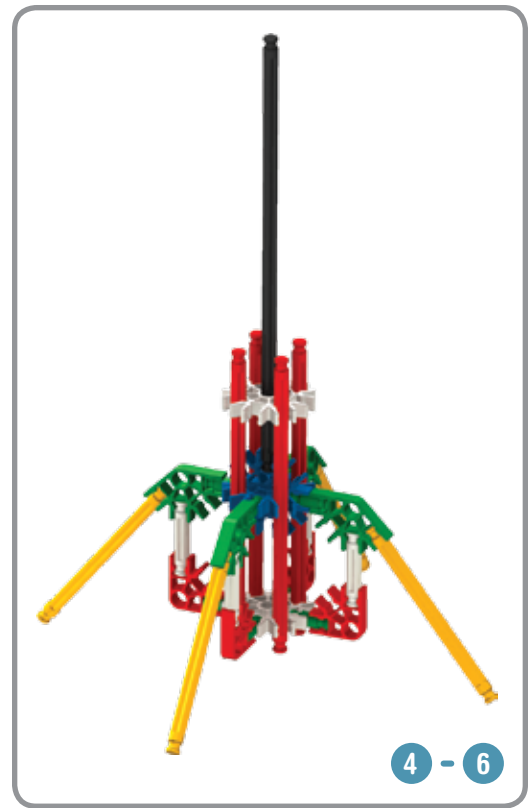

4 - 6

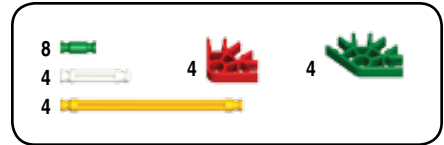

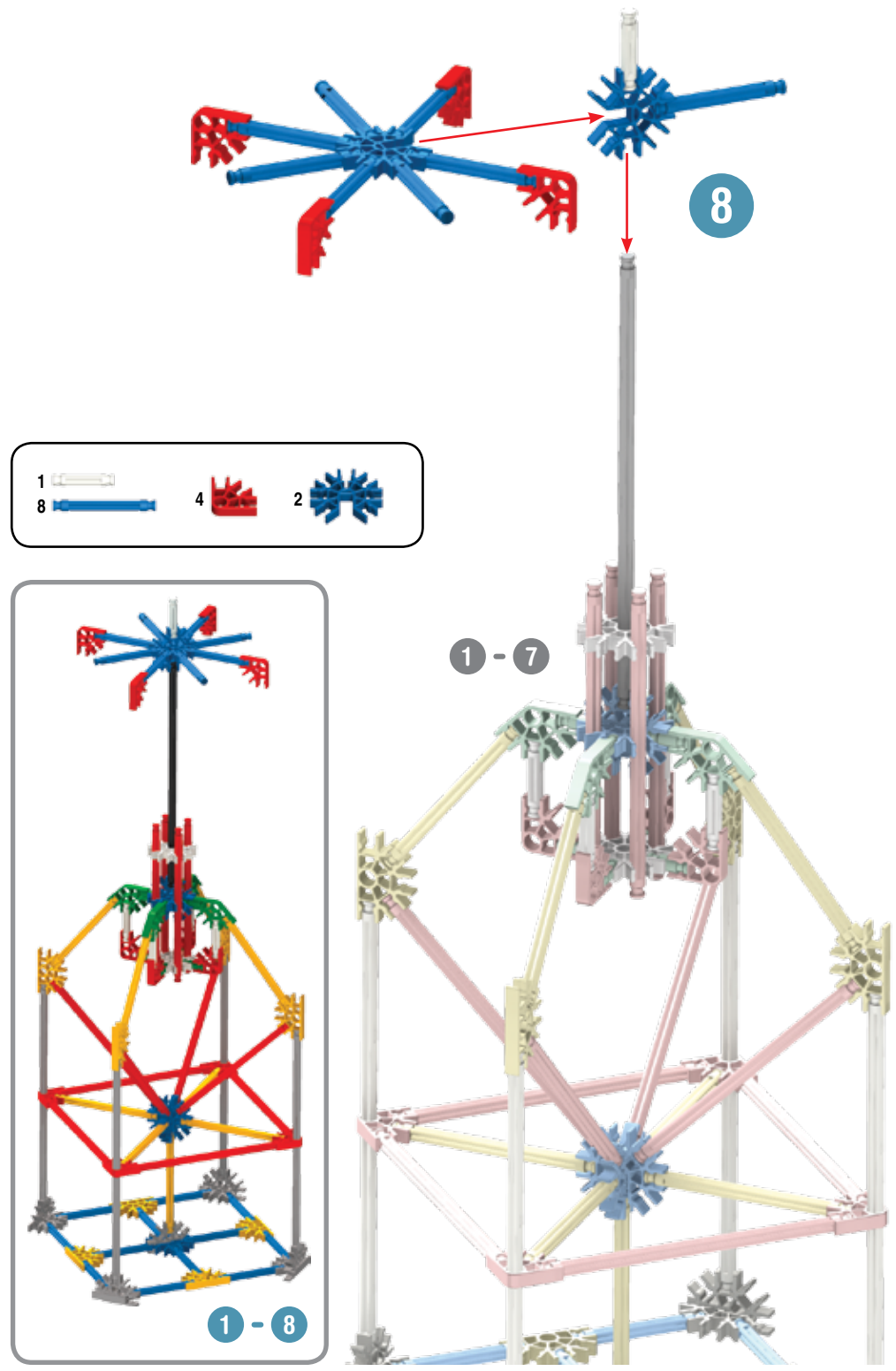
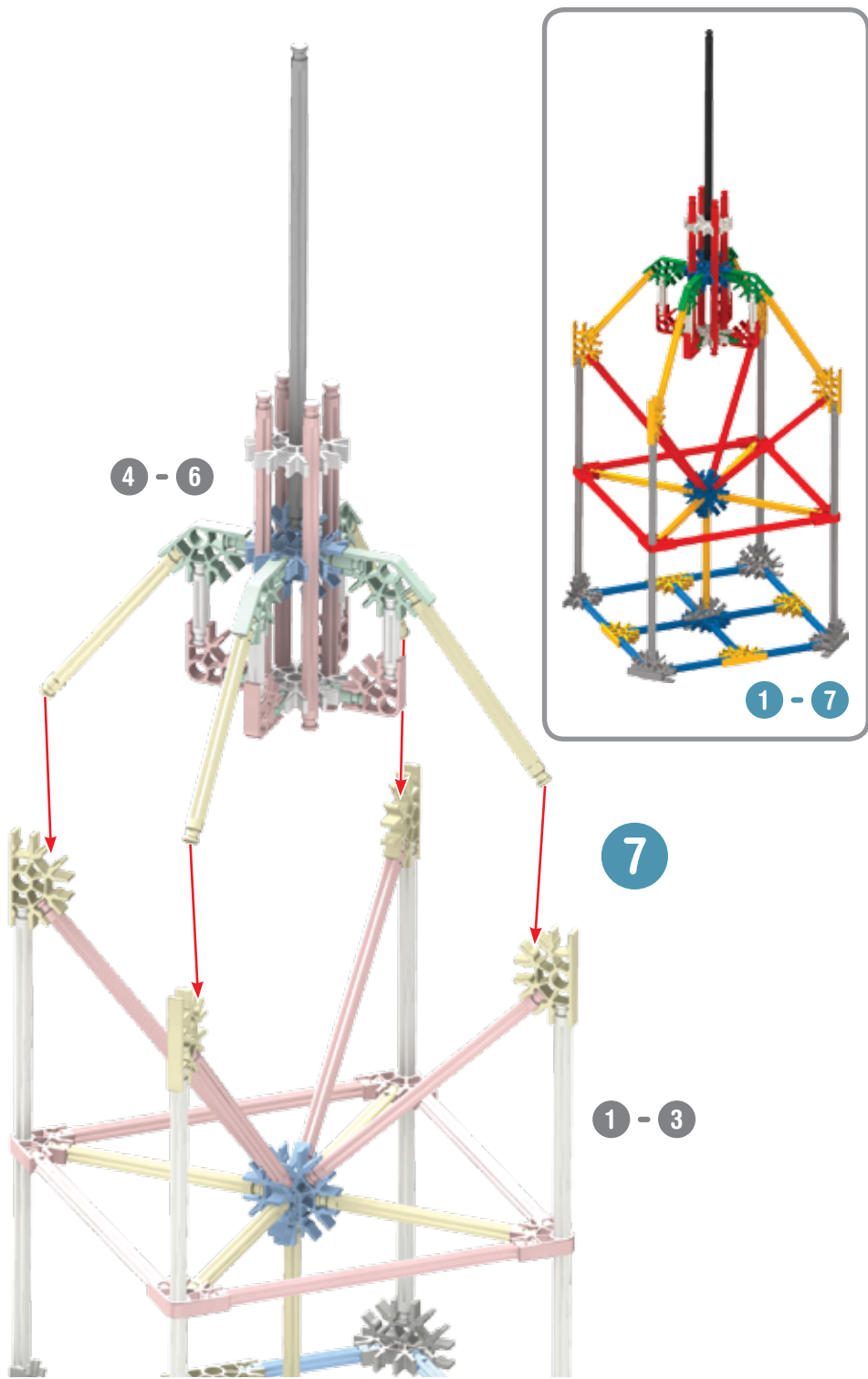

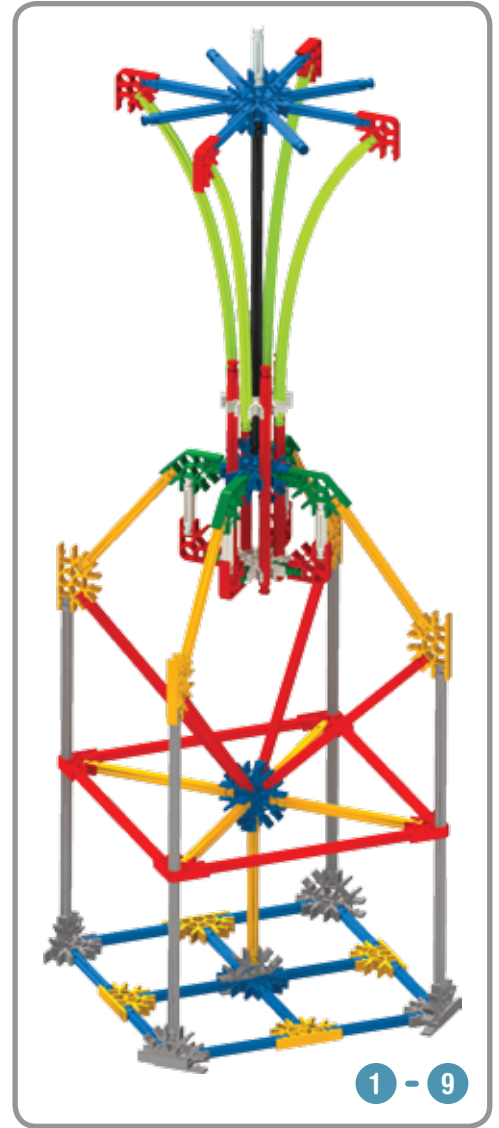
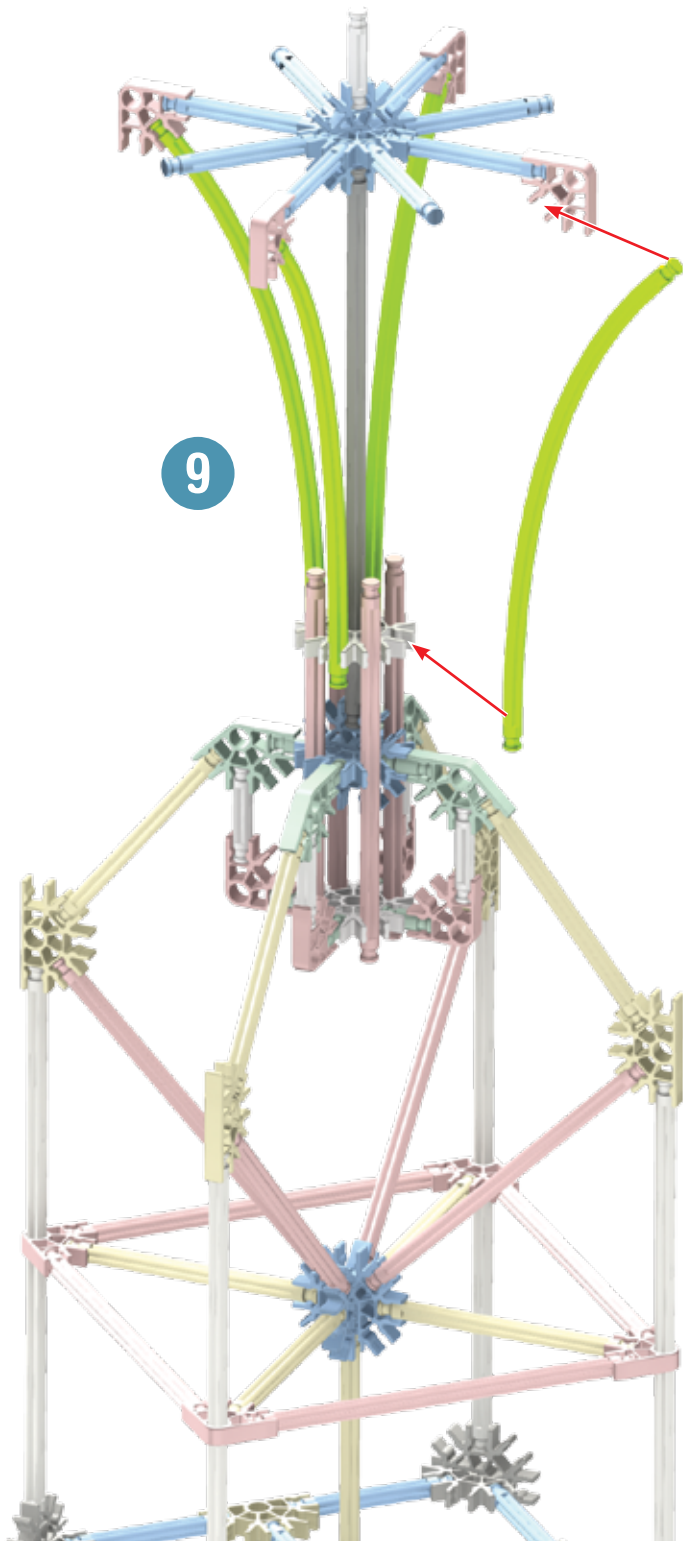

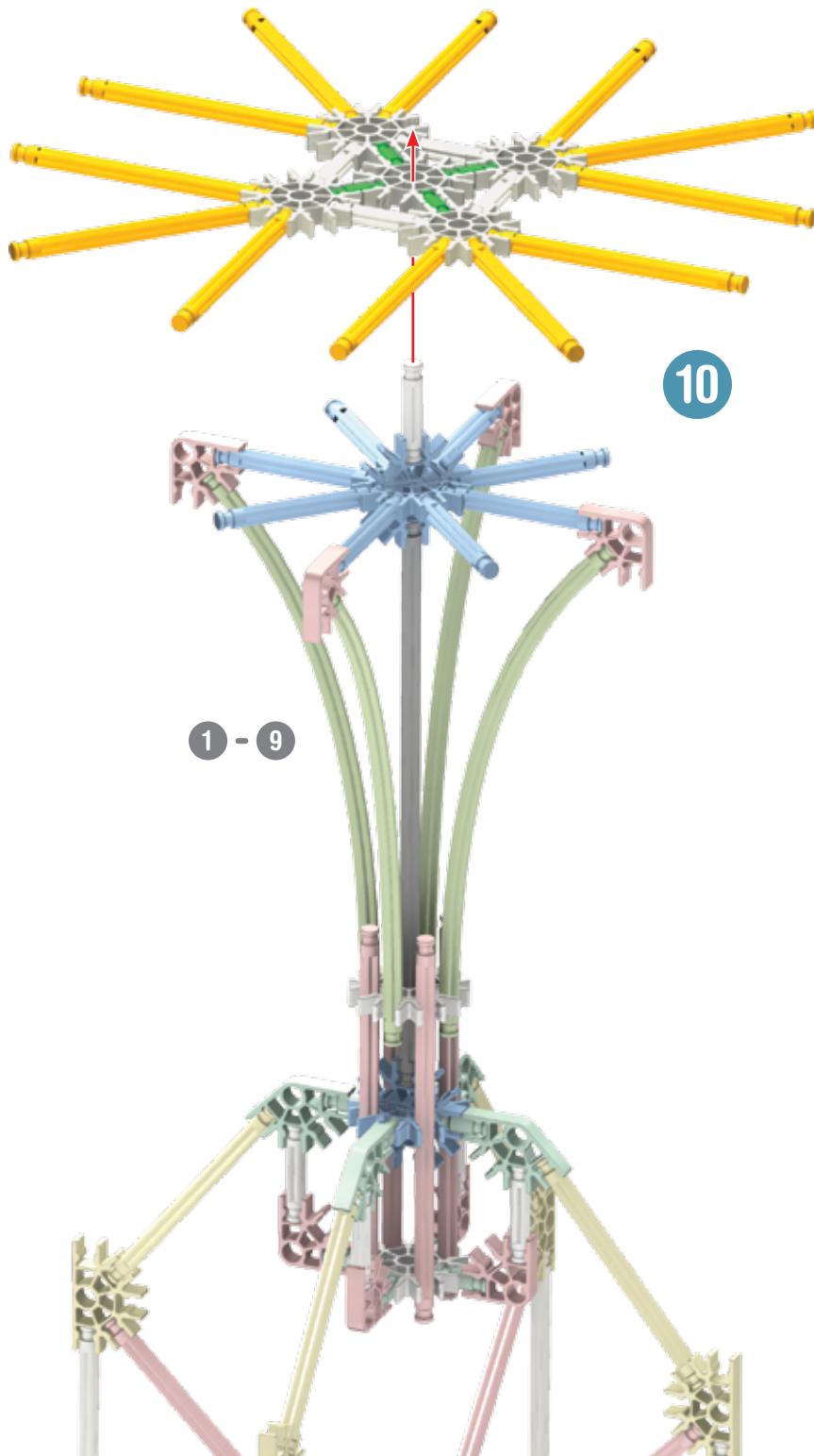



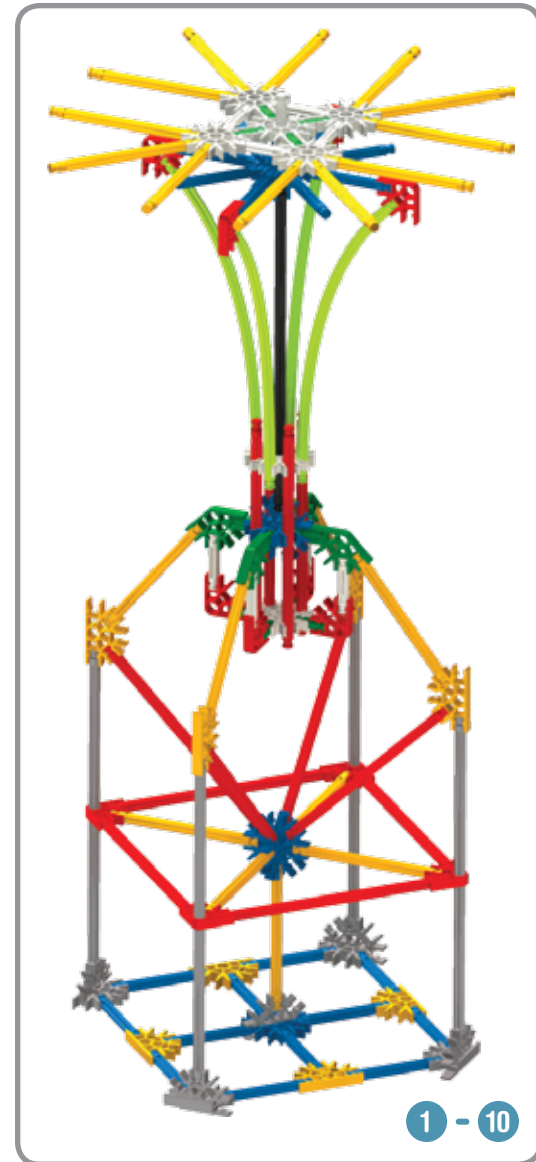
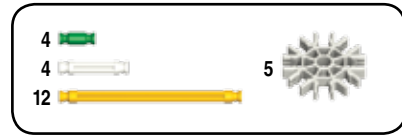

1 - 9

10



1 - 10

3		8		2	
8					

11

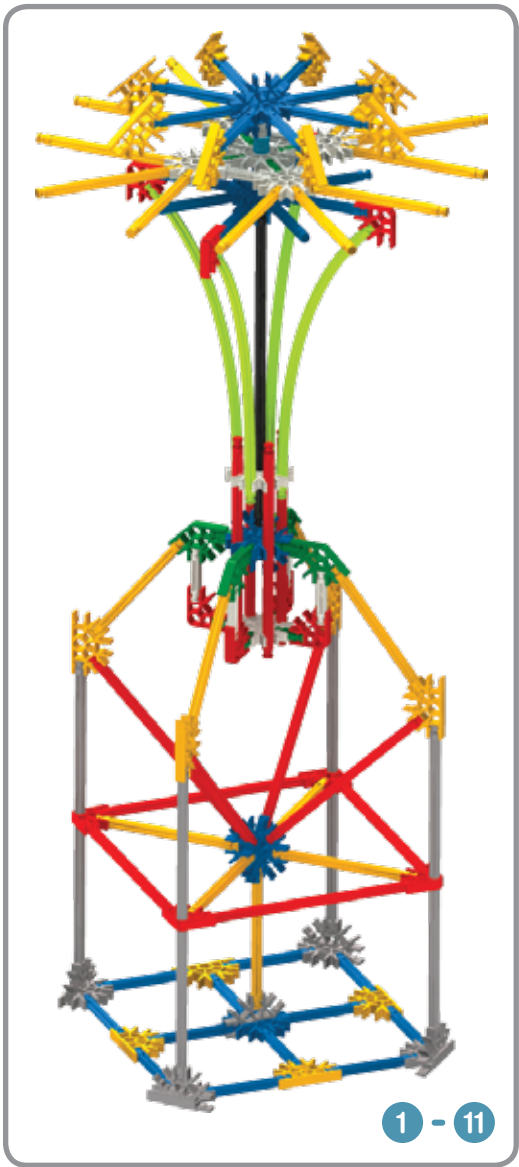
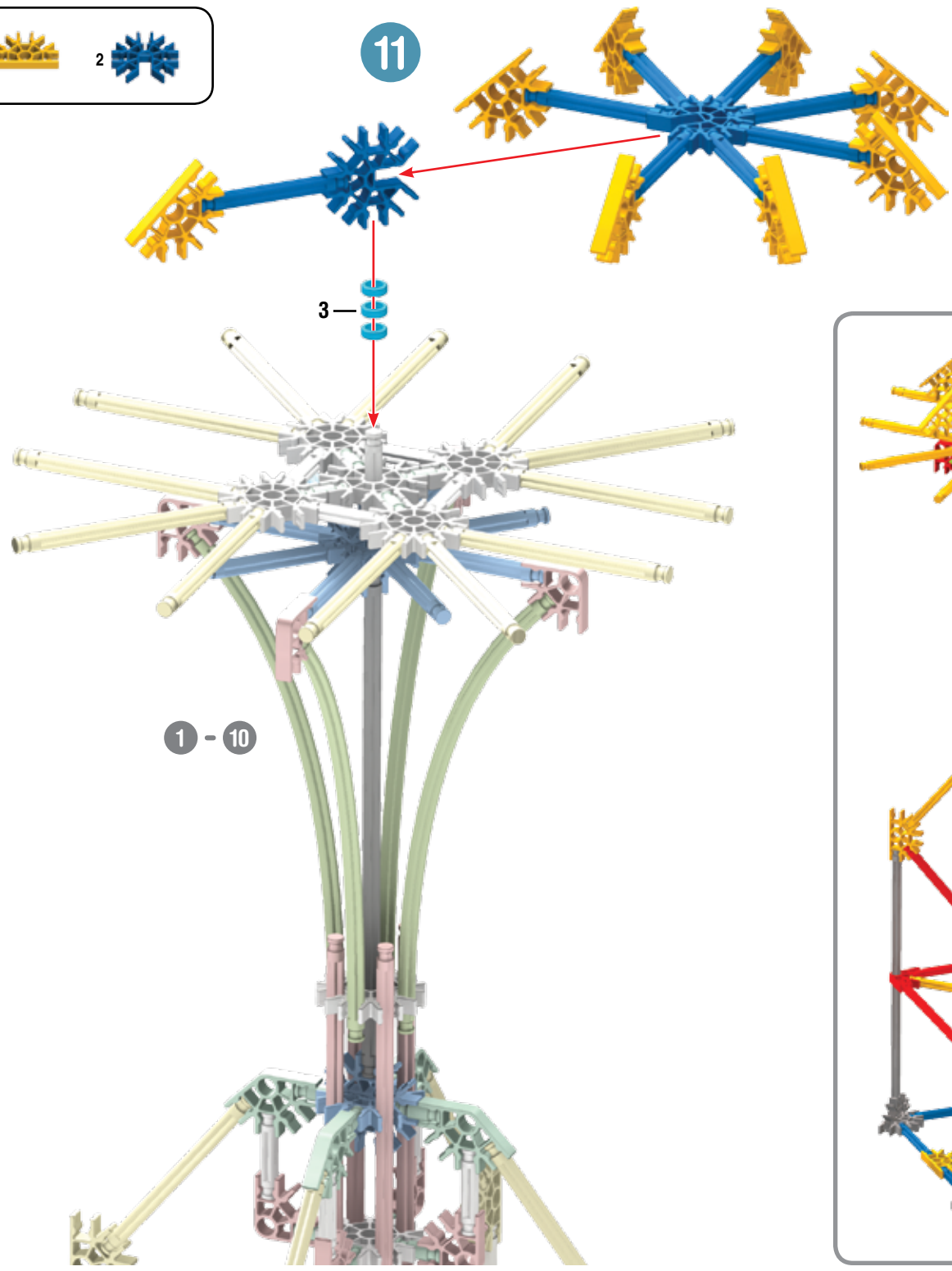

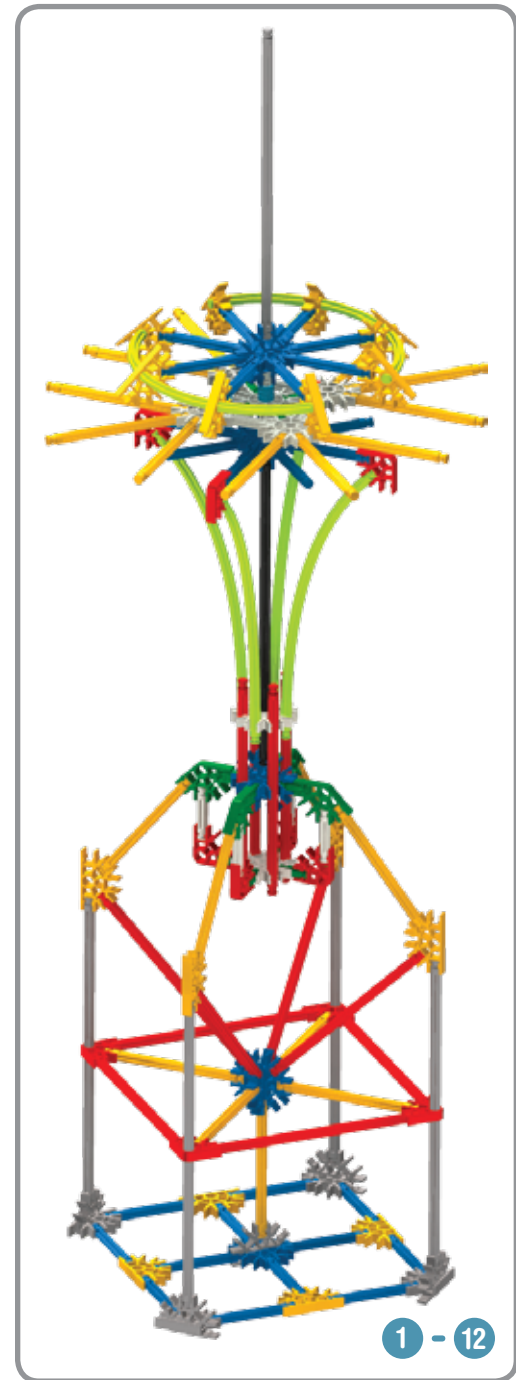
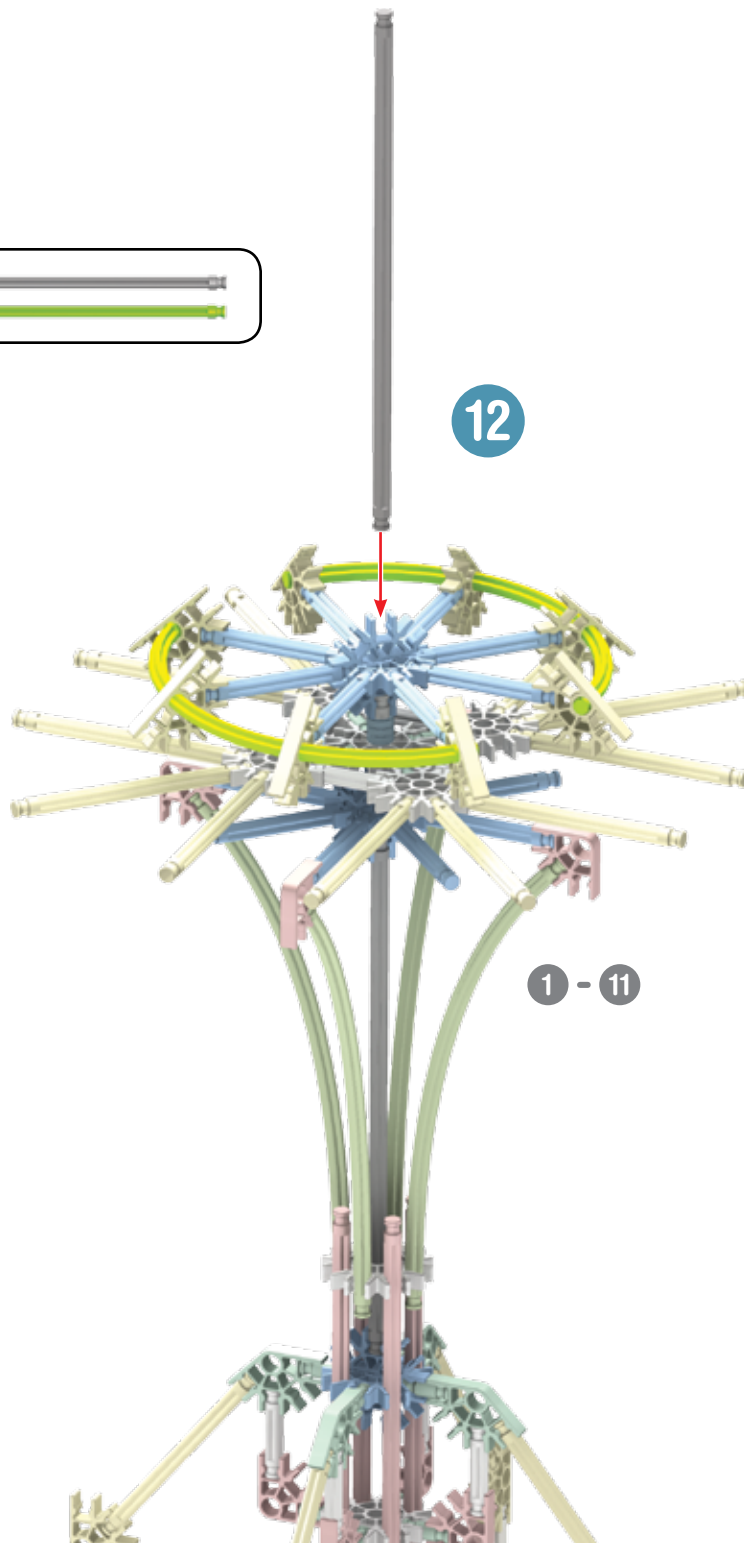

13

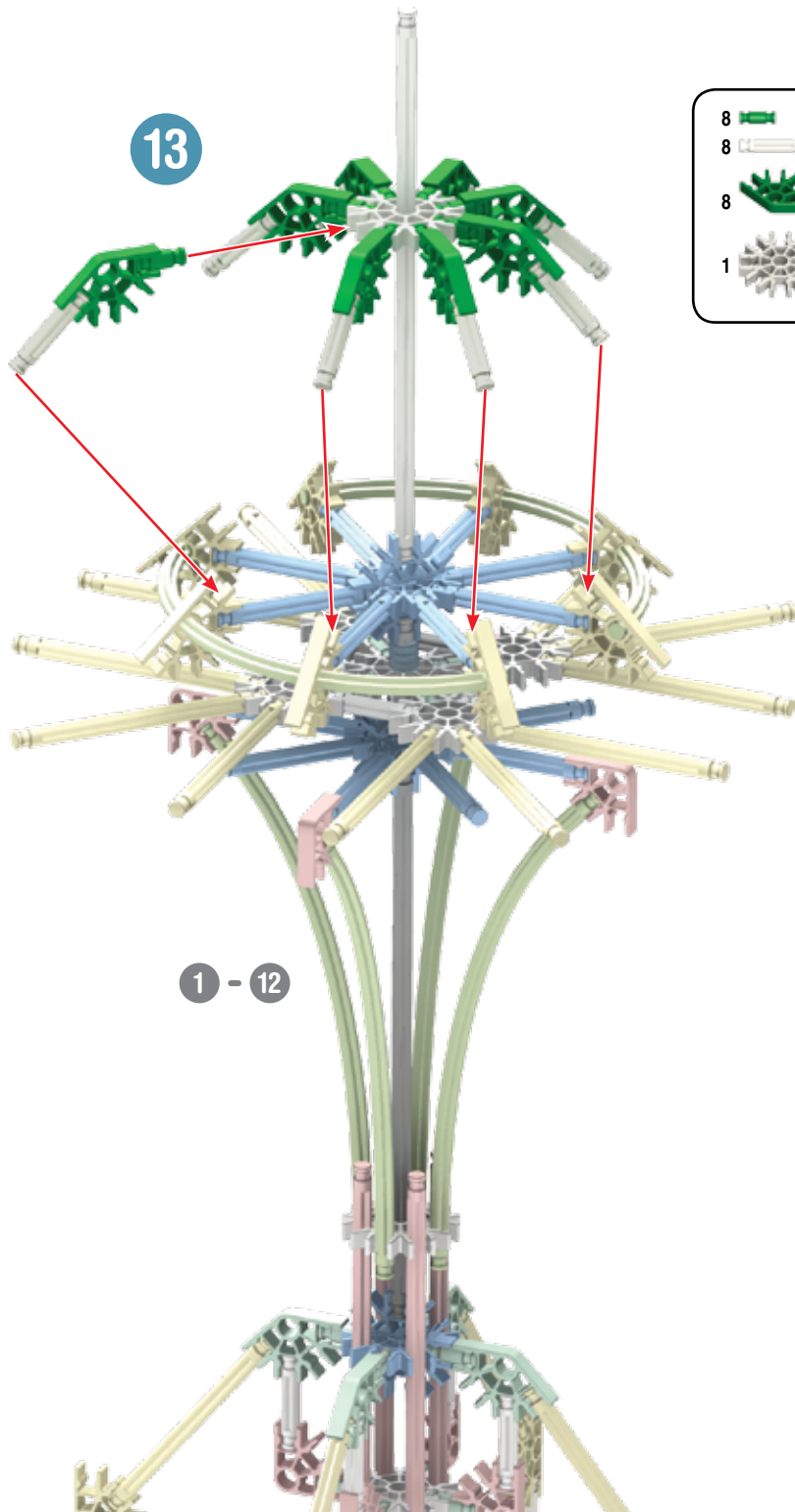

- 8
- 8
- 8
- 1

Observation Tower

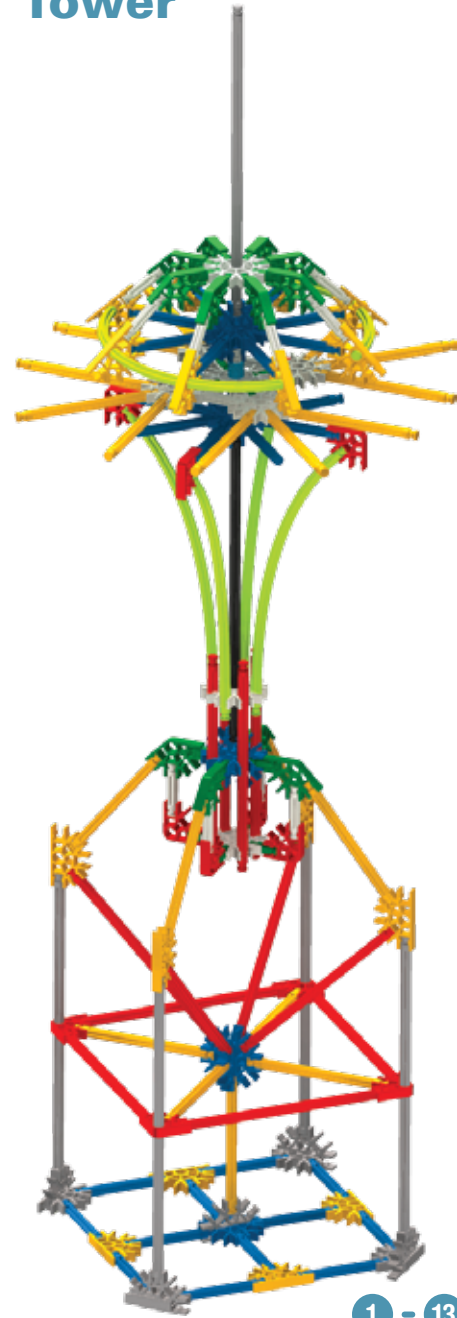

Palace

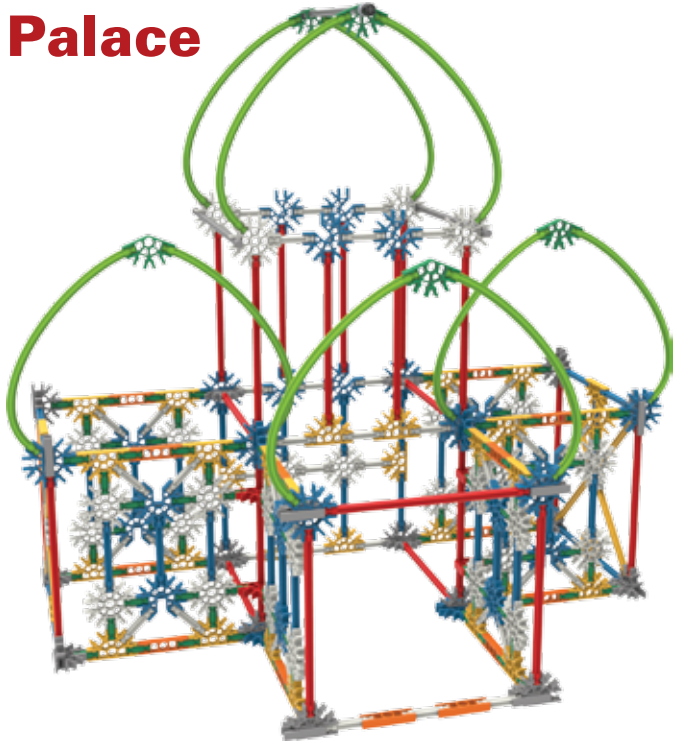

1

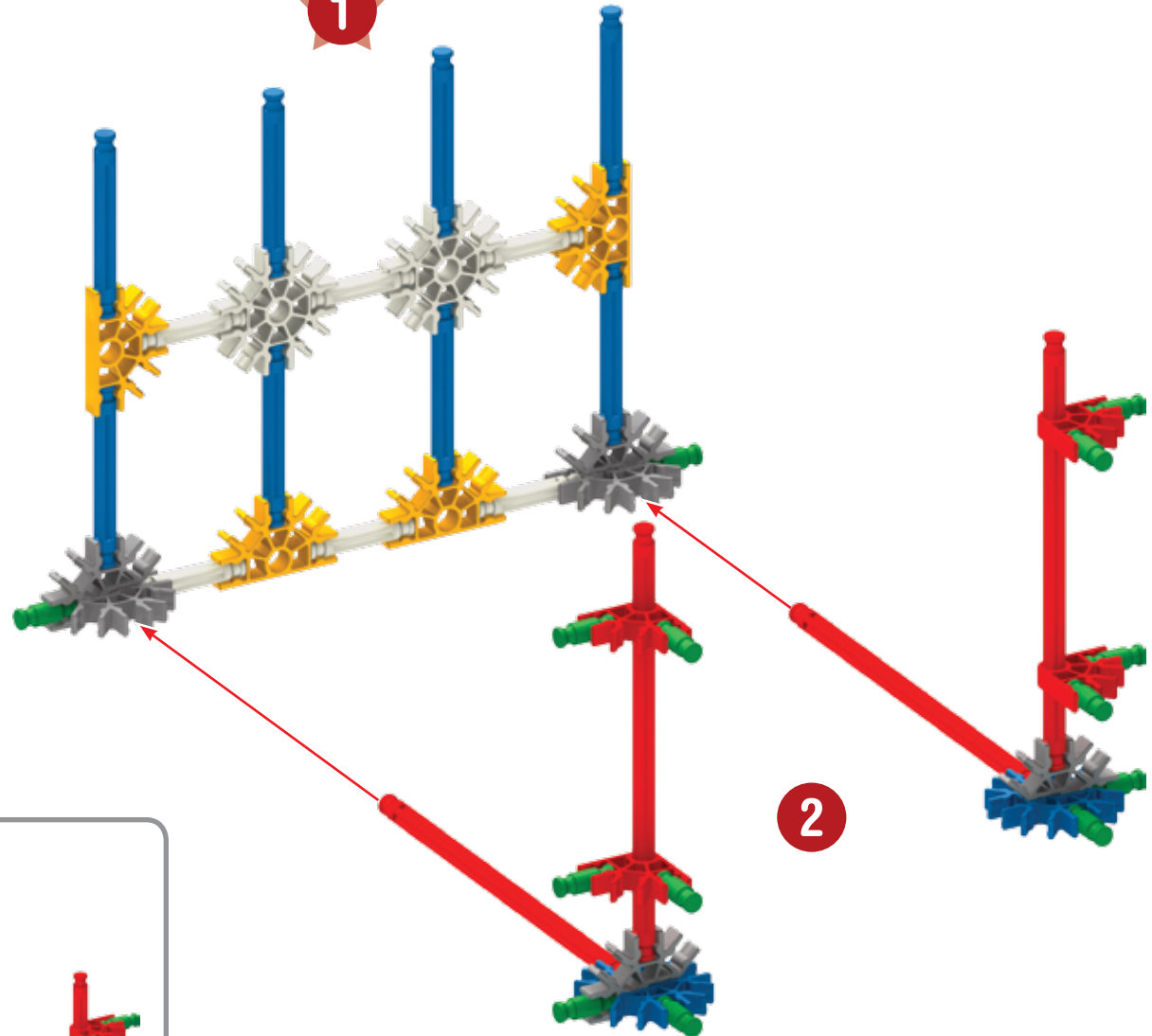

2

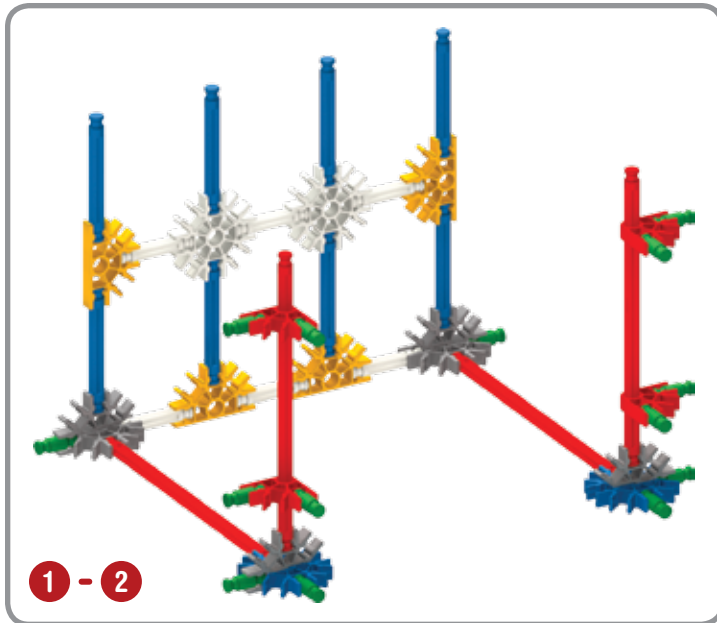

- | | | | | | |
|----|--|---|--|---|--|
| 14 | | 4 | | 4 | |
| 6 | | 4 | | 4 | |
| 8 | | 4 | | 4 | |
| 4 | | 4 | | 4 | |
| 6 | | 2 | | 2 | |

3

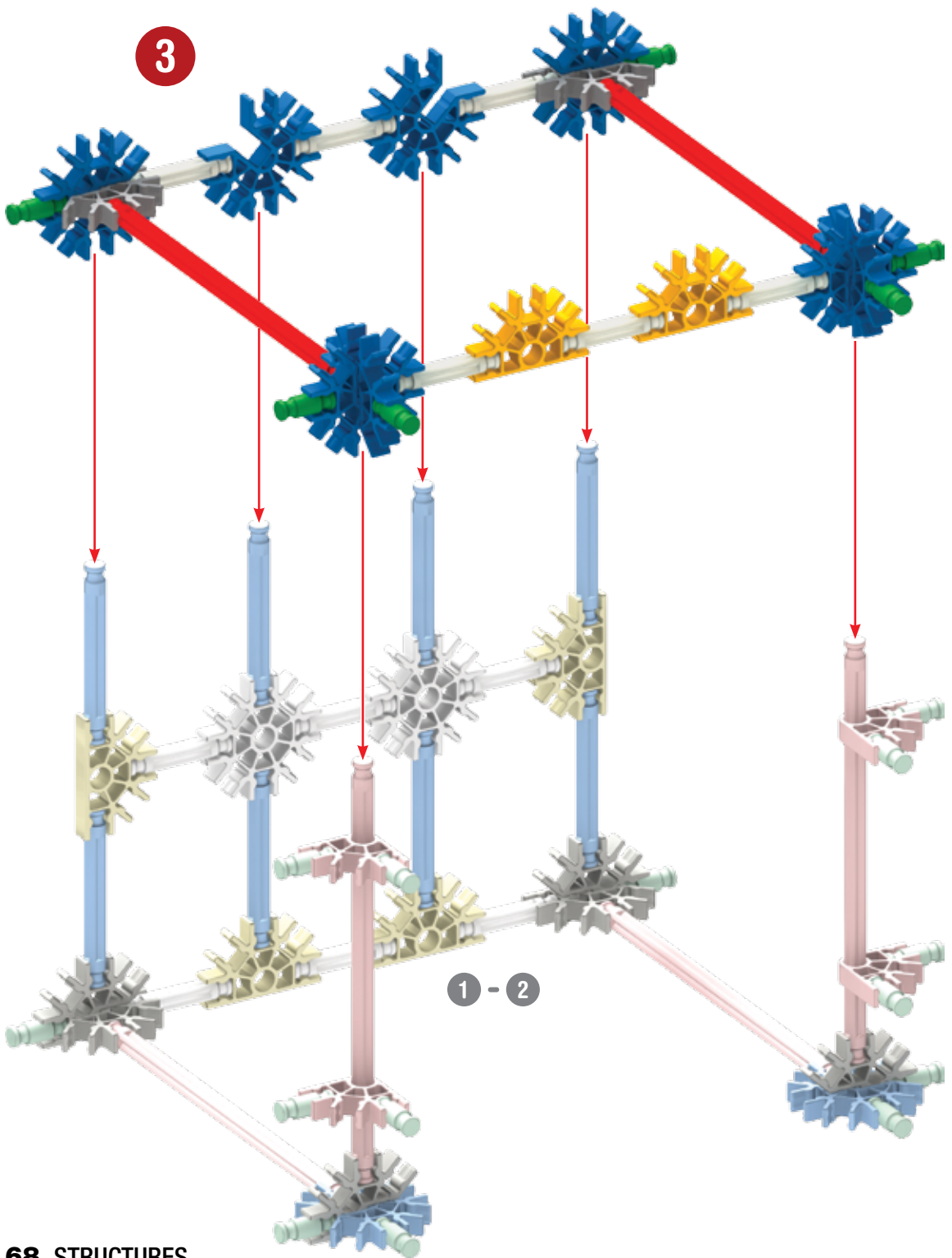

- | | | | |
|---|--|---|--|
| 6 | | 2 | |
| 6 | | | |
| 2 | | | |
| 2 | | 8 | |

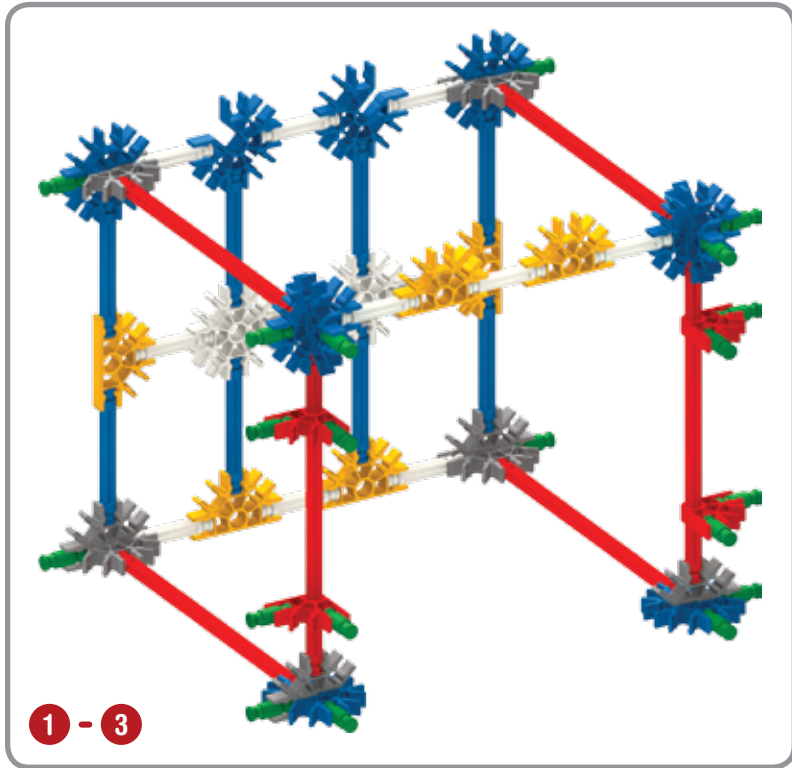

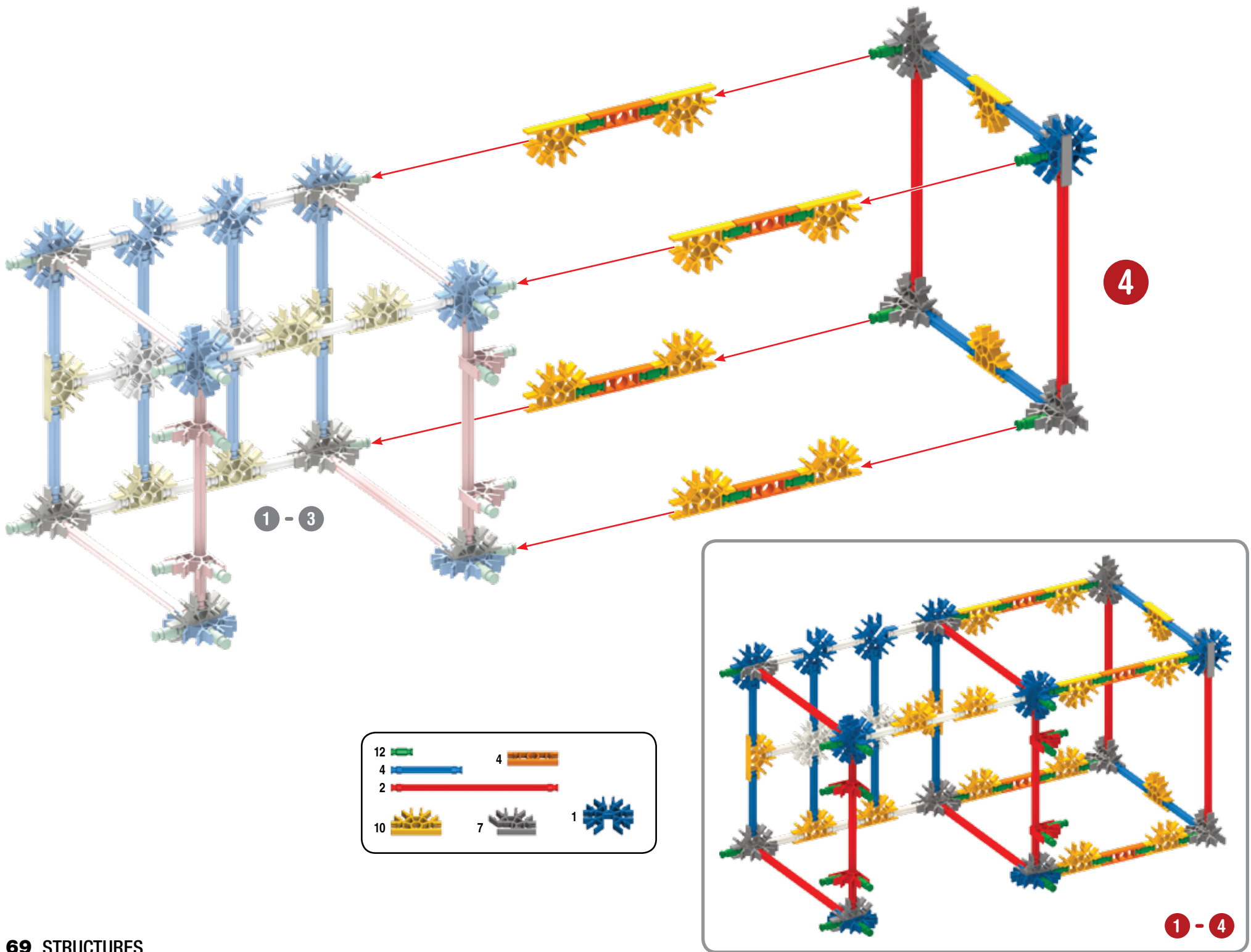

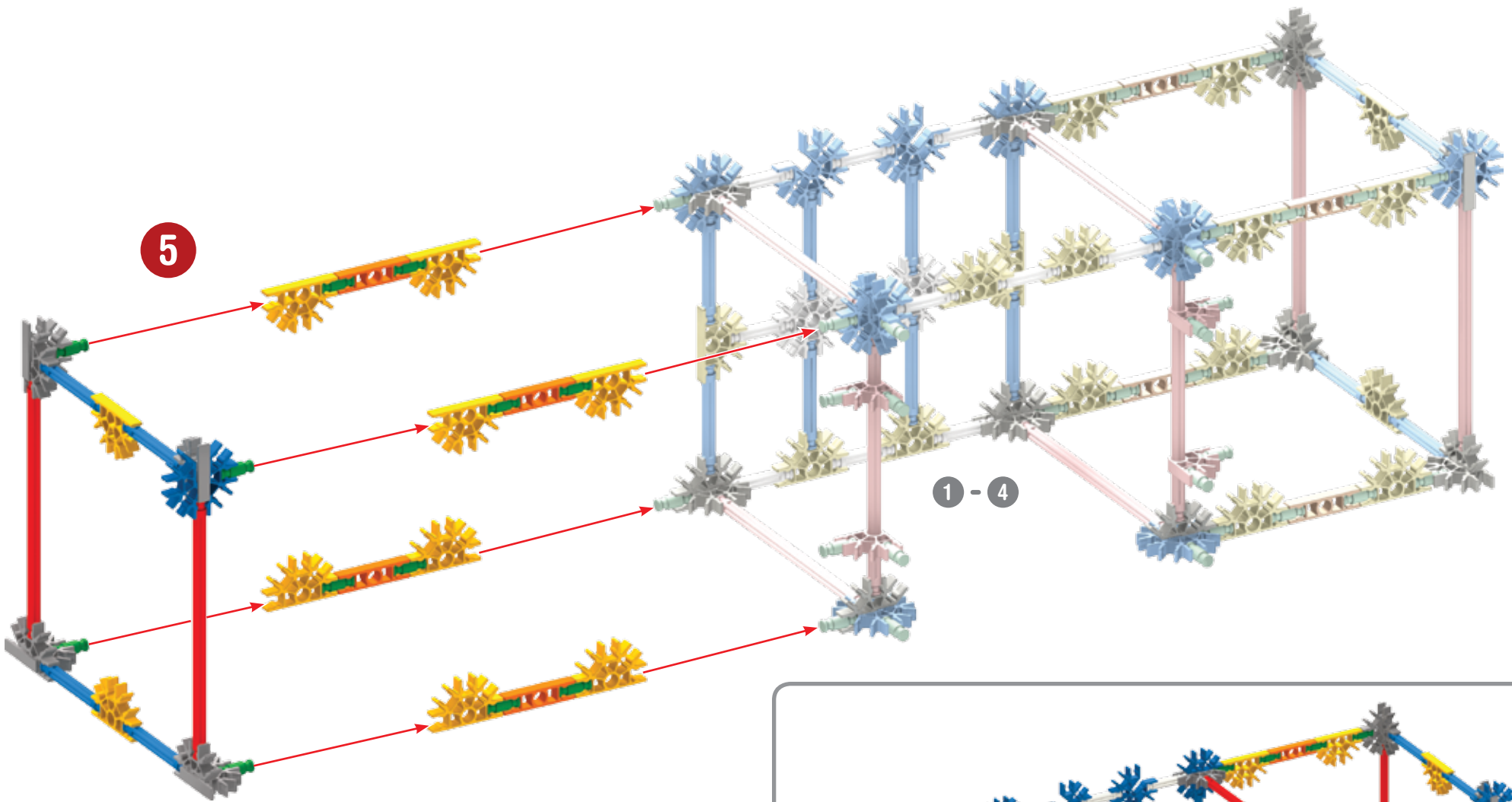

5

1 - 4

12		4	
4			
2			
10		7	
		1	

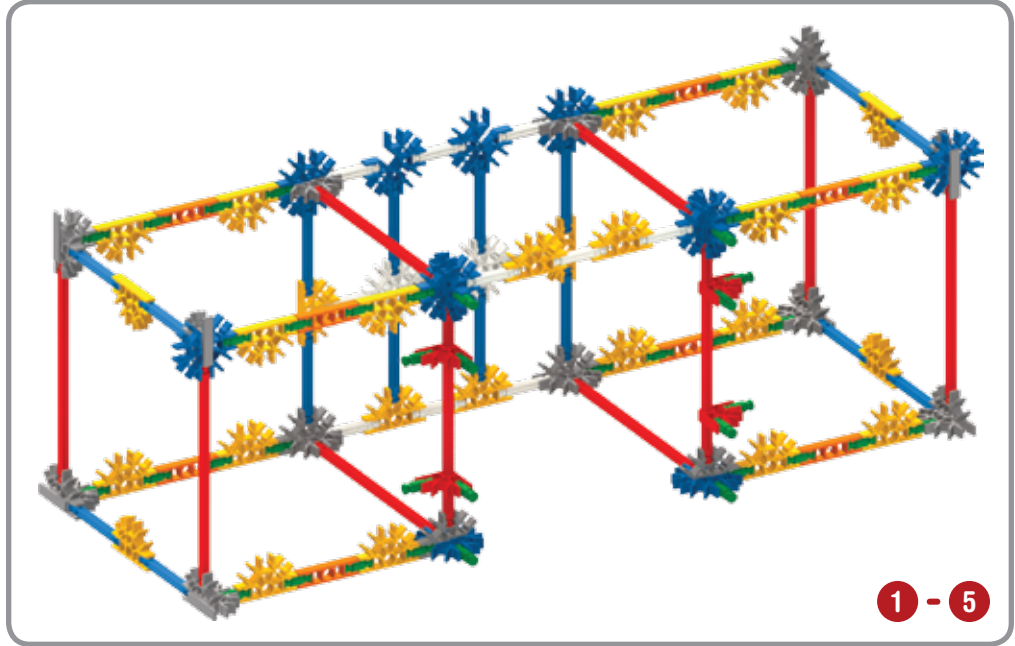

1 - 5

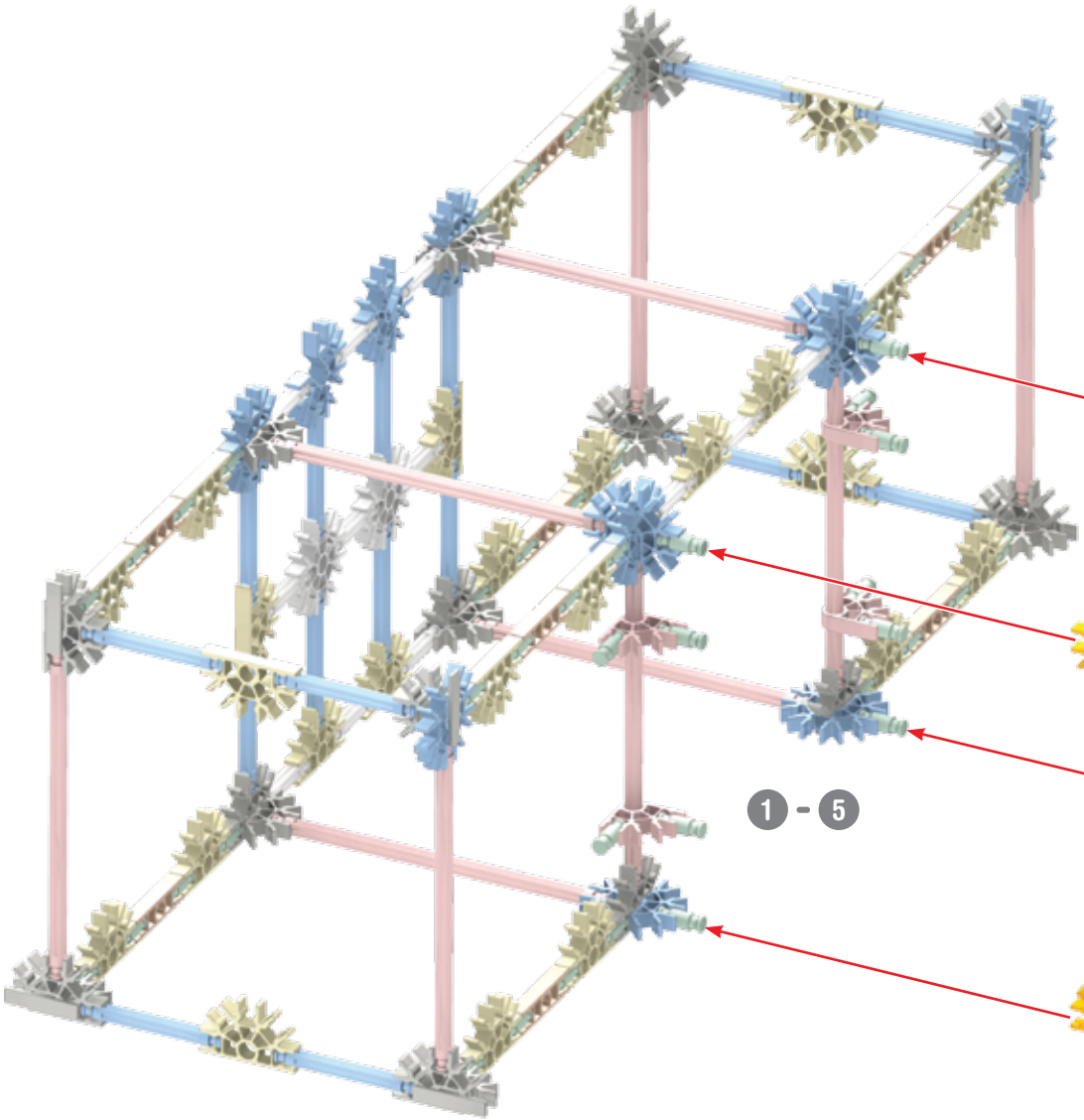
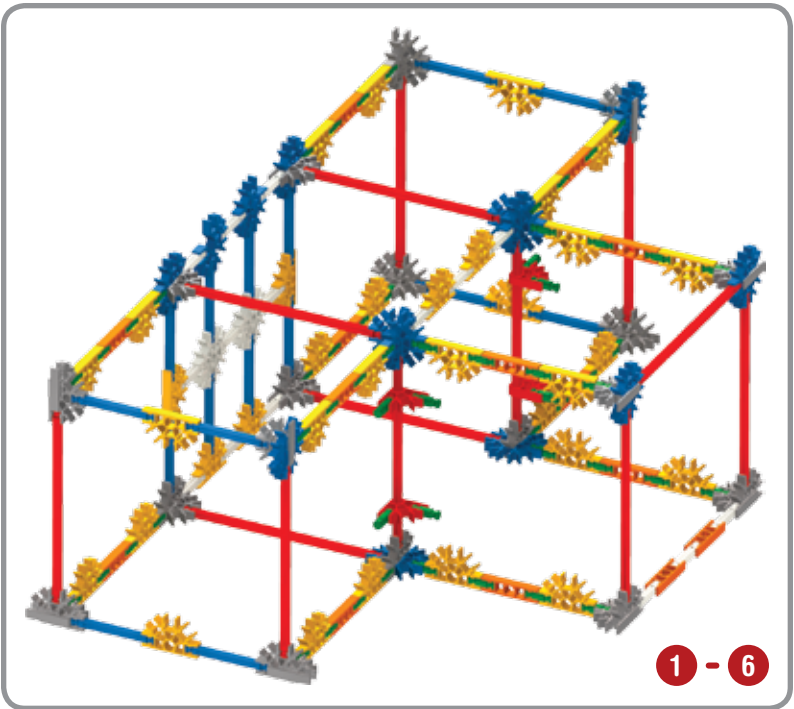
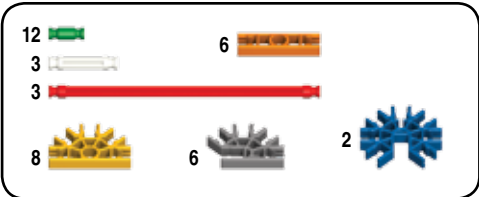

1 - 5

6

x2

7

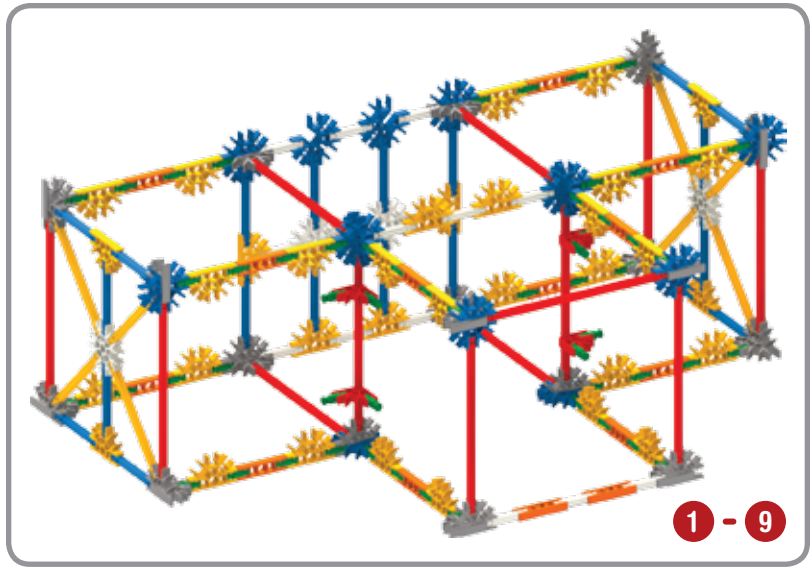
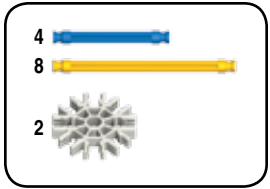
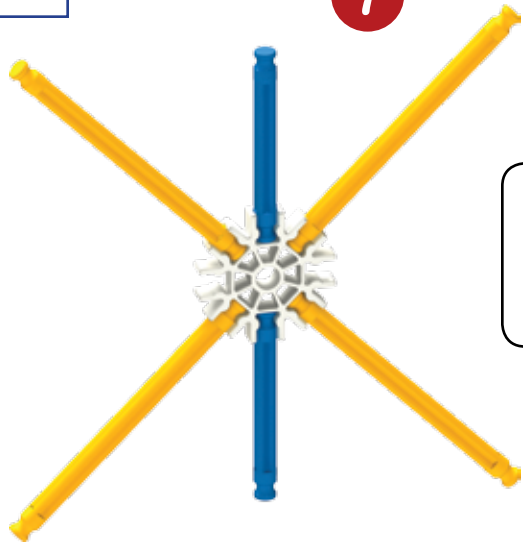

1 - 9

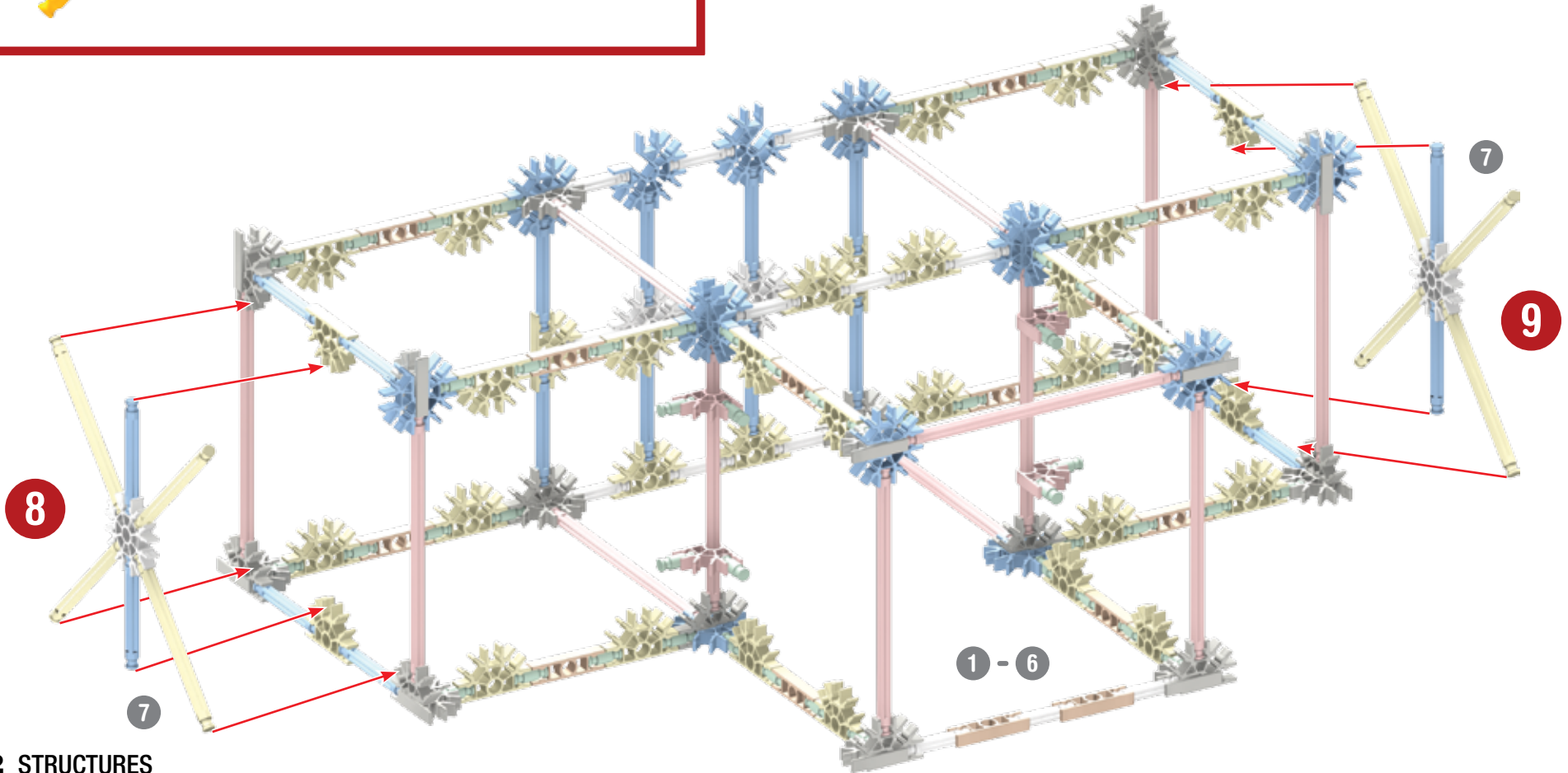

1 - 6

x6

10

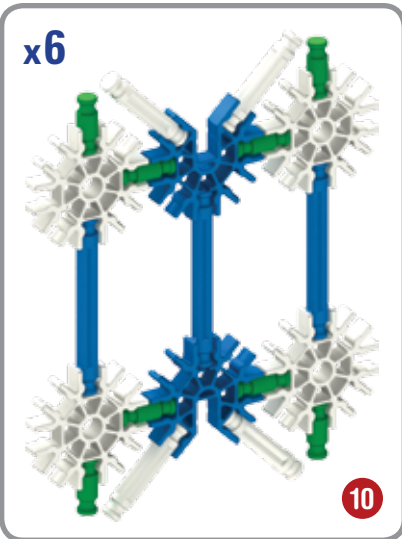
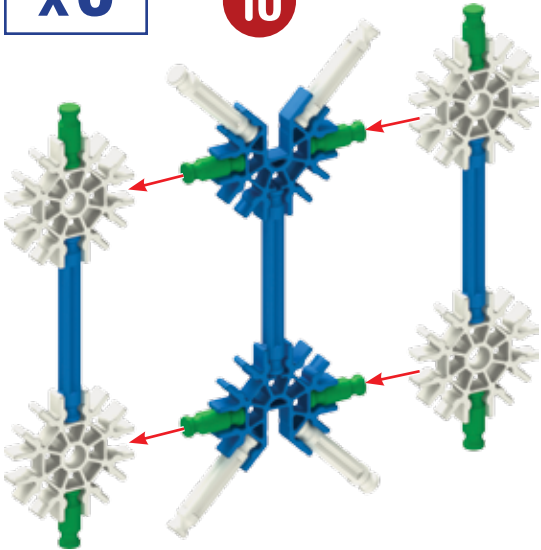

- 48 12 24
- 24
- 18

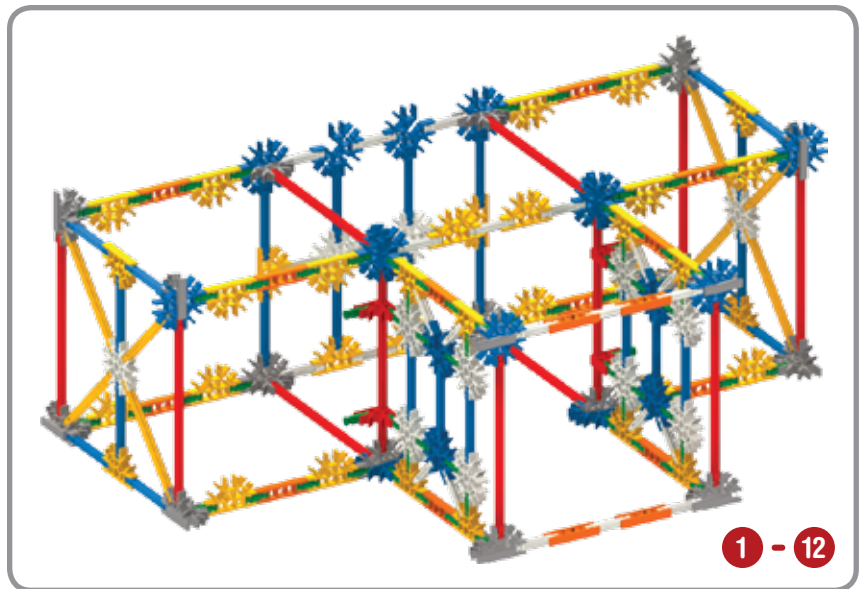
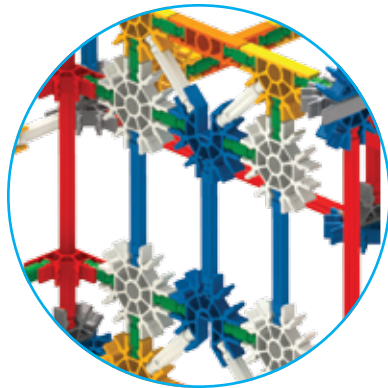
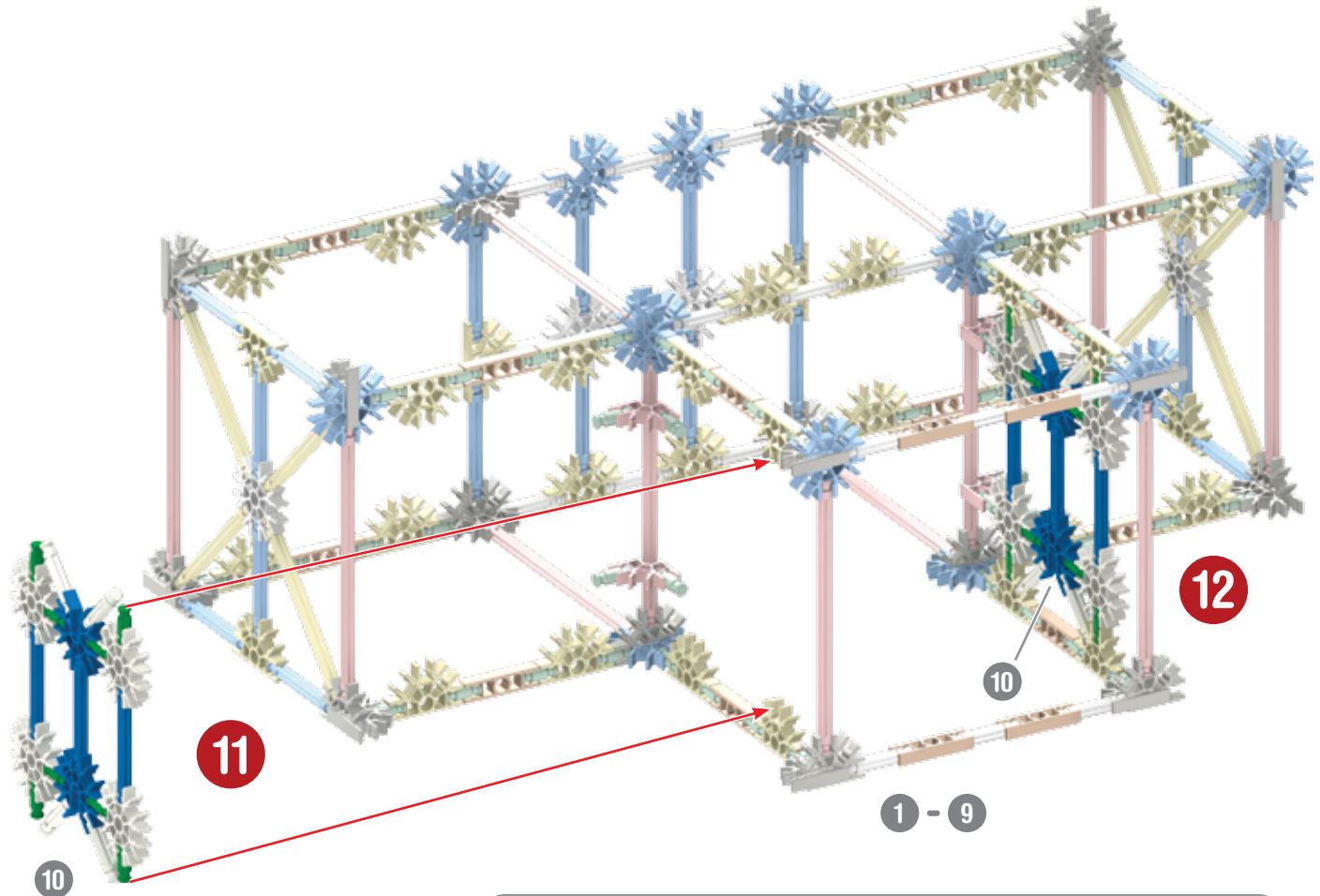

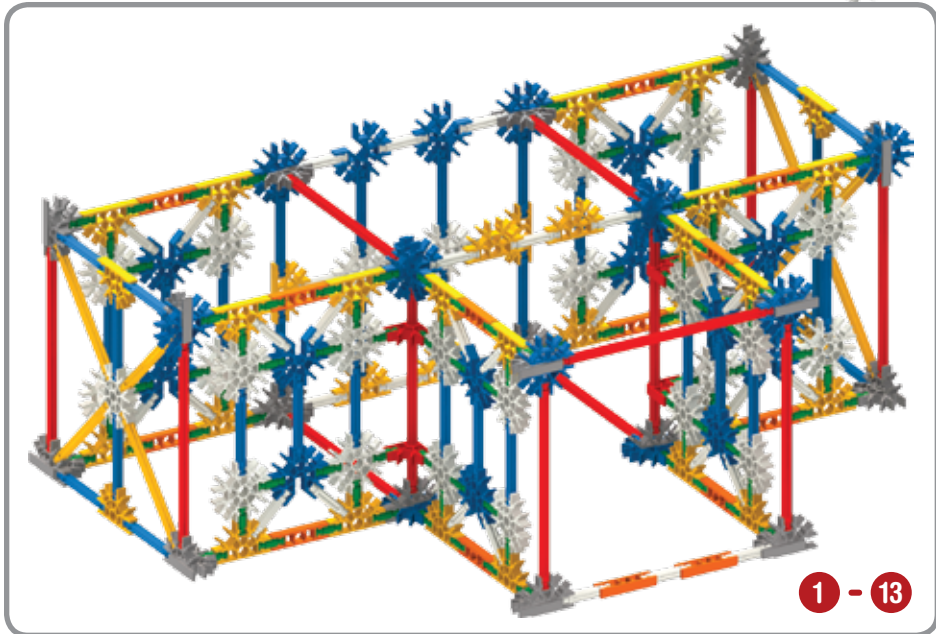
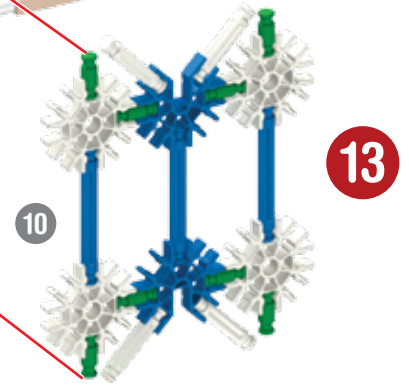
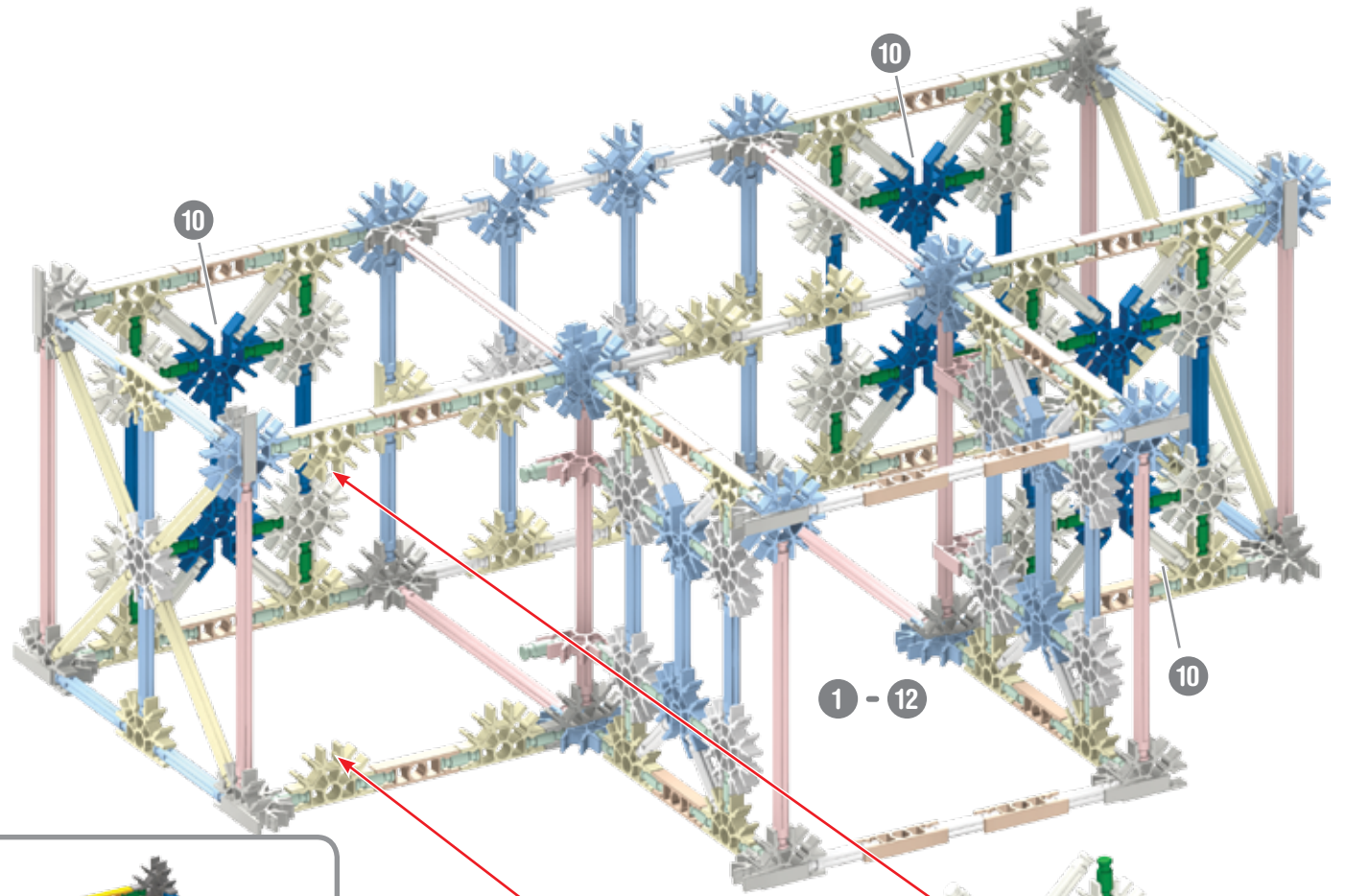
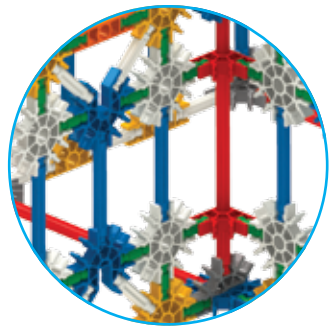

14

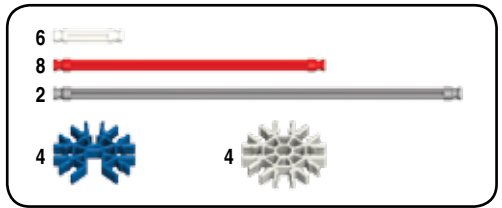
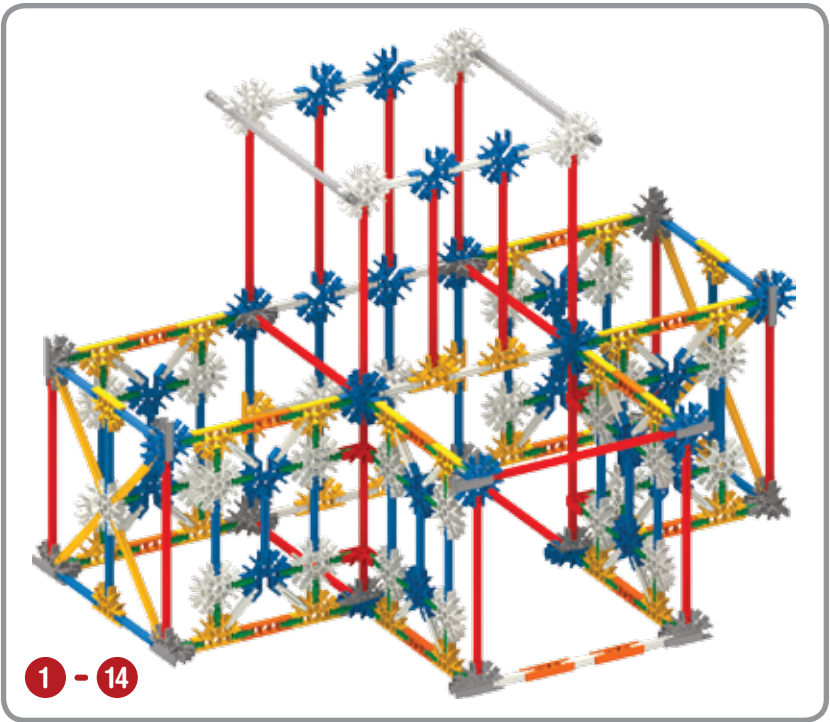
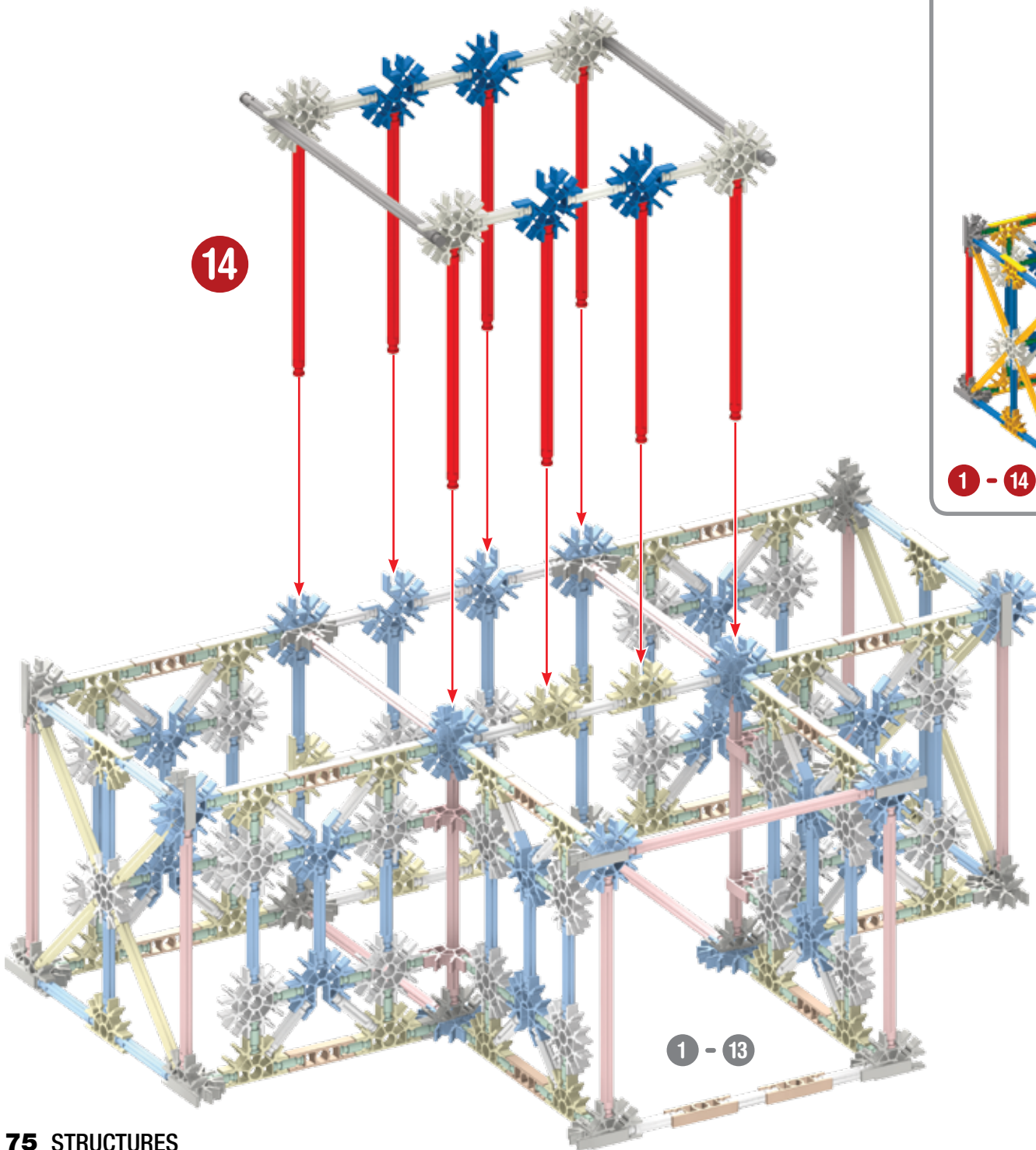

1 - 13

Palace

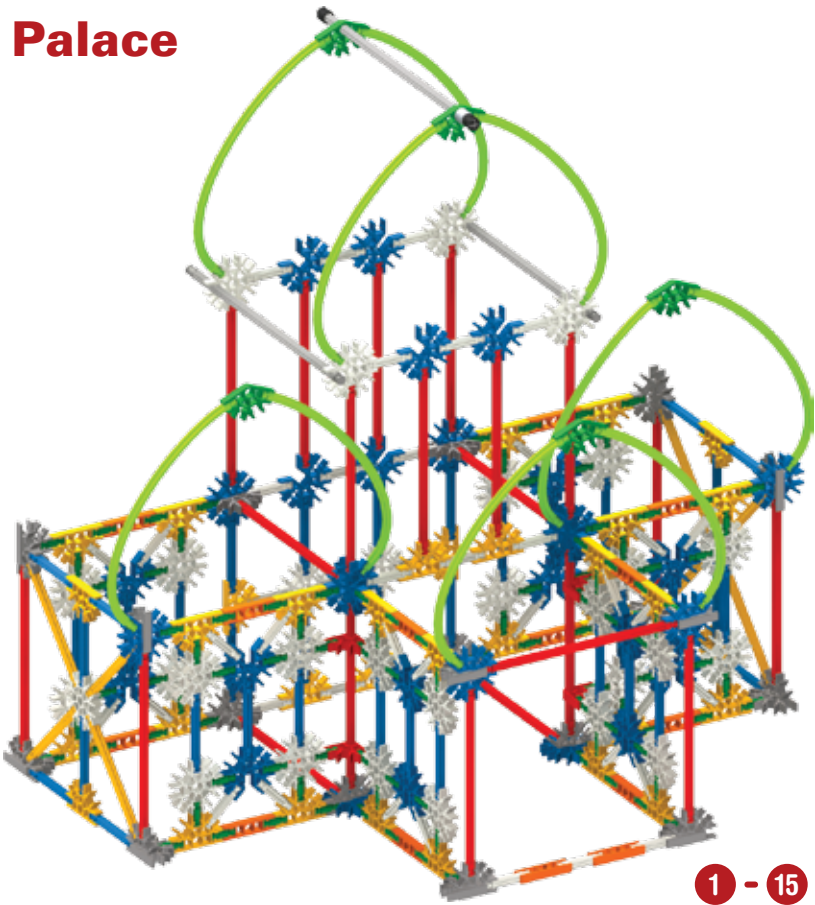

1 - 15



1 - 14

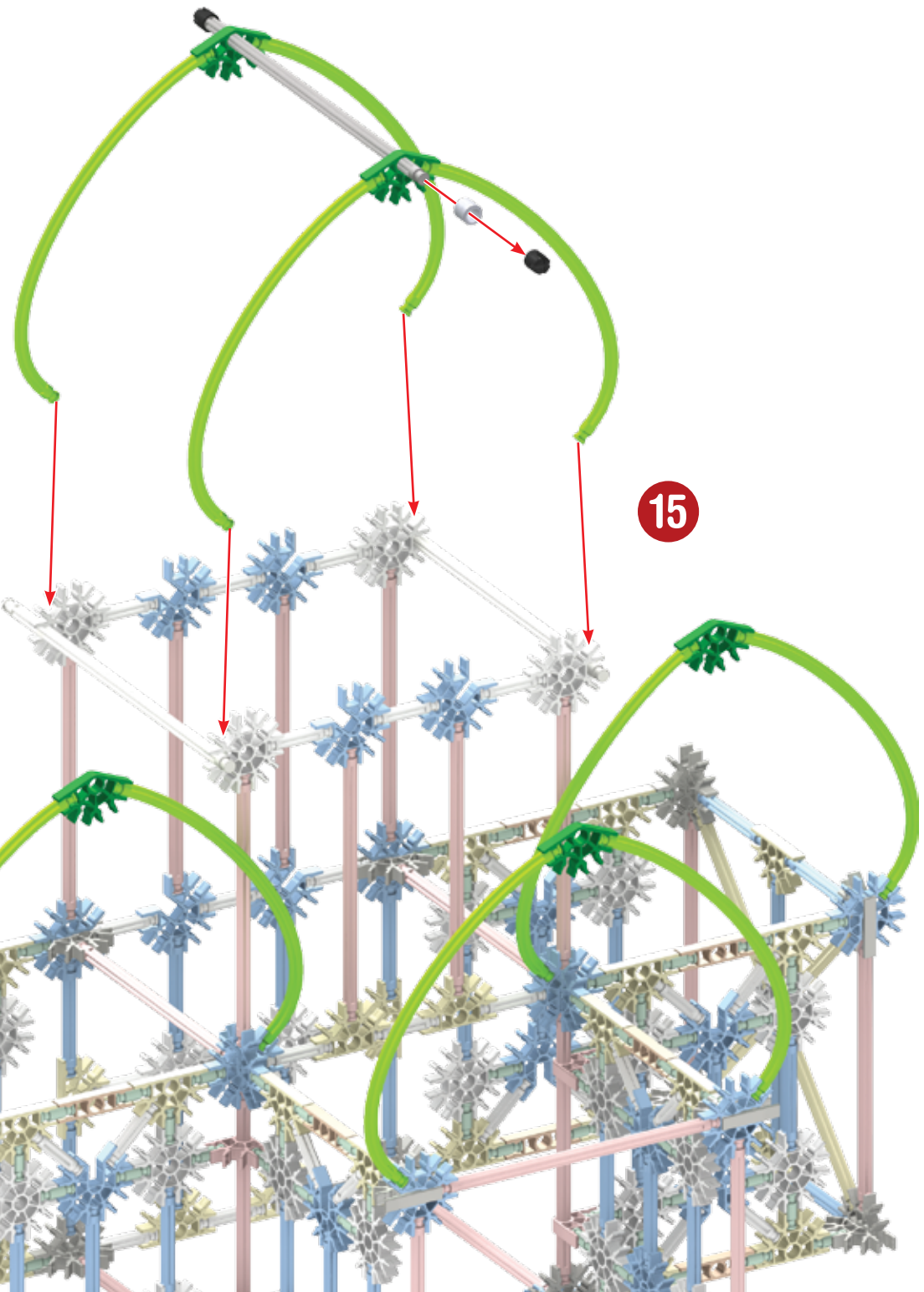

Pyramid

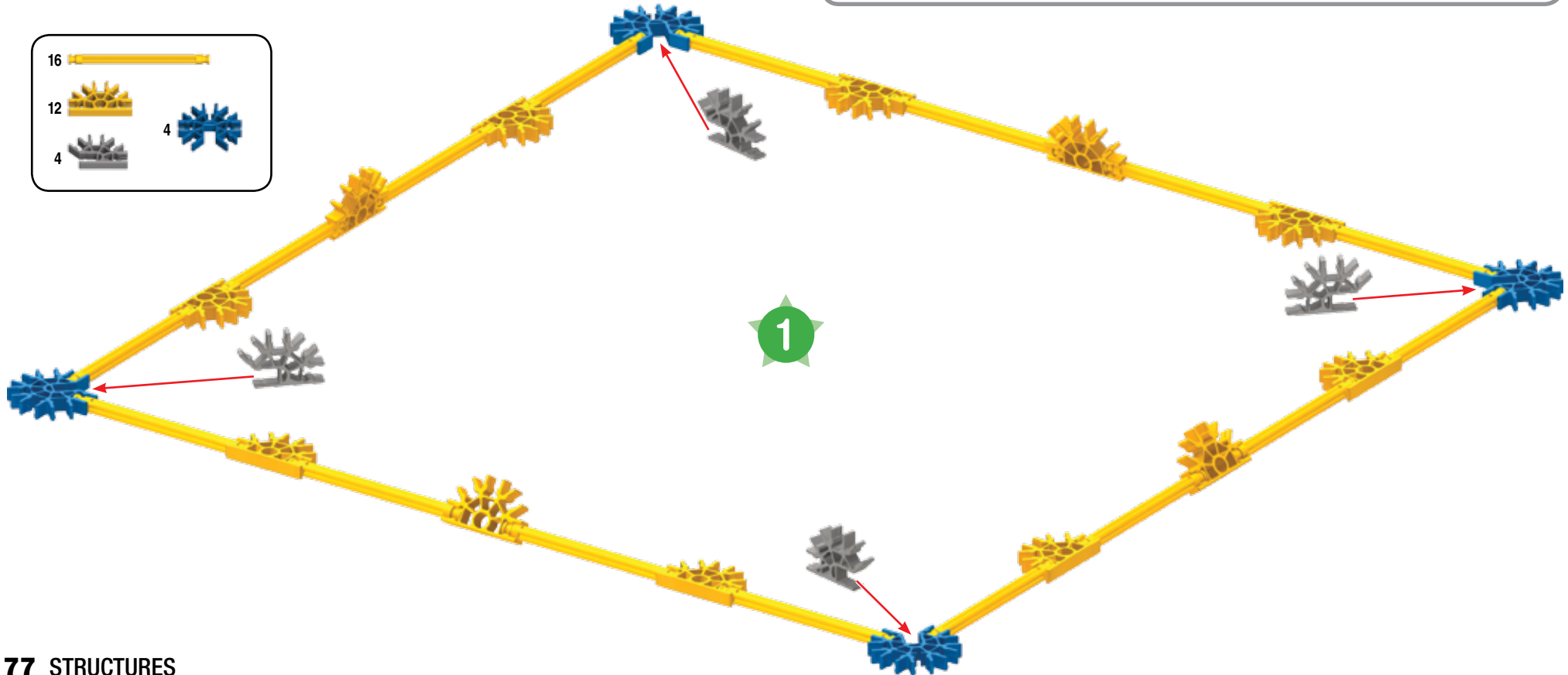
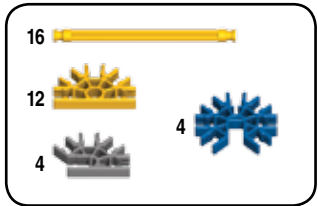
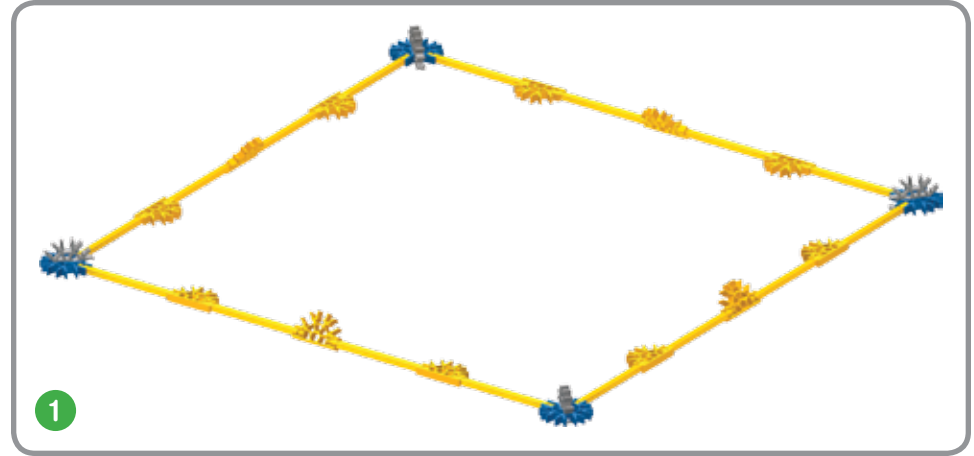
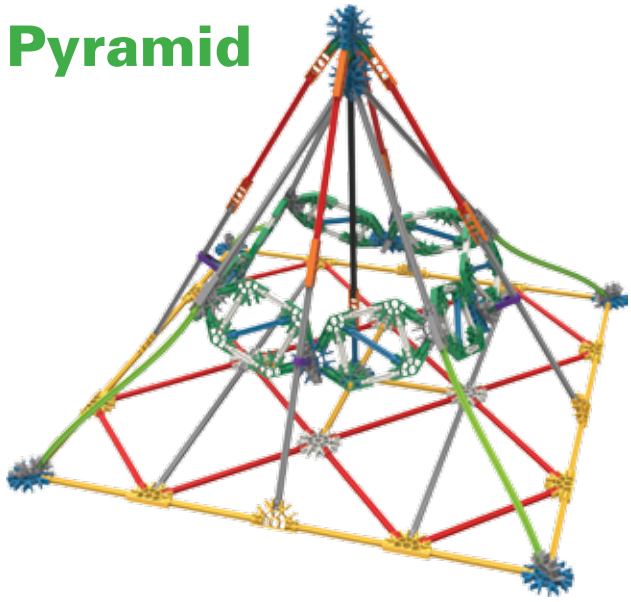

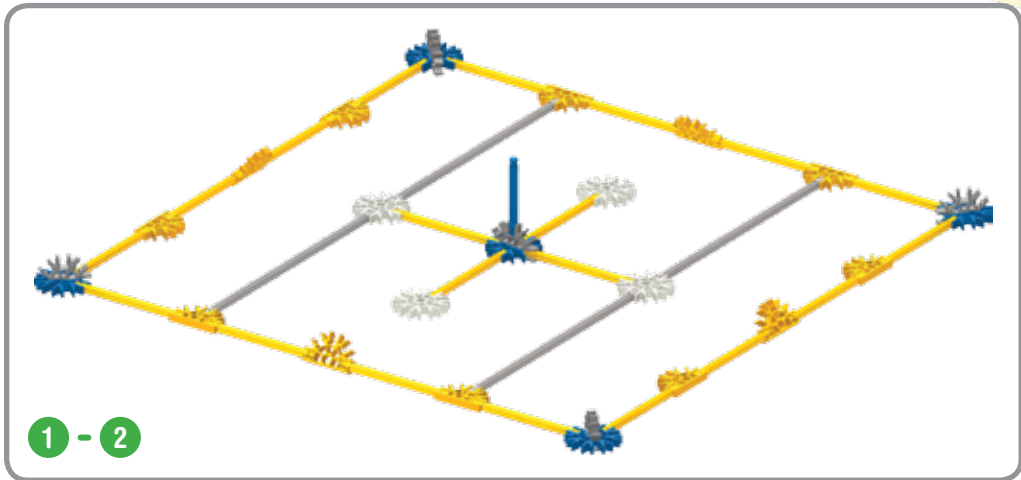
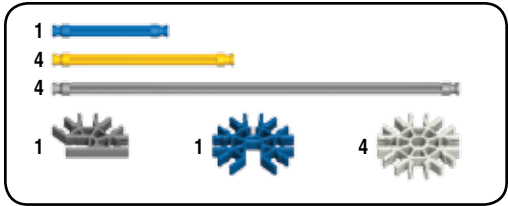
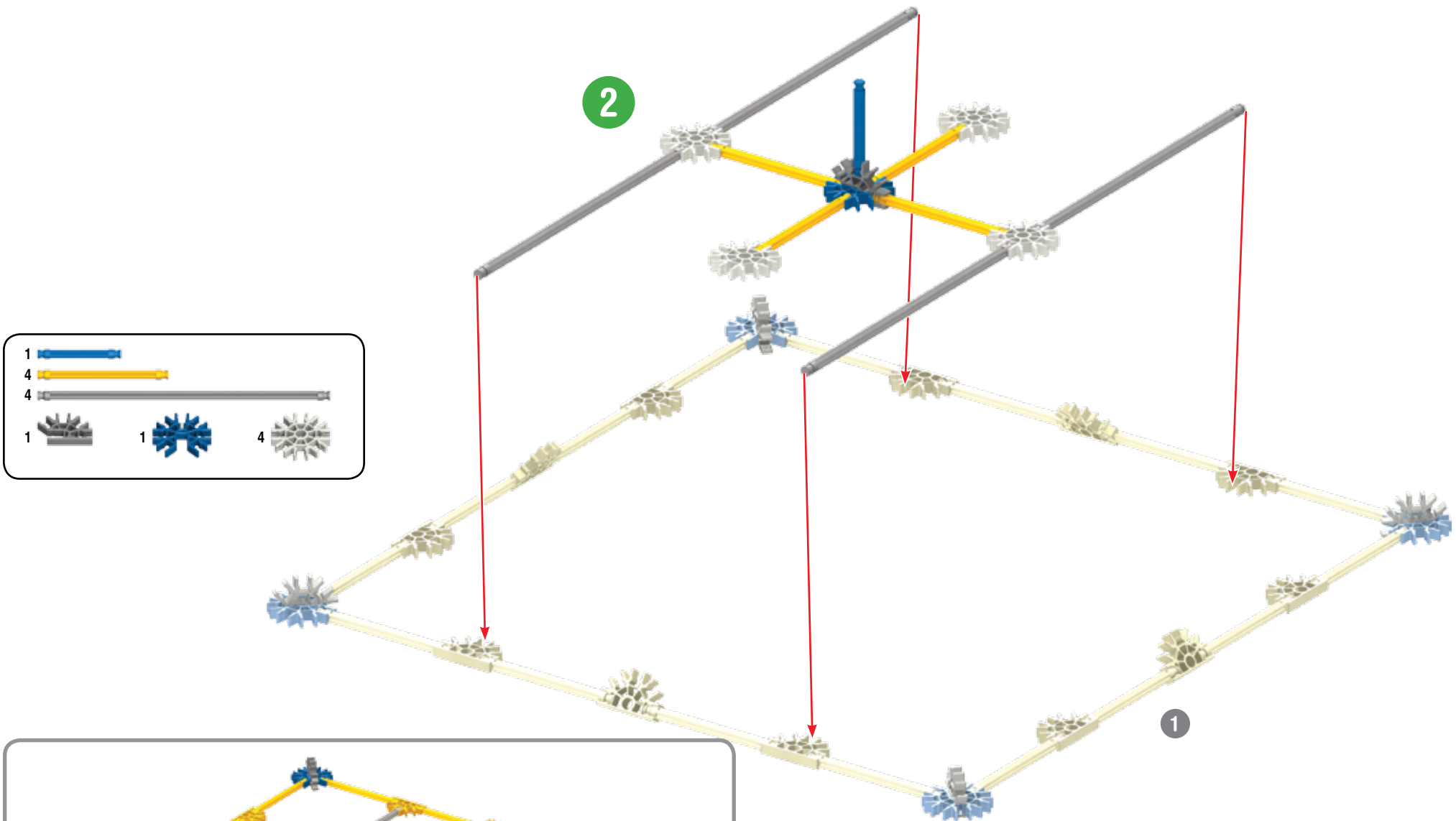

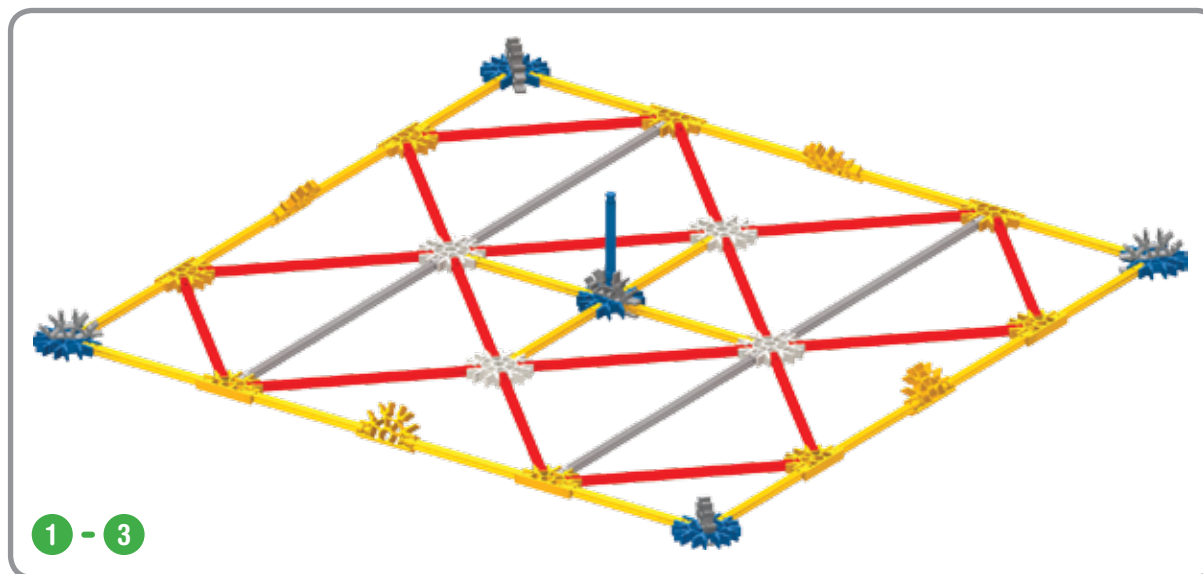
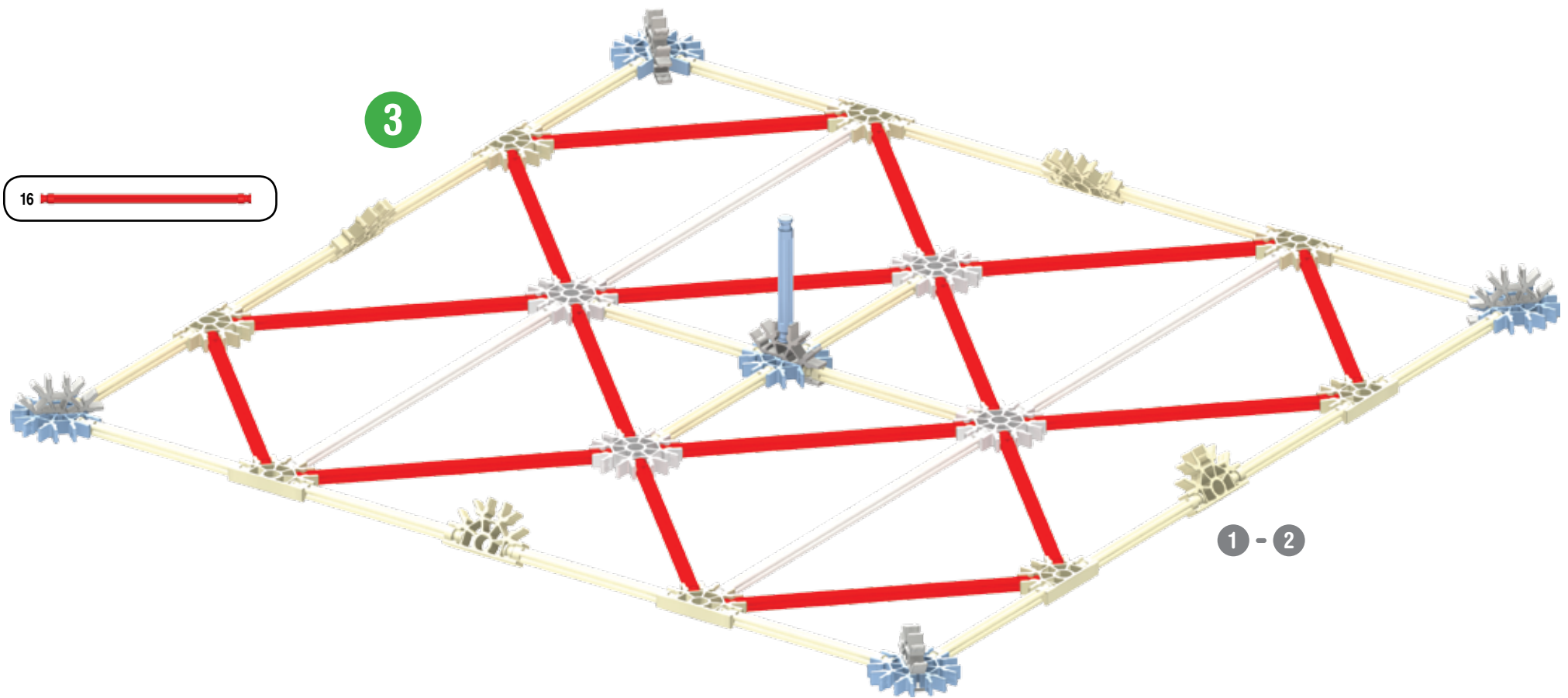

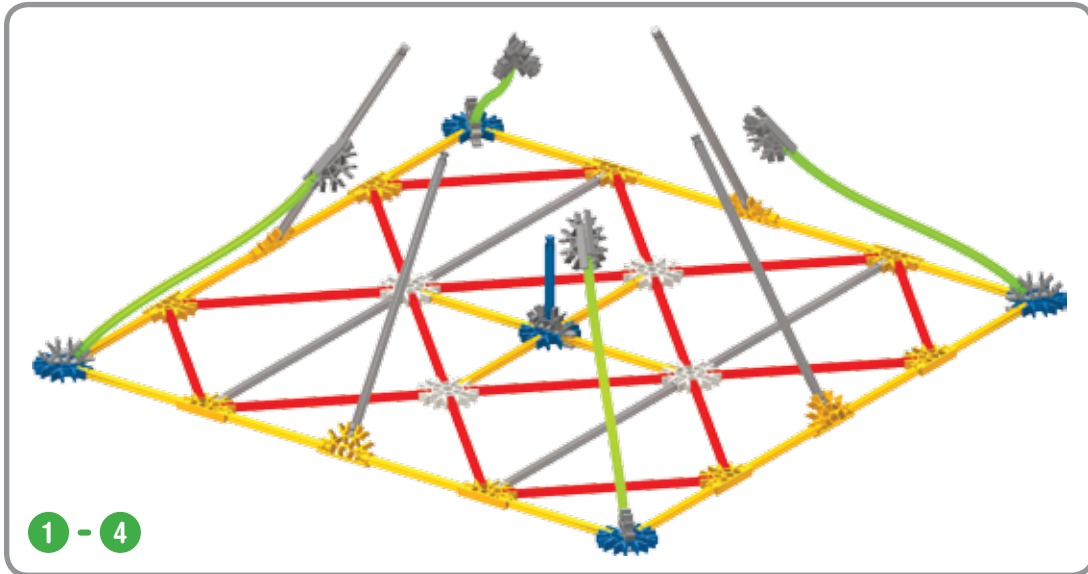
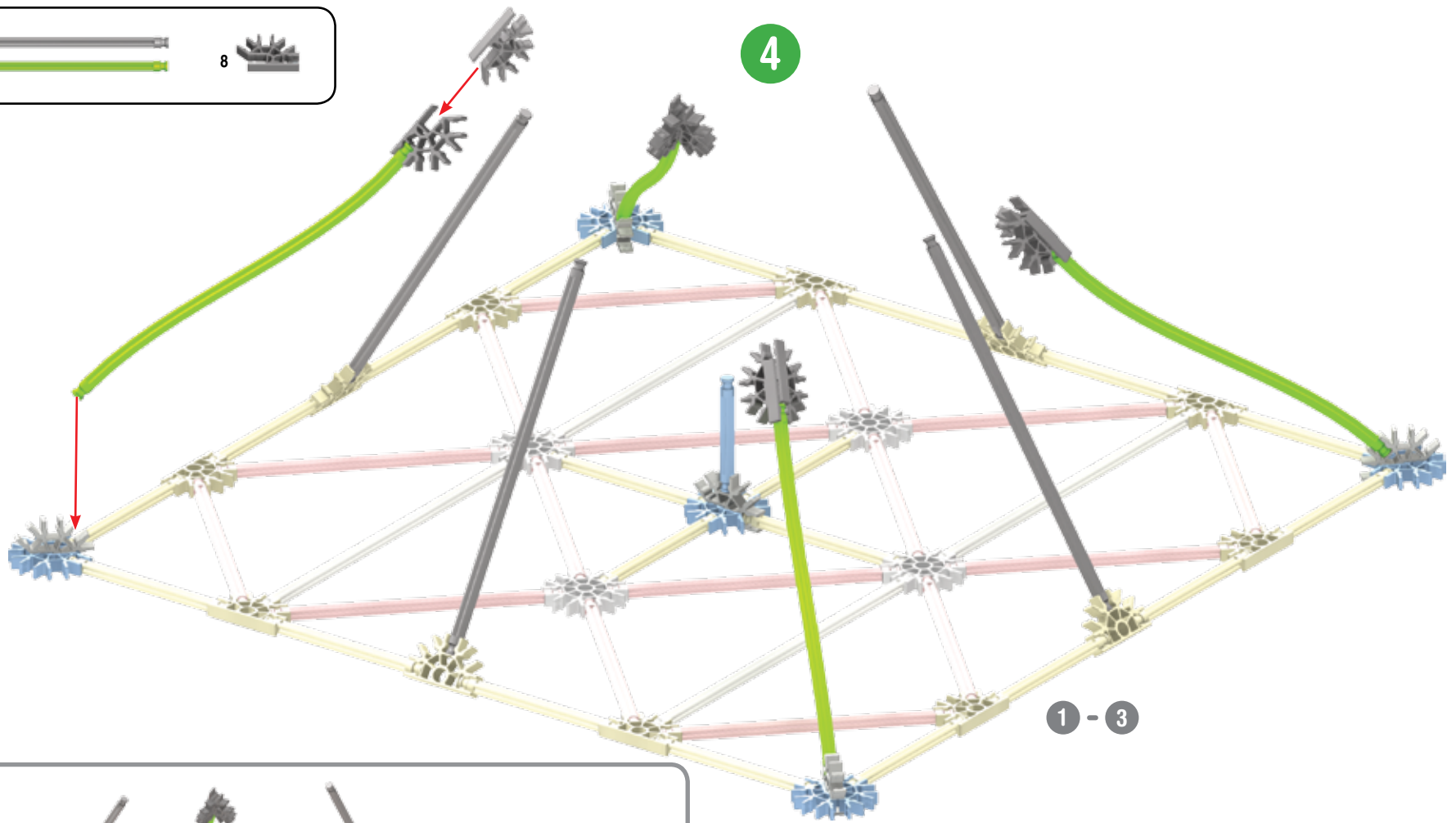

x4

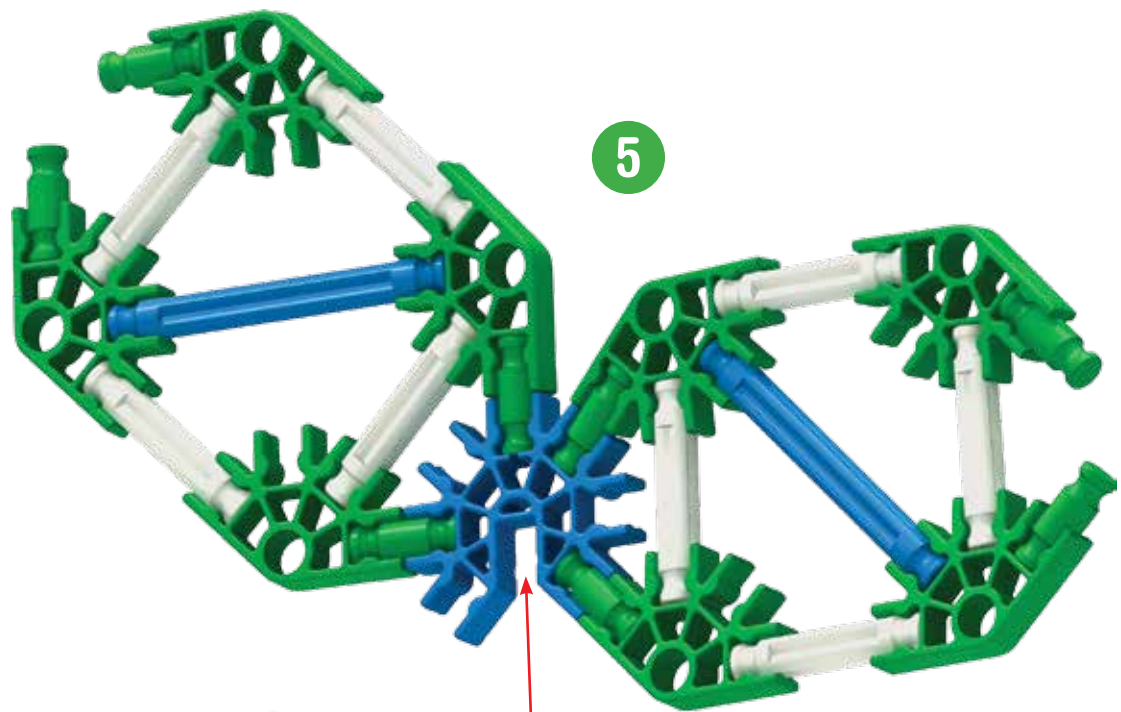

- | | | | | |
|----|--|---|--|--|
| 36 | | 4 | | |
| 32 | | | | |
| 8 | | | | |
| 32 | | 4 | | |

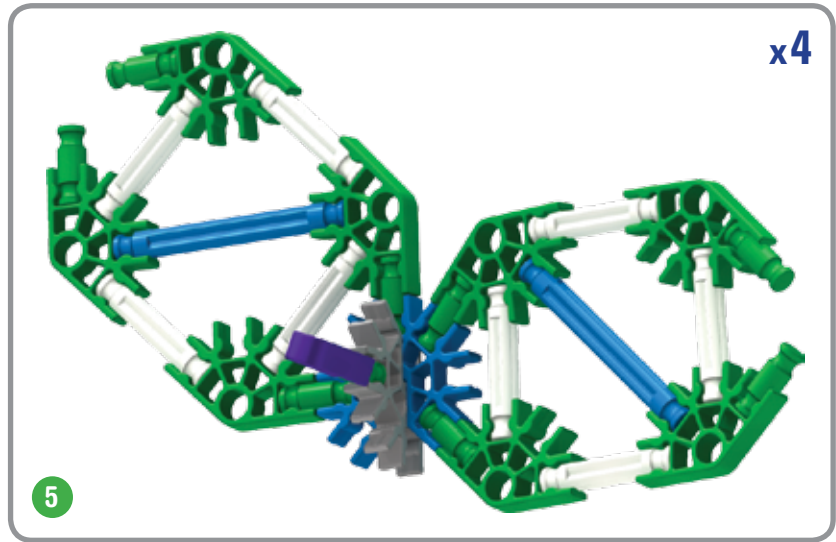
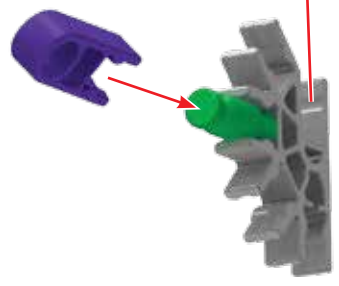

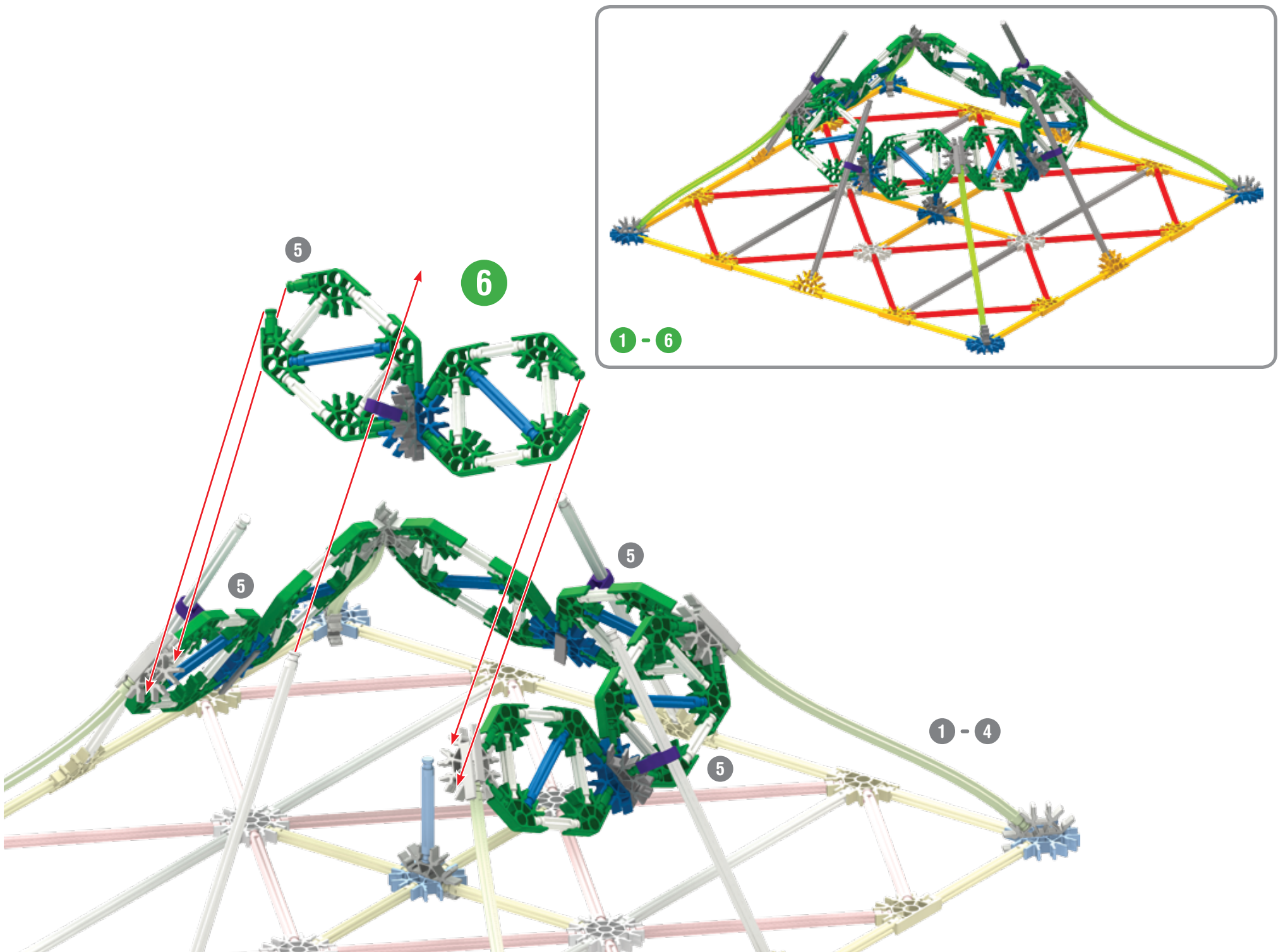

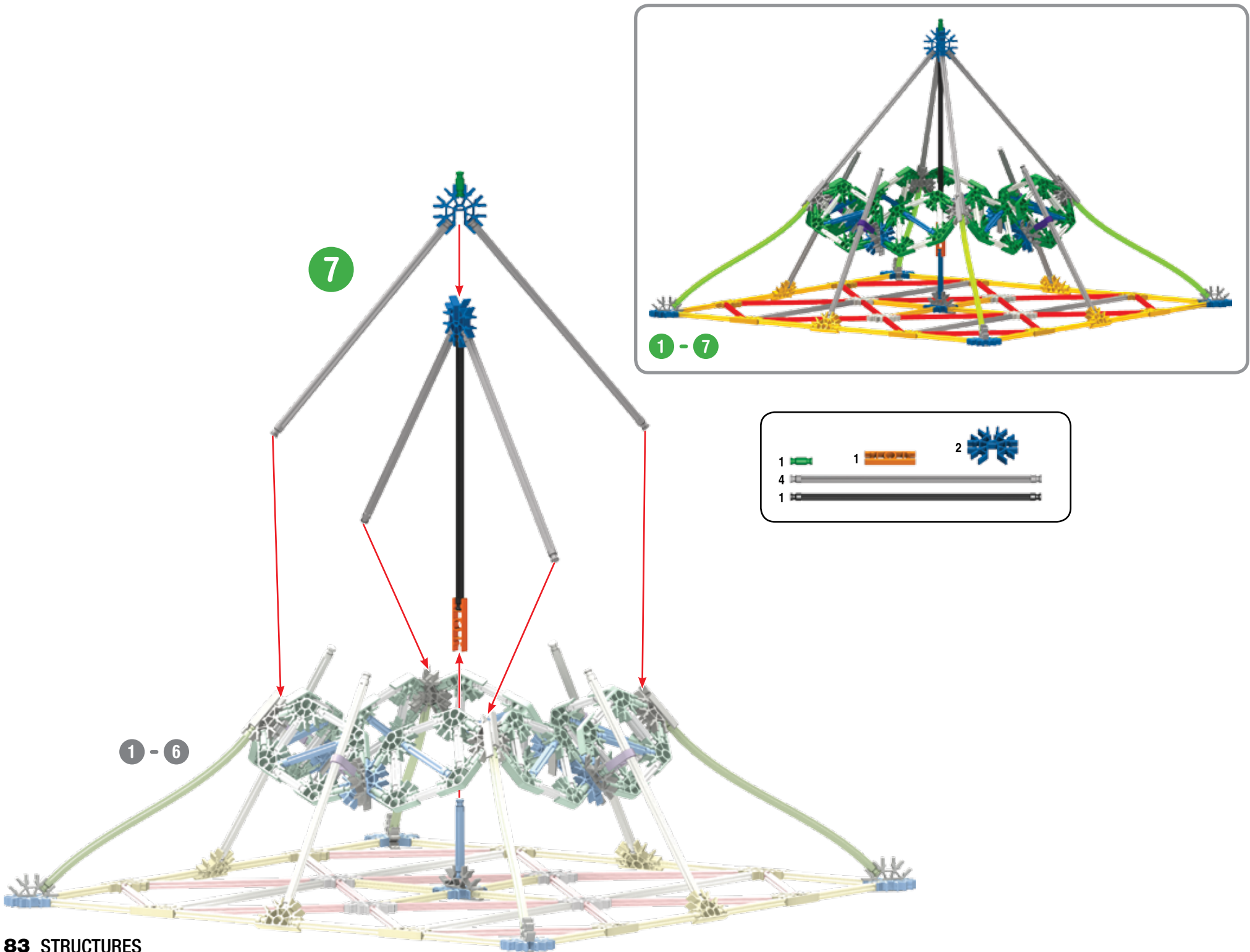





7

1 - 7

1 - 6

- 1 
- 1 
- 2 
- 4 
- 1 

Pyramid

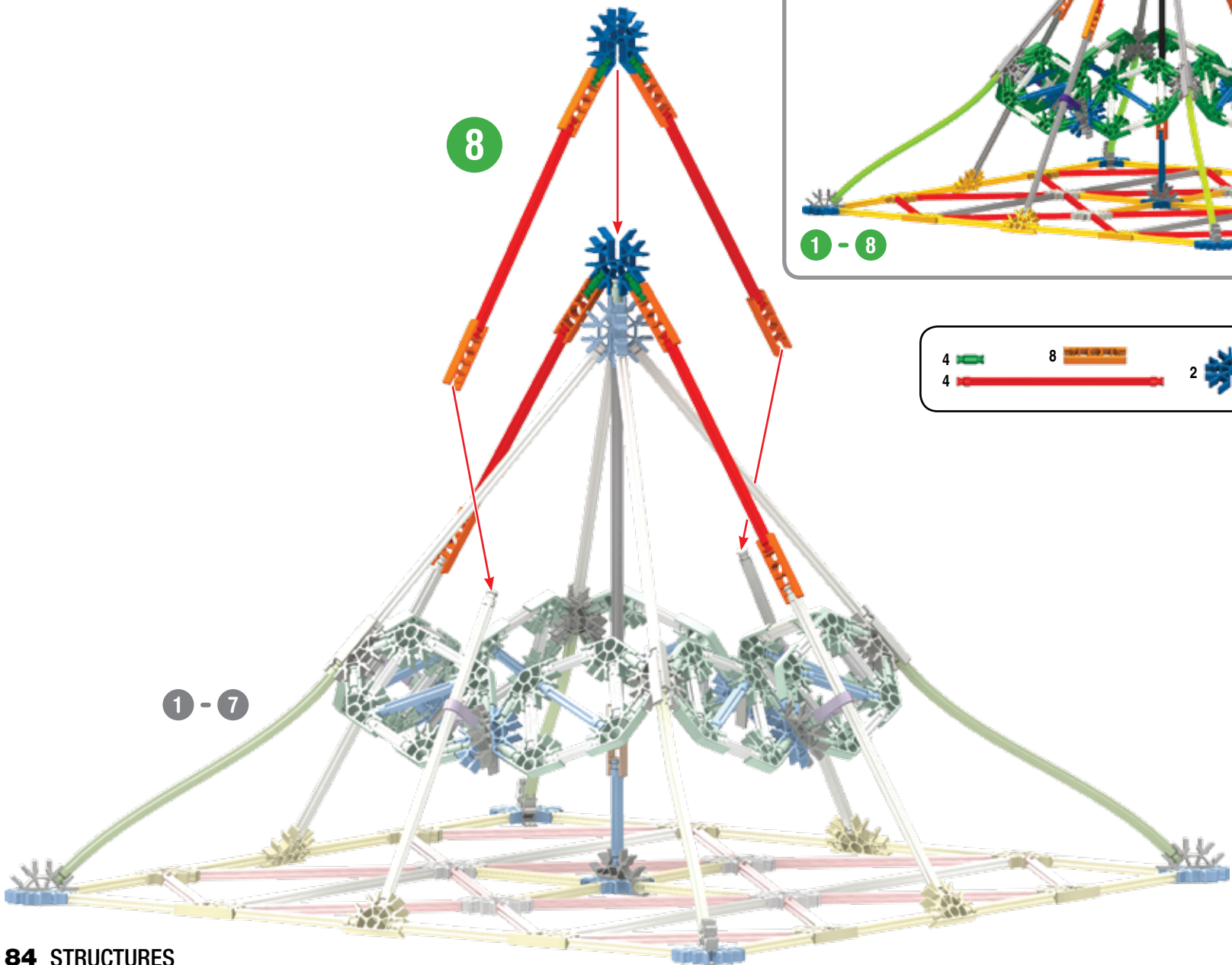
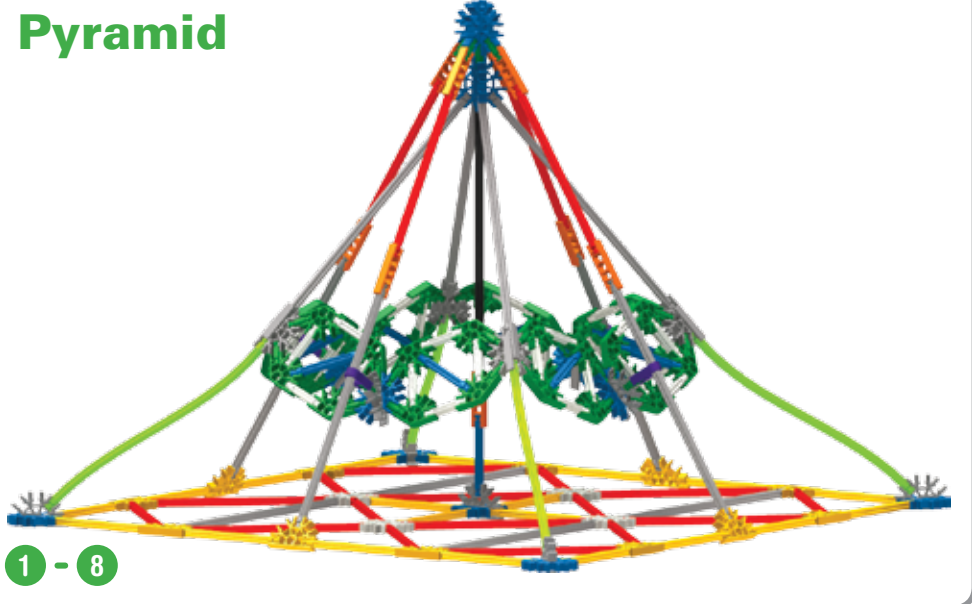

4		8		2	
4					

Treehouse

x2

8		12		12	
16					
4					

1

2

x2

1 - 2

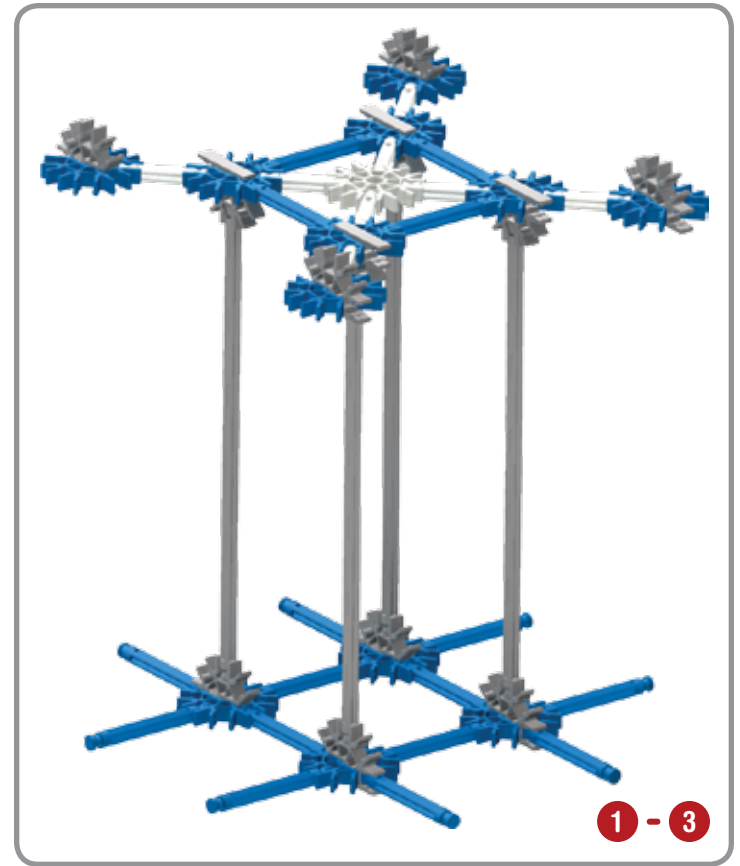
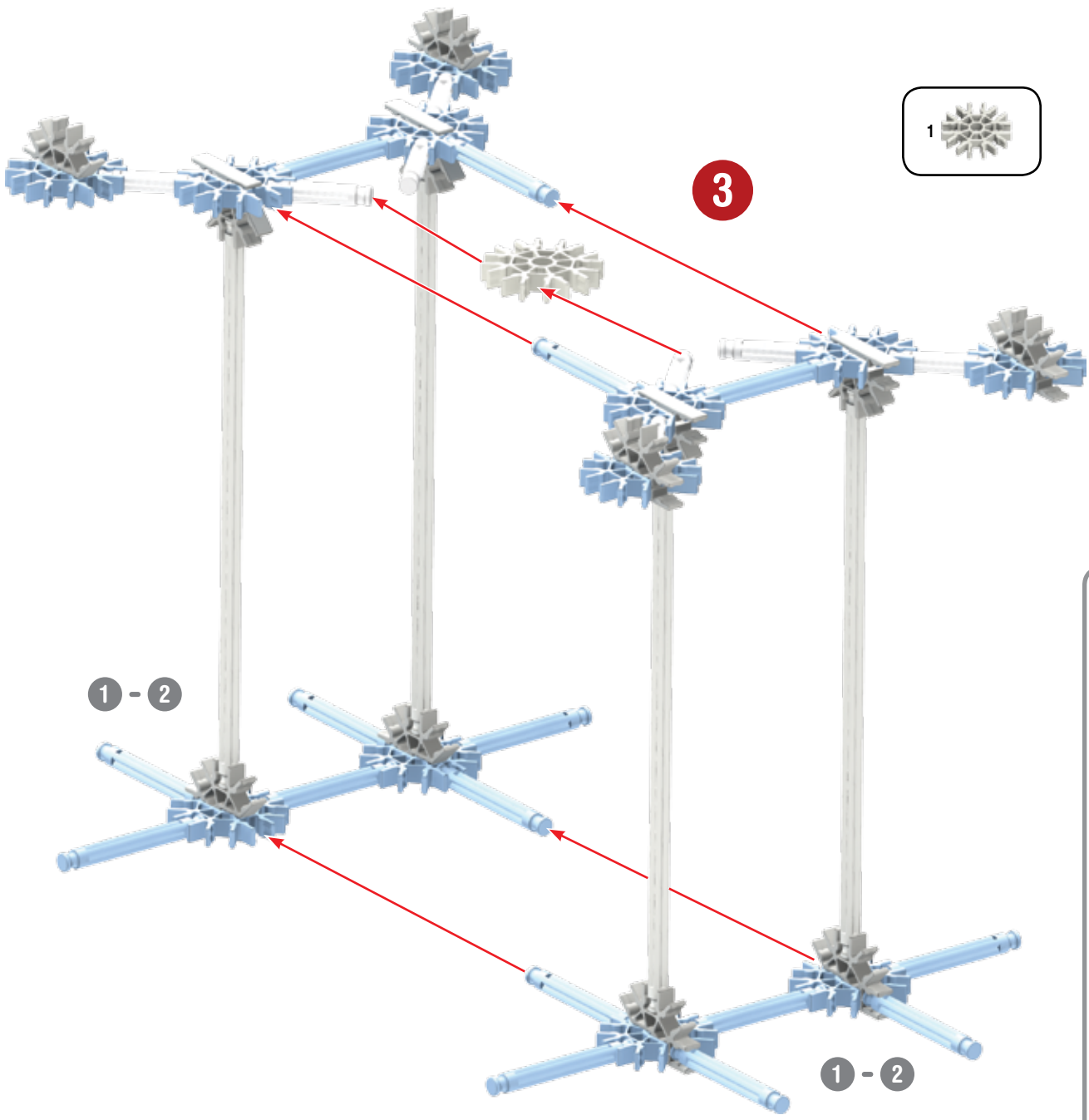

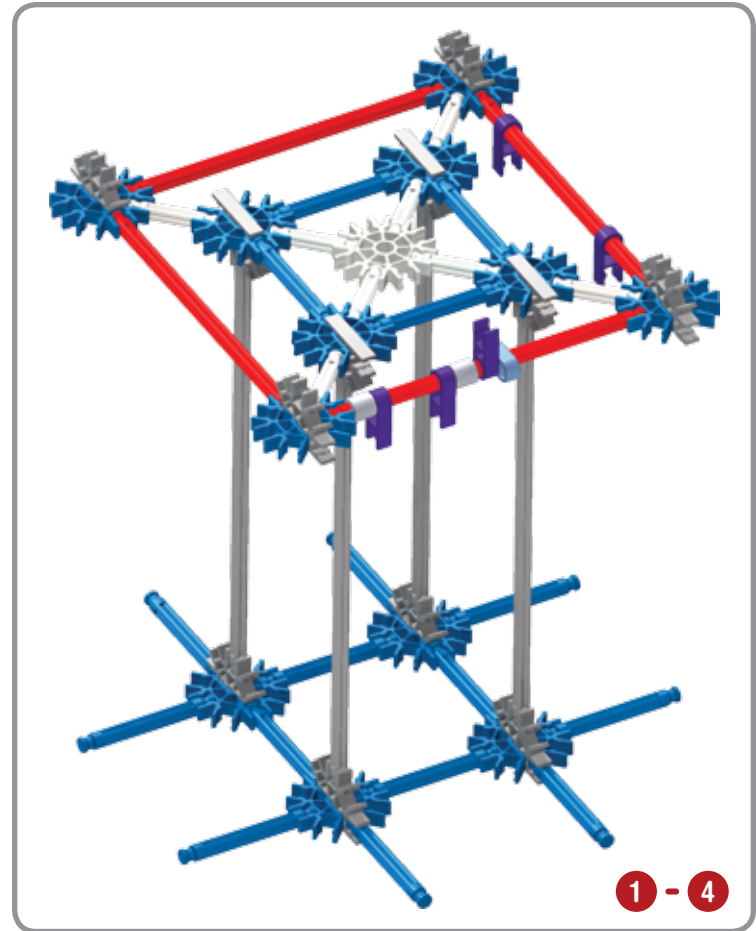
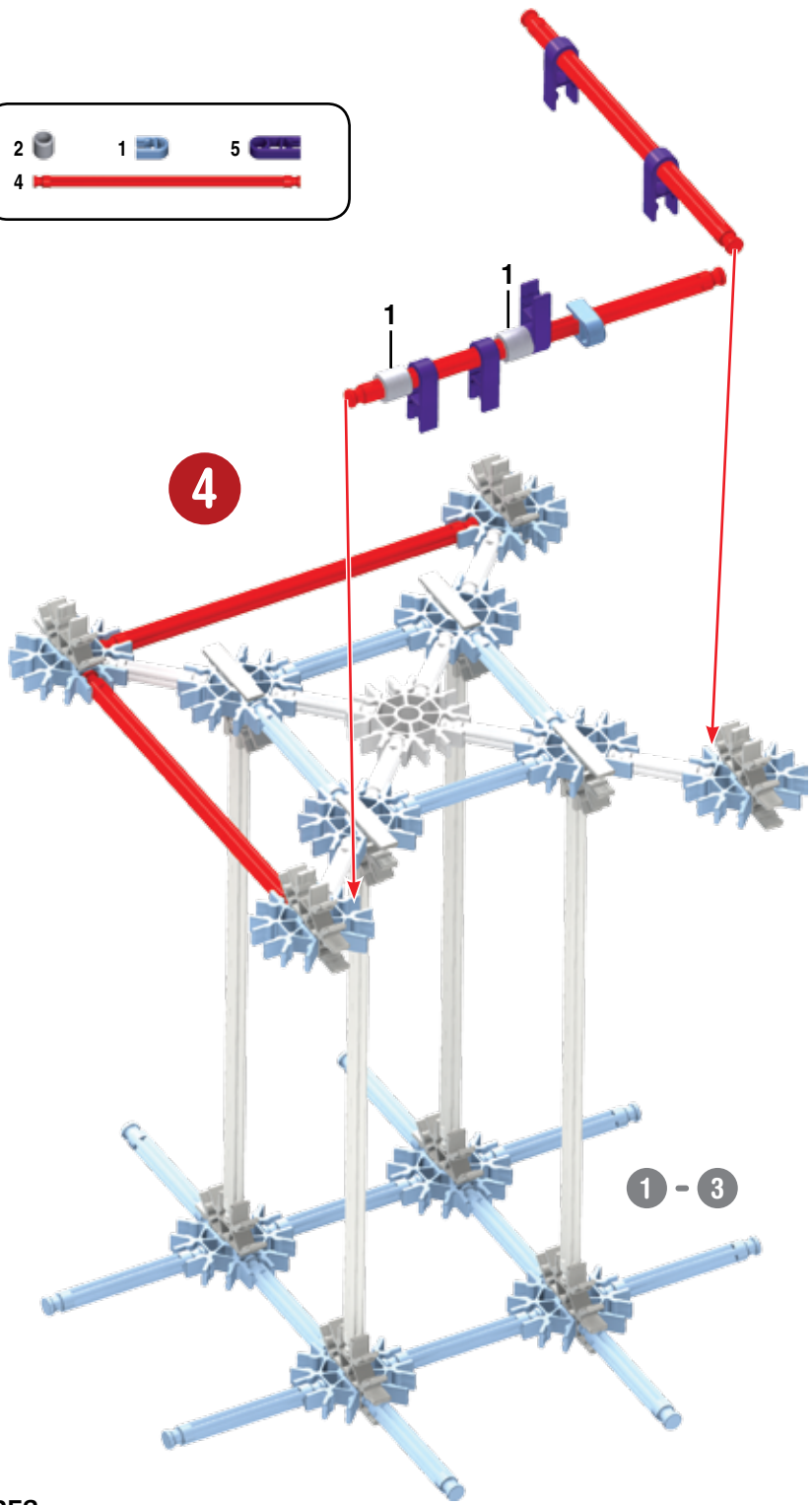
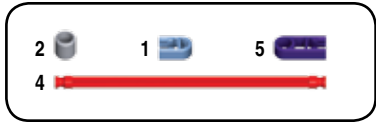

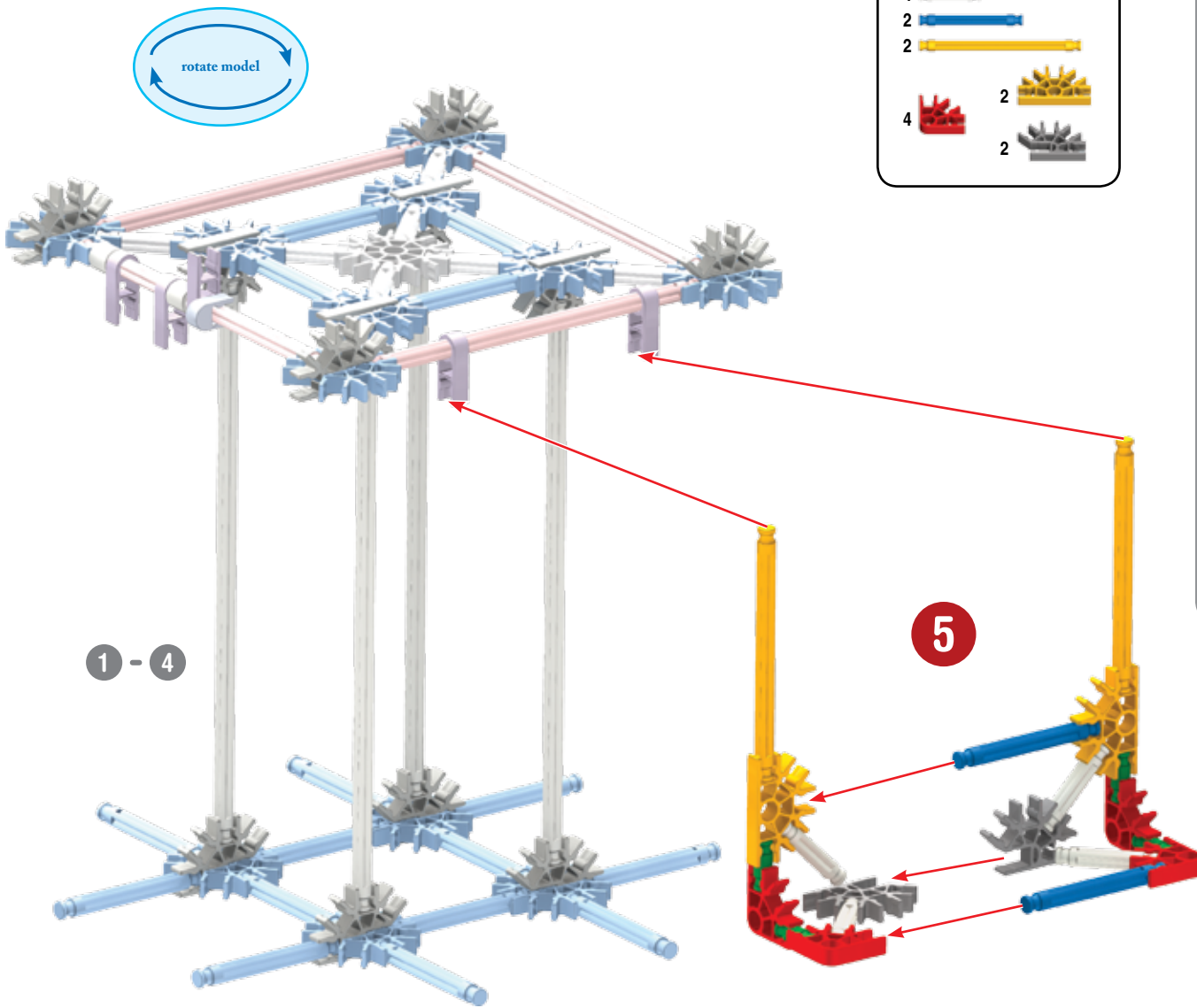

- | | |
|---|--|
| 4 | |
| 4 | |
| 2 | |
| 2 | |
| 4 | |
| 2 | |
| 2 | |

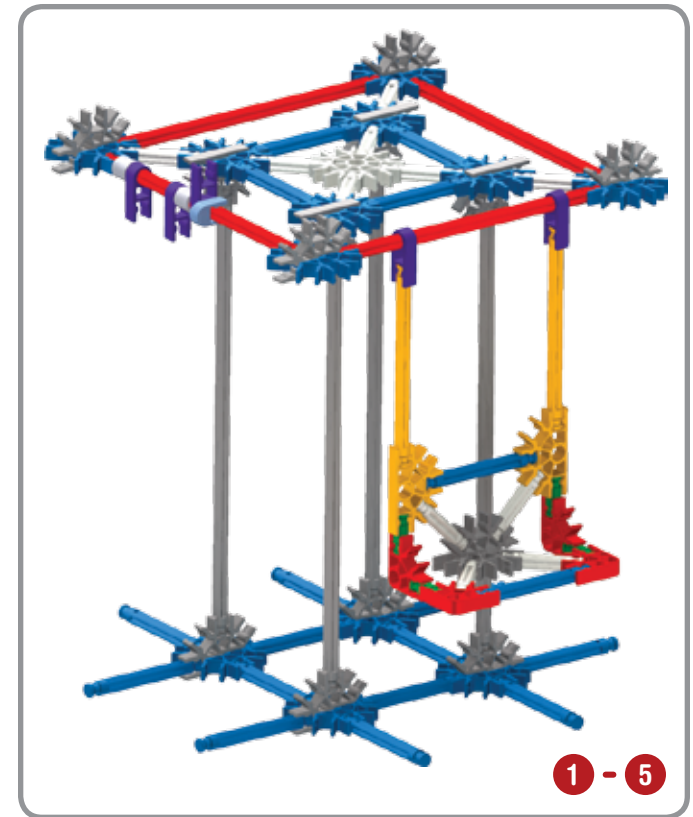

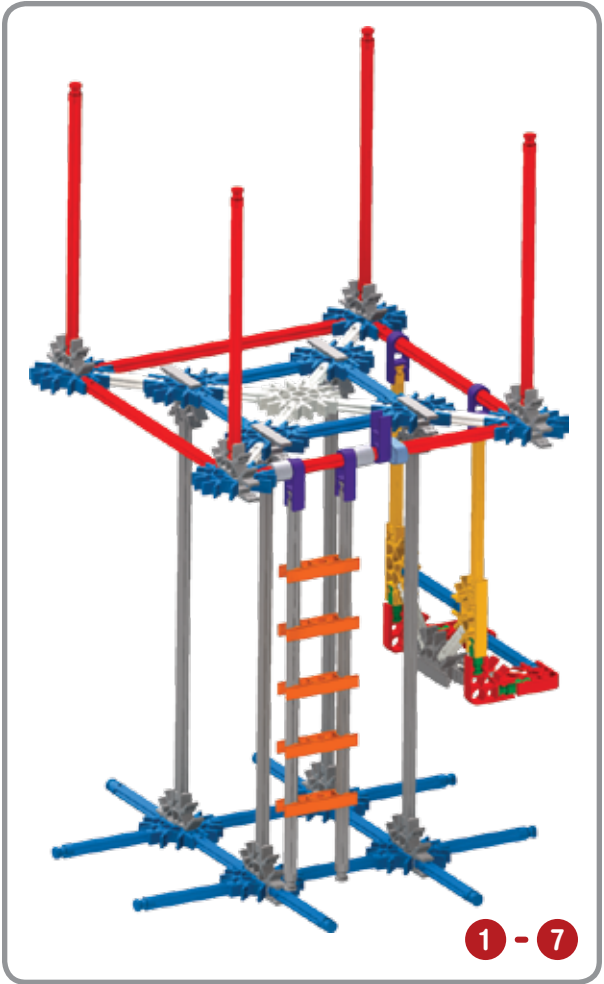
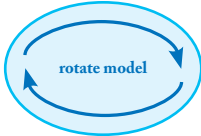
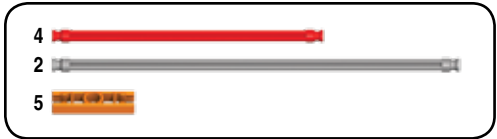
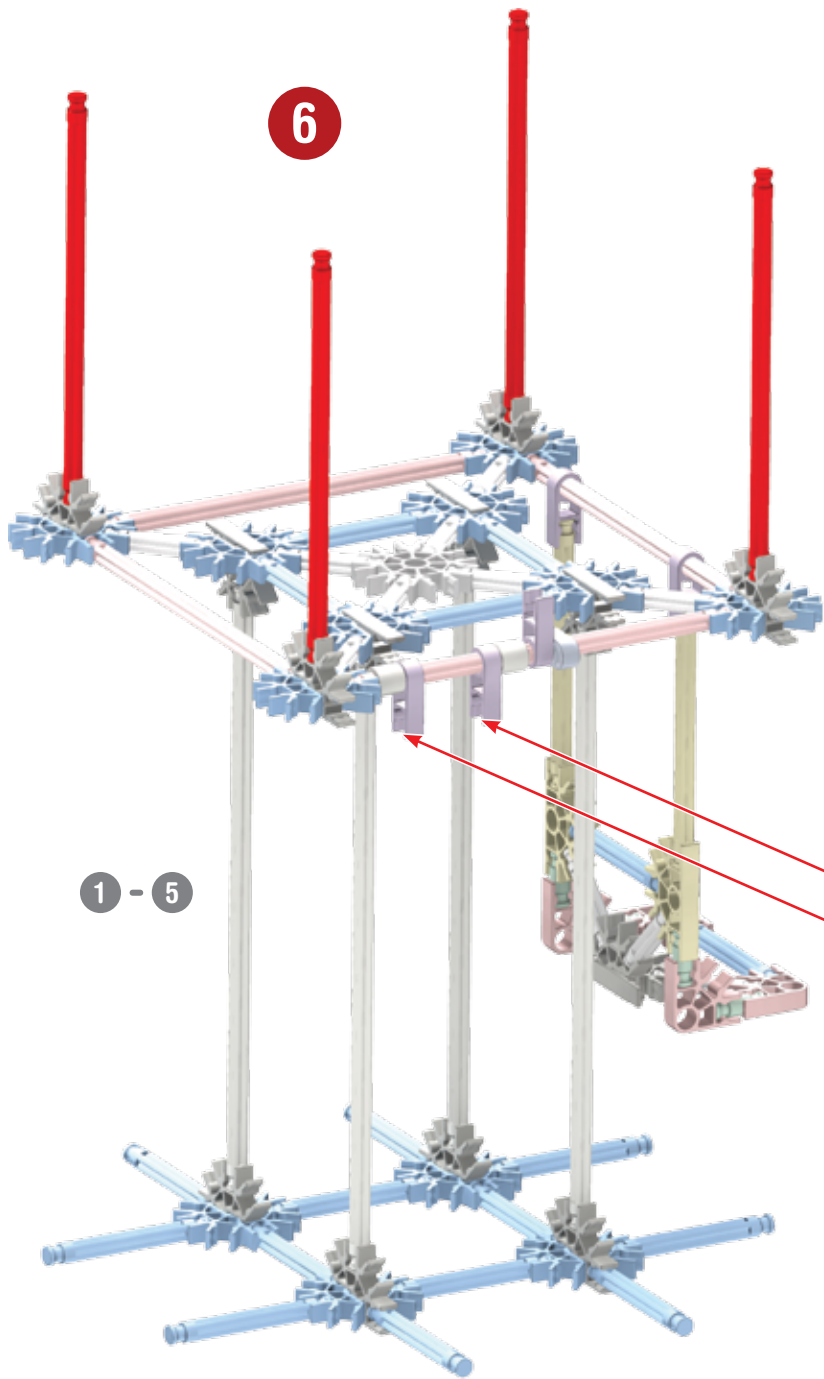

8



1 - 7

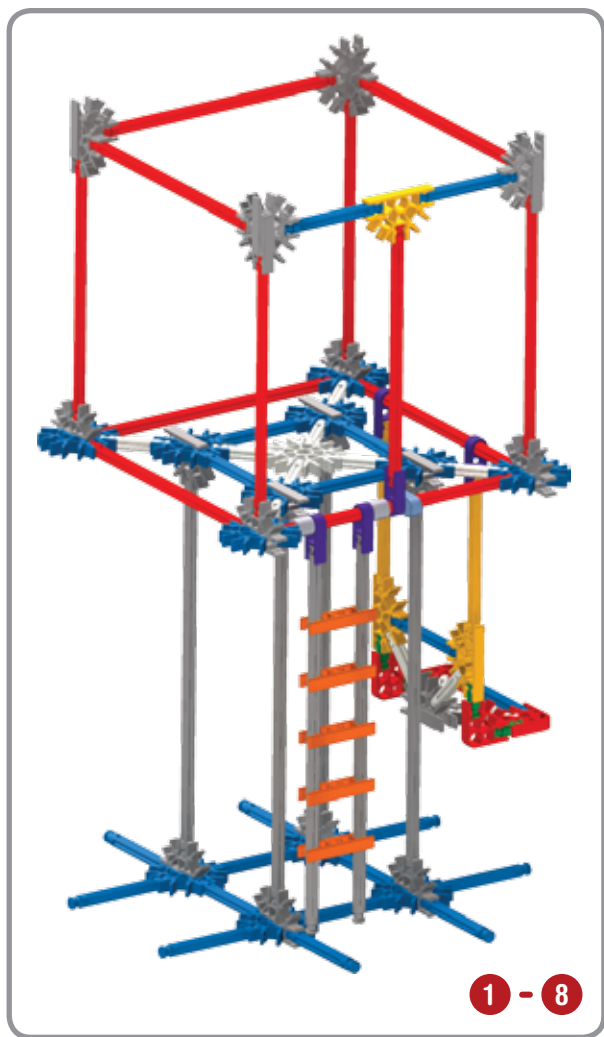
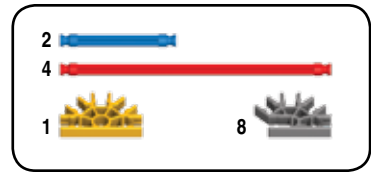

1 - 8

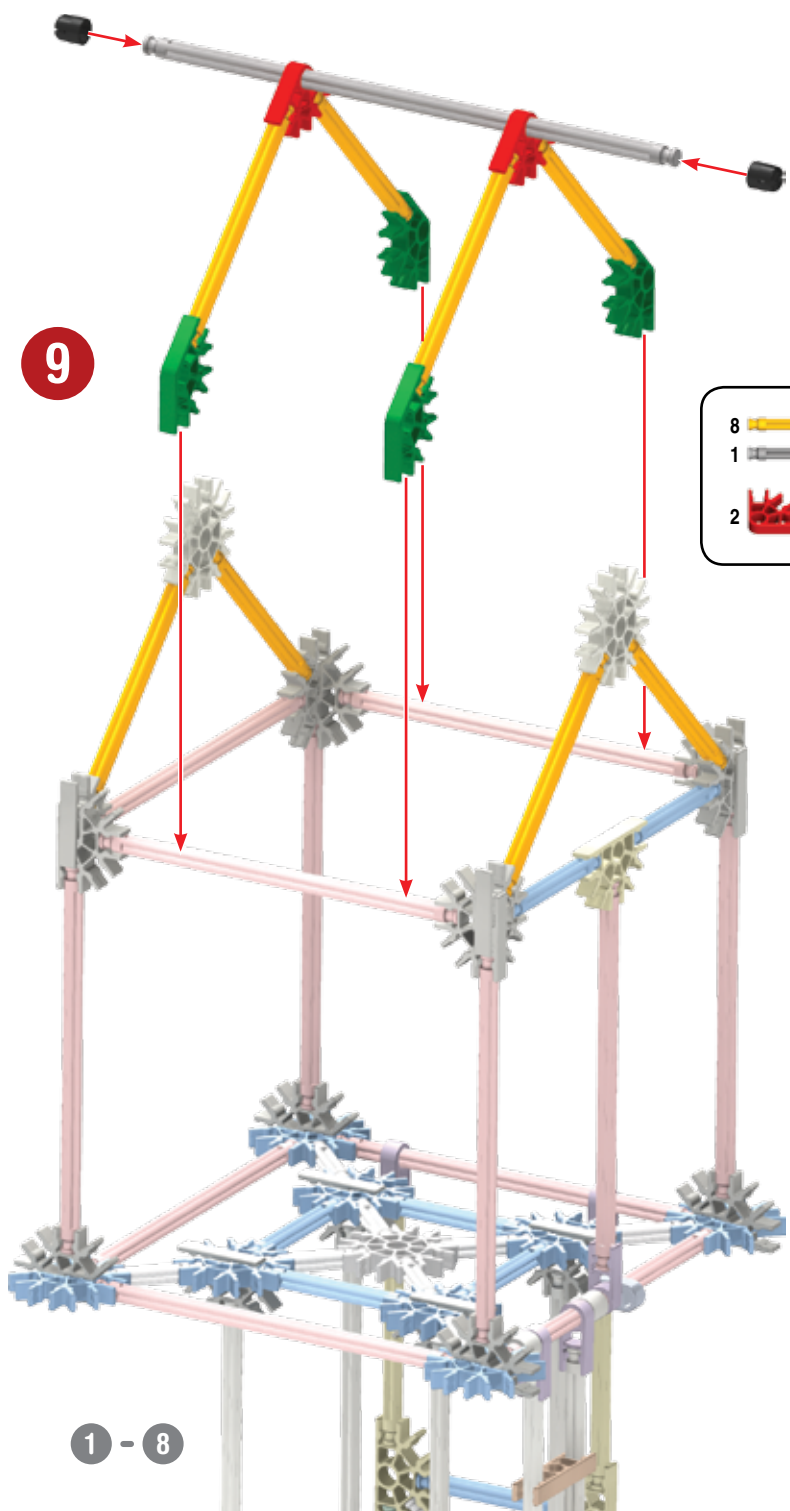

x3

- | | | | |
|---|--|---|--|
| 8 | | 2 | |
| 1 | | | |
| 2 | | 4 | |
| | | 2 | |

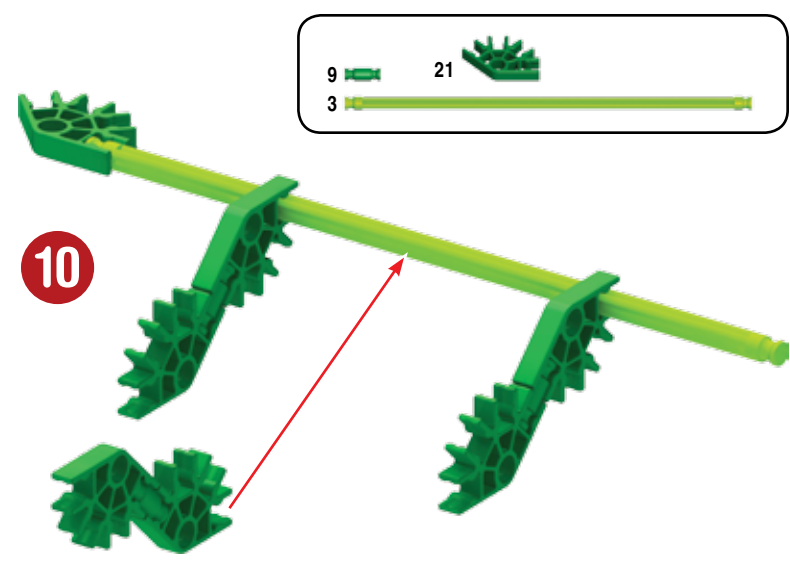

- | | | | |
|---|--|----|--|
| 9 | | 21 | |
| 3 | | | |

10

x3

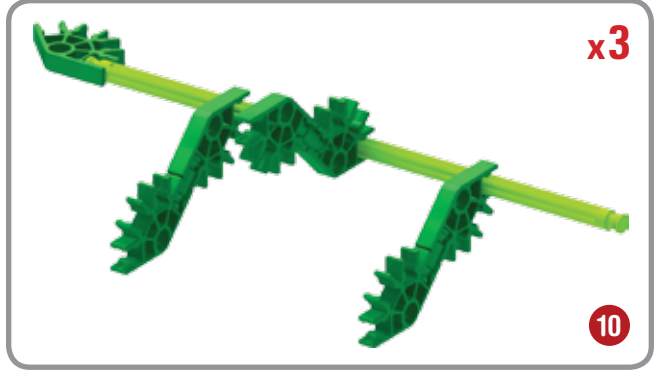

10

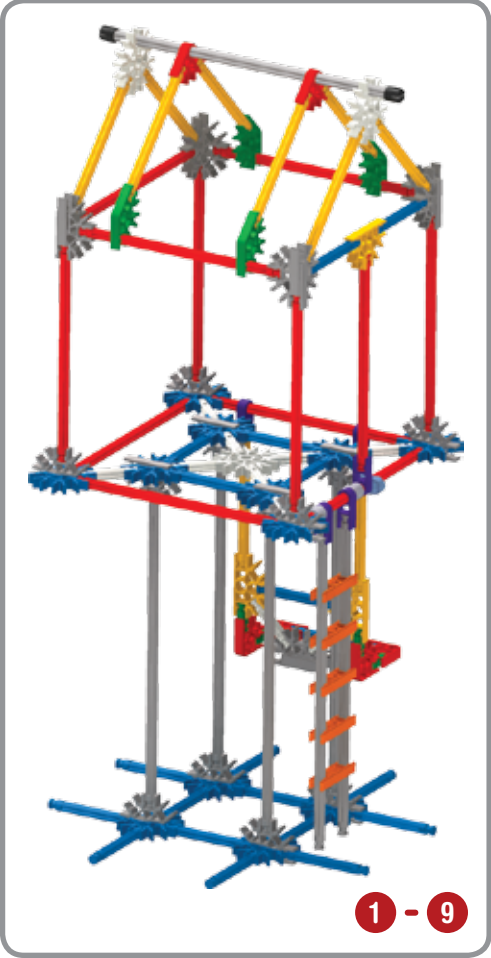

1 - 9

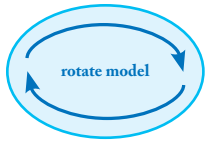

11

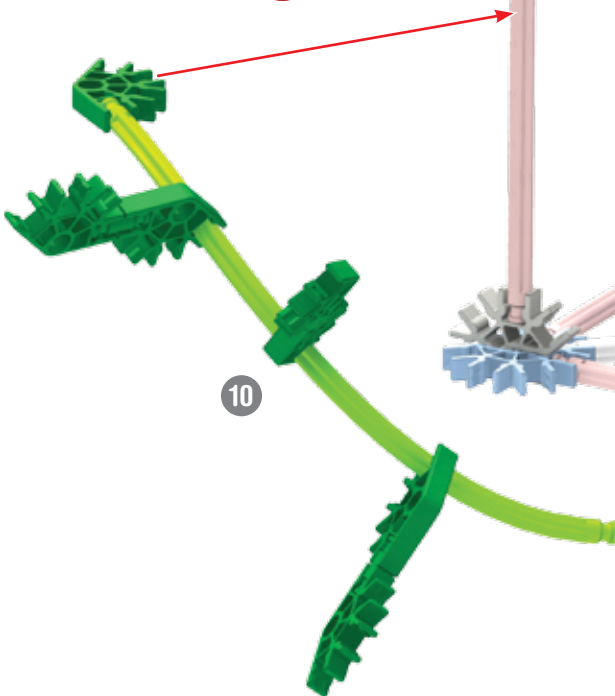

10

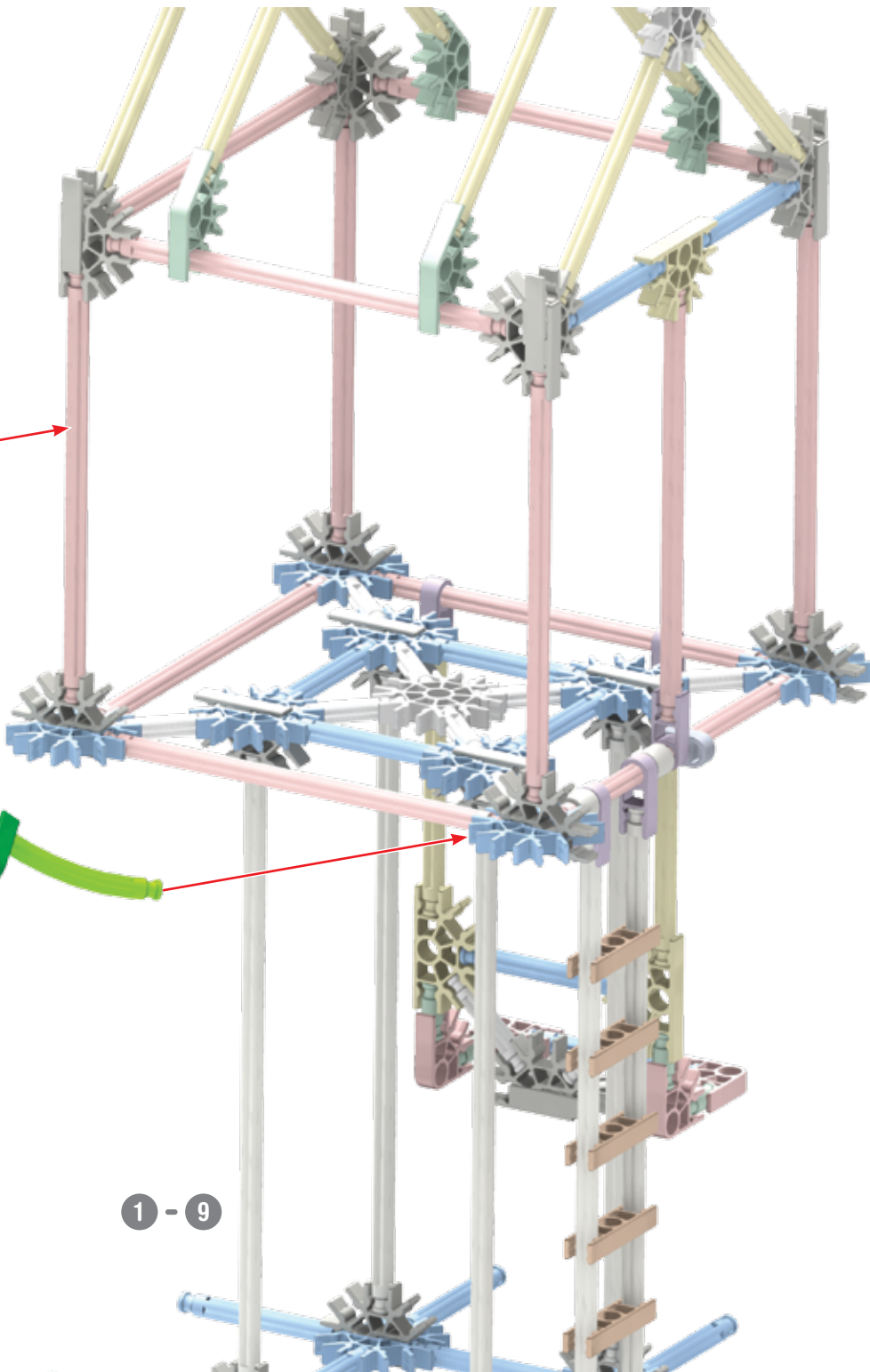

1 - 9

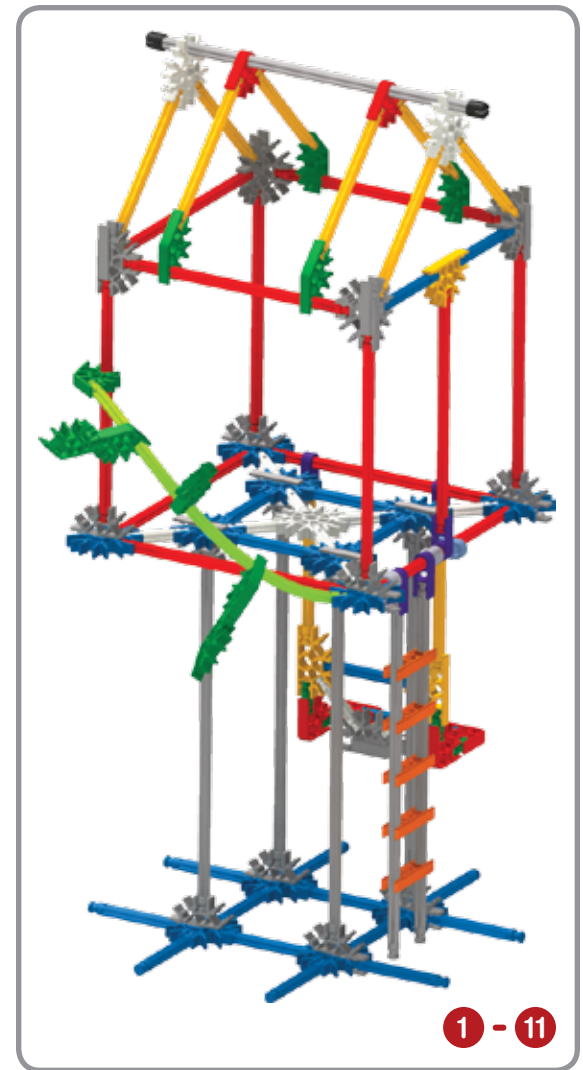

1 - 11

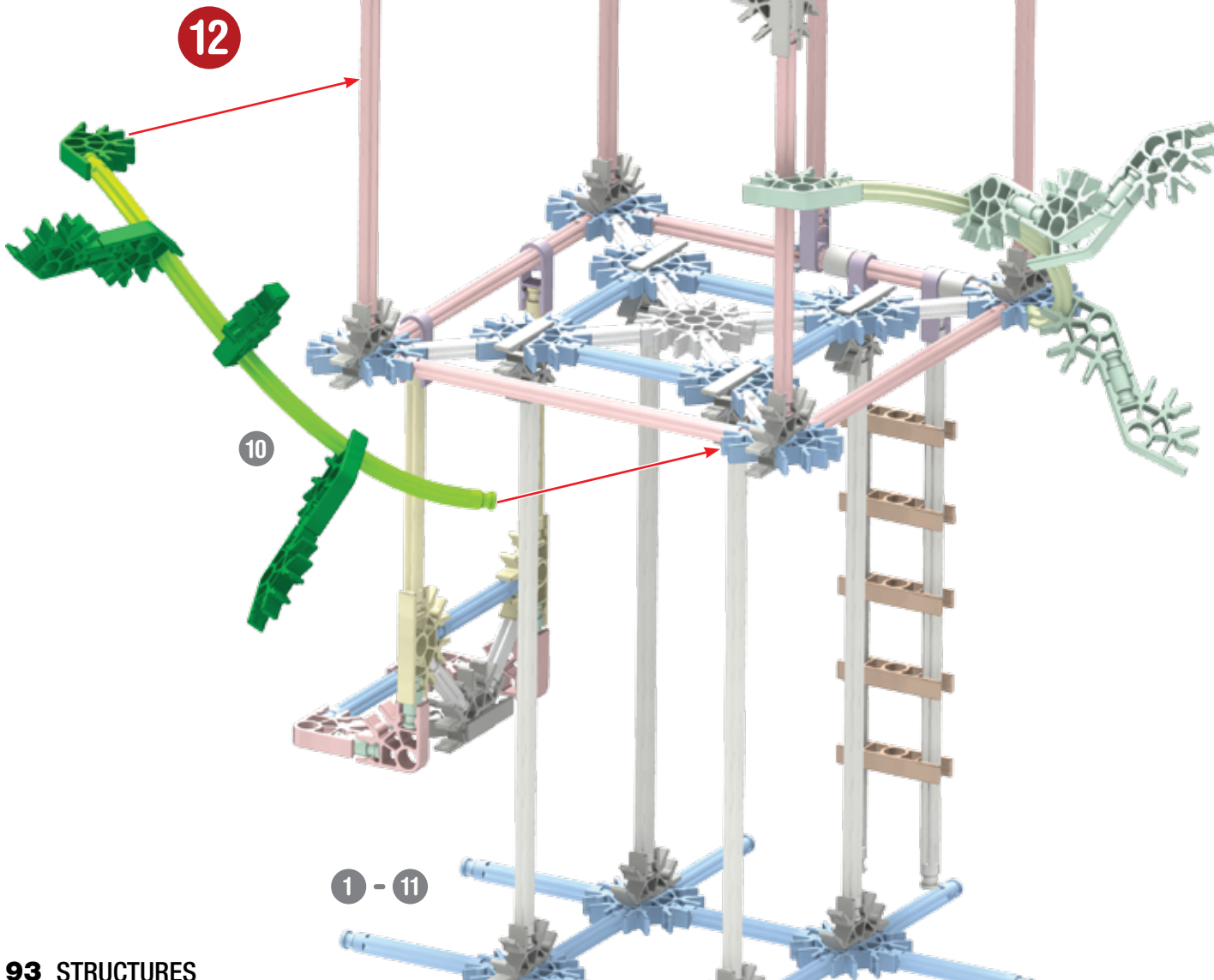
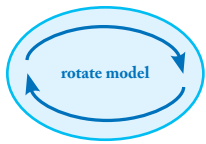

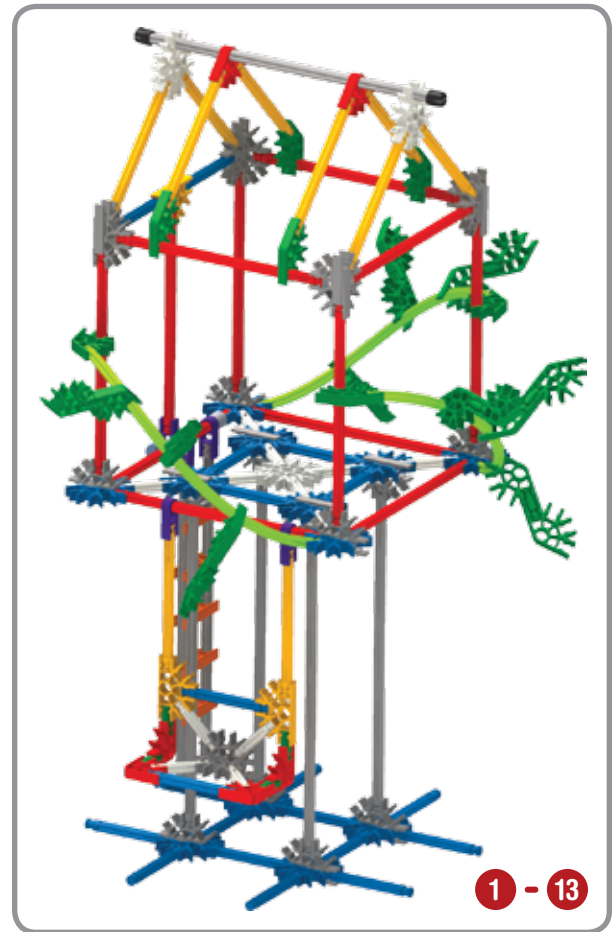
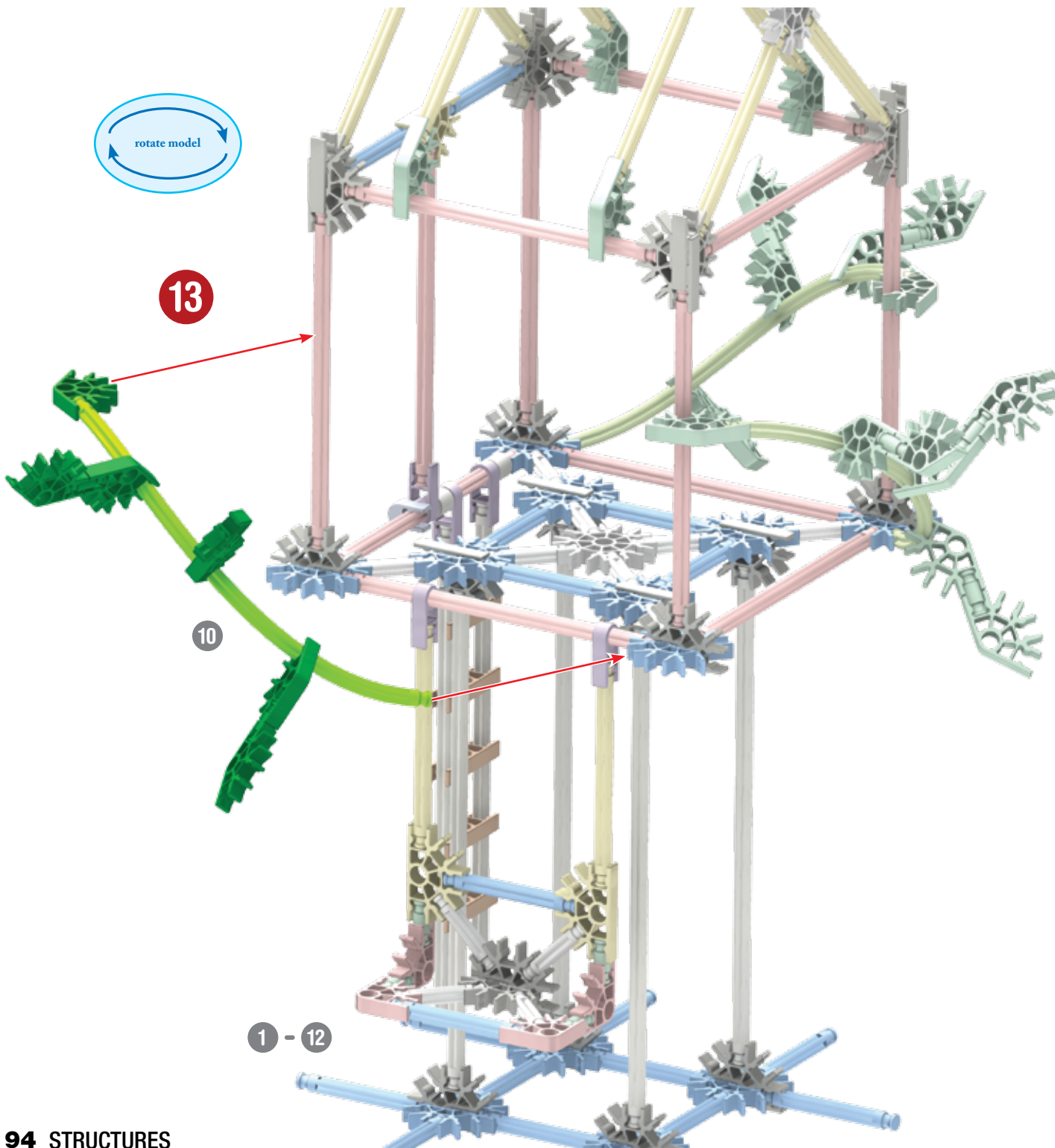

x4

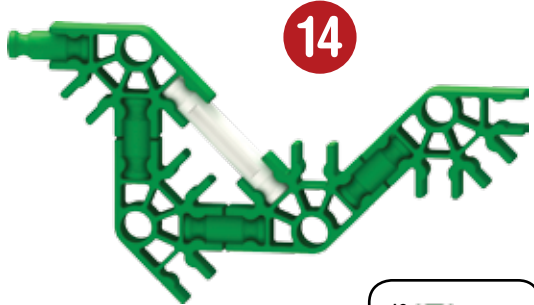

14

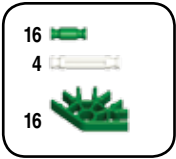

15

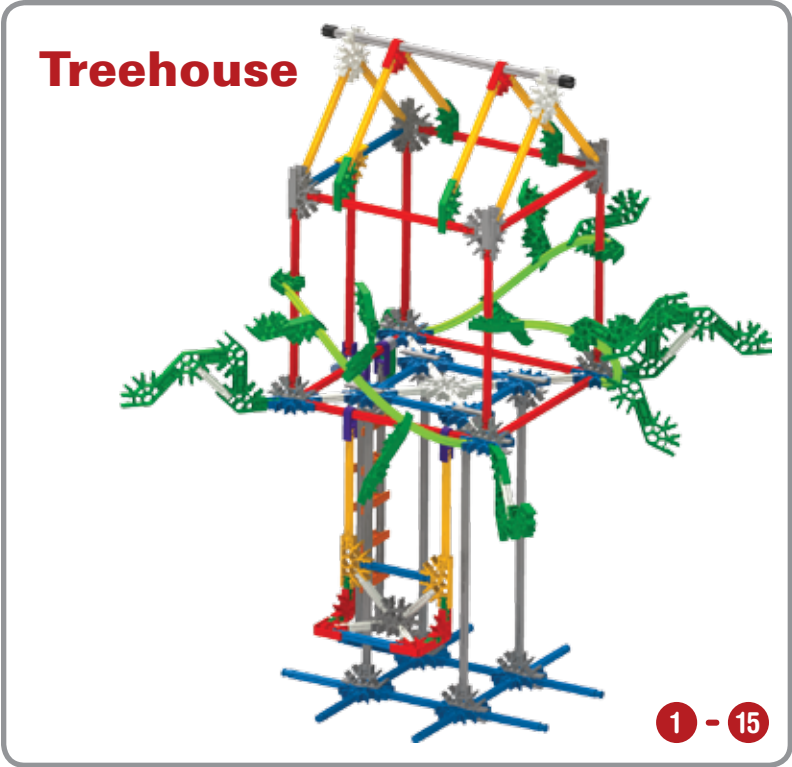
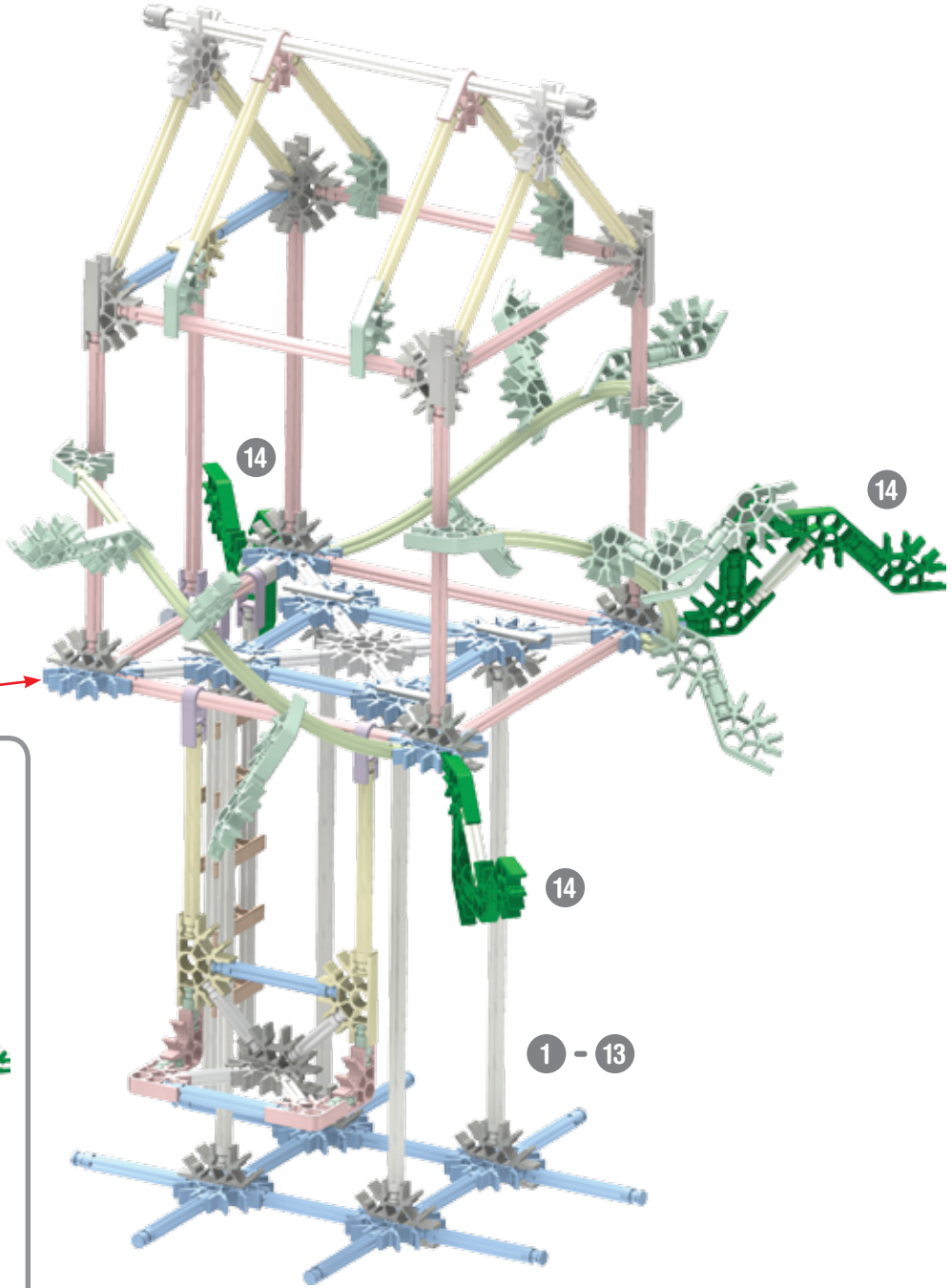

Treehouse

1 - 15

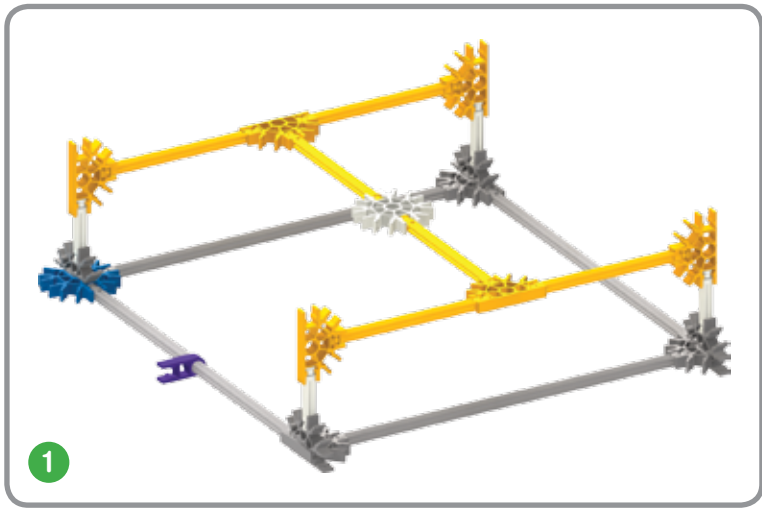
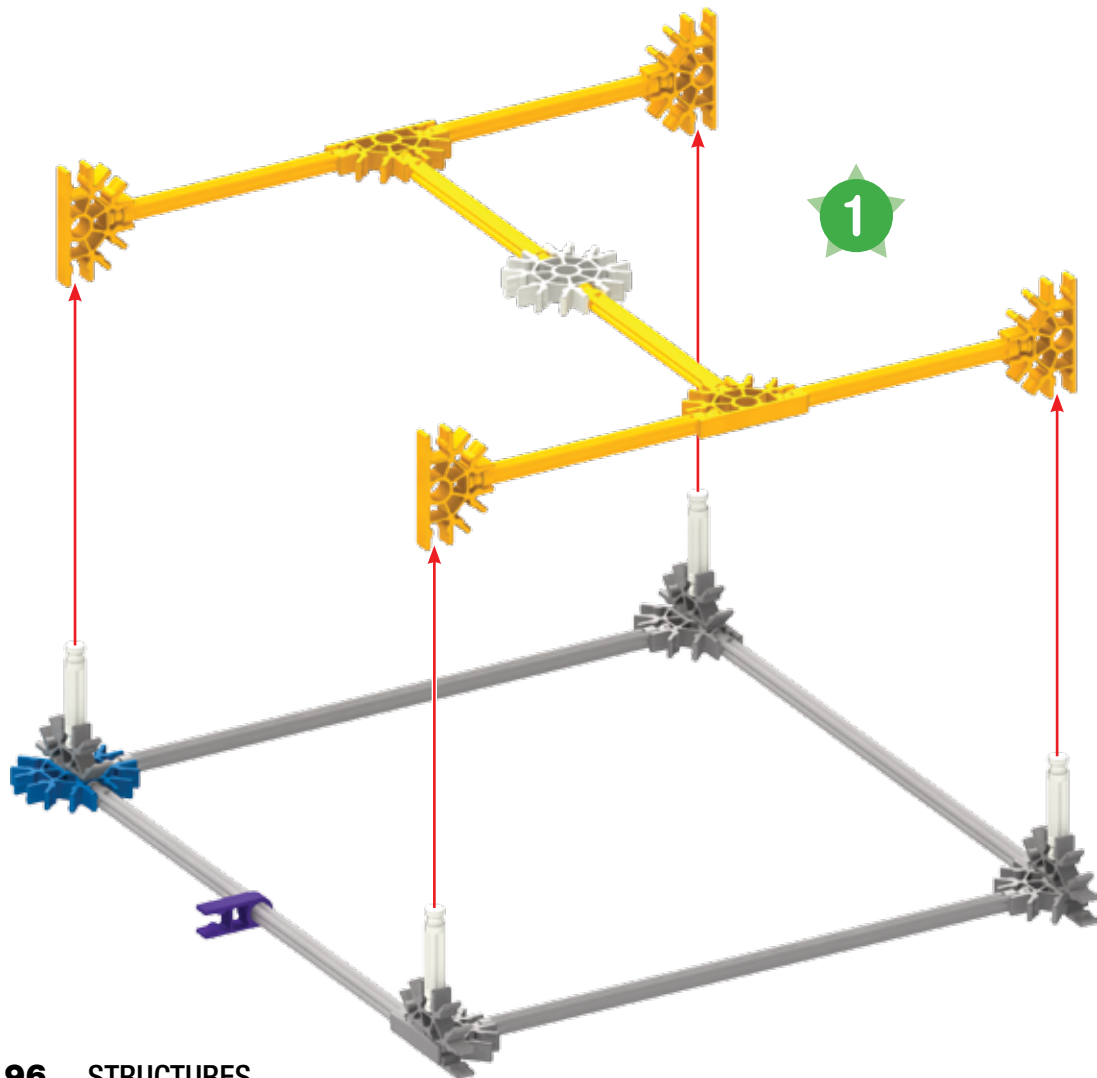
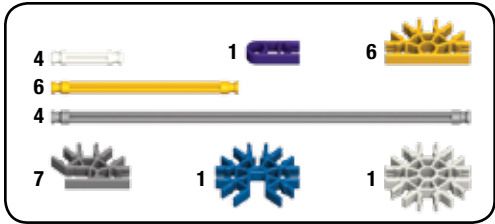

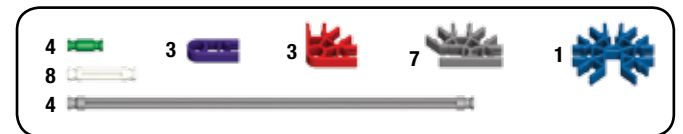
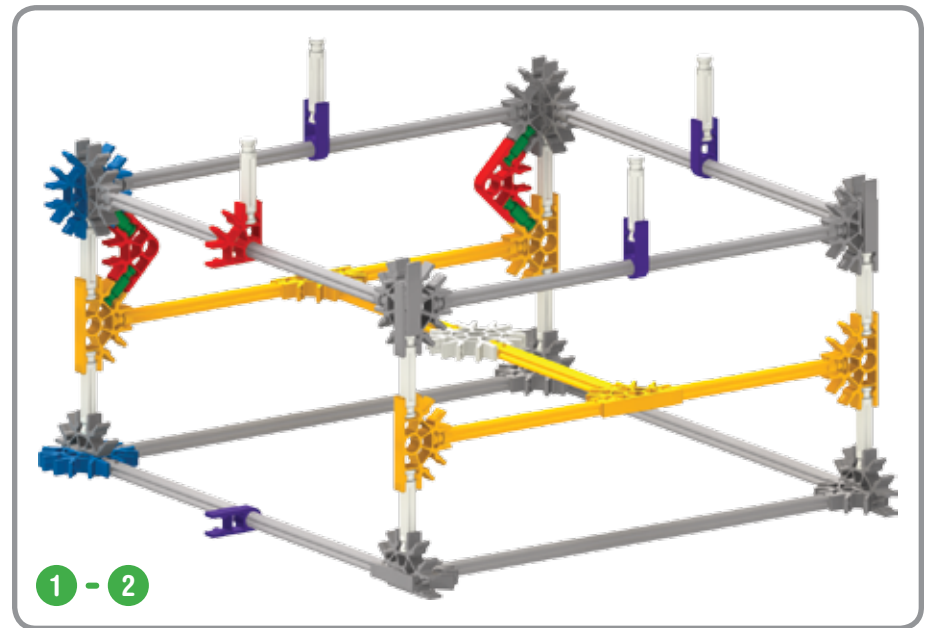
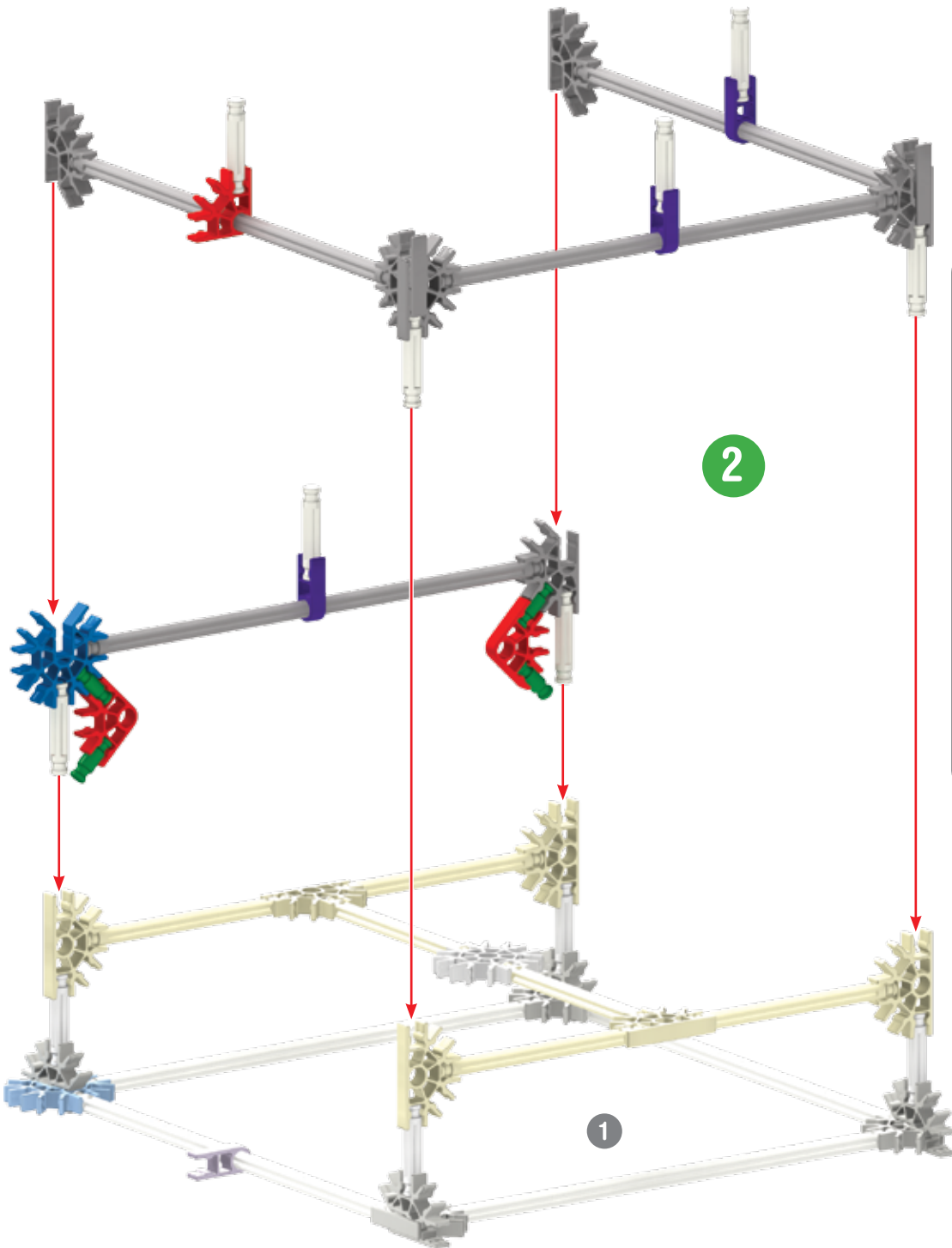

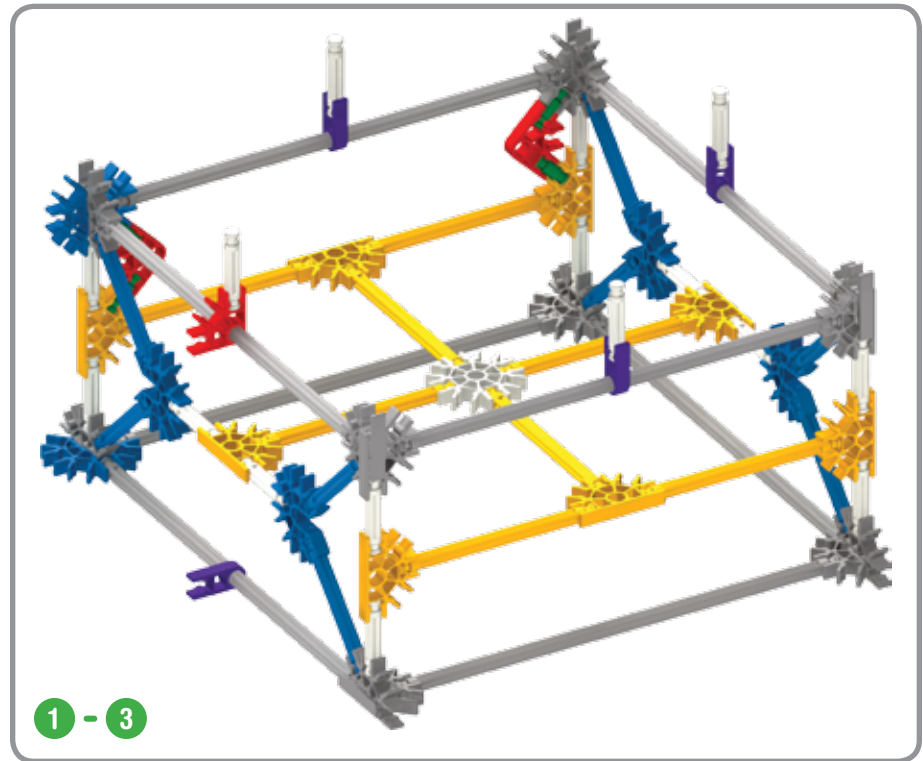
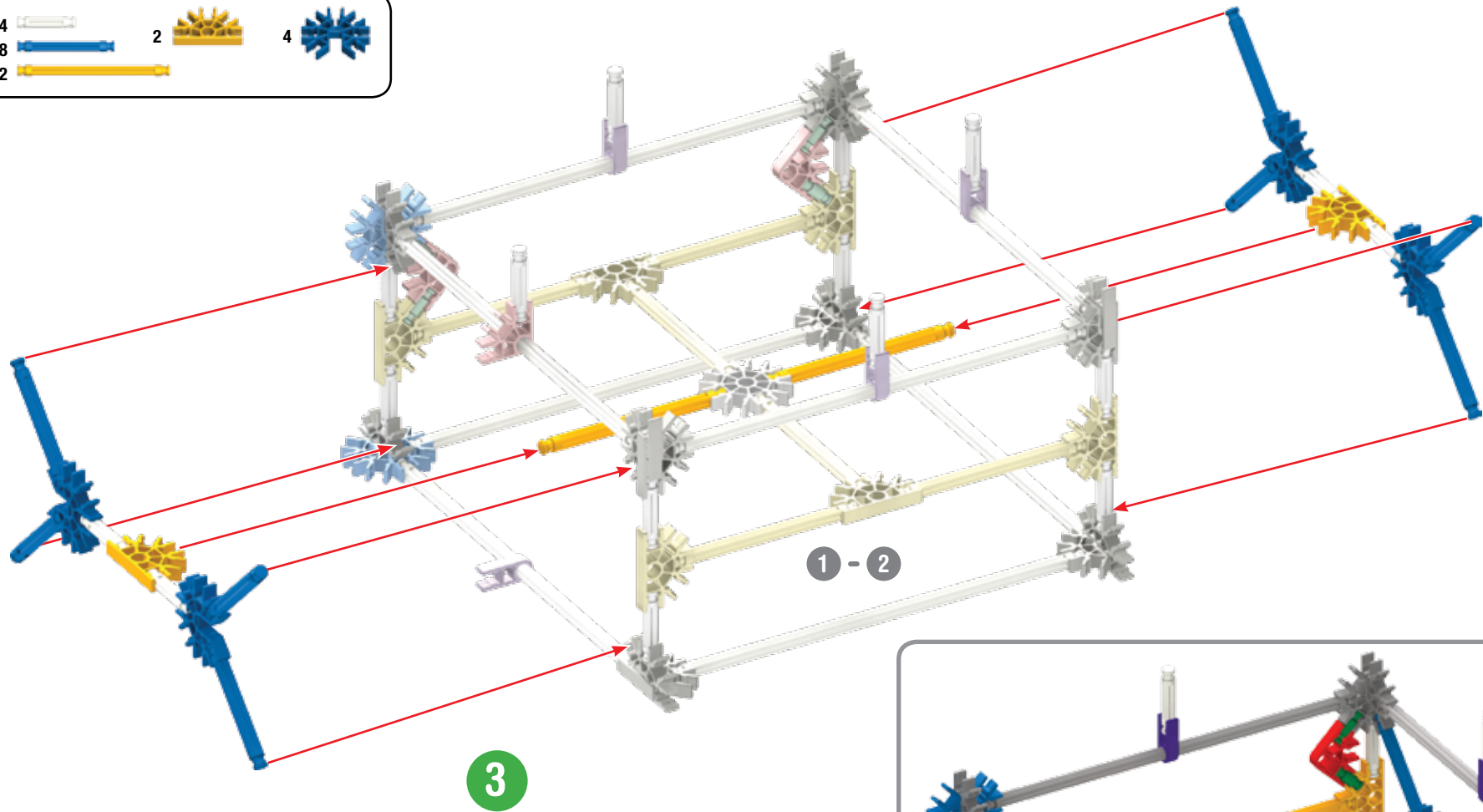
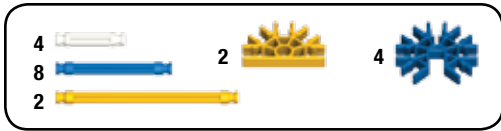

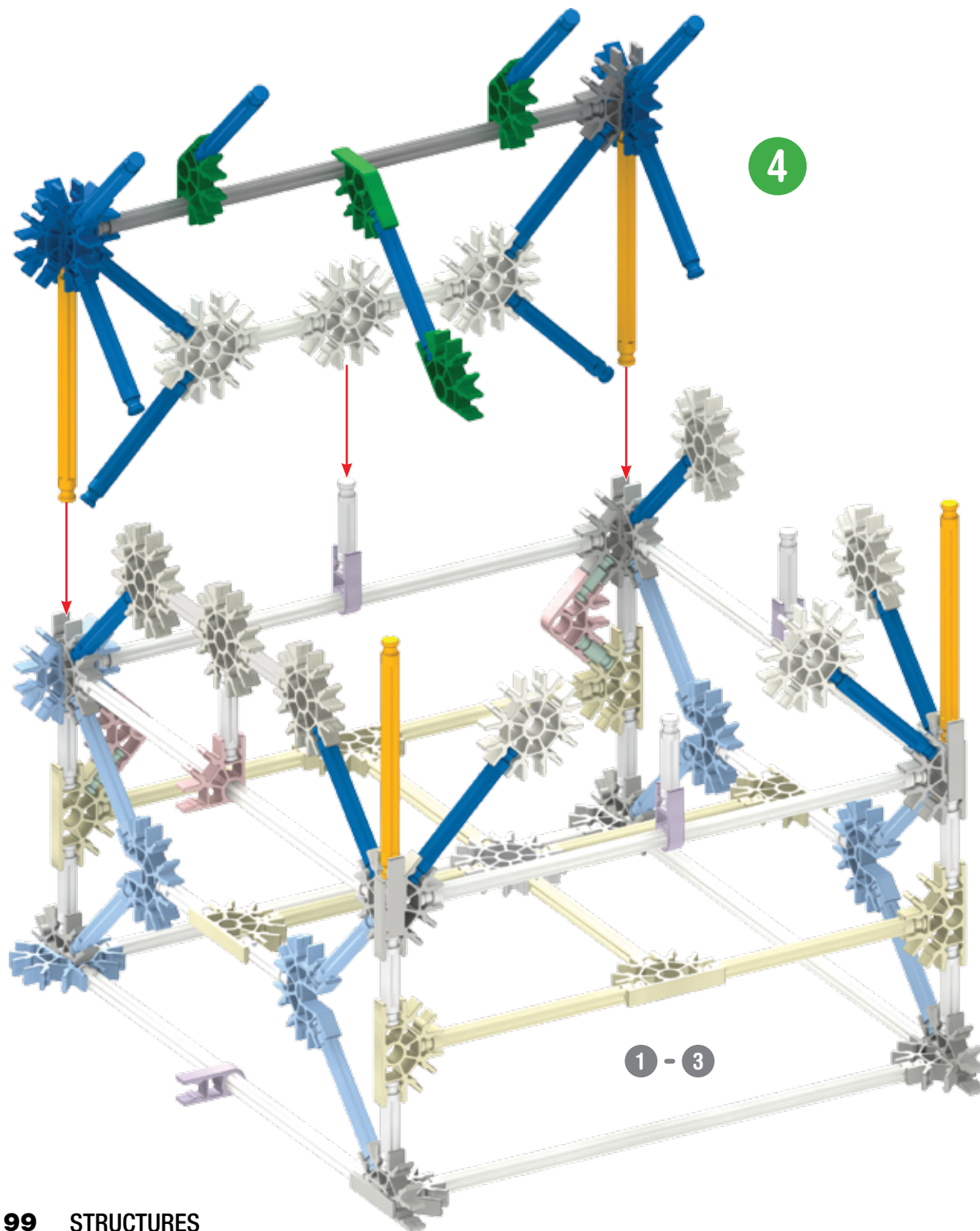





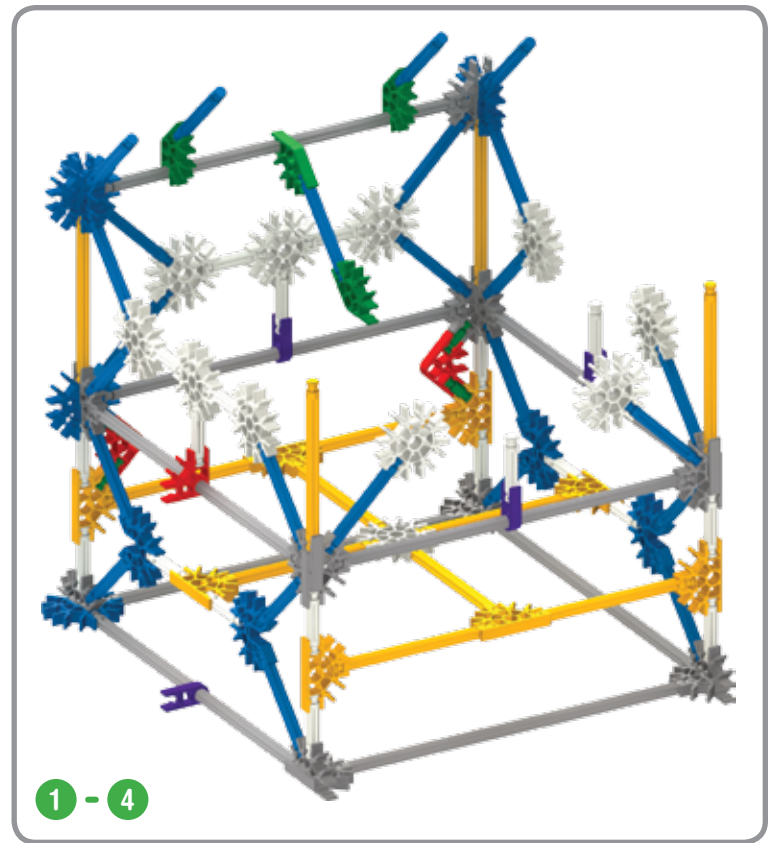

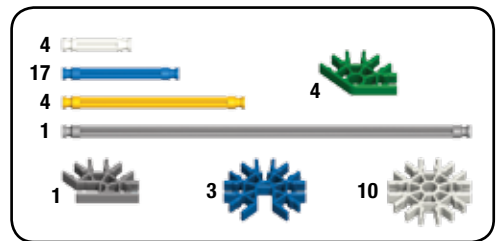

4

1 - 3



1 - 4



- 8  2  10  2  1  2 
- 2 
- 1 

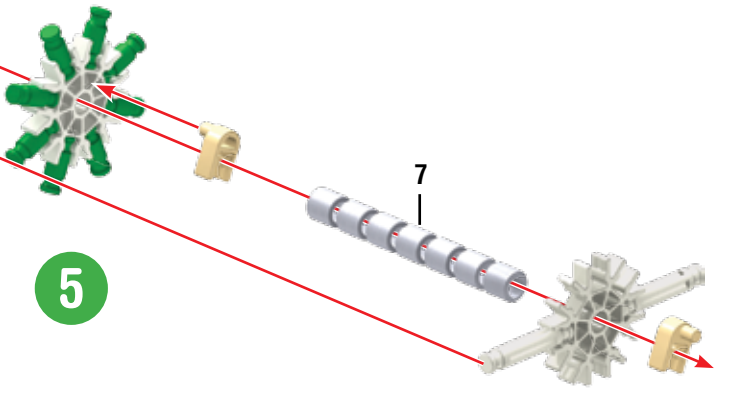
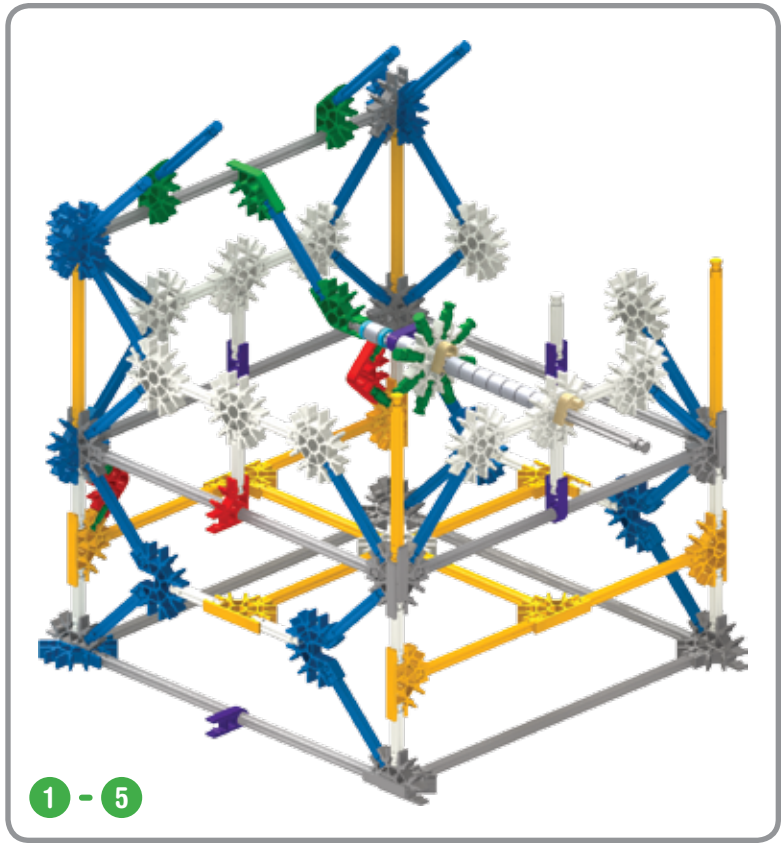
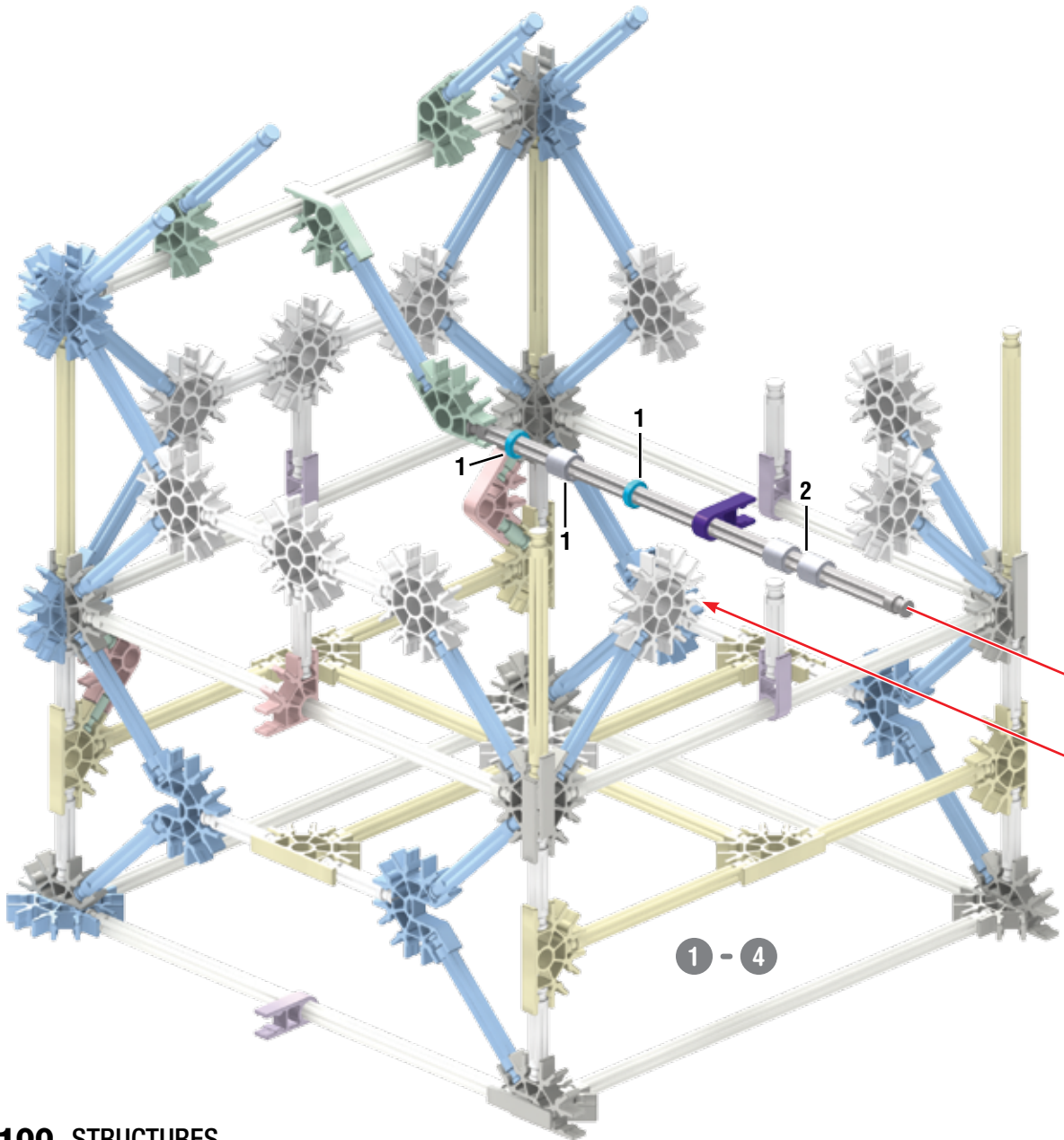

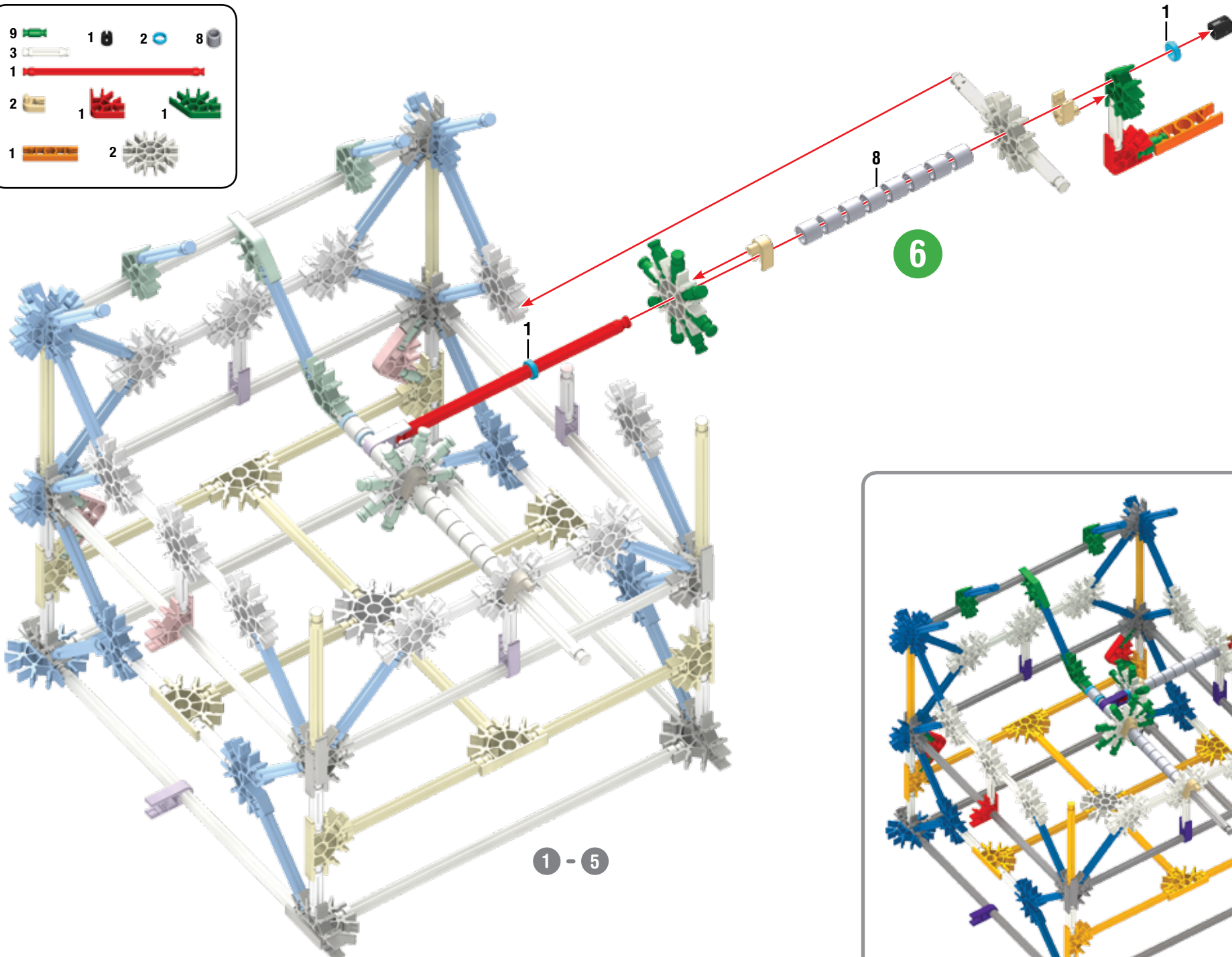
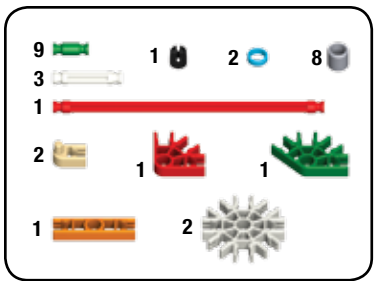

6

1 - 5

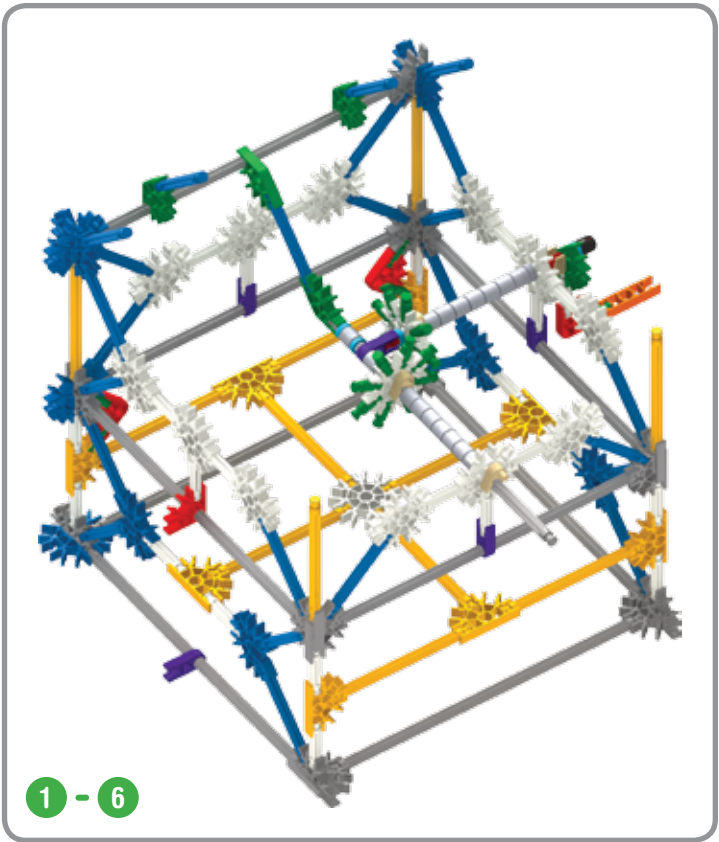

1 - 6

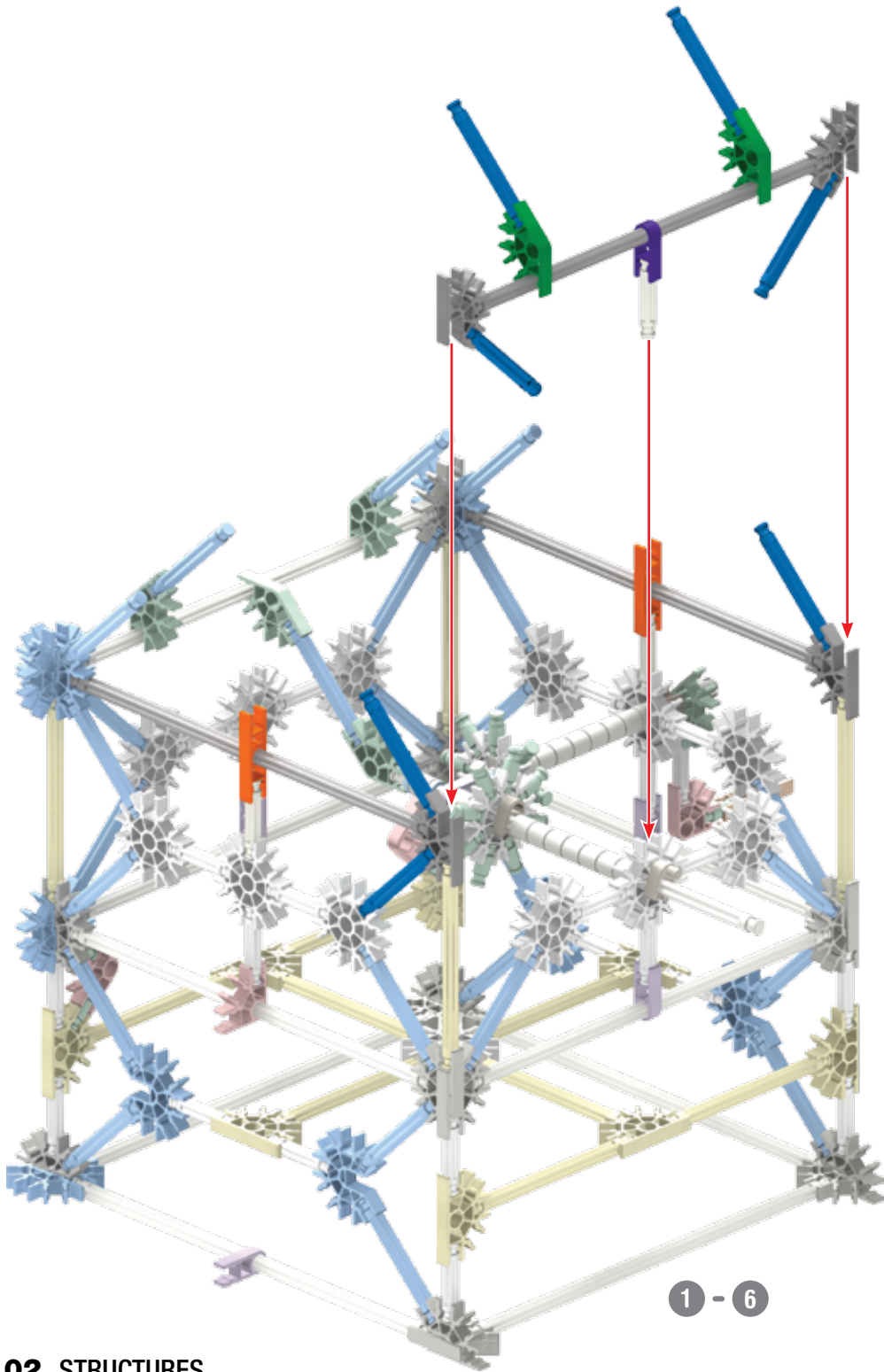

1 - 6

7

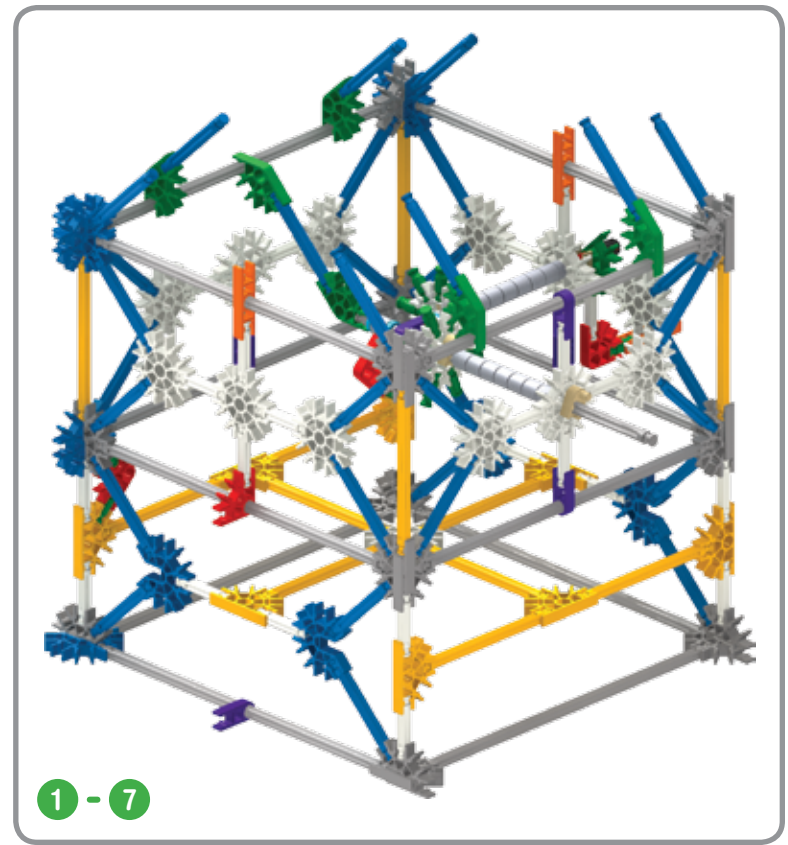

1 - 7

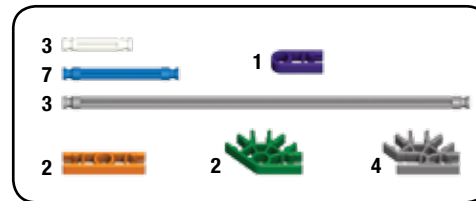

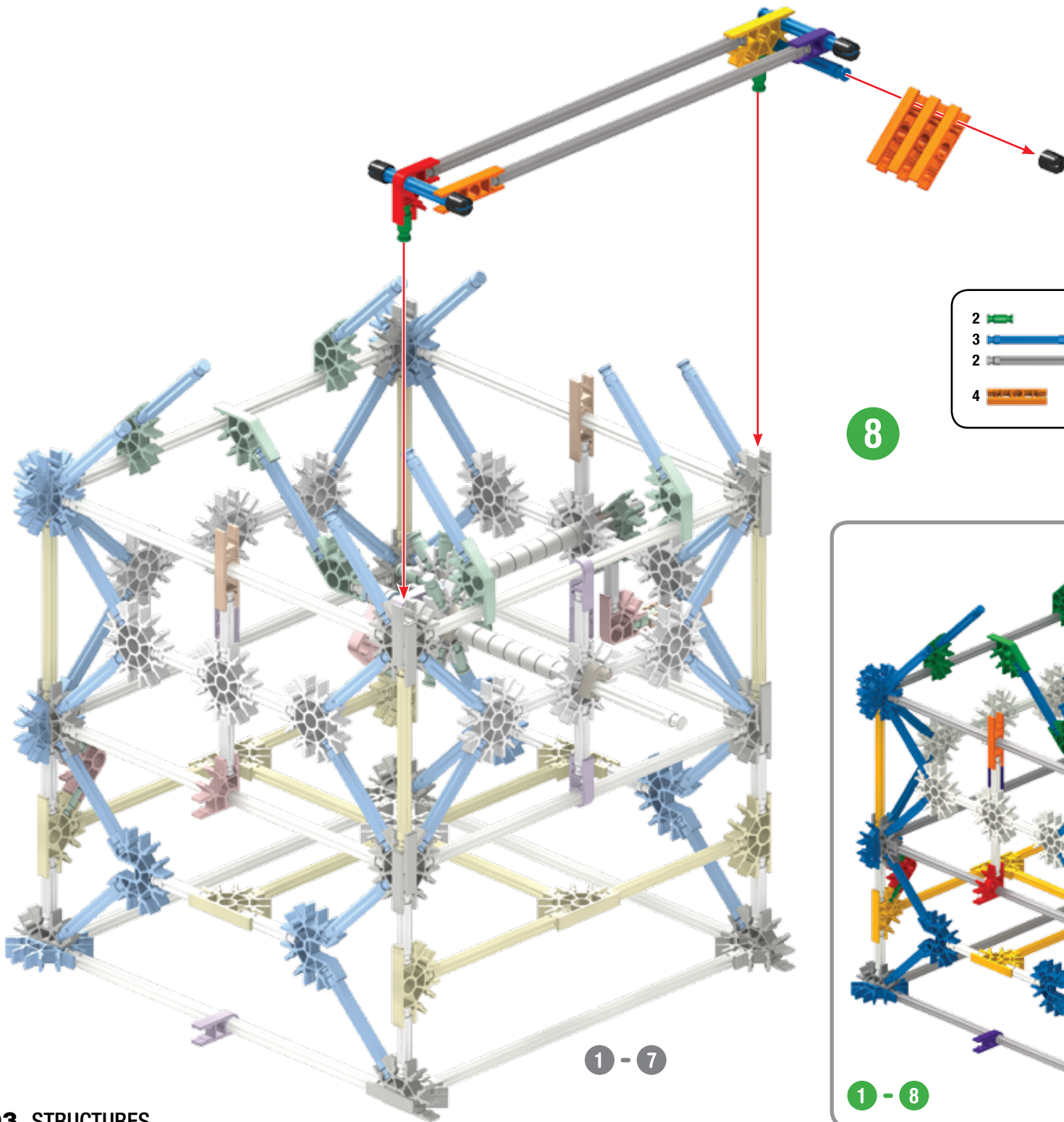

2		4		1	
3					
2					
4		1		1	

8

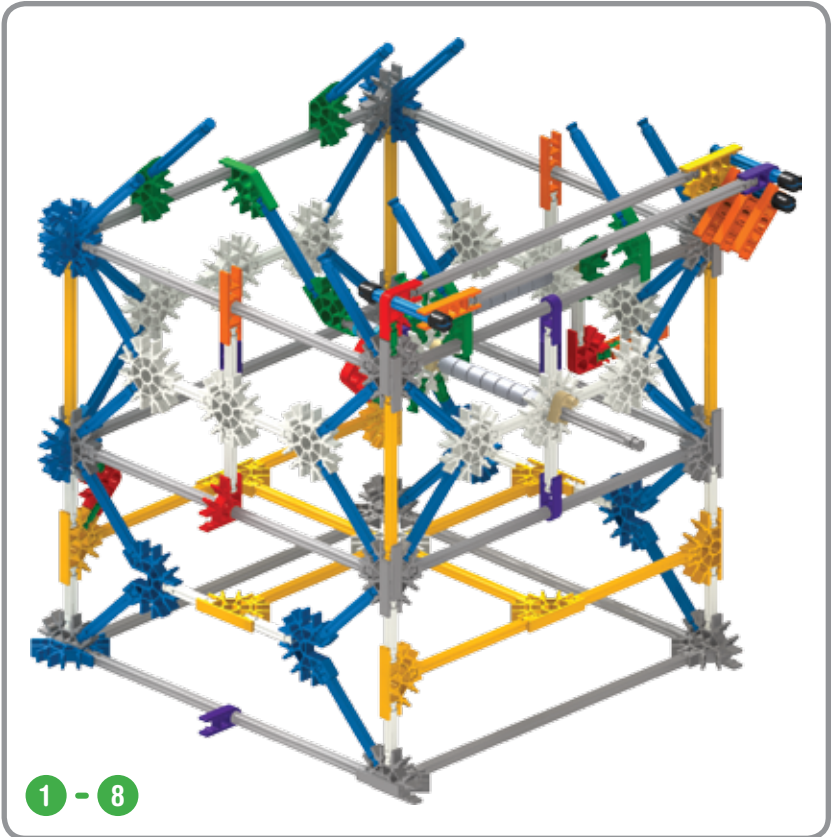

1 - 8

1 - 7

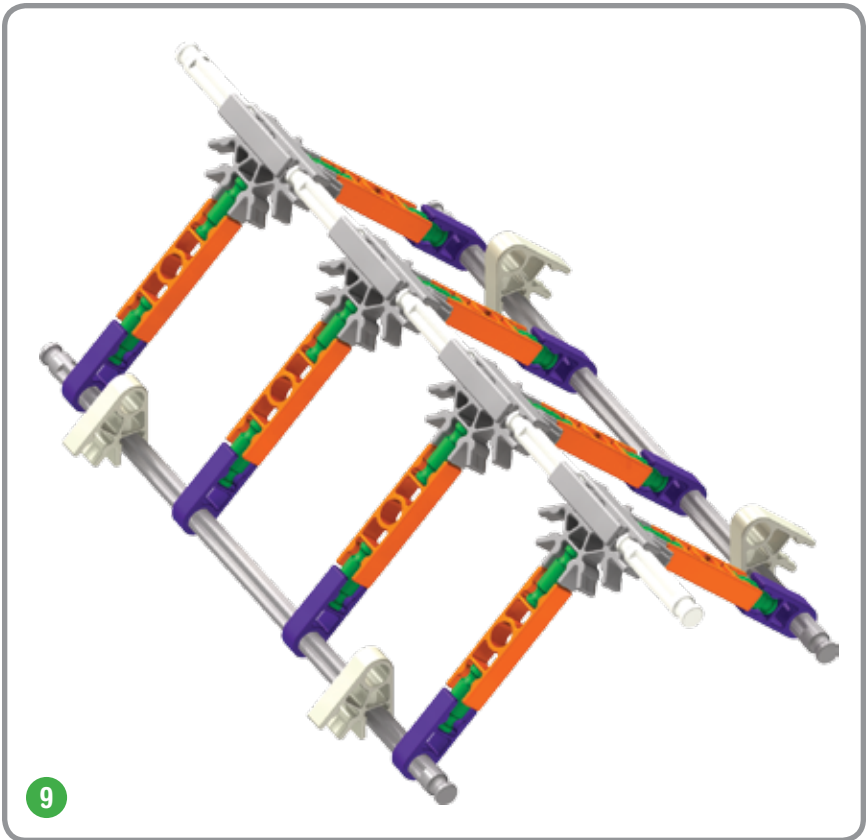
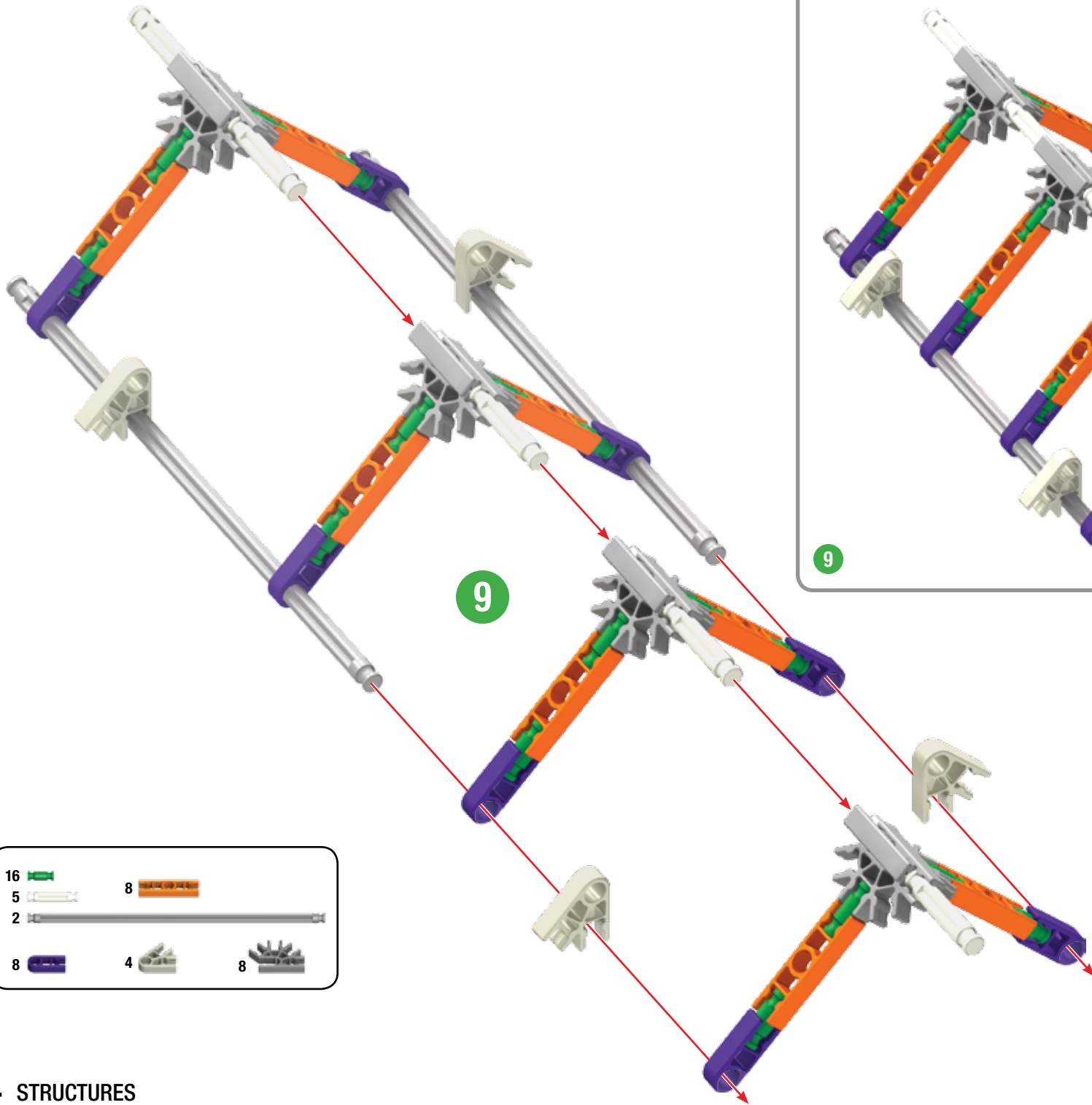

16		8	
5			
2			
8		4	
		8	

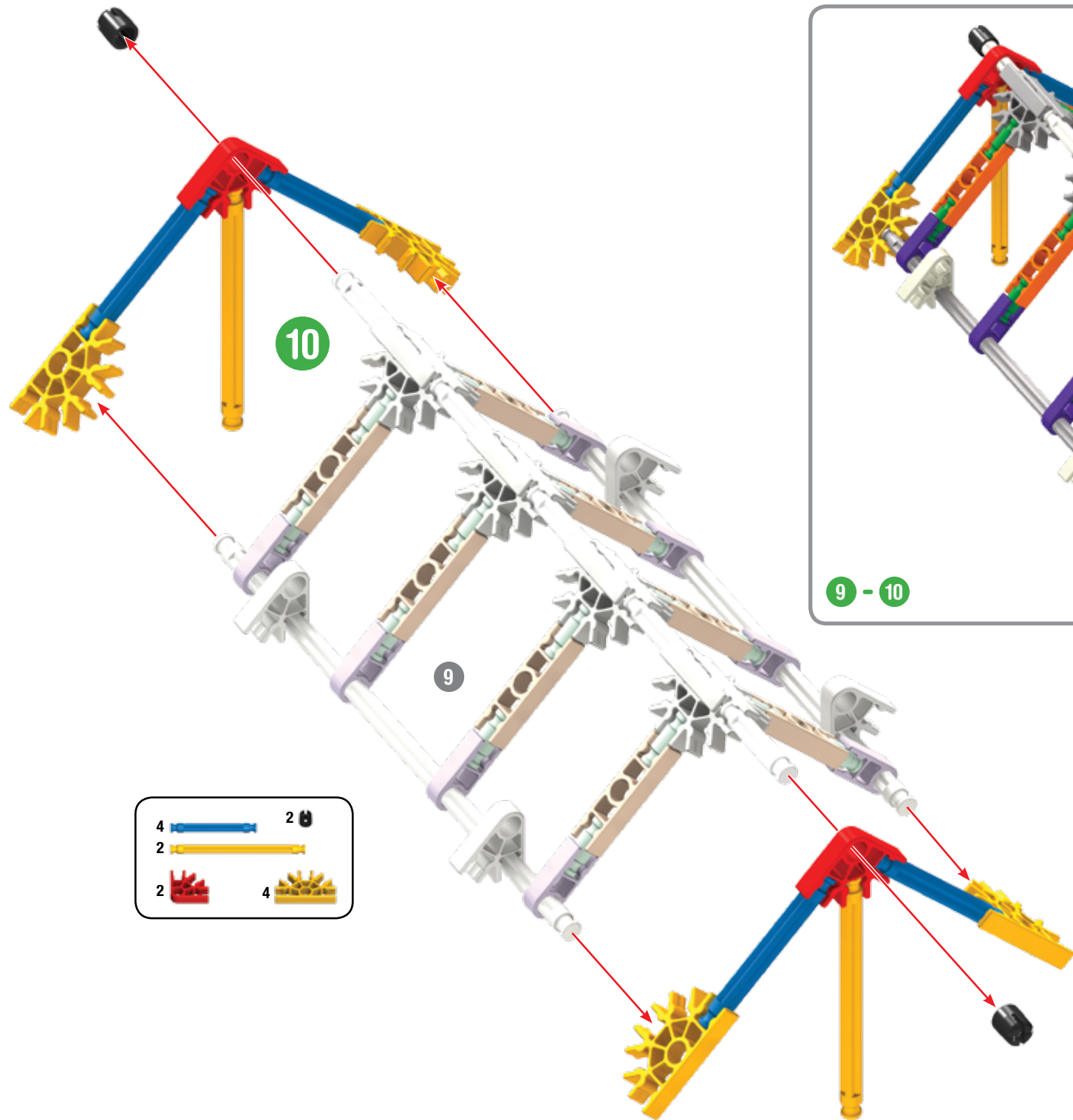

- | | | | |
|---|--|---|--|
| 4 | | 2 | |
| 2 | | | |
| 2 | | 4 | |

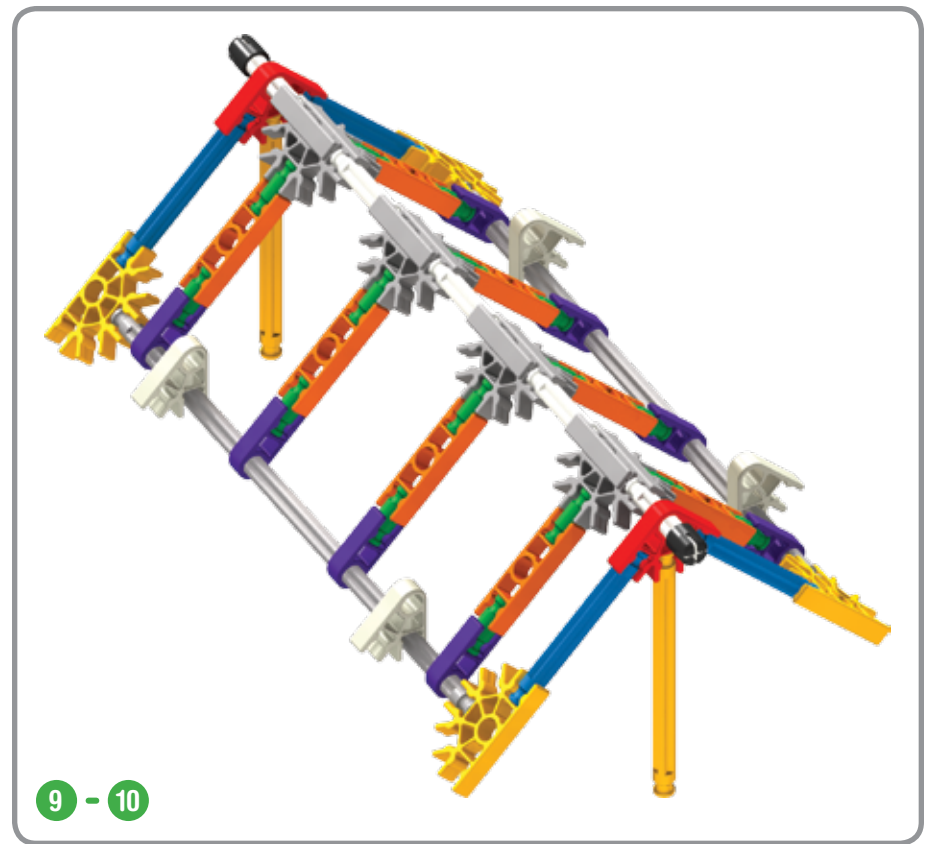

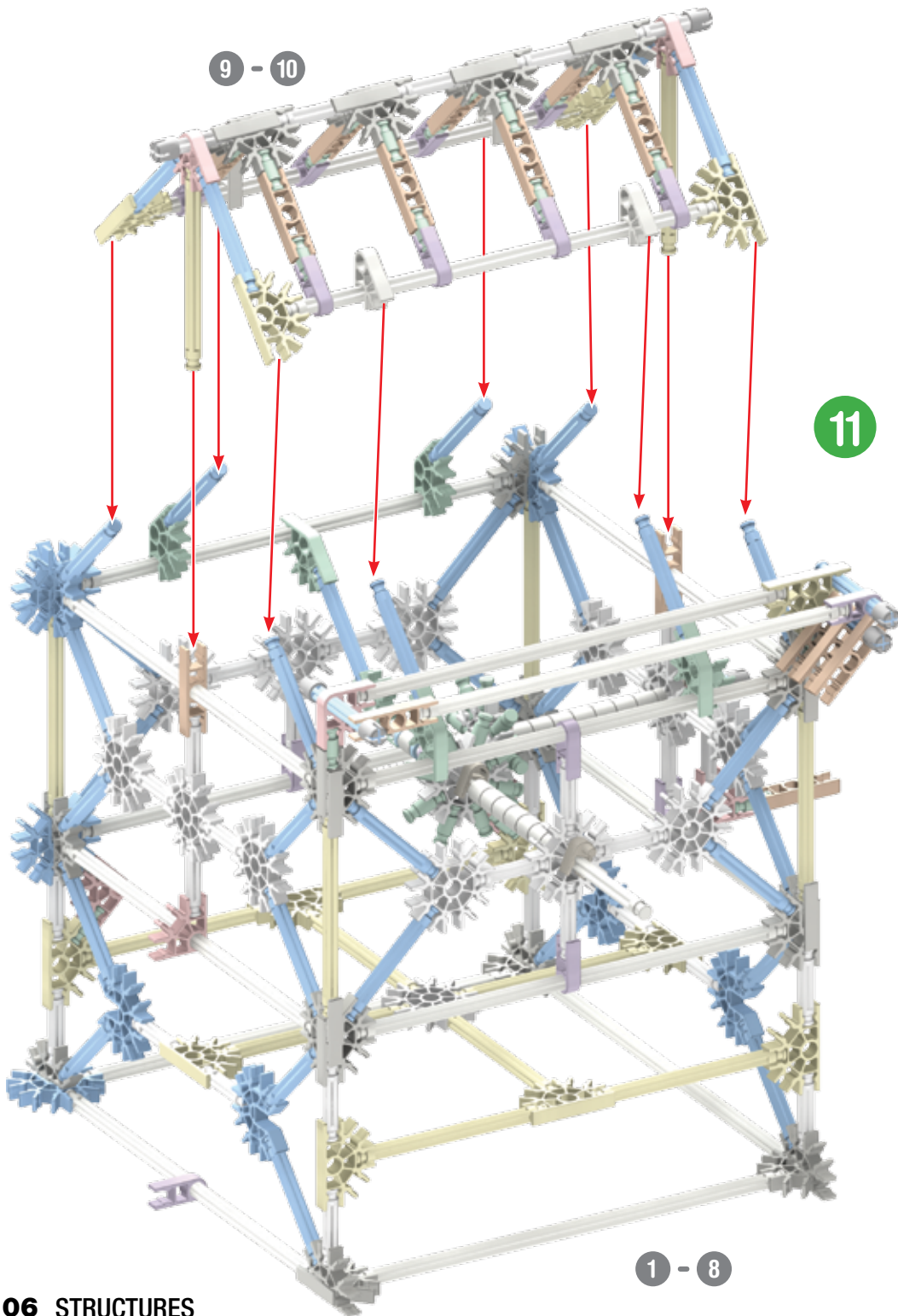

11

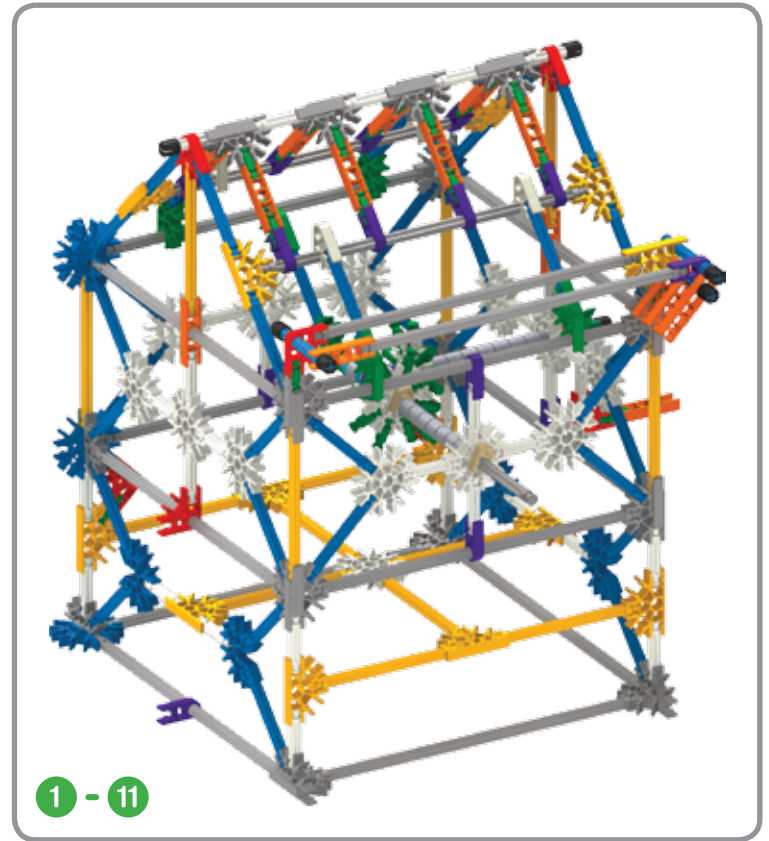



12

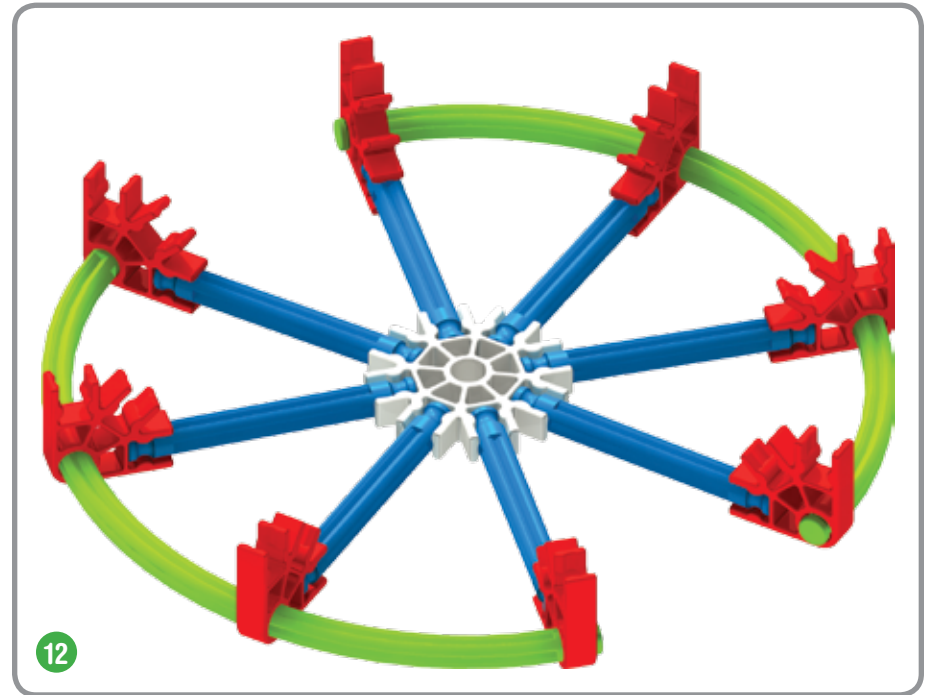
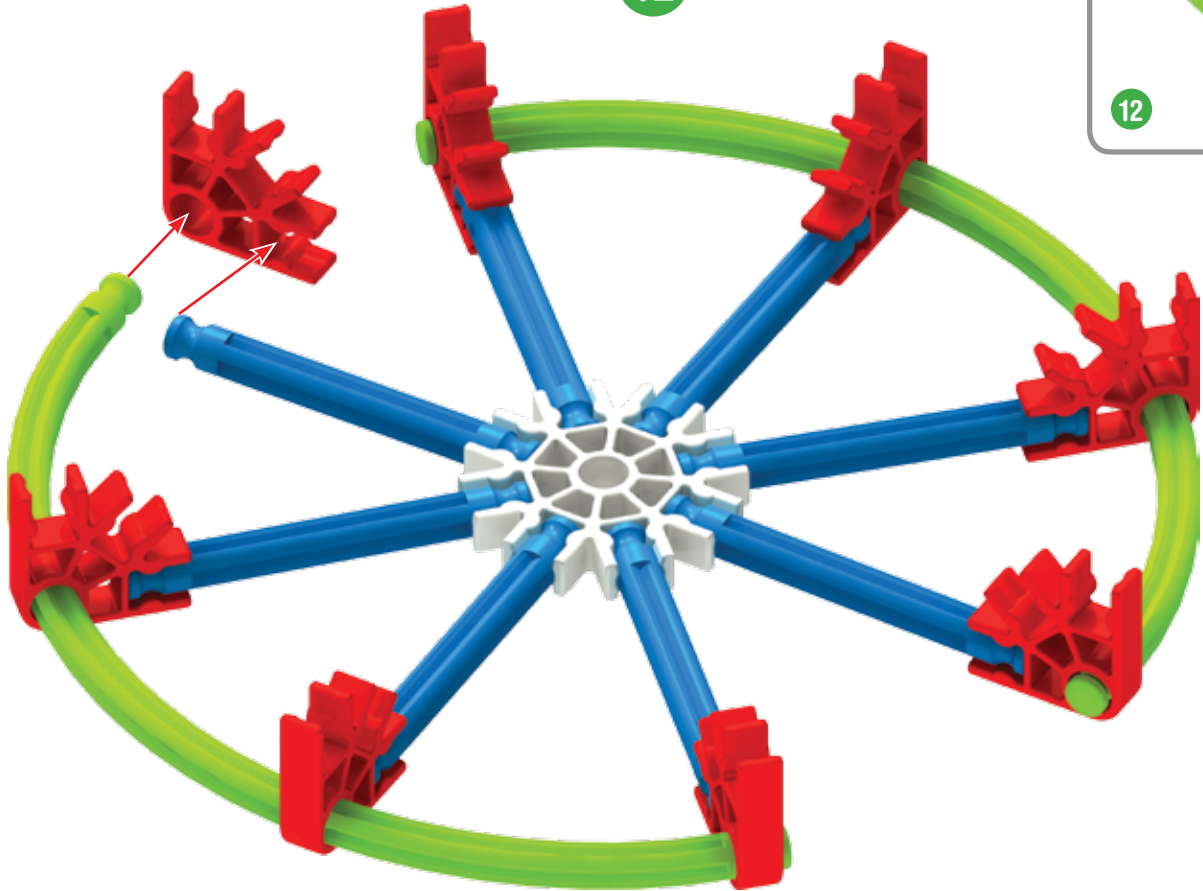

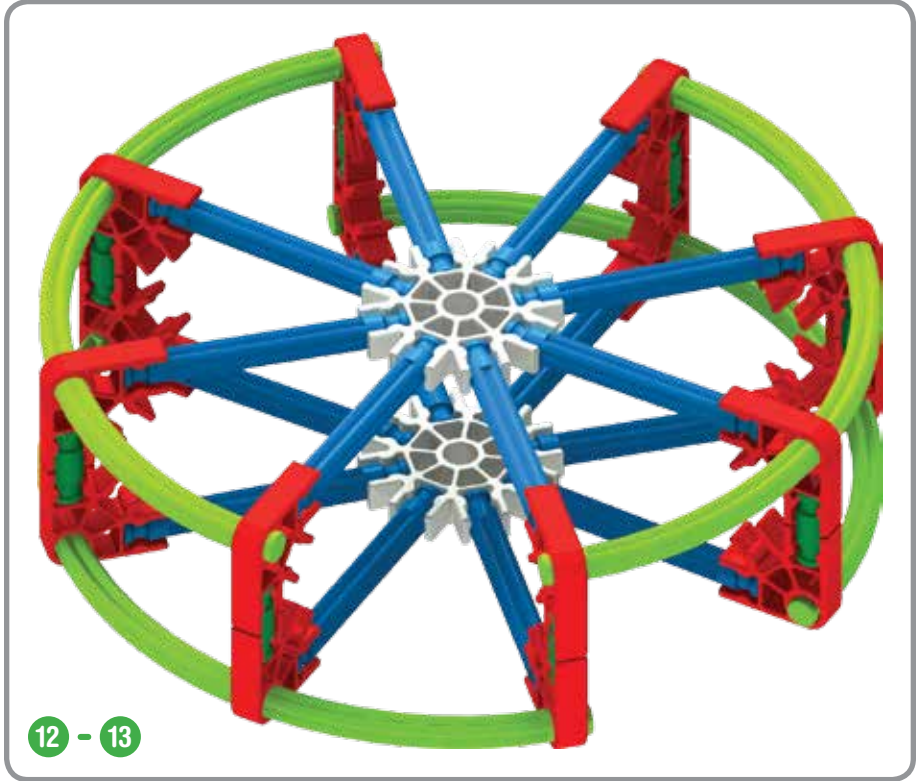
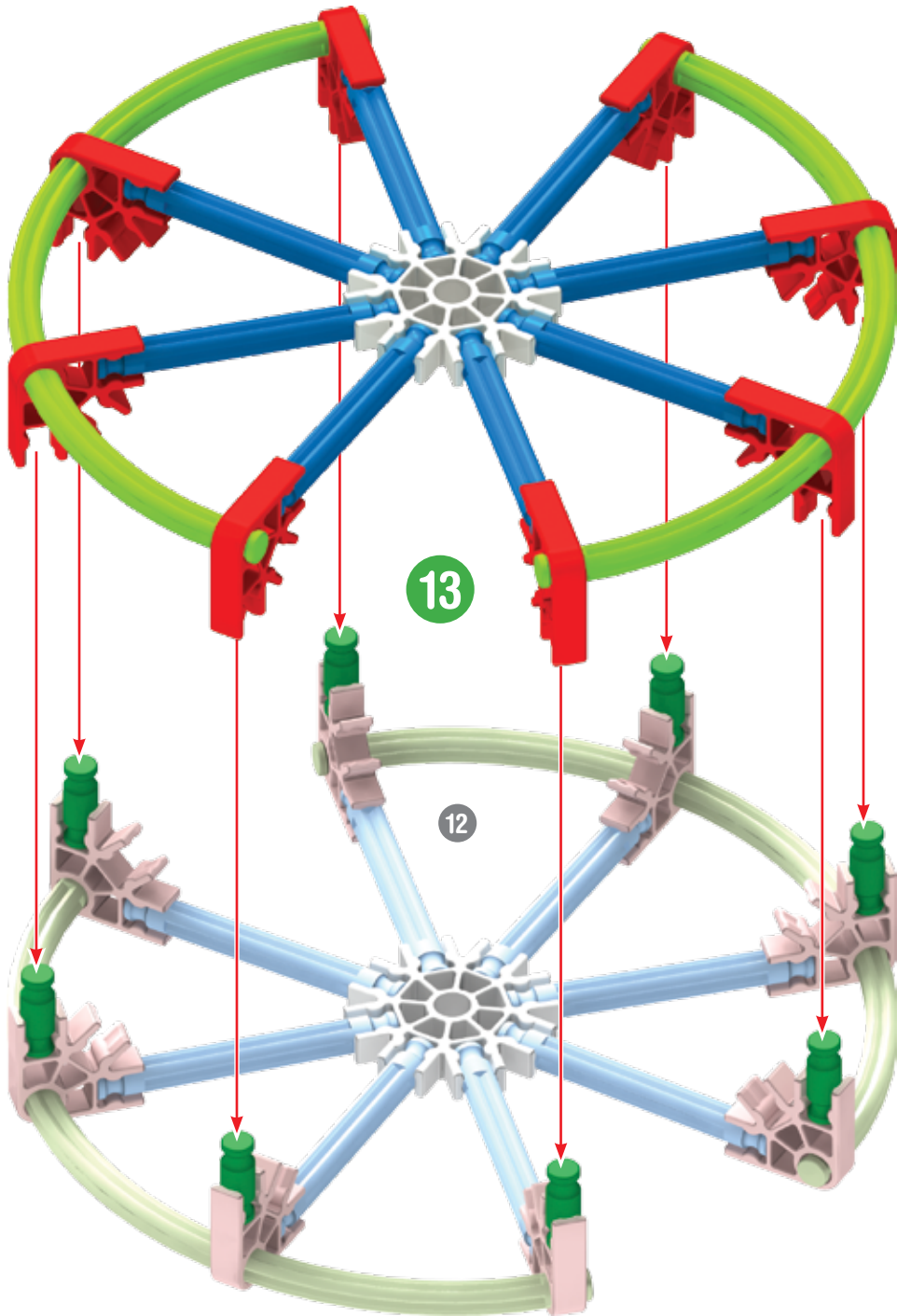

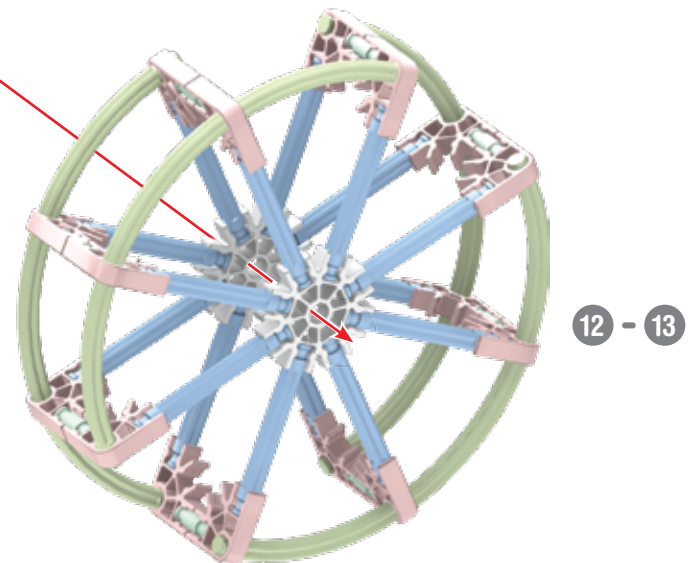
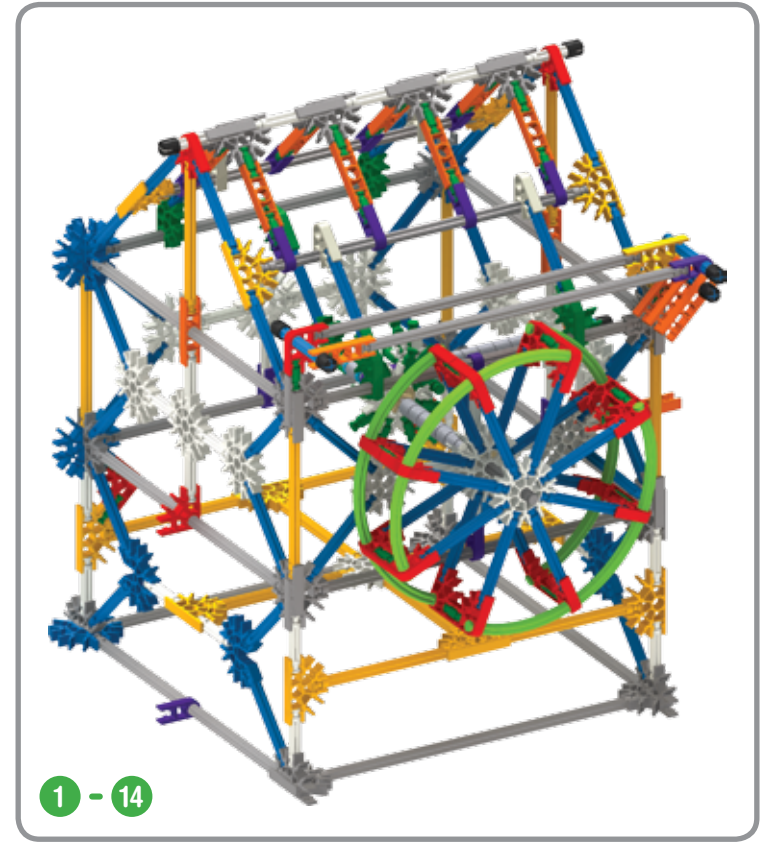
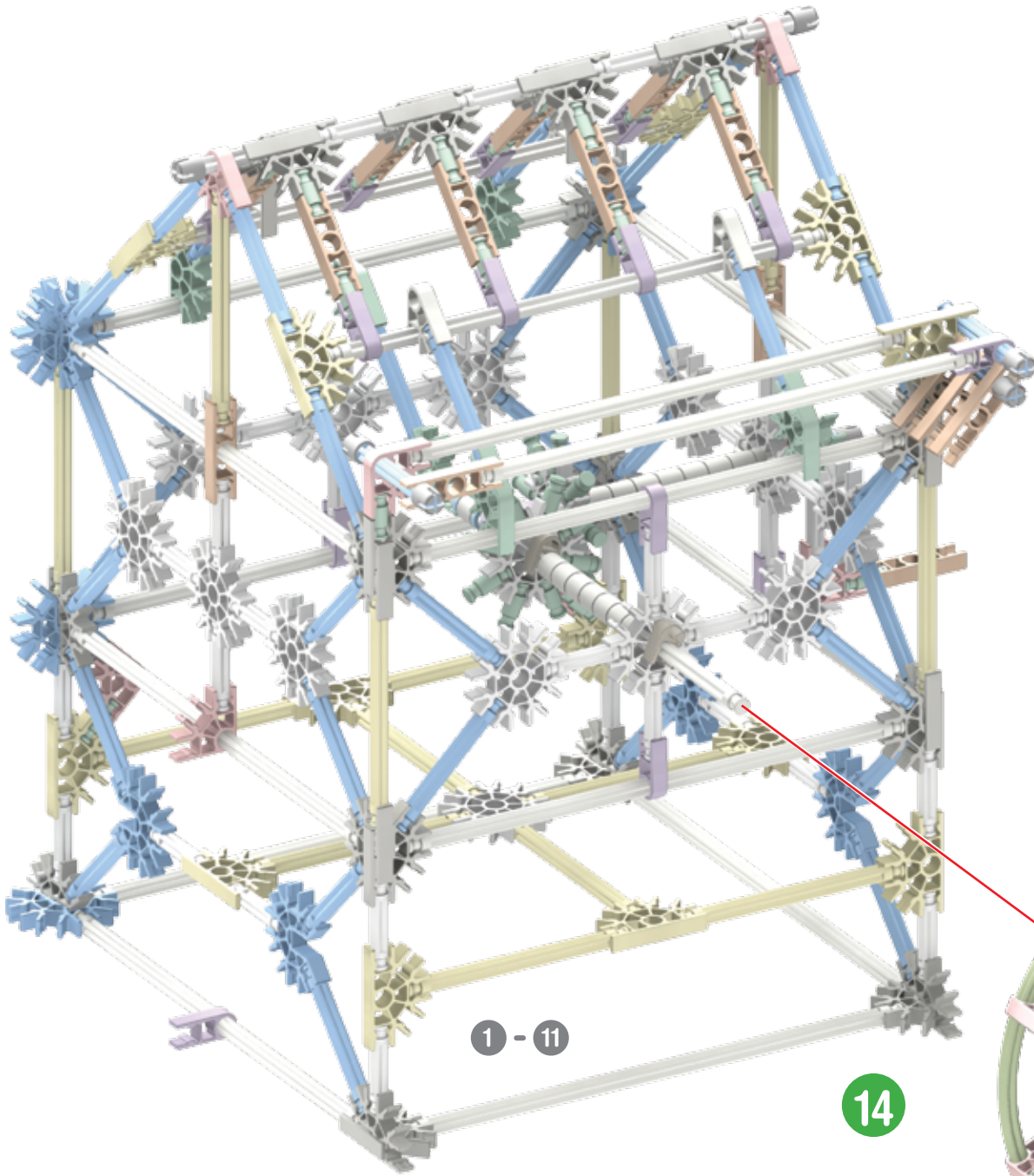

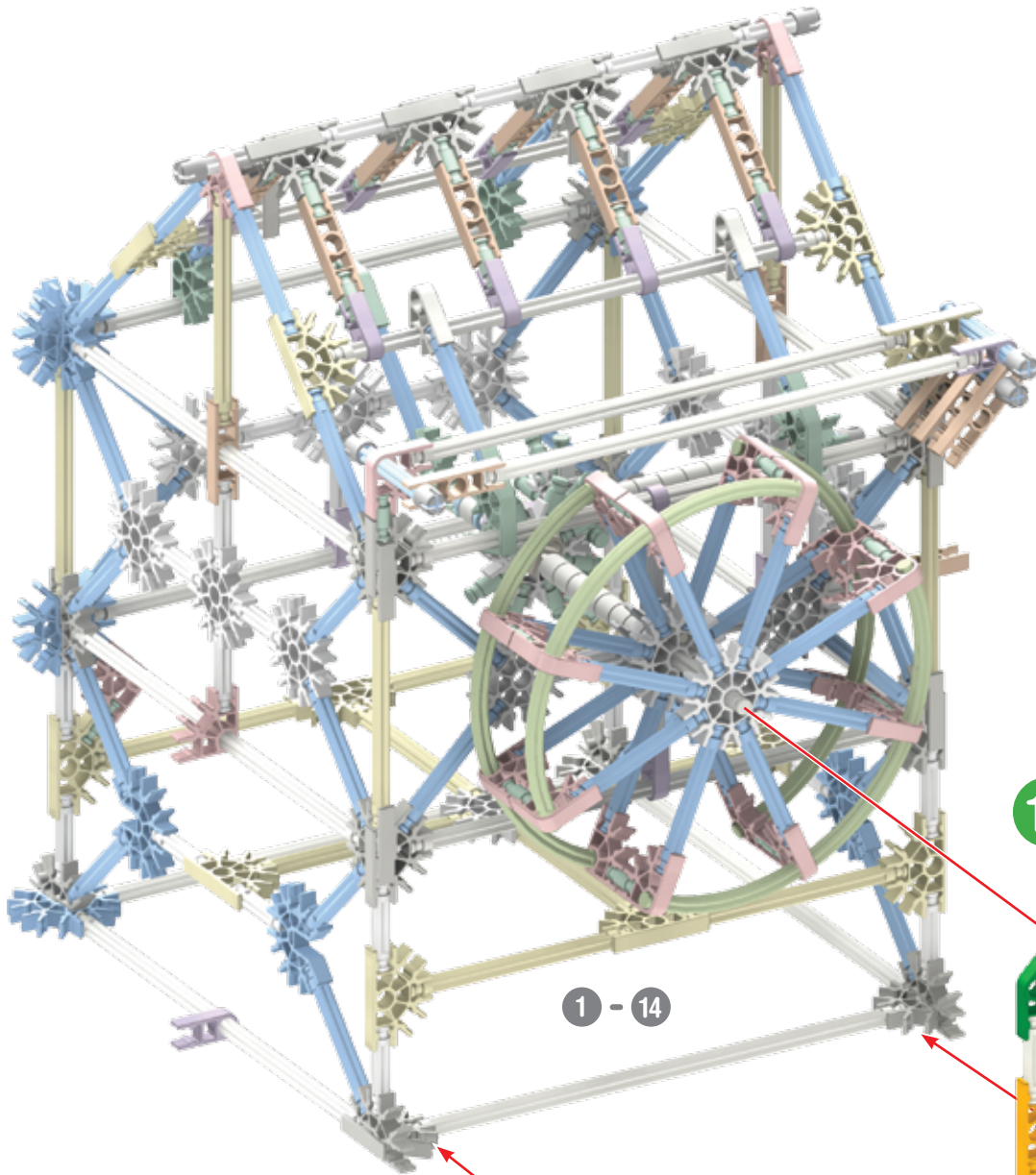

1 - 14

15

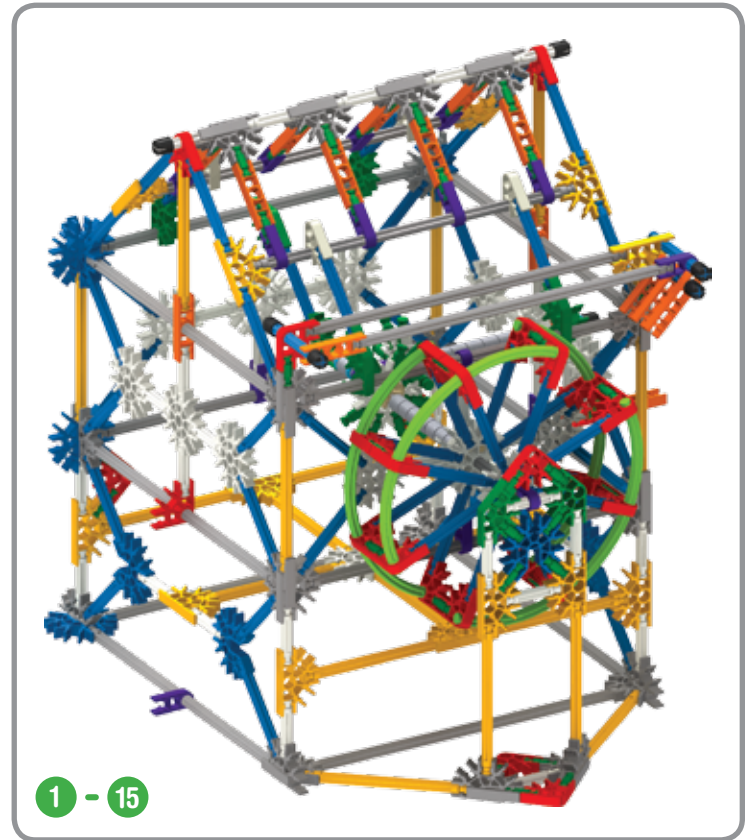

1 - 15

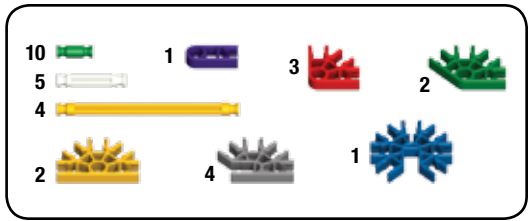

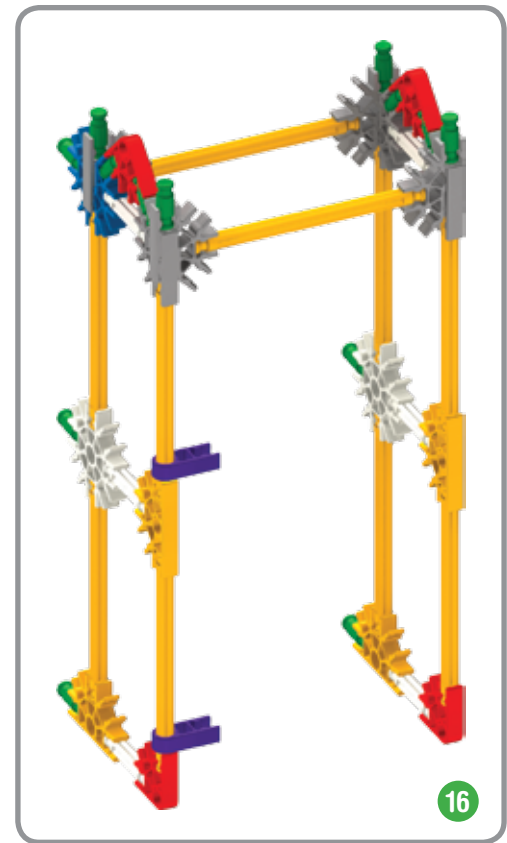
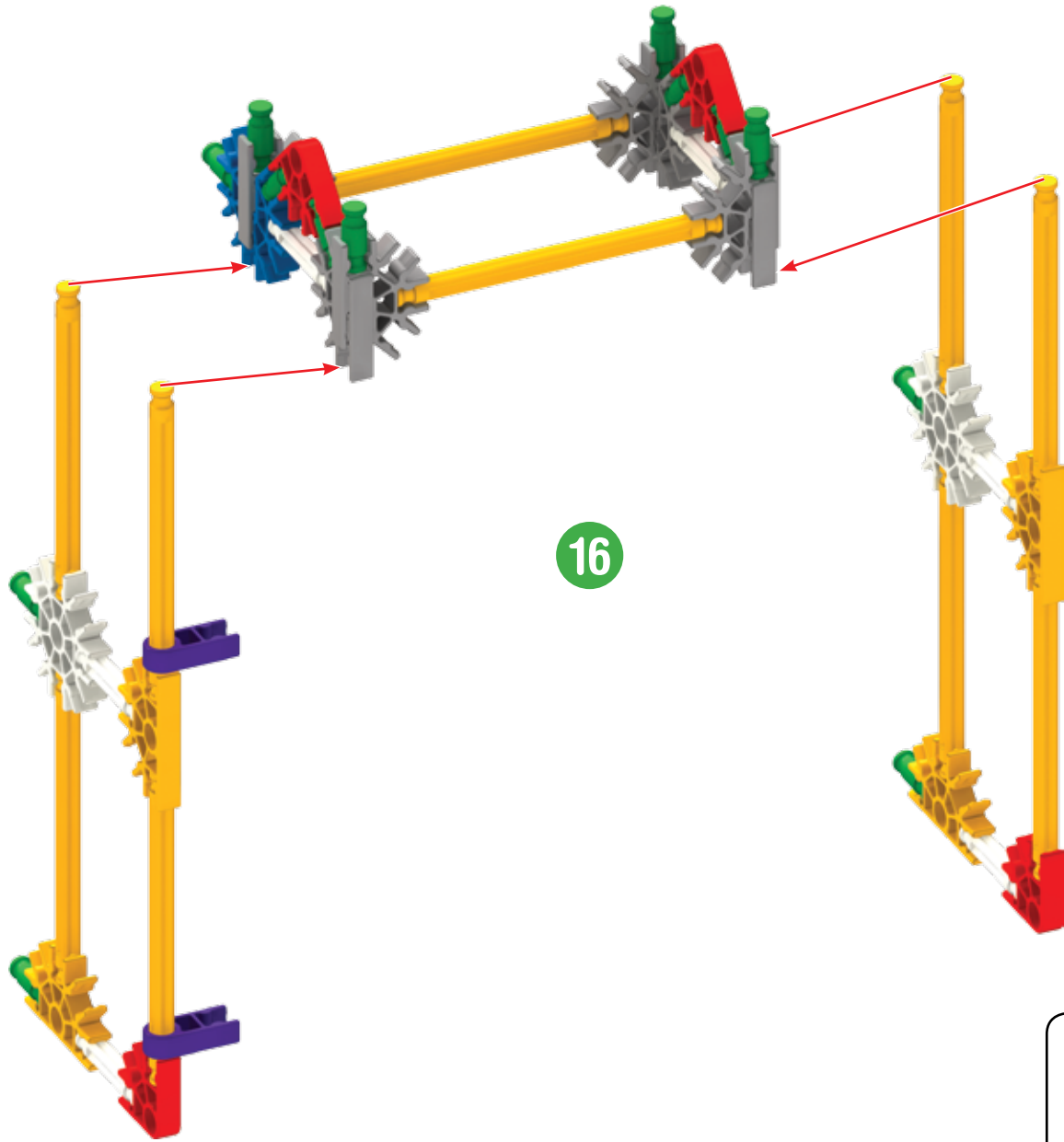

- | | | | | | | | |
|----|--|---|--|---|--|---|--|
| 13 | | 2 | | 4 | | 2 | |
| 6 | | | | | | | |
| 10 | | | | | | | |
| 4 | | 7 | | 1 | | | |

16		8	
4			

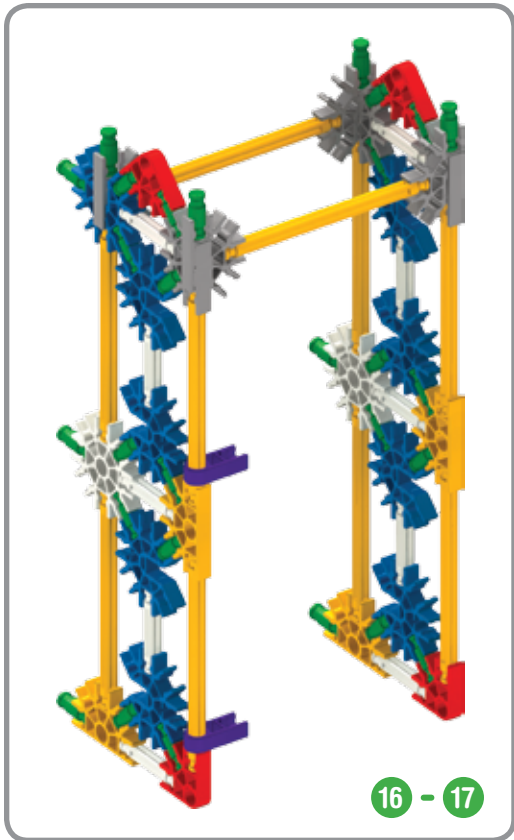
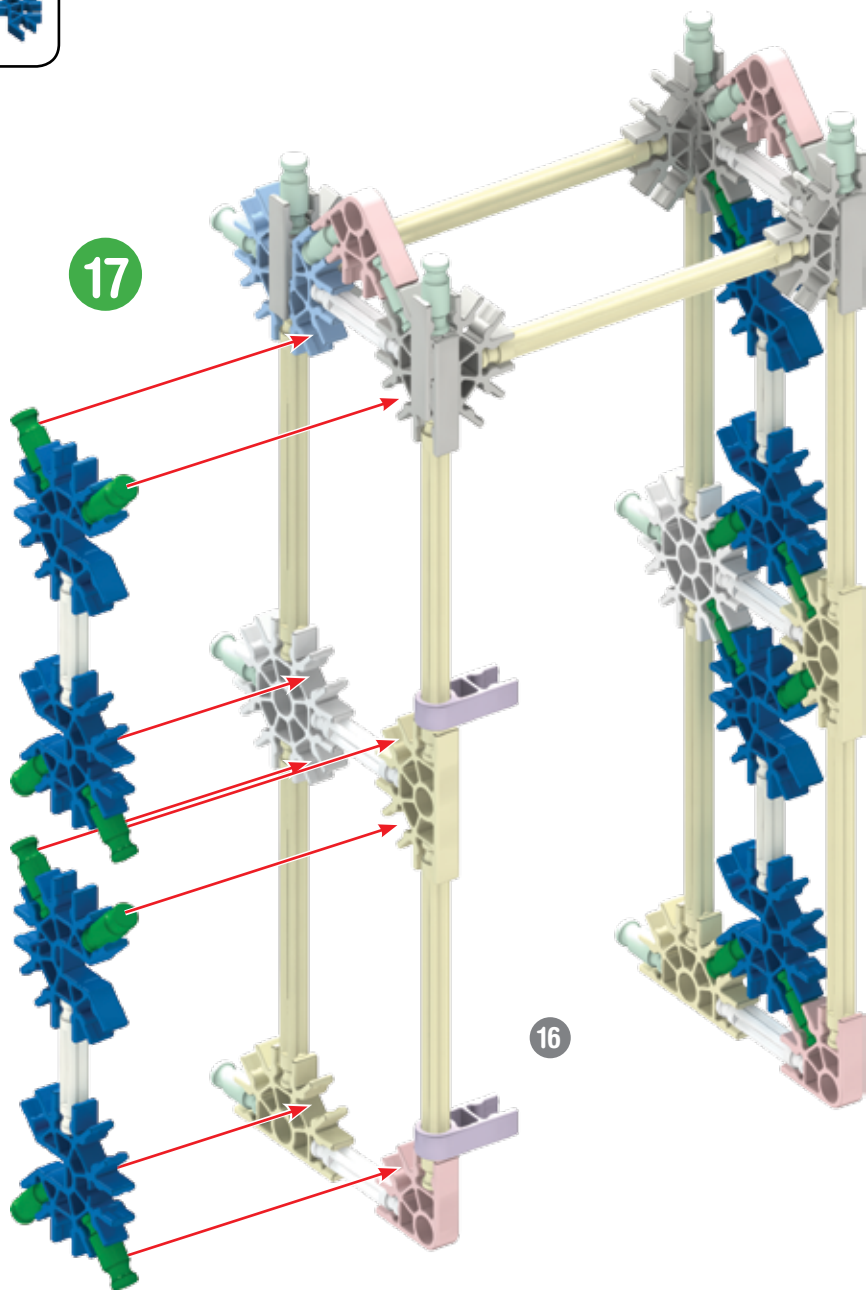

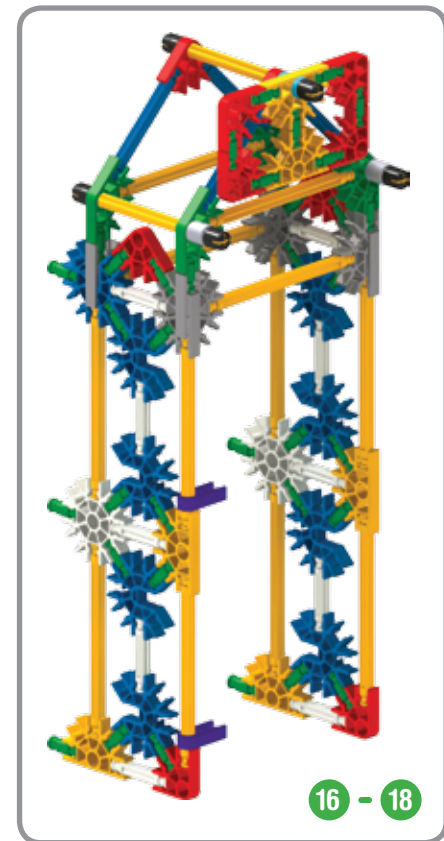
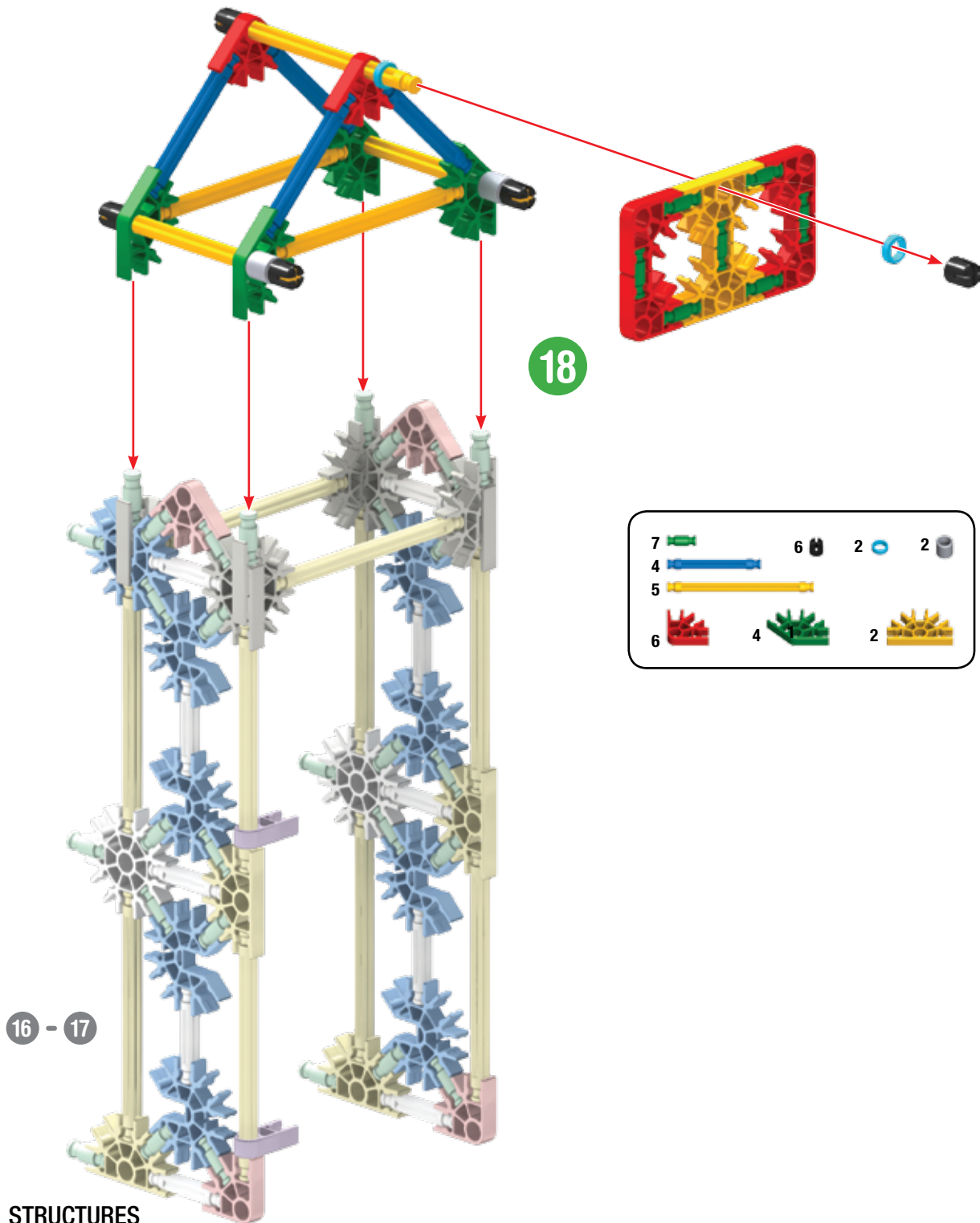

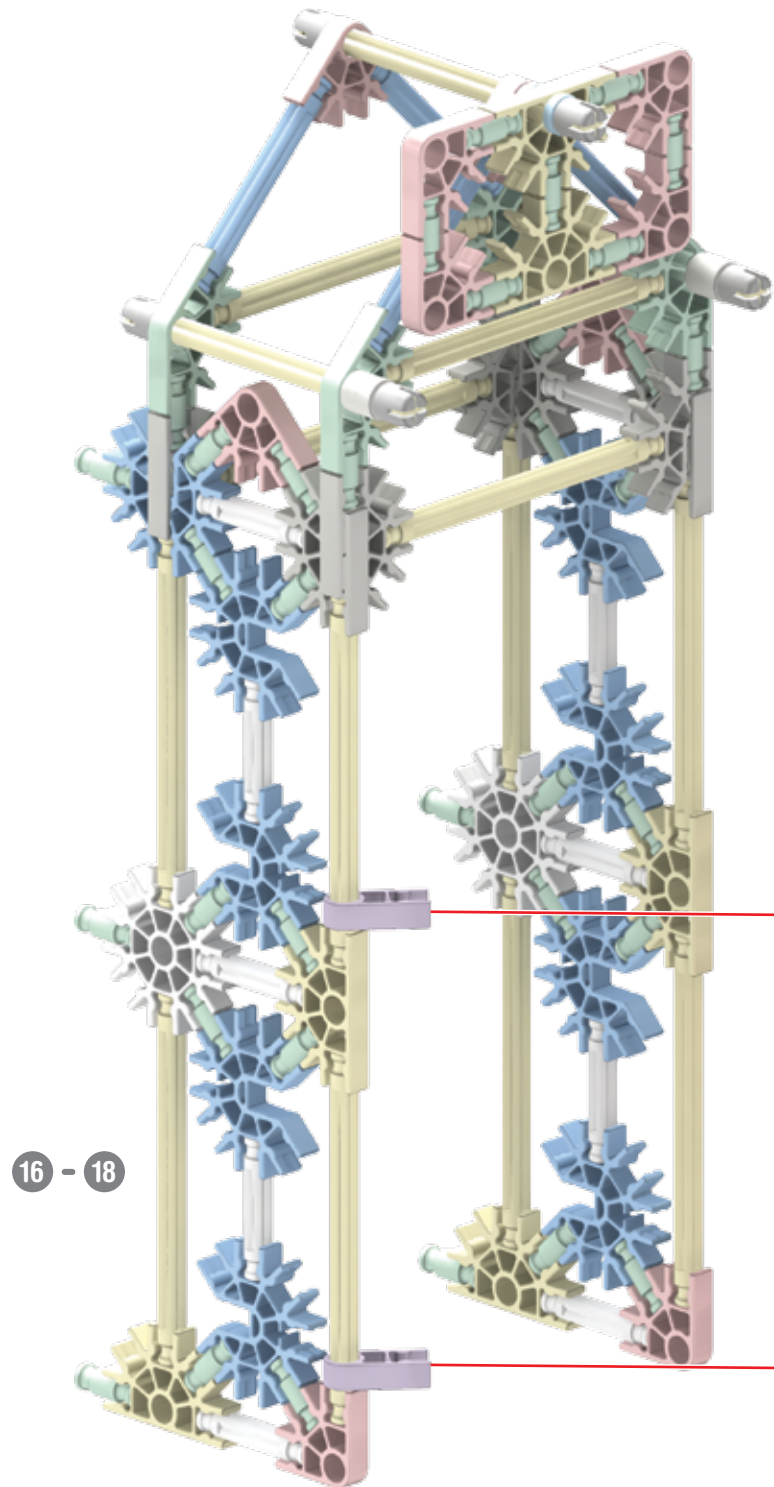

16 - 18

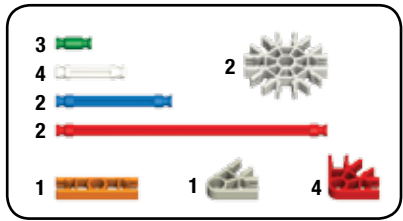

19

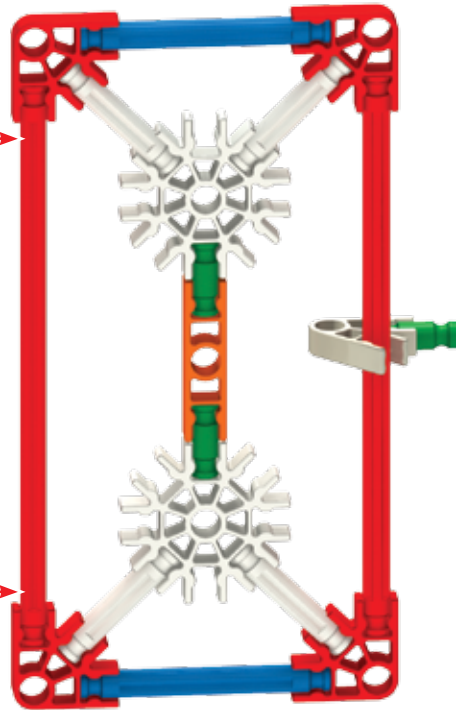

16 - 19

Watermill

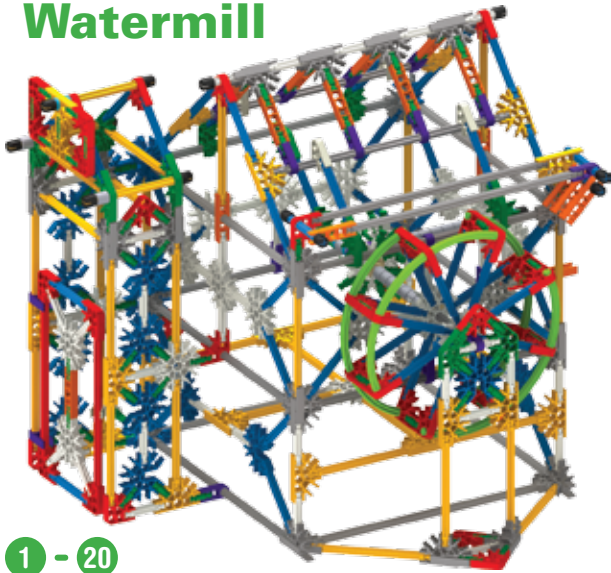

1 - 20

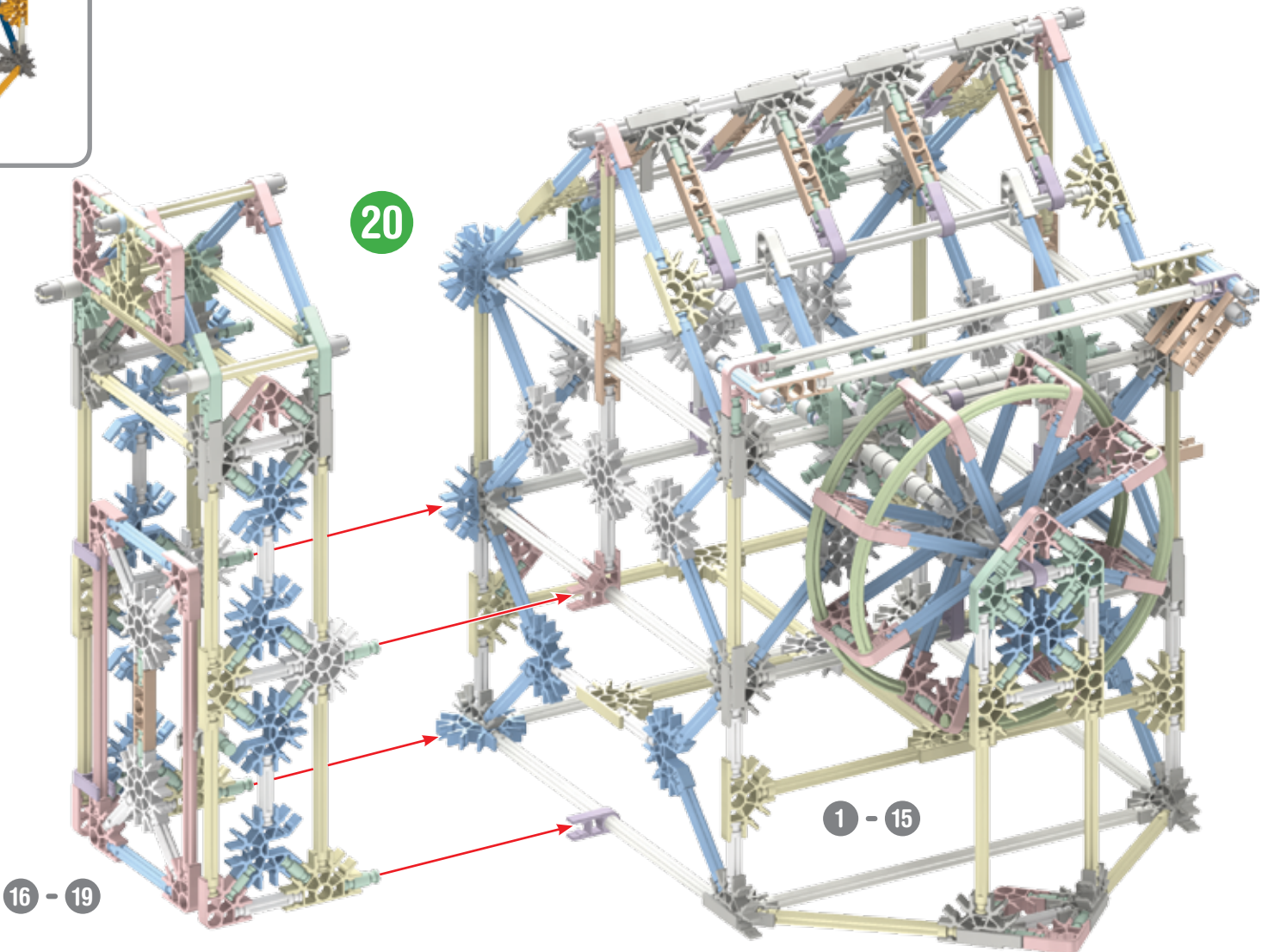

20

1 - 15

16 - 19