

15426

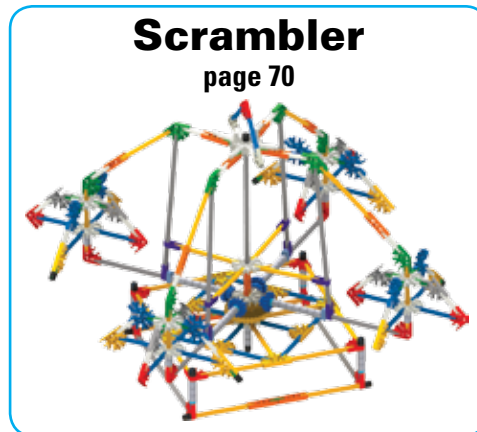

**100 MODEL ULTRA
BUILDING SET**

AMUSEMENT PARK RIDES

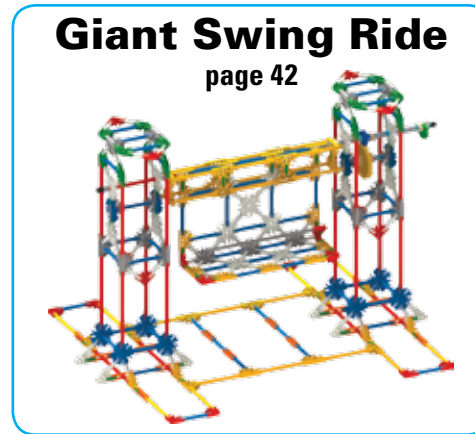
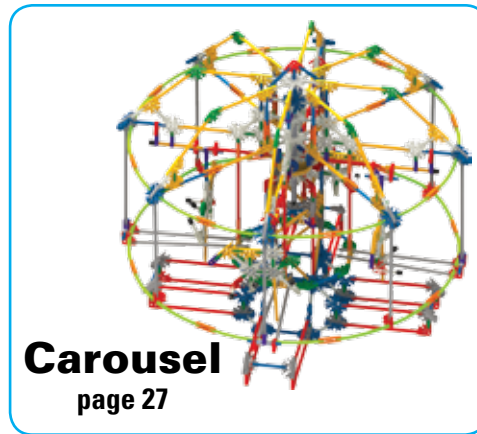
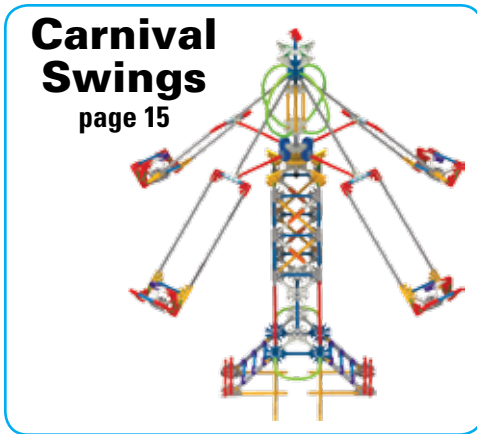
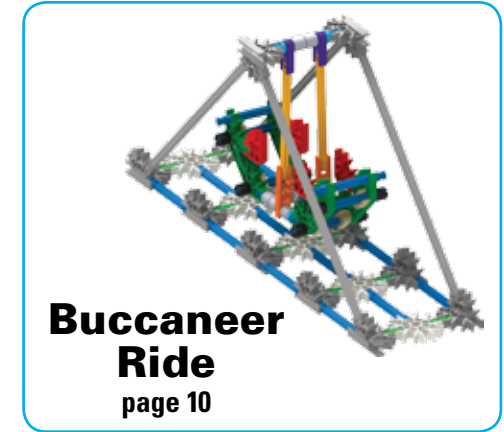
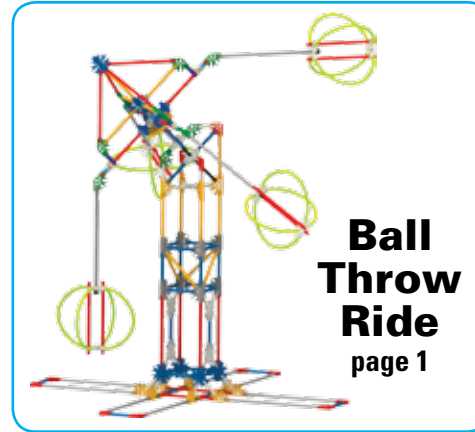

Ball Throw Ride

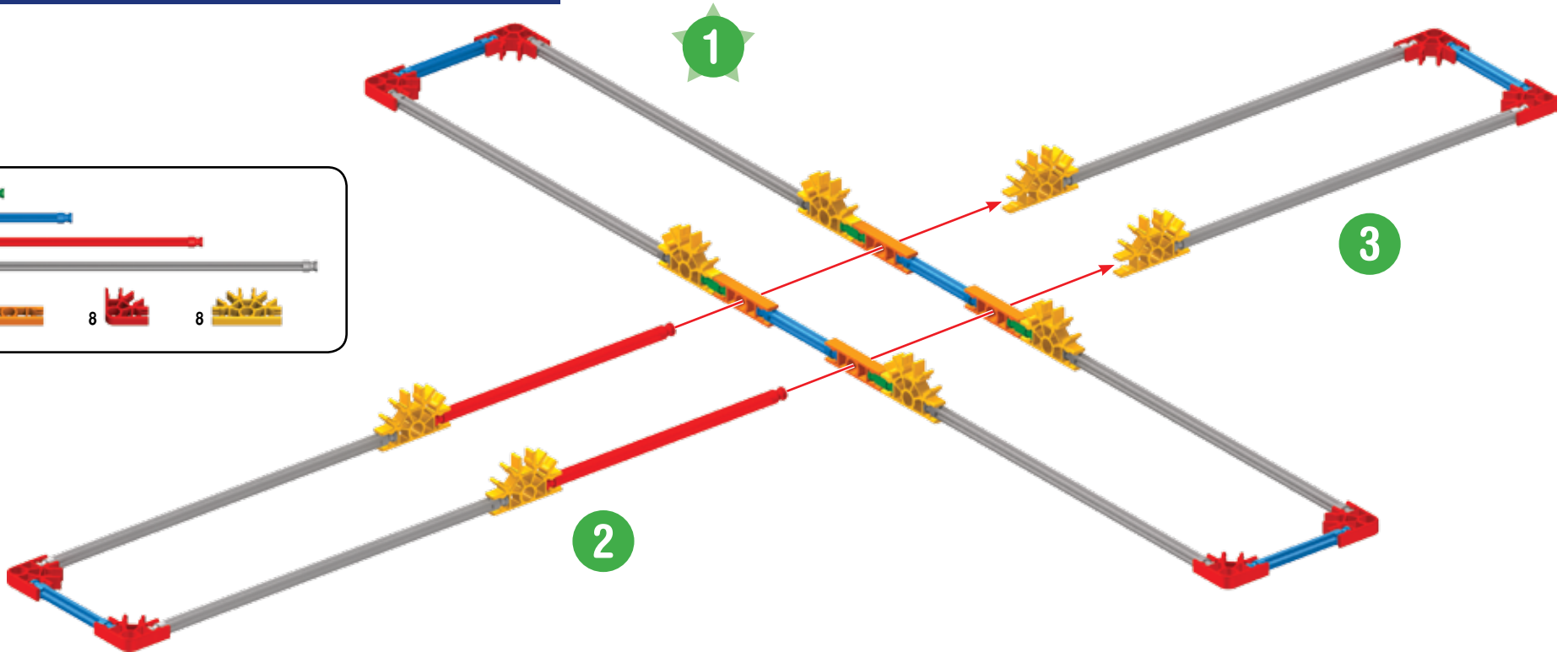
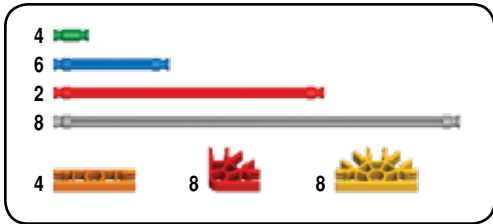
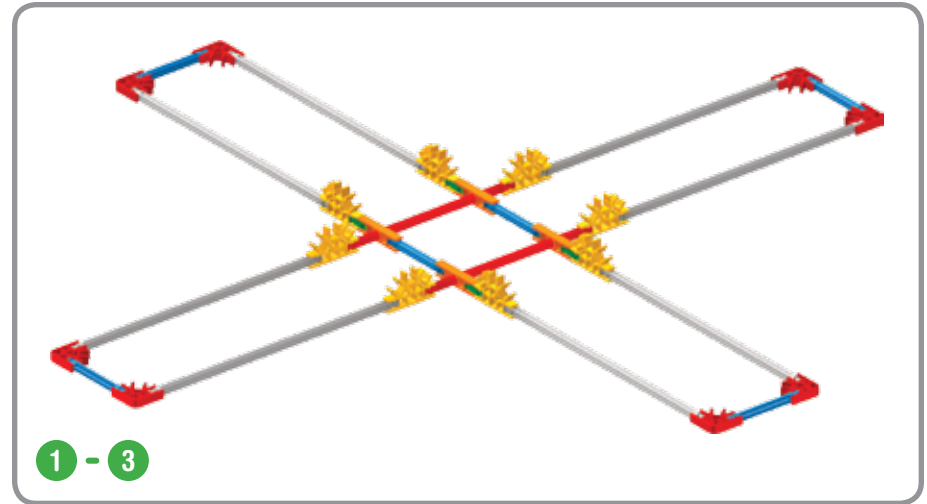

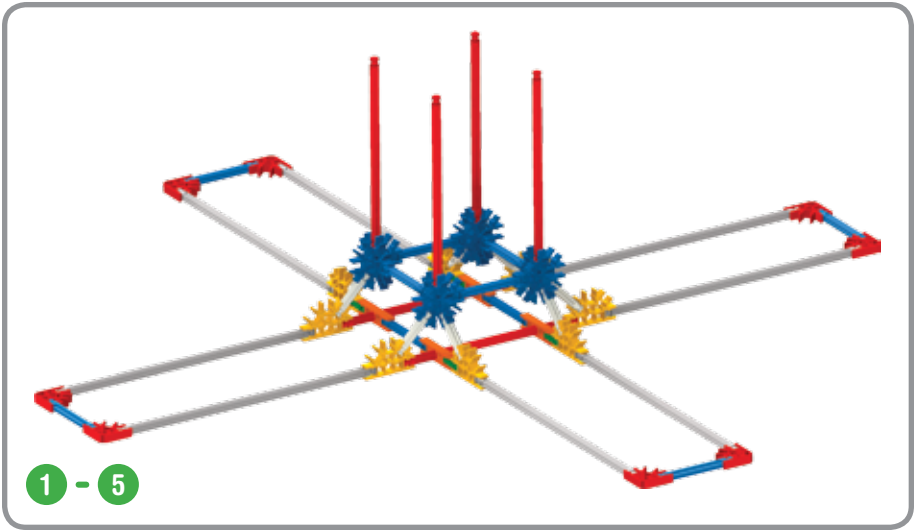
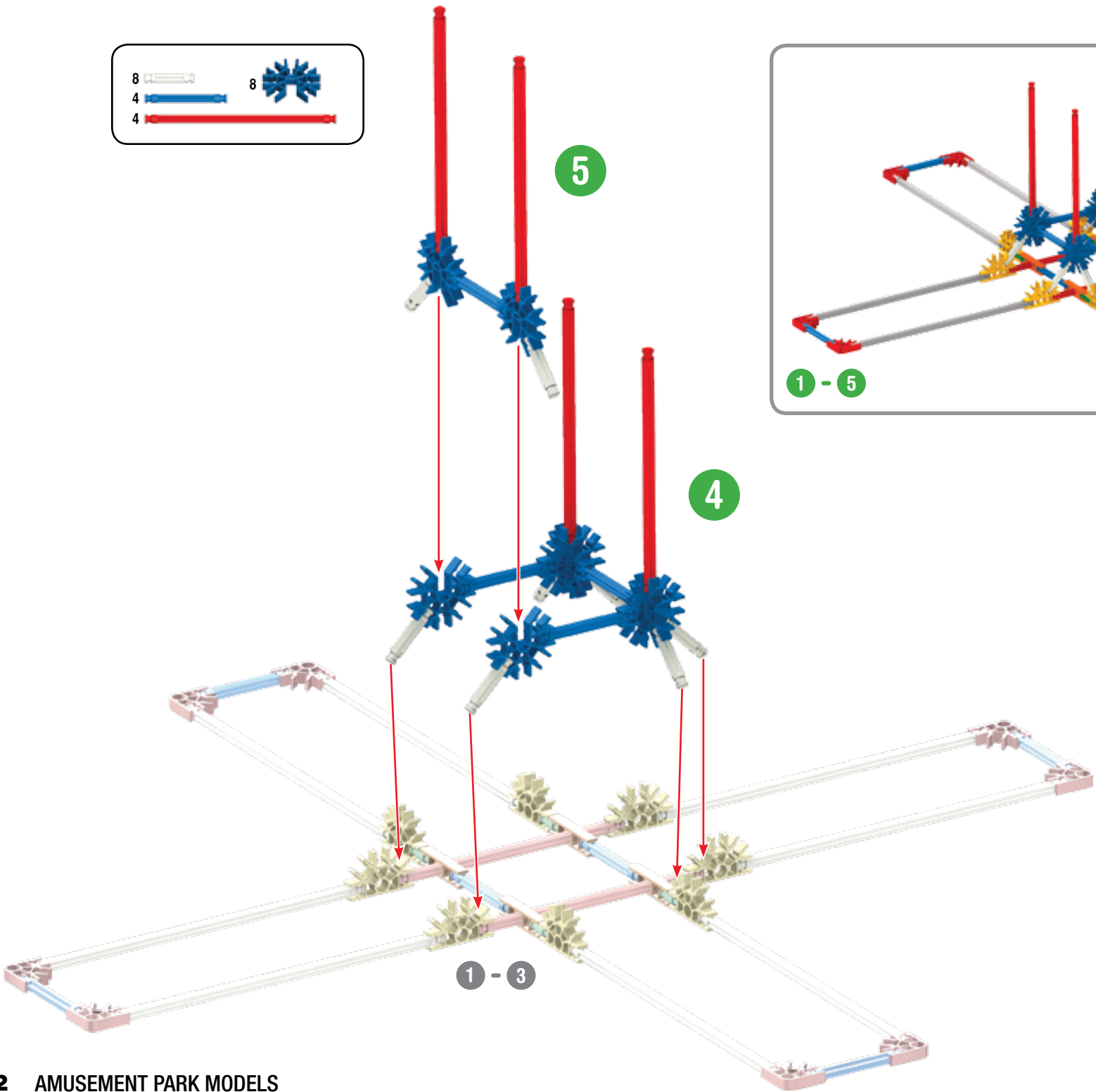
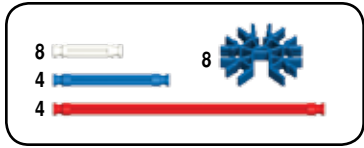

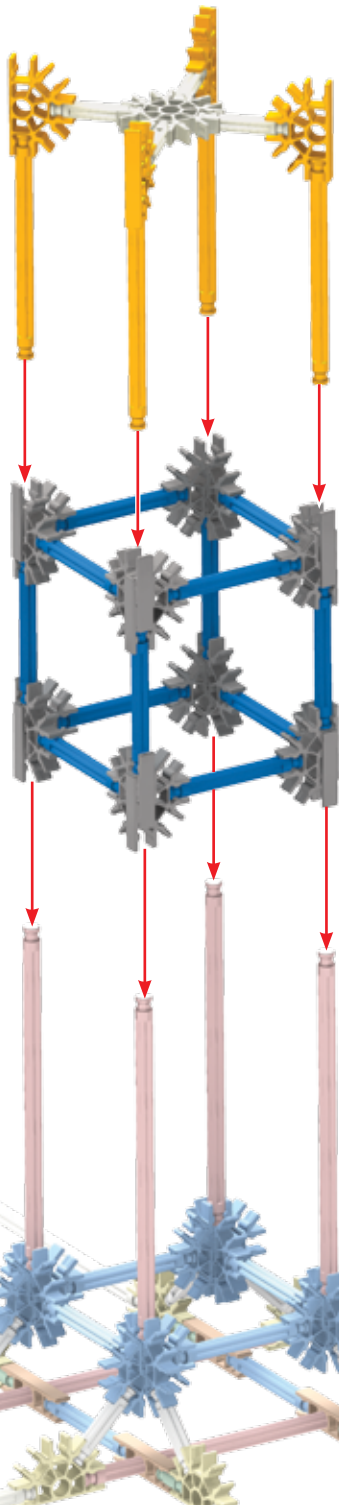
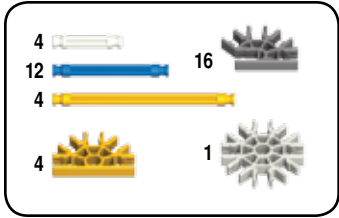

7

6

1 - 5

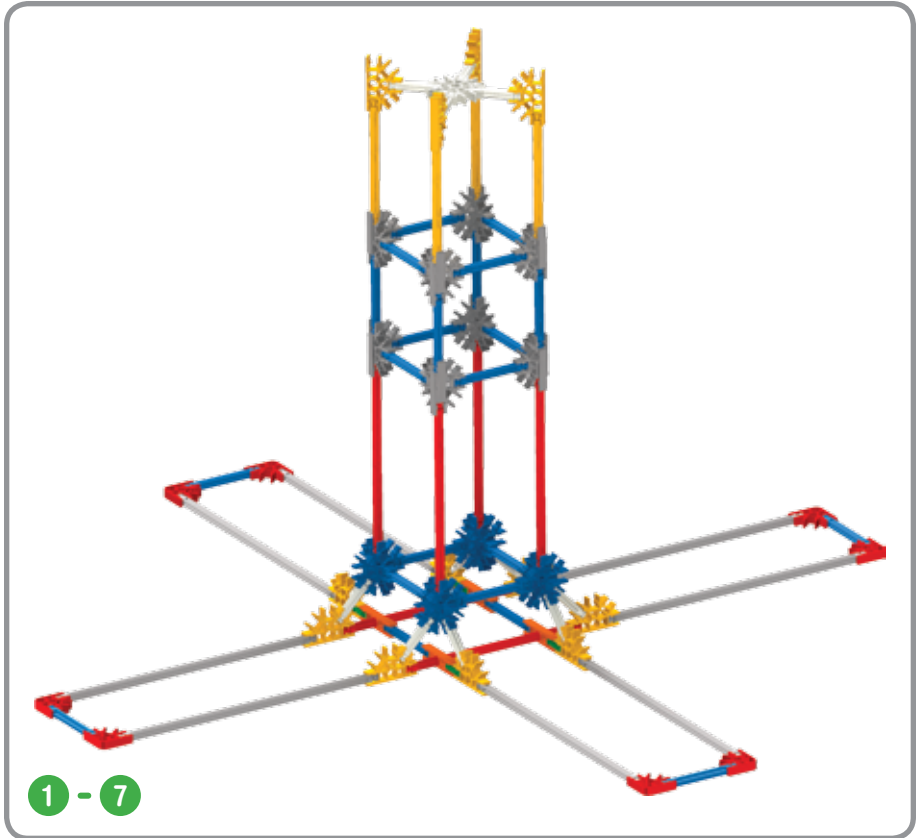

1 - 7

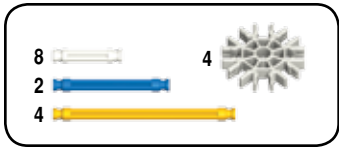





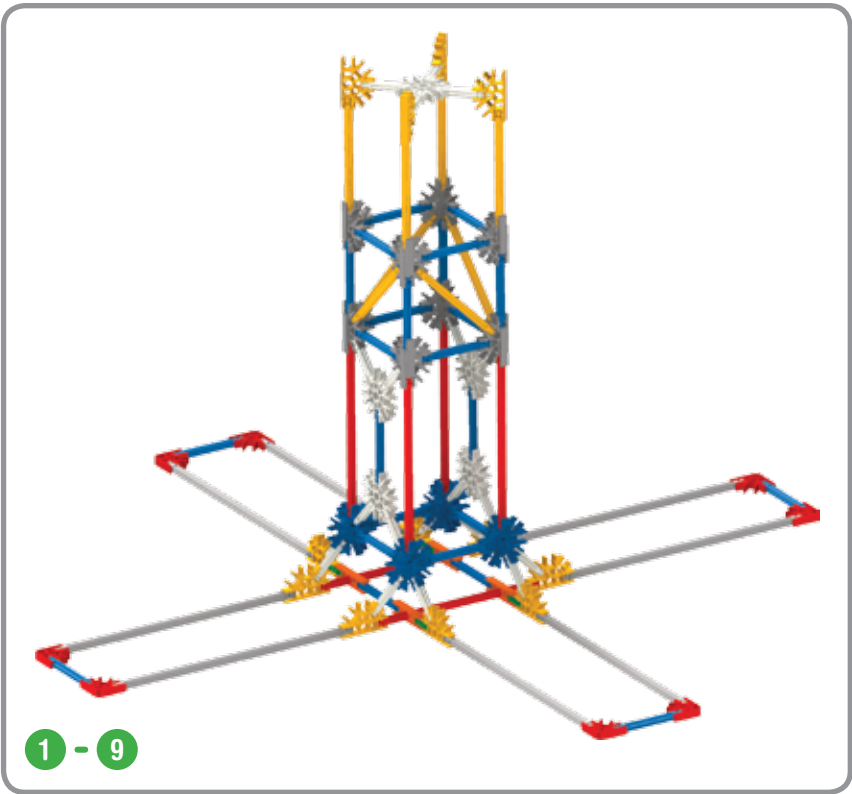

8

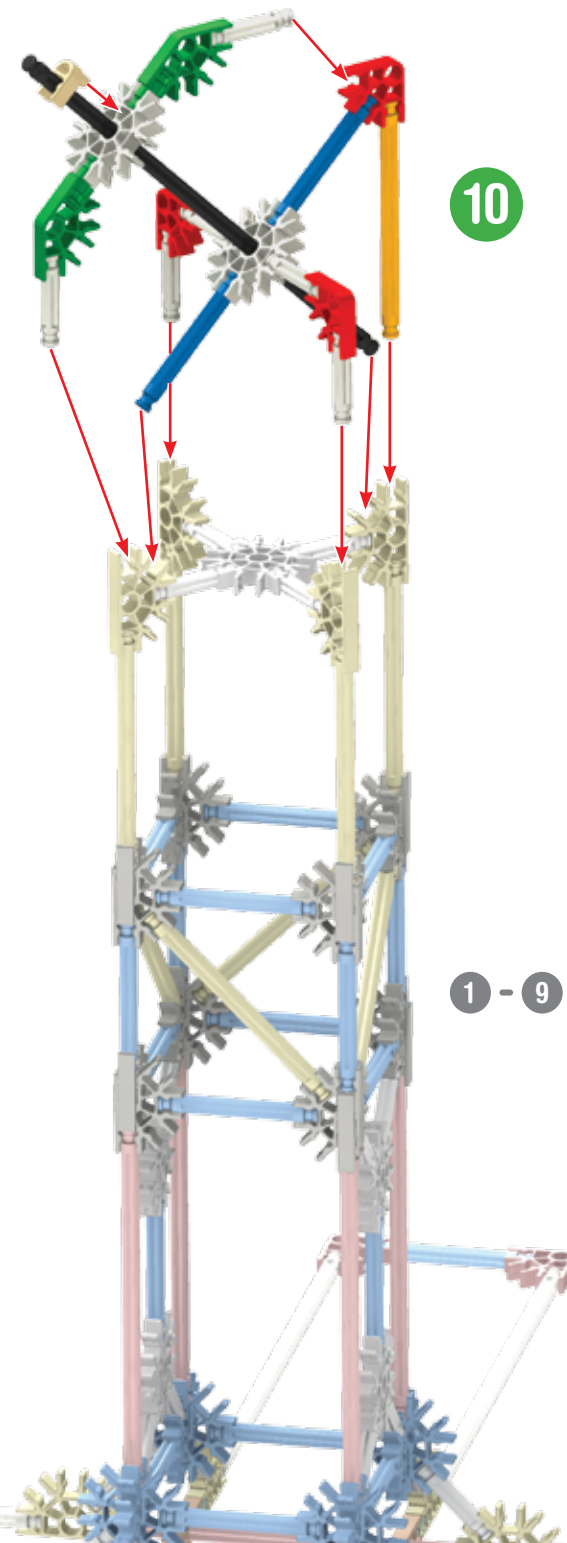
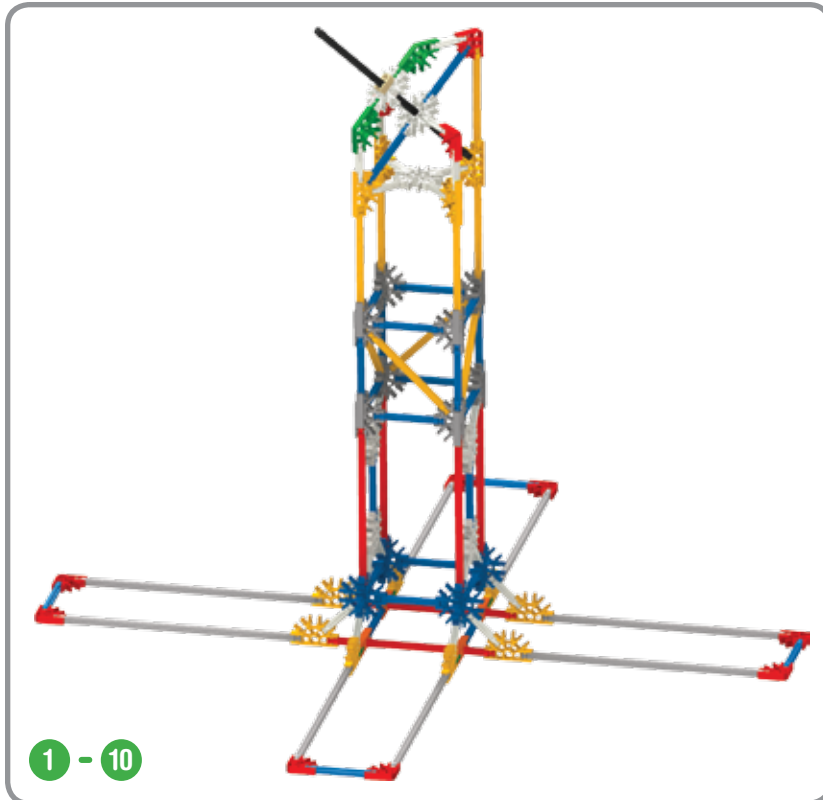
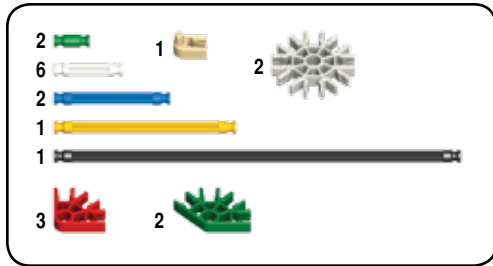
9

1 - 7





1		2	
2			
1		1	

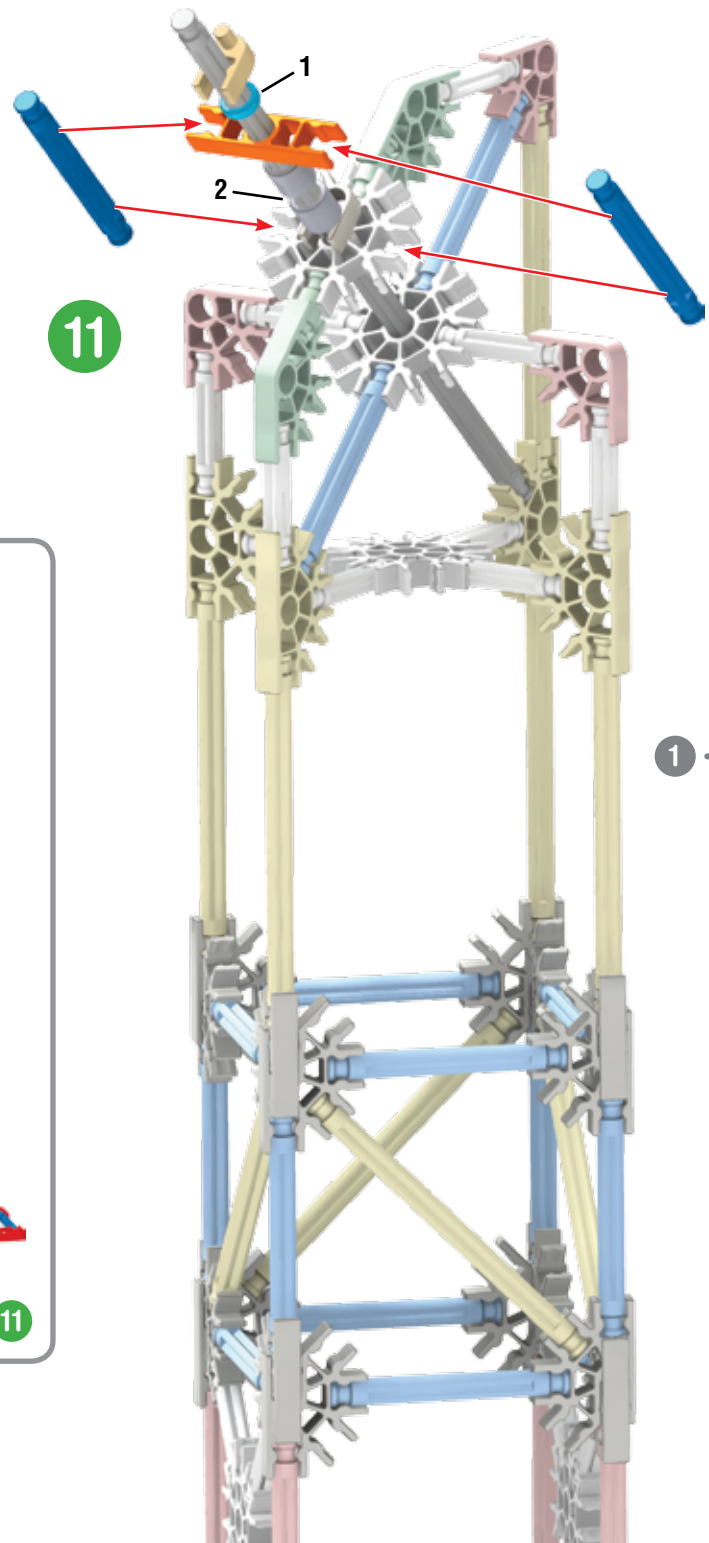
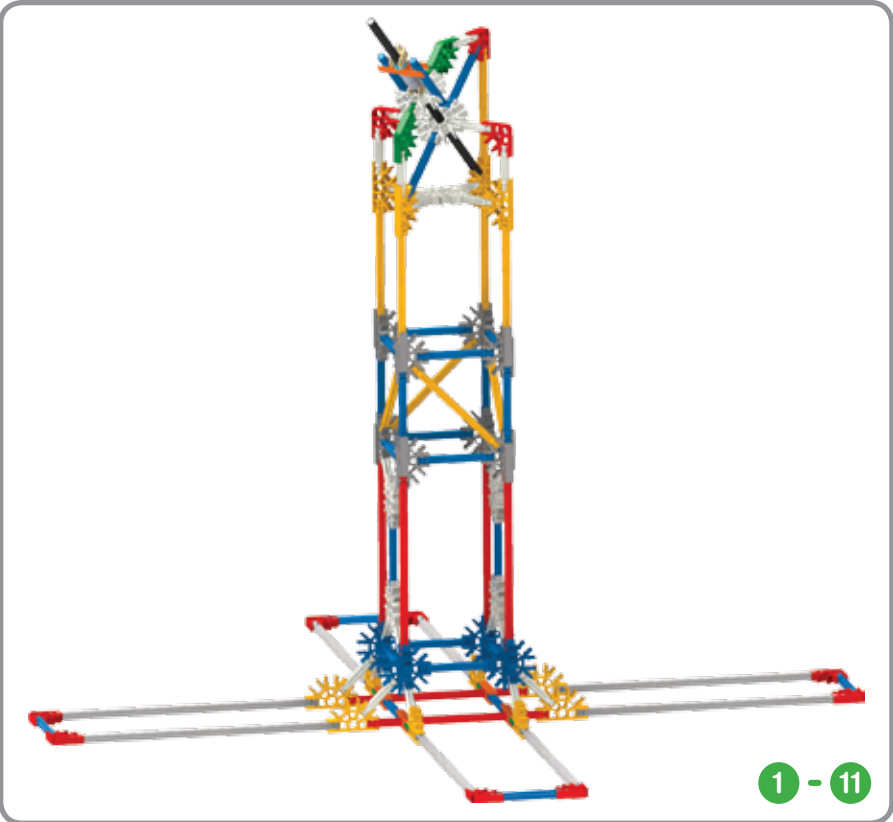

1 - 10

1 - 11

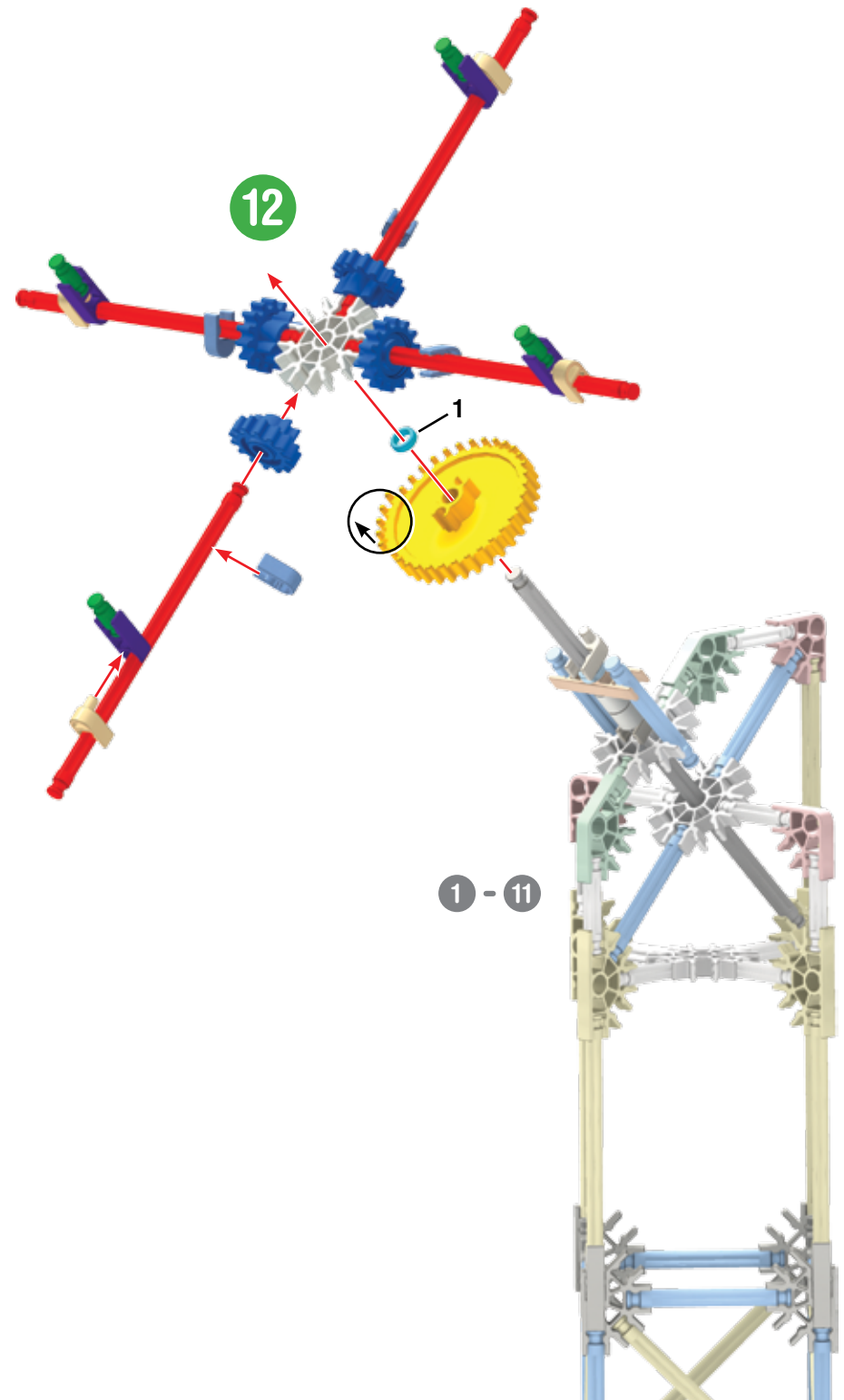
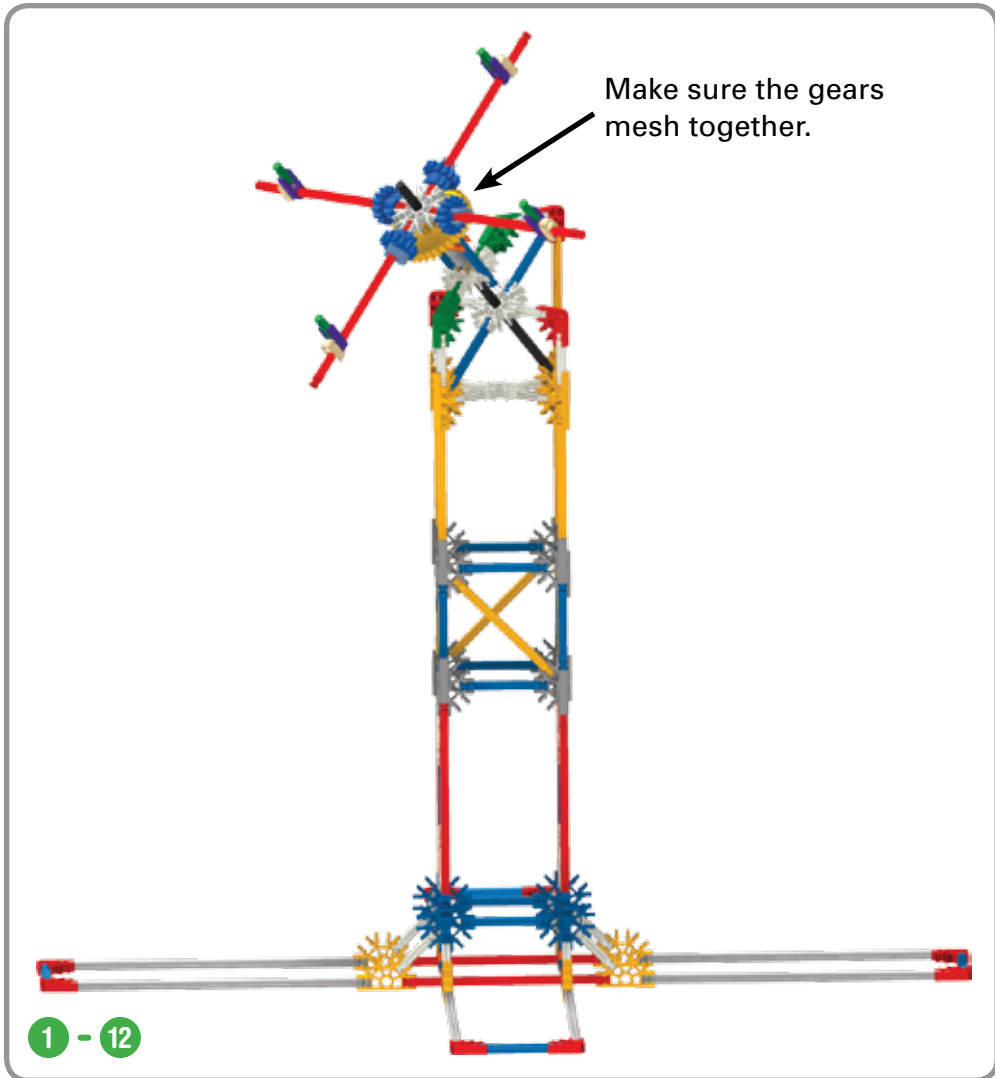
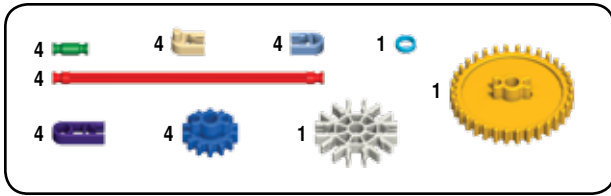

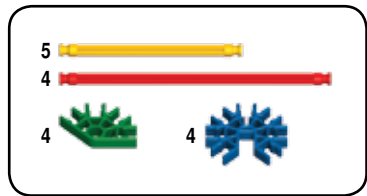
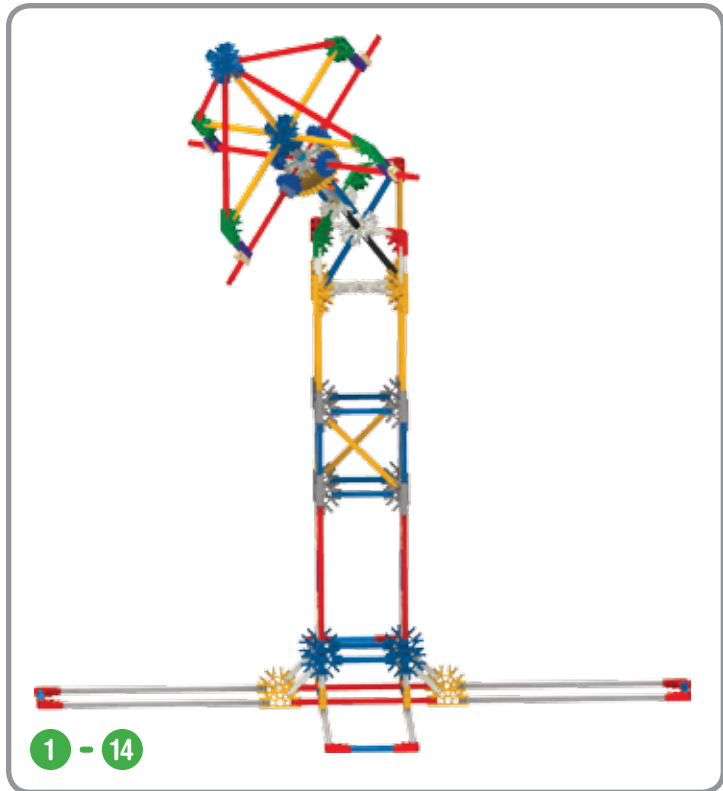

14

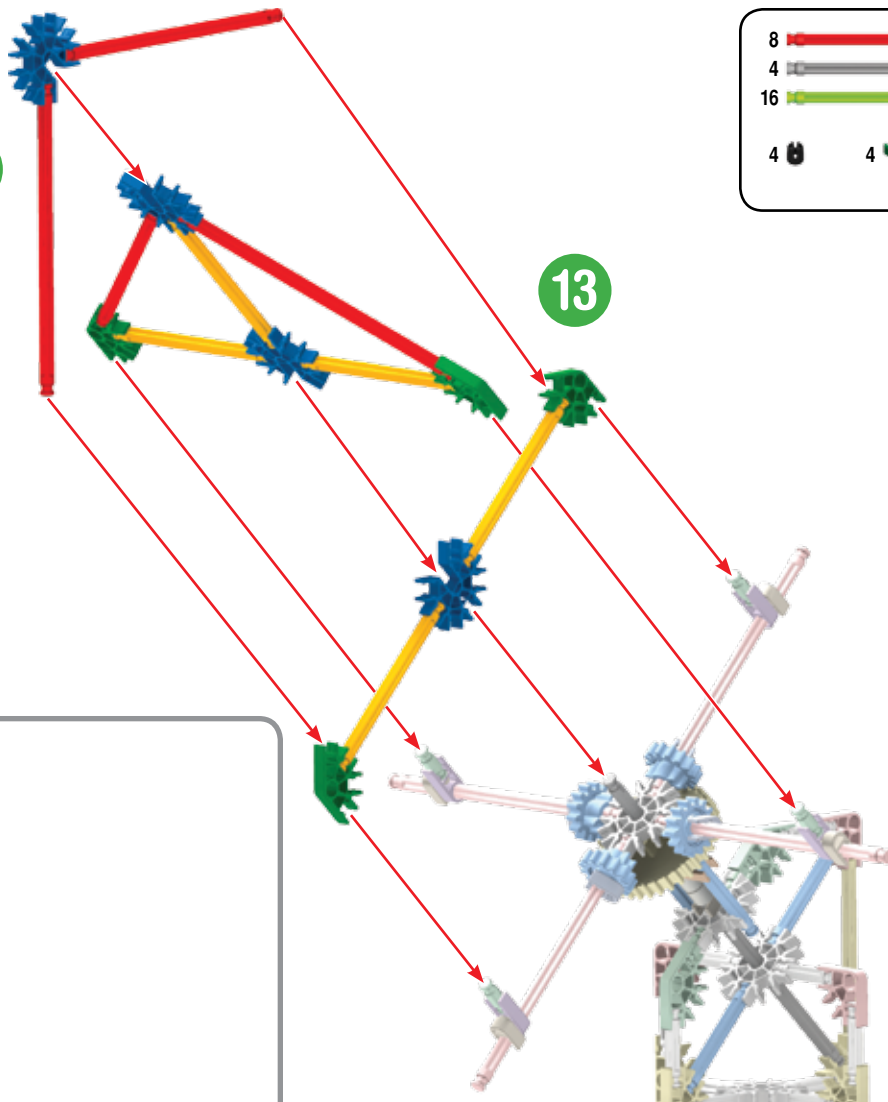

13

1 - 12

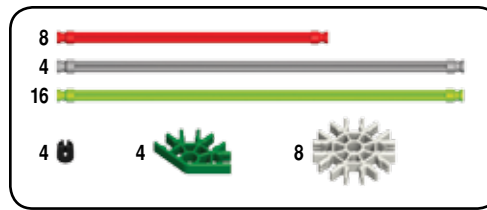

15

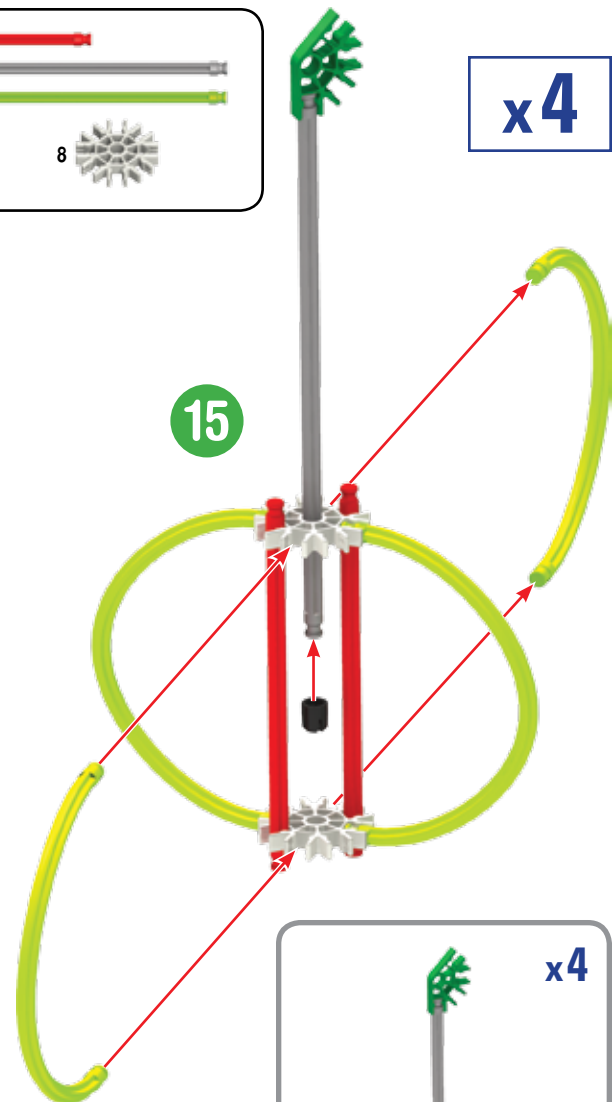

x4

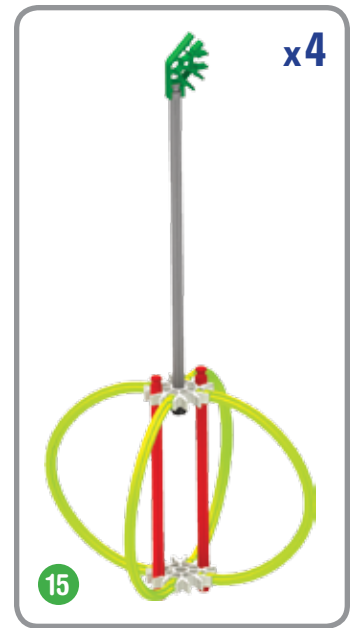

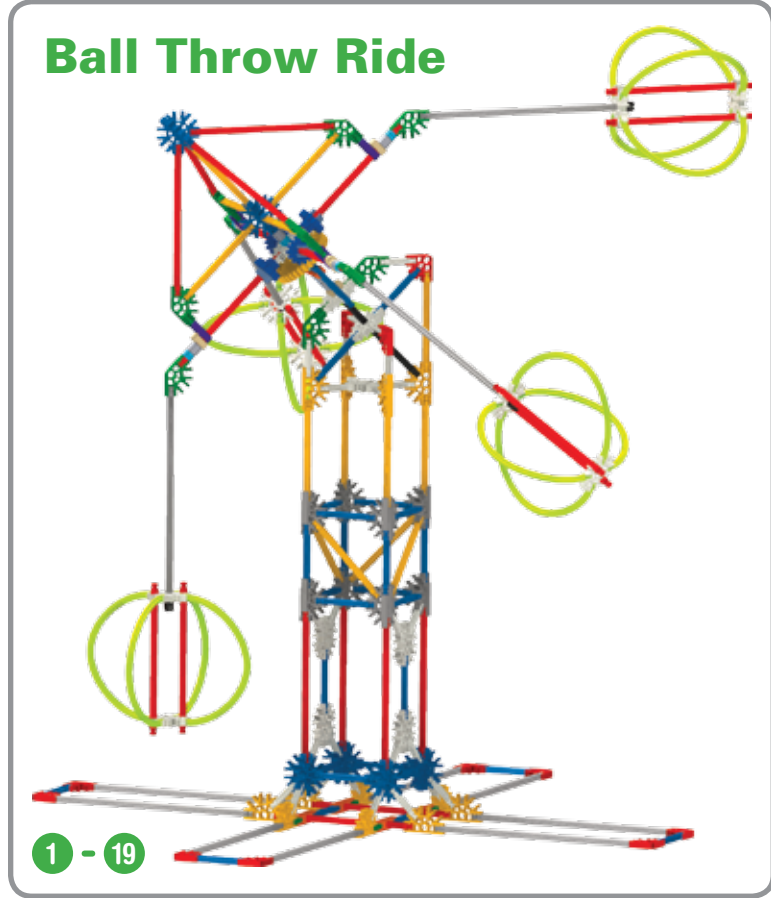
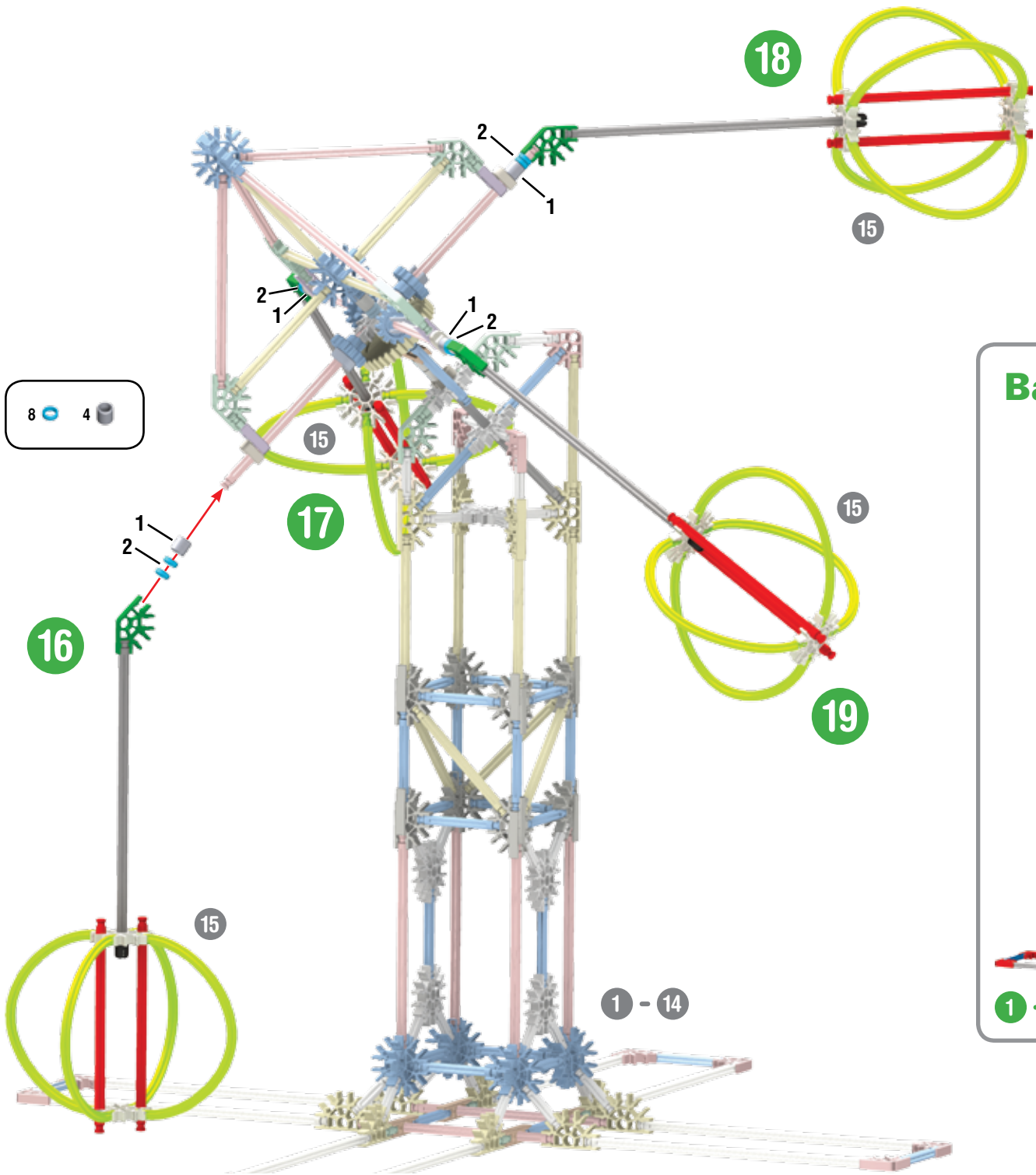

Buccaneer Ride

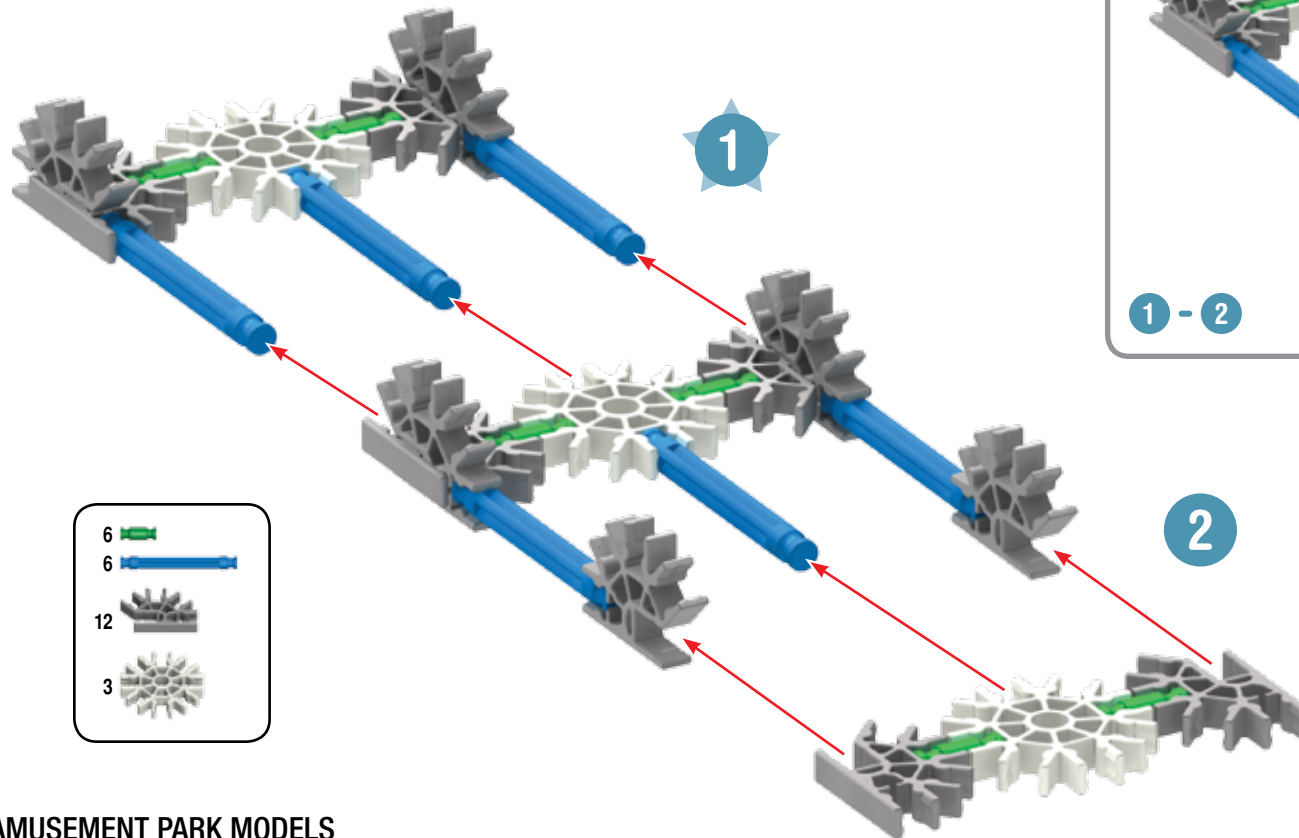
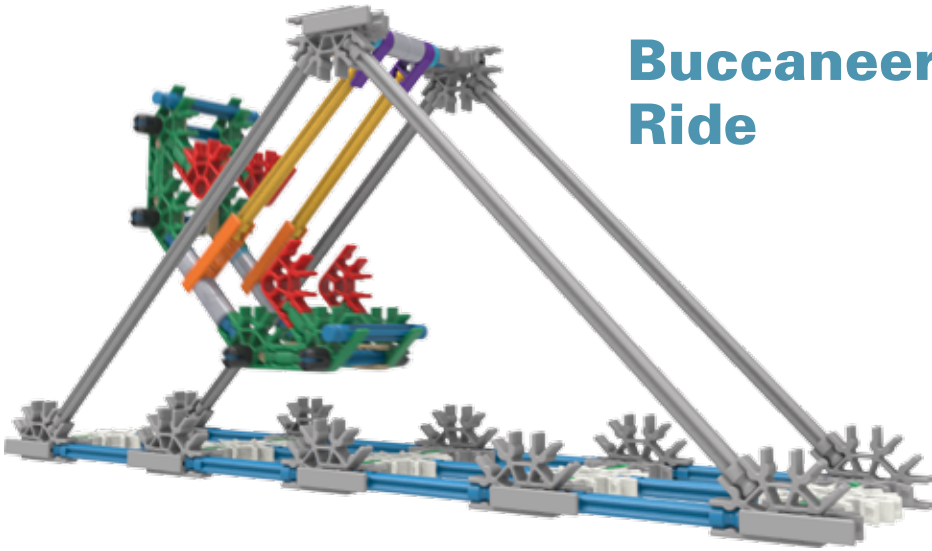

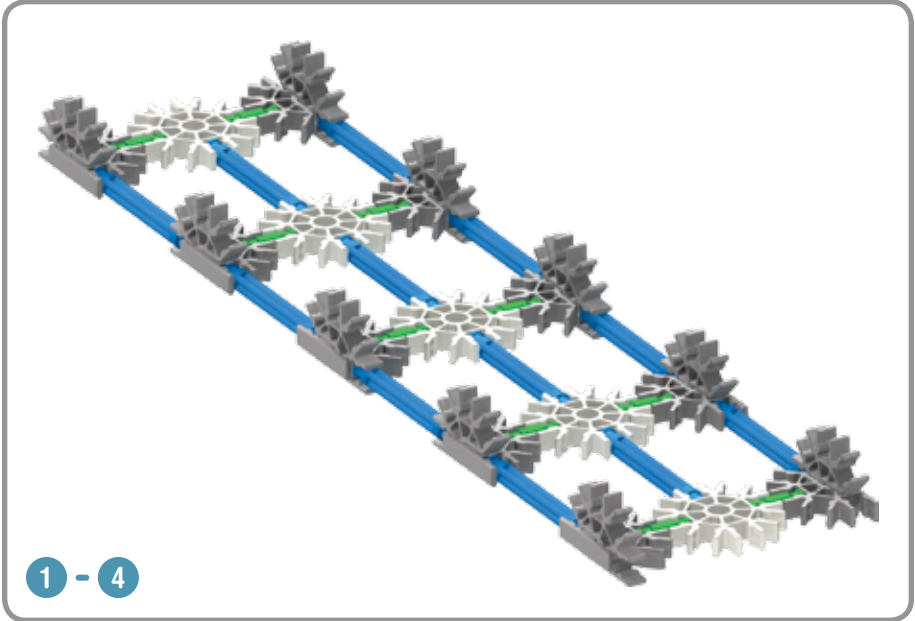
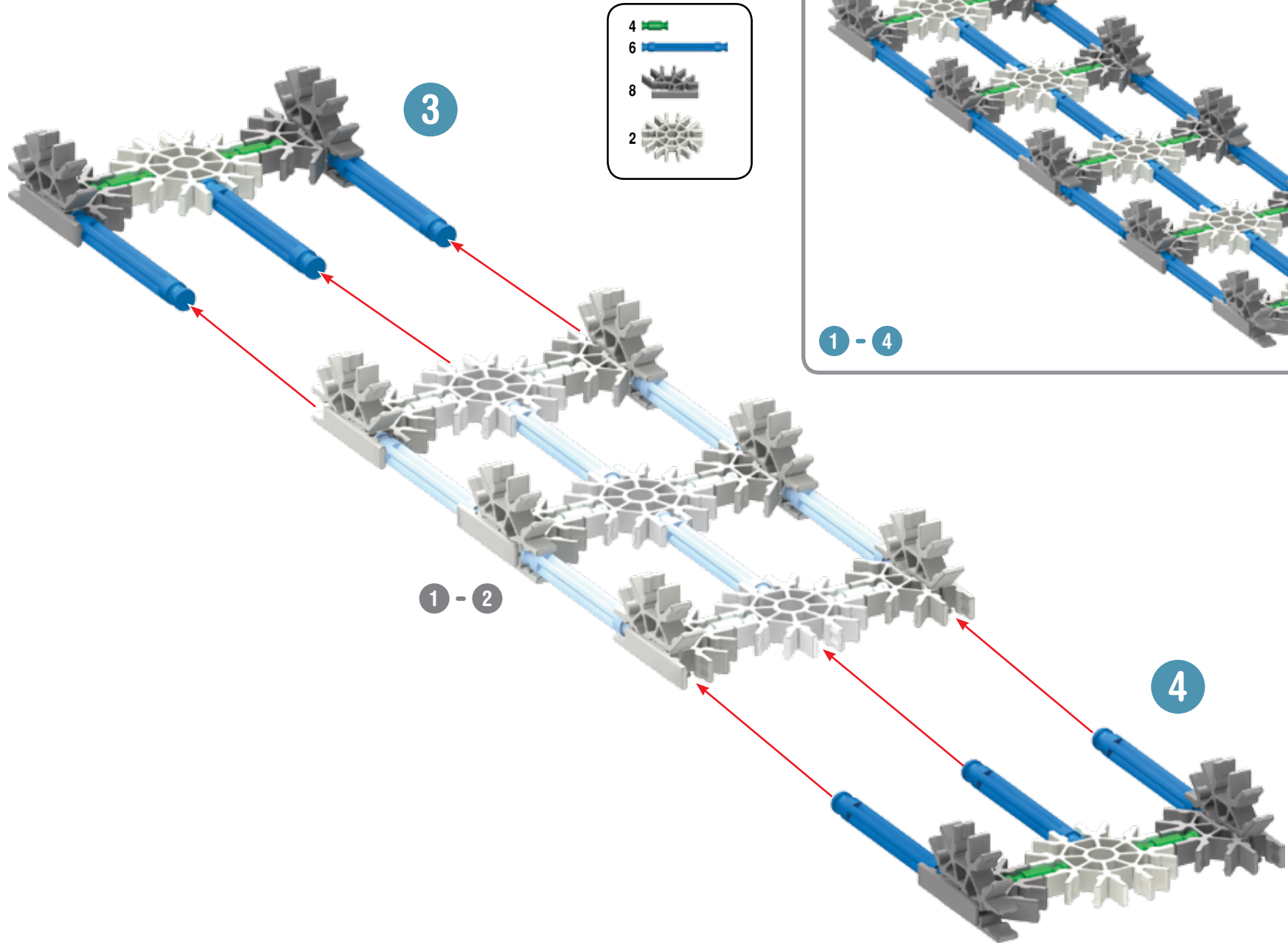

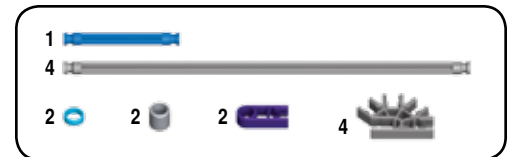
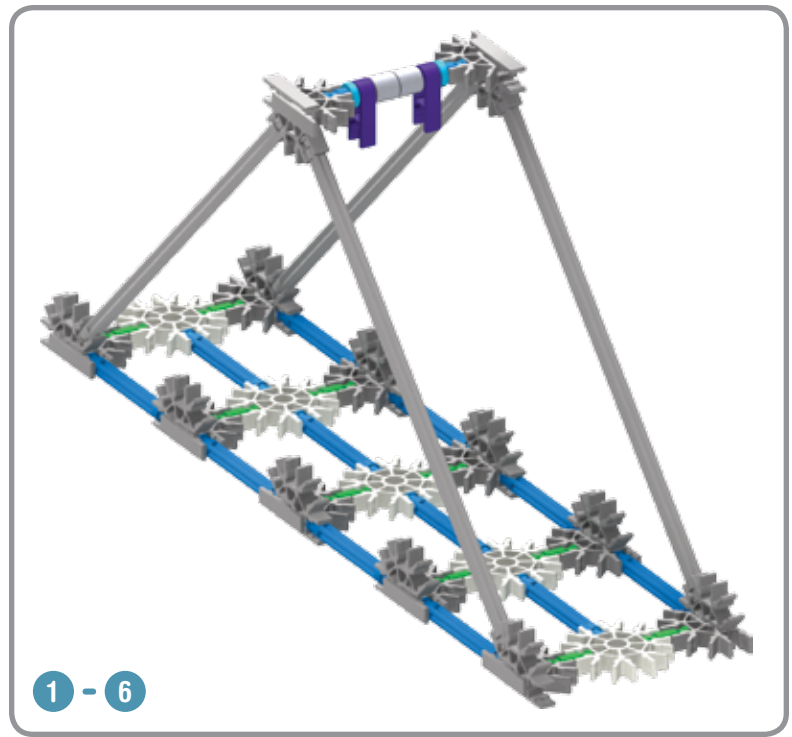
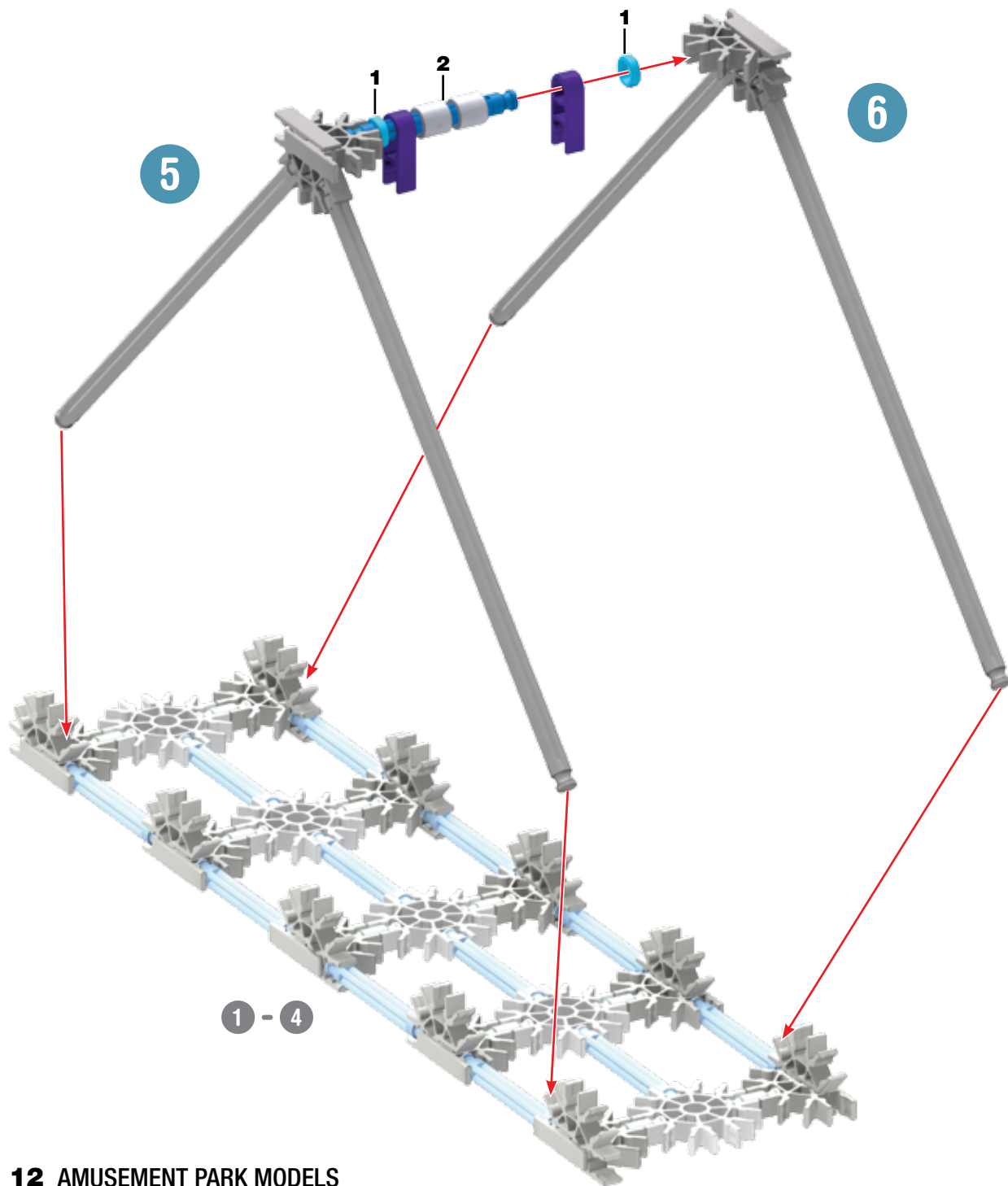

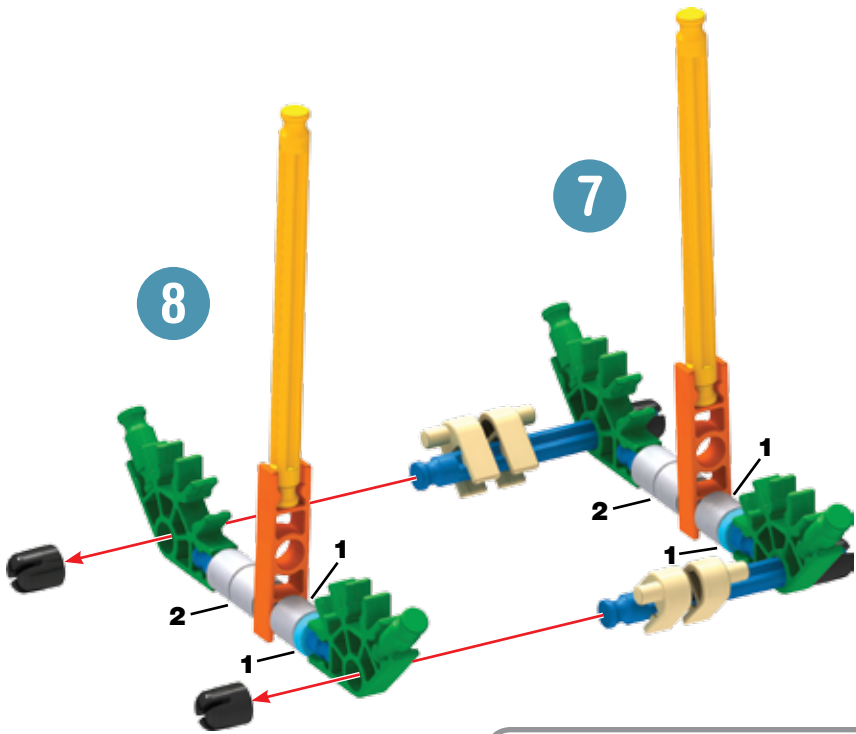

- | | | | |
|---|--|---|--|
| 4 | | 4 | |
| 4 | | | |
| 2 | | | |
| 4 | | 2 | |
| 2 | | | |
| 6 | | 4 | |

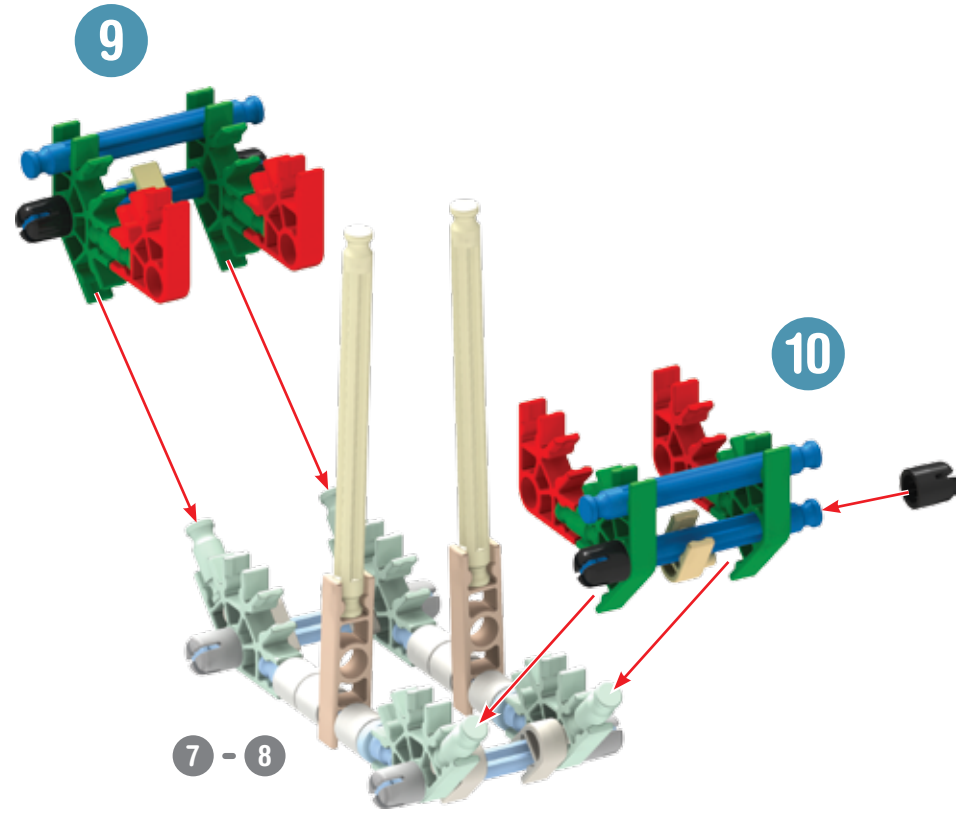

- | | | | |
|---|--|---|--|
| 4 | | | |
| 4 | | | |
| 4 | | 4 | |
| 2 | | 4 | |



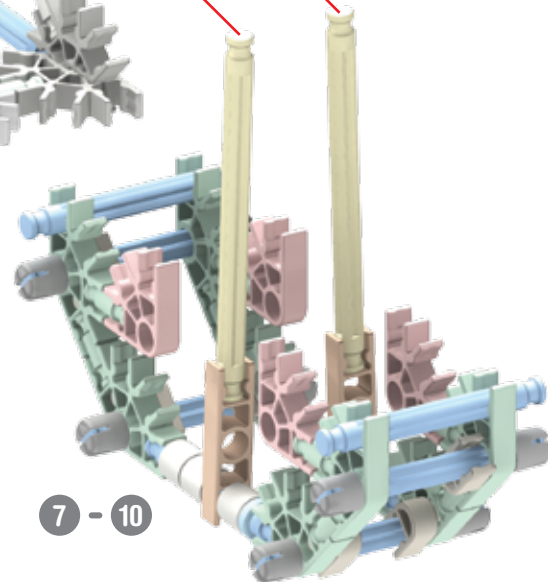
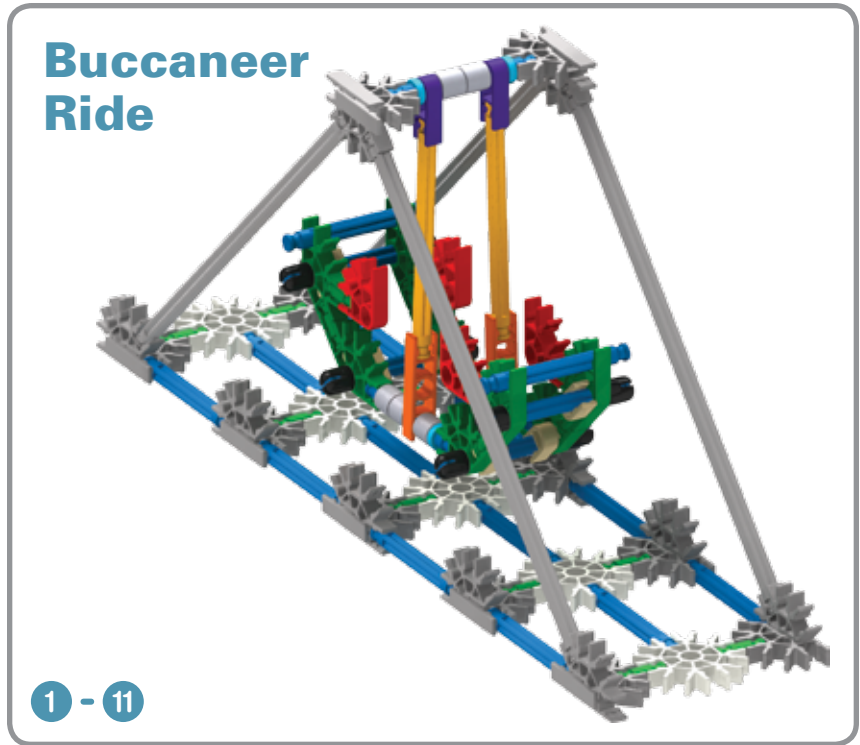
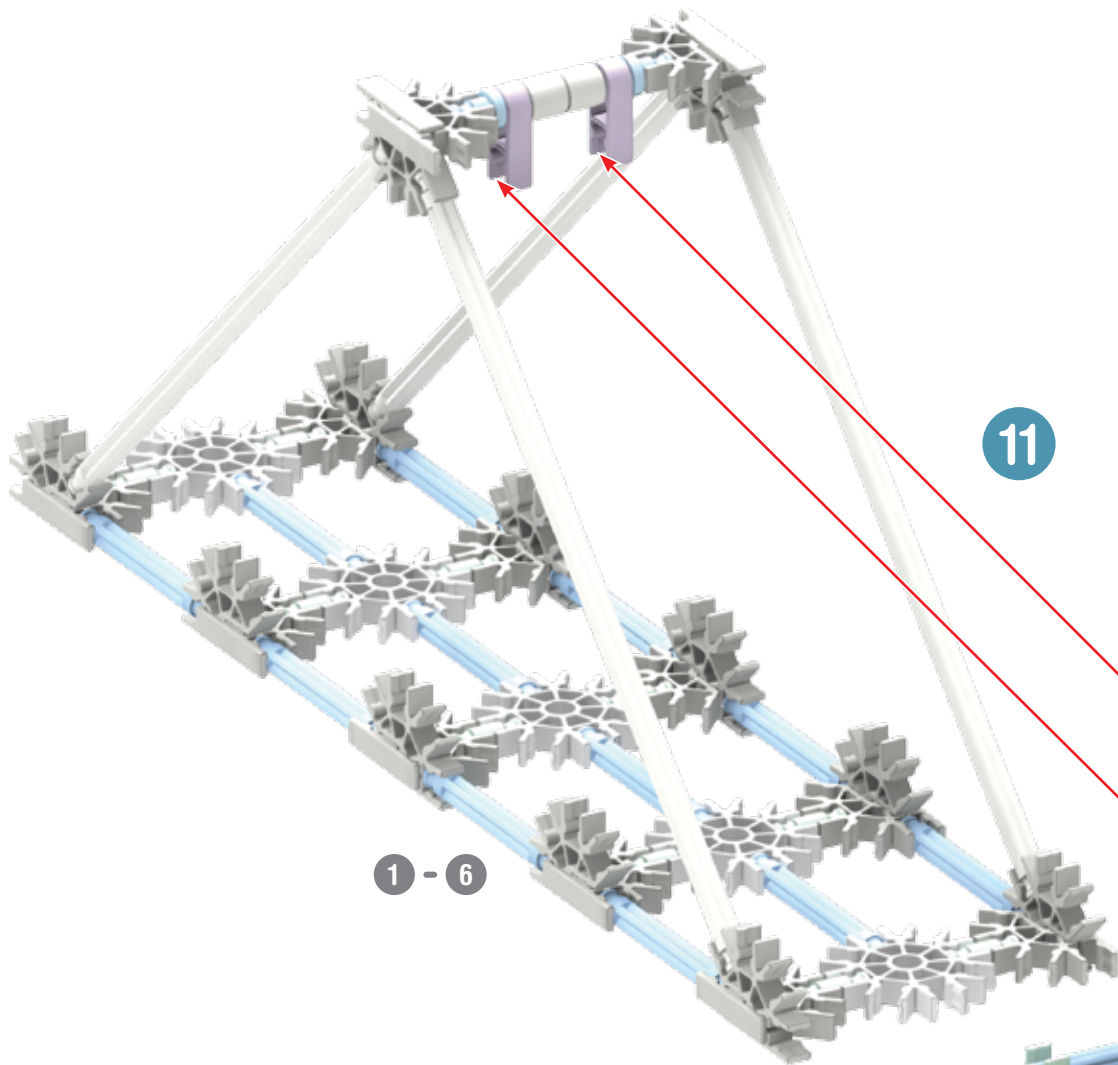

Carnival Swings

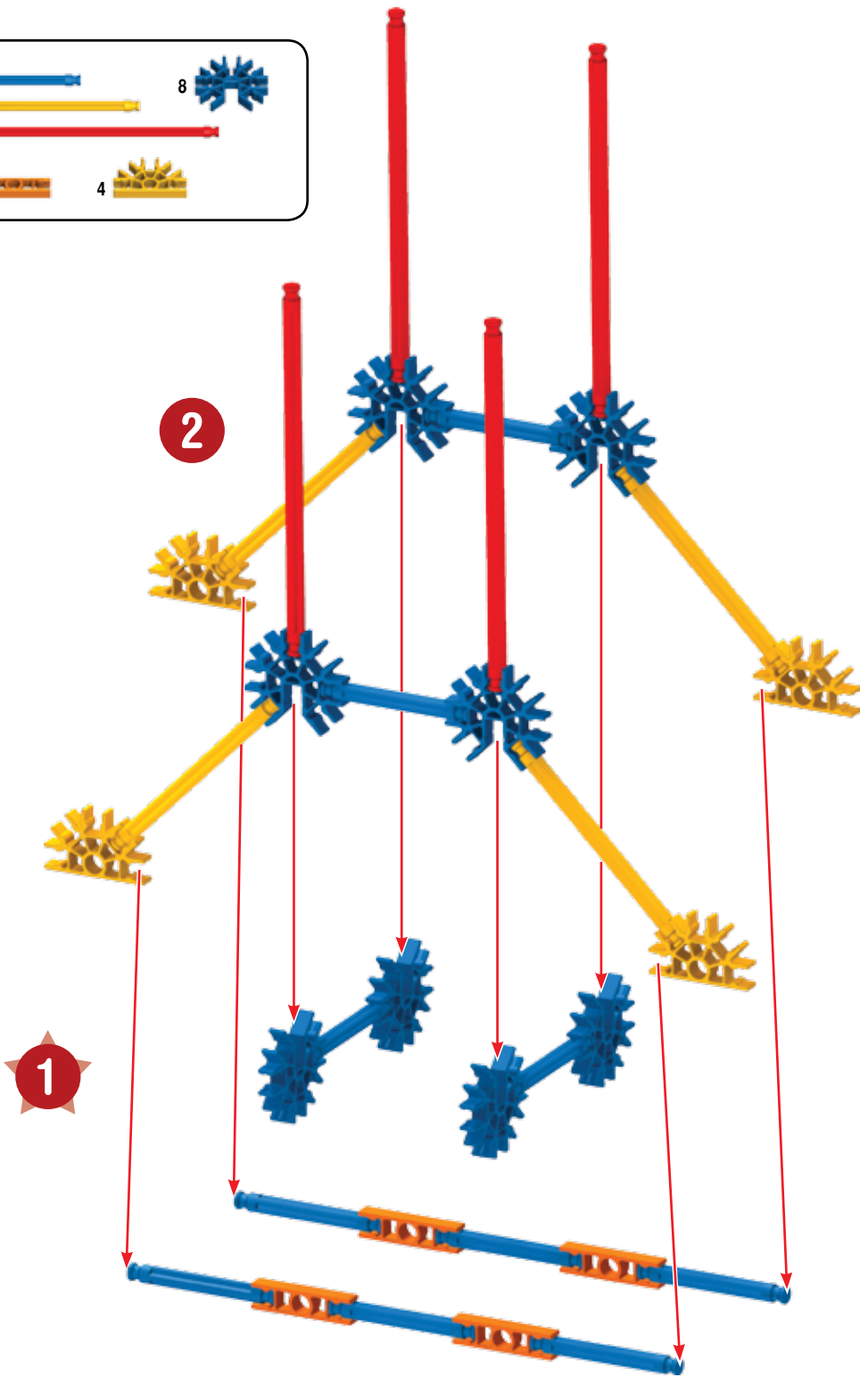
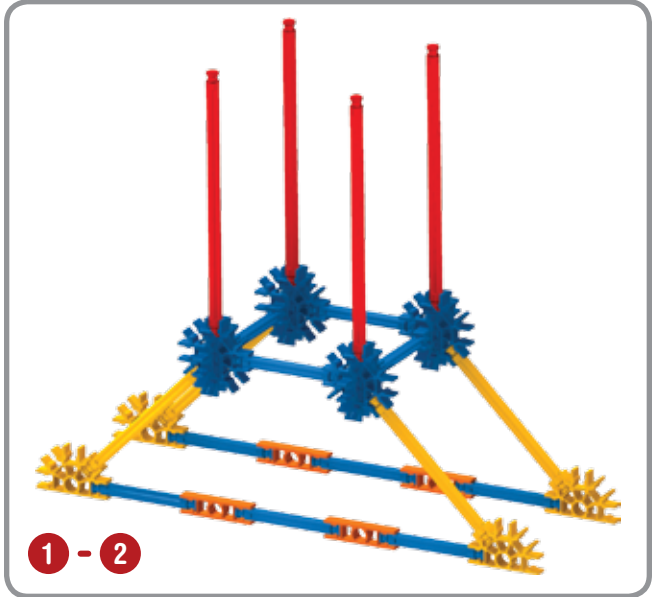
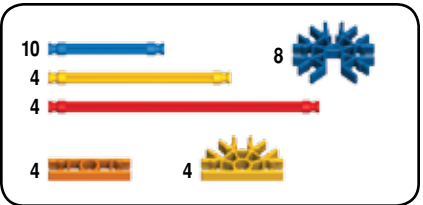

x2

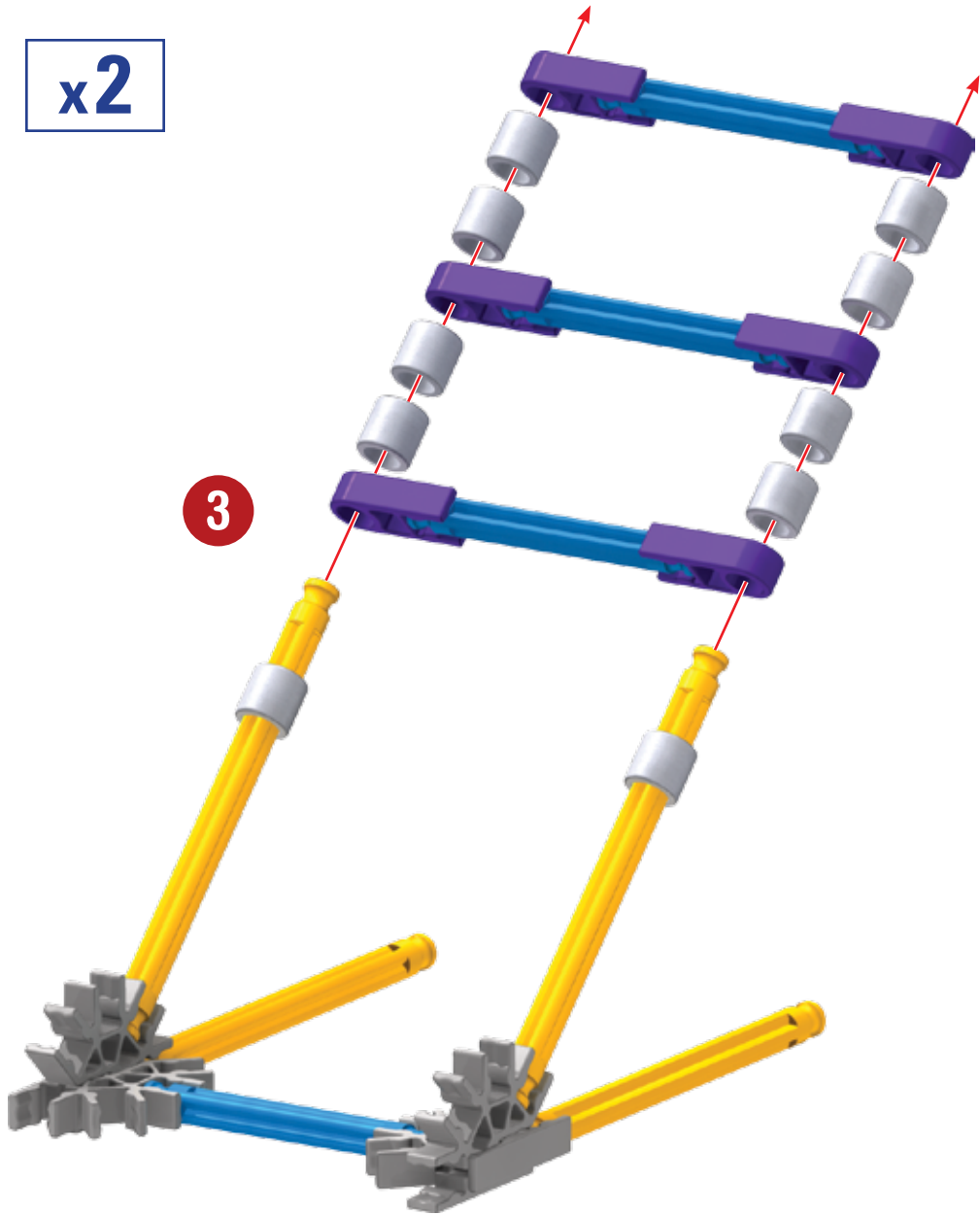

20		12		8	
8					
8					

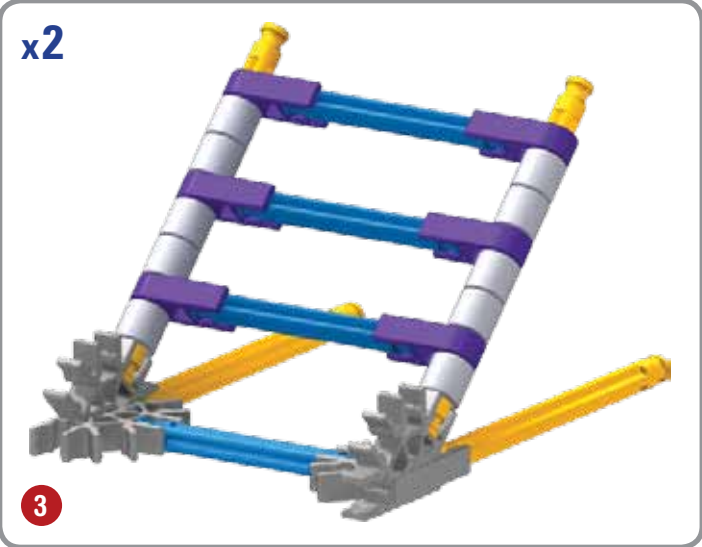

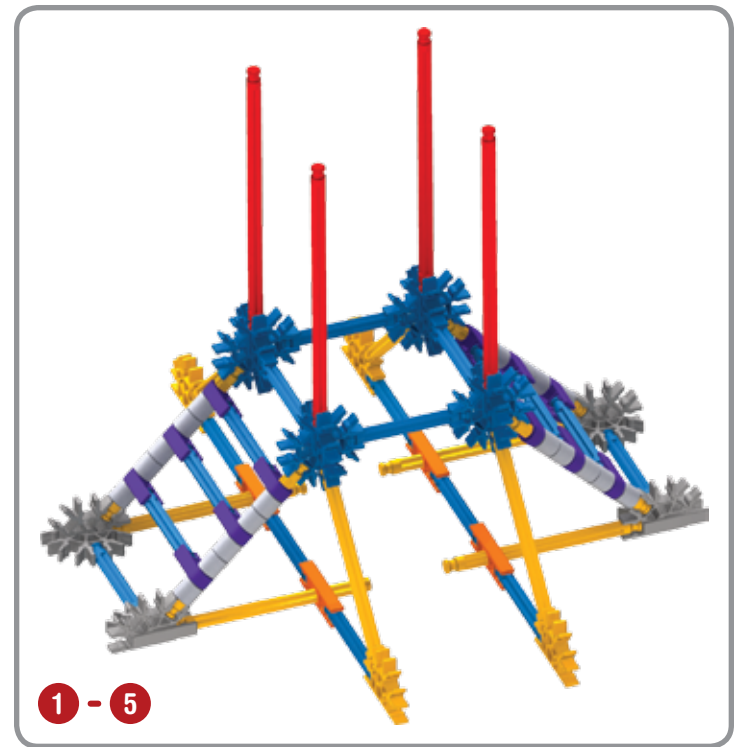
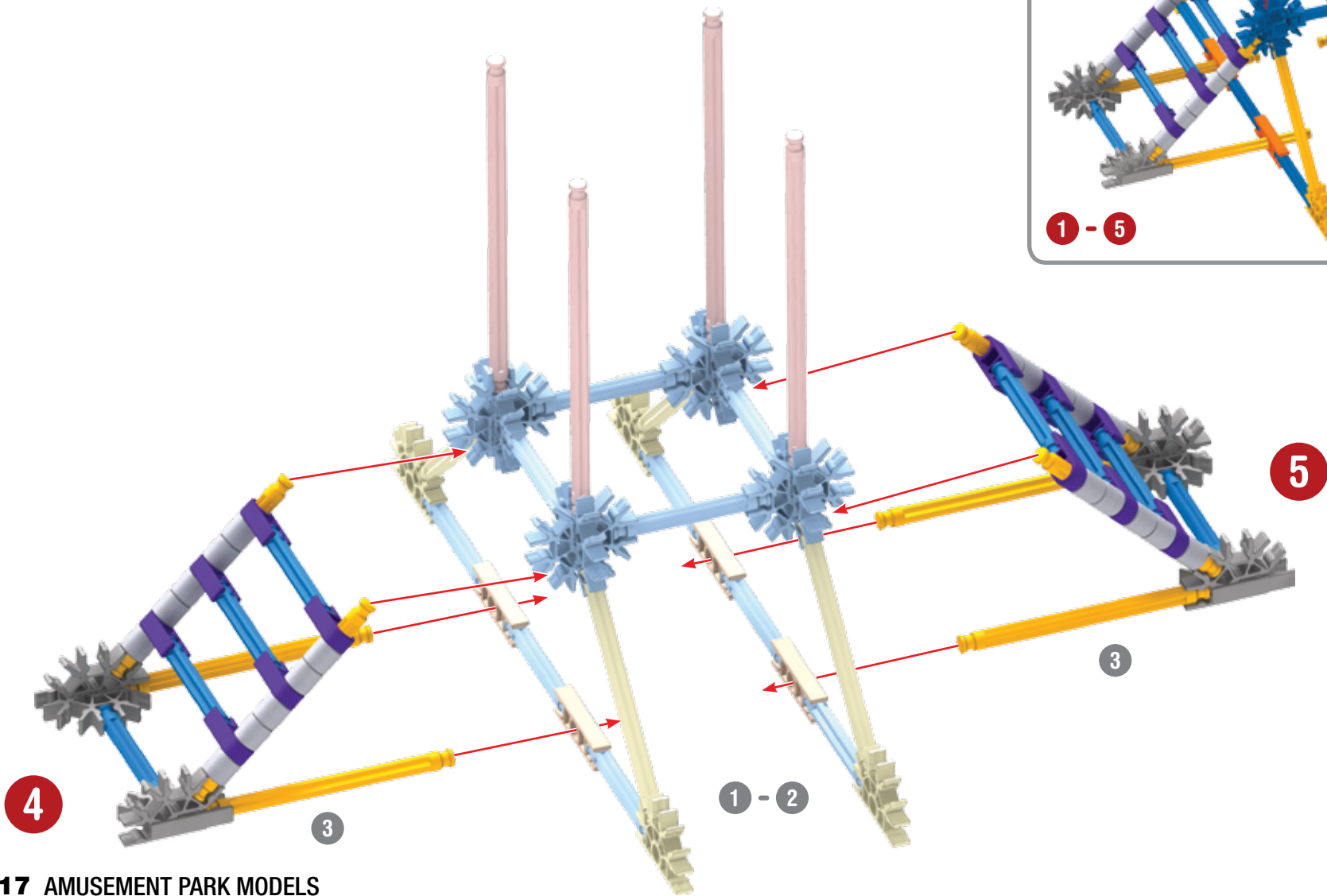

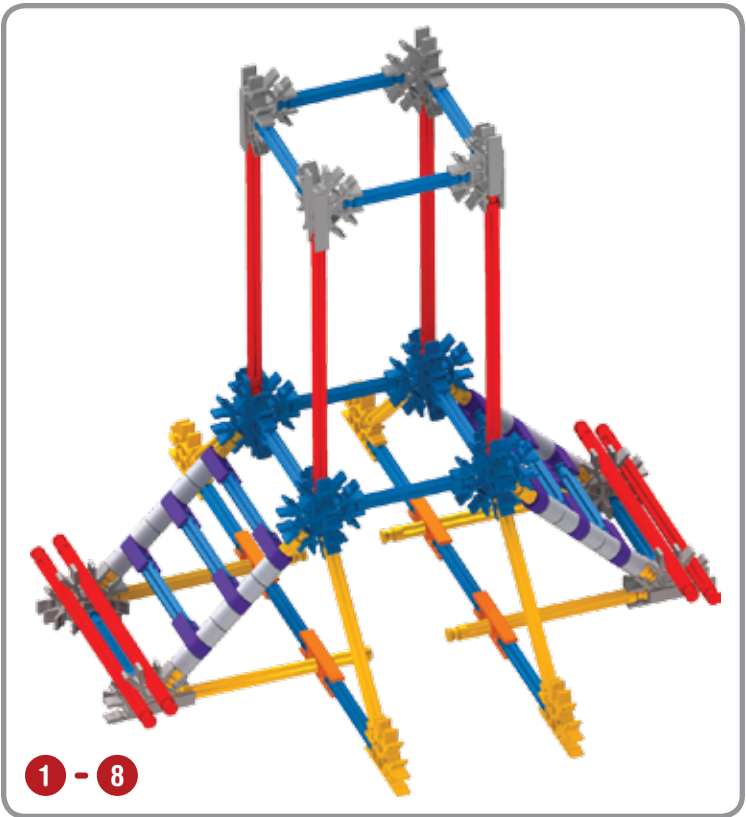
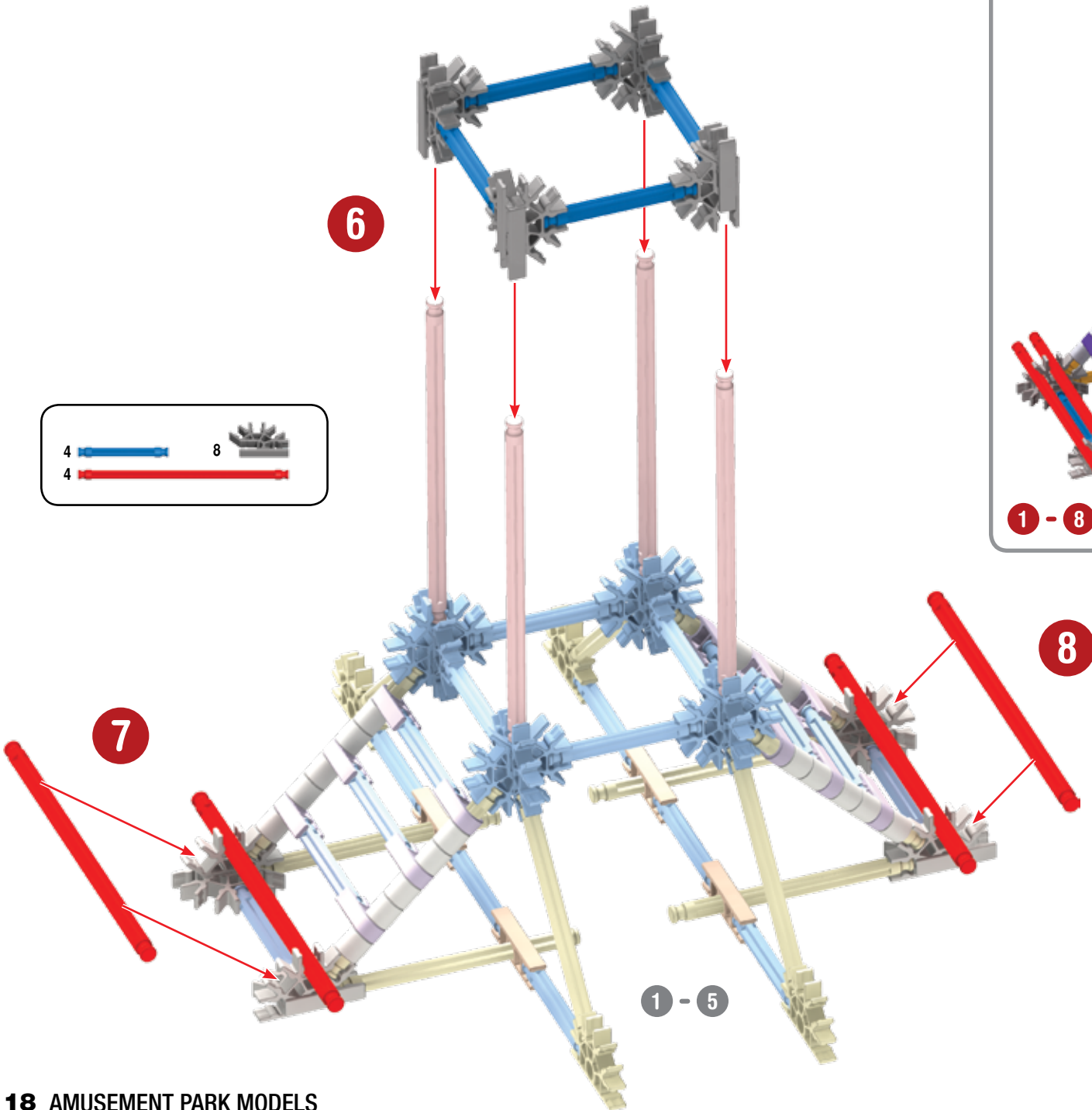

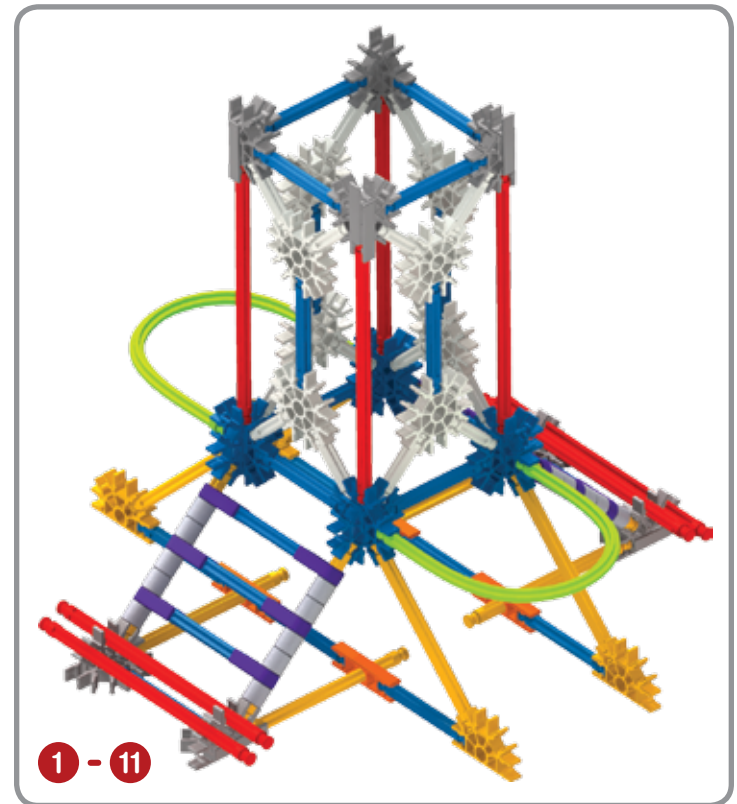
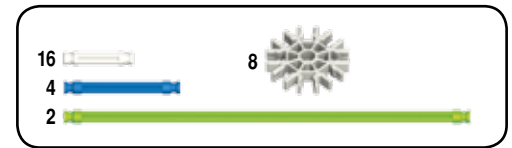
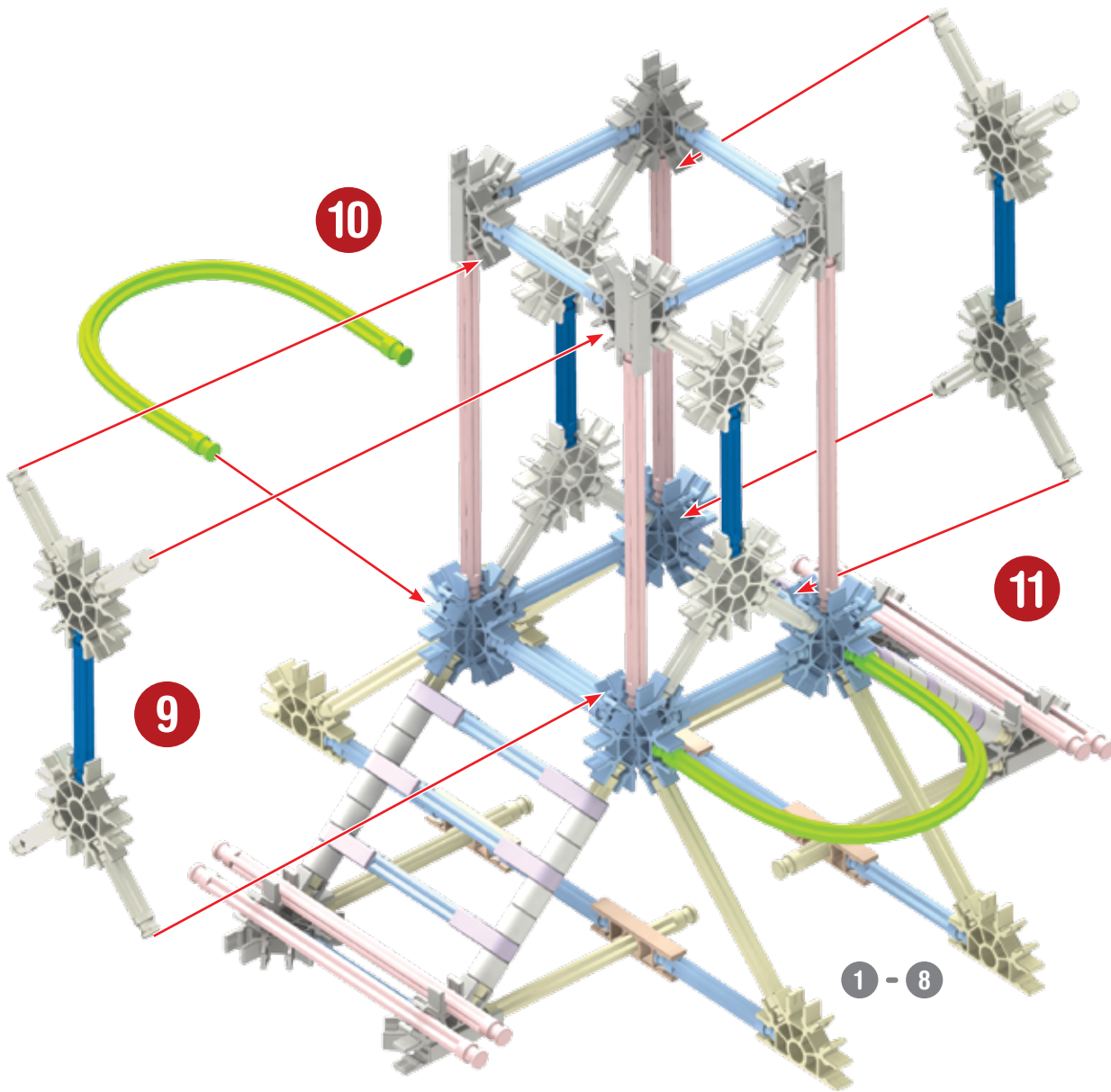

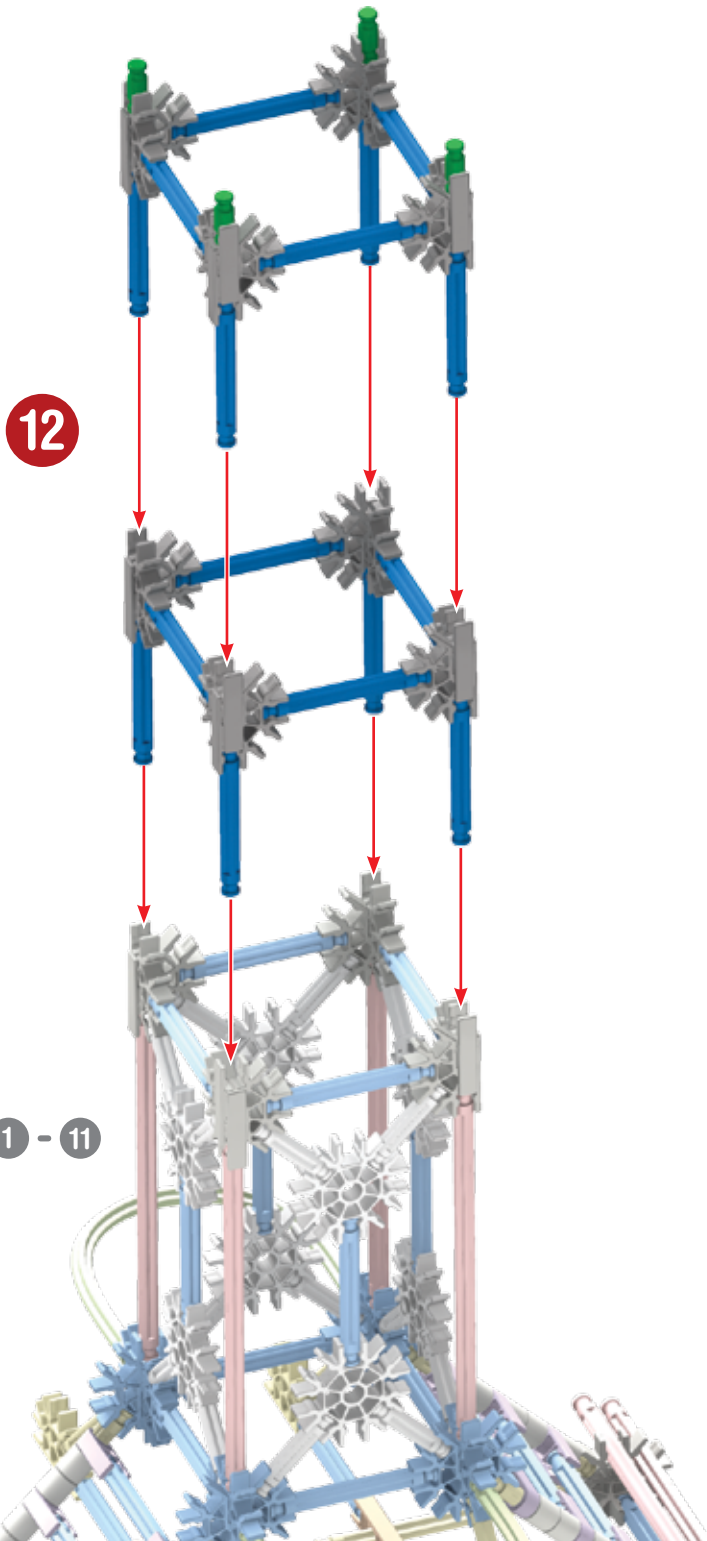

4		16	
16		16	

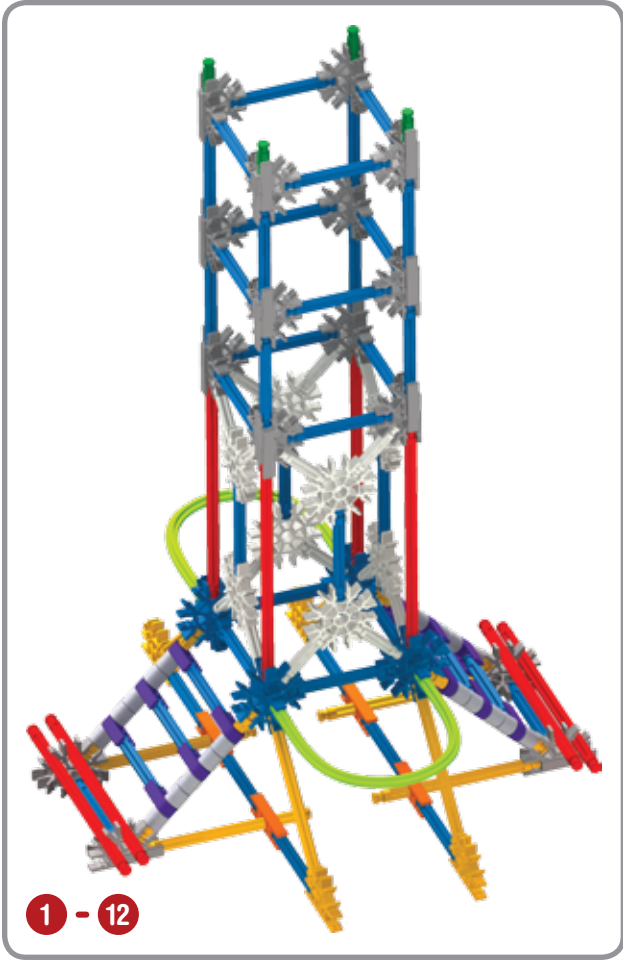

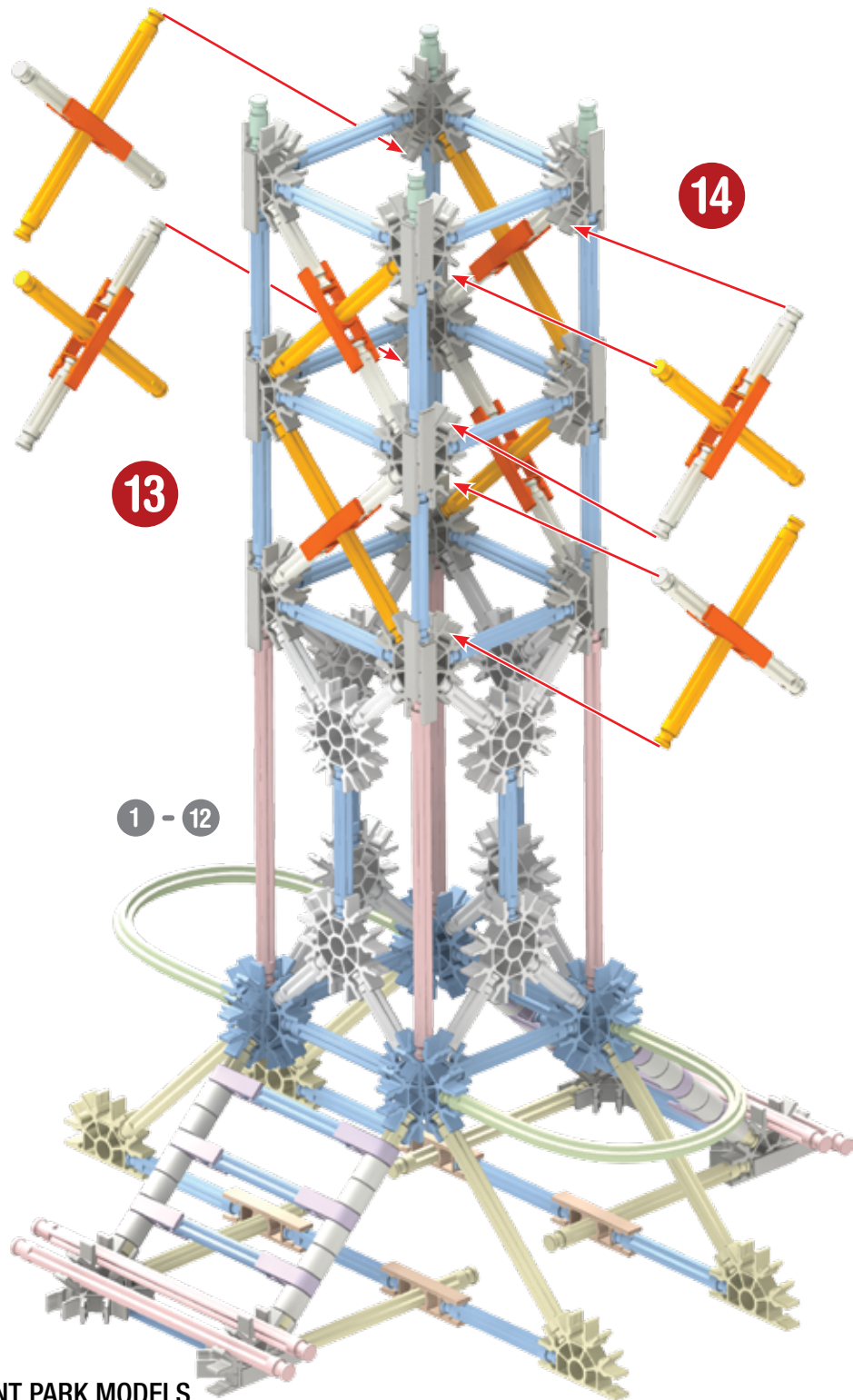

- 16
- 8
- 8

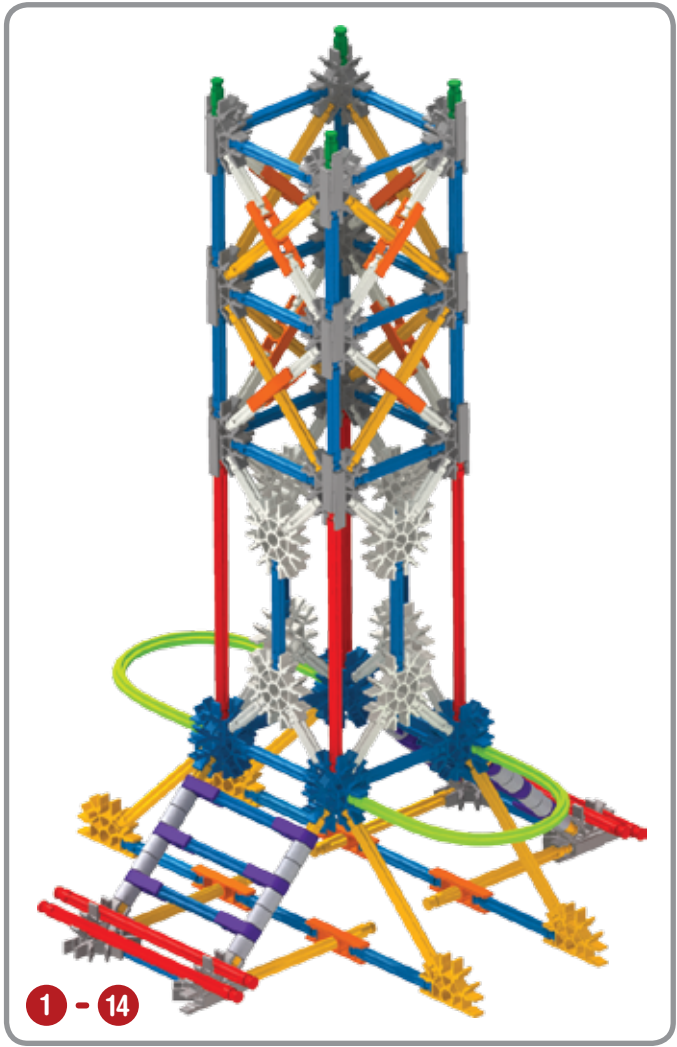

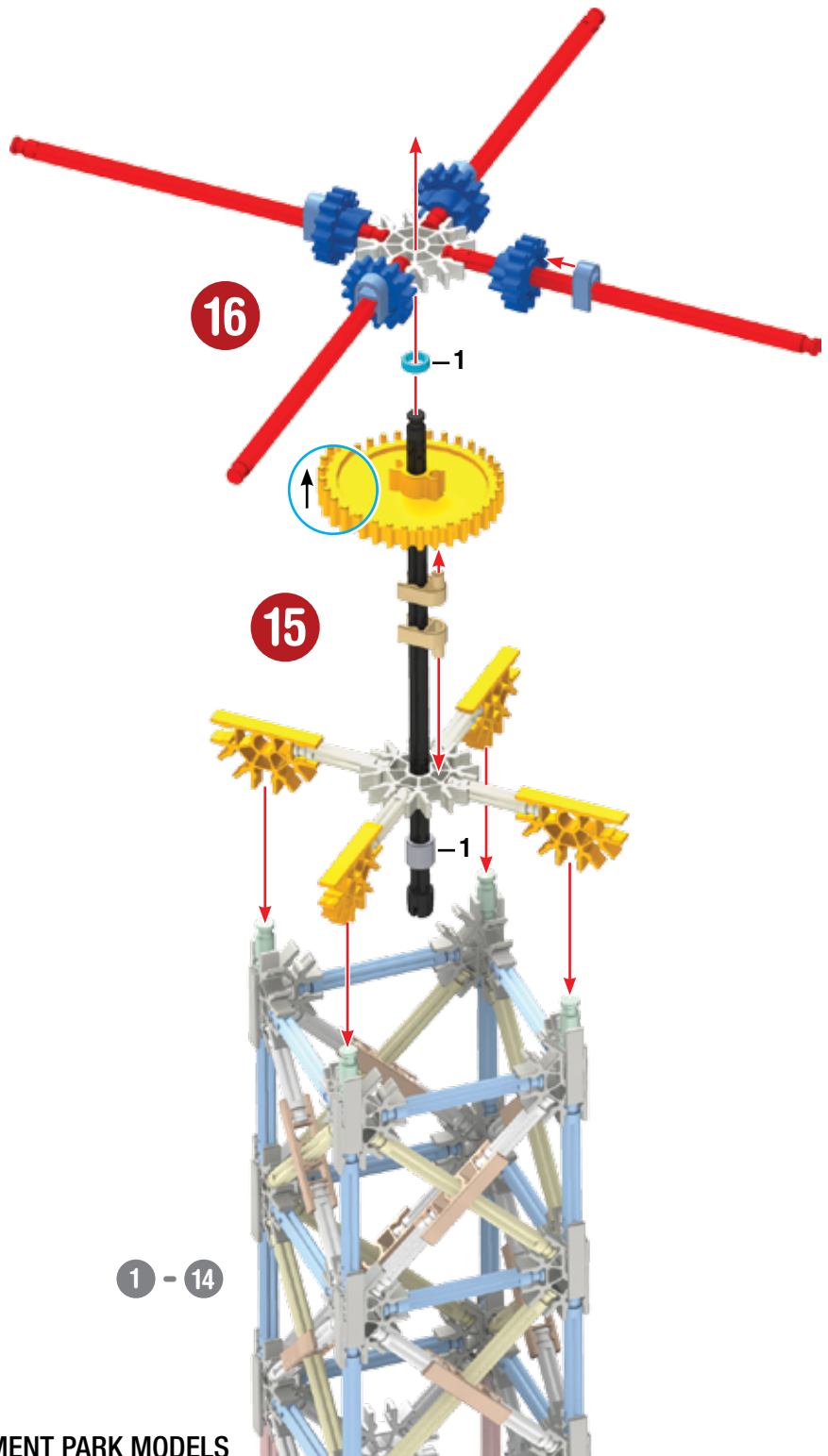

- | | | | | | | | | | | | |
|---|--|---|--|---|--|---|--|---|--|---|--|
| 4 | | 2 | | 4 | | 1 | | 1 | | 1 | |
| 4 | | | | | | | | | | | |
| 1 | | | | | | | | | | | |
| 4 | | 2 | | 4 | | 1 | | | | | |

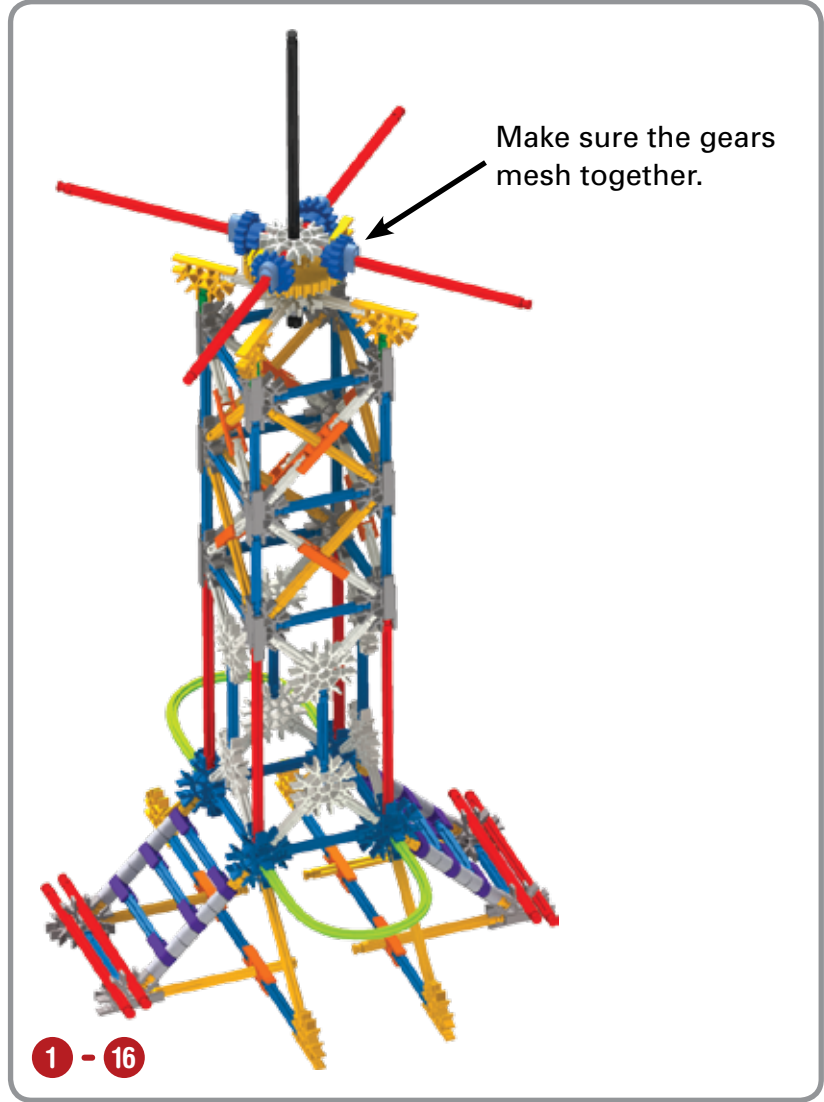

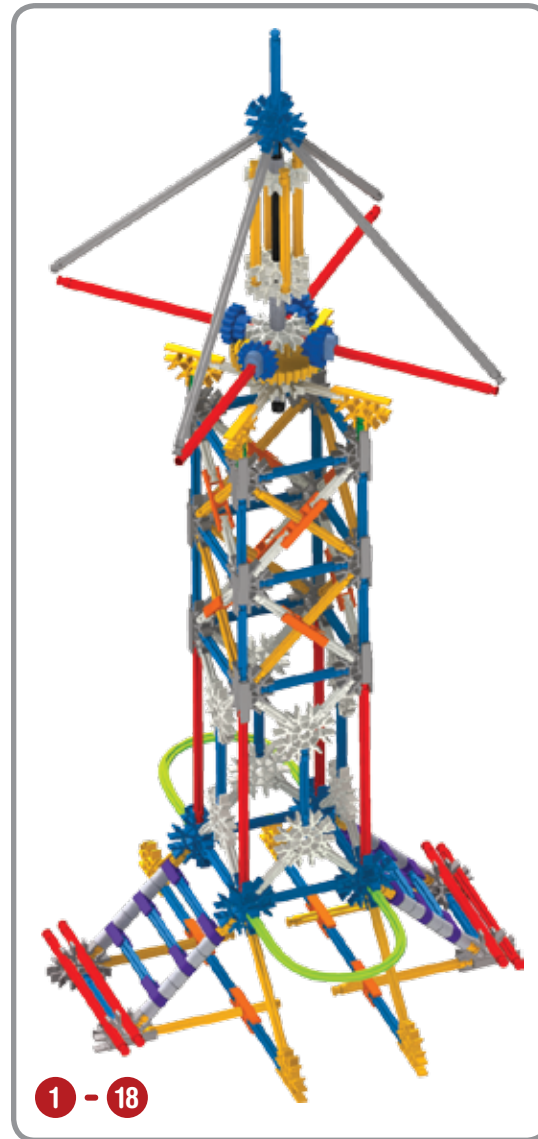
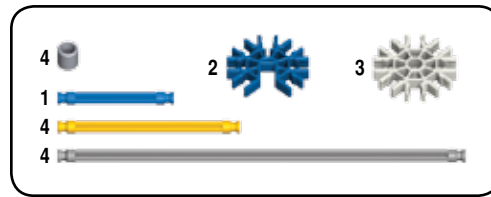
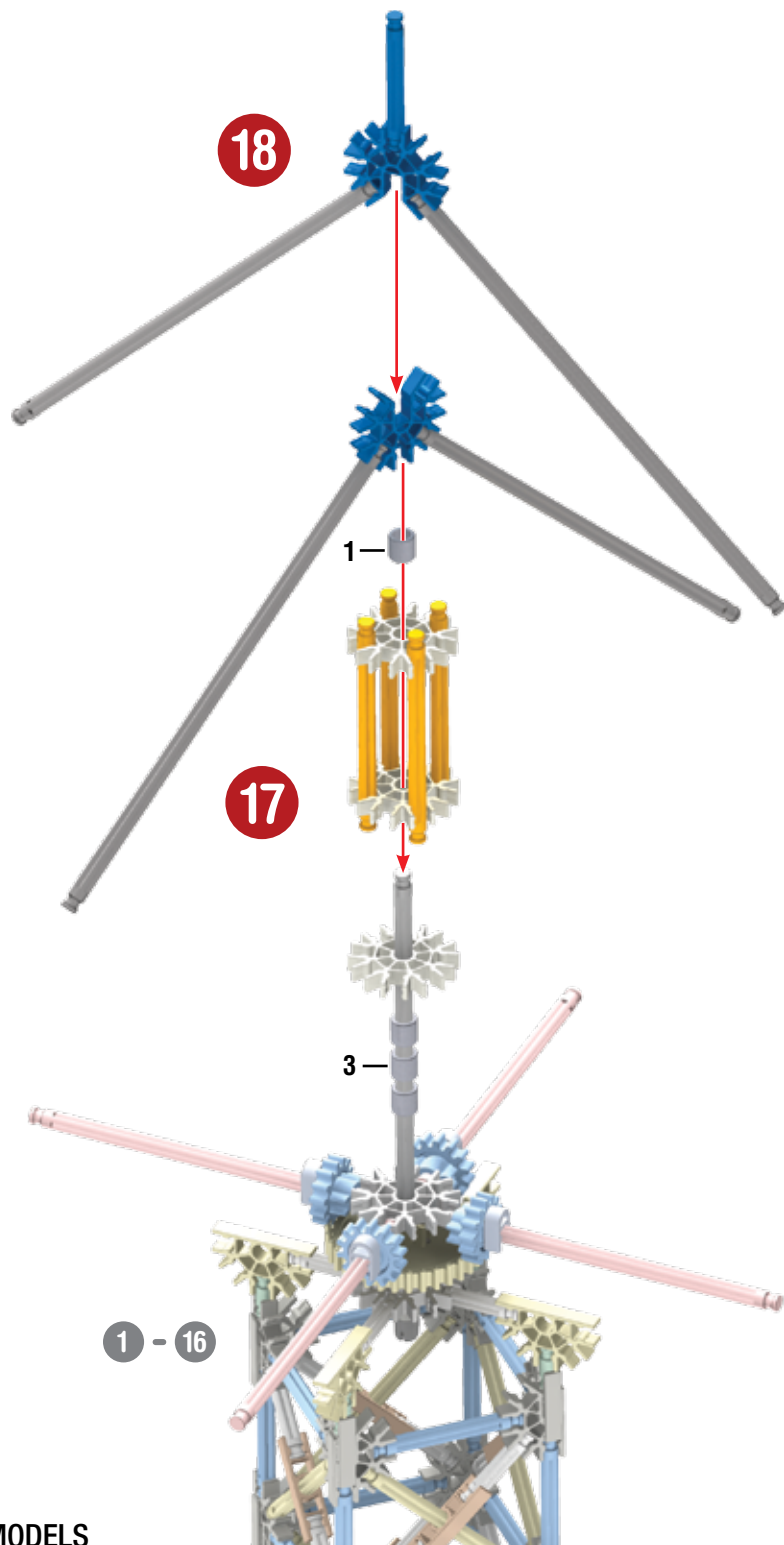

x4

19

20



20		16		8		8	
20							
12							
8							
4		4		28		8	

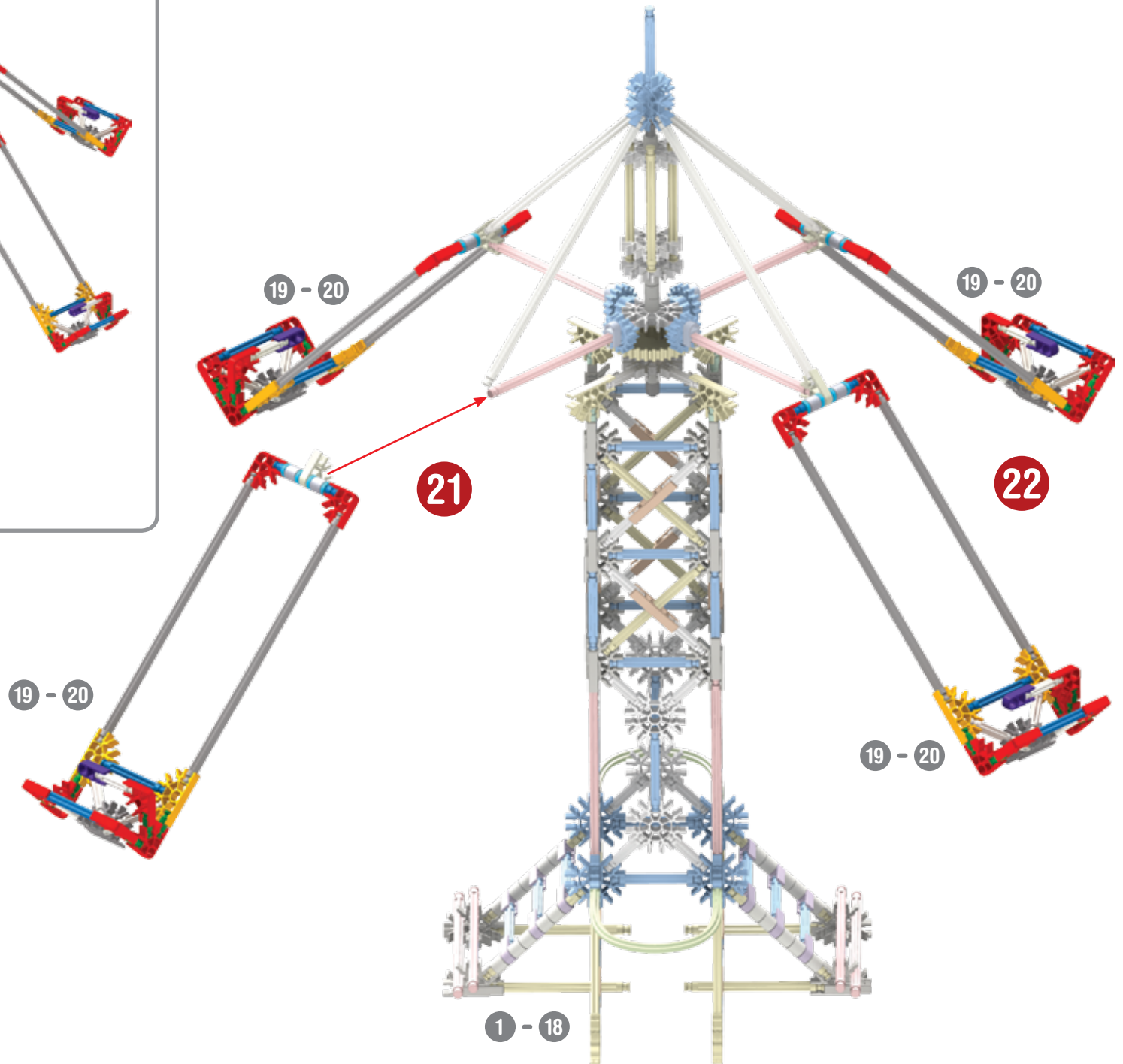
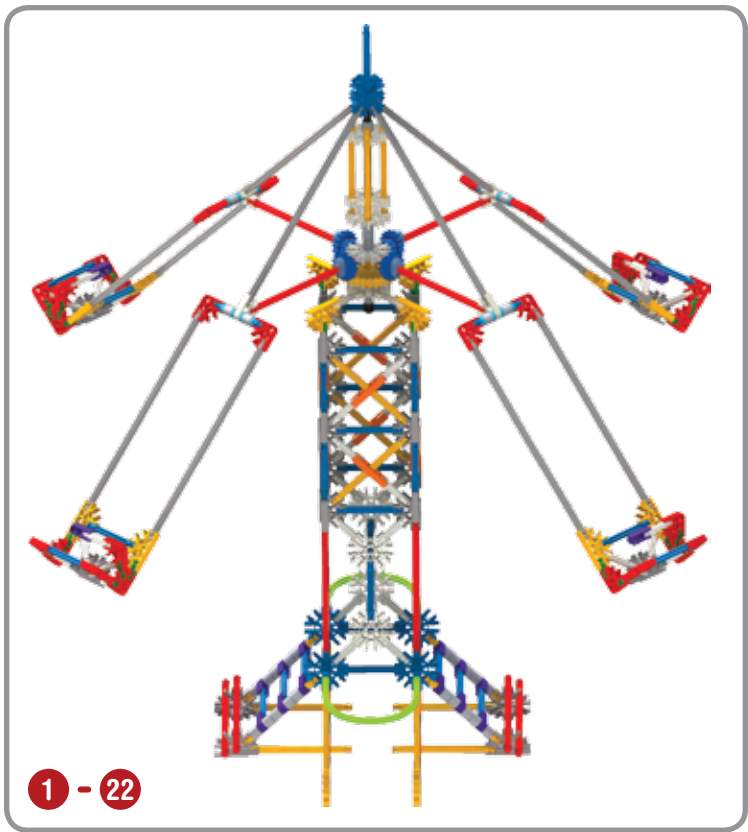

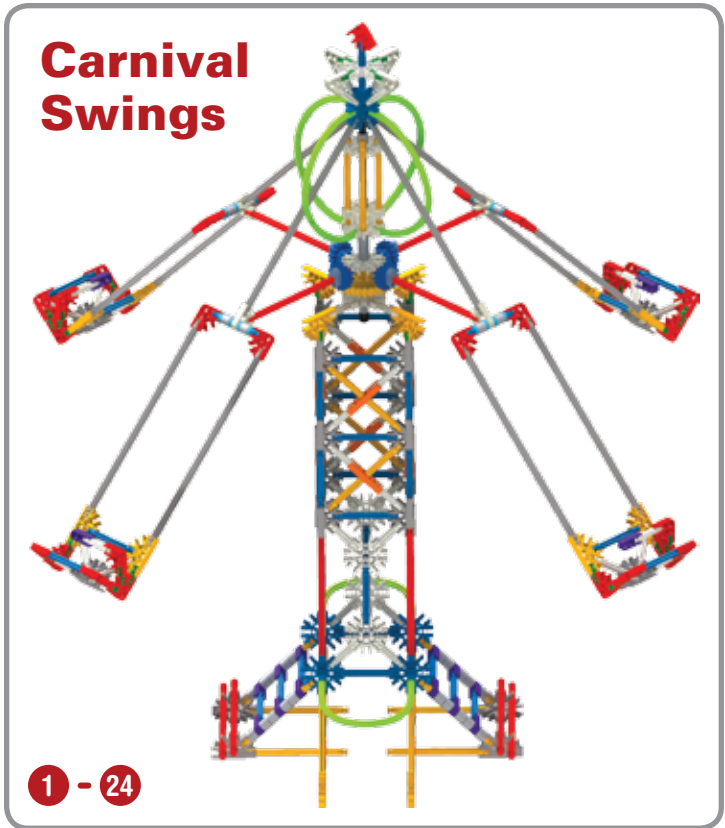
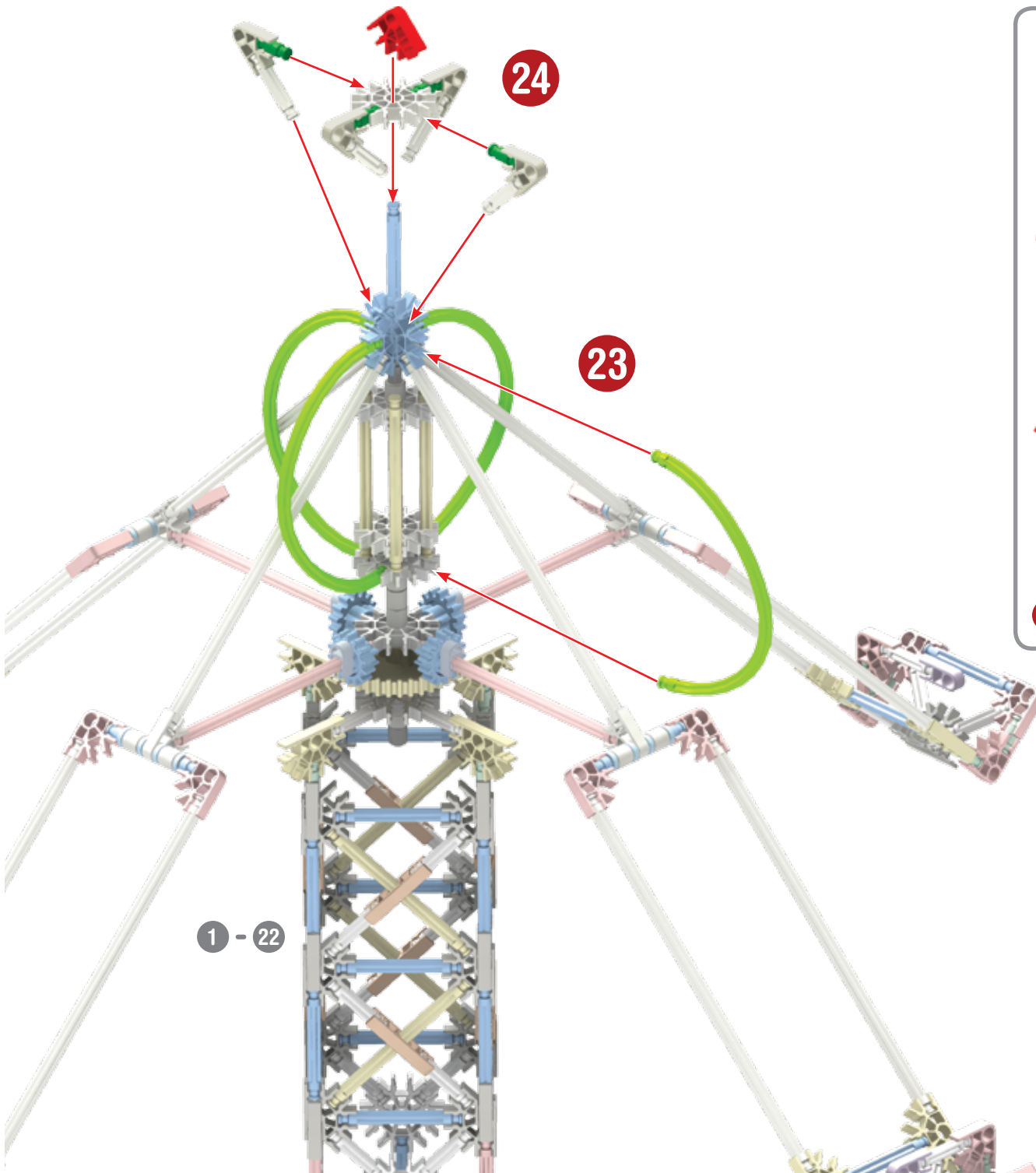

Carousel

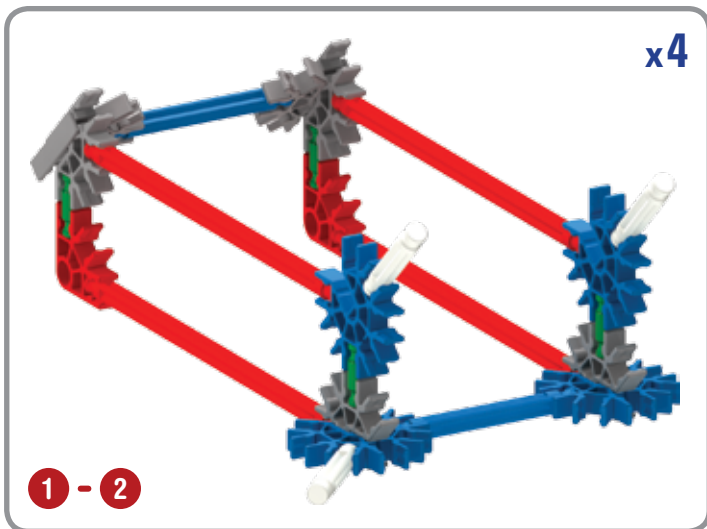
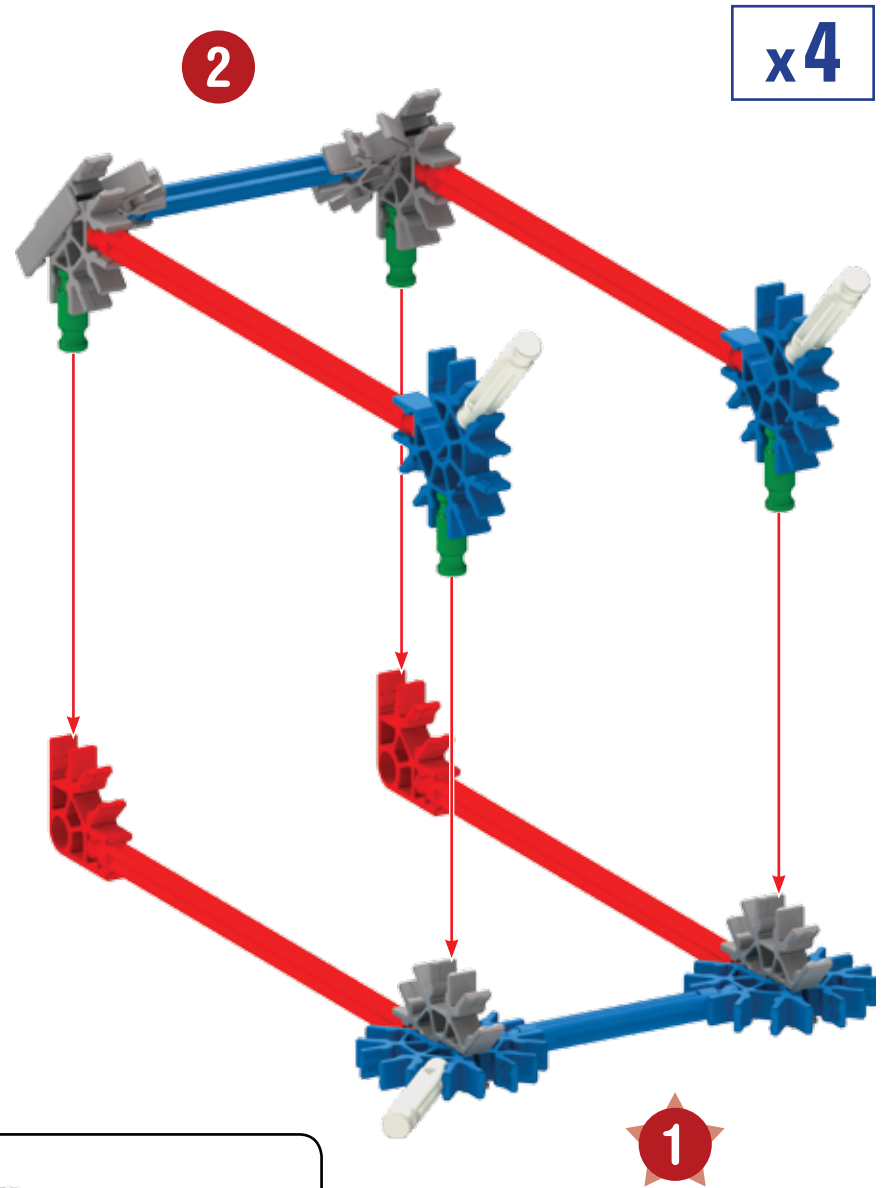
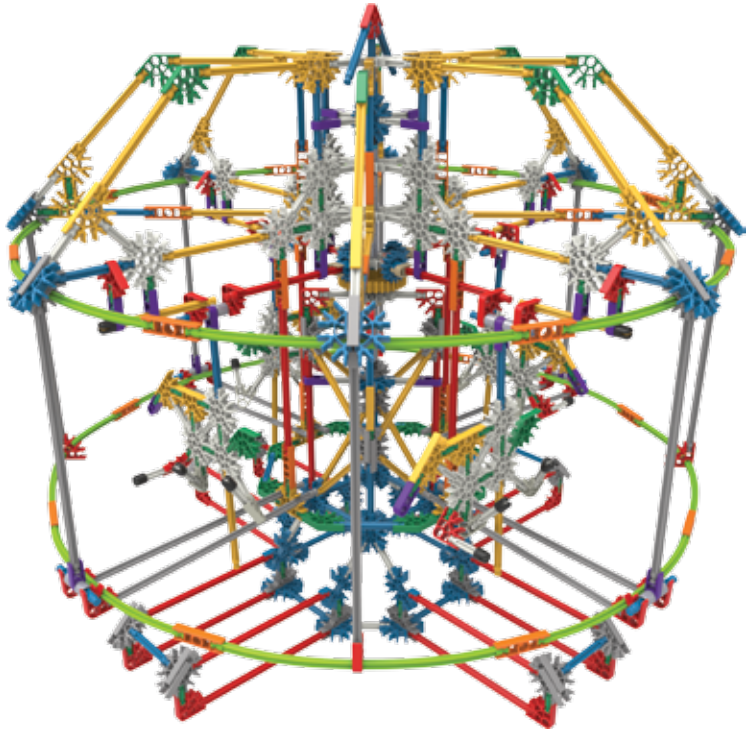

- 16
- 12
- 8
- 16
- 8
- 24
- 16

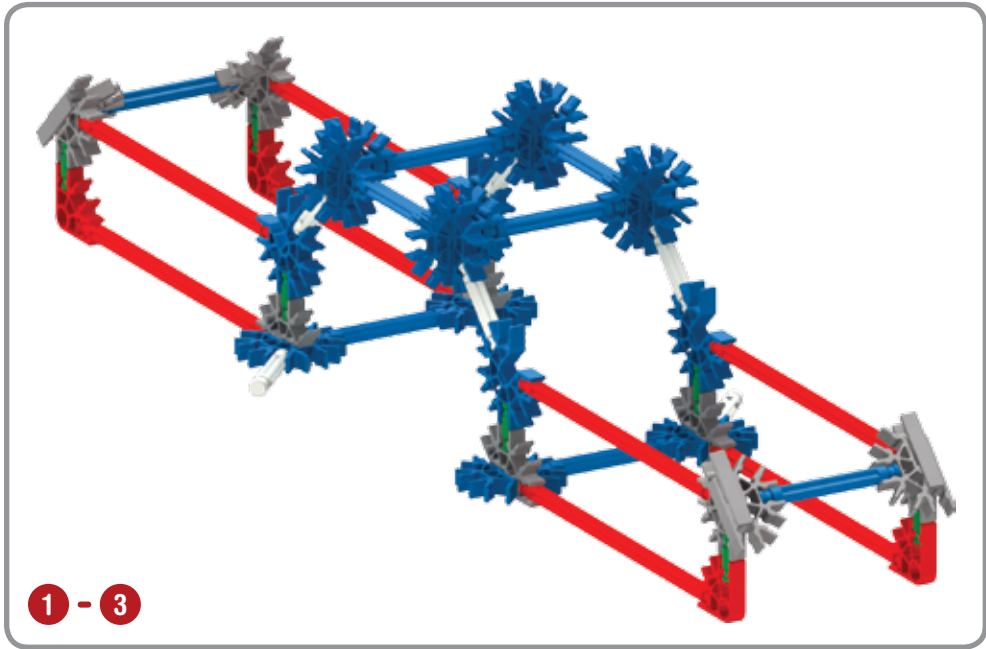
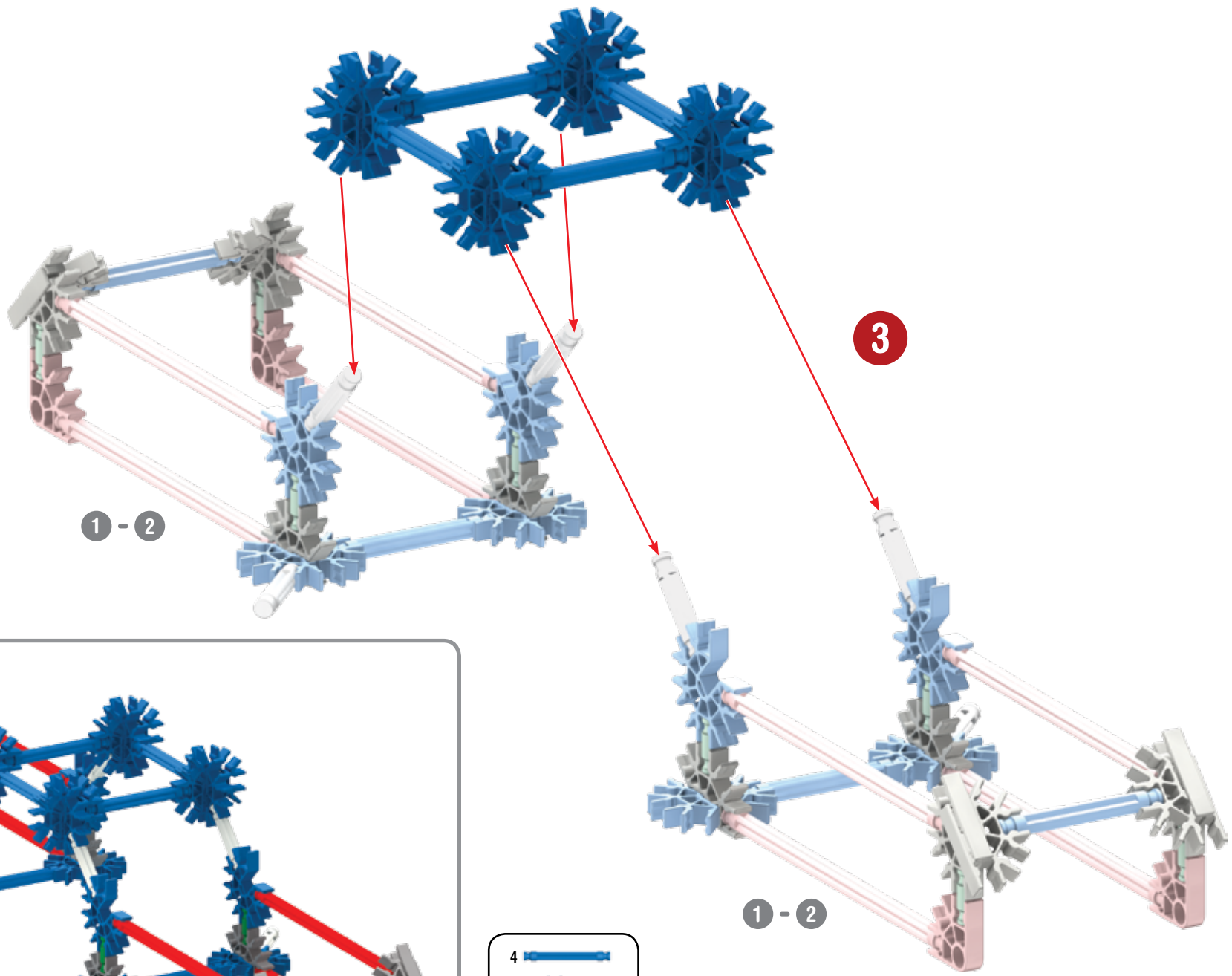

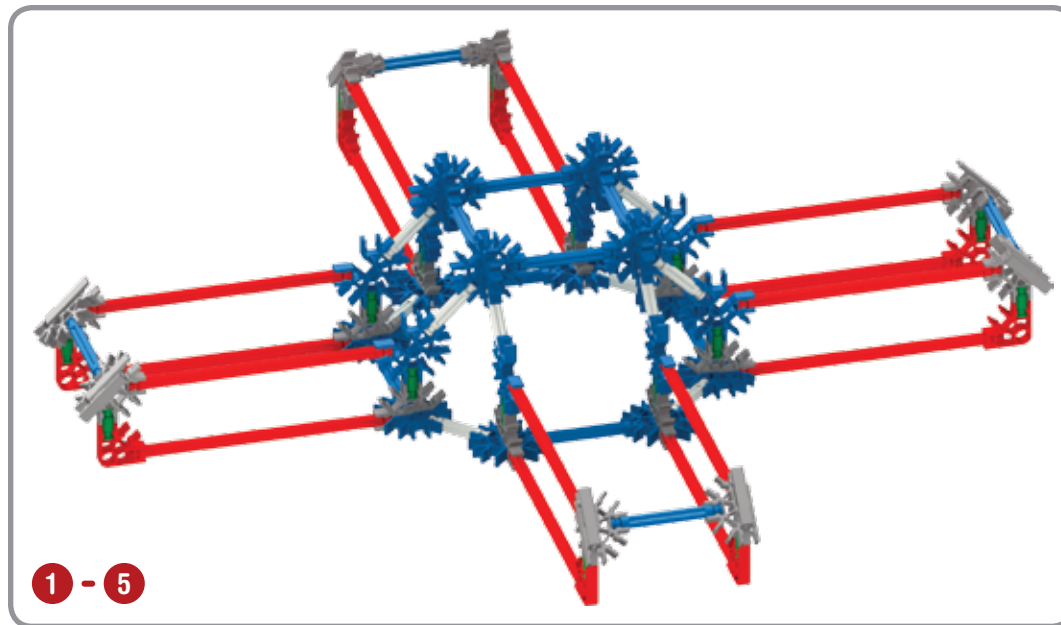
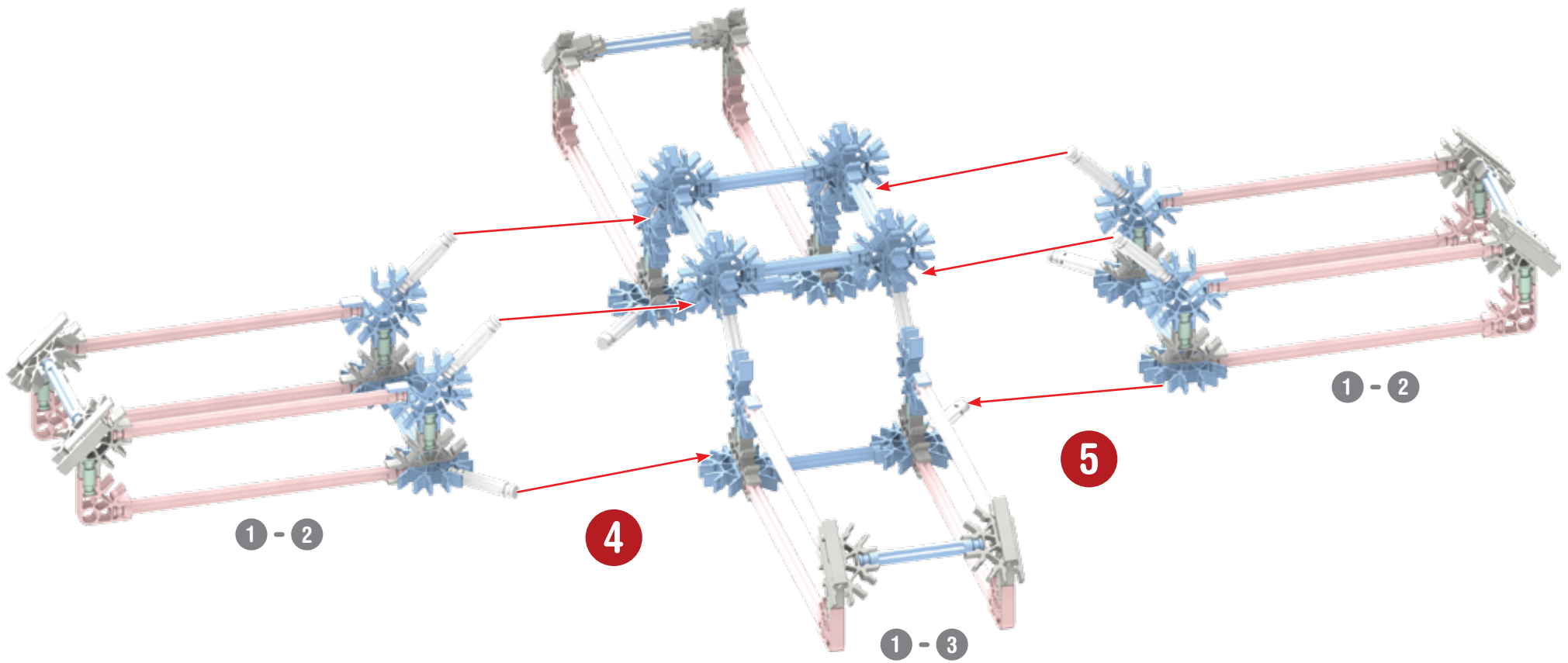

6

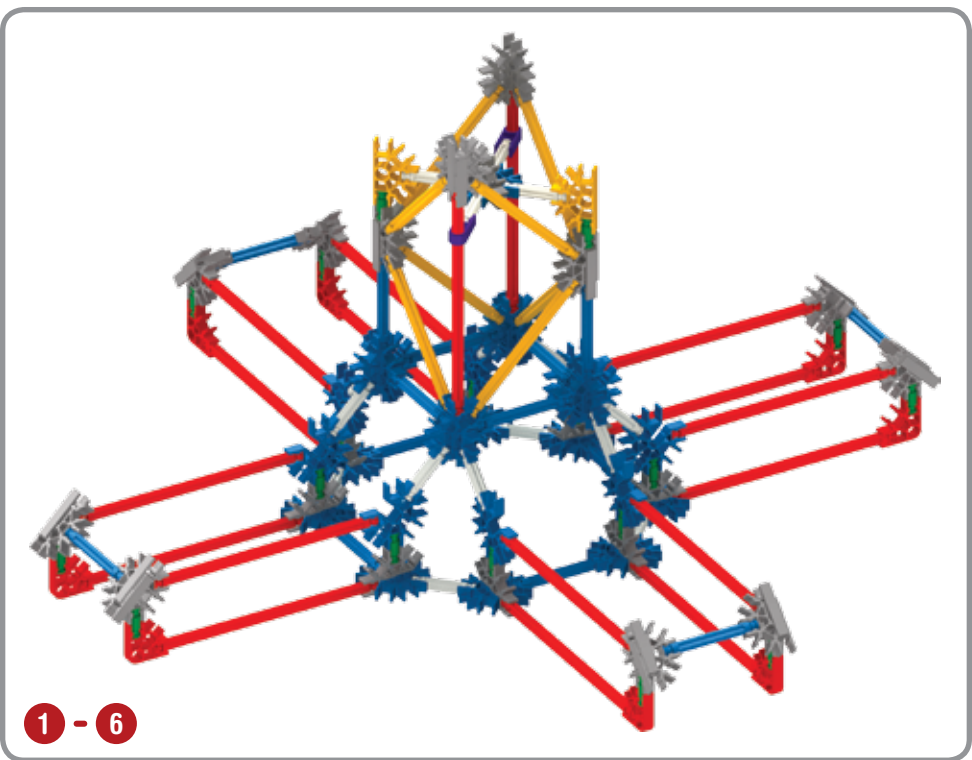
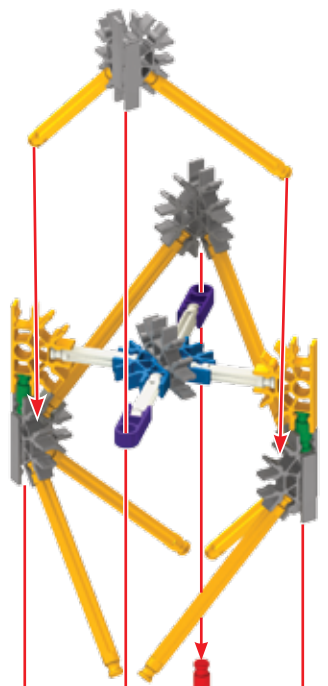

1 - 6

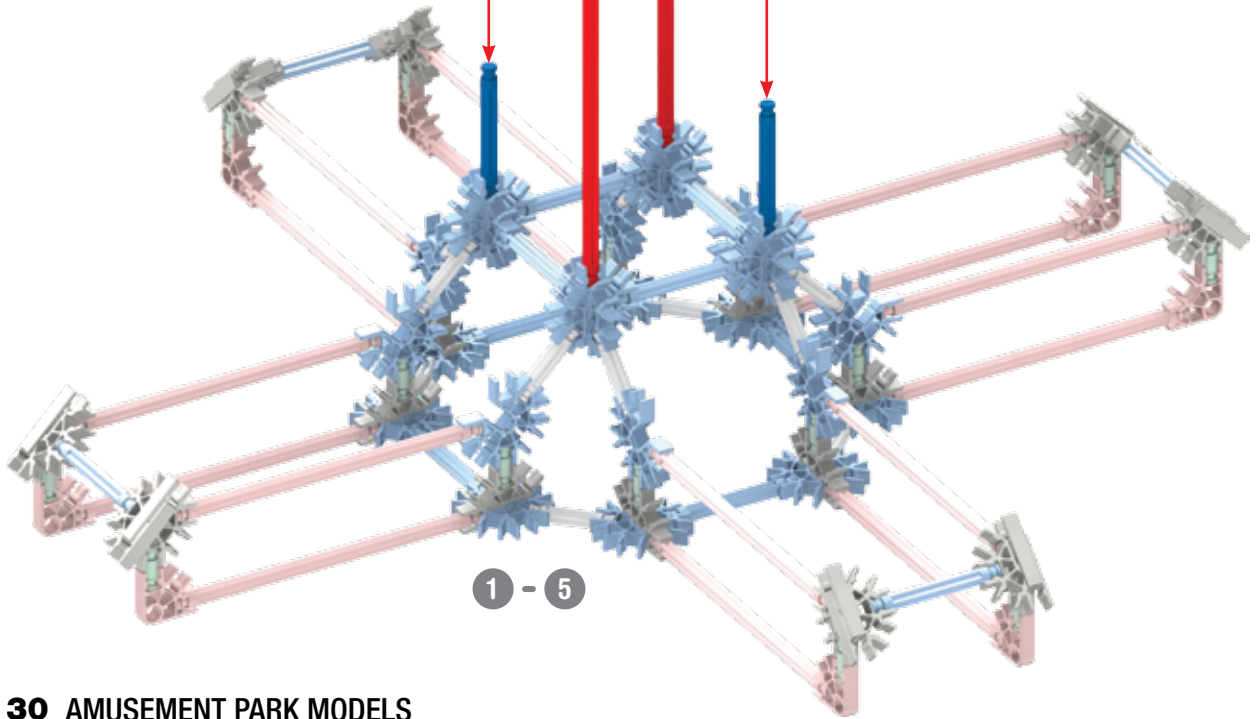

1 - 5

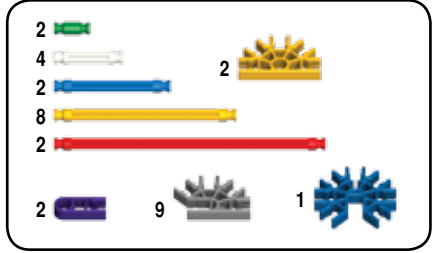

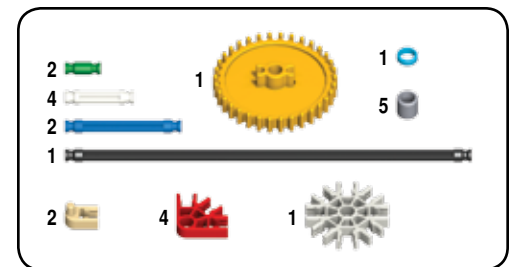
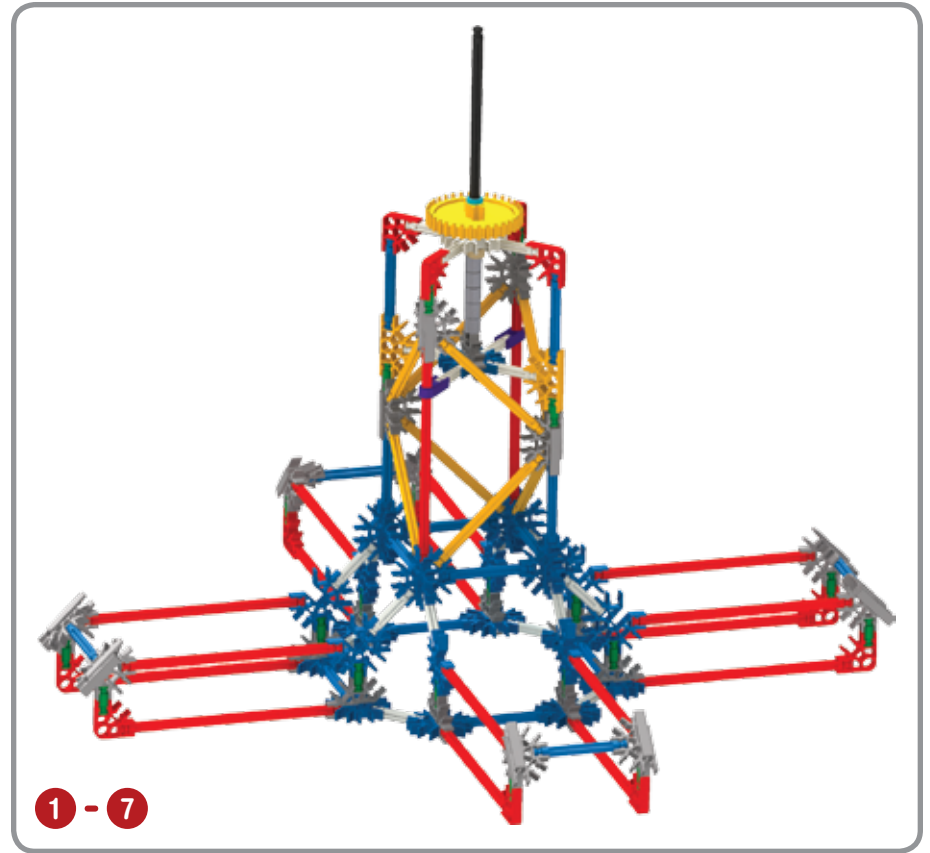
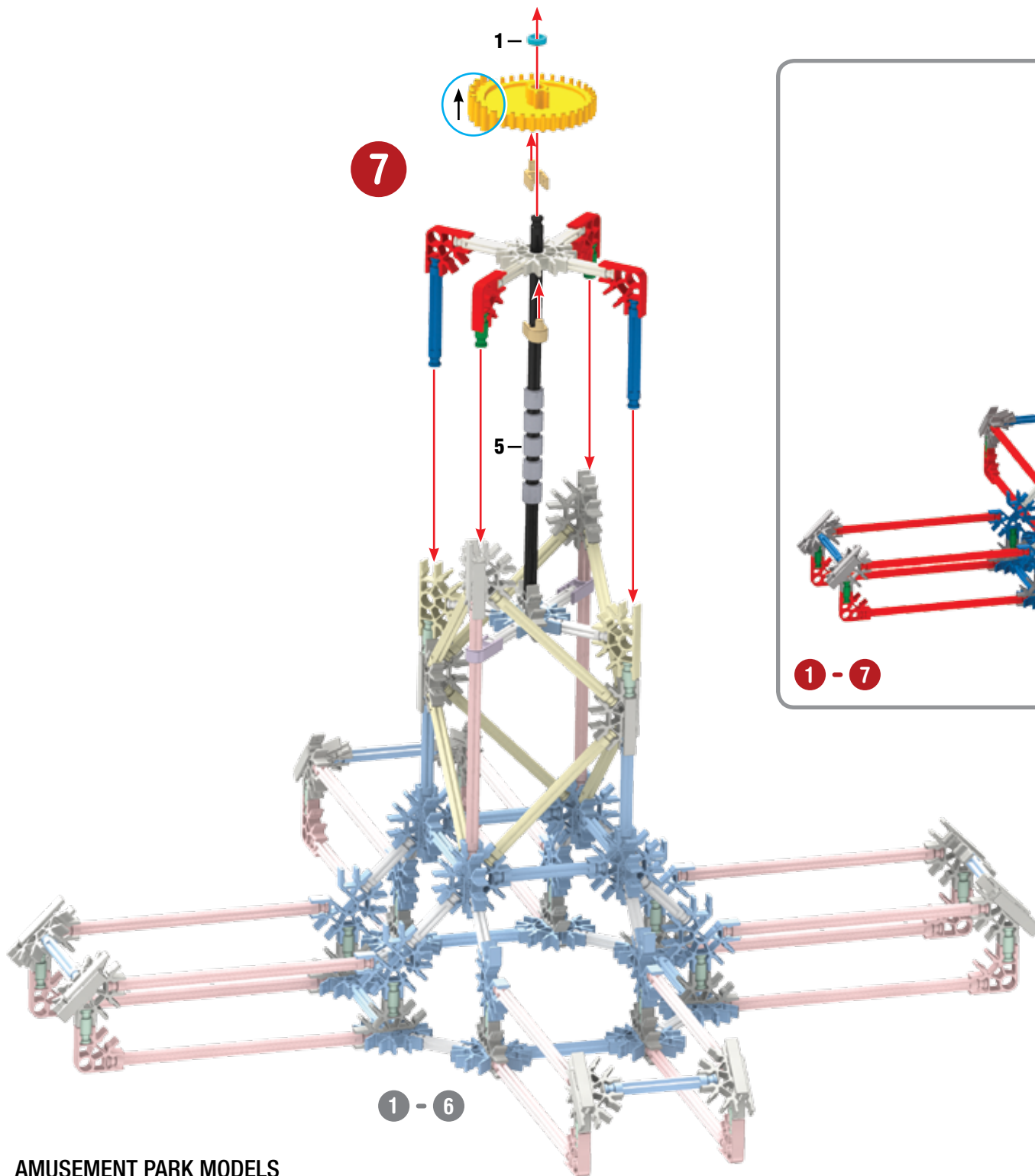

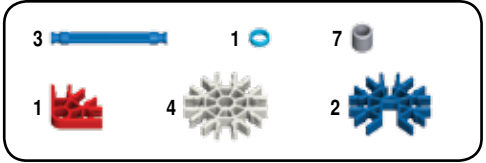
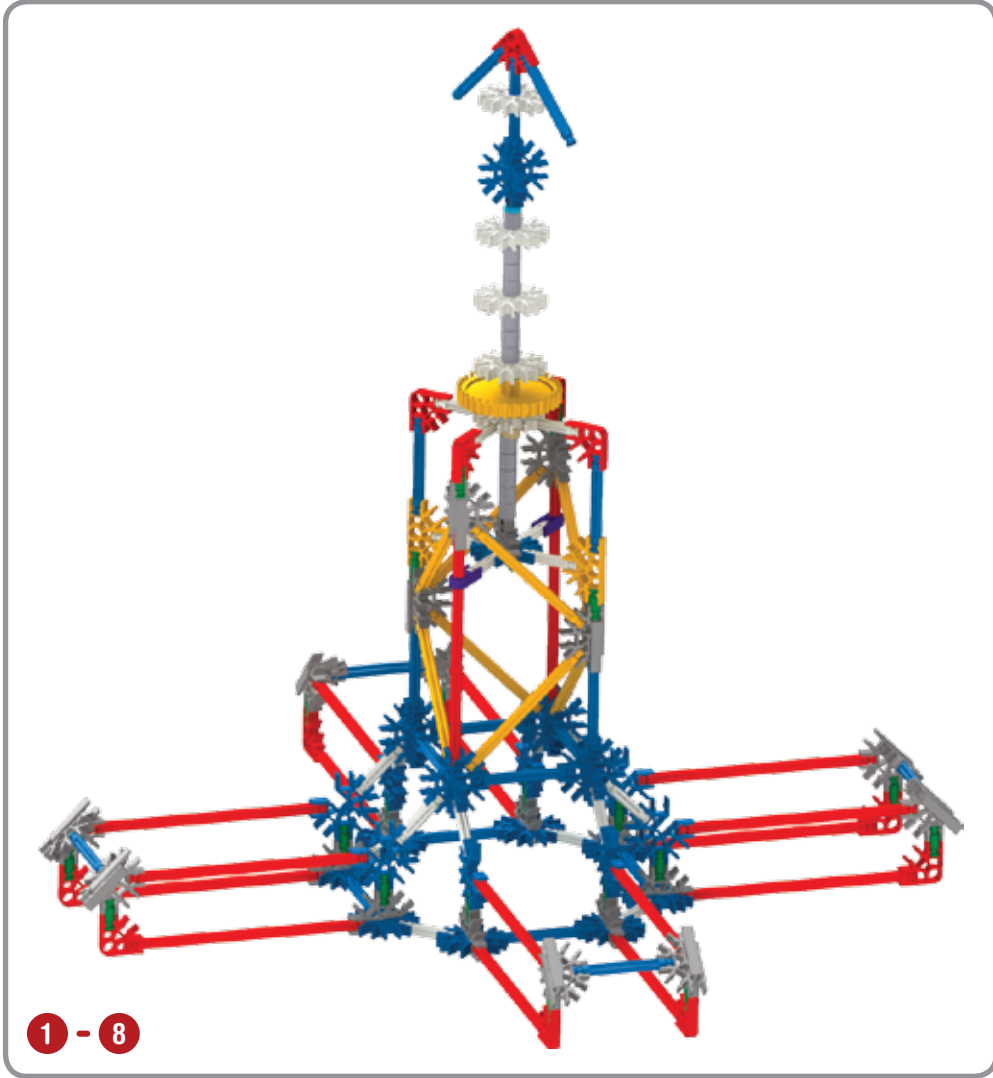
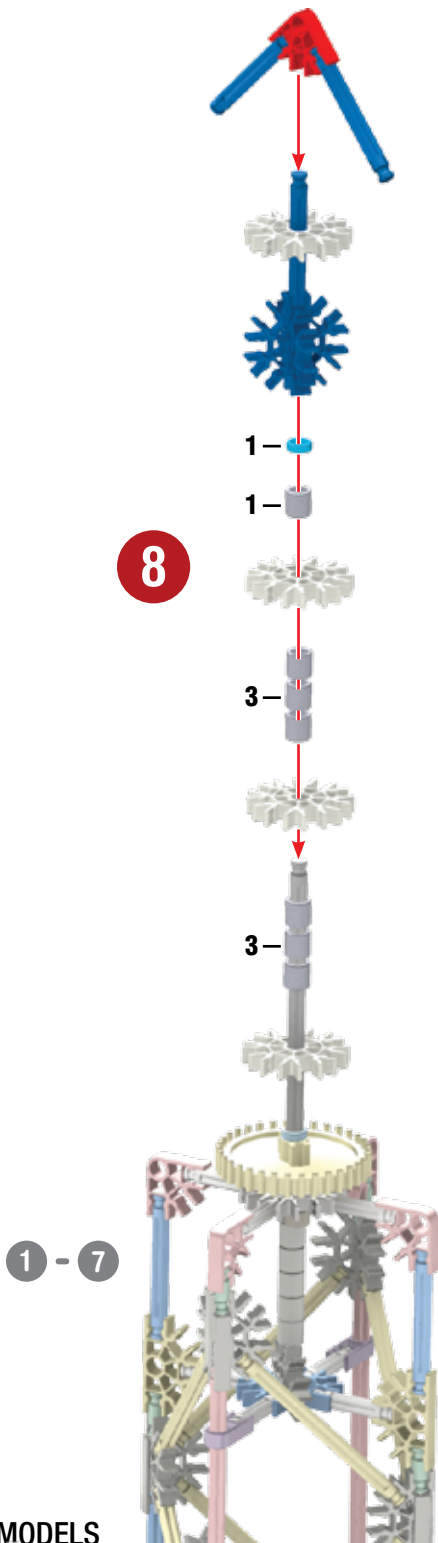

x4

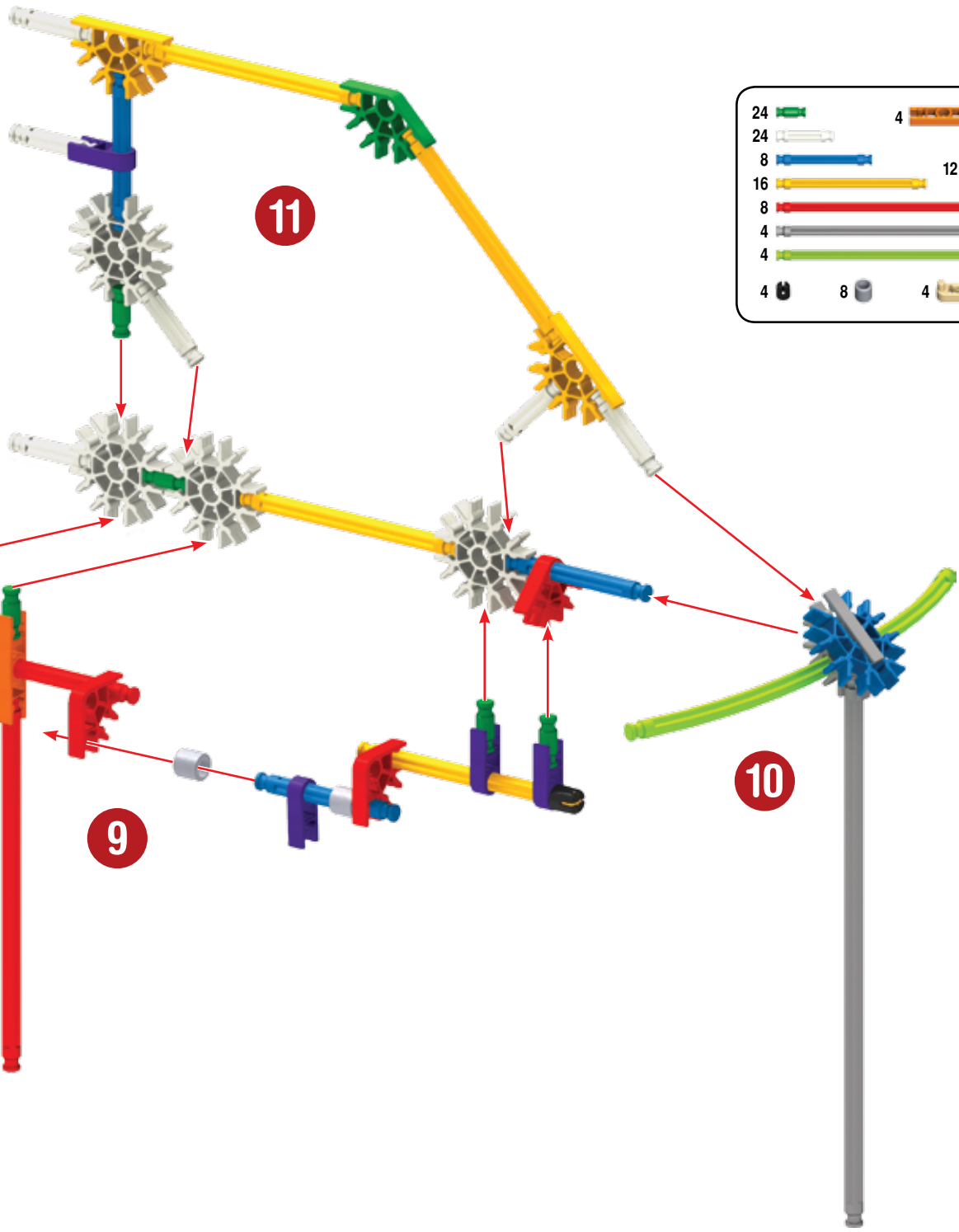

- | | | | | | | | |
|----|--|----|--|----|--|----|--|
| 24 | | 4 | | 4 | | 4 | |
| 24 | | 12 | | 4 | | 16 | |
| 8 | | 8 | | 4 | | 8 | |
| 16 | | 4 | | 20 | | | |
| 8 | | | | | | | |
| 4 | | | | | | | |
| 4 | | | | | | | |
| 4 | | 8 | | 4 | | | |

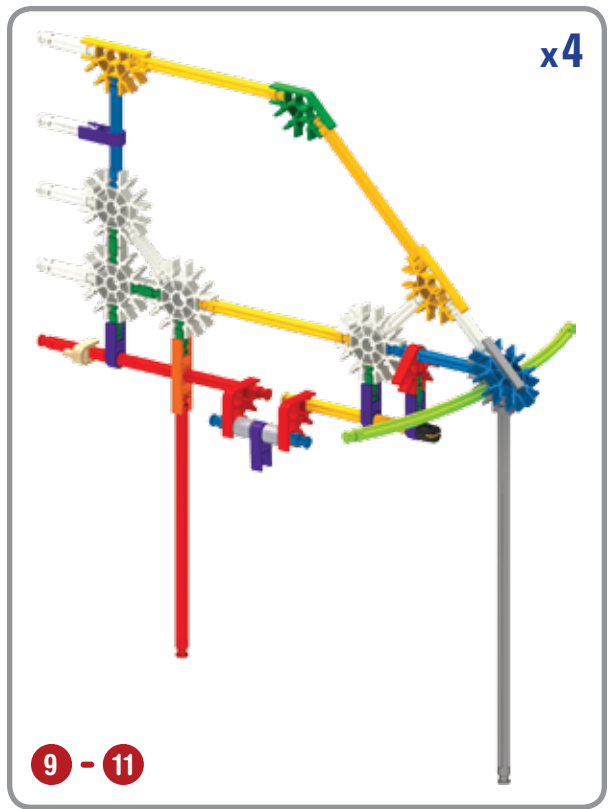

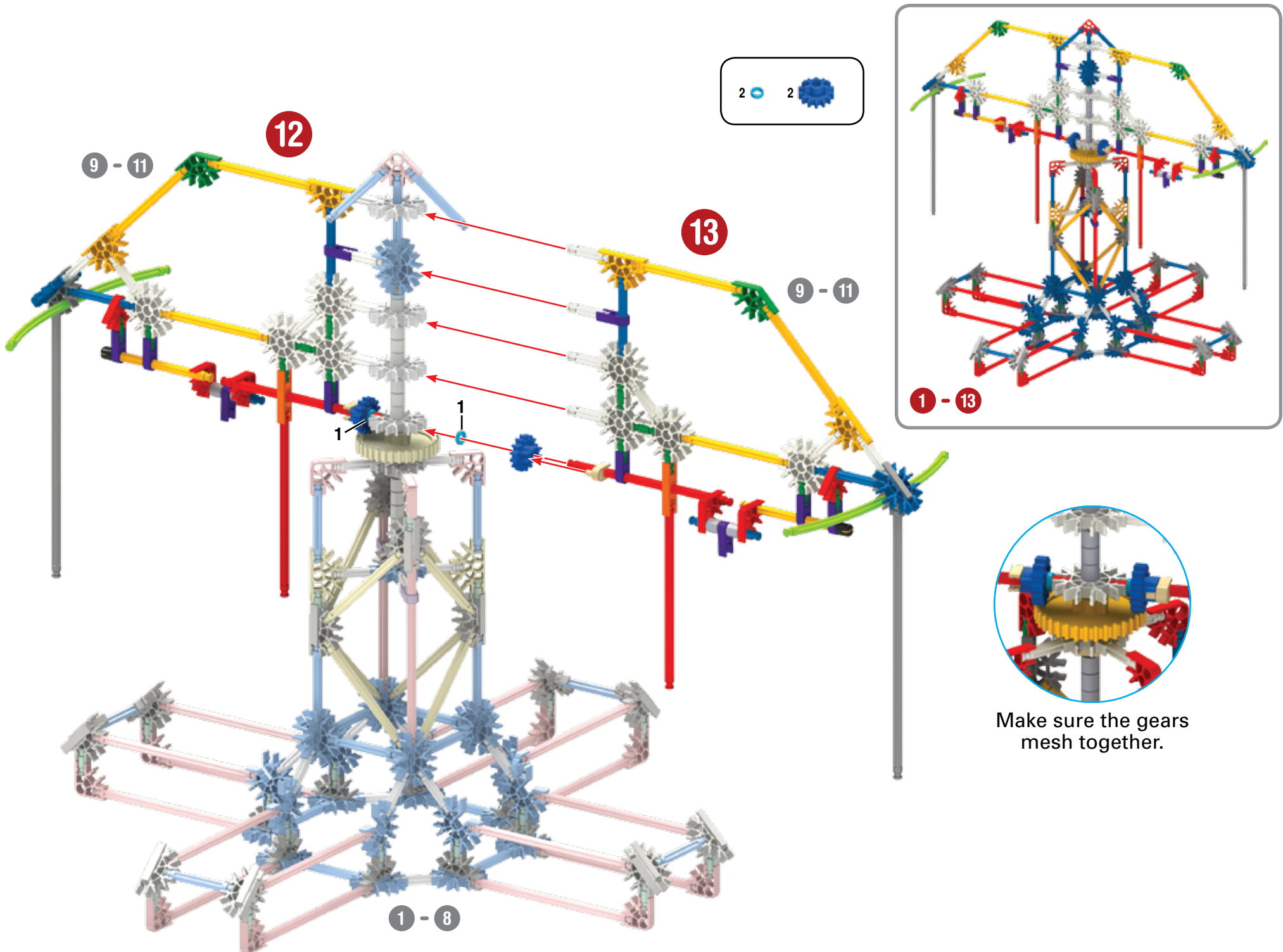

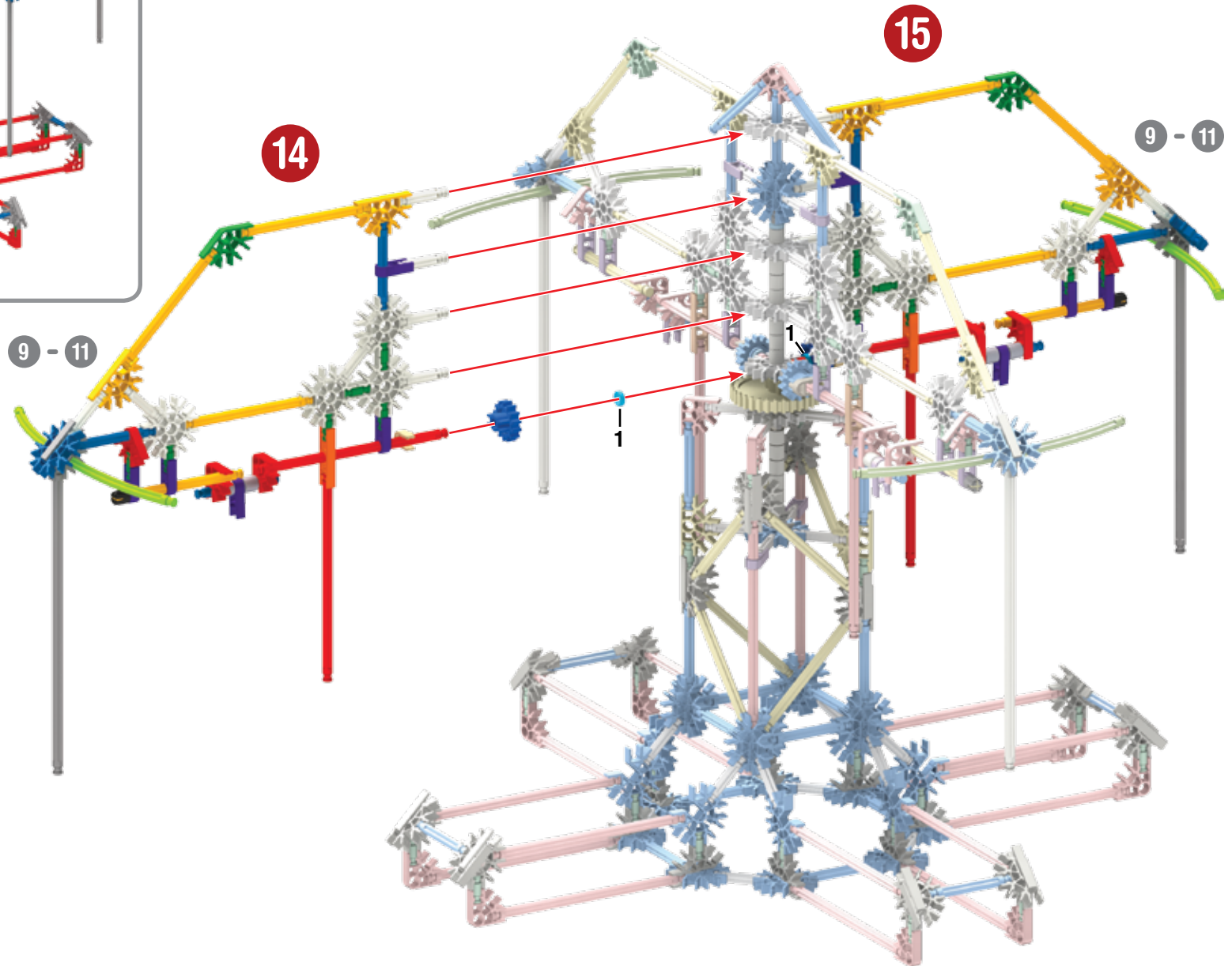
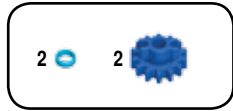
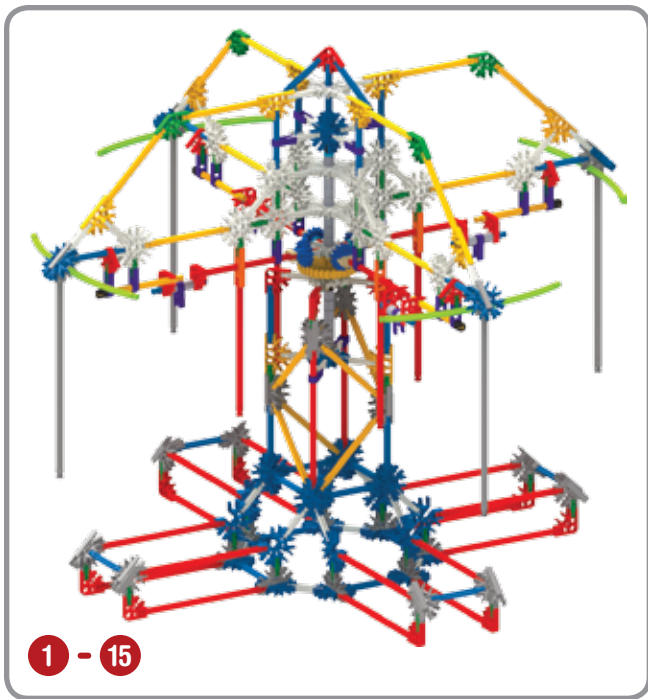

x4

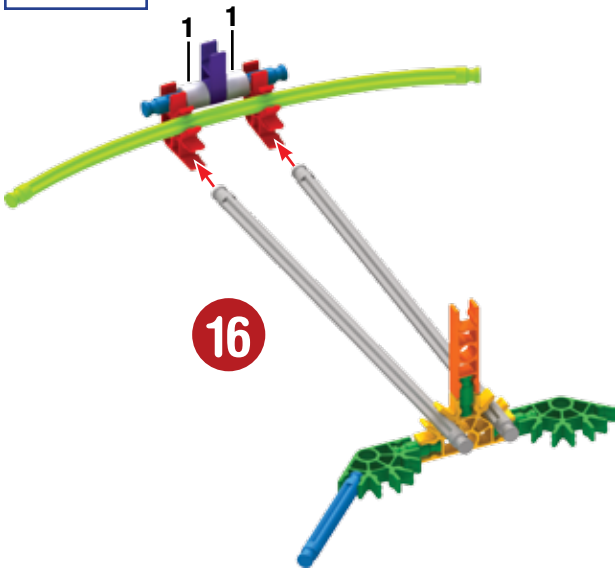

16

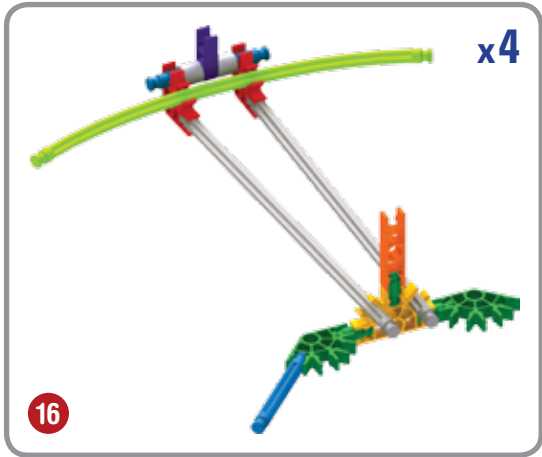

16

12		8		8	
8		8		8	
8		8		8	
4		8		8	
8		4		4	
8		4		4	
8		4		4	
8		4		4	



1 - 18

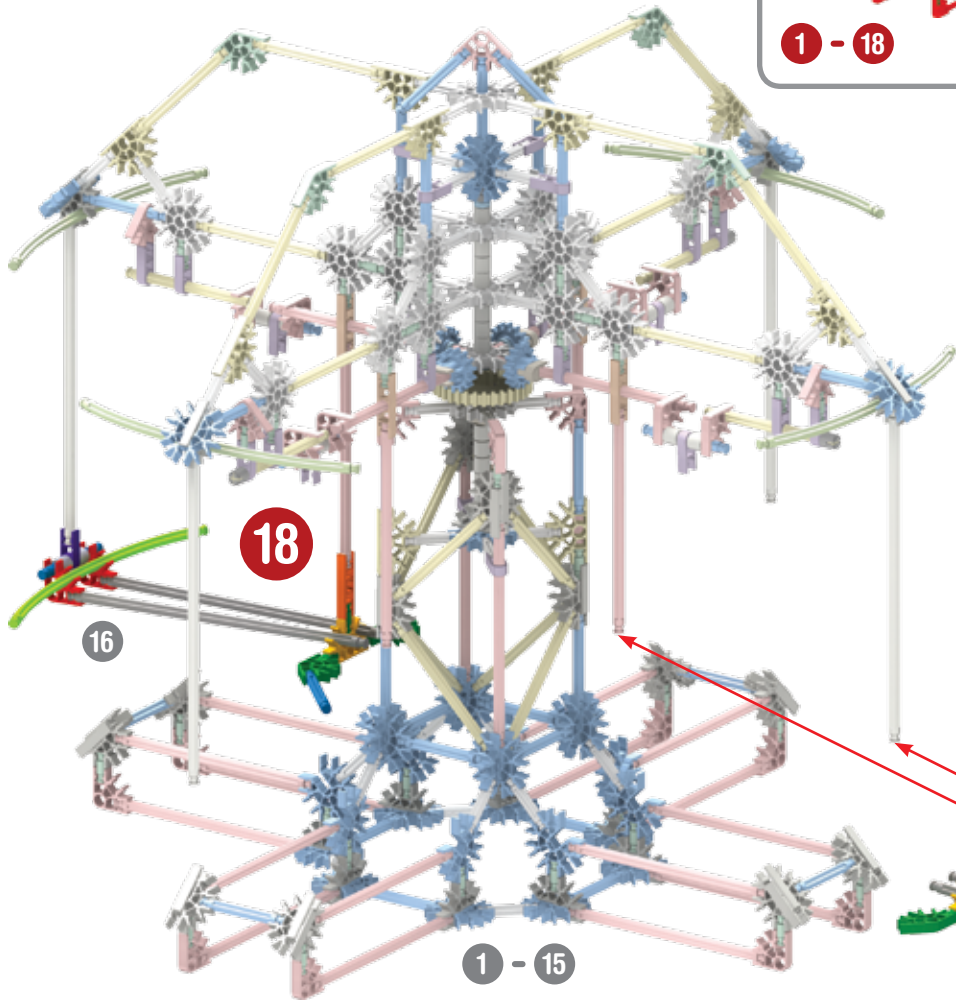

18

16

17

1 - 15

16

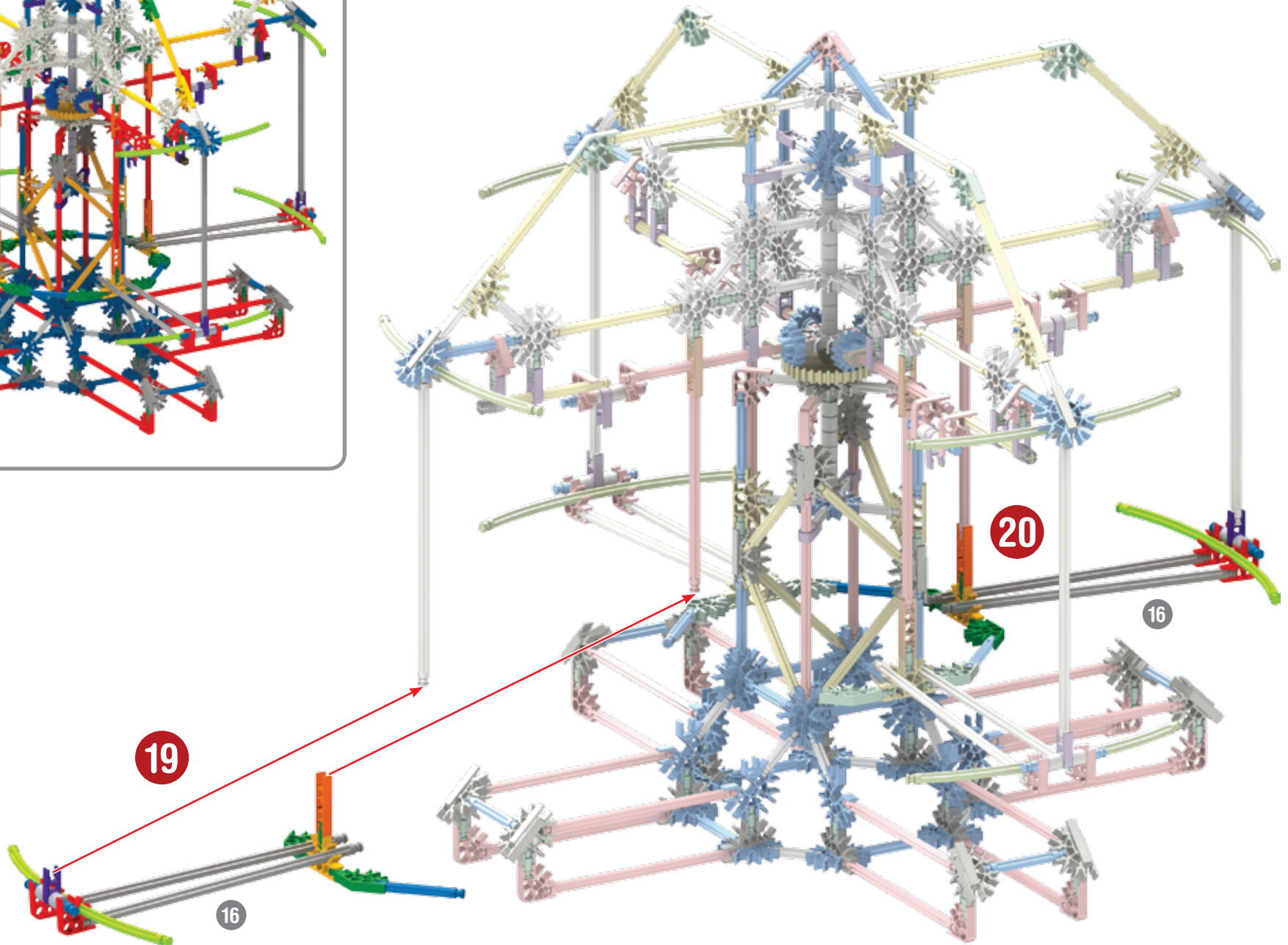
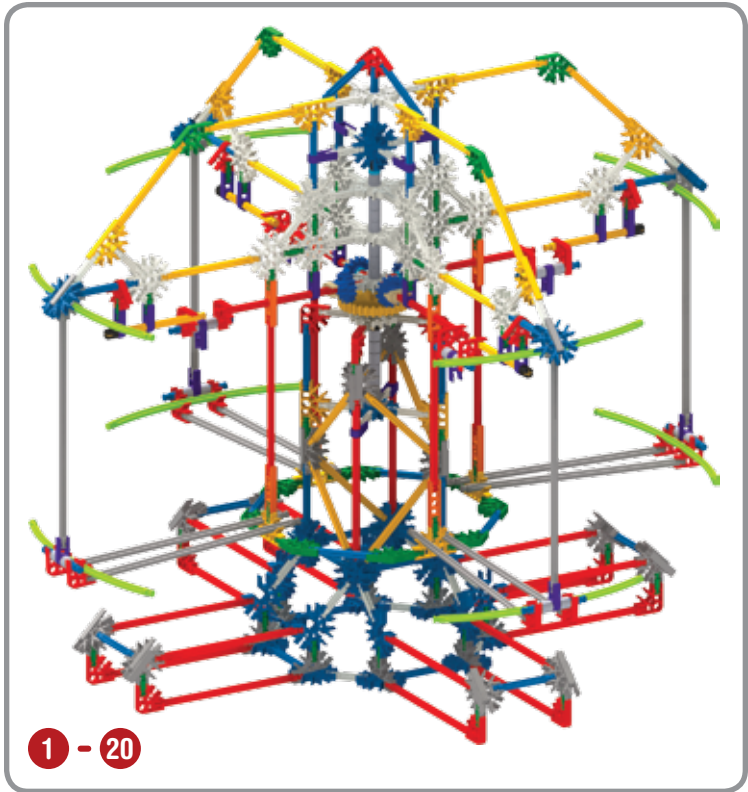

x4

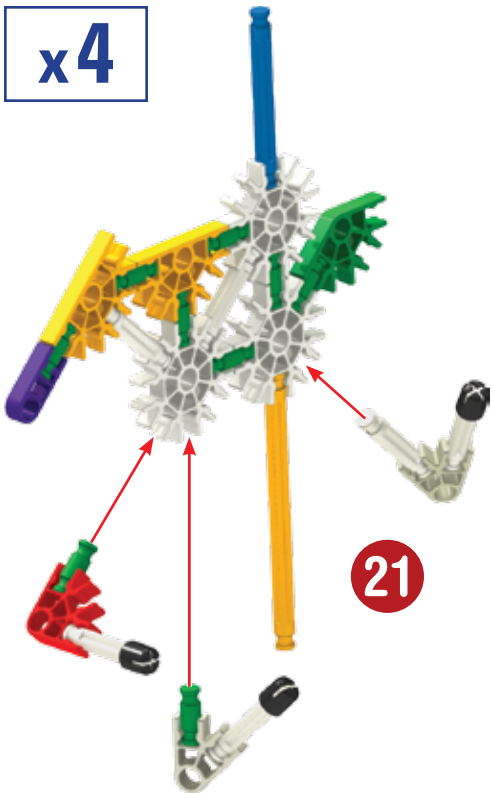

36		12		8		4		12	
24		4		4		8			
4									
4									

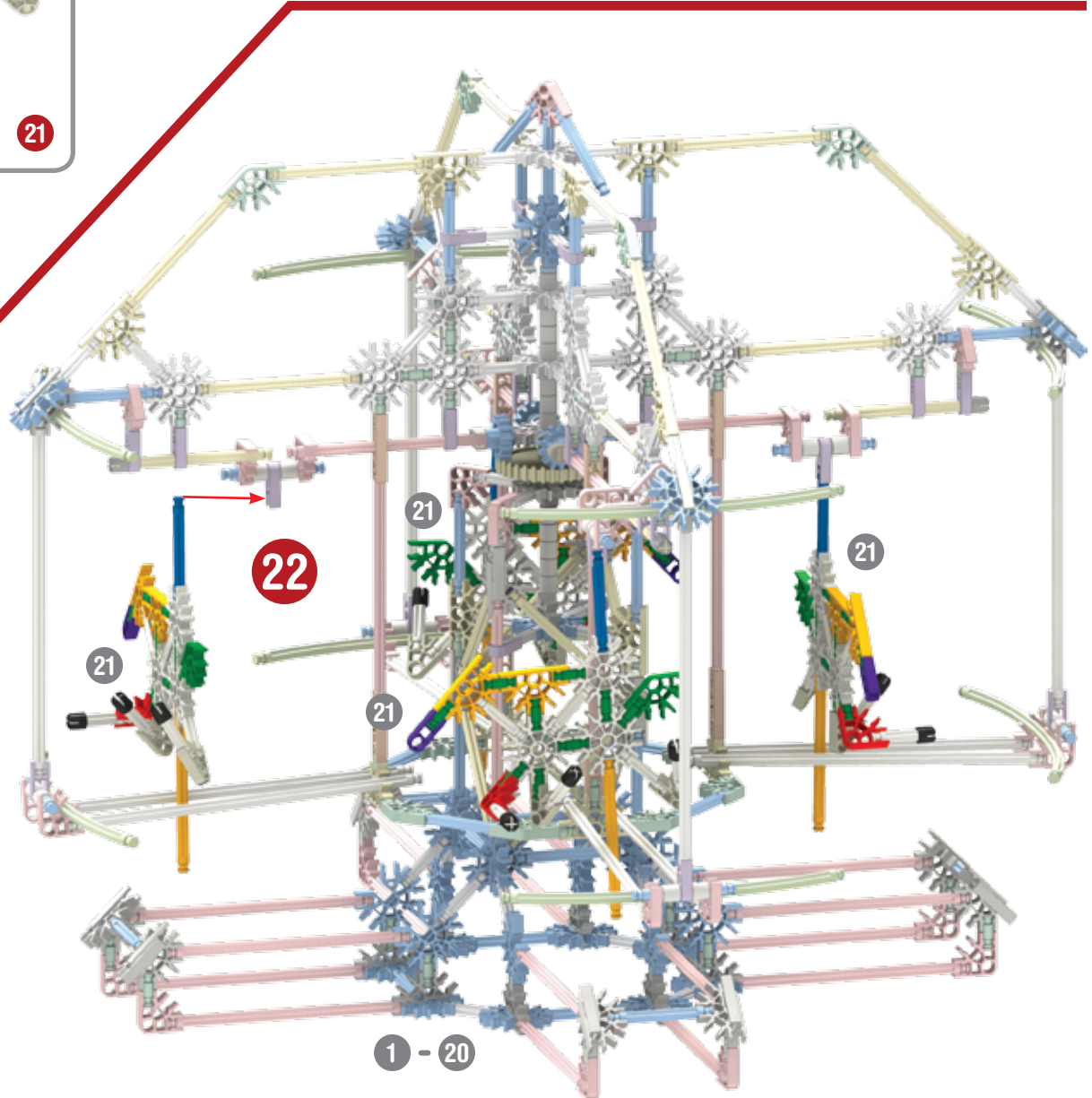
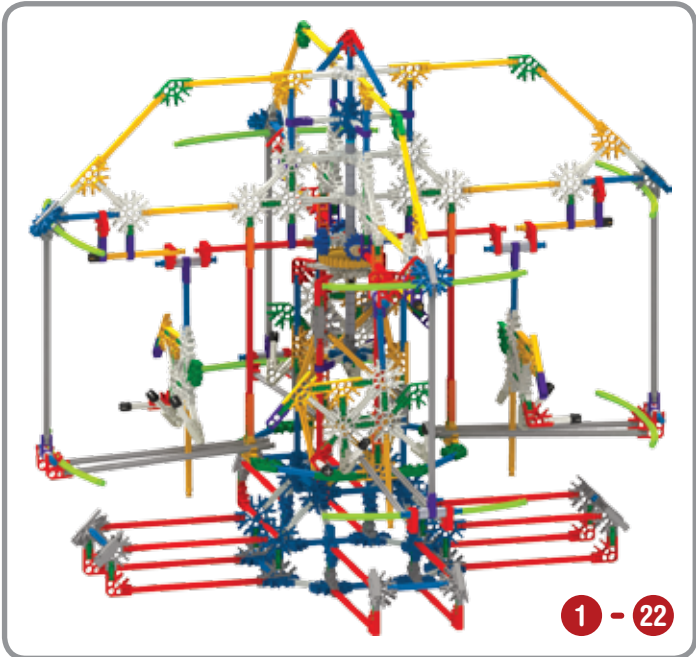

x4

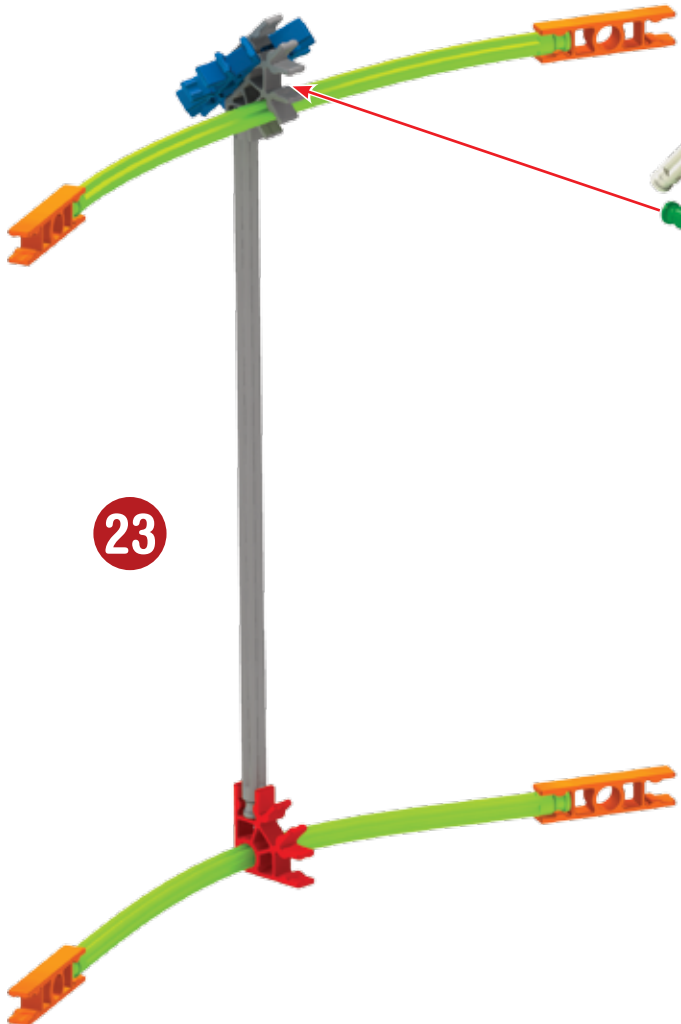

23

- | | | | | | |
|----|--|----|--|---|--|
| 12 | | 16 | | 4 | |
| 12 | | 4 | | | |
| 8 | | | | | |
| 12 | | | | | |
| 4 | | | | | |
| 8 | | | | | |
| 24 | | 4 | | 4 | |

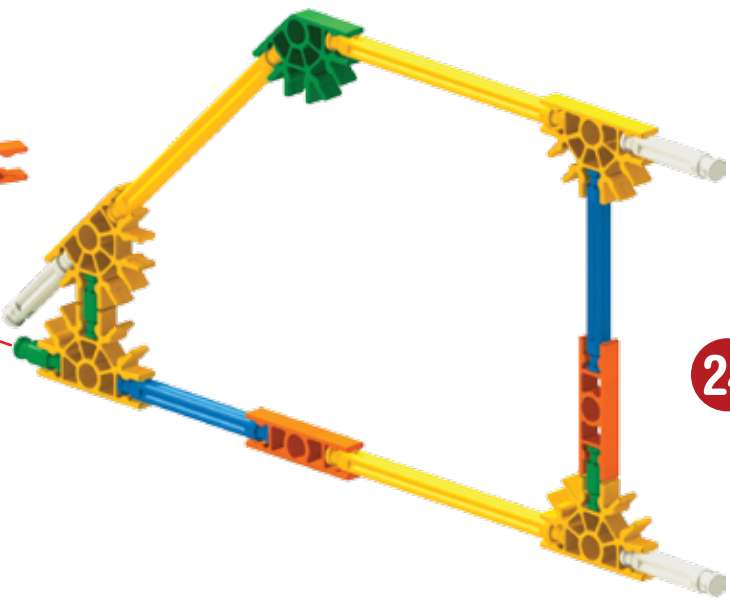

24

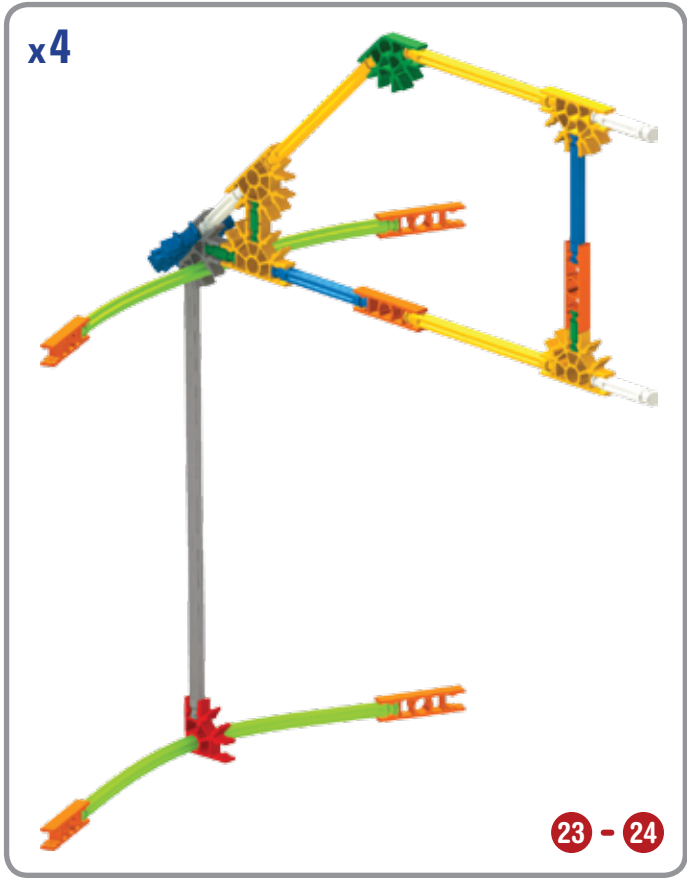

x4

23 - 24

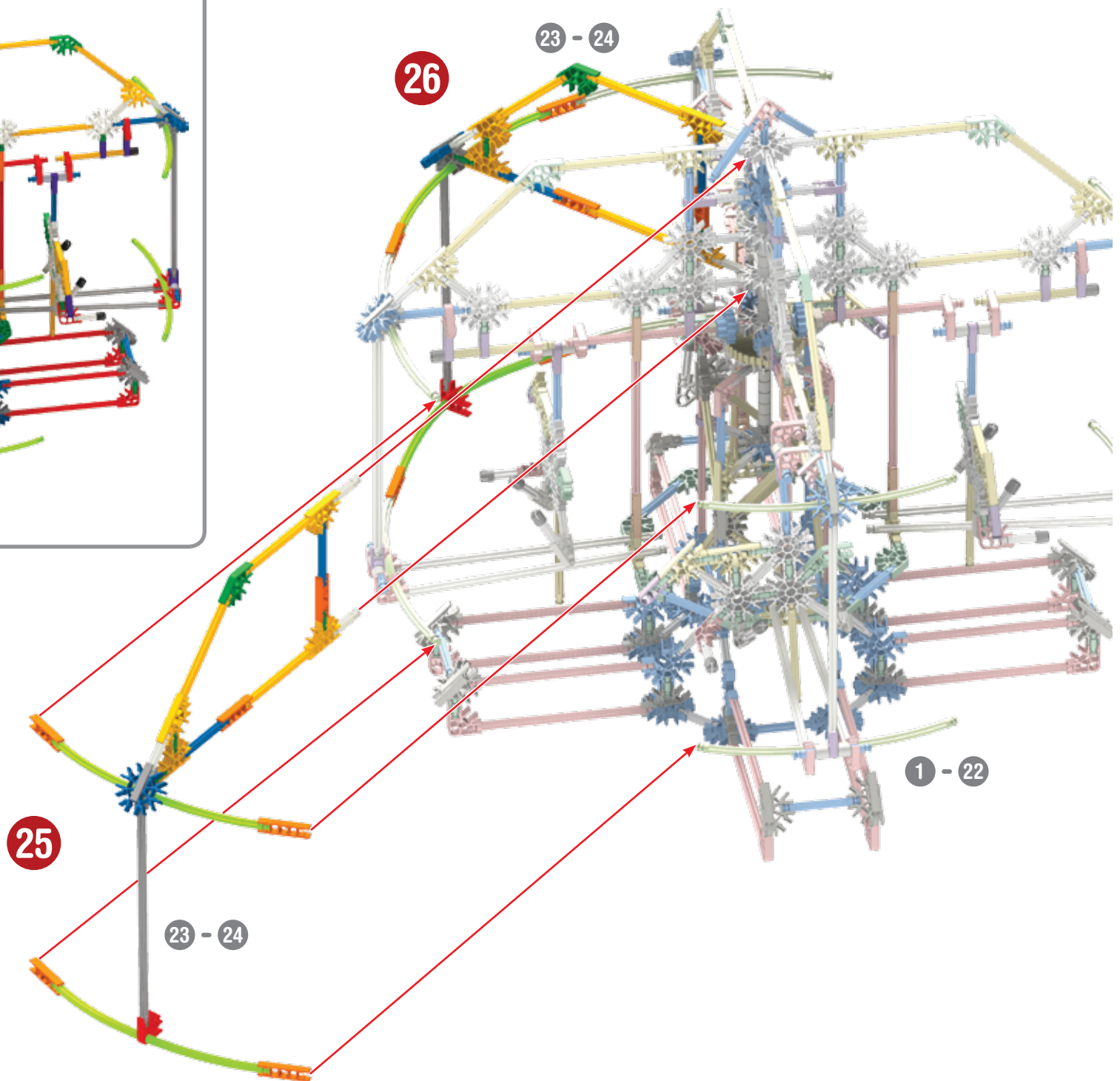
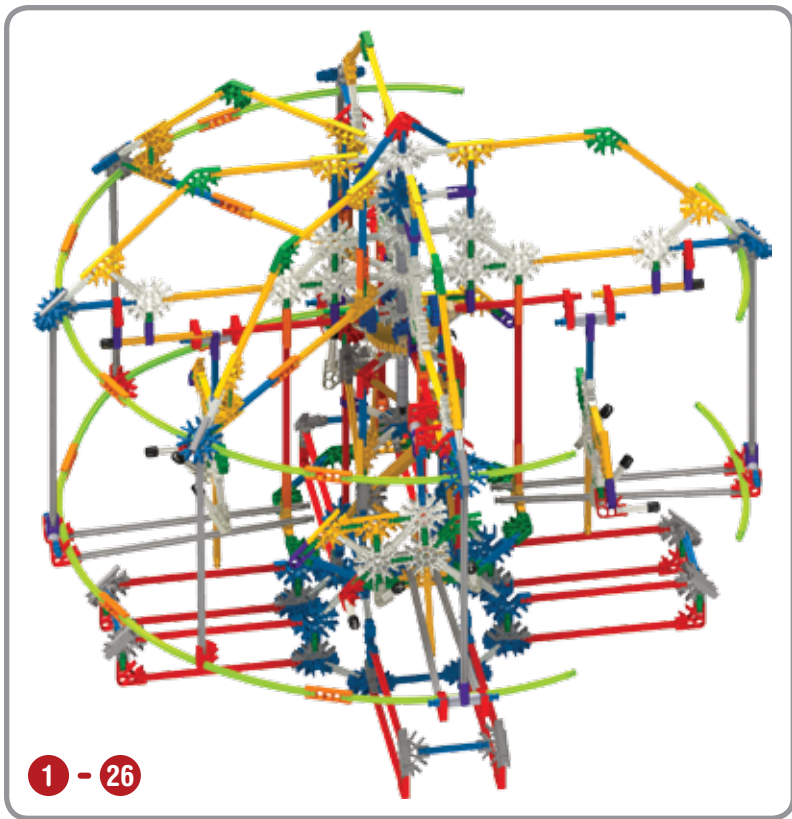

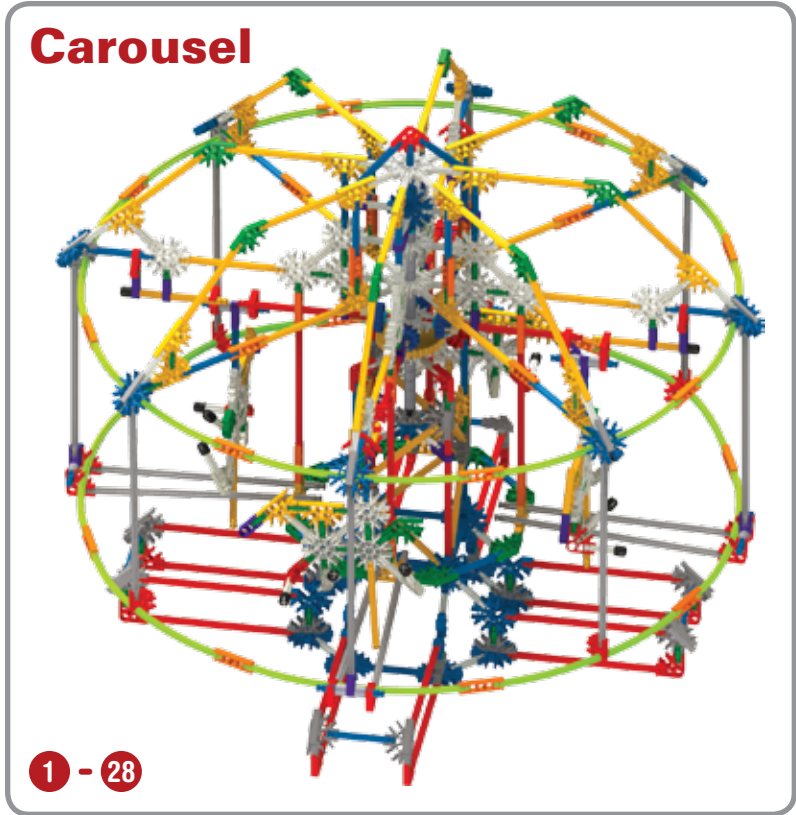
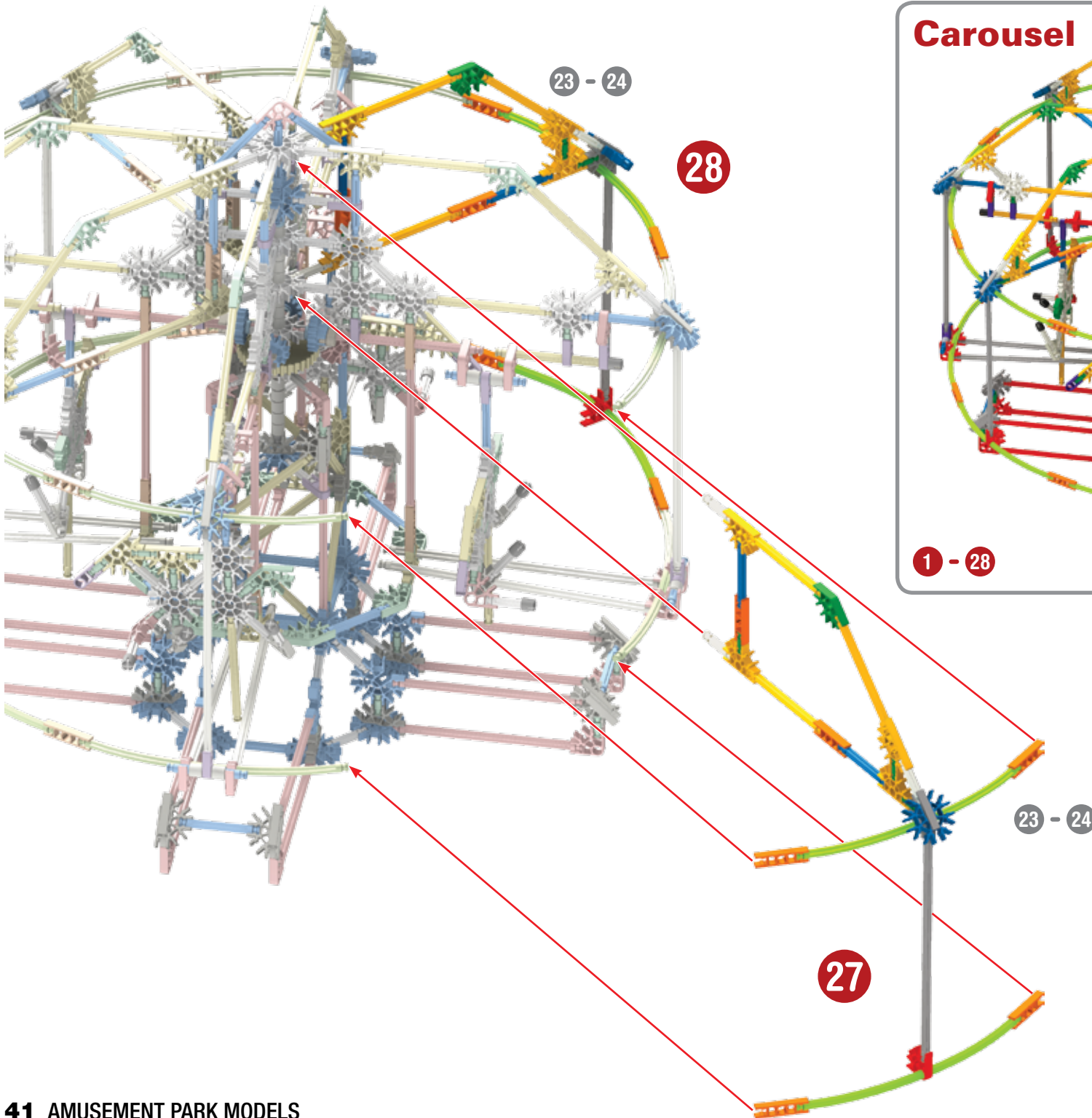

Giant Swing Ride



x2

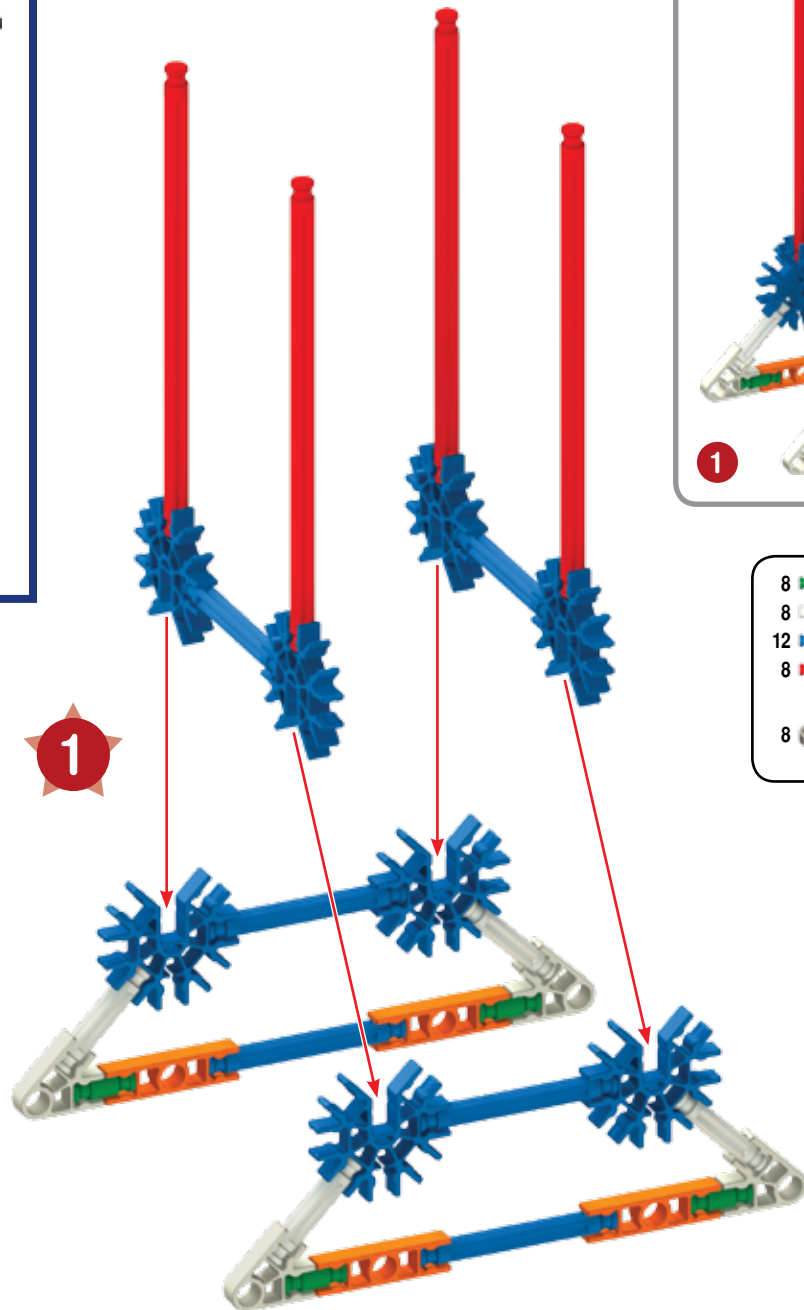
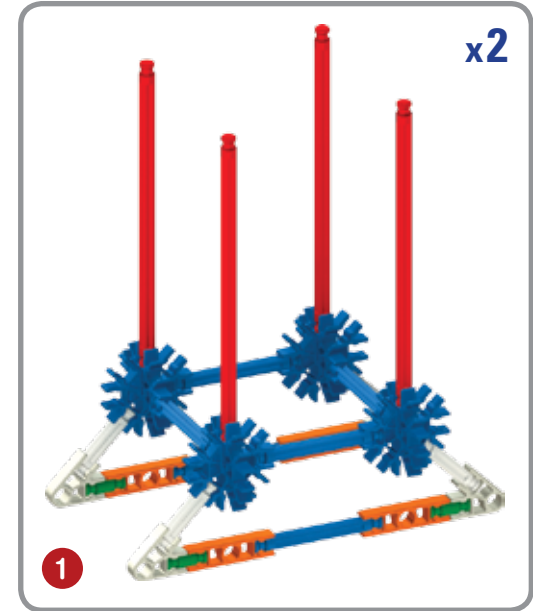

- | | | | |
|----|--|----|--|
| 8 | | 8 | |
| 8 | | | |
| 12 | | | |
| 8 | | | |
| 8 | | 16 | |

x2

8		4		16	
8					
8					

2

x2

3

x2

1 - 4

x2

1 - 2

1 - 2

8		4	
8			
4			
8			
4			
8		12	

4

1 - 2

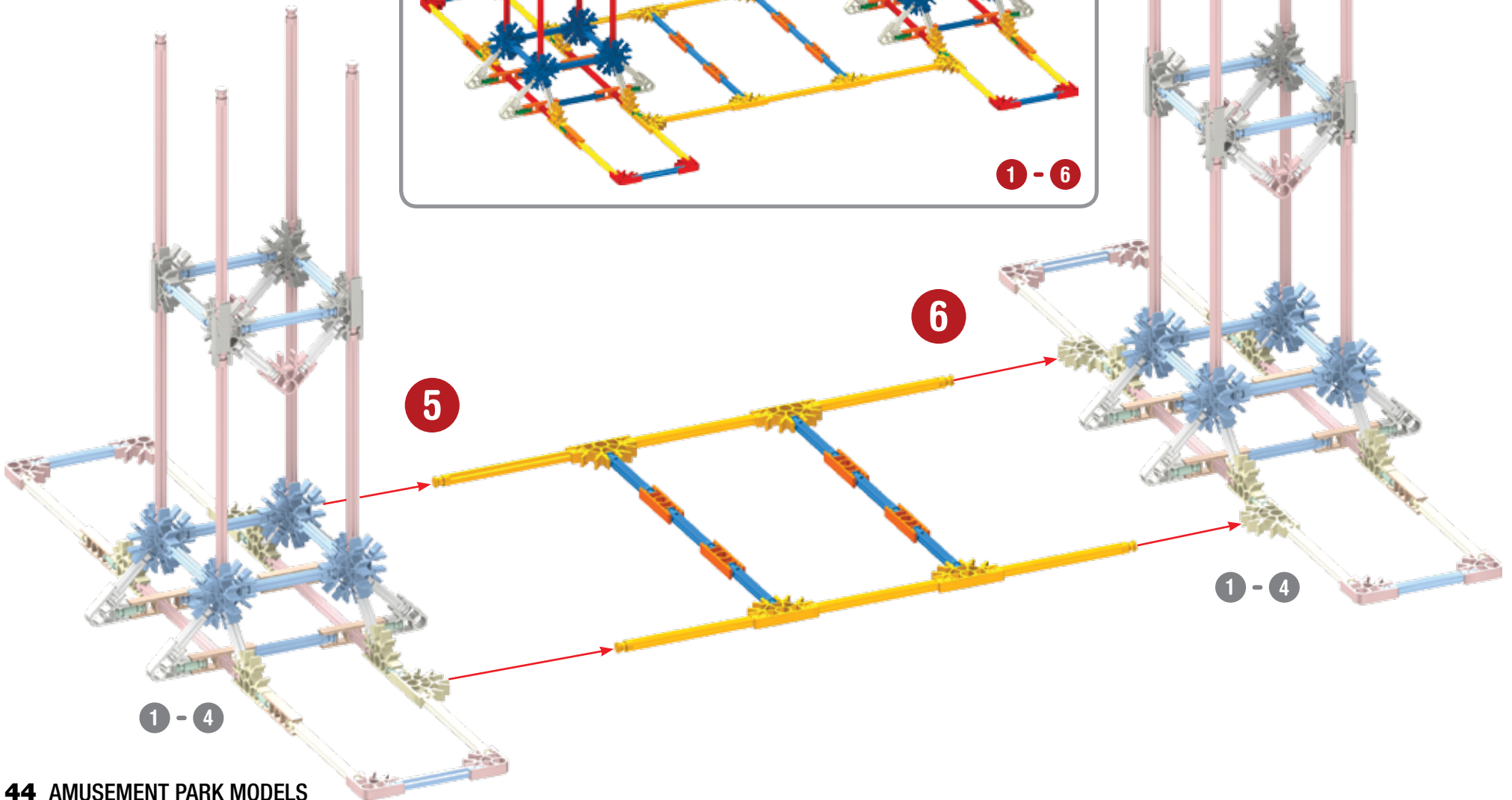
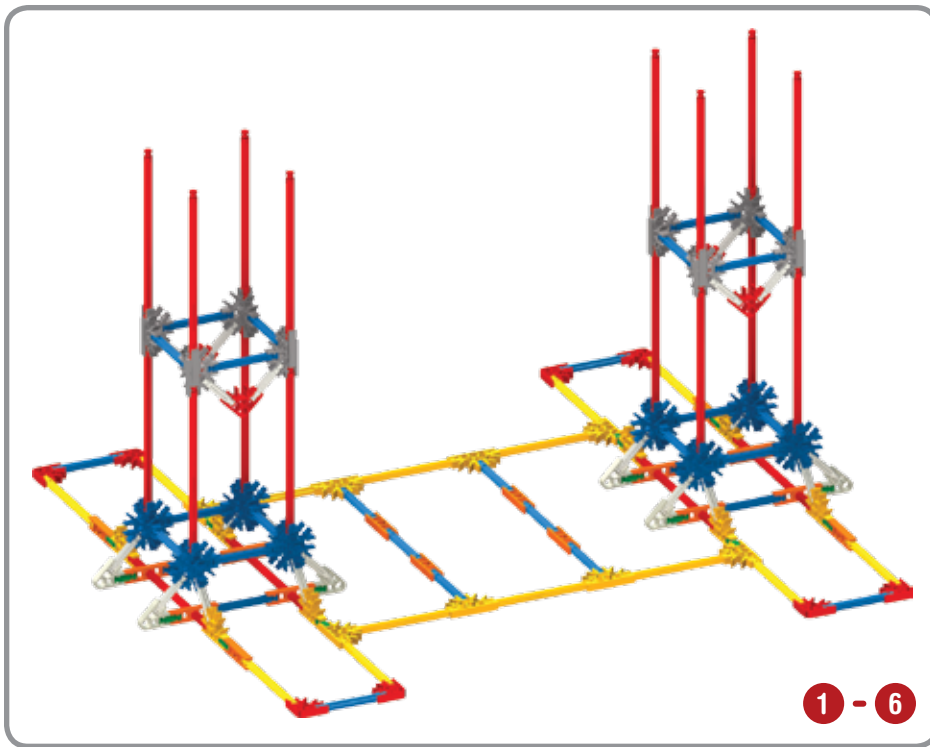
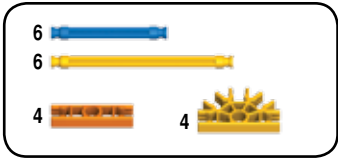

8

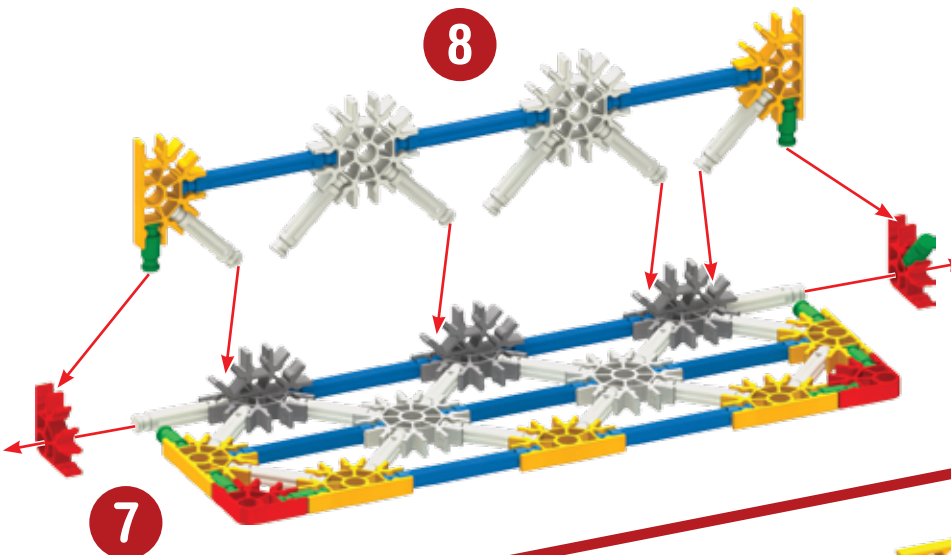

- 9
- 20
- 10
- 4
- 7
- 4
- 6

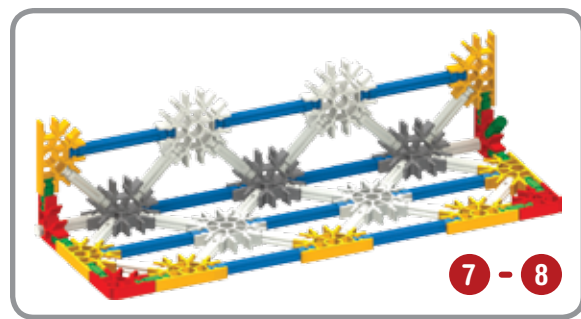

7 - 8

7

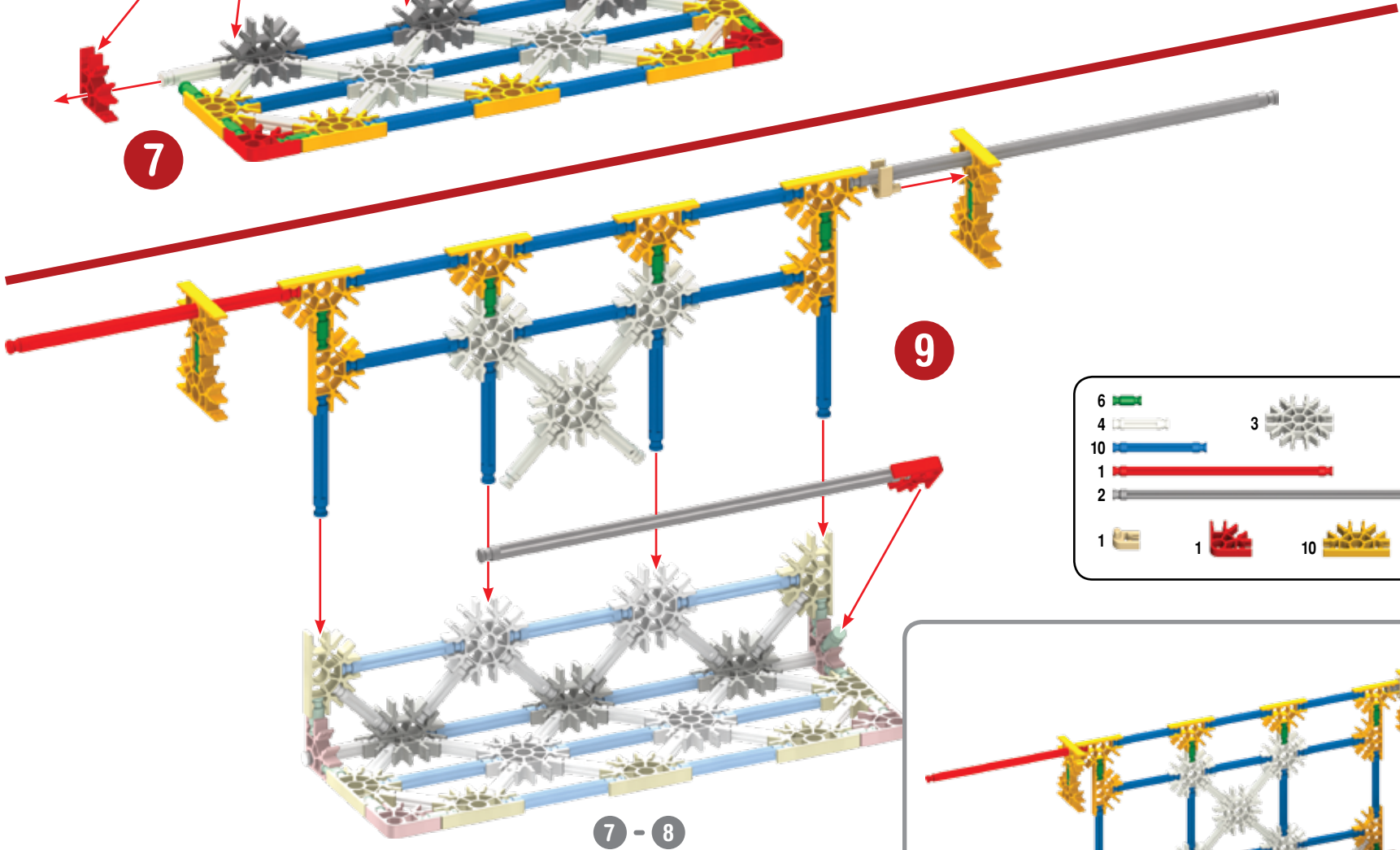

9

- 6
- 4
- 10
- 1
- 2
- 1
- 1
- 3
- 10

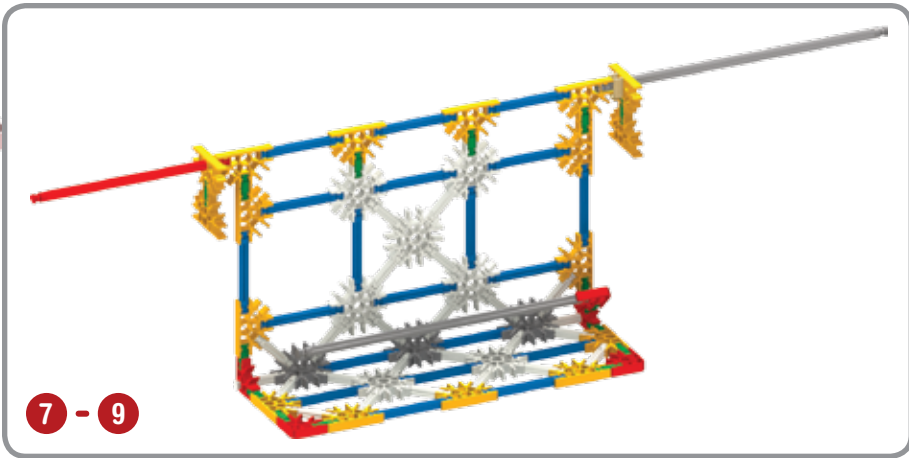

7 - 9

7 - 8

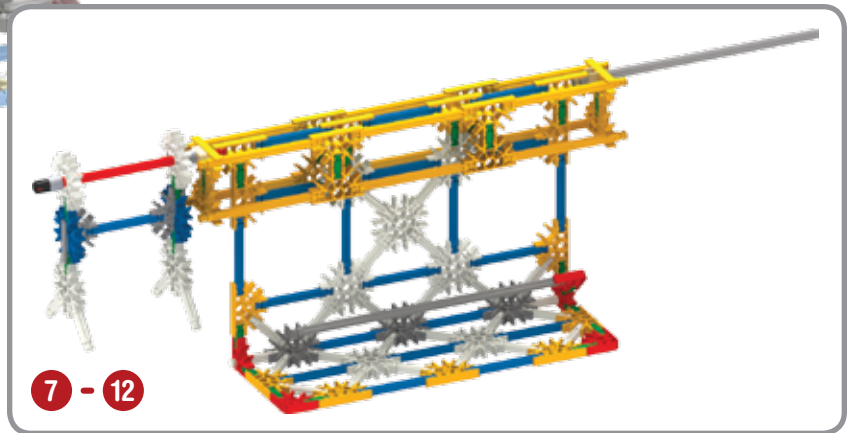
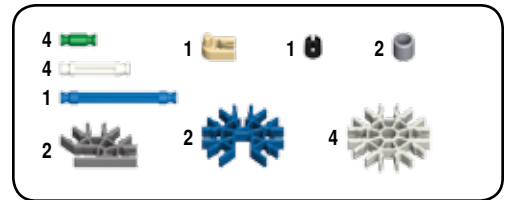
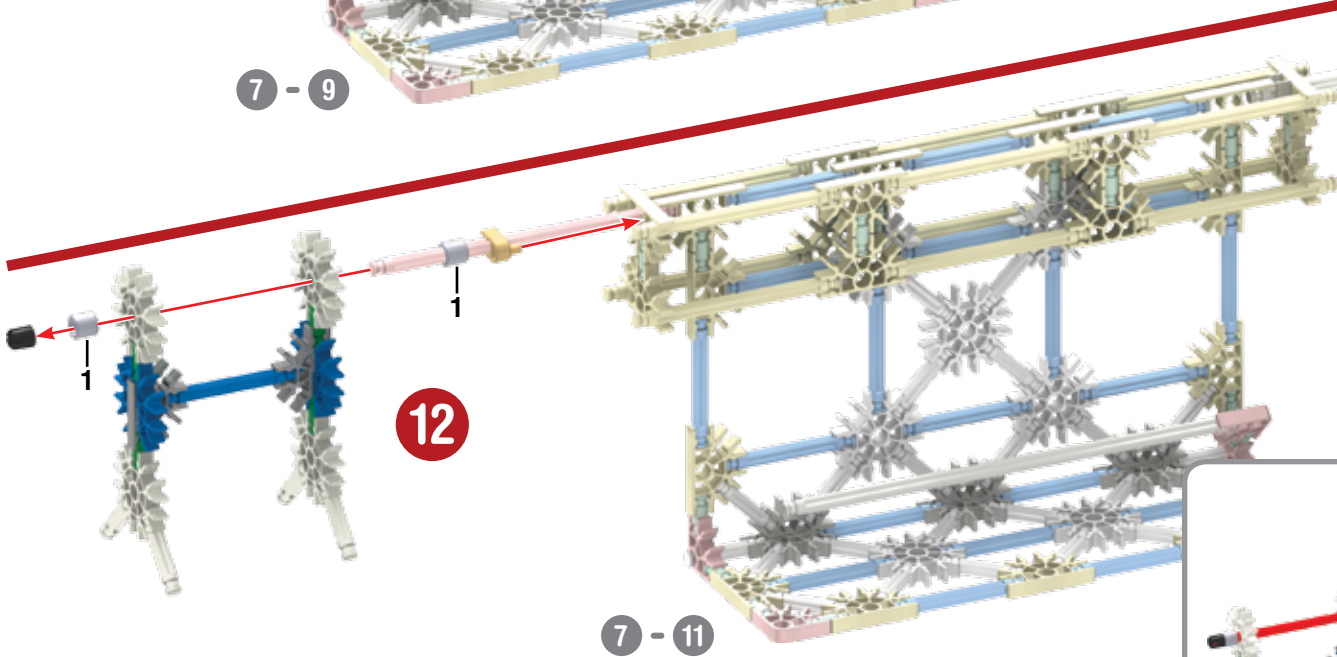
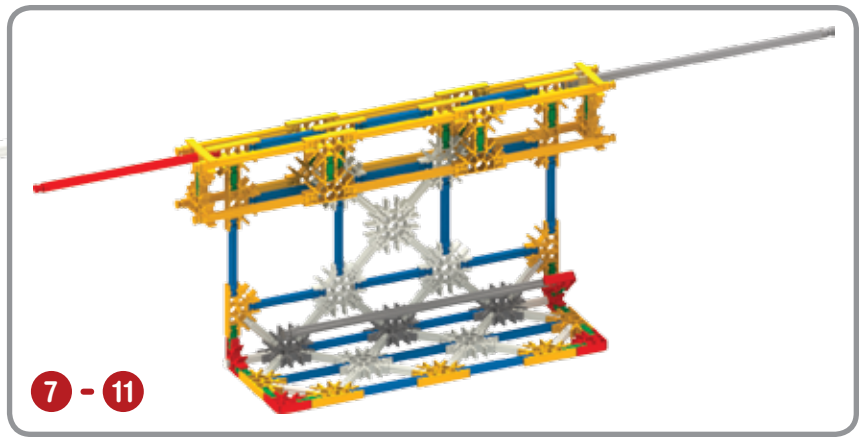
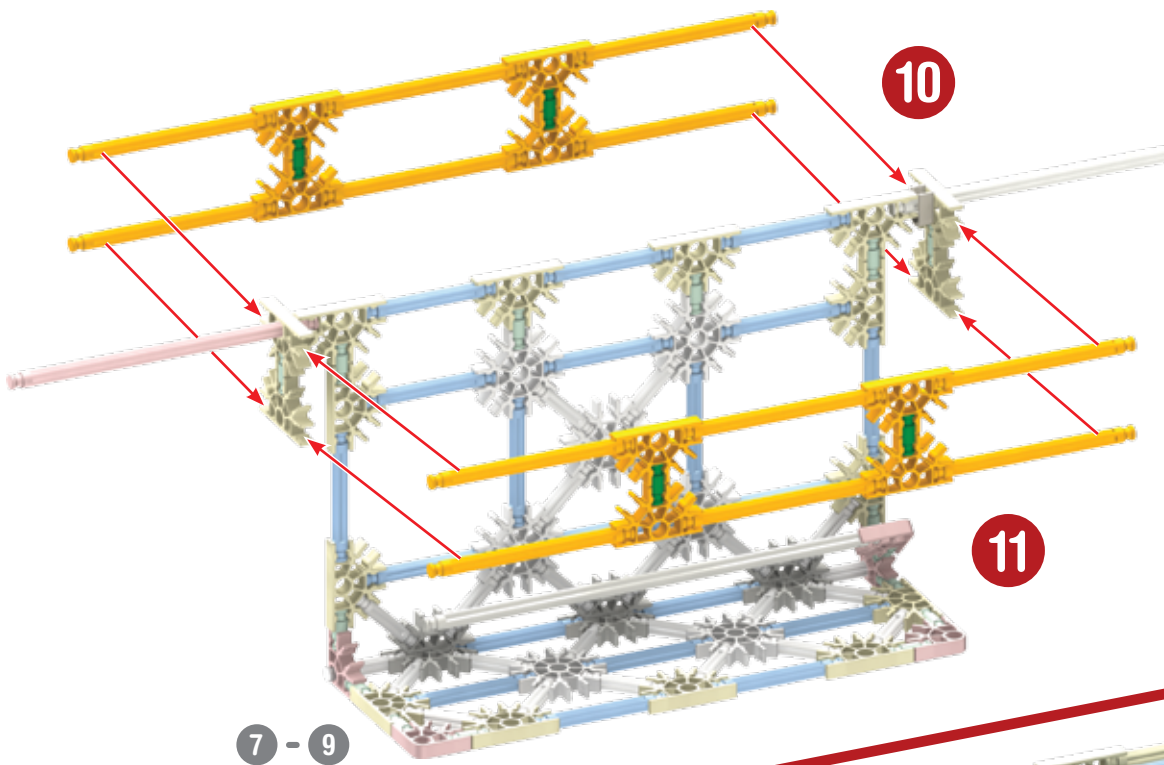

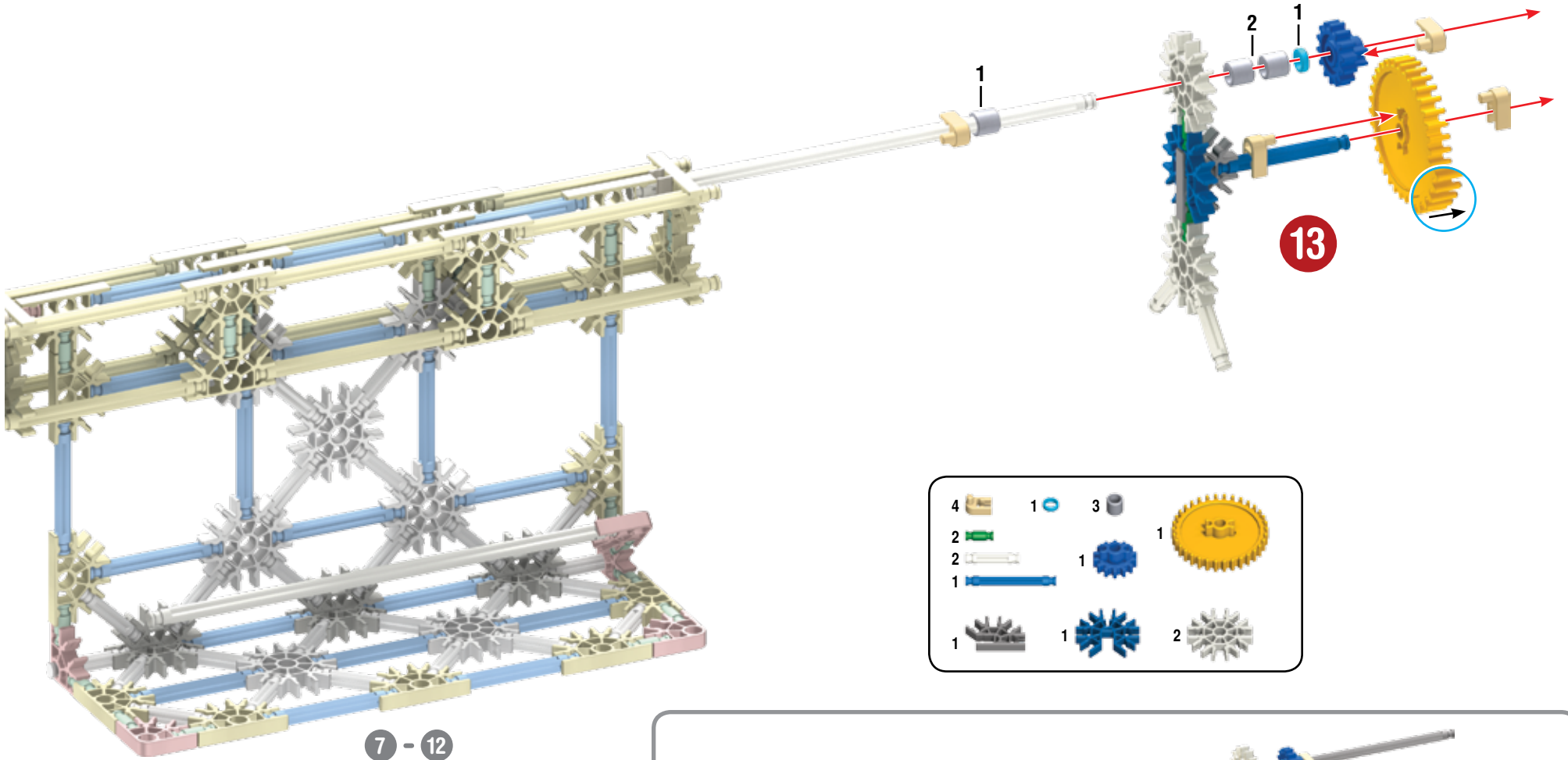

7 - 12

- | | | | | | | |
|---|--|---|--|---|--|--|
| 4 | | 1 | | 3 | | |
| 2 | | | | 1 | | |
| 2 | | | | | | |
| 1 | | | | | | |
| 1 | | 1 | | | | |
| | | | | | | |

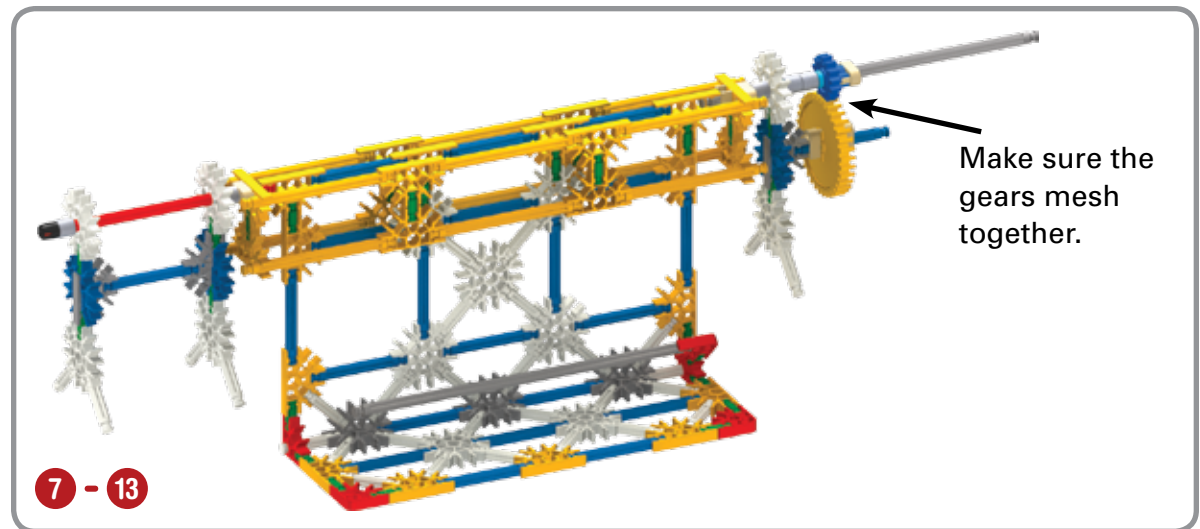

7 - 13

Make sure the gears mesh together.

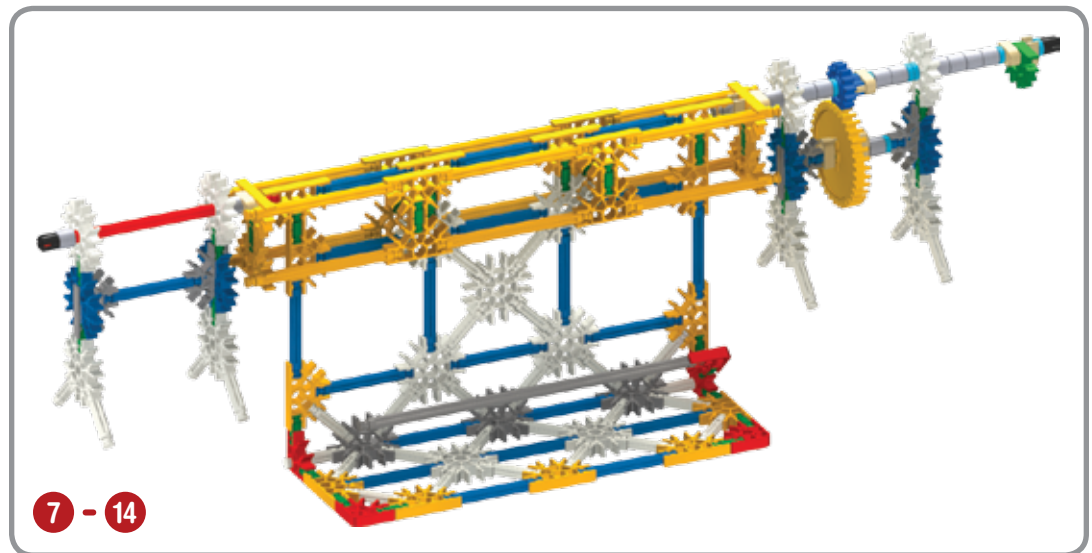
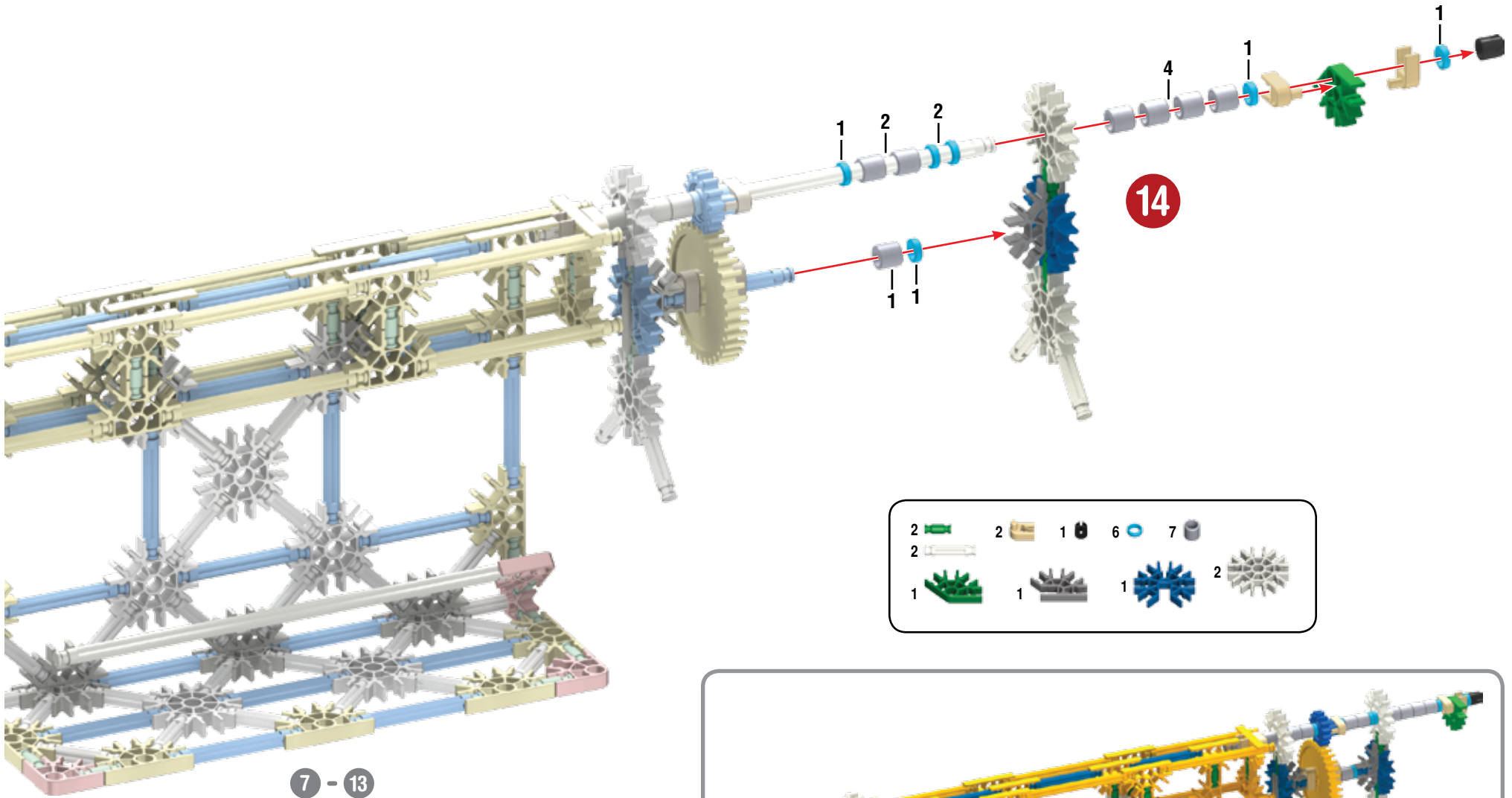

7 - 14

15

1 - 6

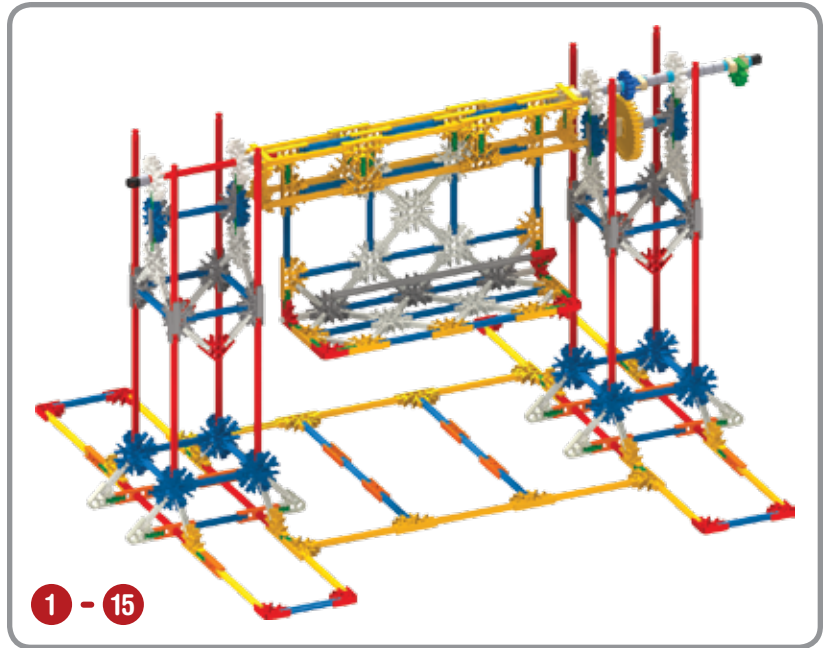

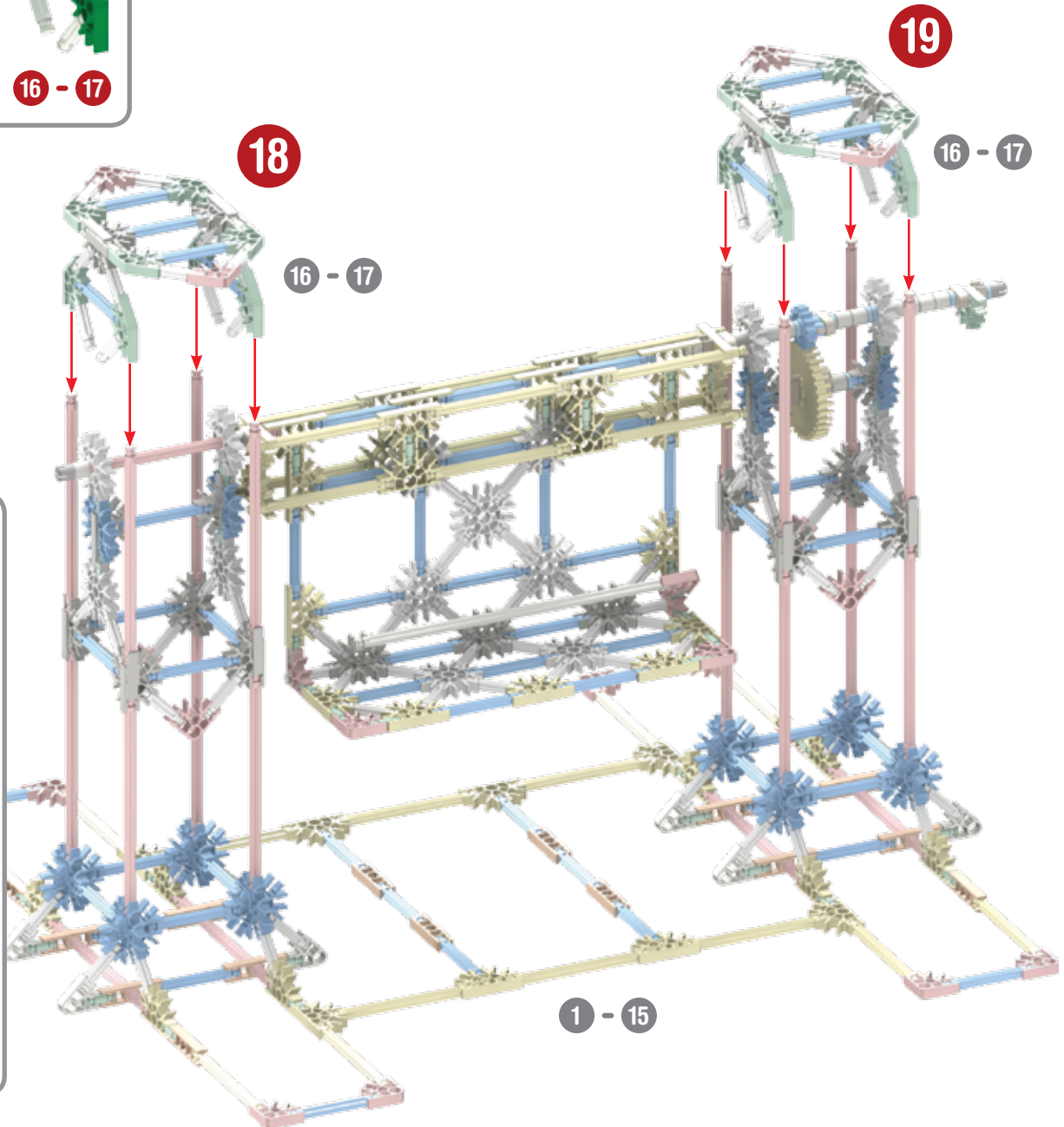
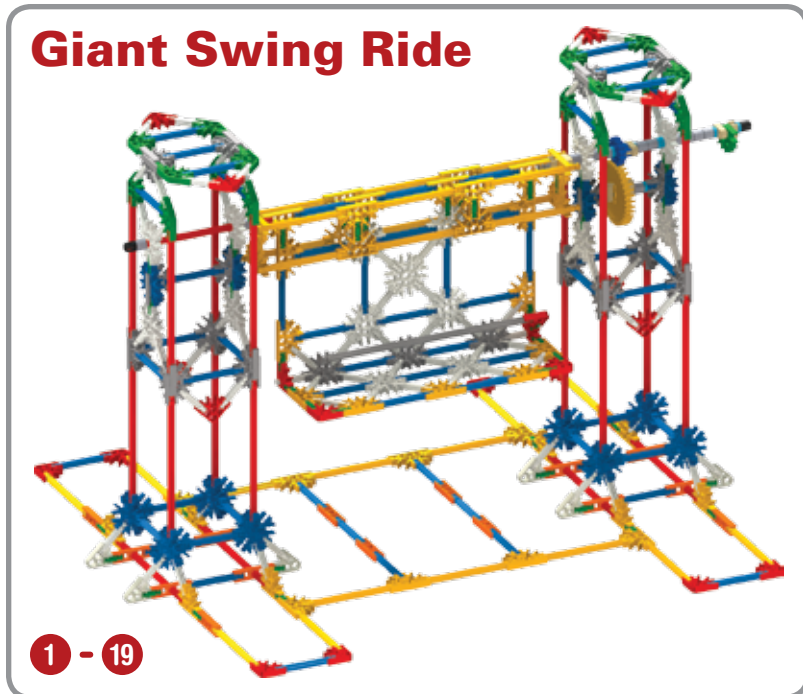
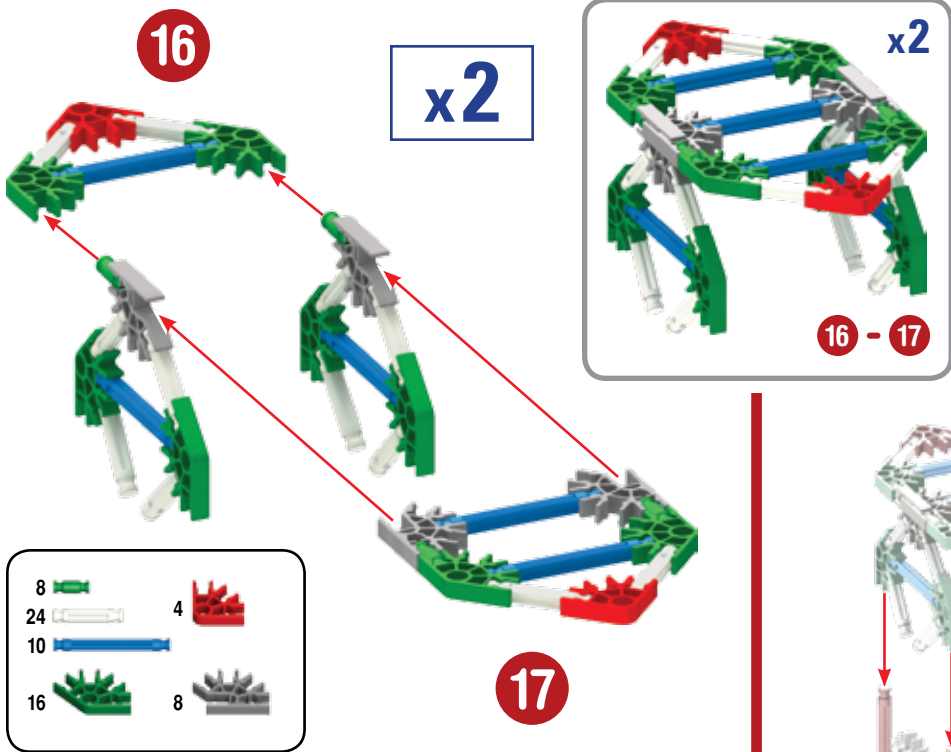

Large Ferris Wheel

x2

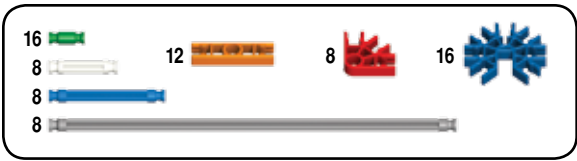
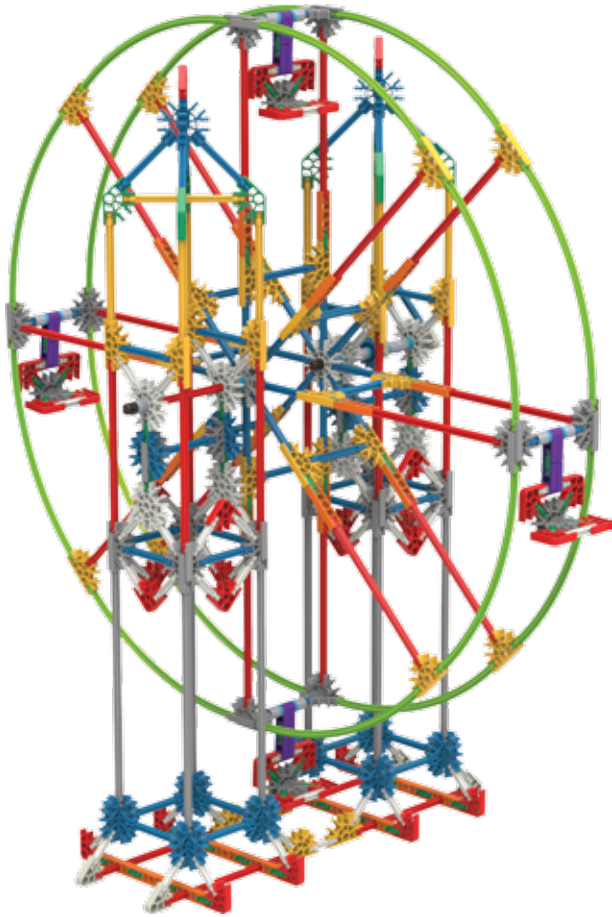

2

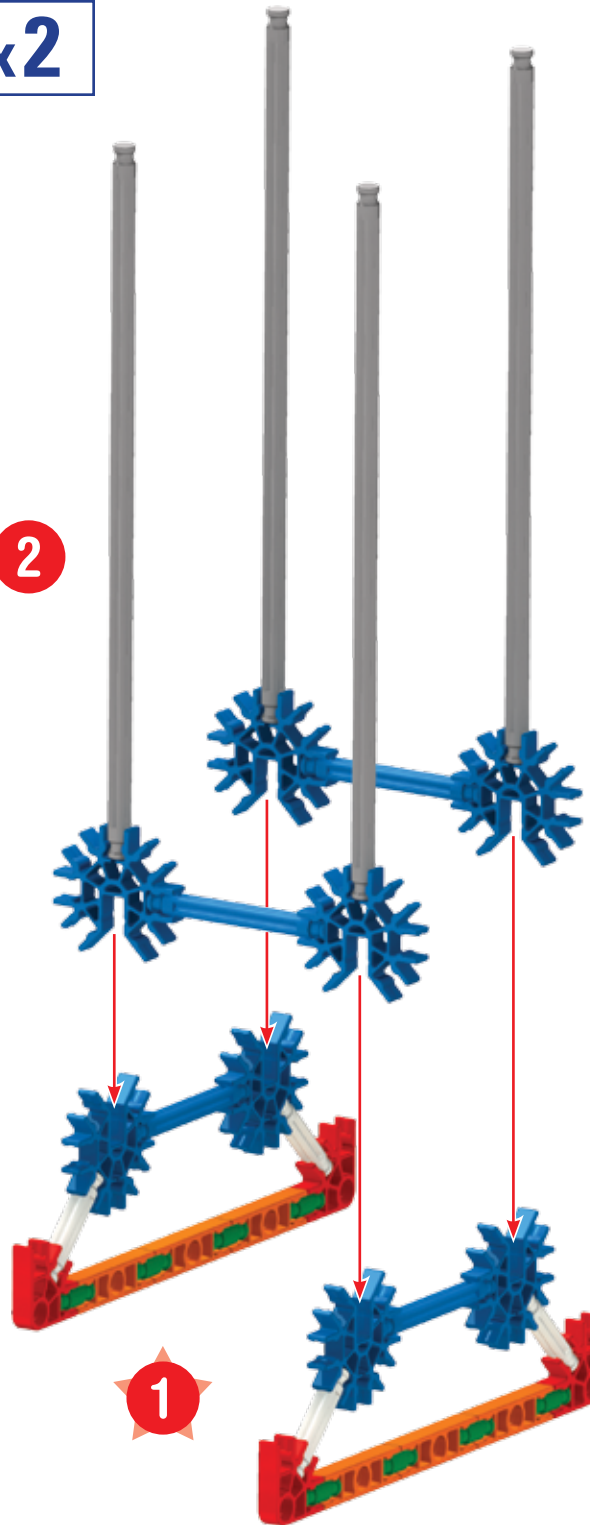

x2

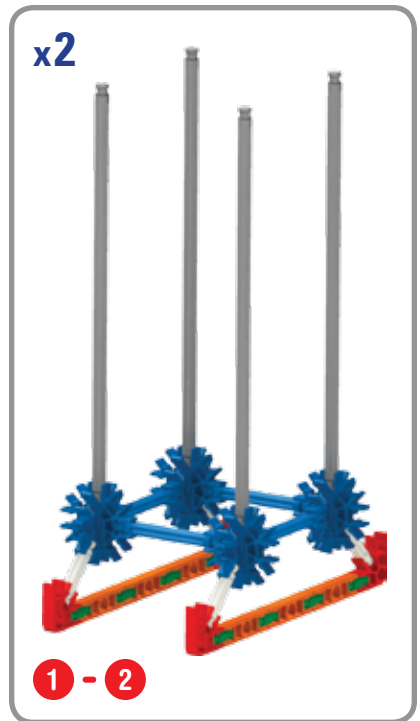

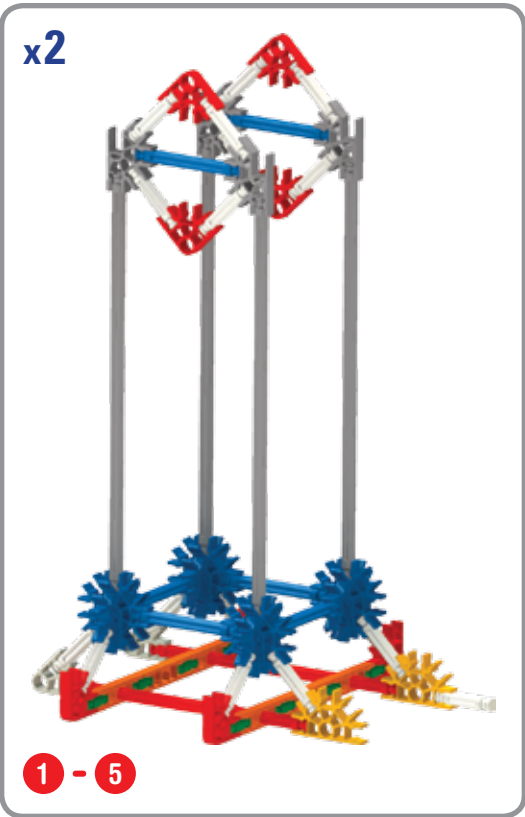

x2

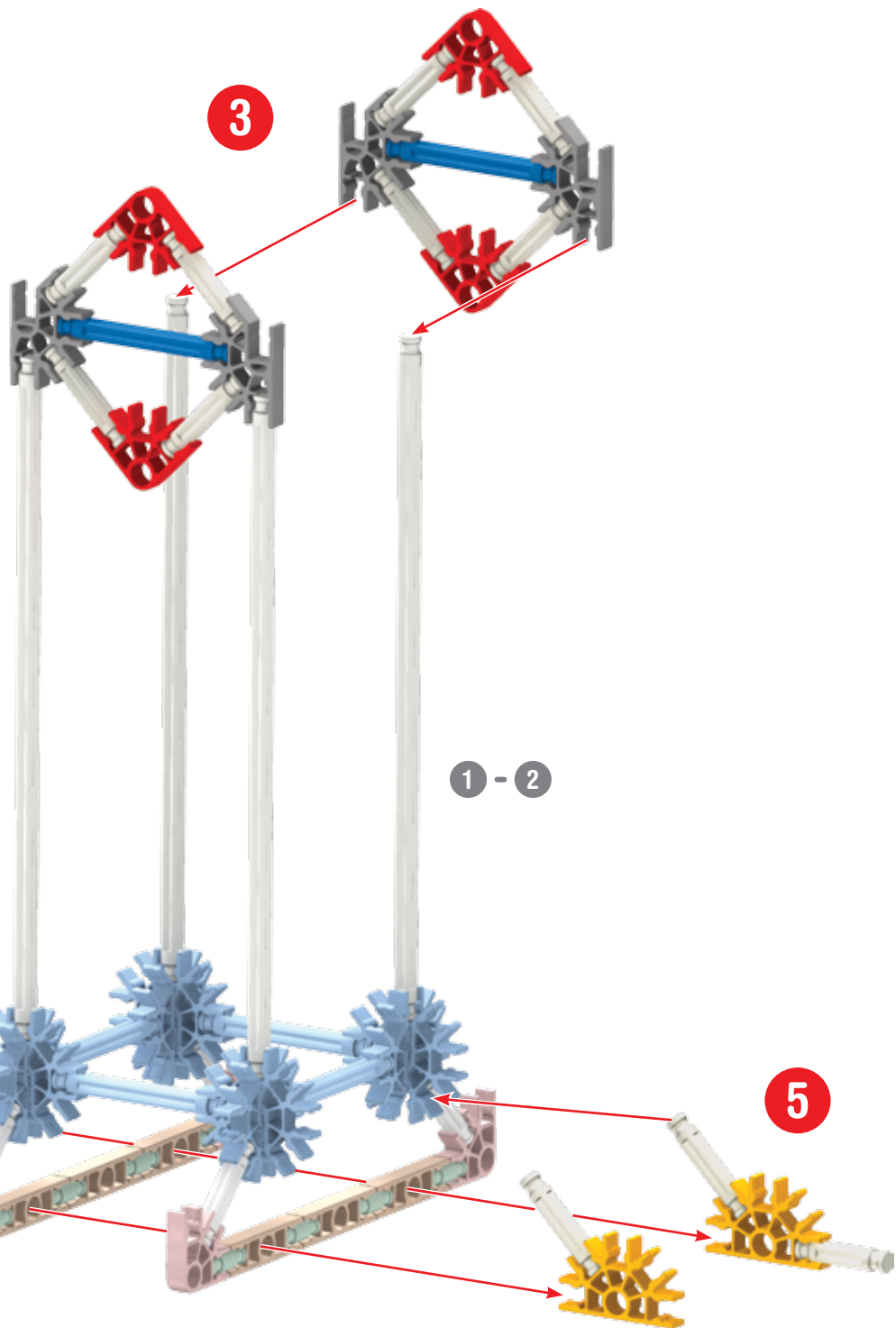

- | | | | |
|----|--|---|--|
| 26 | | 4 | |
| 4 | | 4 | |
| 4 | | | |
| 4 | | 8 | |
| | | 8 | |

x2

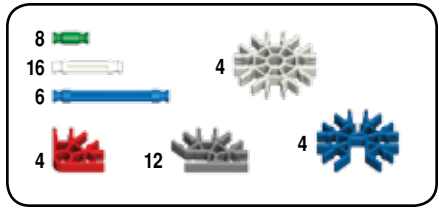

6

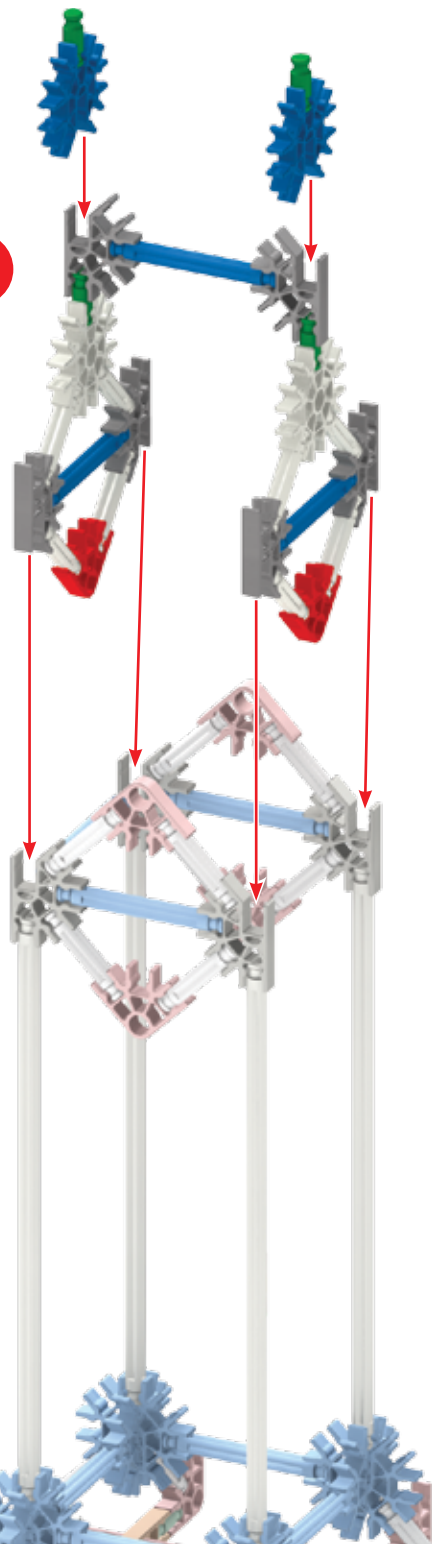

1 - 5

x2

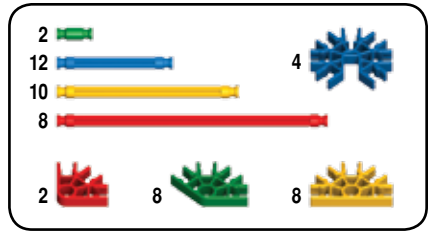

7

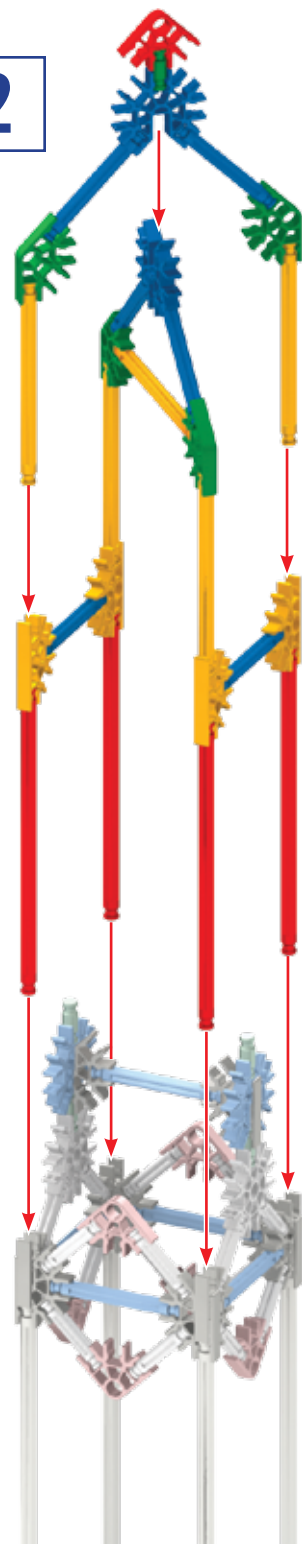

1 - 6

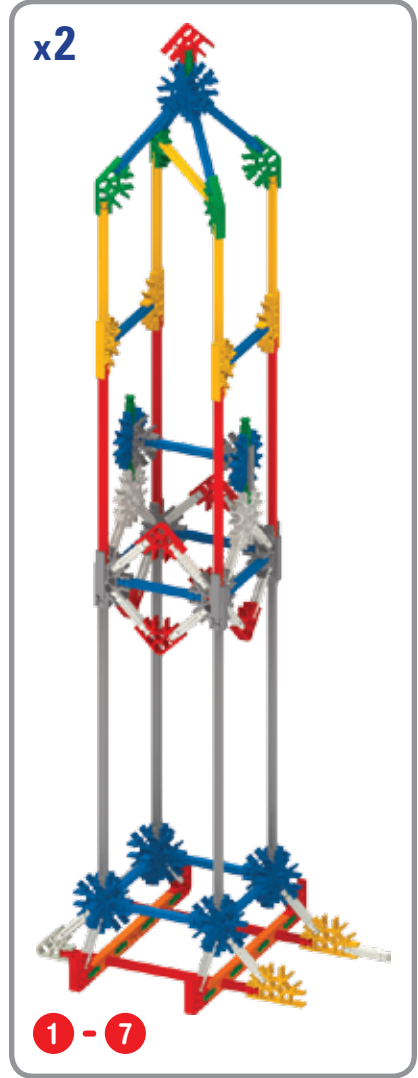
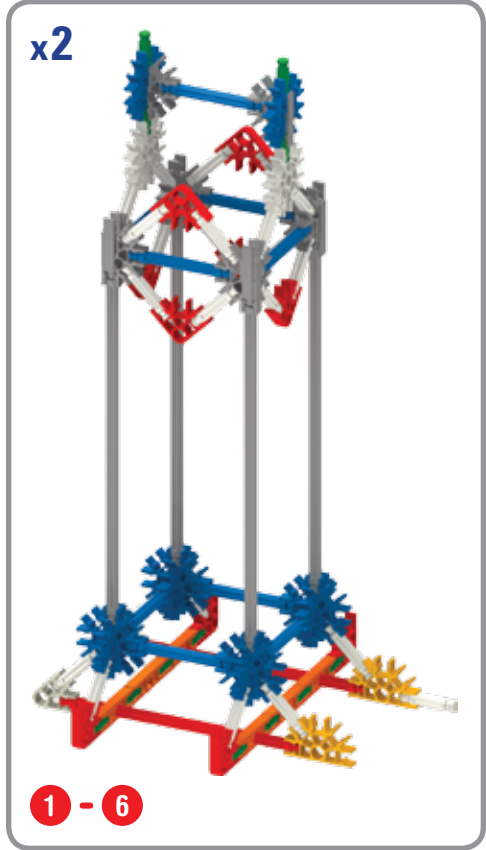

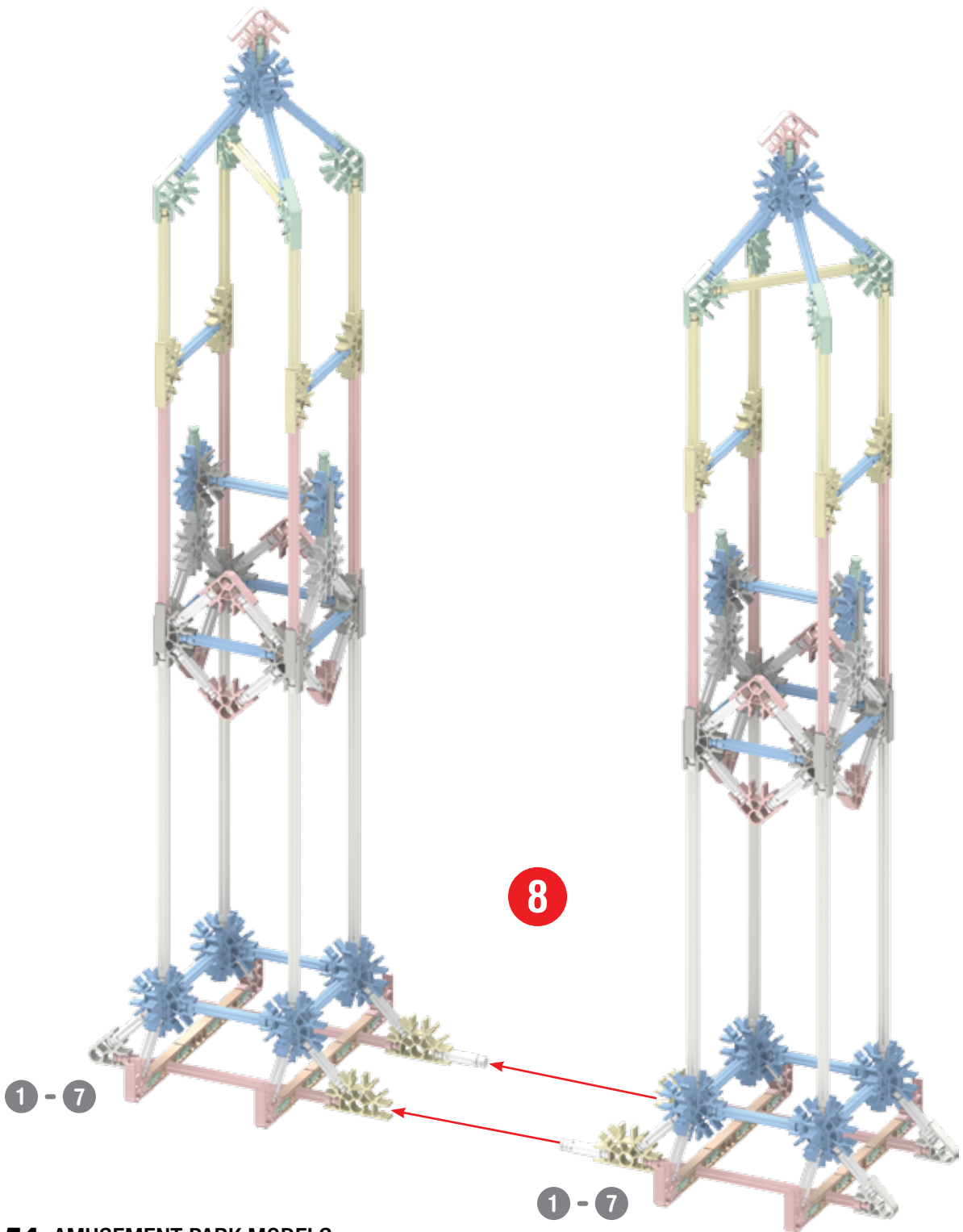

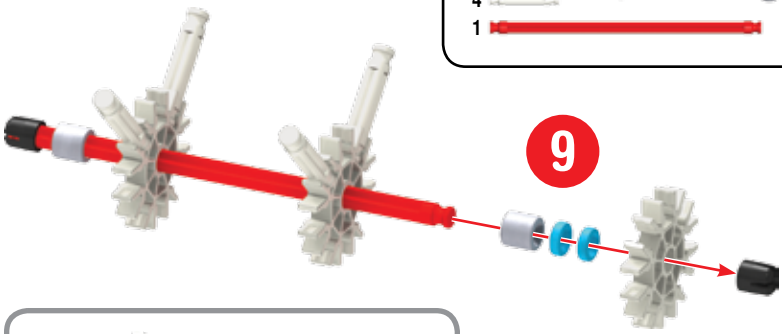
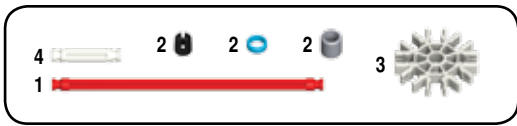

9

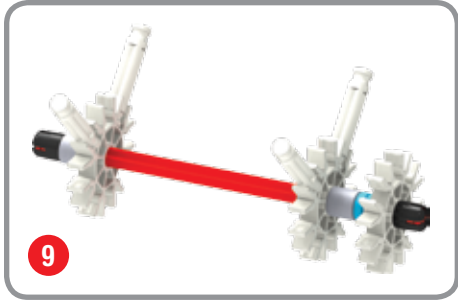

9

9

10

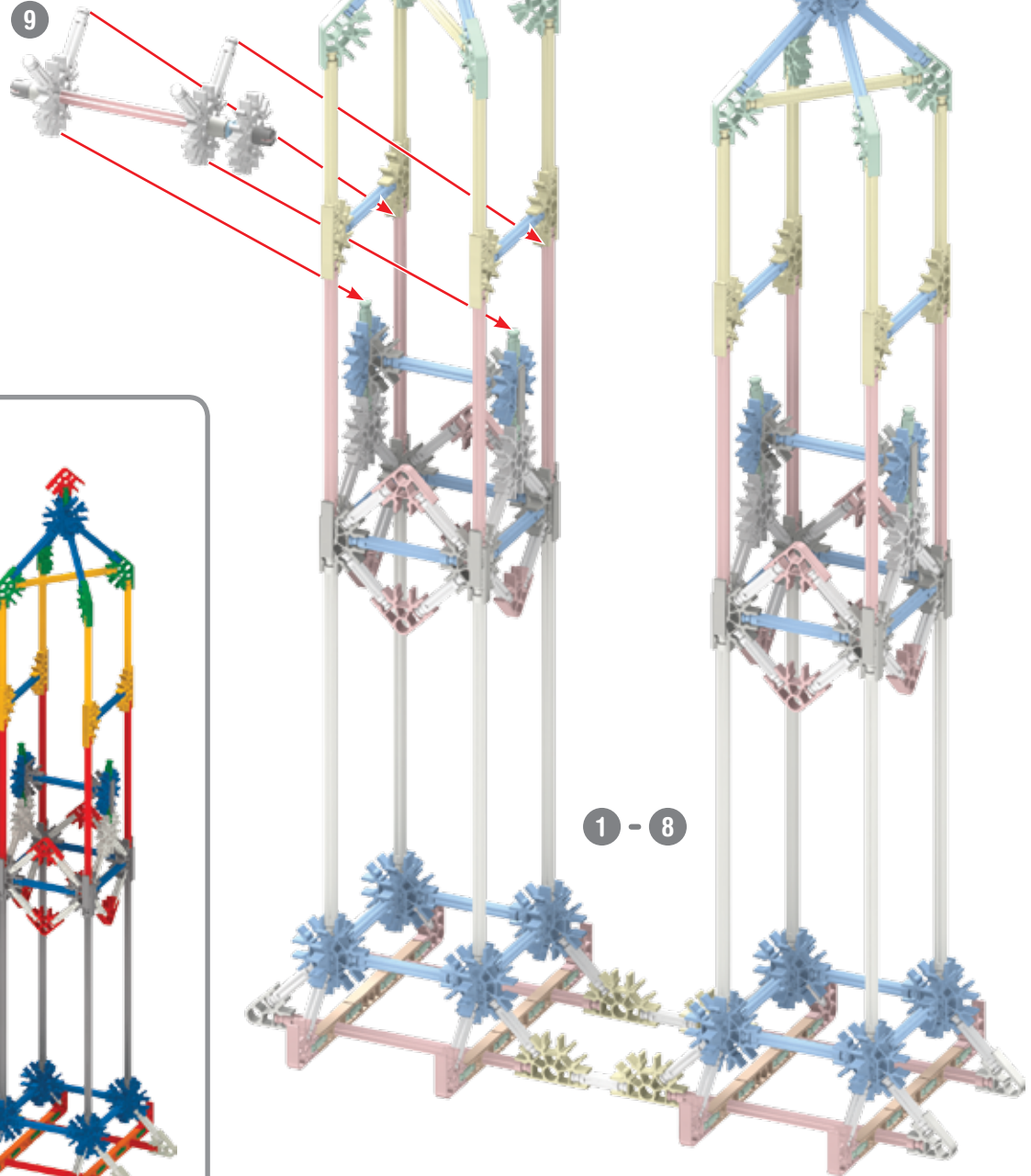

1 - 8

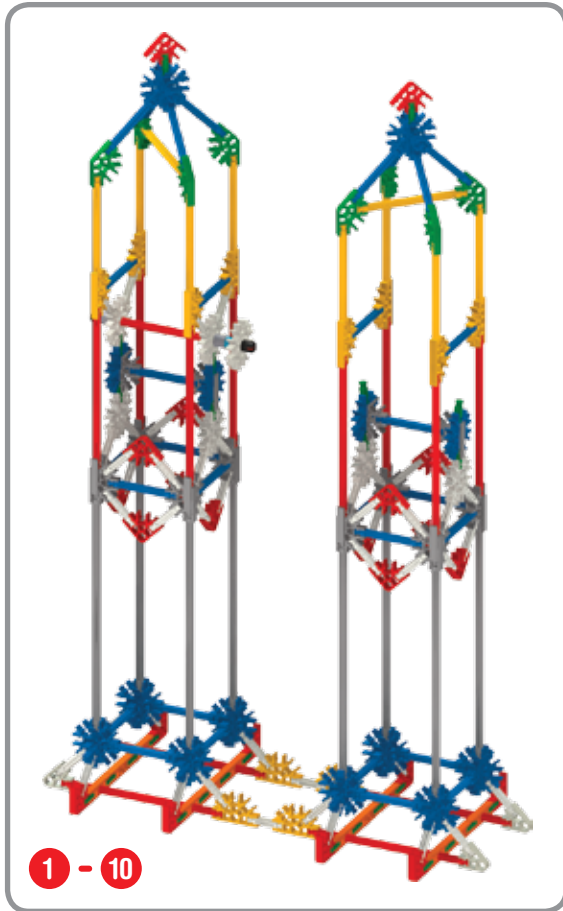

1 - 10

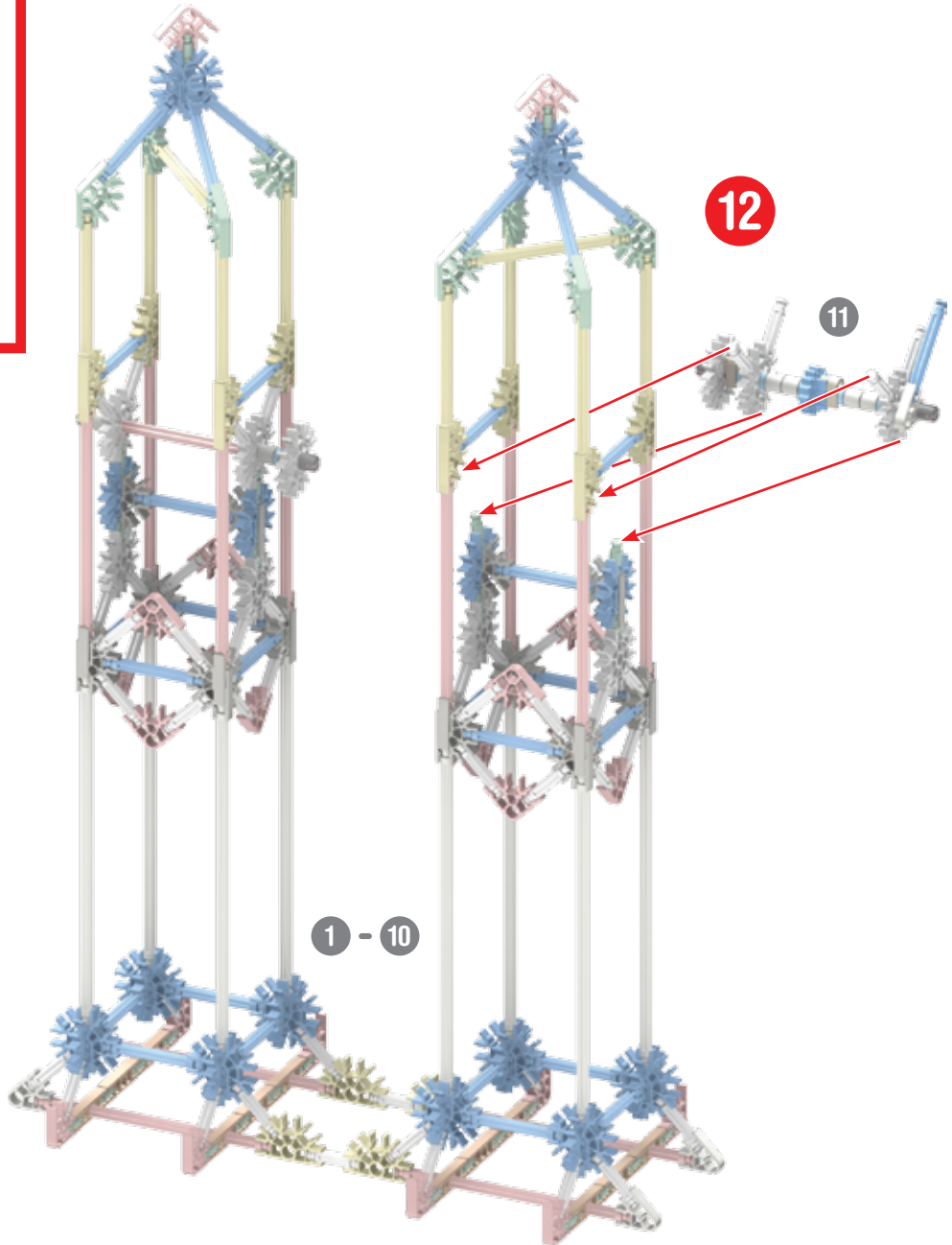
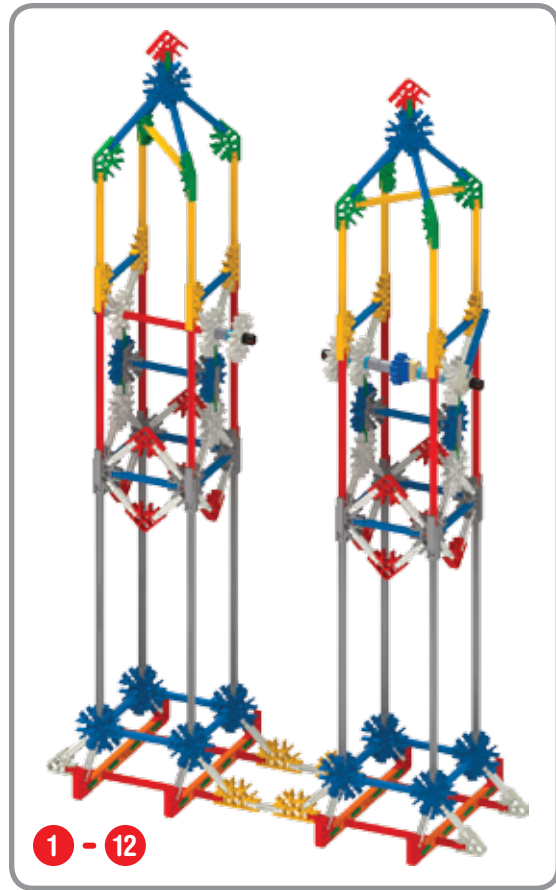
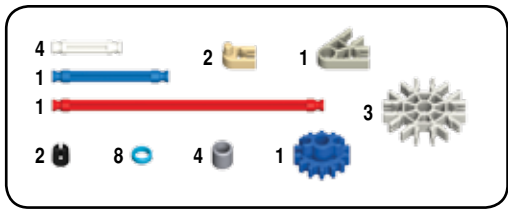
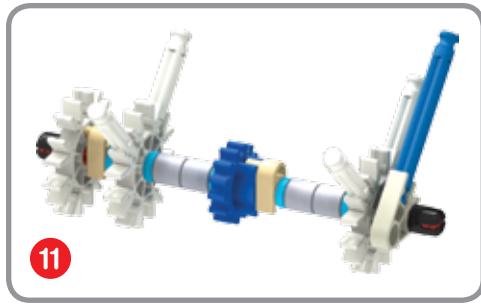
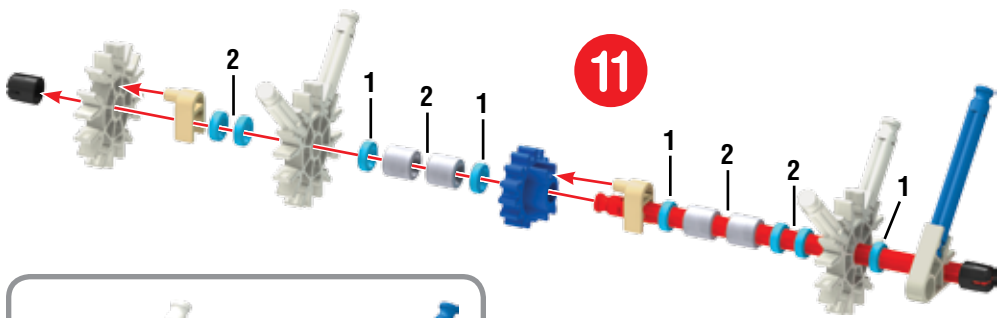

x4

13

16		8		8		16	
16							
8							
16		8		8			

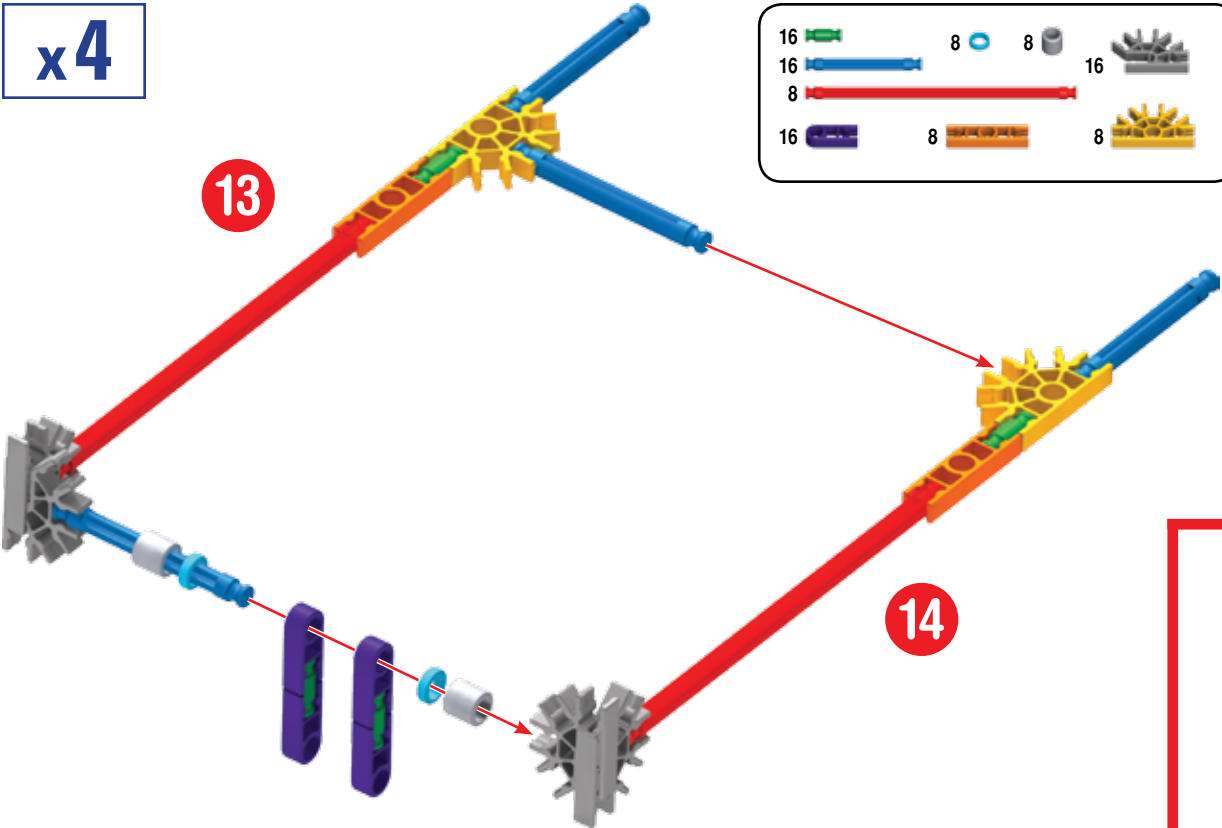

14

x4

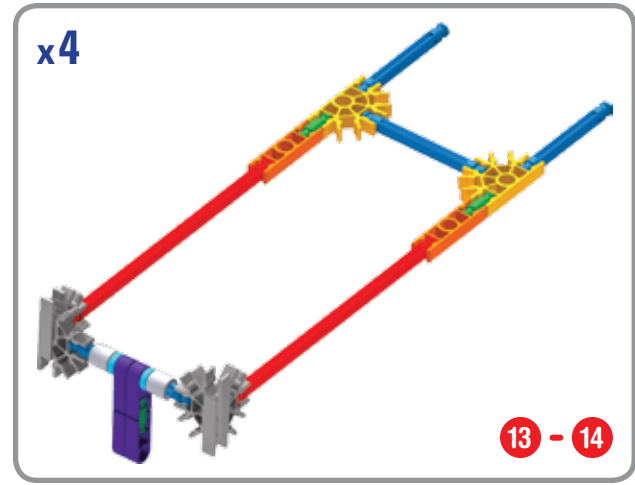

13 - 14

x4

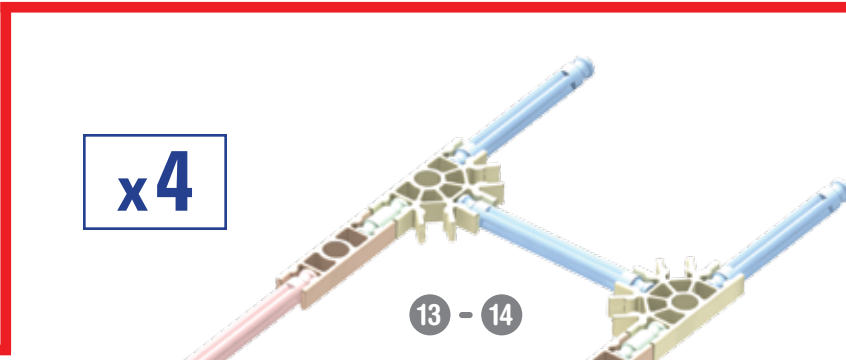

13 - 14

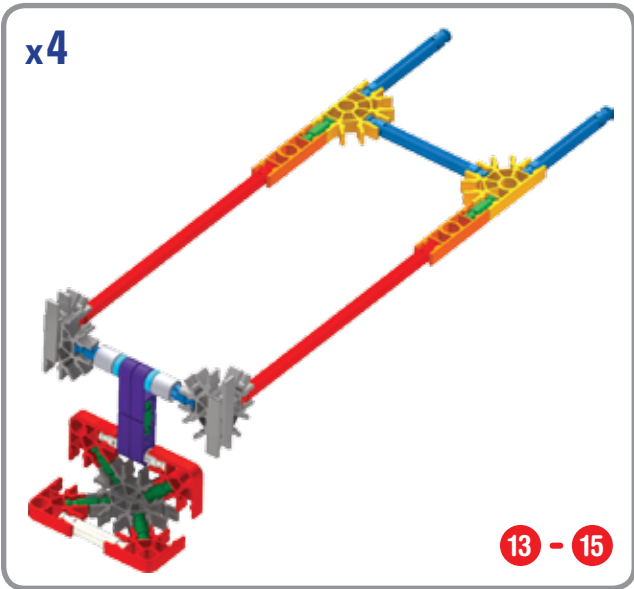

x4

13 - 15

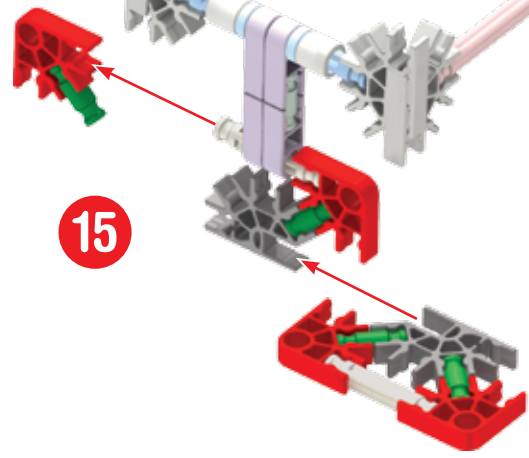

15

16		16		8	
8					

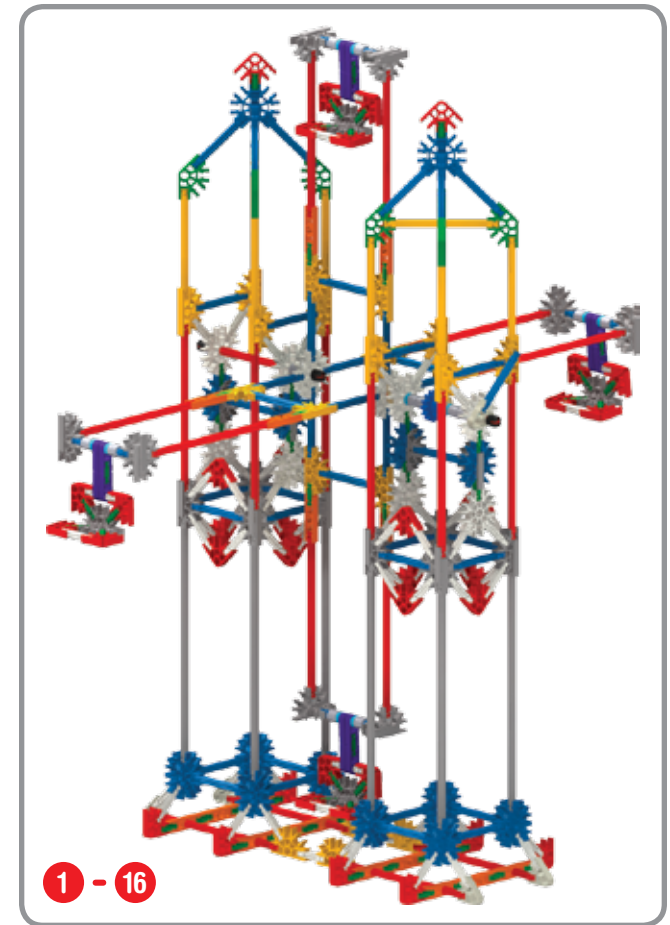
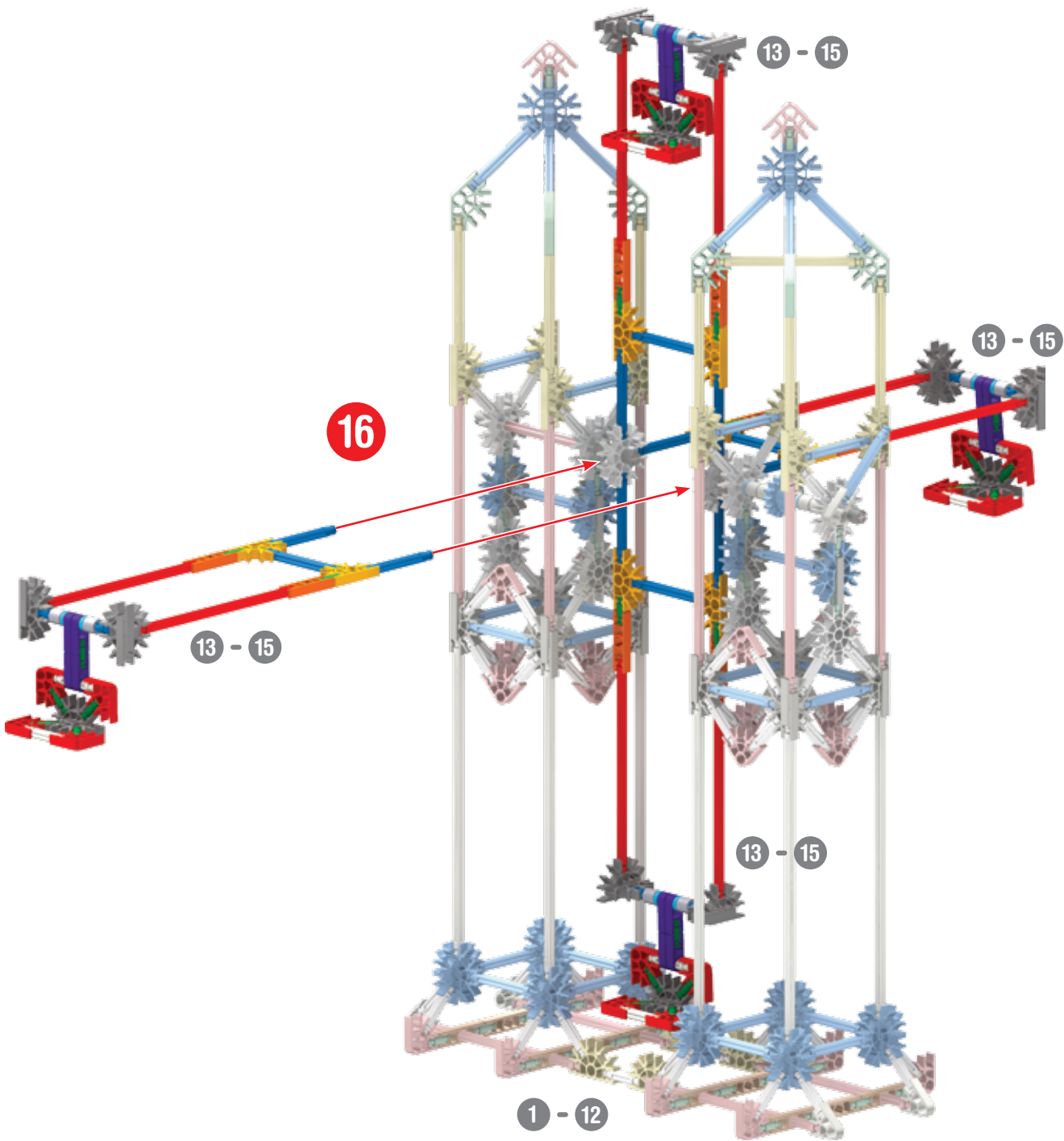

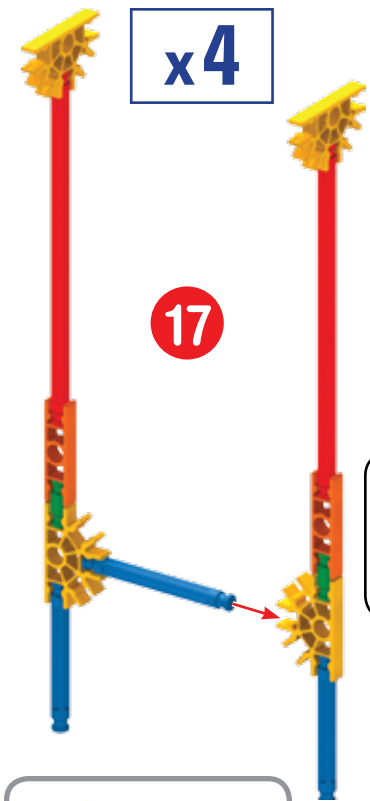

x4

17

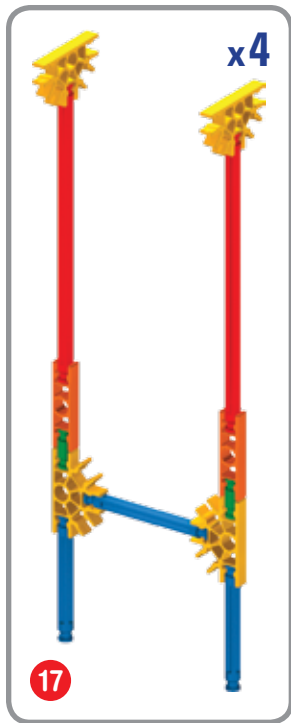
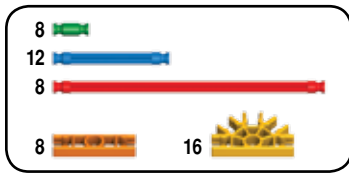

x4

17

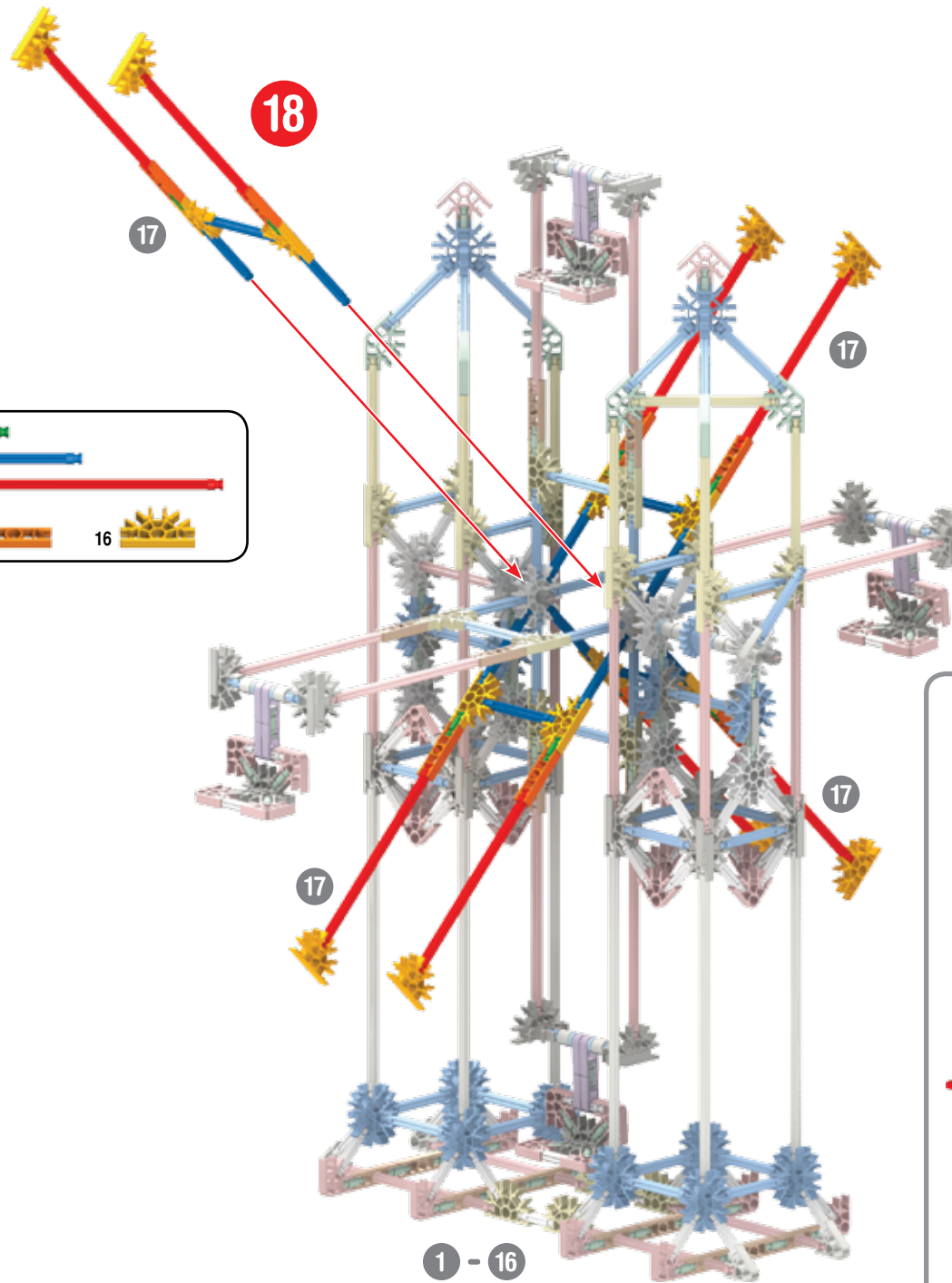

18

17

17

17

17

1 - 16

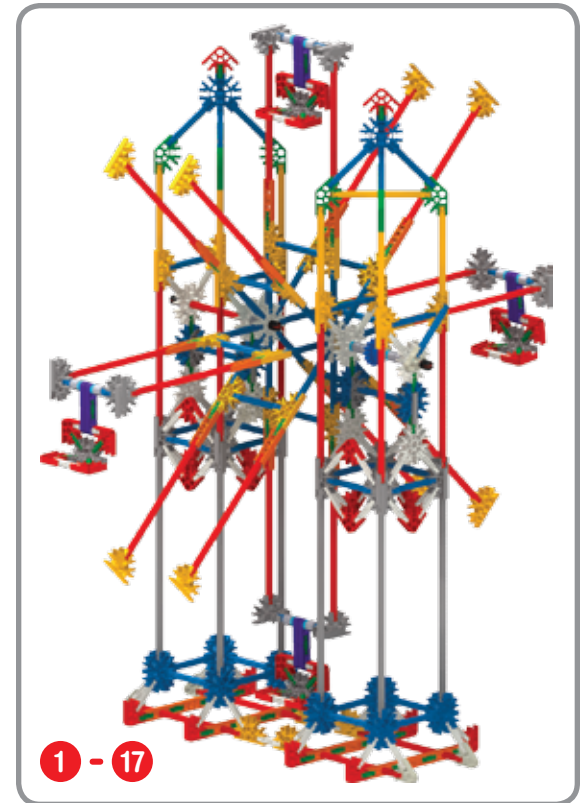

1 - 17

19

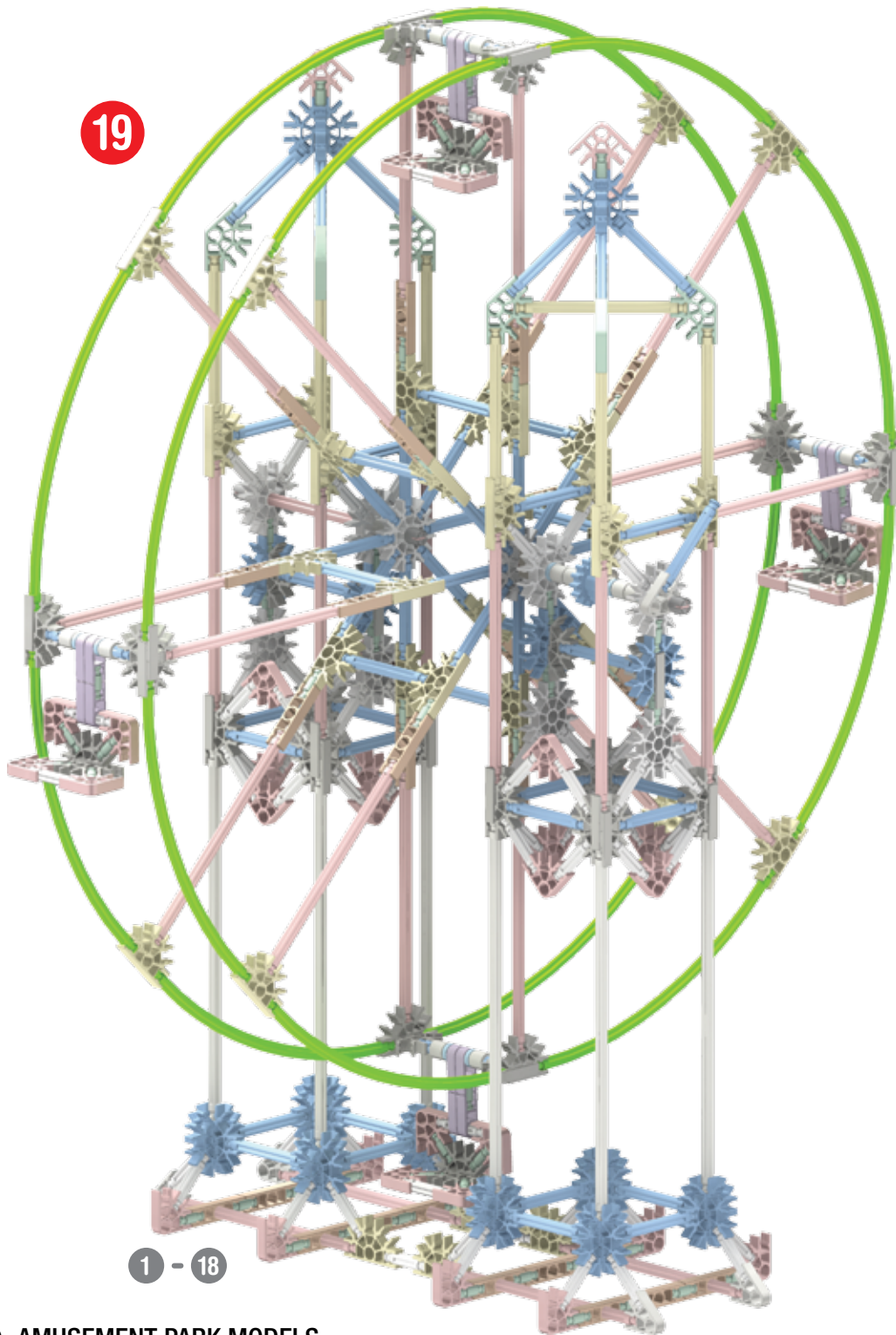

1 - 18



Large Ferris Wheel

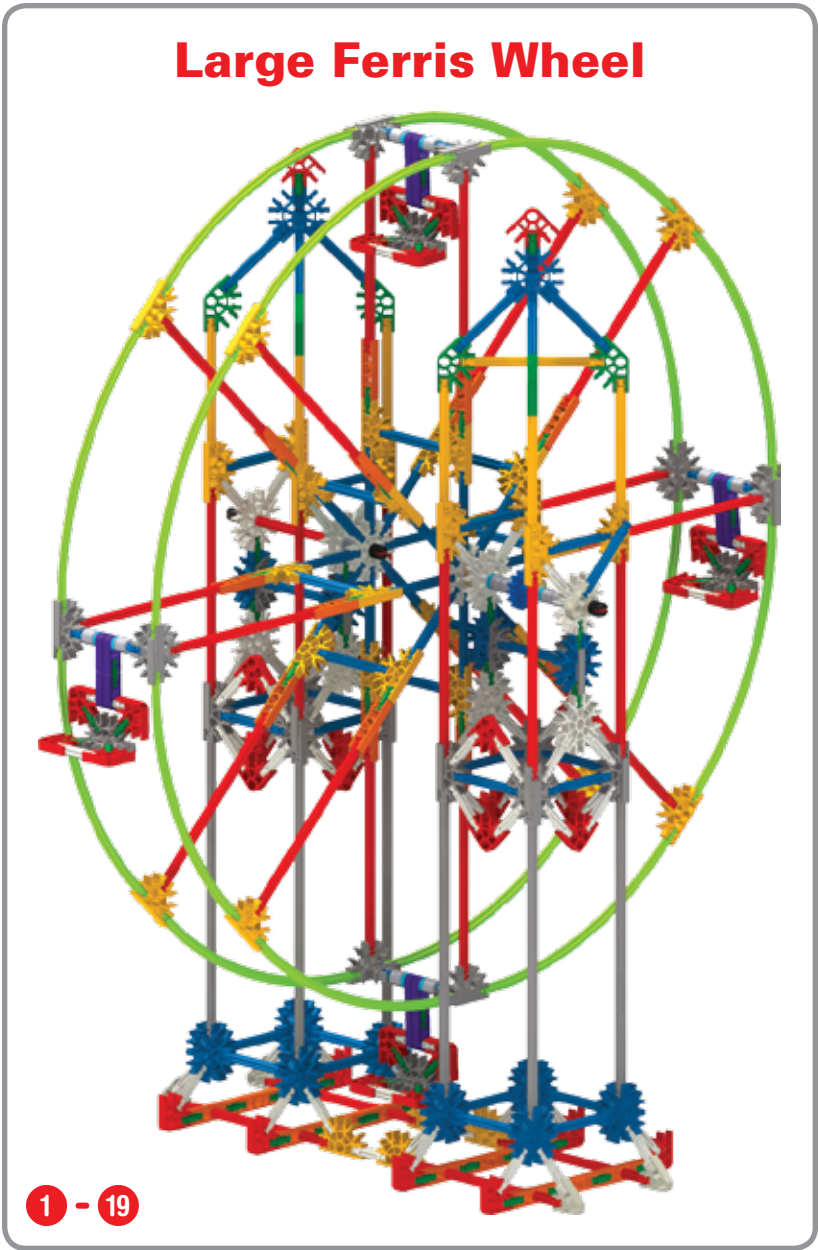

1 - 19

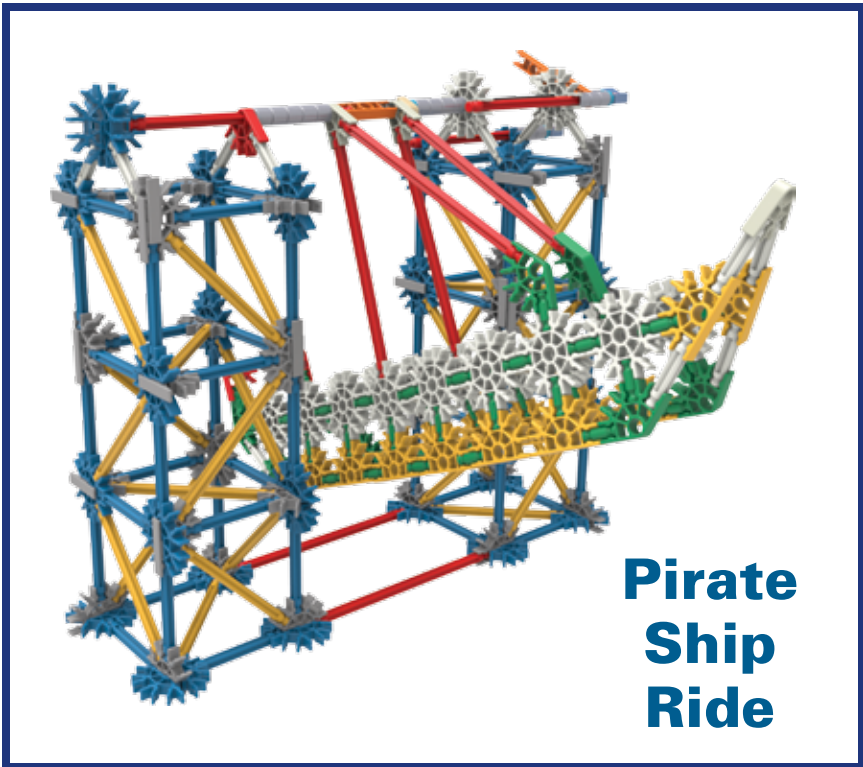

**Pirate
Ship
Ride**

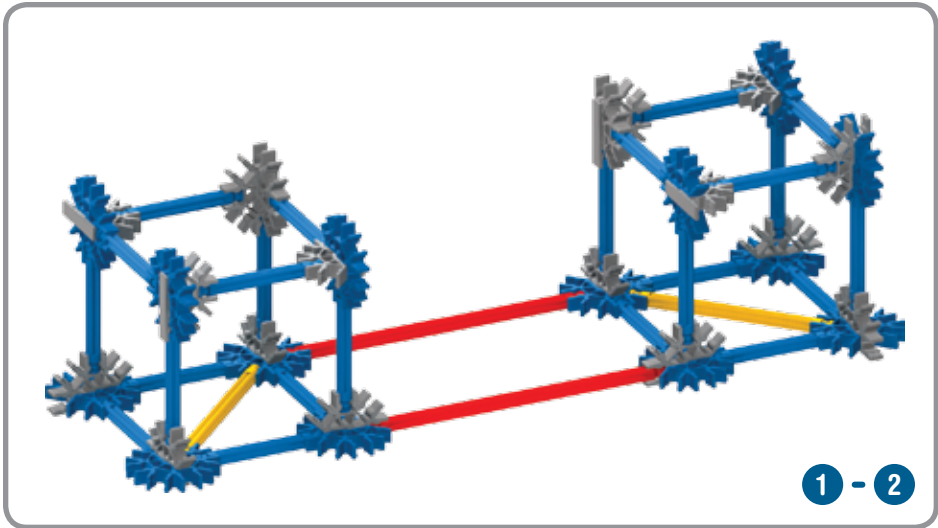

- | | |
|----|--|
| 24 | |
| 2 | |
| 2 | |
| 18 | |
| 14 | |

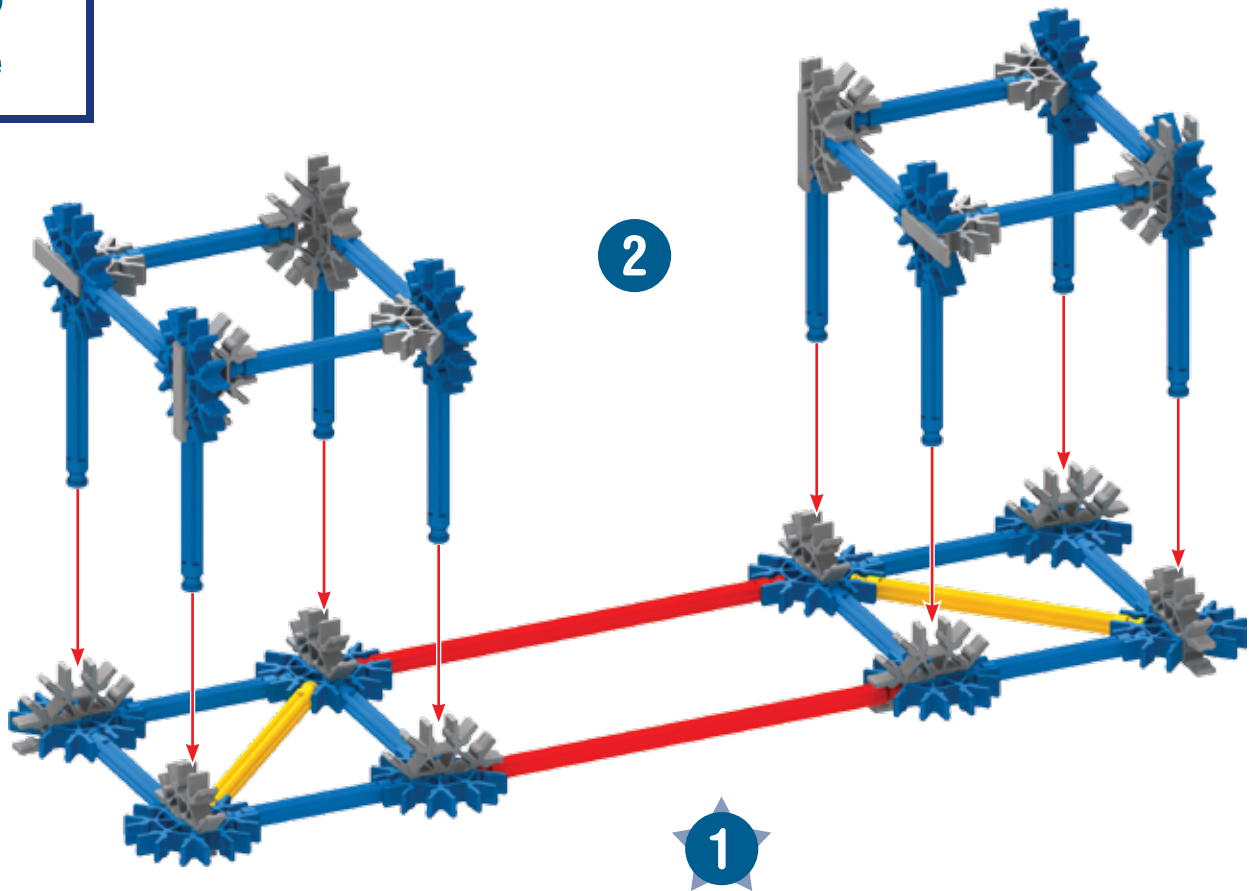

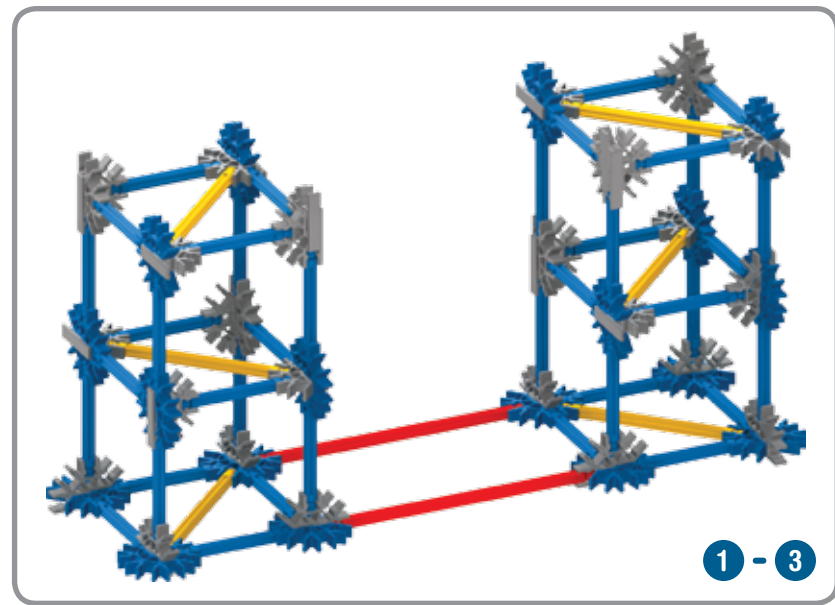
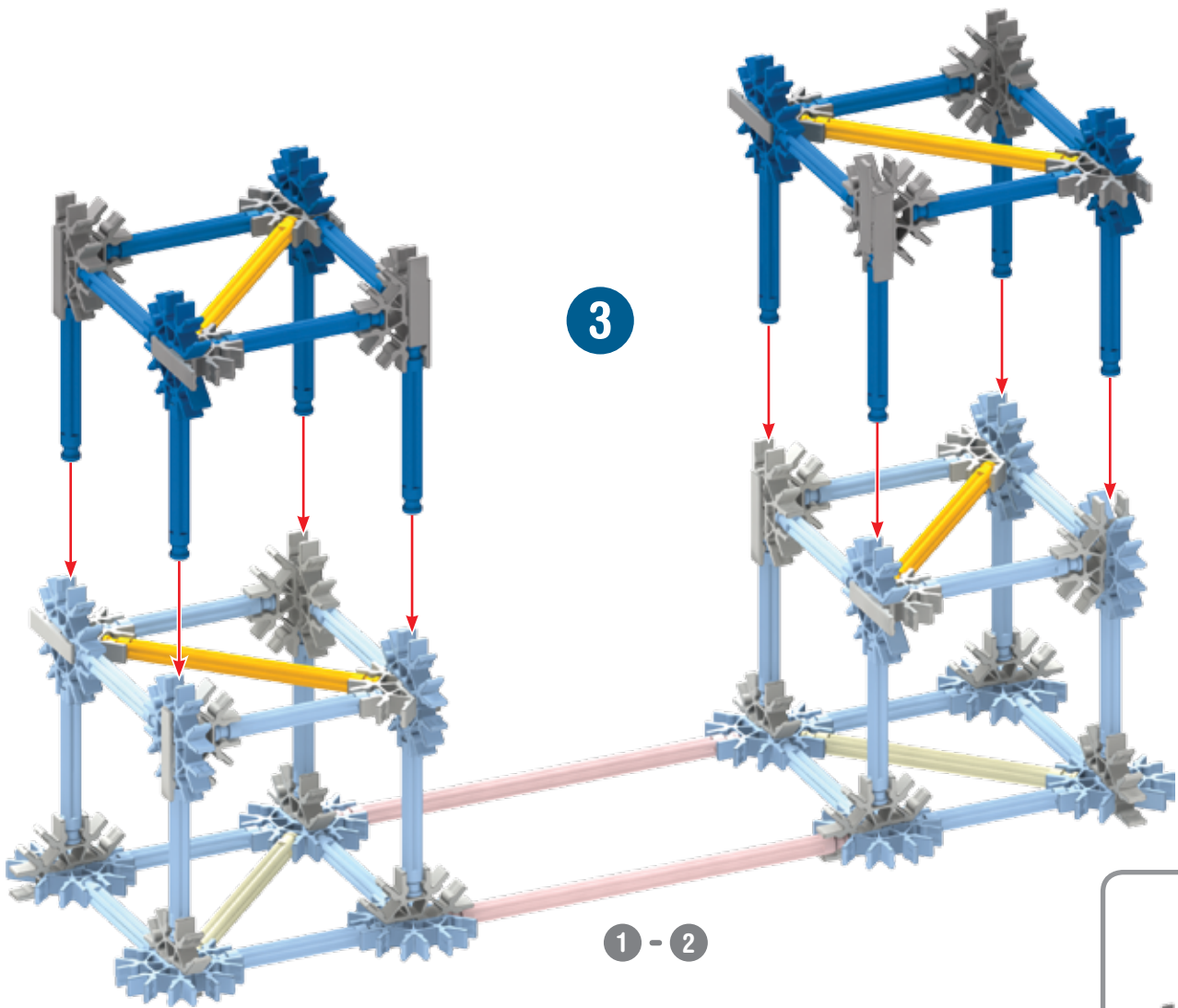

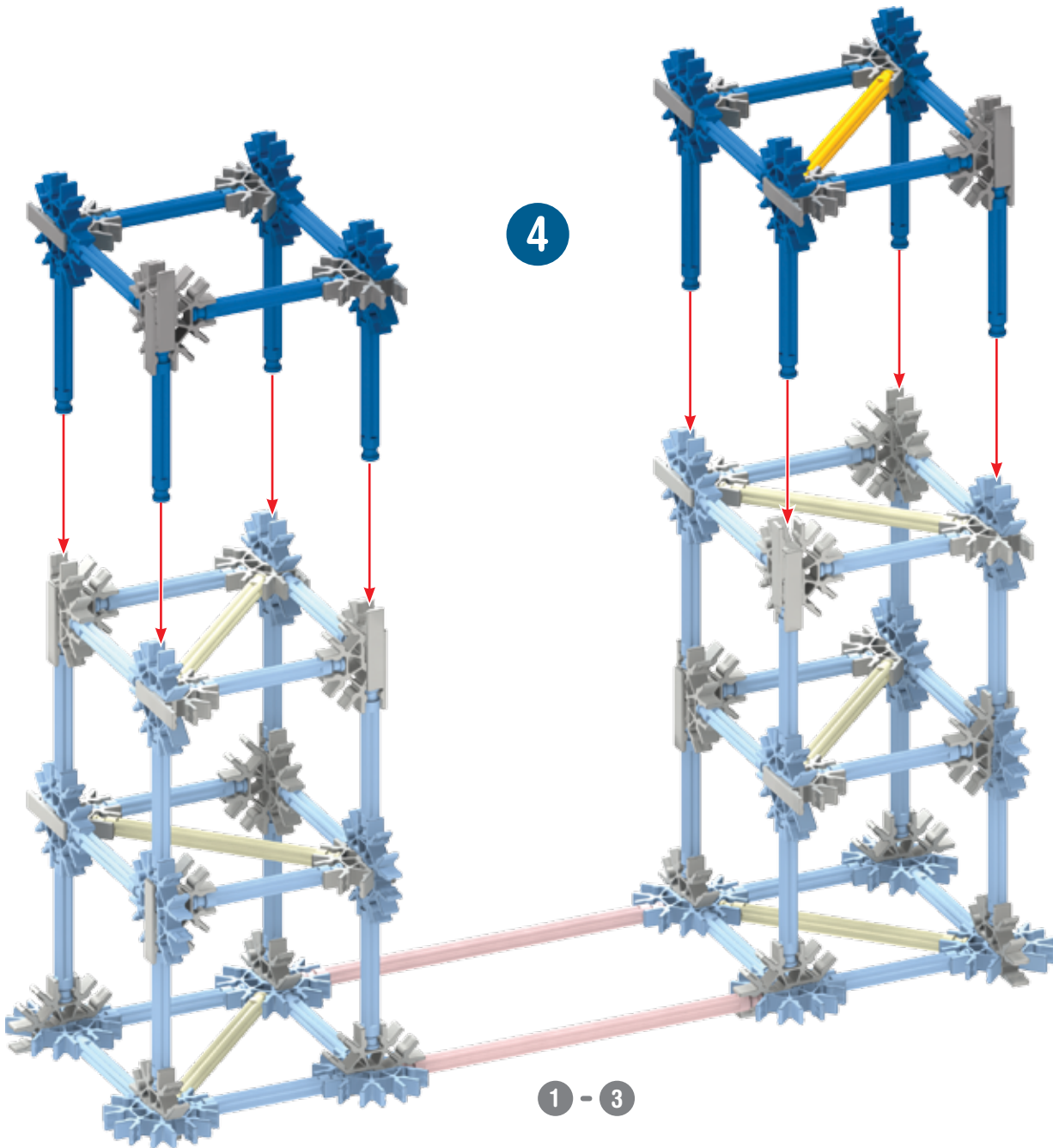

16	
1	
10	
6	

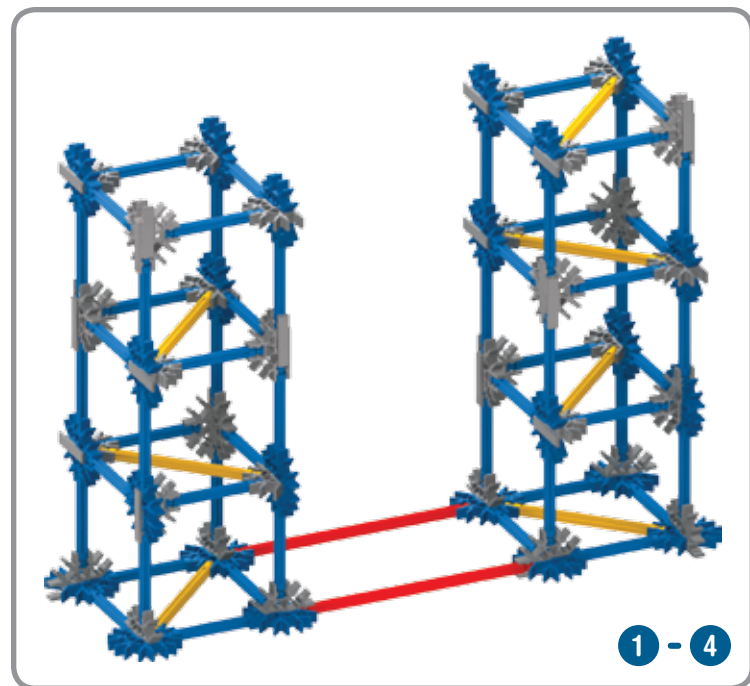

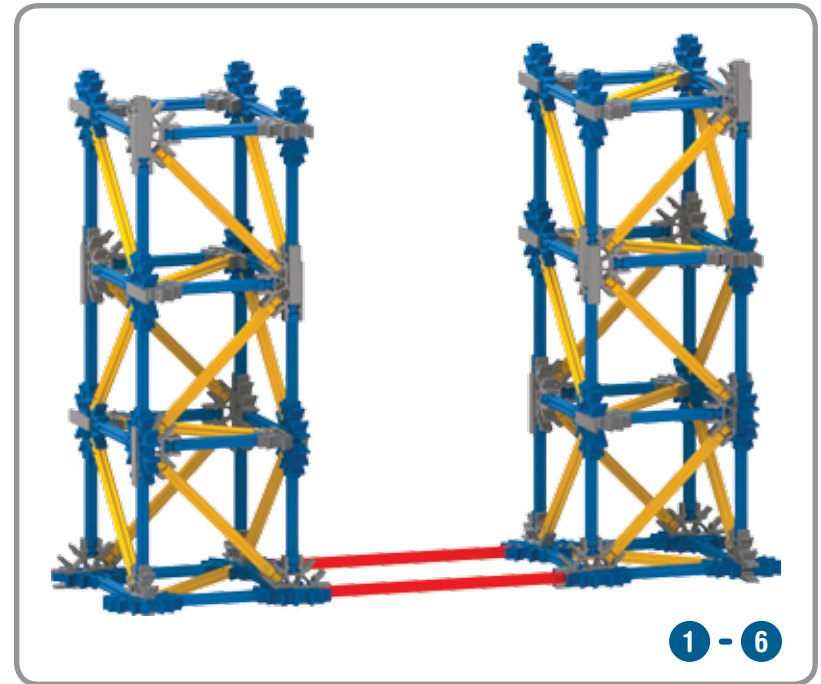
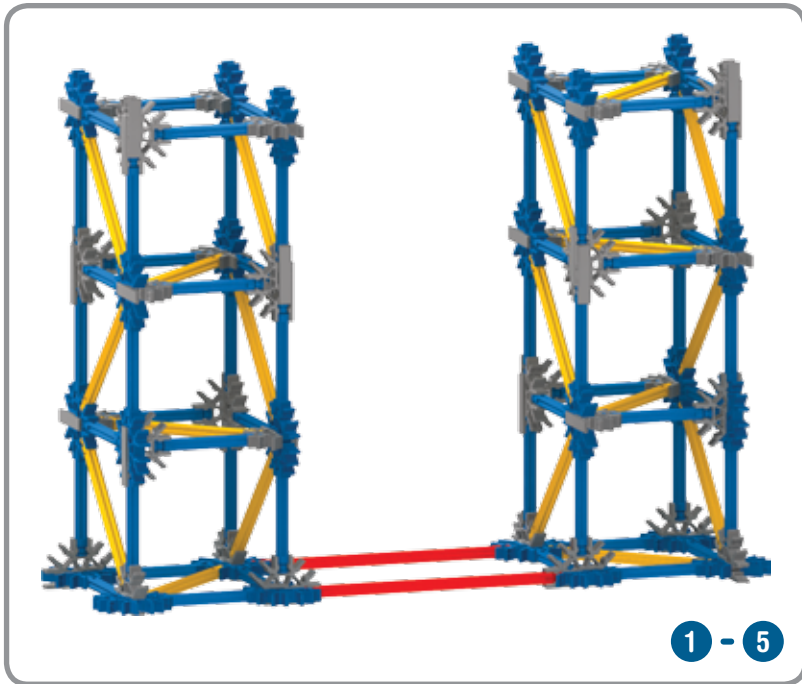
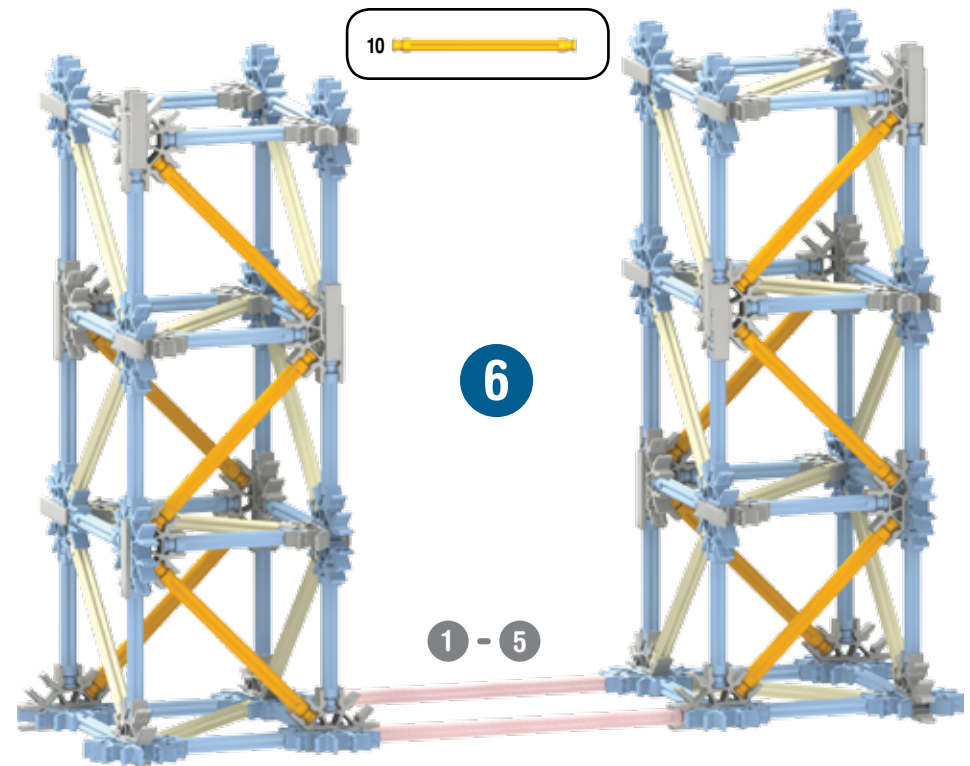
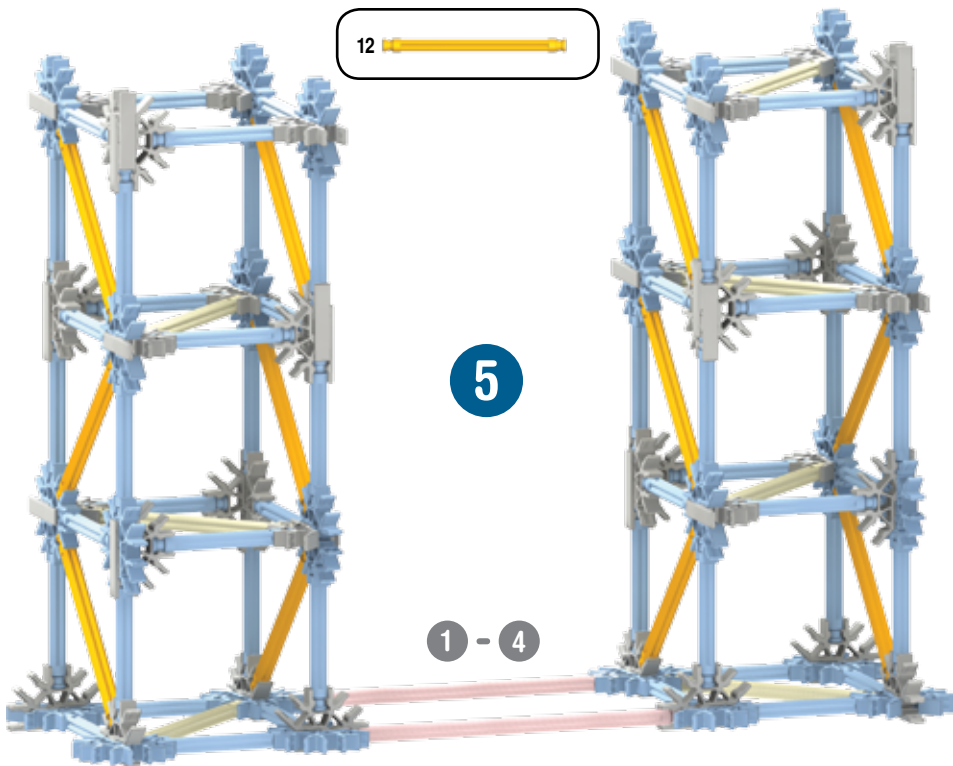

x2

7

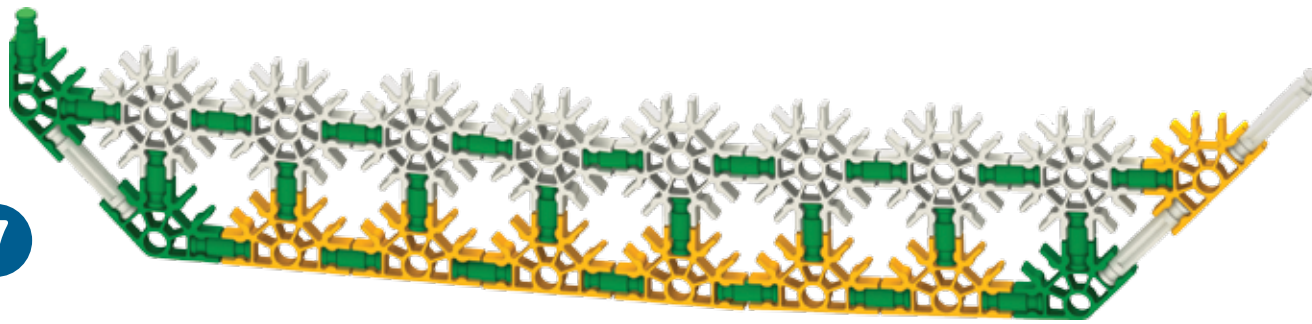

50		14	
6			
6		16	

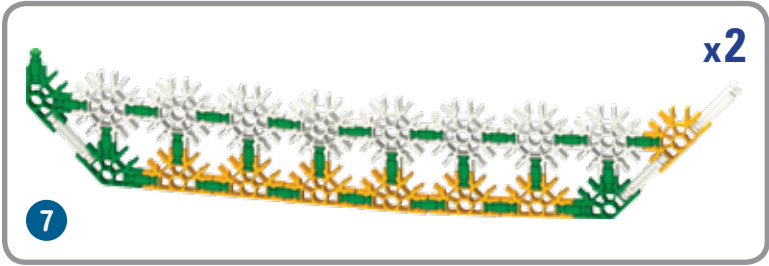

x2

7

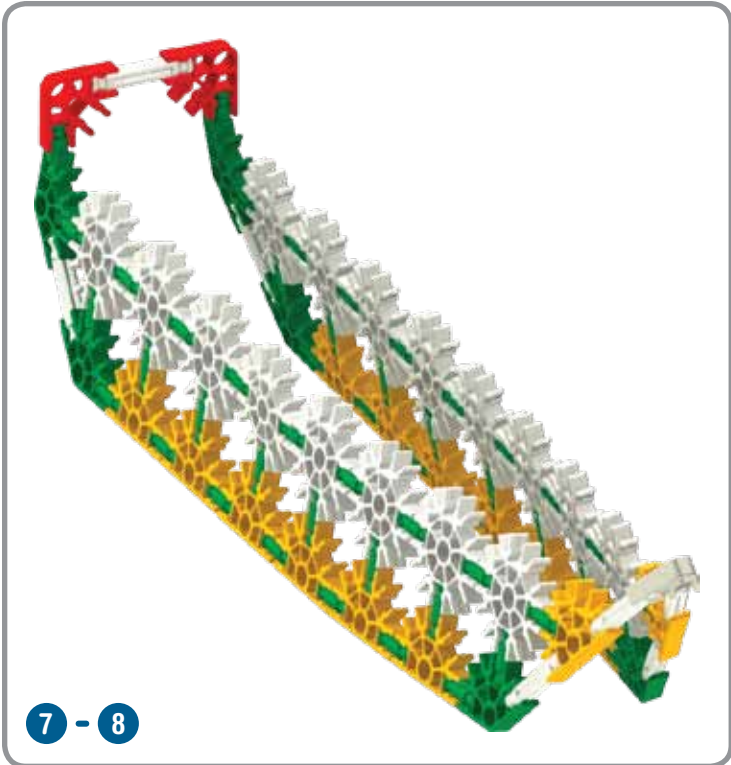

7 - 8

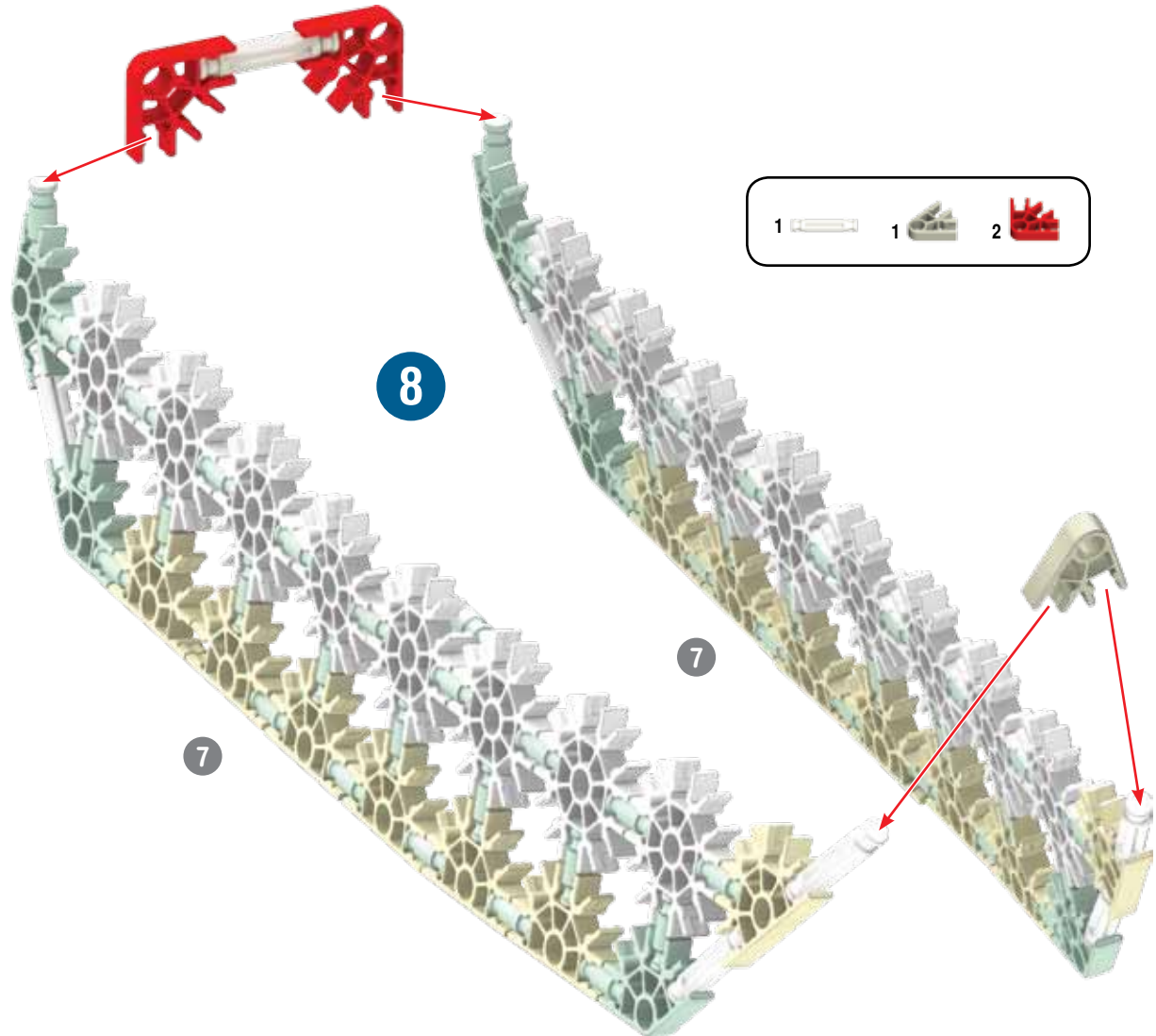

8

7

7



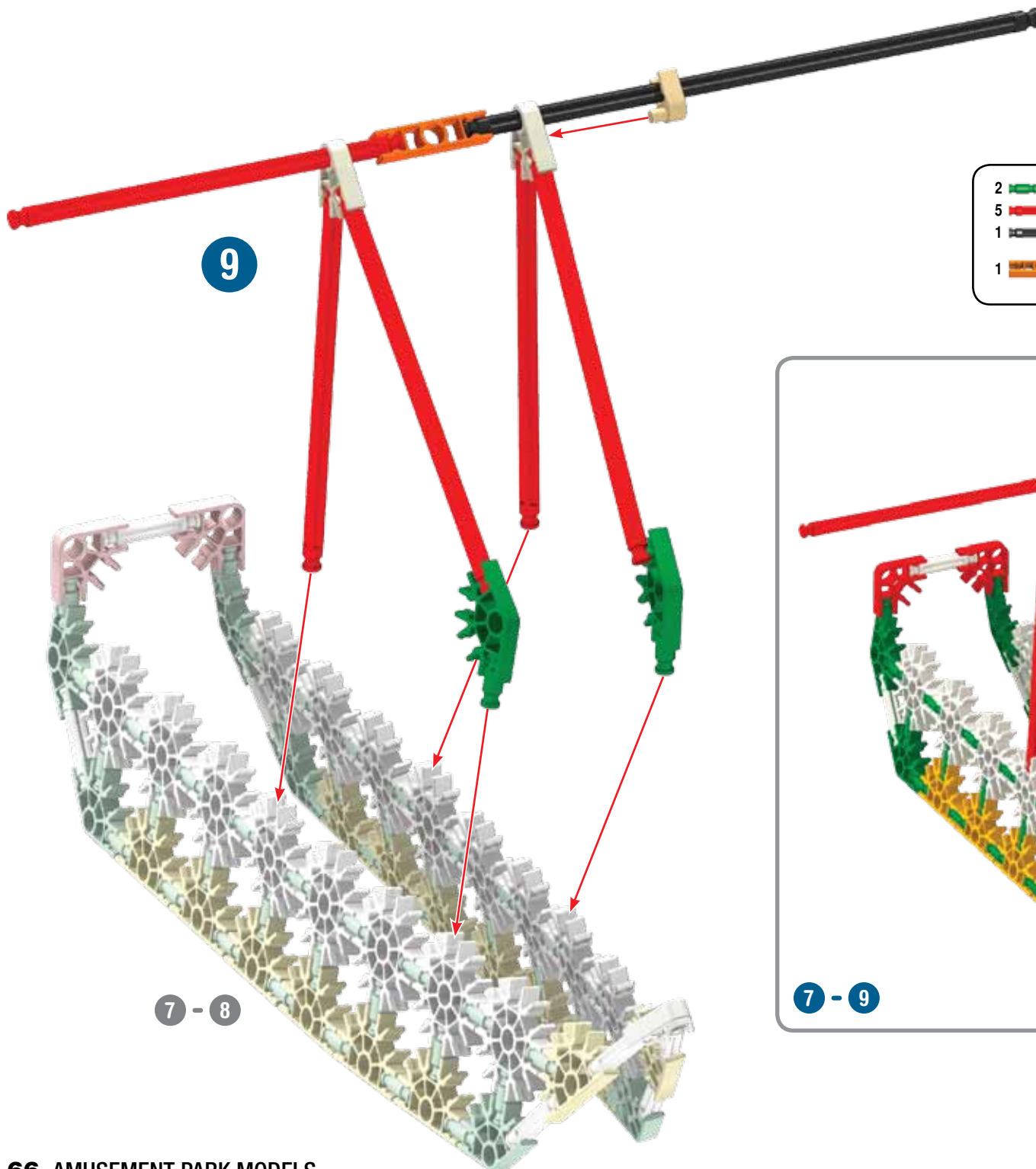





1		1		2	
---	--	---	--	---	--



- | | | | |
|---|--|---|--|
| 2 | | | |
| 5 | | 1 | |
| 1 | | | |
| 1 | | 2 | |
| | | 2 | |

7 - 8



2		11		1		3	
9				2		2	
1							

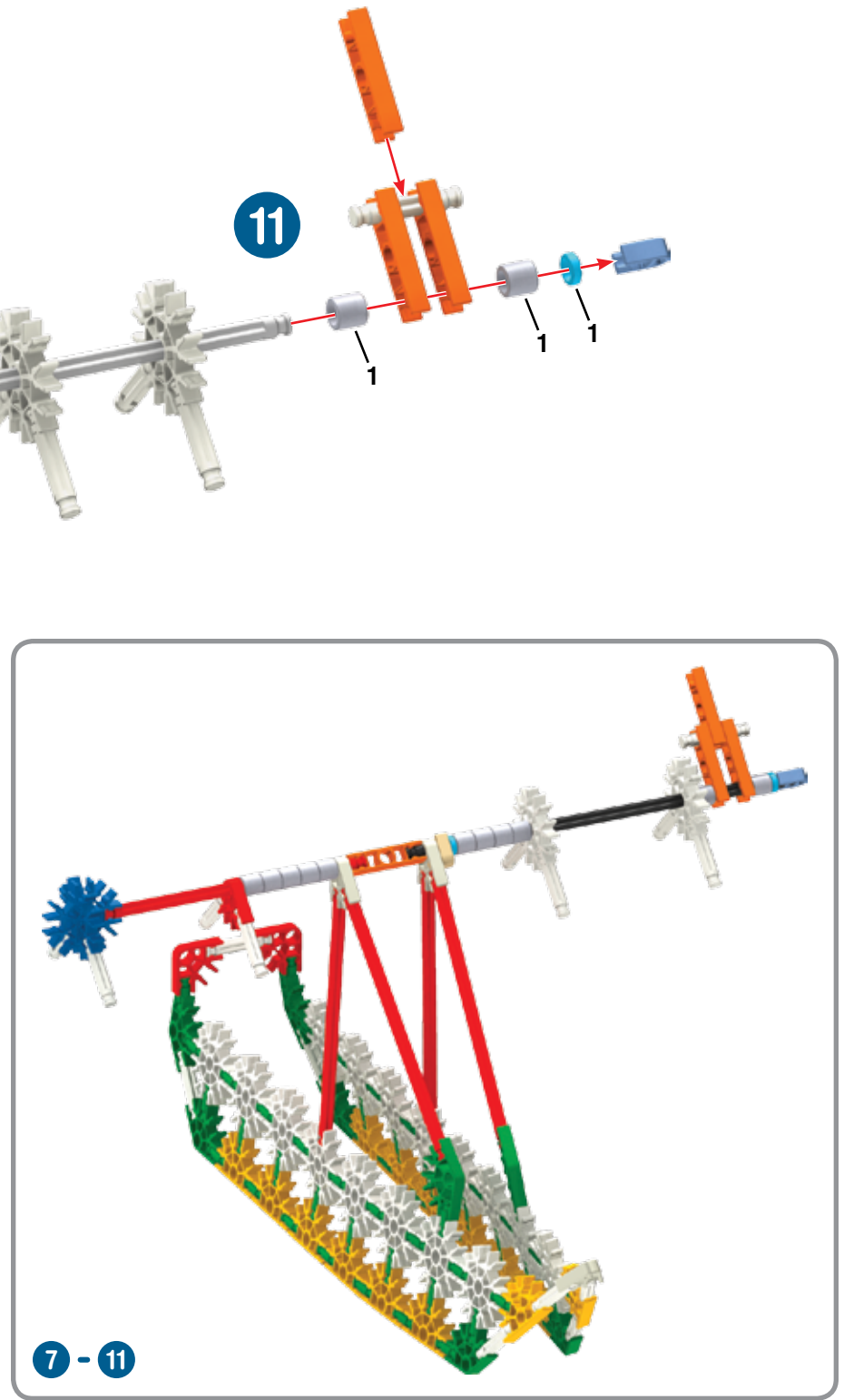
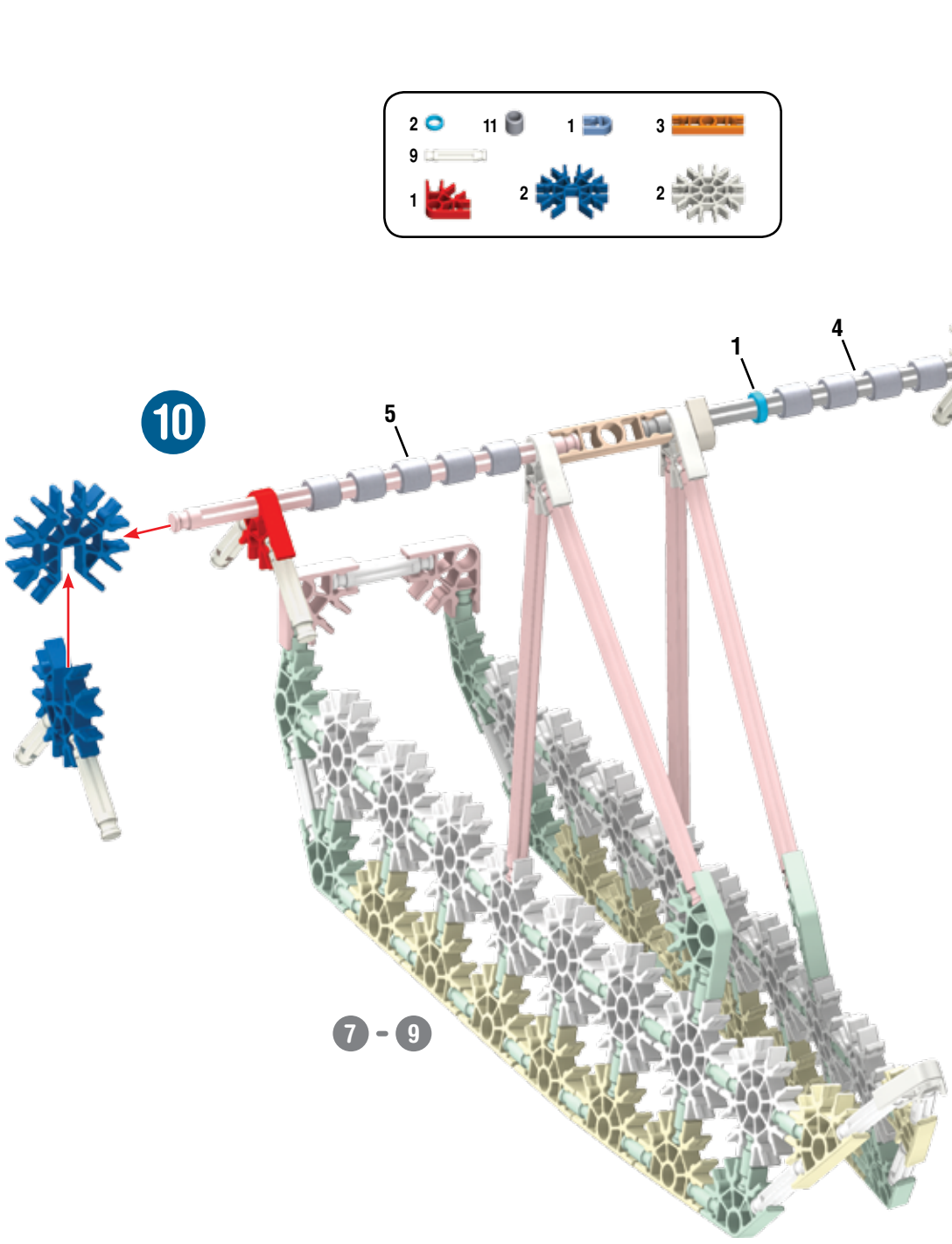

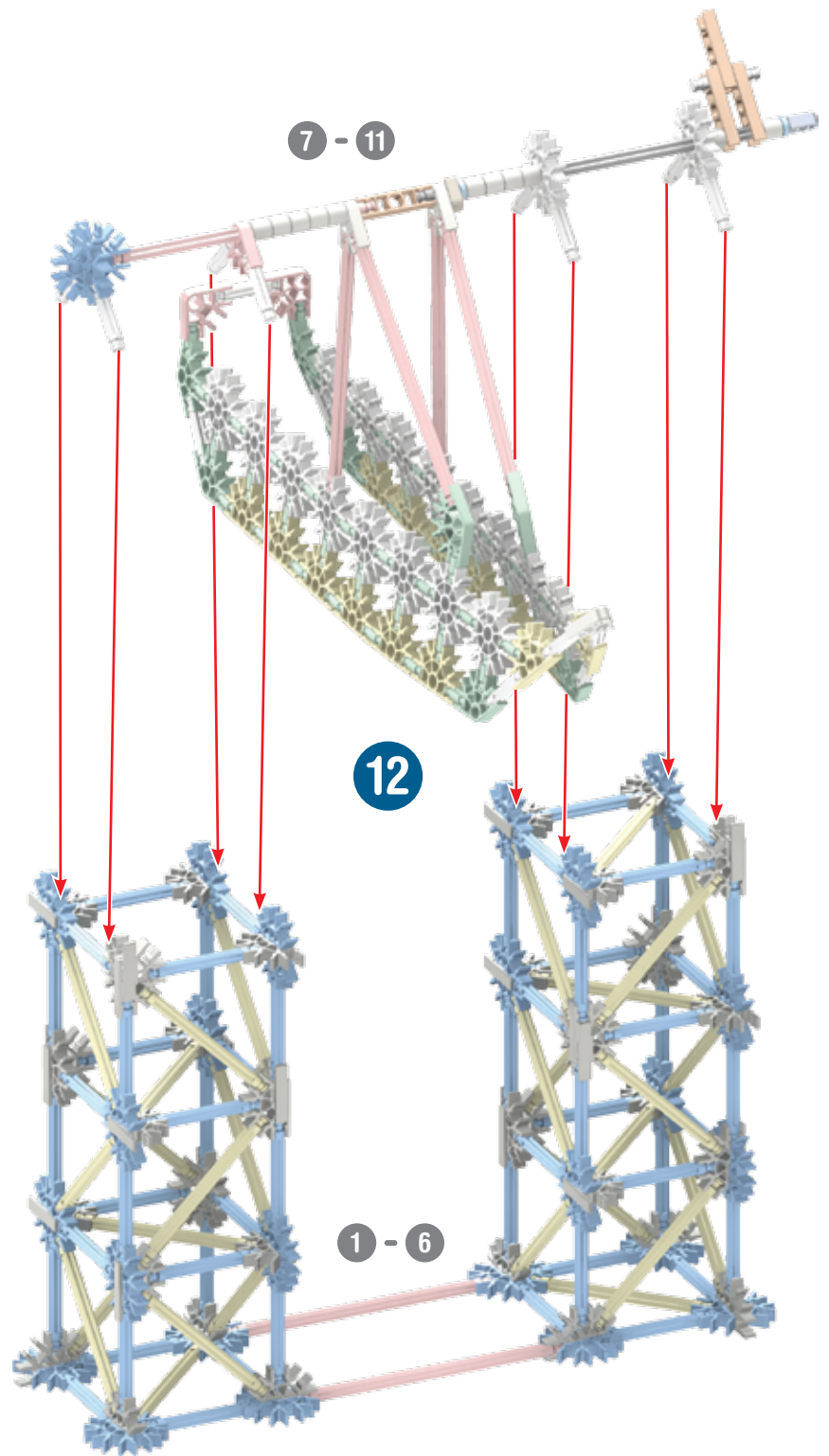
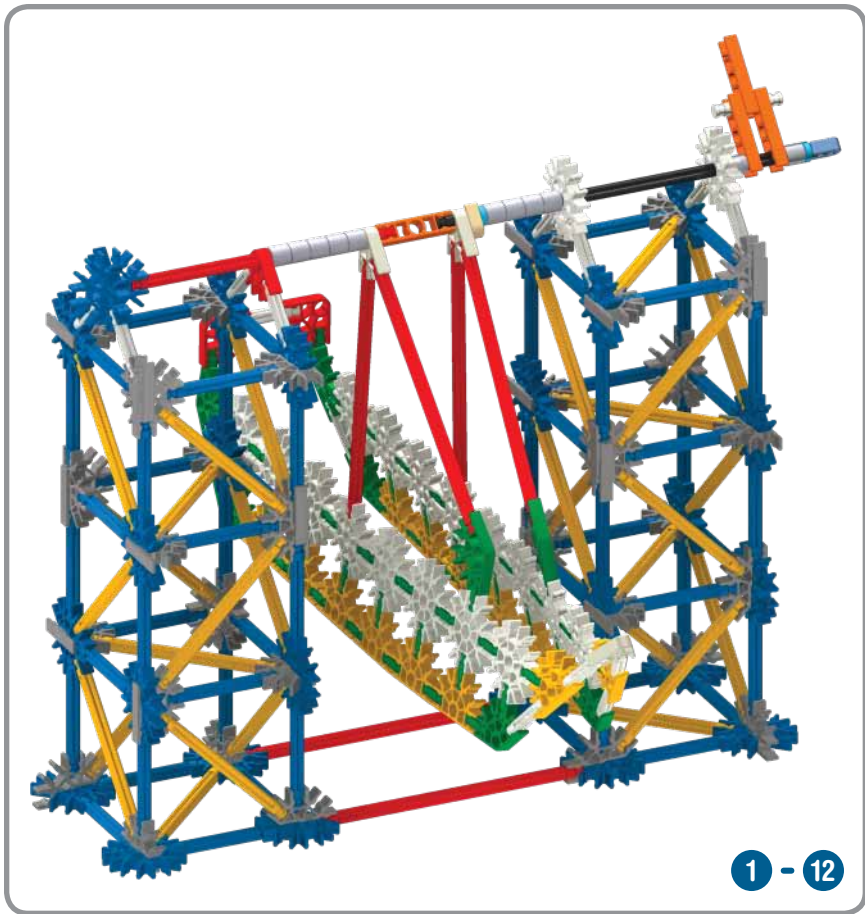

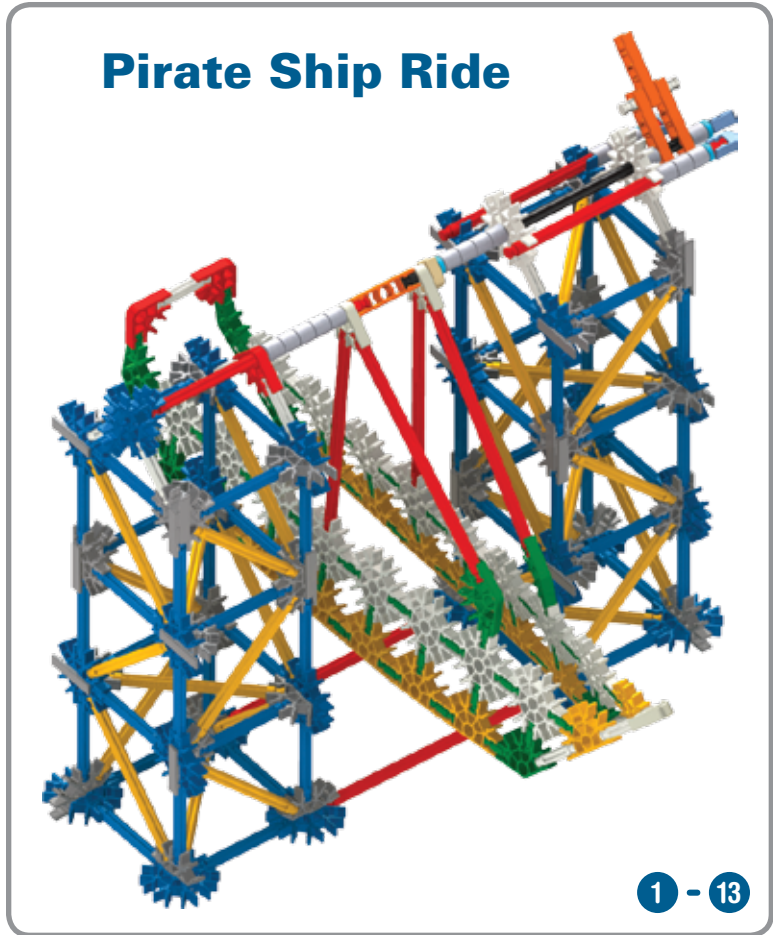
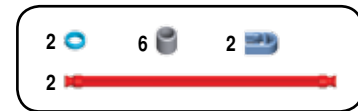
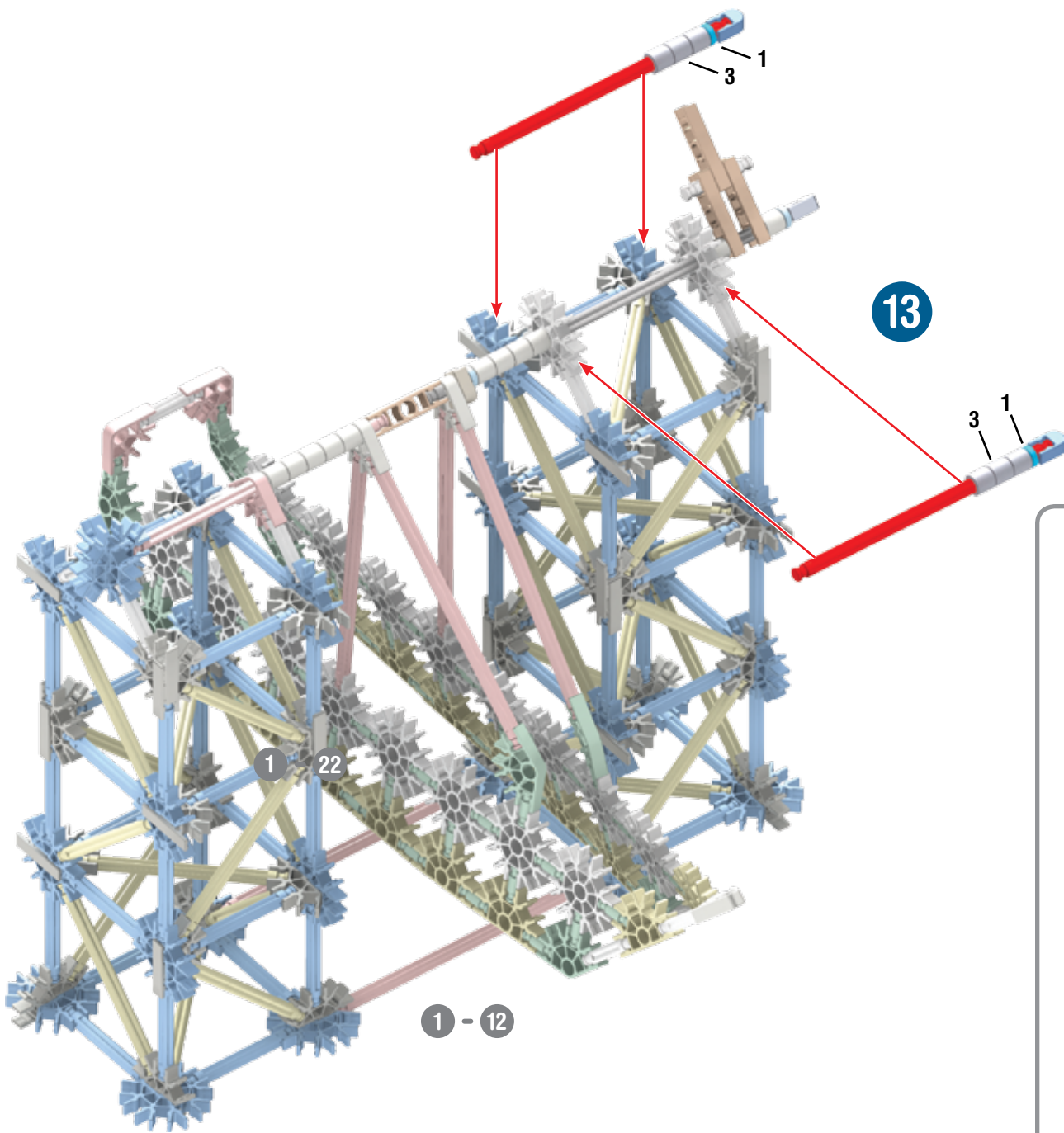

Scrambler



- | | | | | | | | |
|----|--|---|--|---|--|----|--|
| 2 | | 8 | | 4 | | 12 | |
| 4 | | | | | | | |
| 12 | | | | | | | |
| 2 | | | | | | | |
| 4 | | 8 | | 2 | | | |

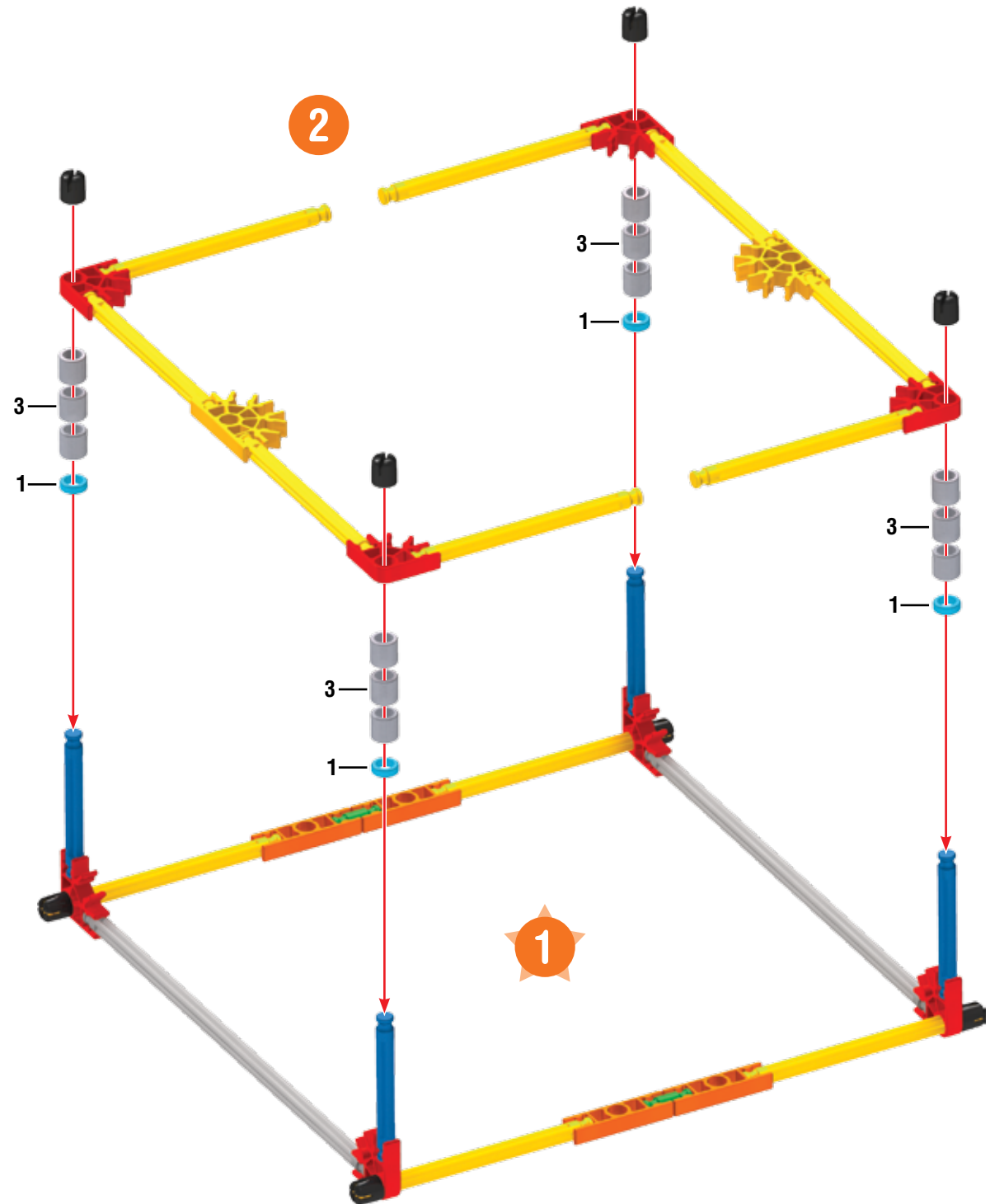
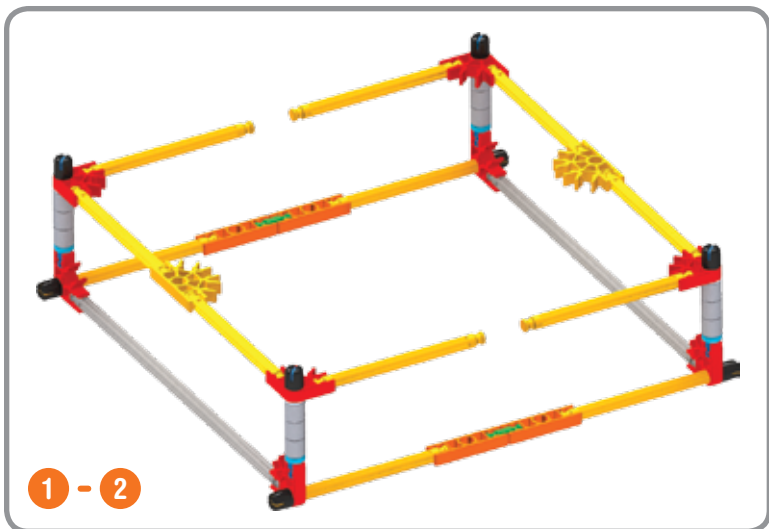

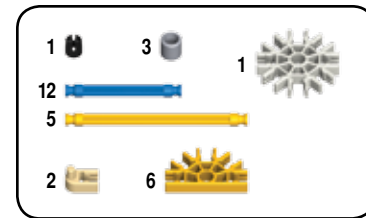
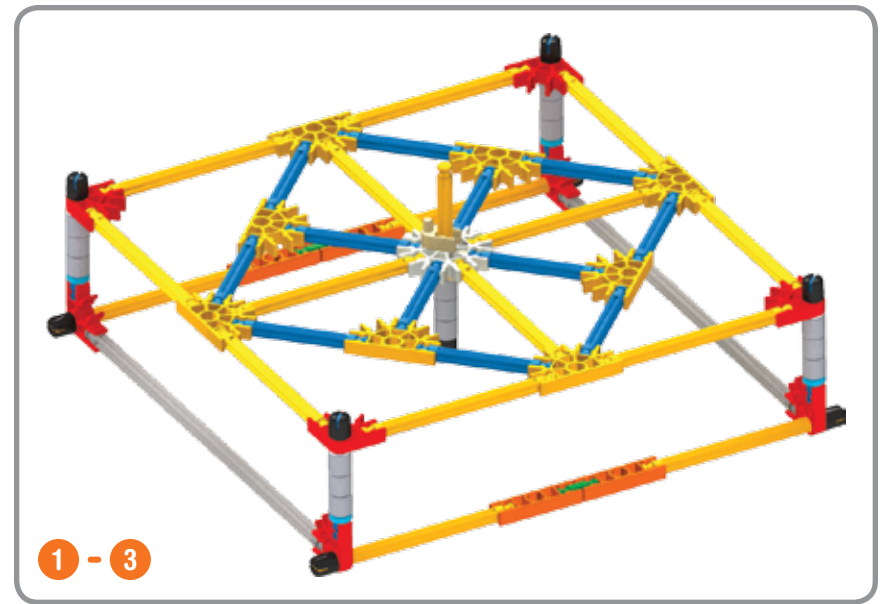
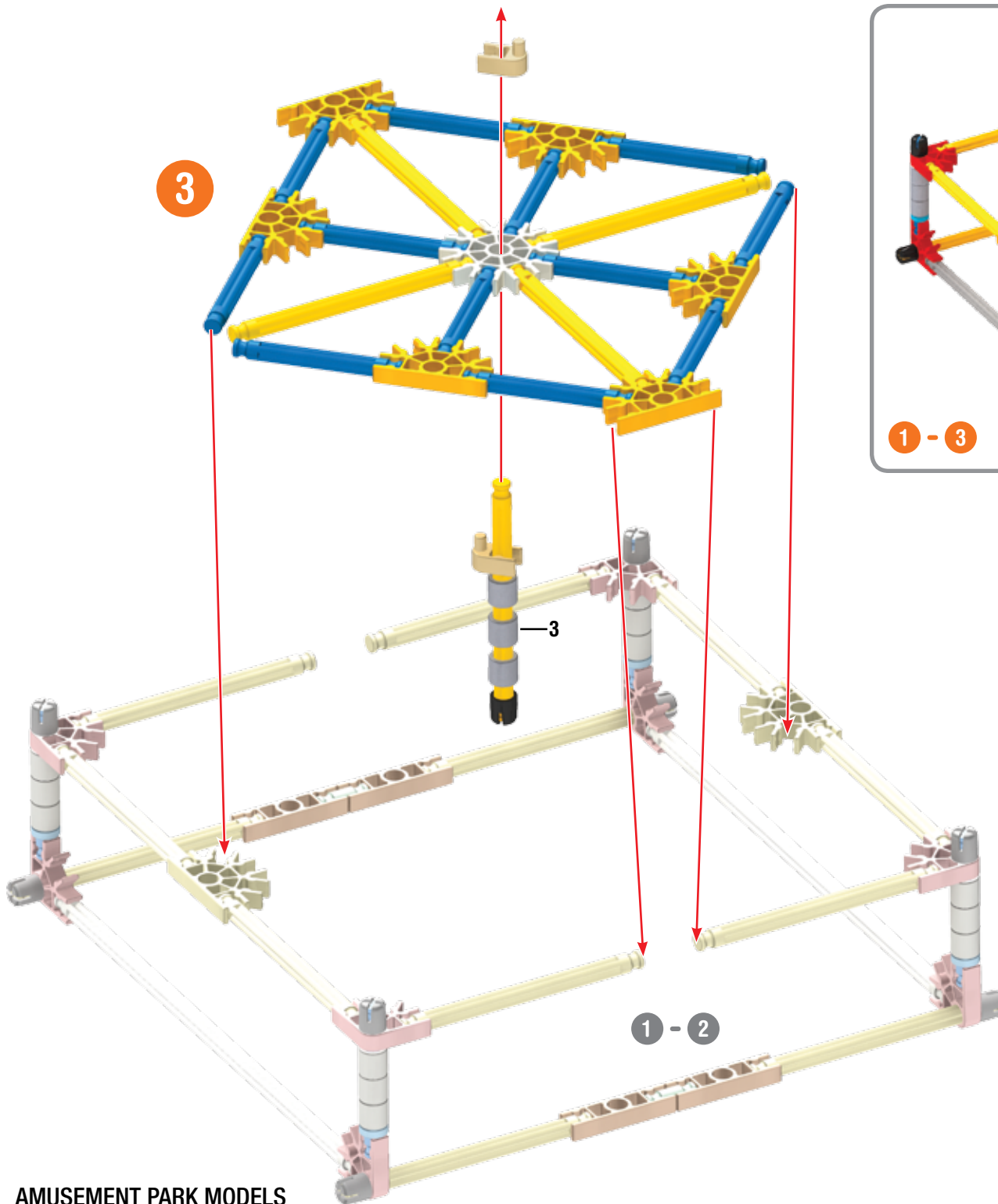

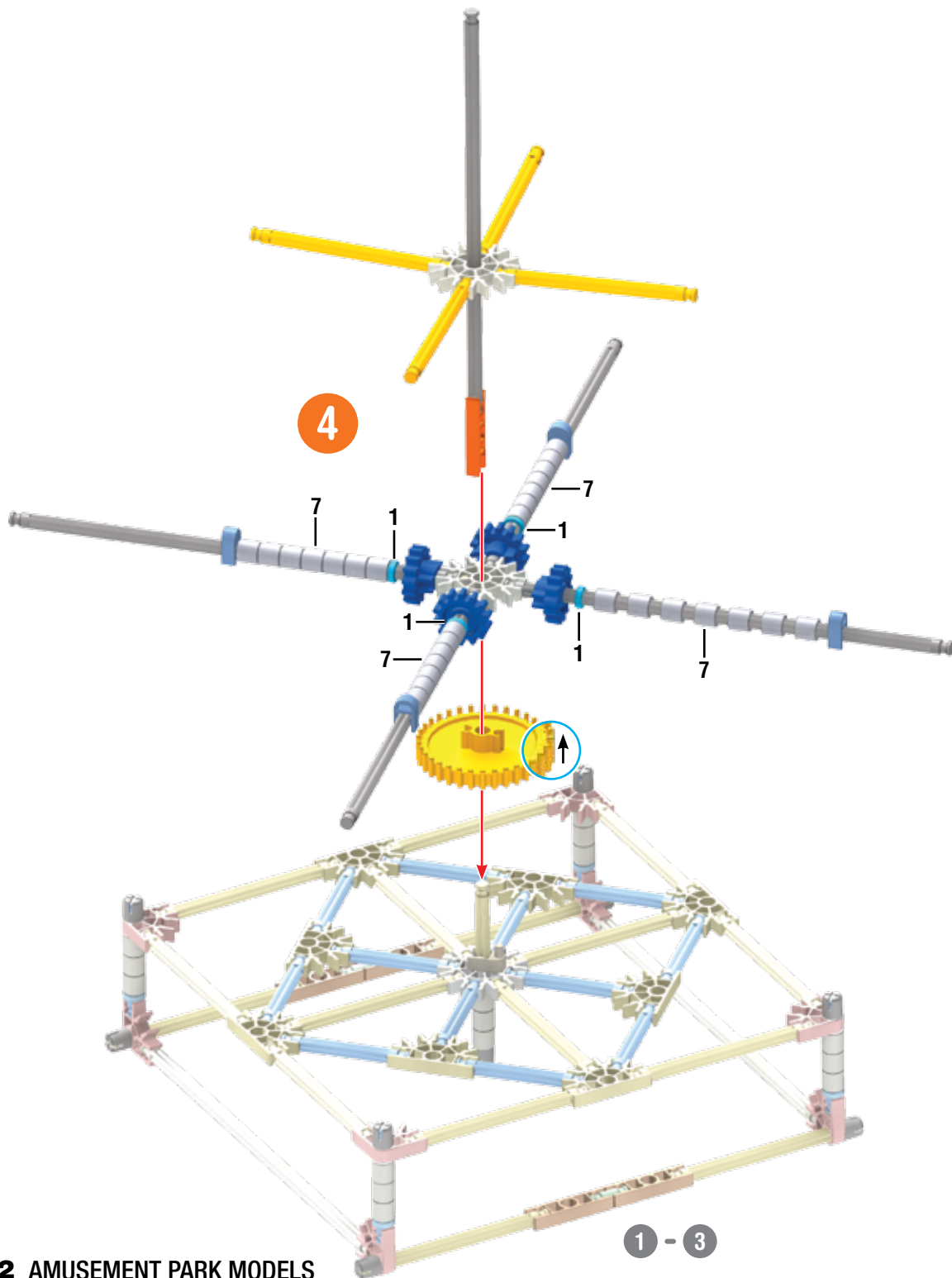

4

7

1

7

1

1

7

1 - 3

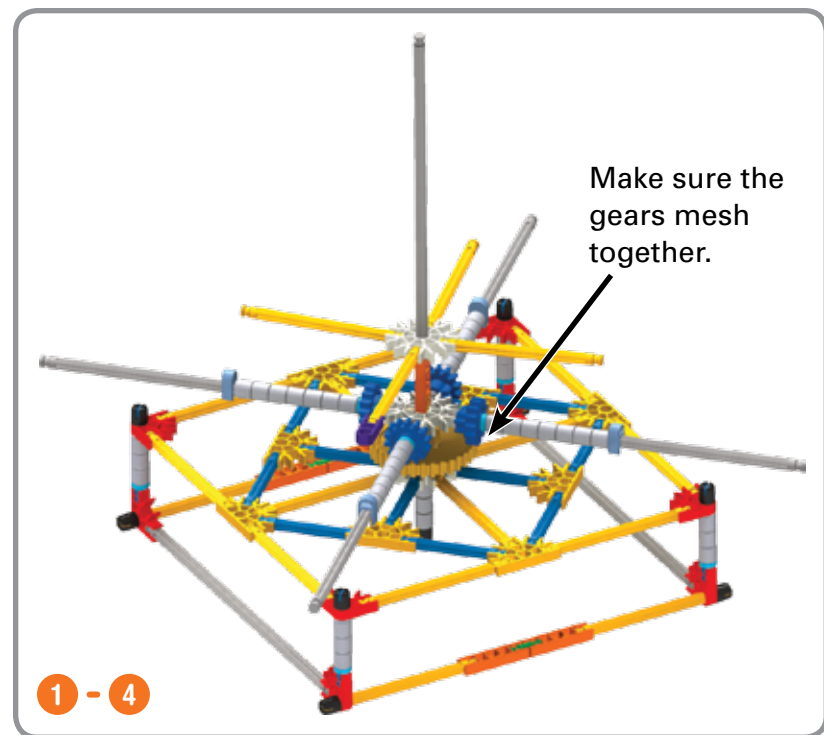

Make sure the gears mesh together.

1 - 4

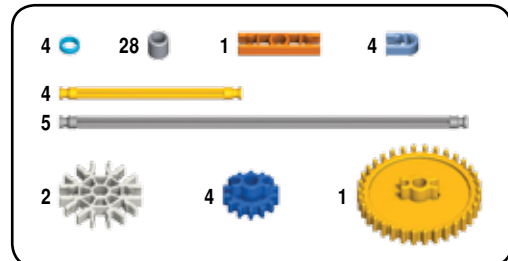

4 28 1 4

4

5

2

4

1

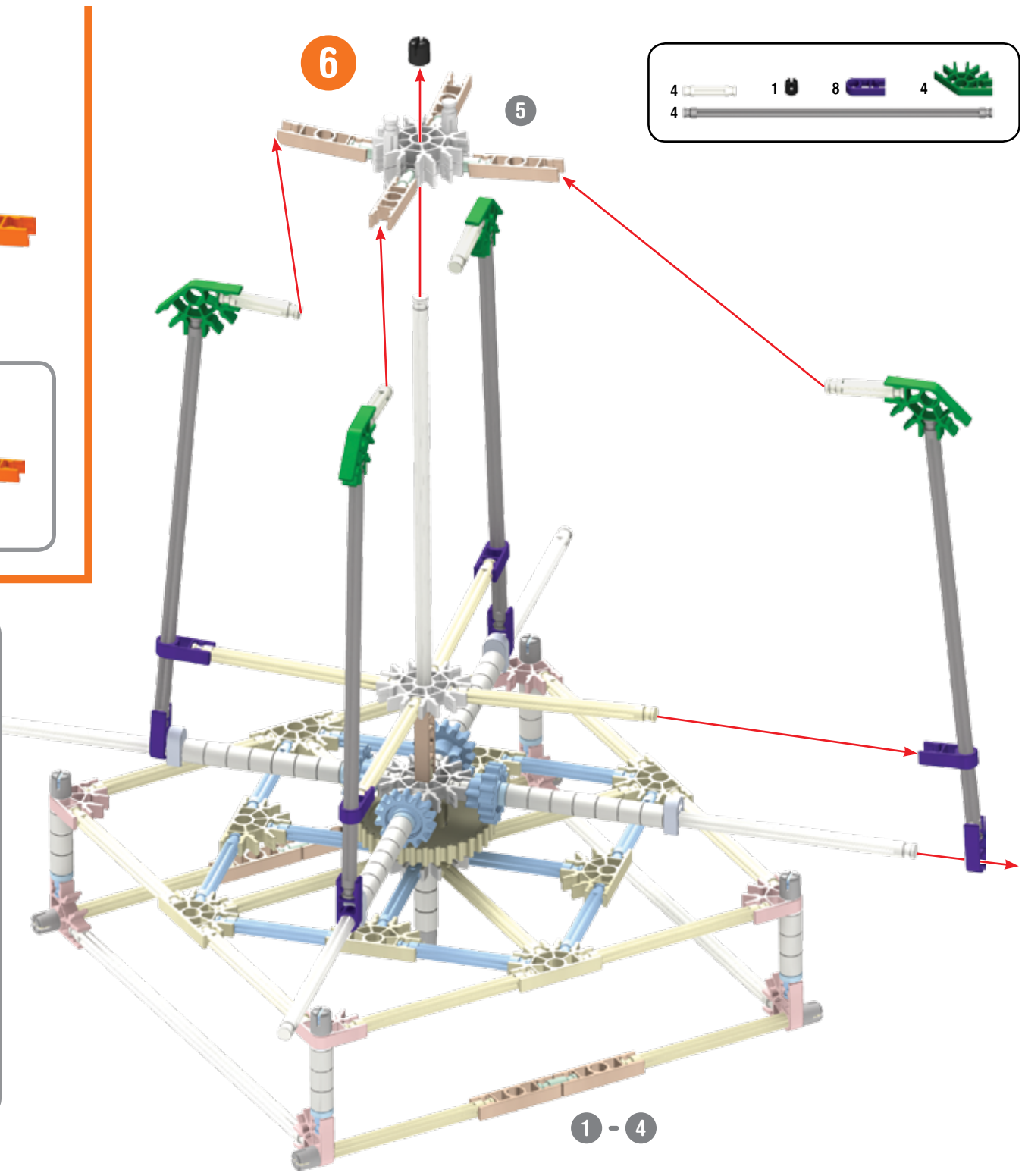
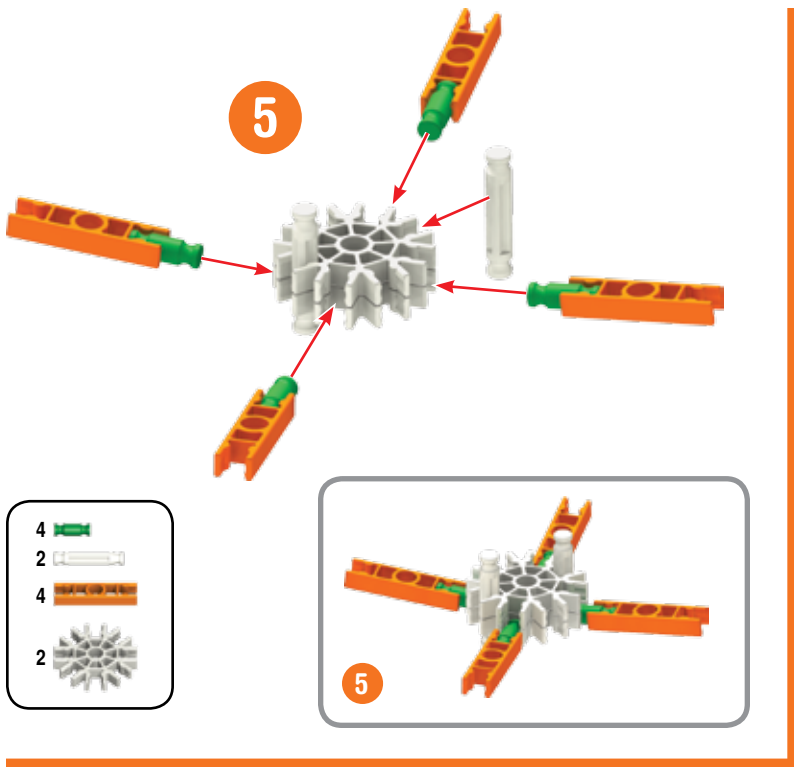

















x4

8

7

2



20		4		4	
20		8		8	
16		8		8	
8		4		8	
12		8		8	
8		8			

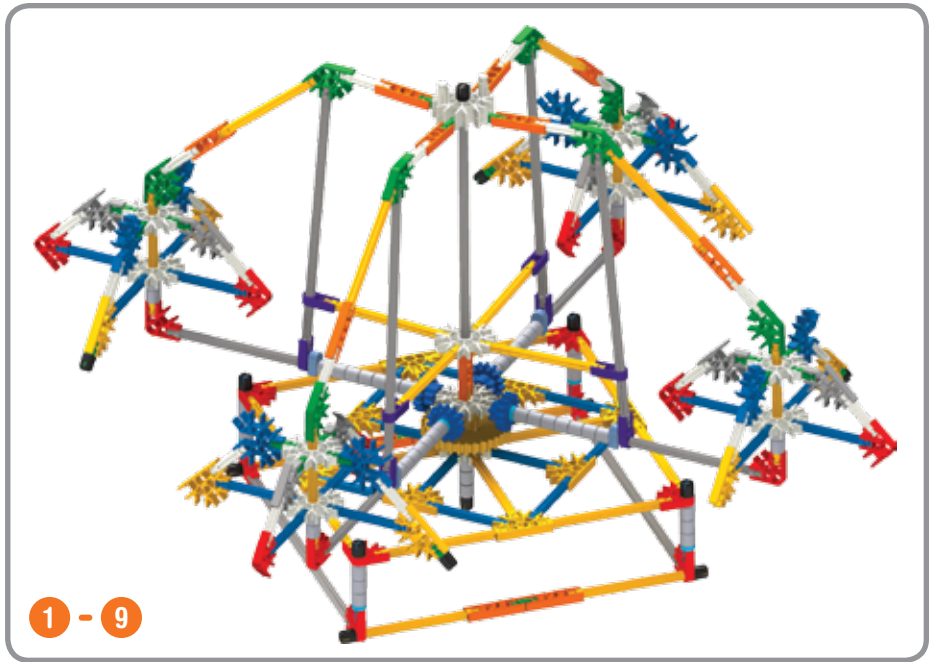
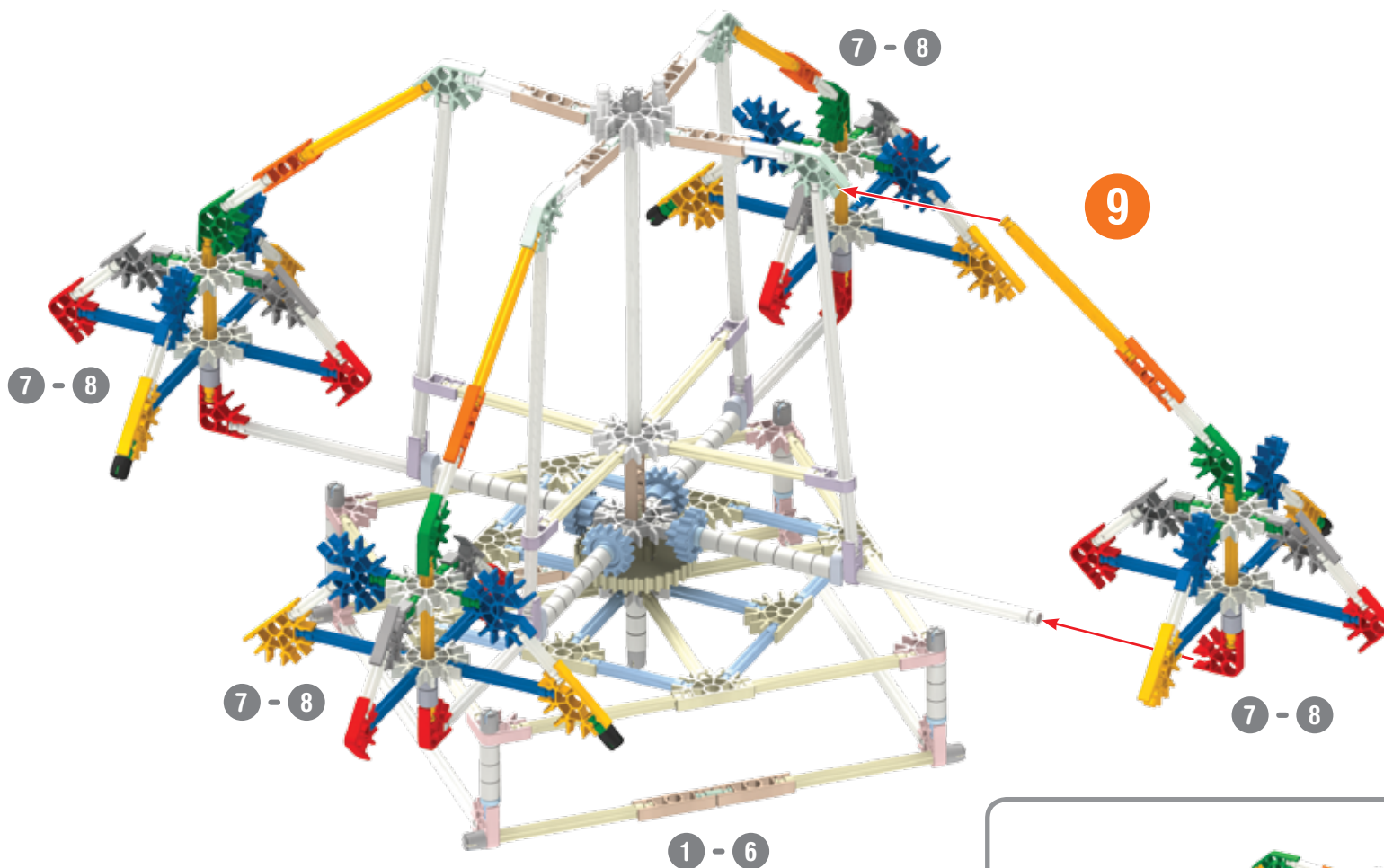

Scrambler



1 - 10

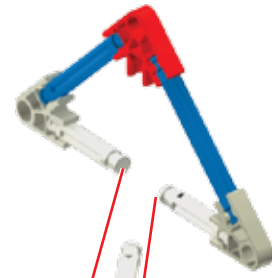

6		2		1	
2					

10

1 - 9

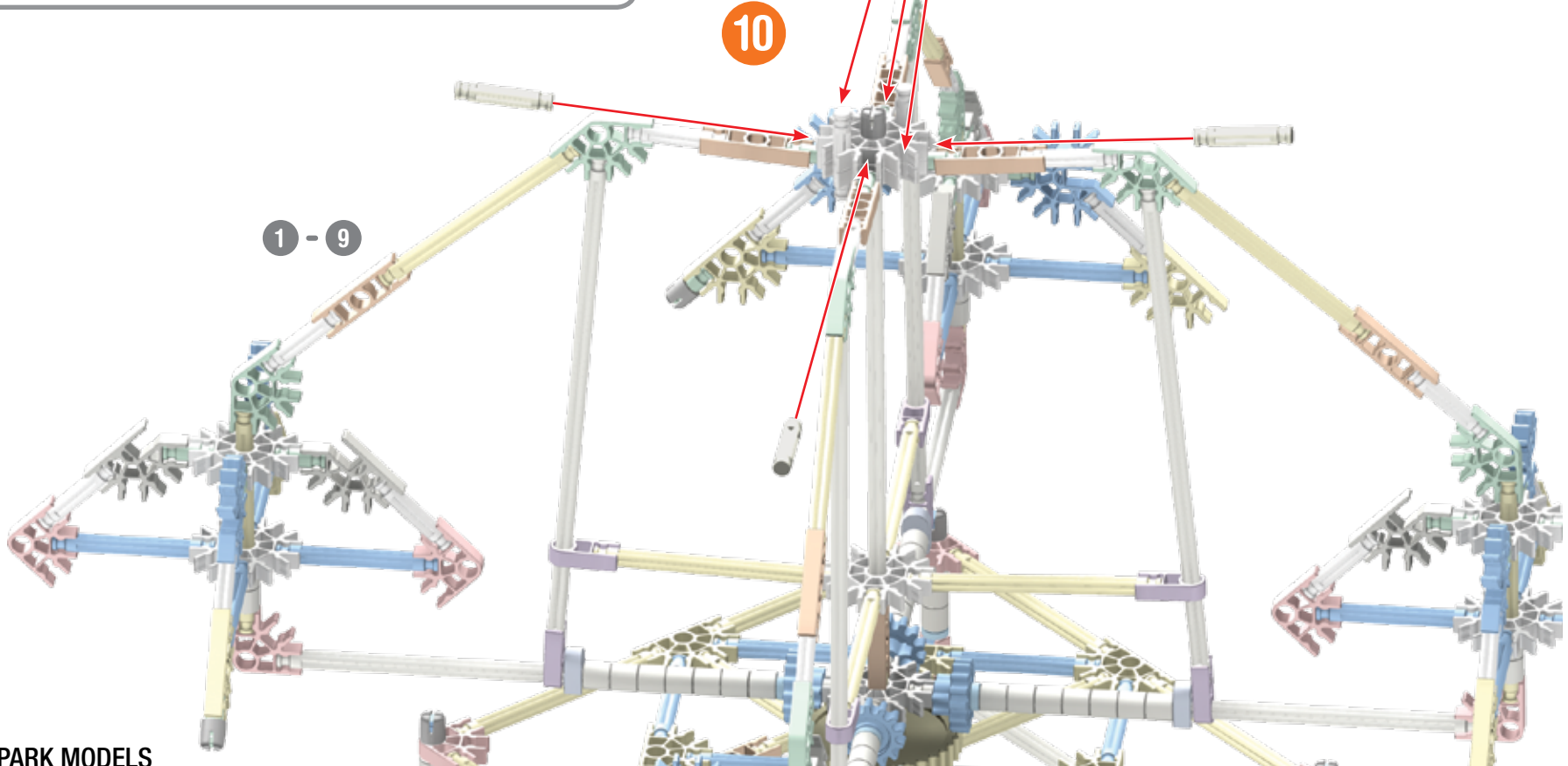

Small Ferris Wheel



x2

x2

1

1

- | | | | |
|----|--|---|--|
| 4 | | | |
| 14 | | | |
| 8 | | 2 | |
| 8 | | 4 | |

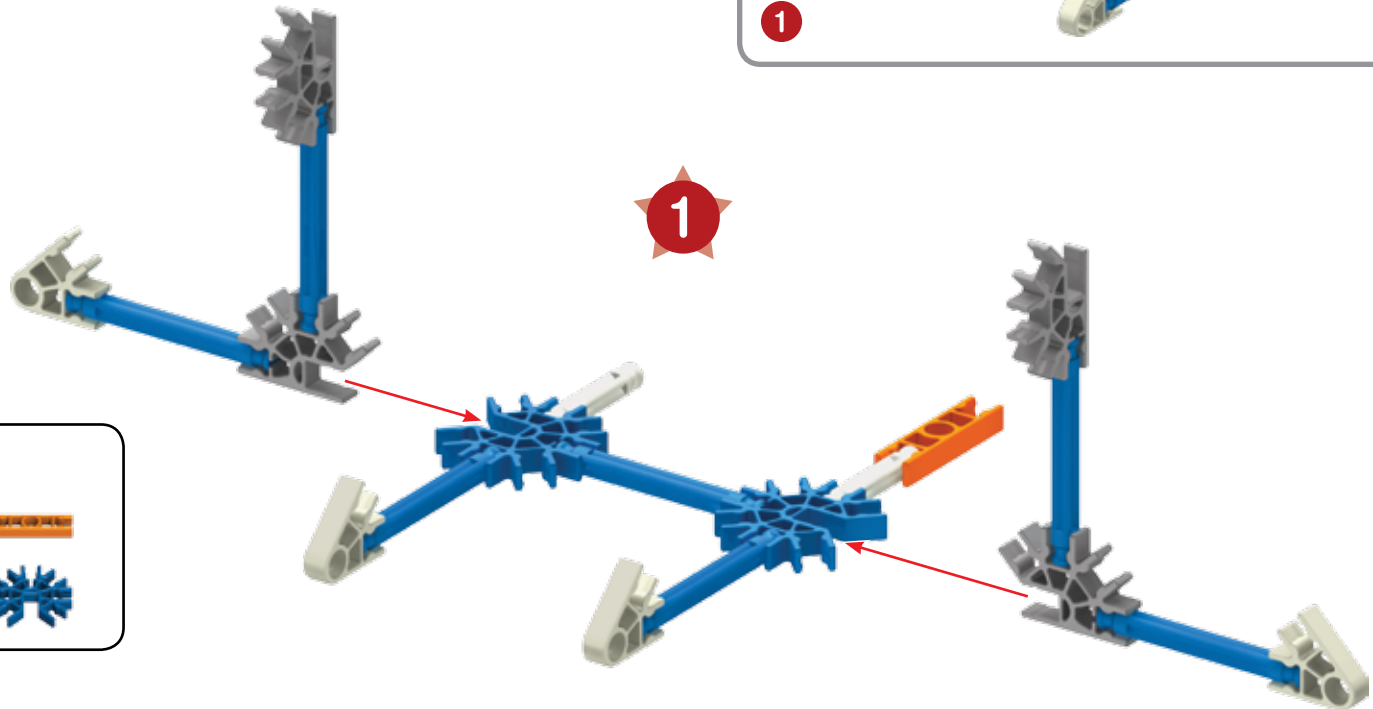

x2

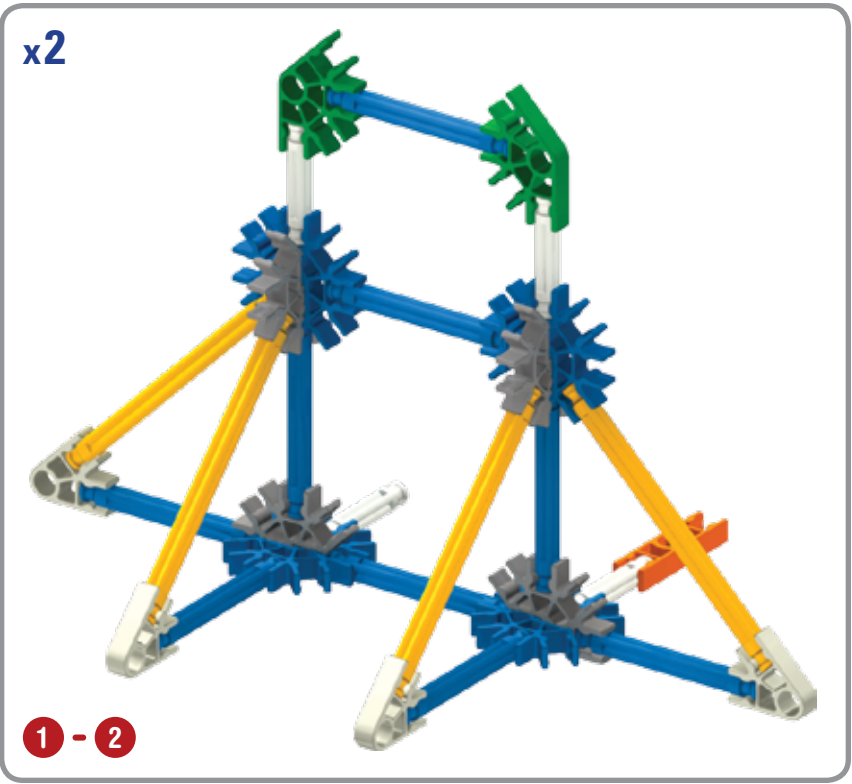
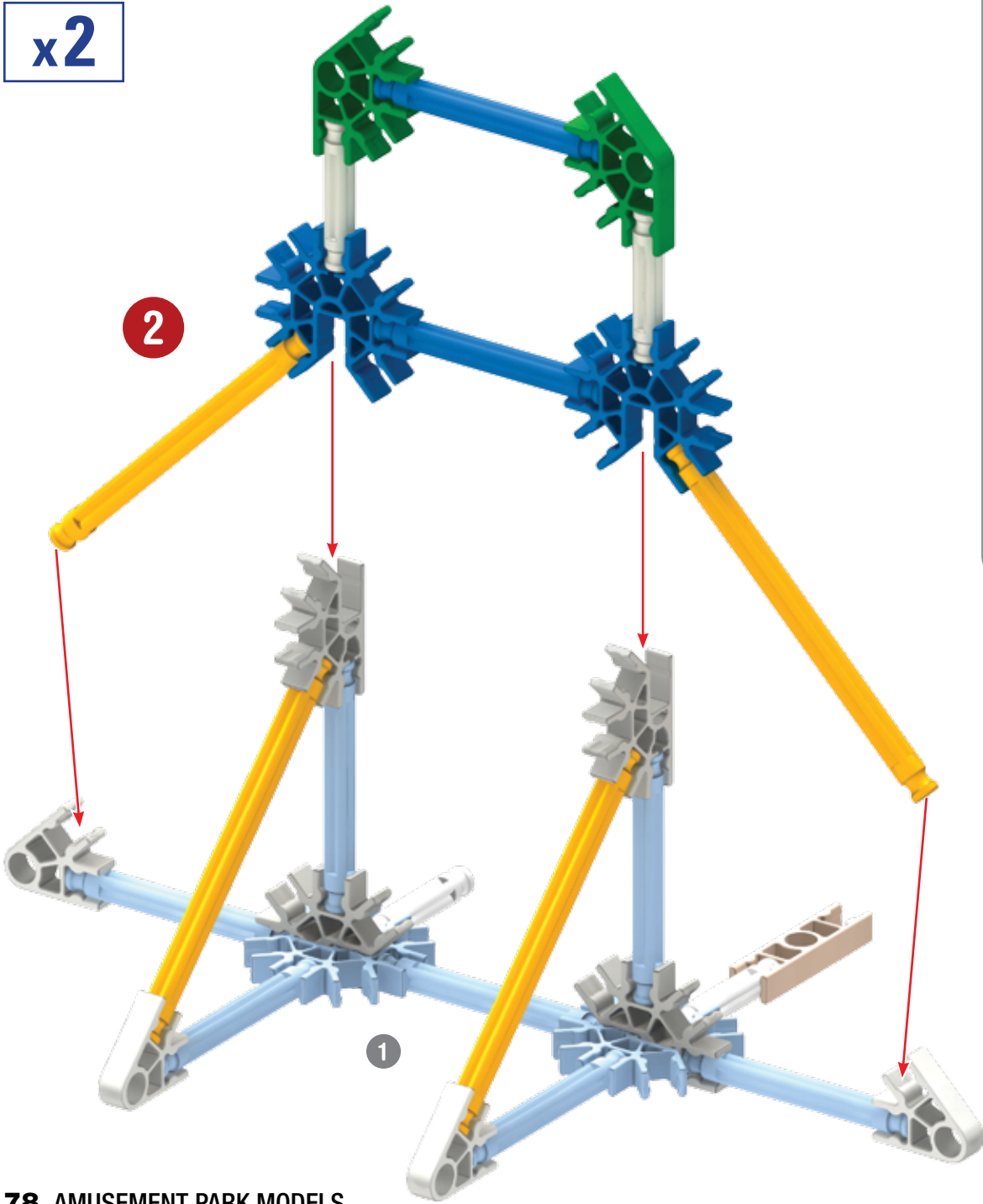

- 4
- 4
- 8
- 4
- 4

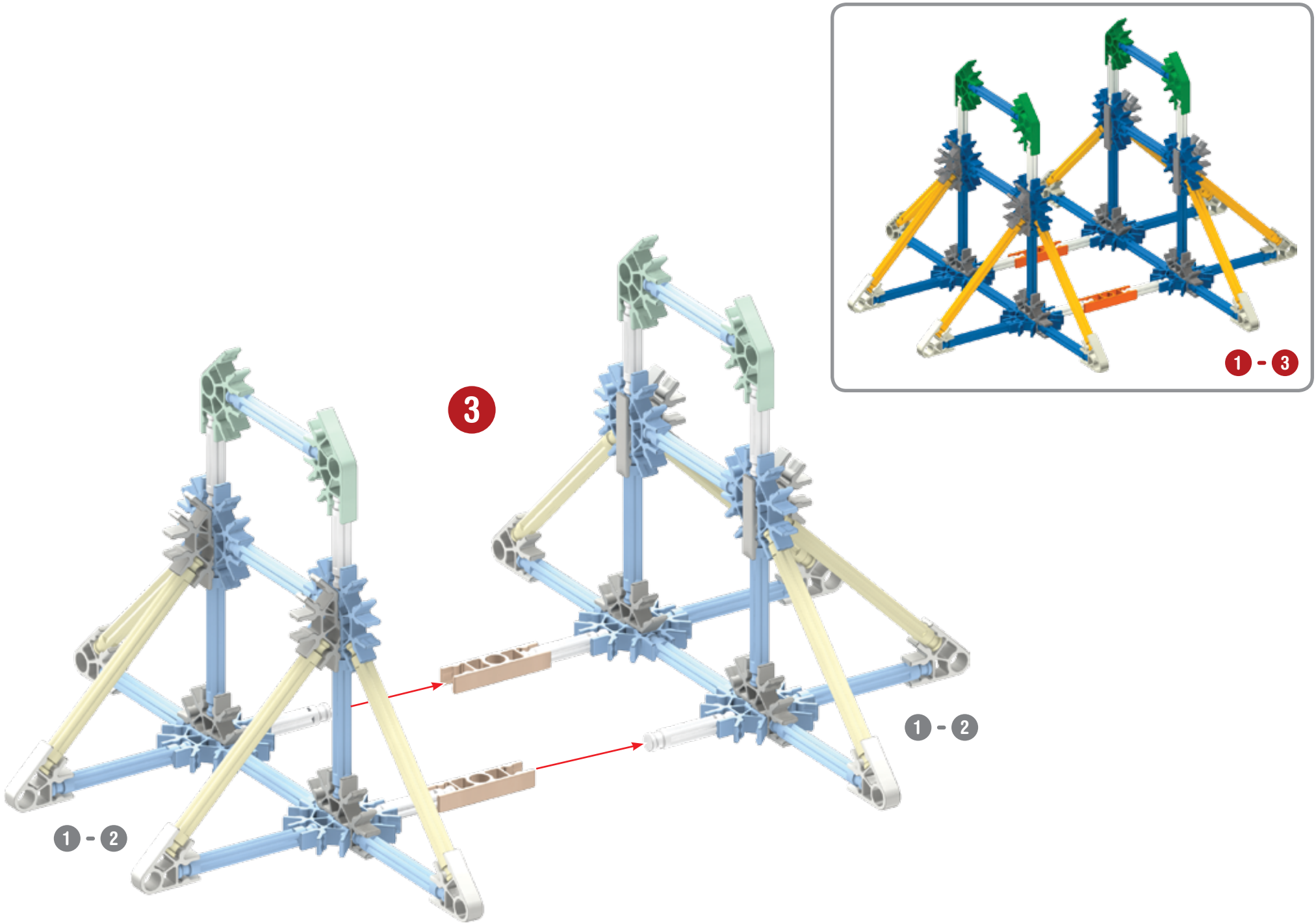

x2

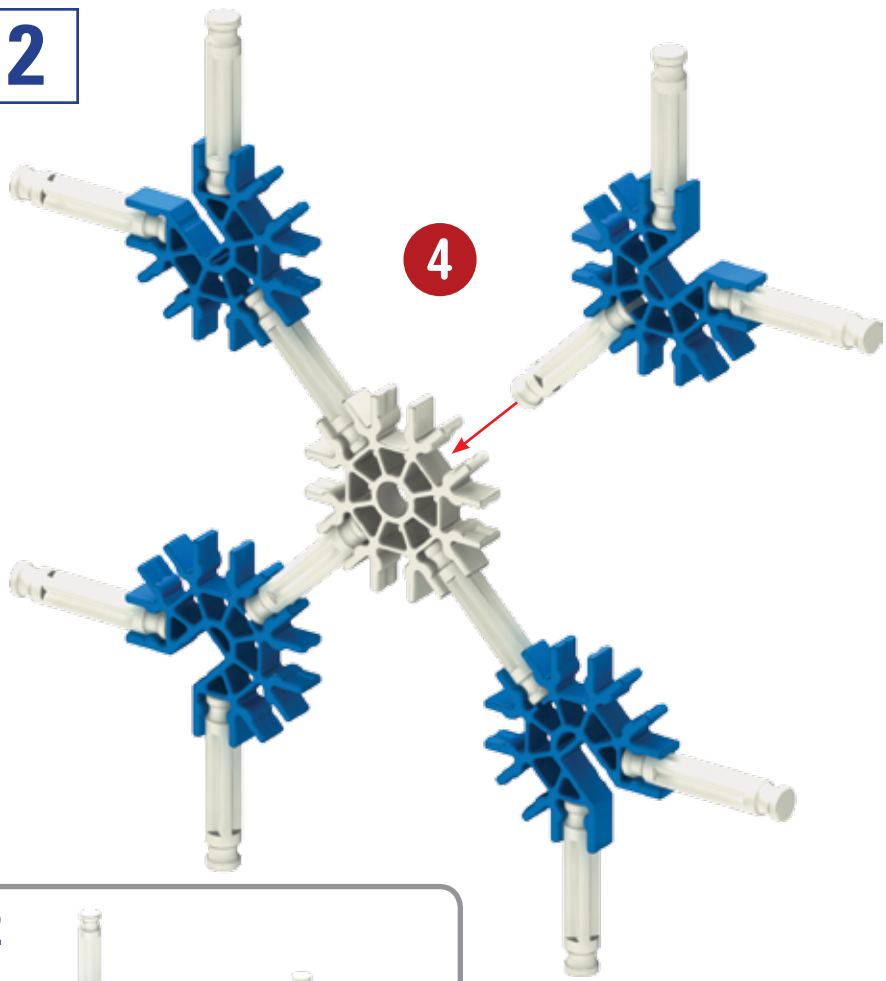

4

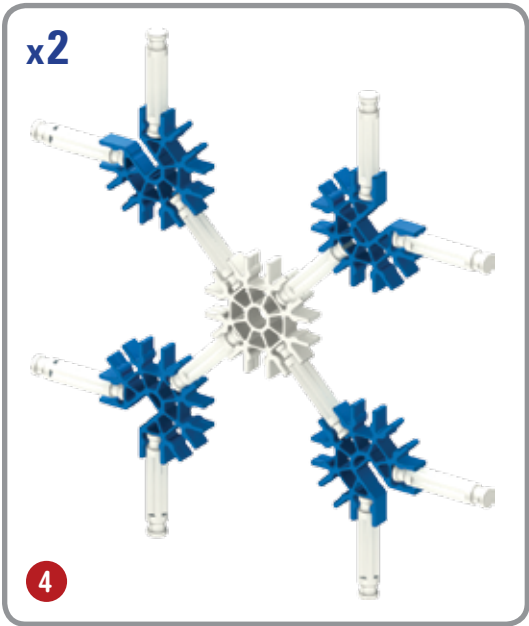

x2

- 24
- 2
- 8

x4

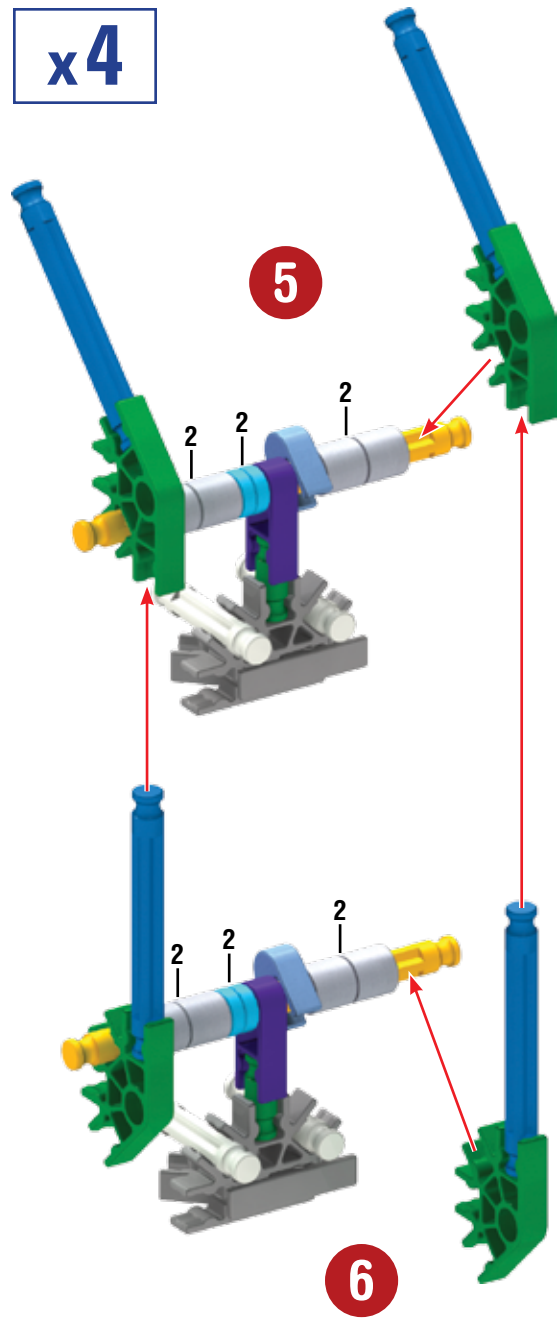

5

6

- | | |
|----|----|
| 8 | 16 |
| 16 | 32 |
| 16 | 8 |
| 8 | 8 |
| 16 | 16 |

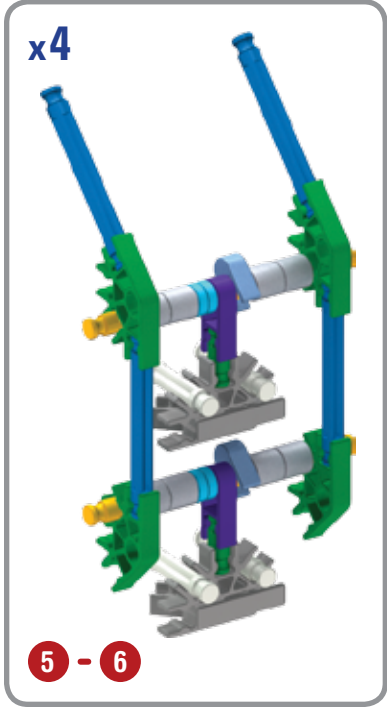

x4

5 - 6

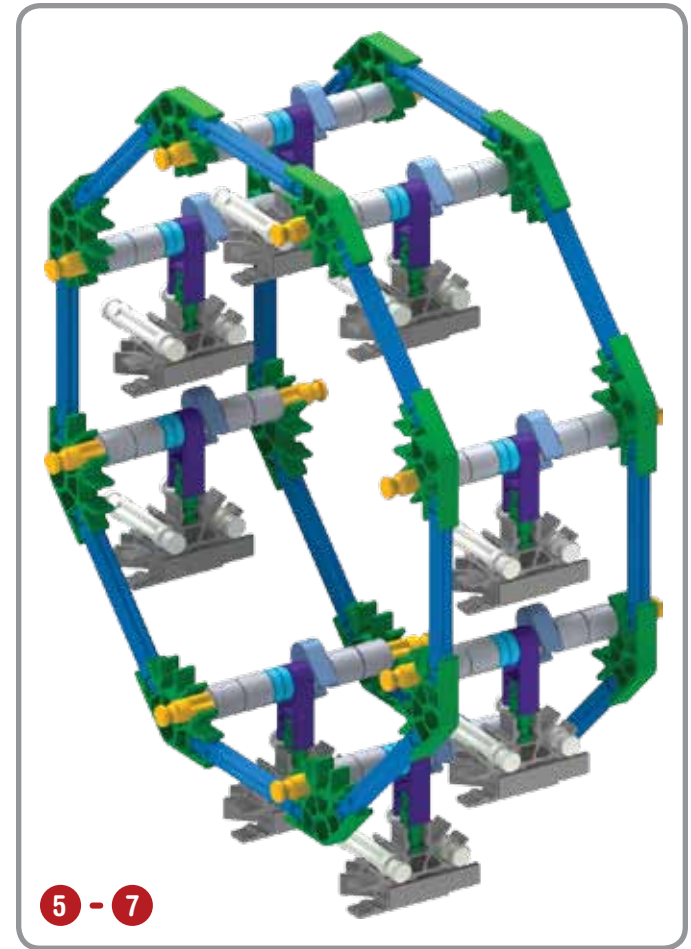
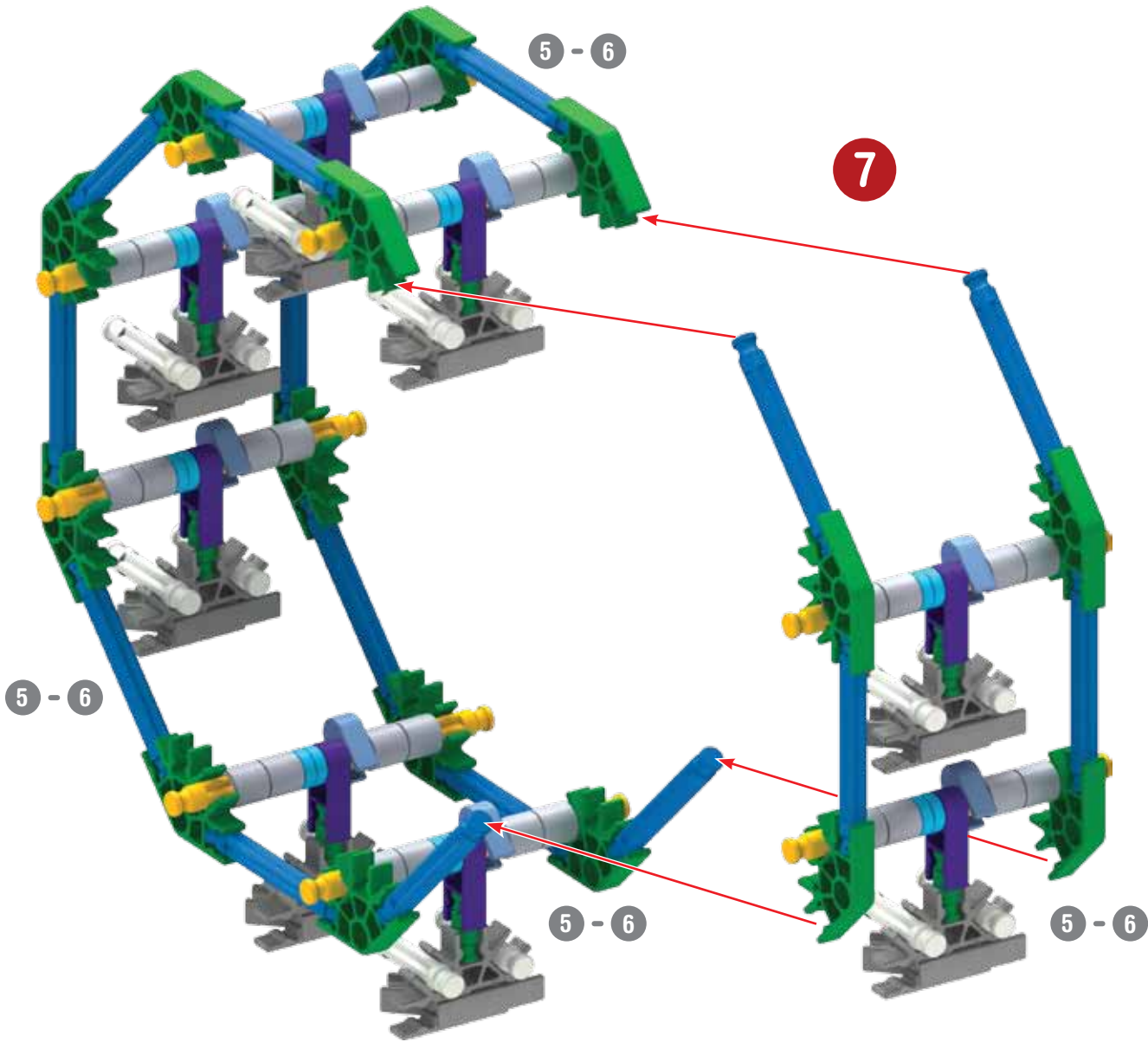

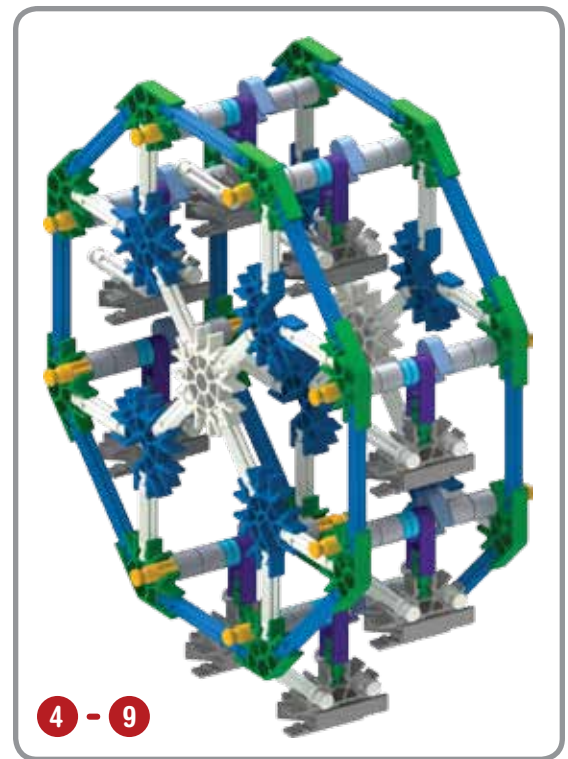
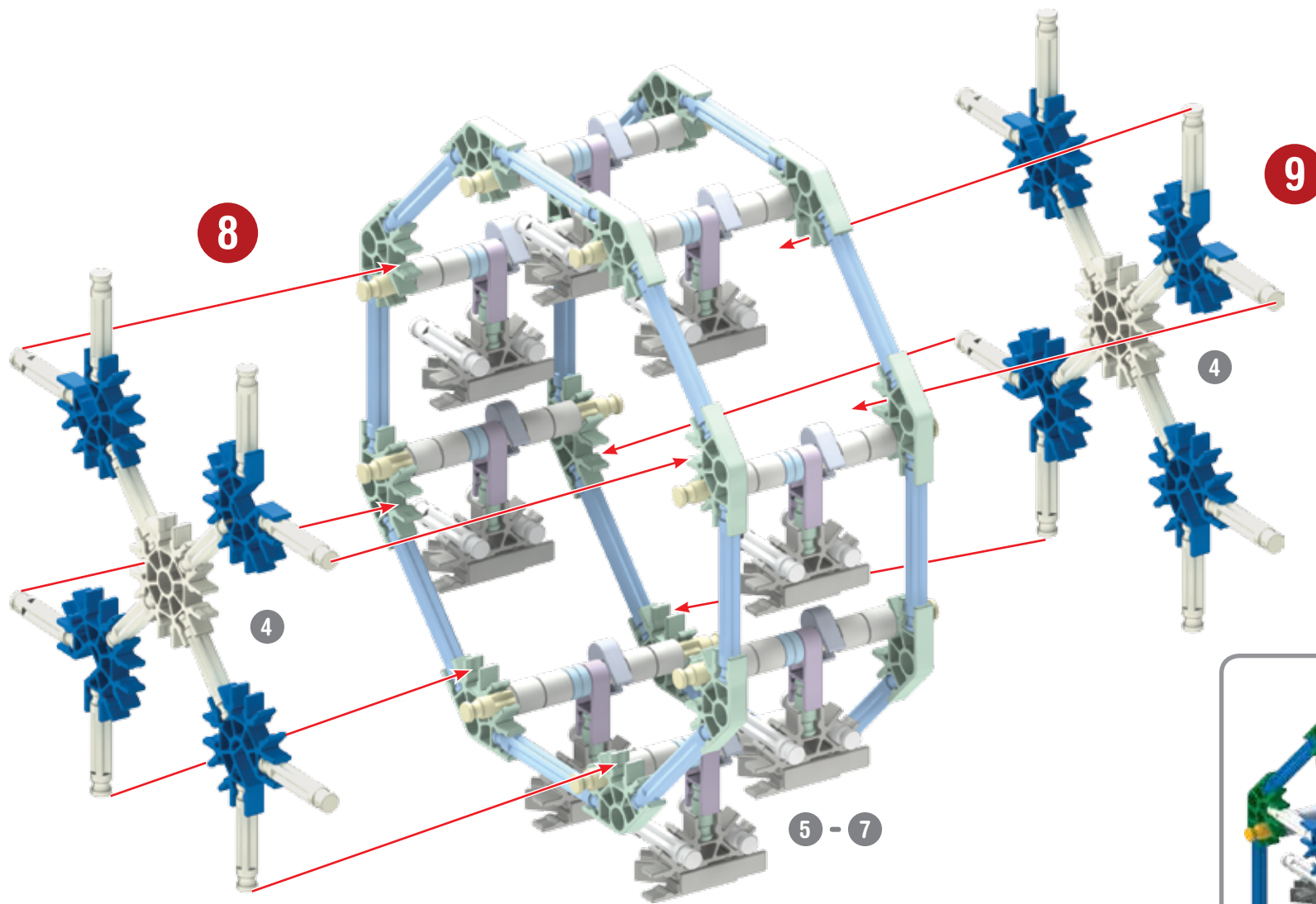

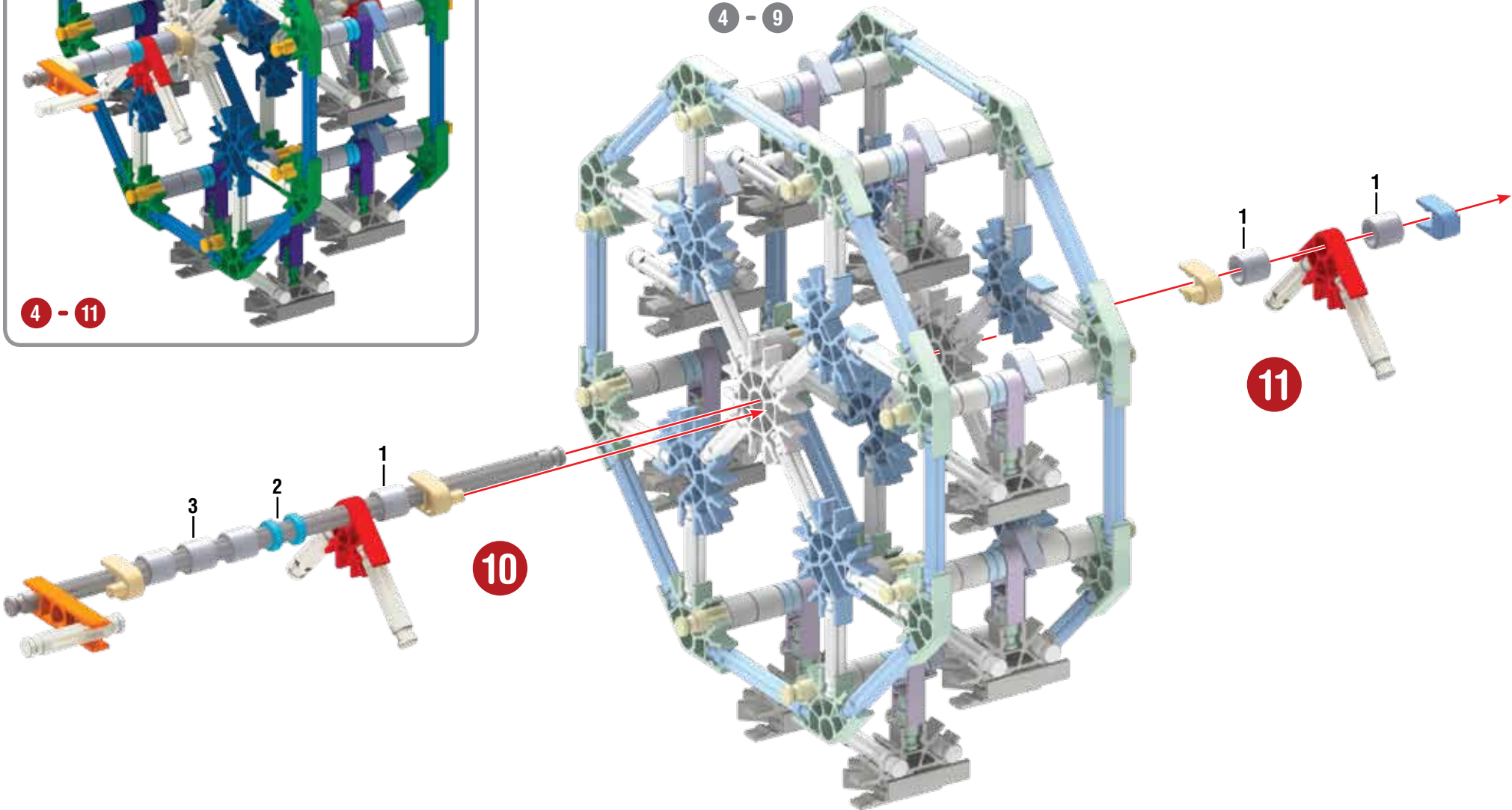
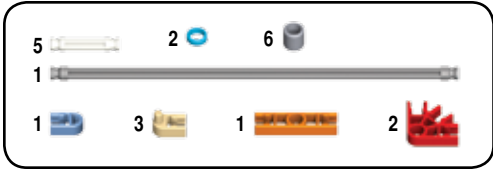
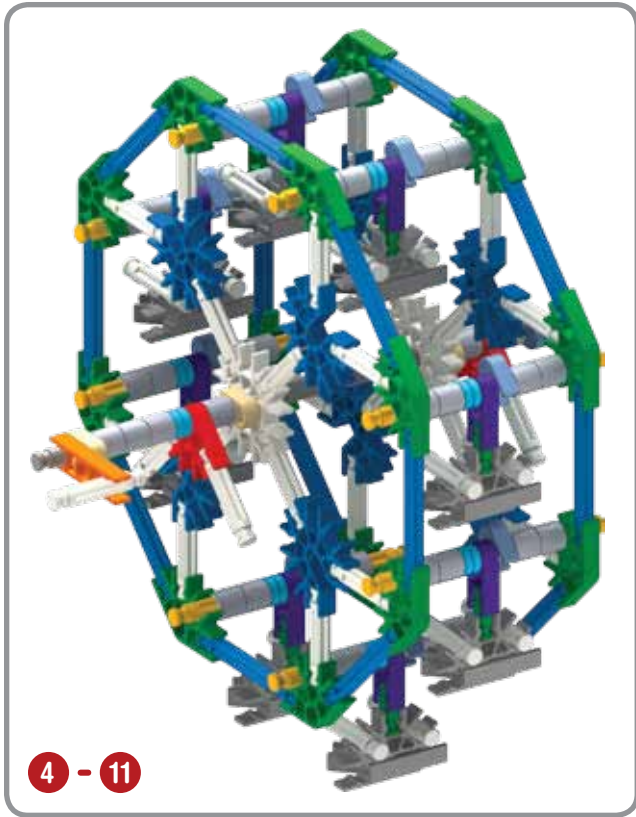

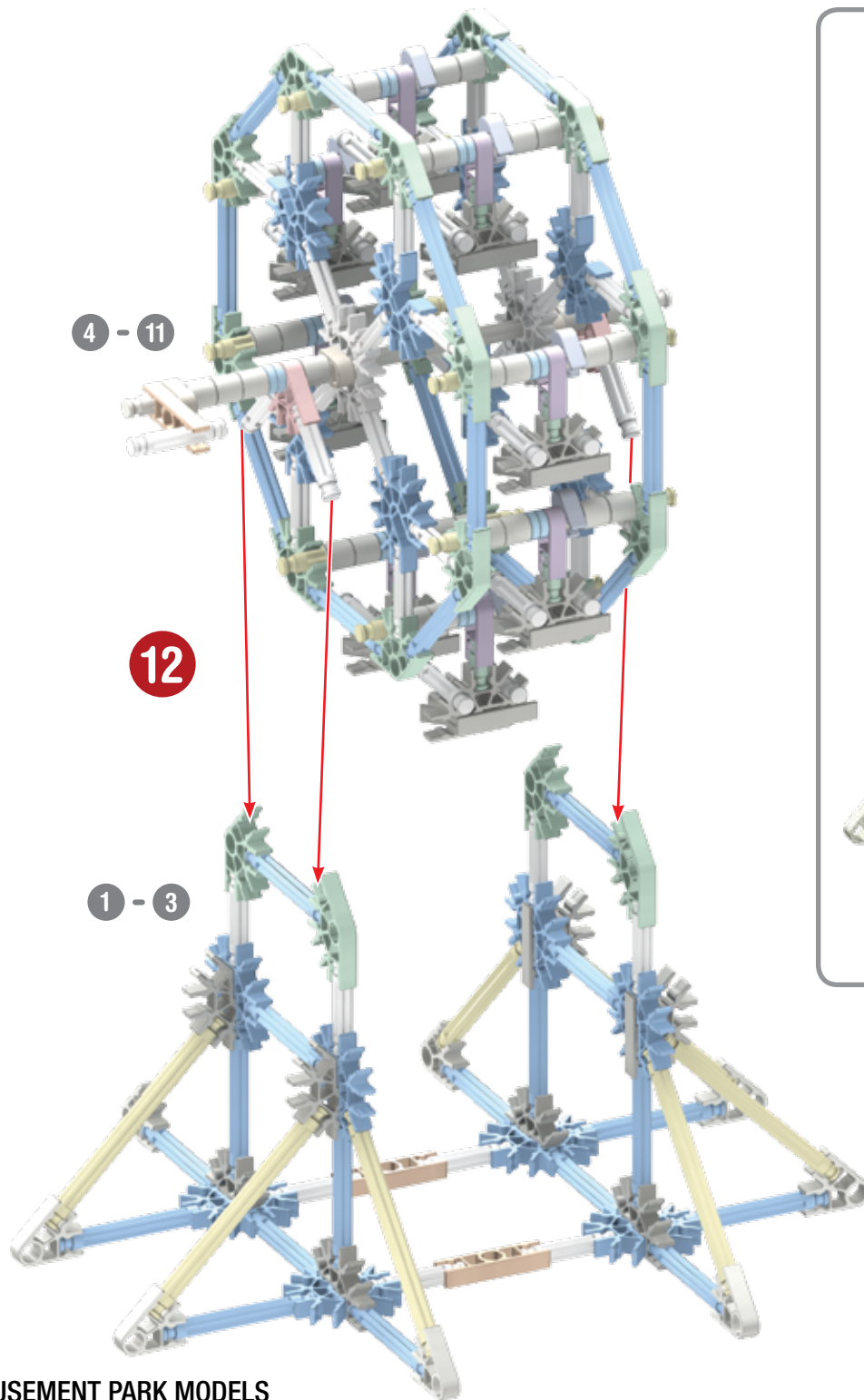

Small Ferris Wheel

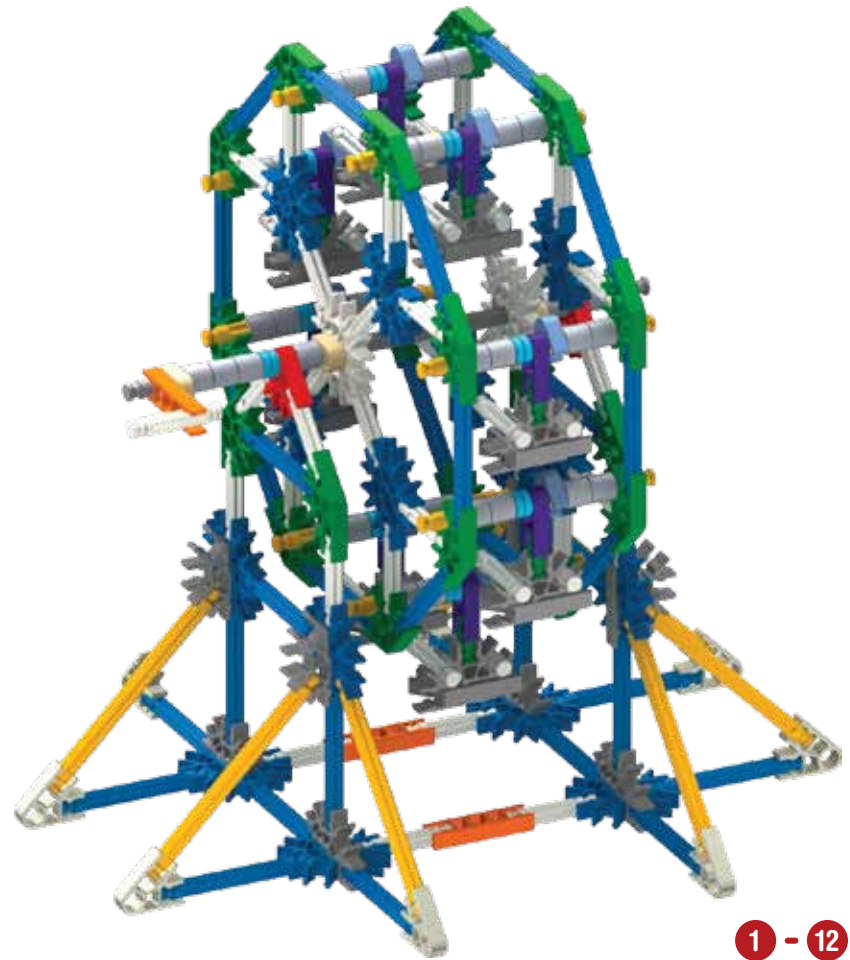

Swing Ride



x8

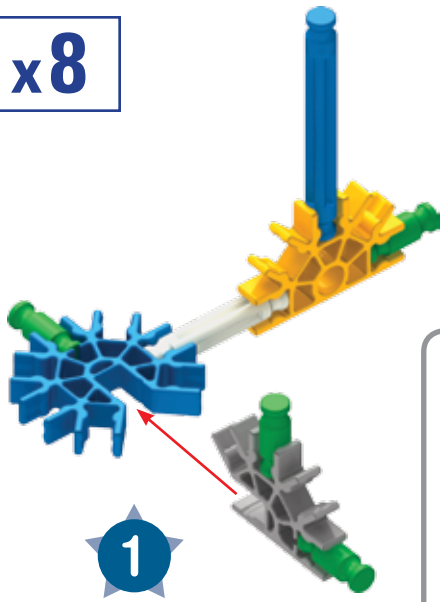

32		8	
8		8	
8			
8		8	

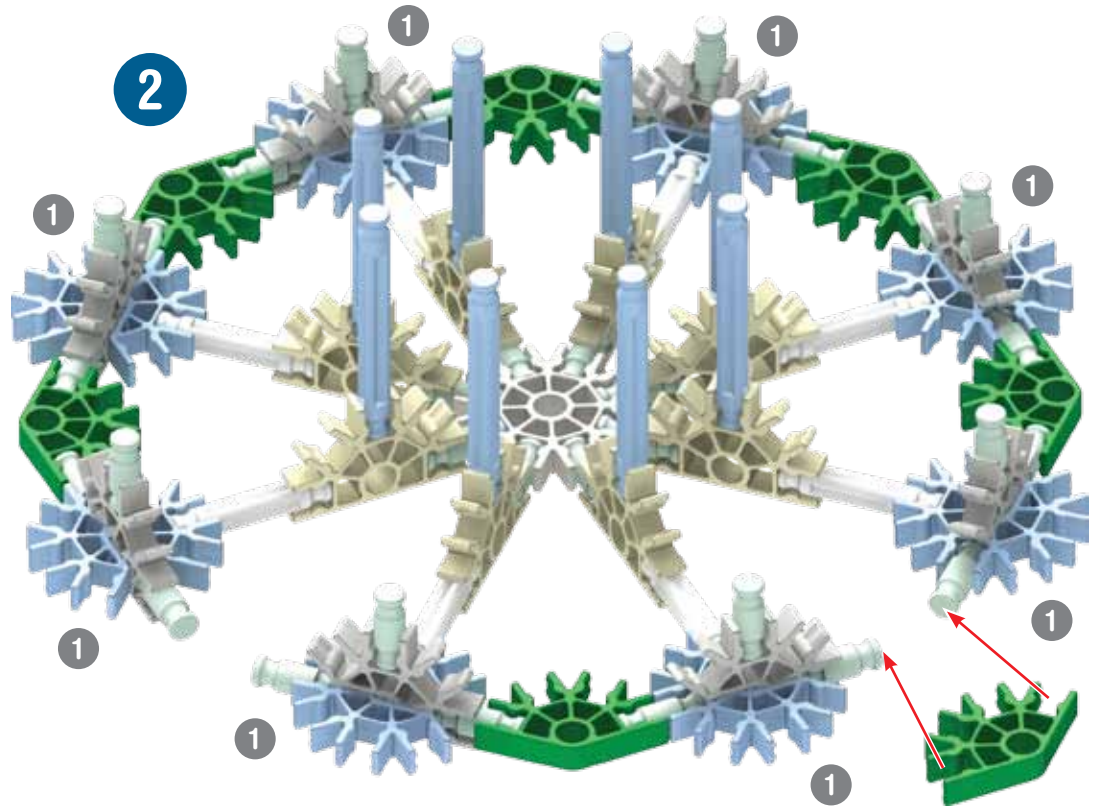
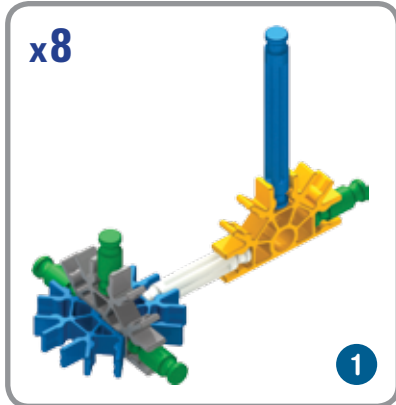

7	
1	

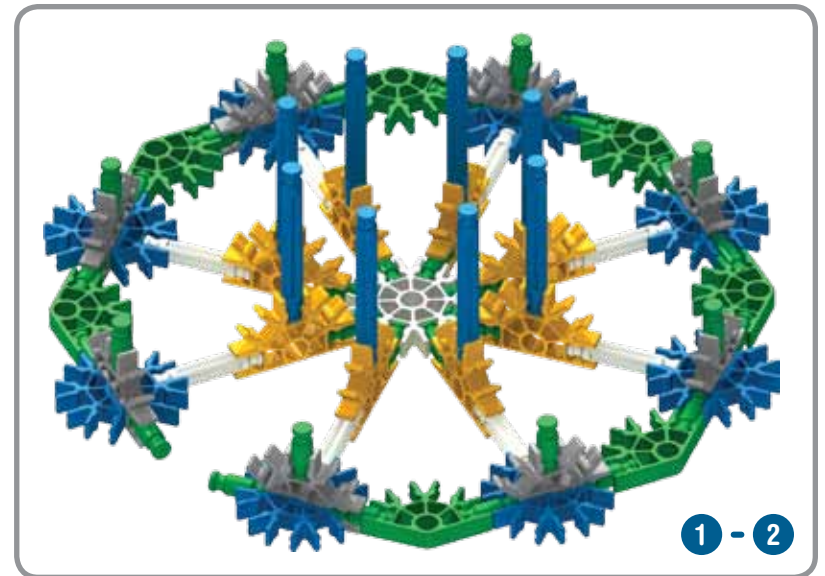

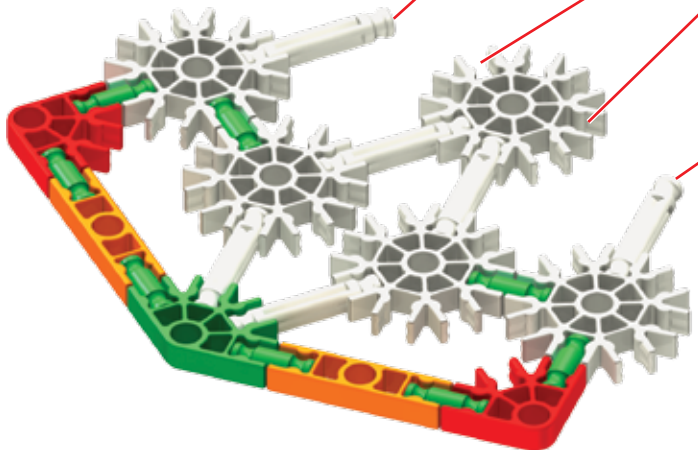
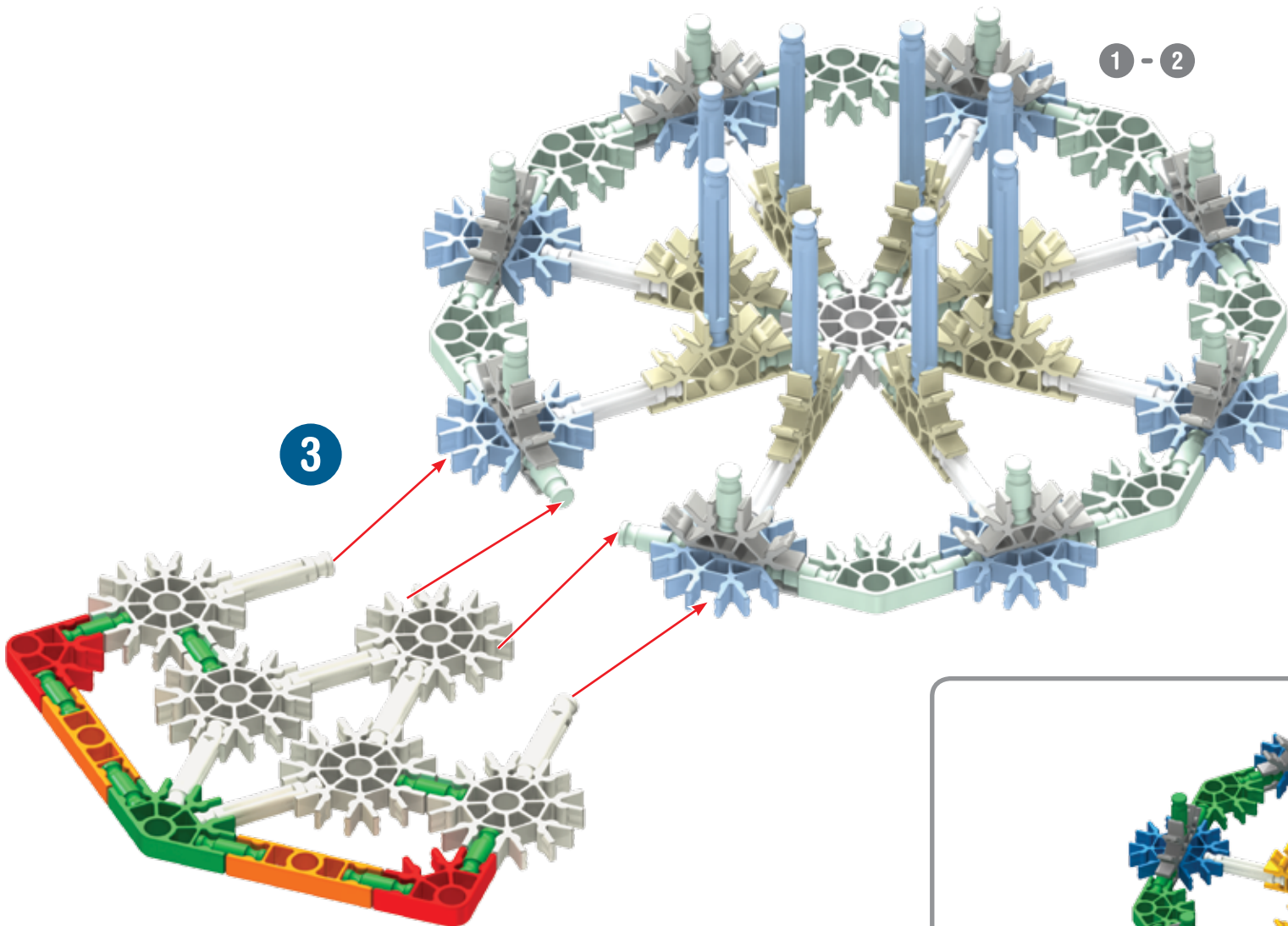

- | | | | | |
|---|--|---|--|--|
| 8 | | 2 | | |
| 6 | | | | |
| 2 | | 1 | | |

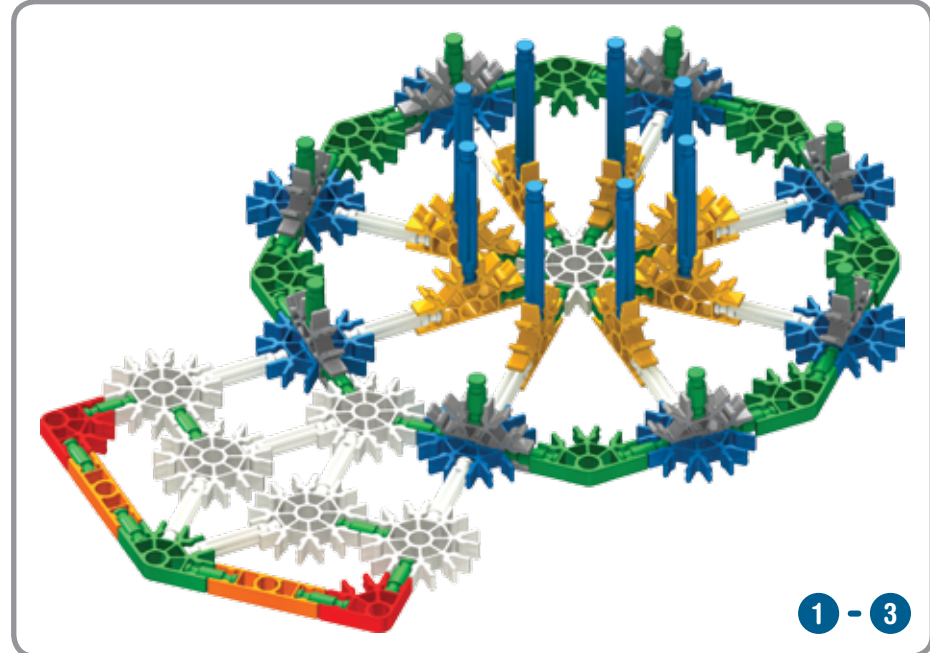

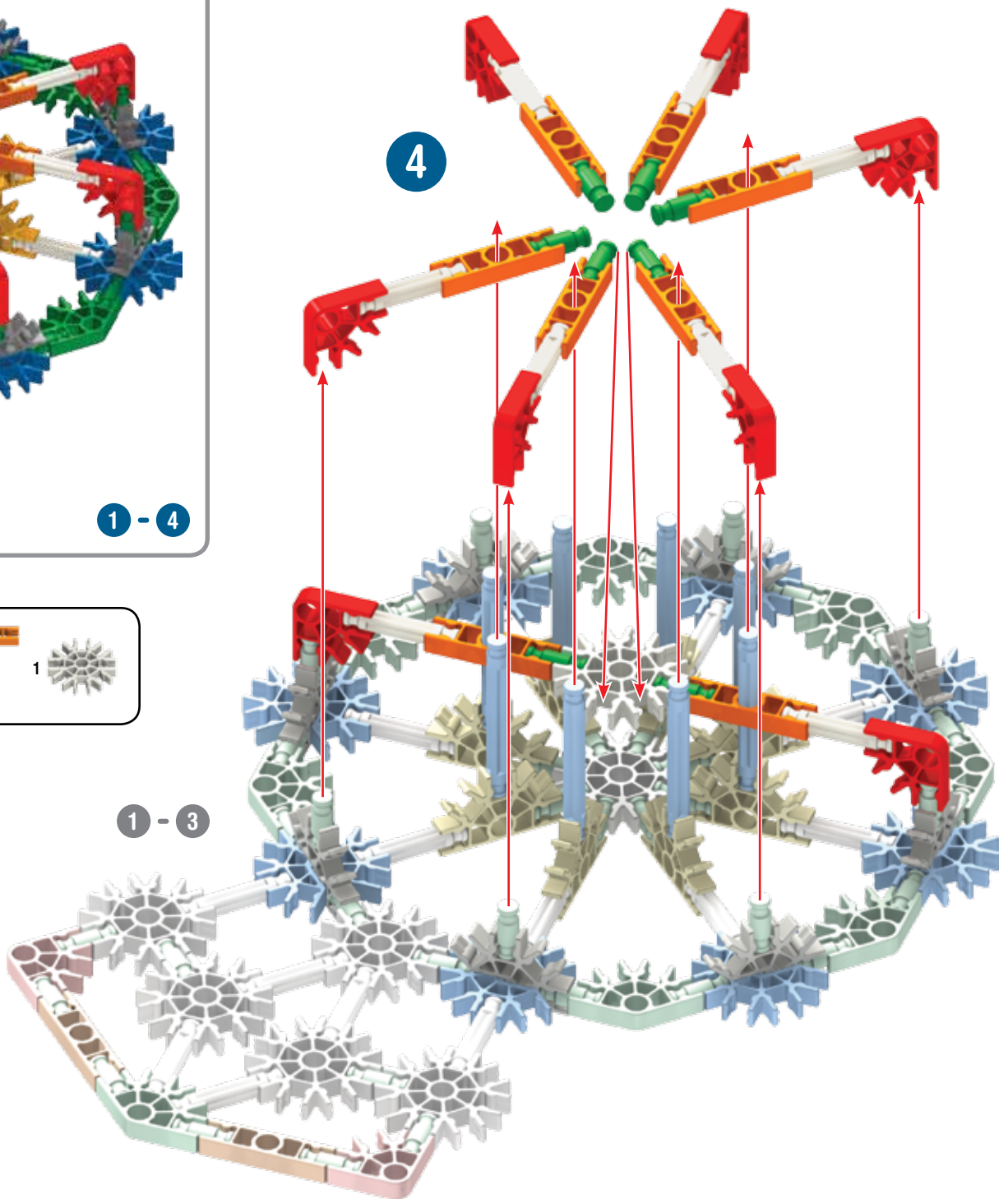
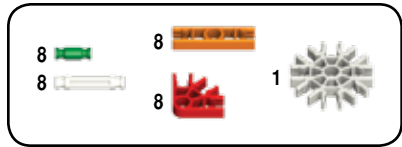
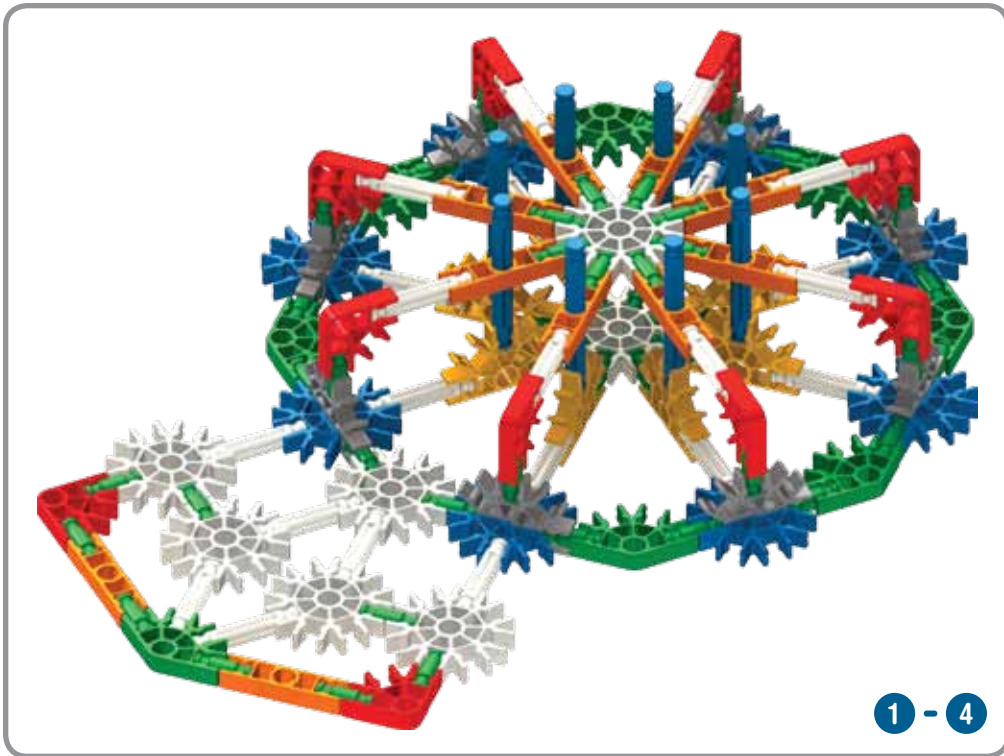

6

21		11		12		1	
1							
2		3					

x3

x2

x5

x6

x3

x4

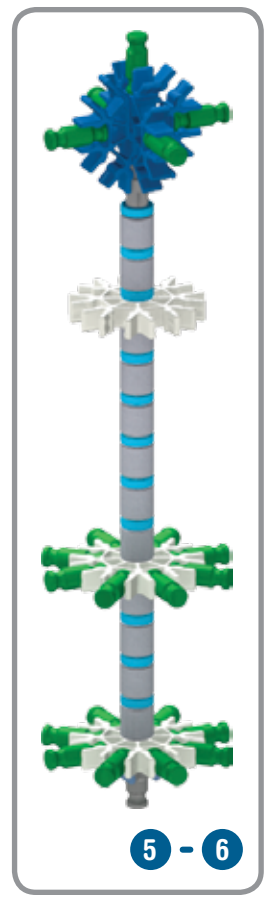

5 - 6

5 - 6

7

8

5 - 8

8

8

8

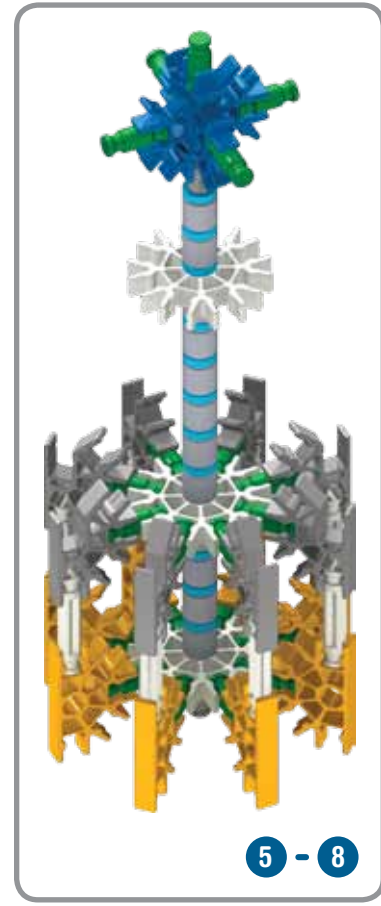

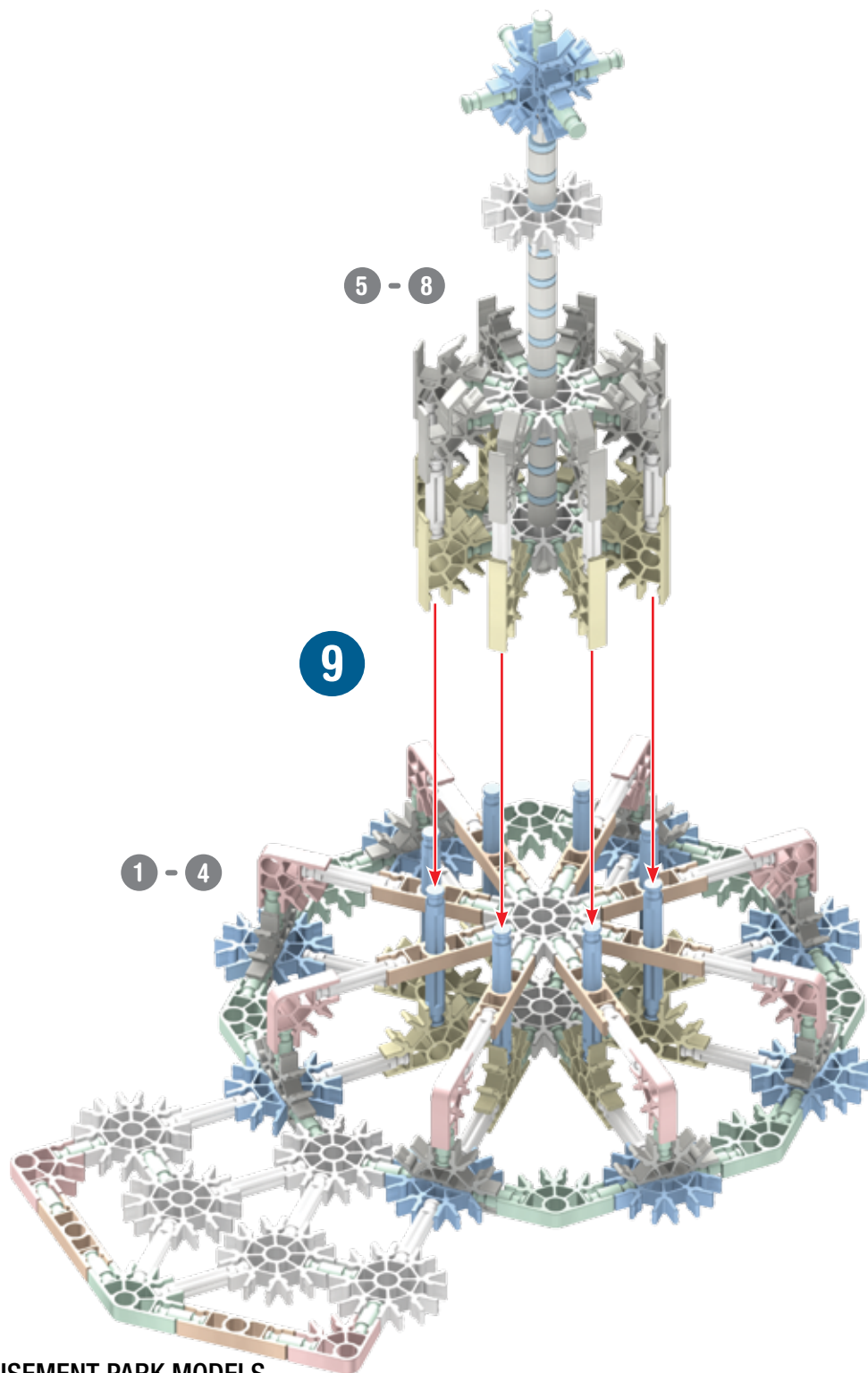

x4

10

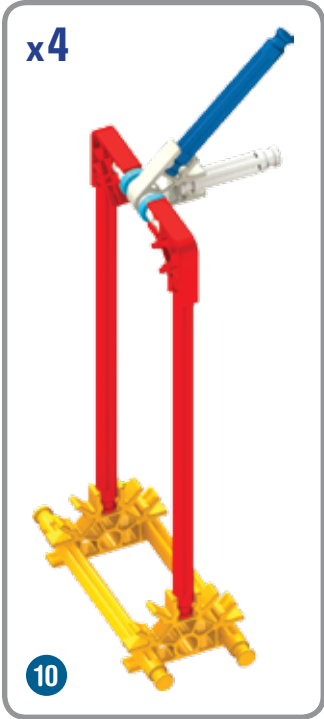
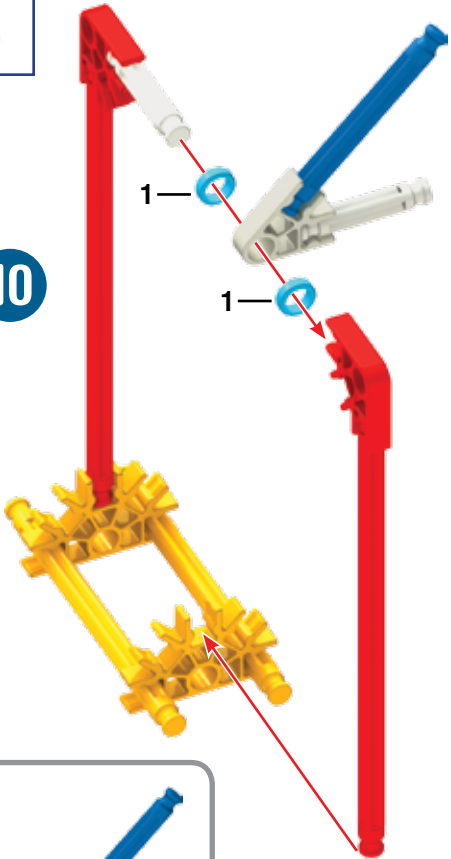

x4

10

- | | | | | | |
|---|--|---|--|---|--|
| 8 | | 8 | | 4 | |
| 4 | | | | | |
| 8 | | | | | |
| 8 | | | | | |
| 8 | | 8 | | | |

11

10

10

10

10

1 - 9

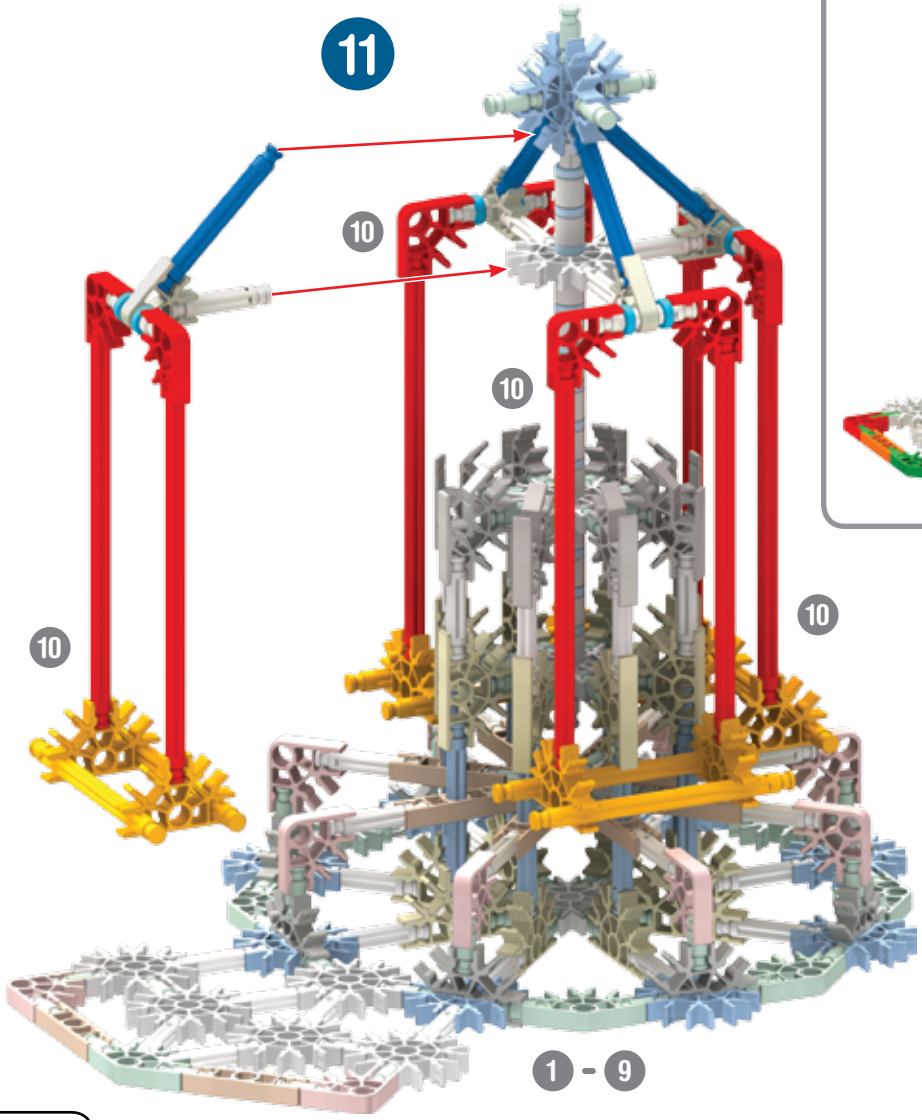

Swing Ride



1 - 11