



**100 MODEL ULTRA BUILDING SET**

**MISCELLANEOUS**



**Camera**  
page 1

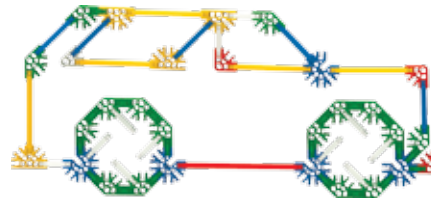

**Car**  
page 12



**Drum Kit**  
page 13

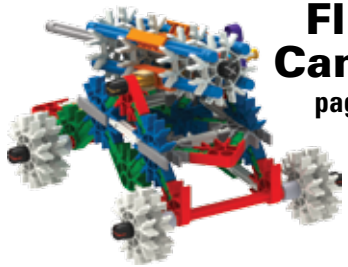

**Flick Cannon**  
page 20



**Gravitron**  
page 24

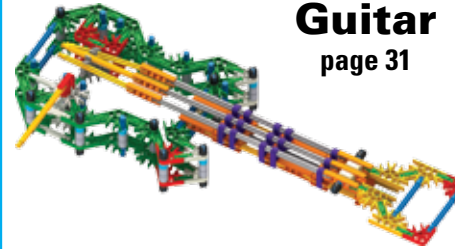

**Guitar**  
page 31



**Mech**  
page 38



**Metal Detector**  
page 47

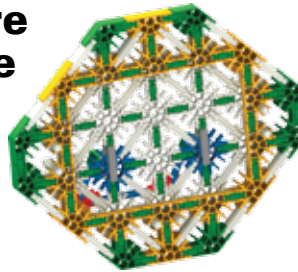

**Picture Frame**  
page 55

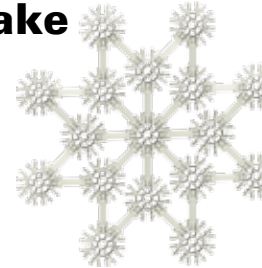

**Snowflake**  
page 58

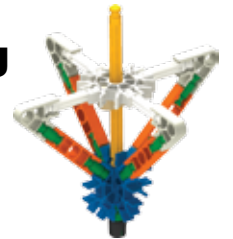

**Spinning Top**  
page 59

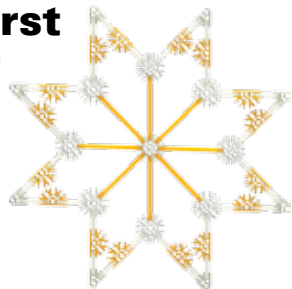

**Starburst**  
page 60



**Table Tennis**  
page 61



**Telephone**  
page 63

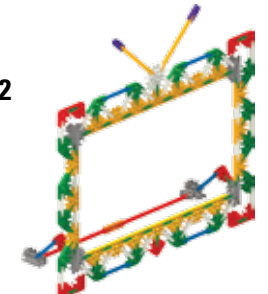

**TV**  
page 72

# Camera



x2

1

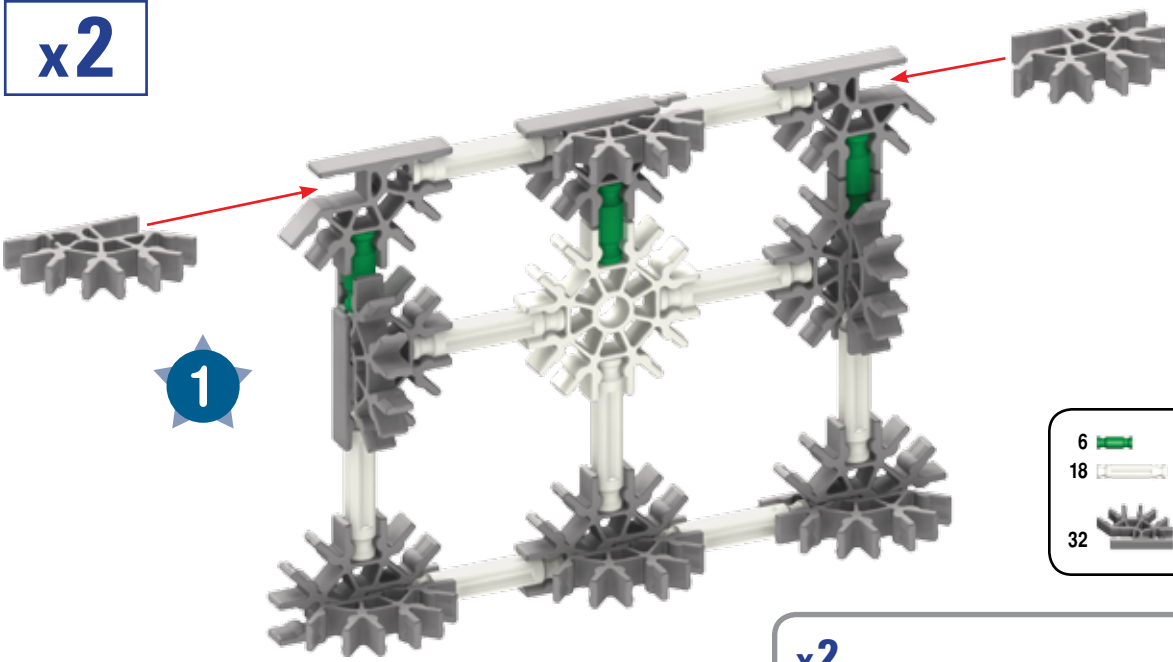

- 6
- 18
- 32
- 2

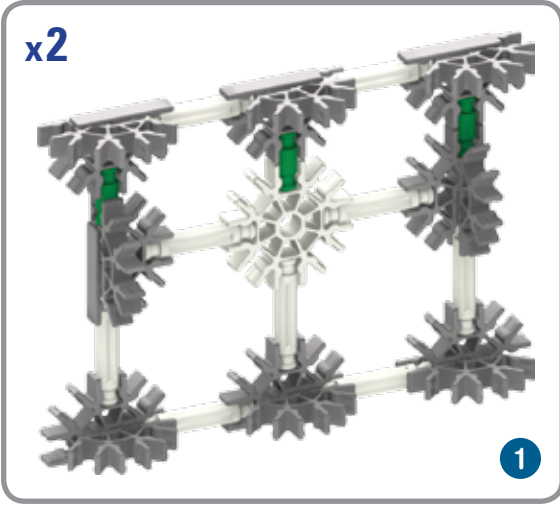

x2

1

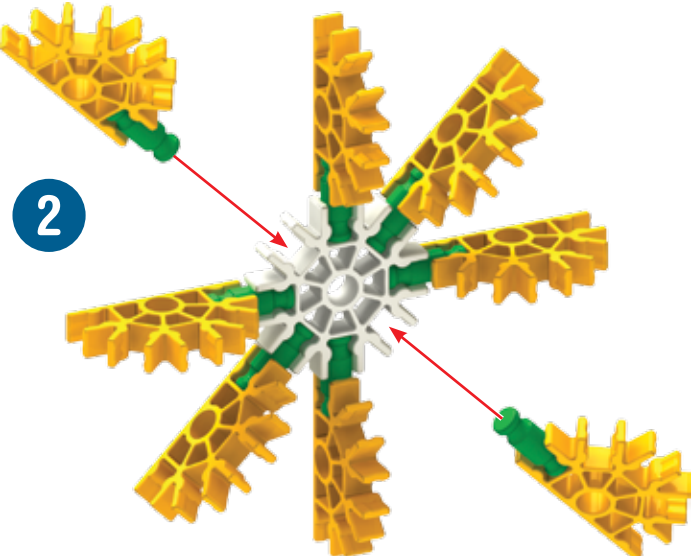

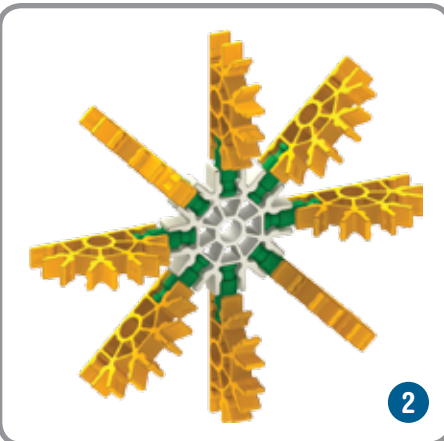

2

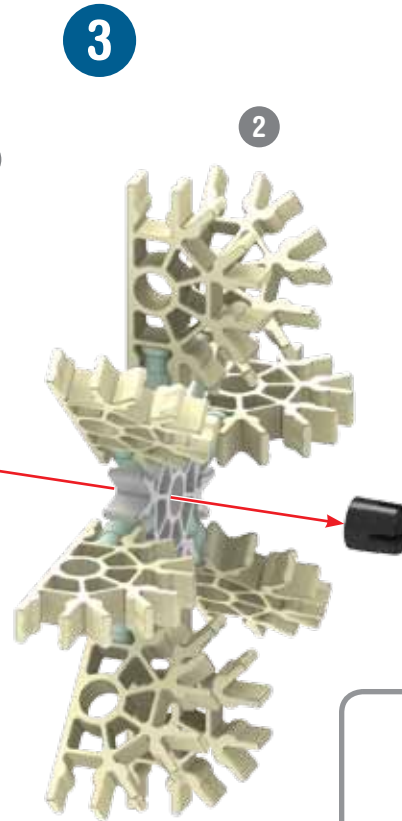
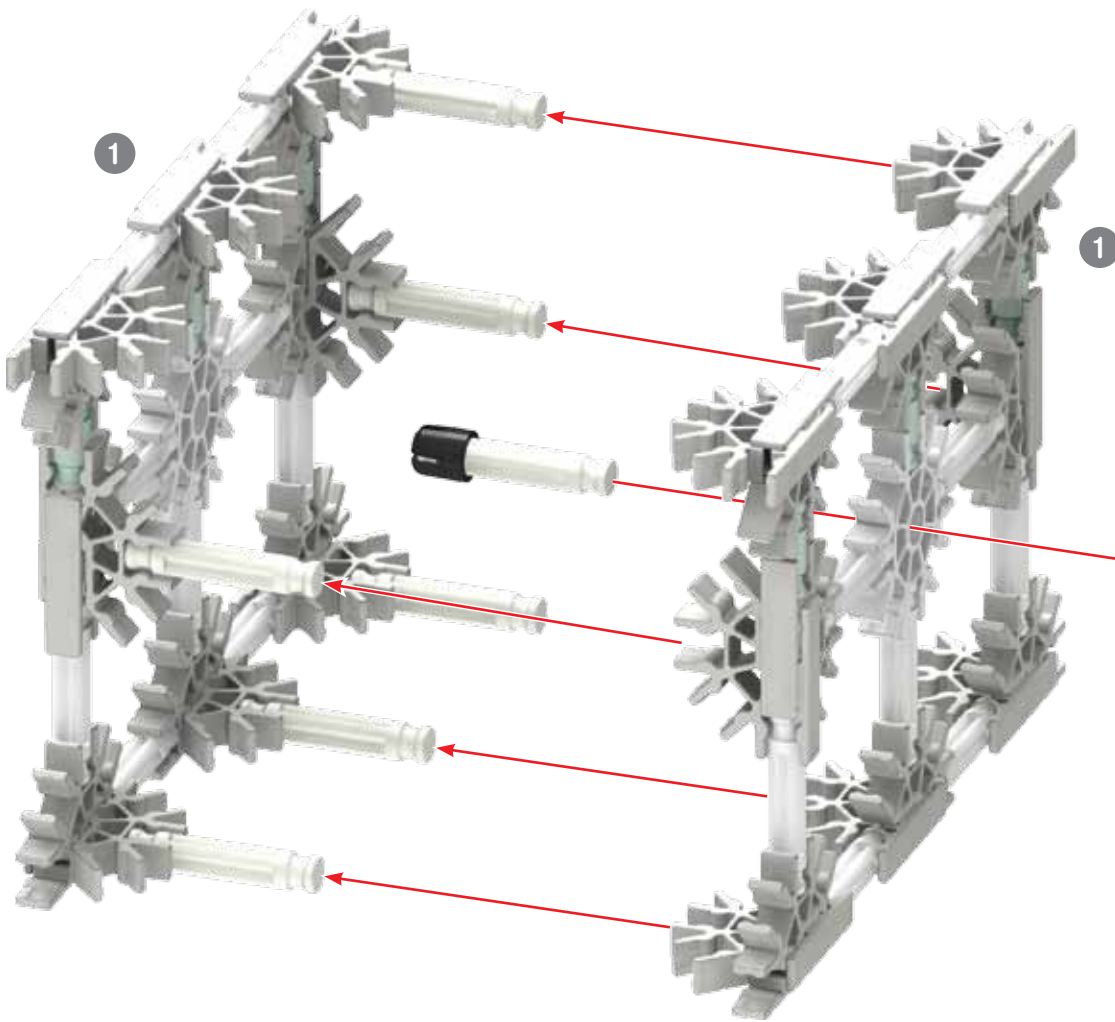

2

- 8
- 8
- 1



- 2 
- 7 



4

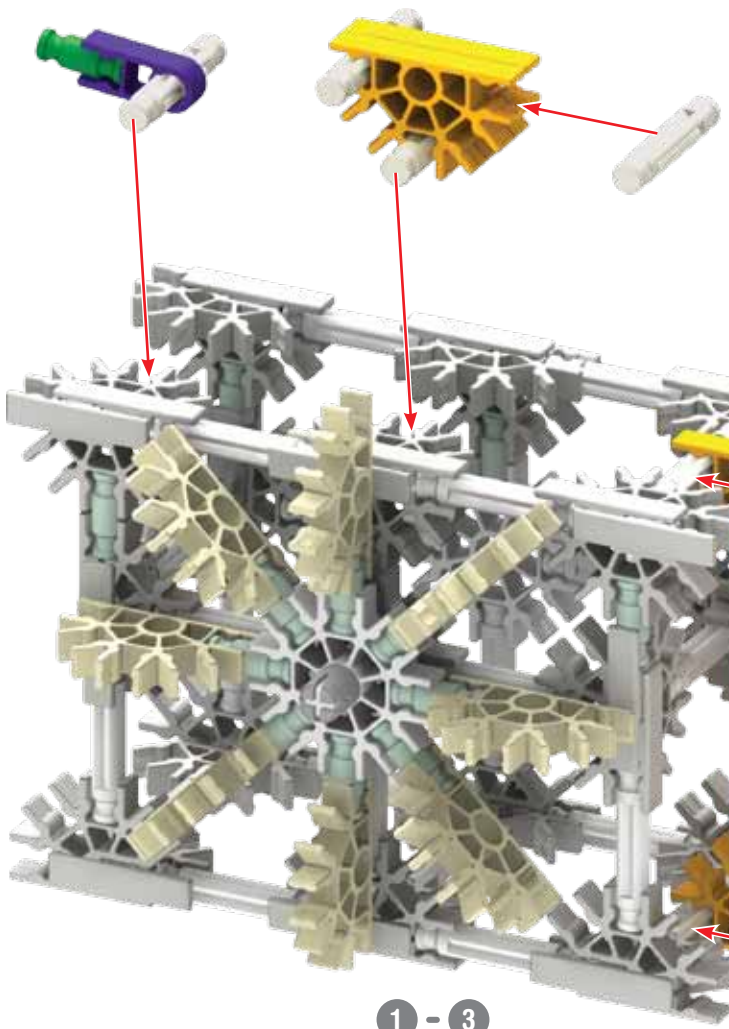

1 - 3

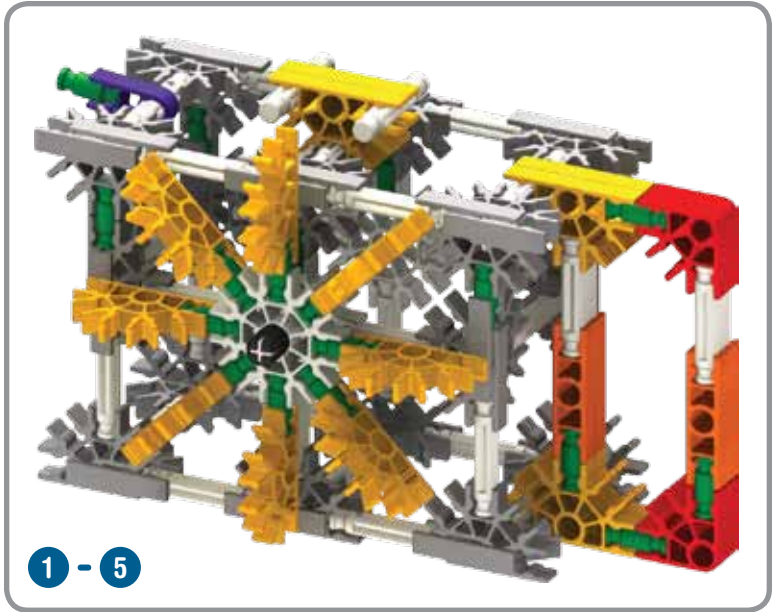

1 - 5

5

9		6		
8				
1		4		4

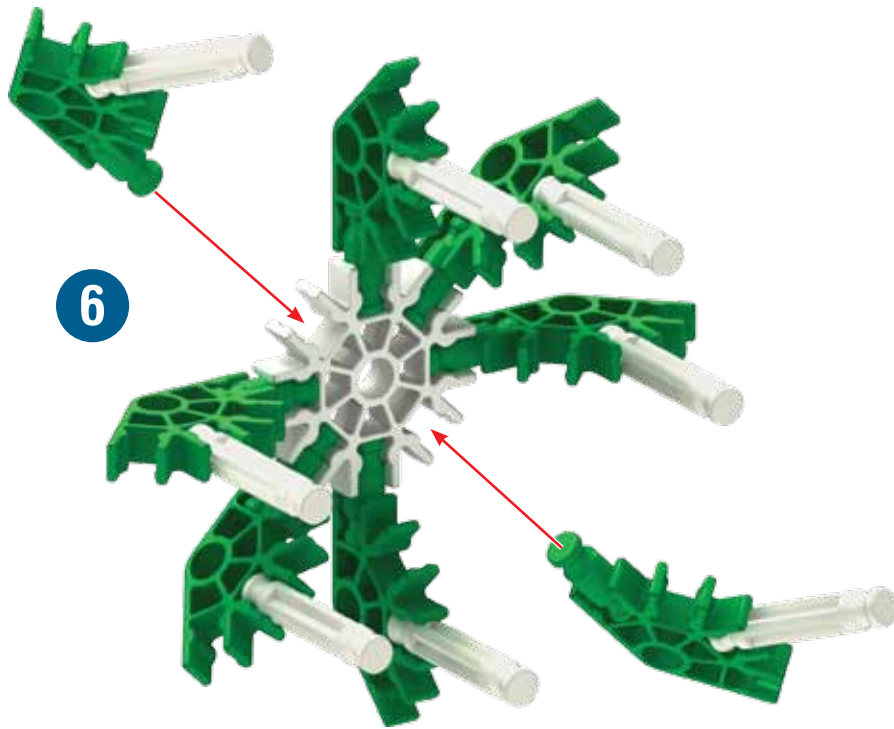

6

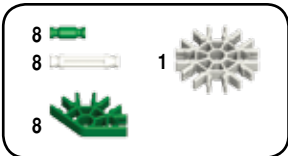

6

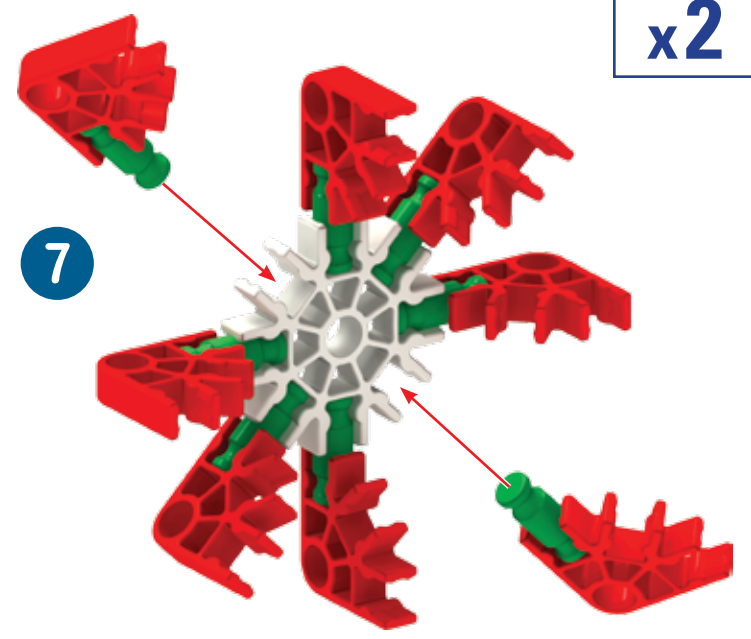

x2

7

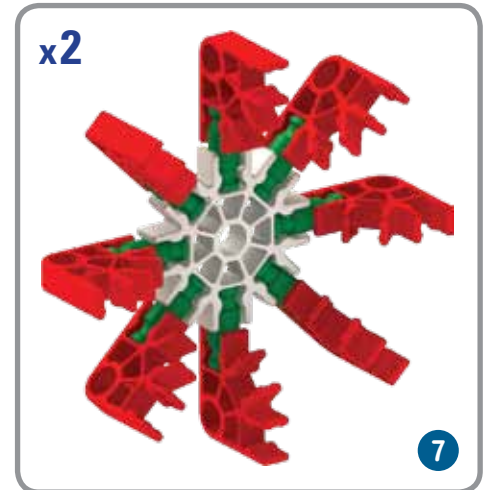
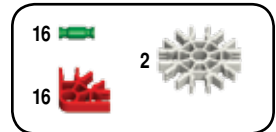

7

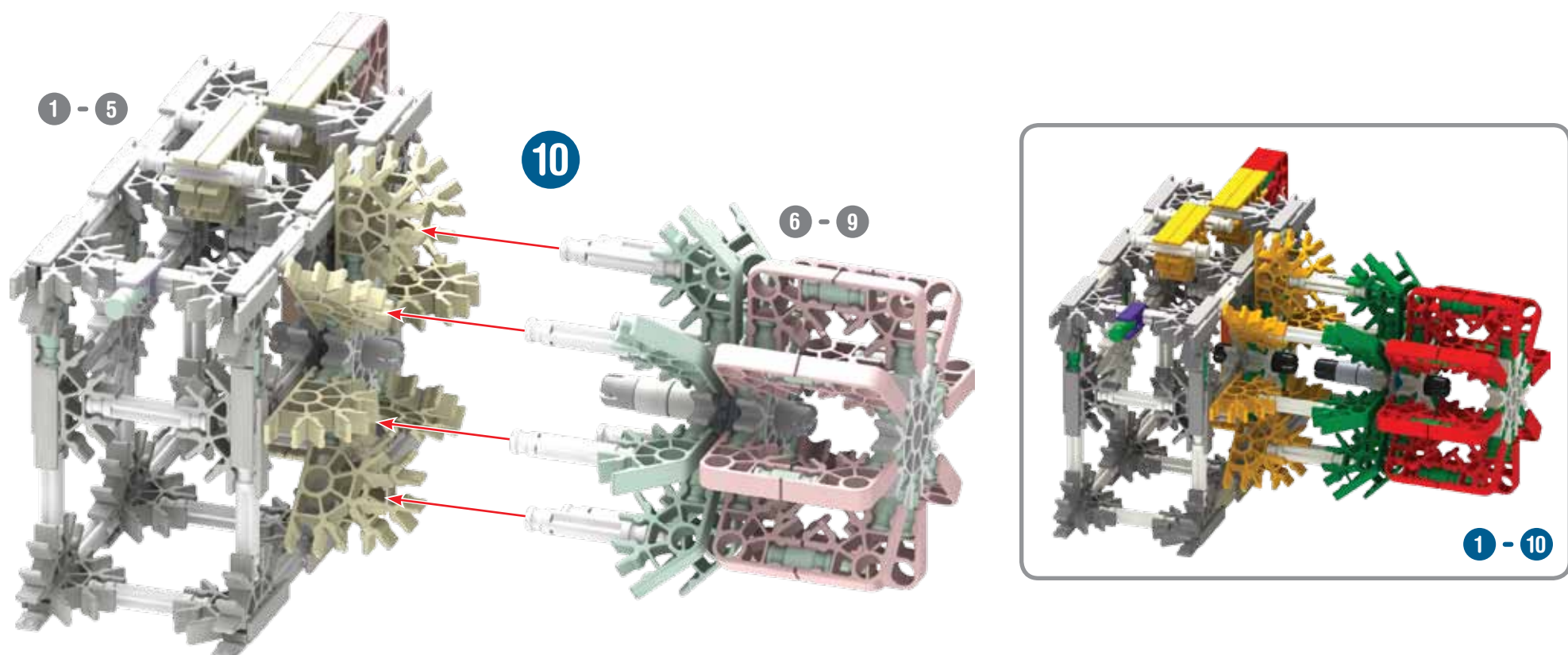
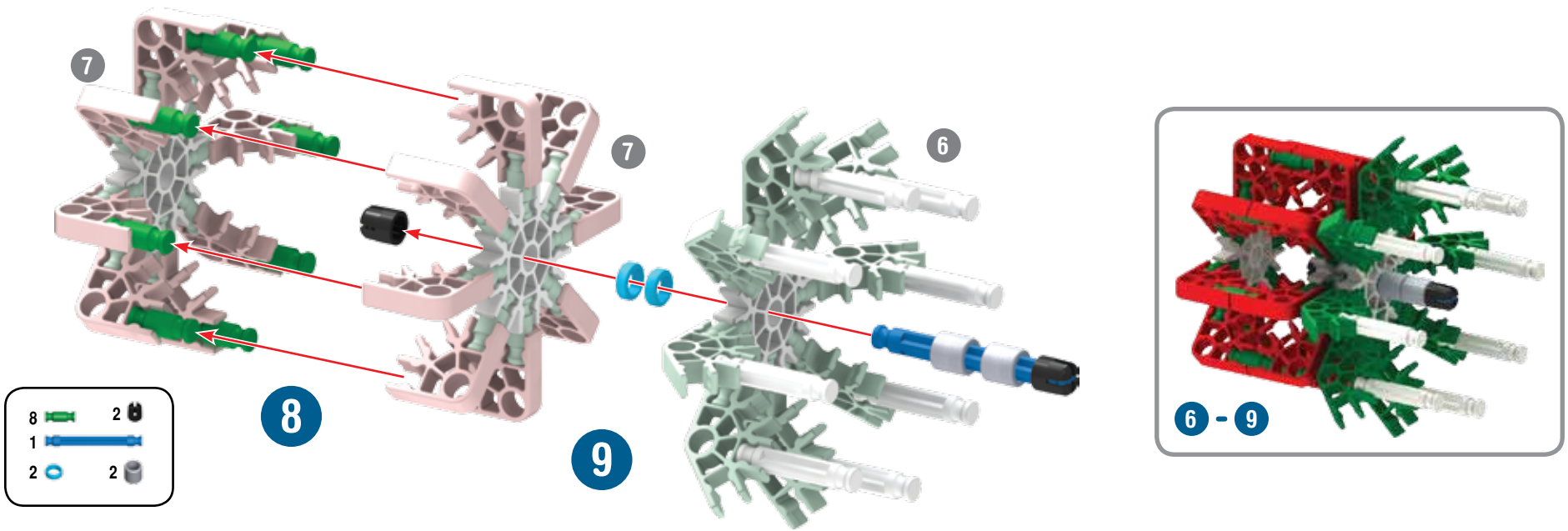

**5 MISCELLANEOUS**

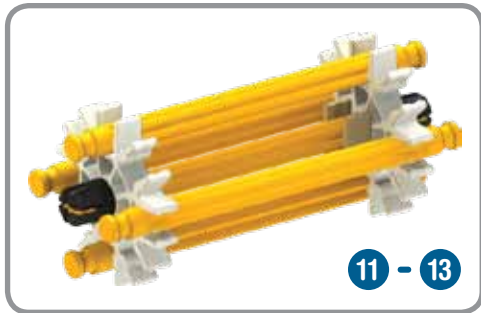
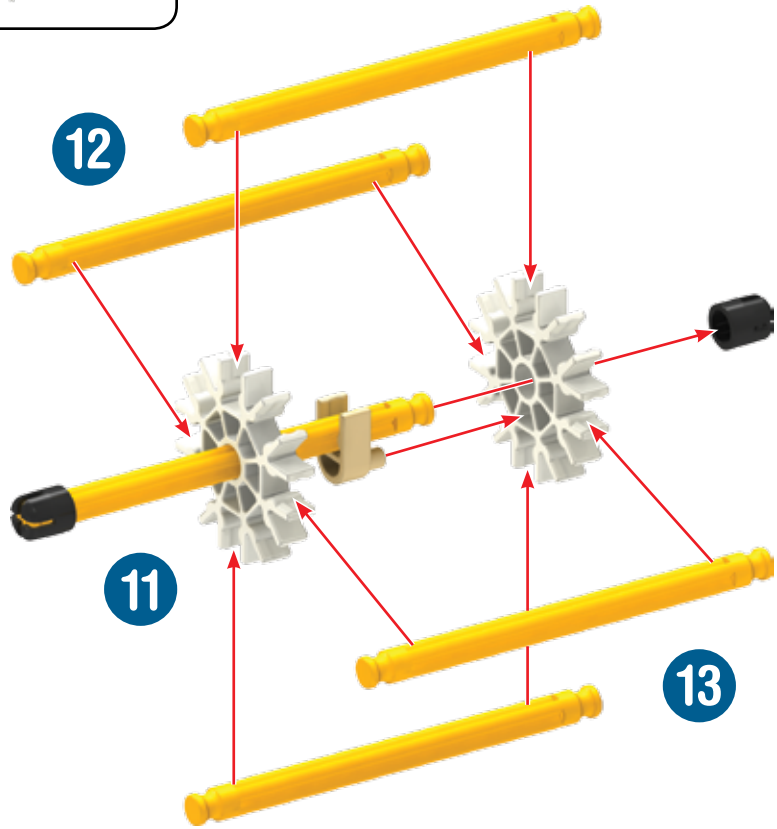
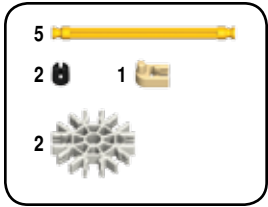

11 - 13

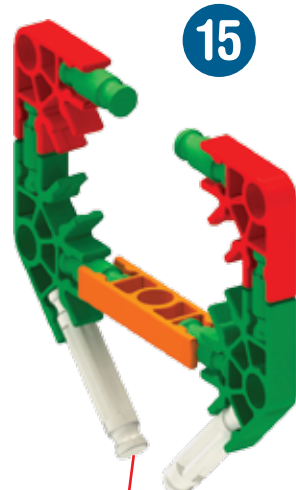
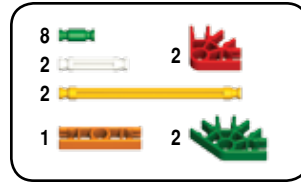

15



11 - 15

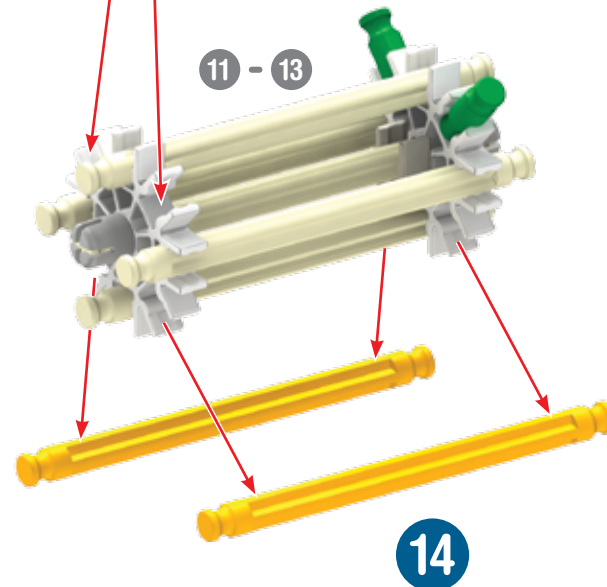

11 - 13

14

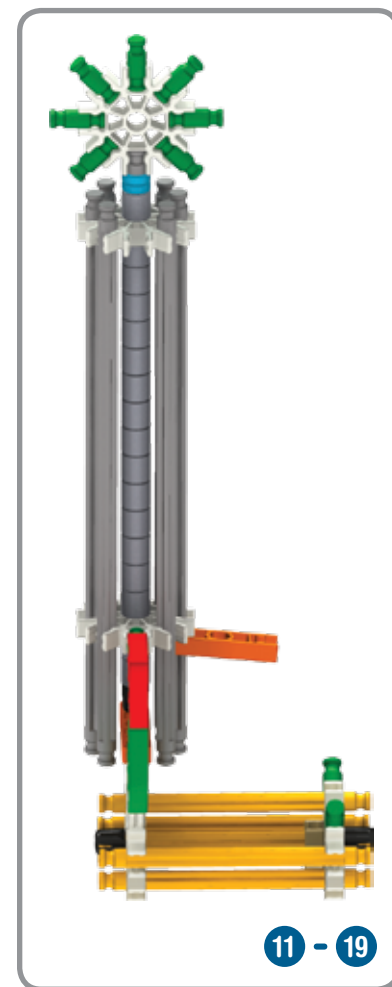
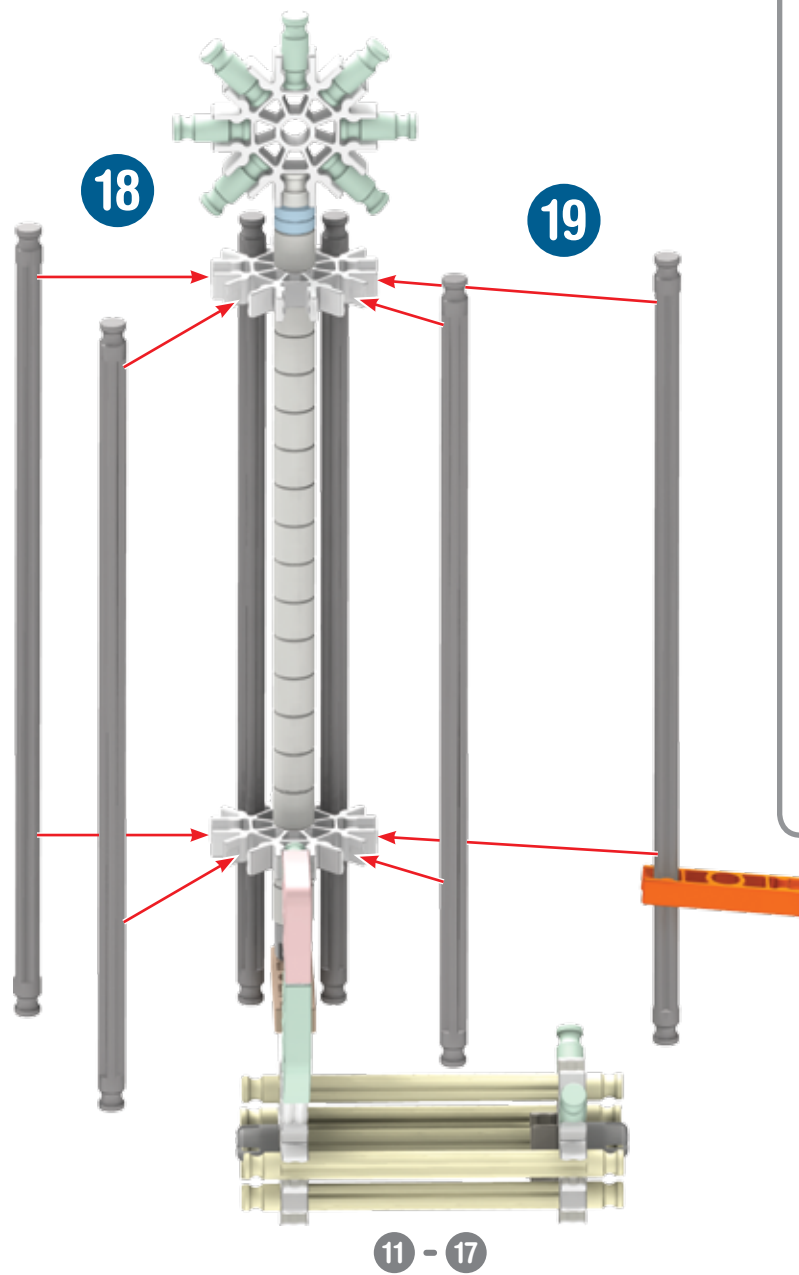
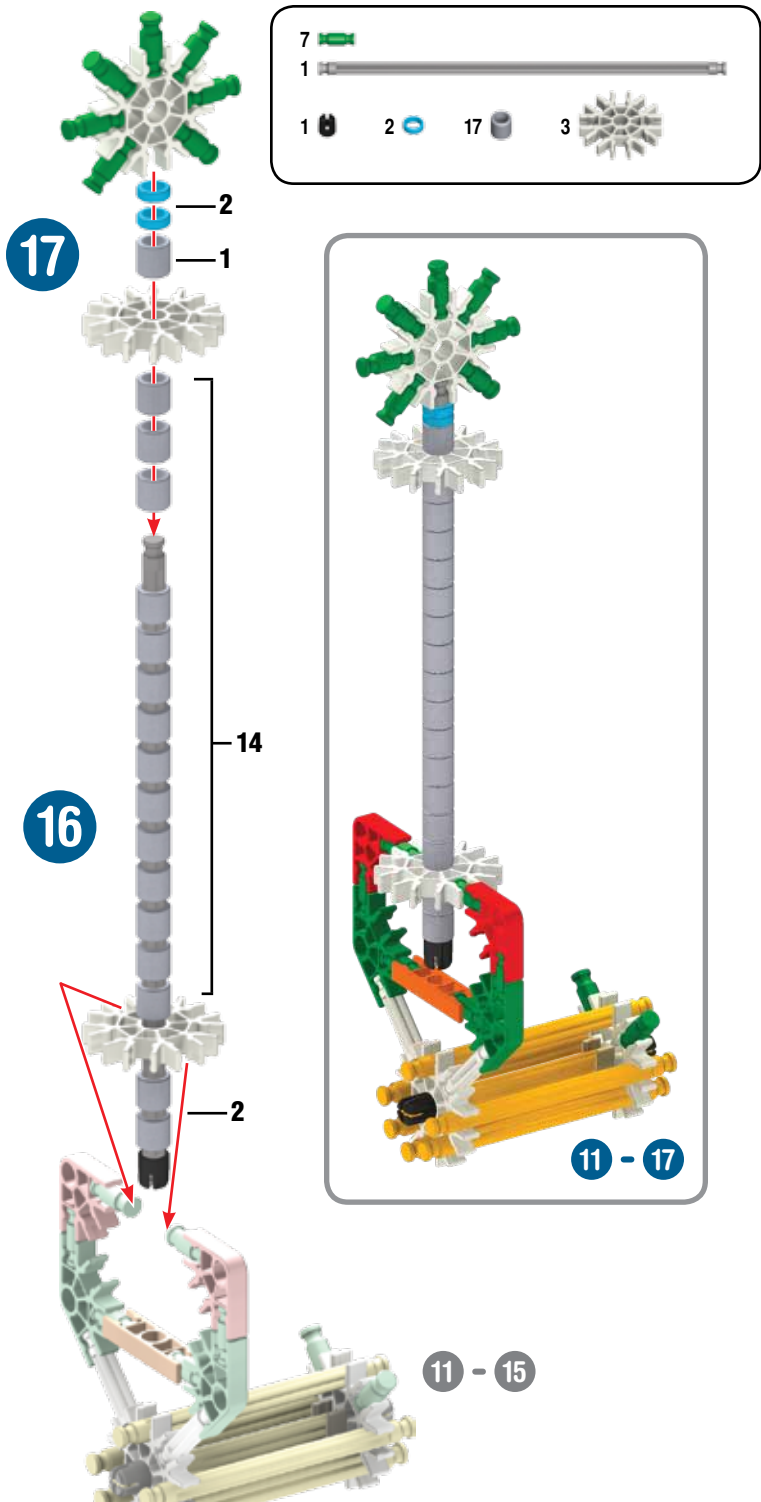



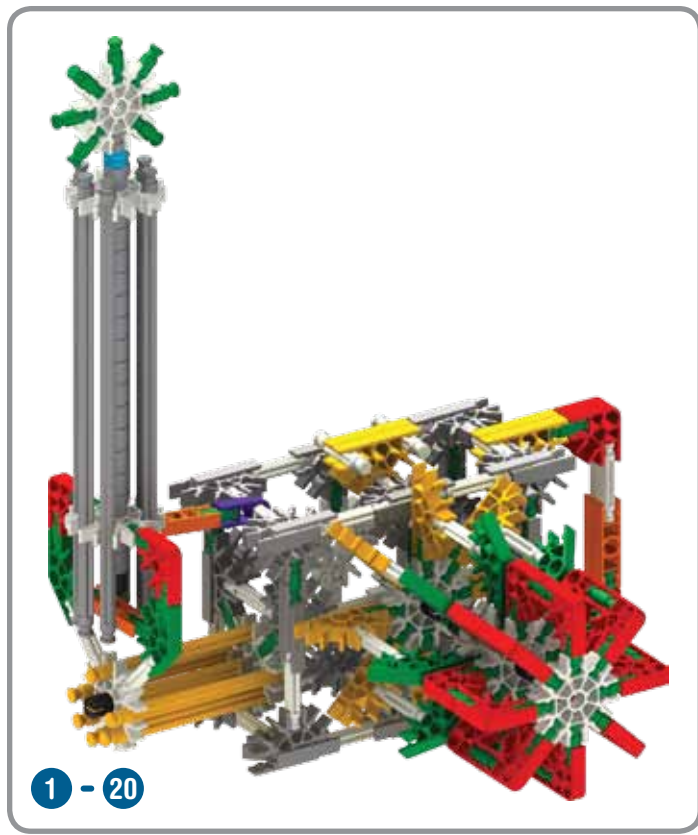
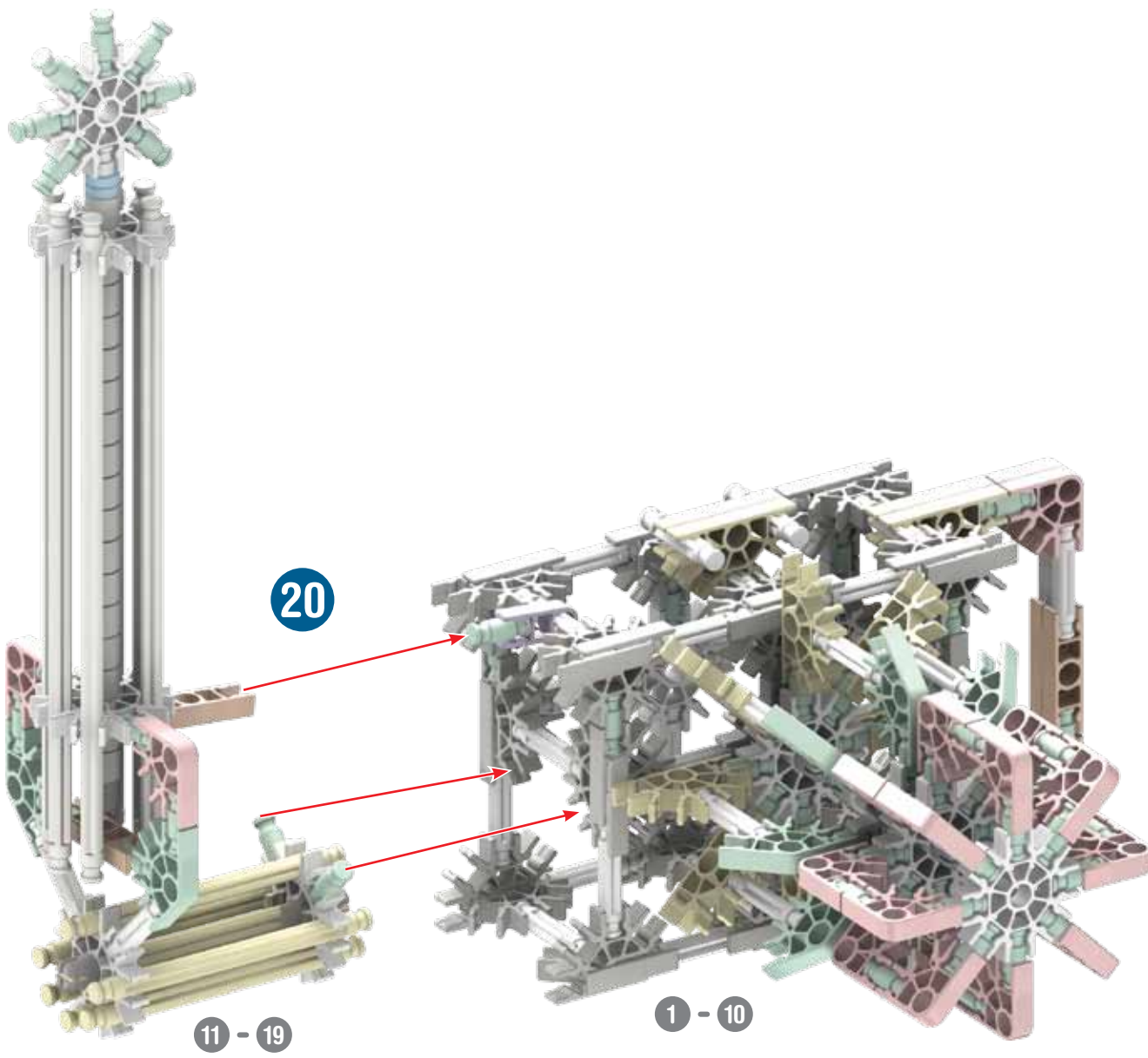

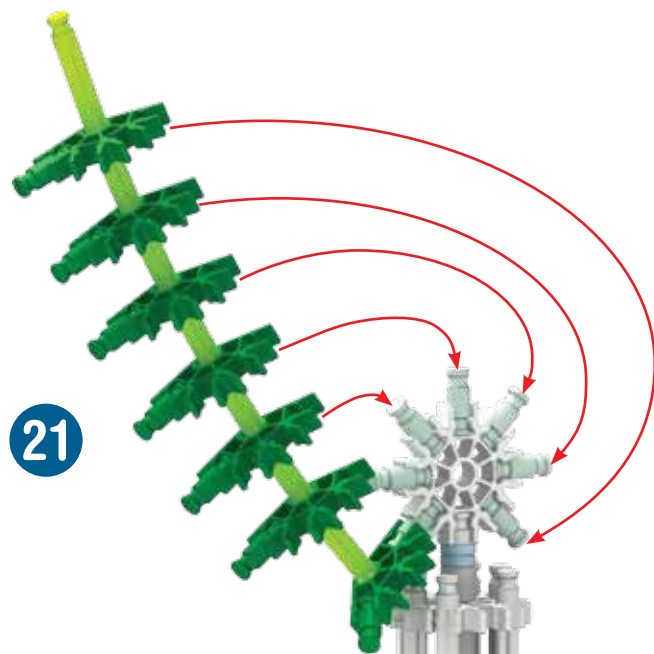

- 7
- 1
- 7

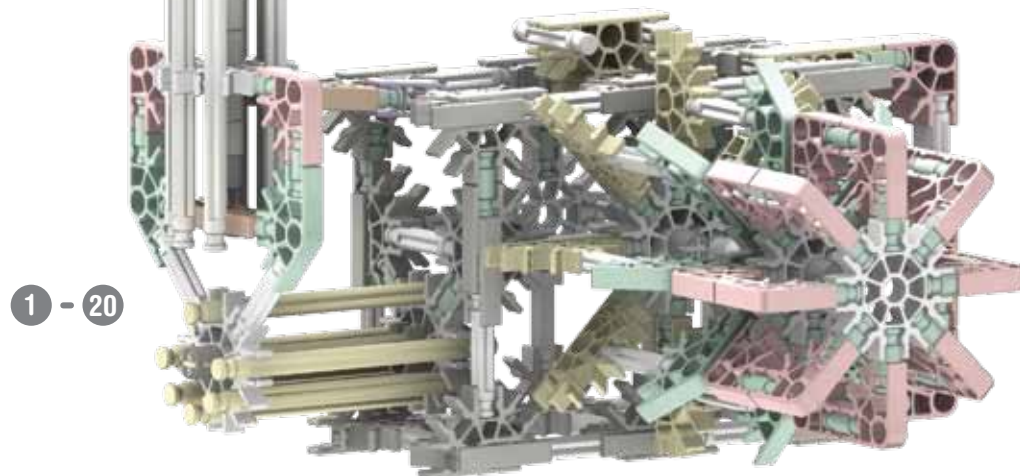
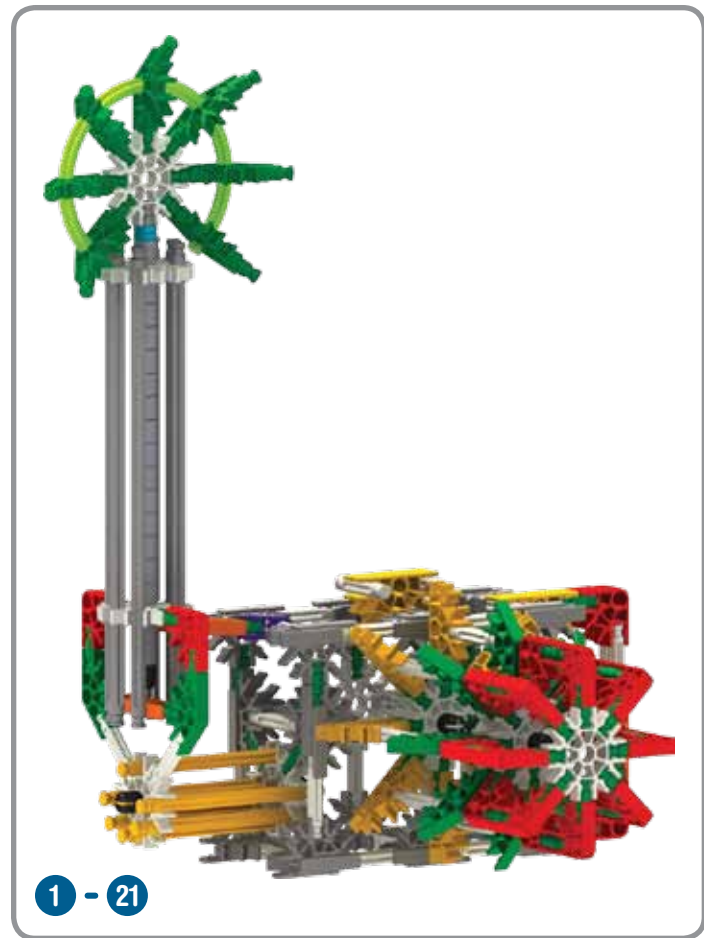

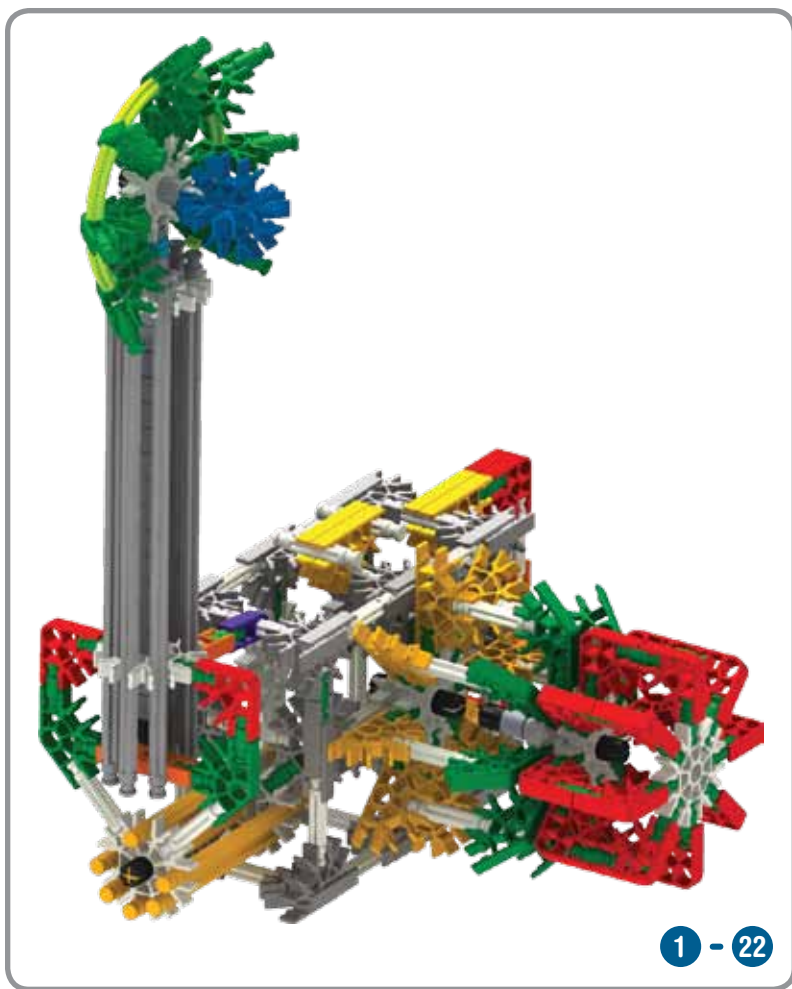
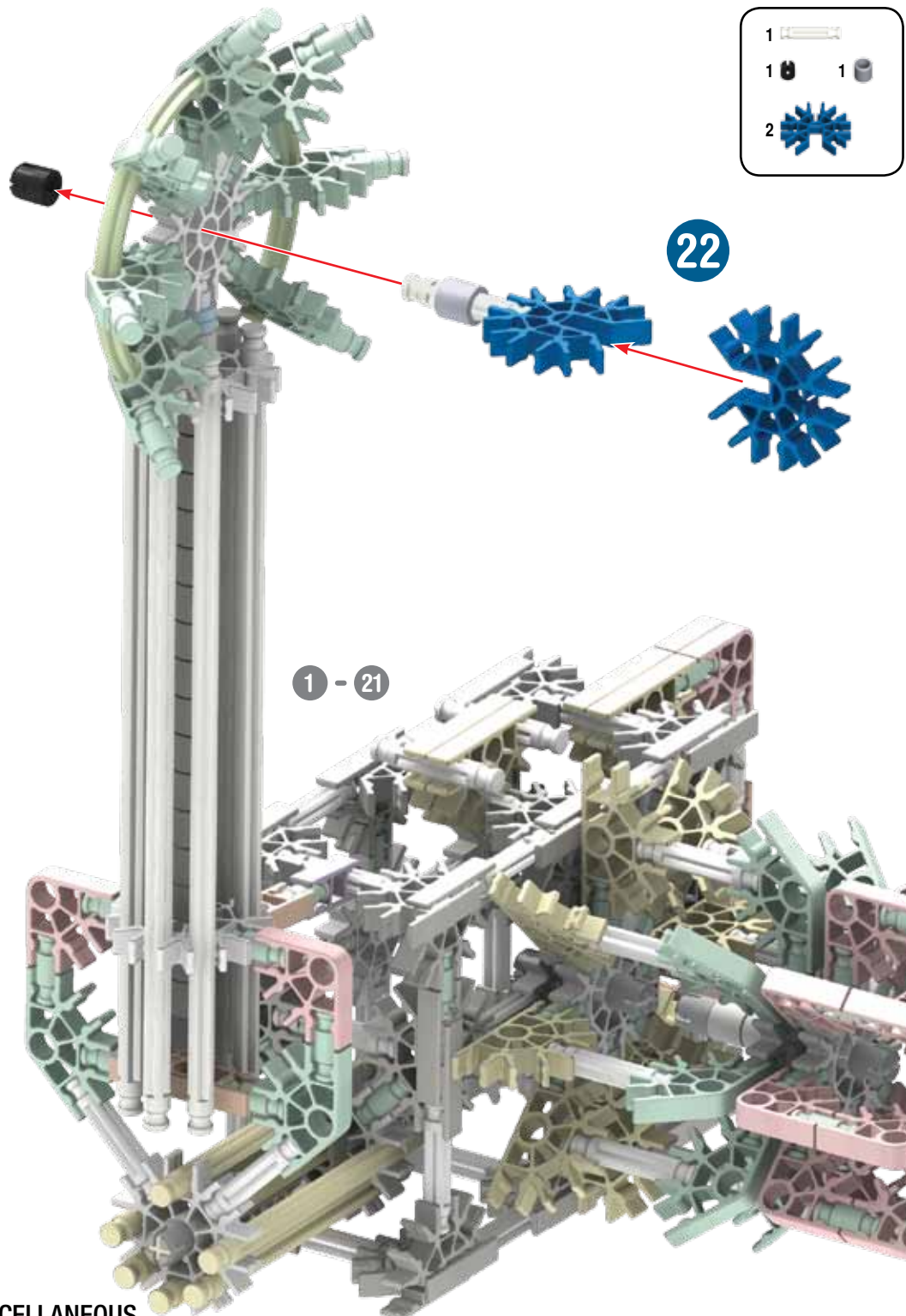

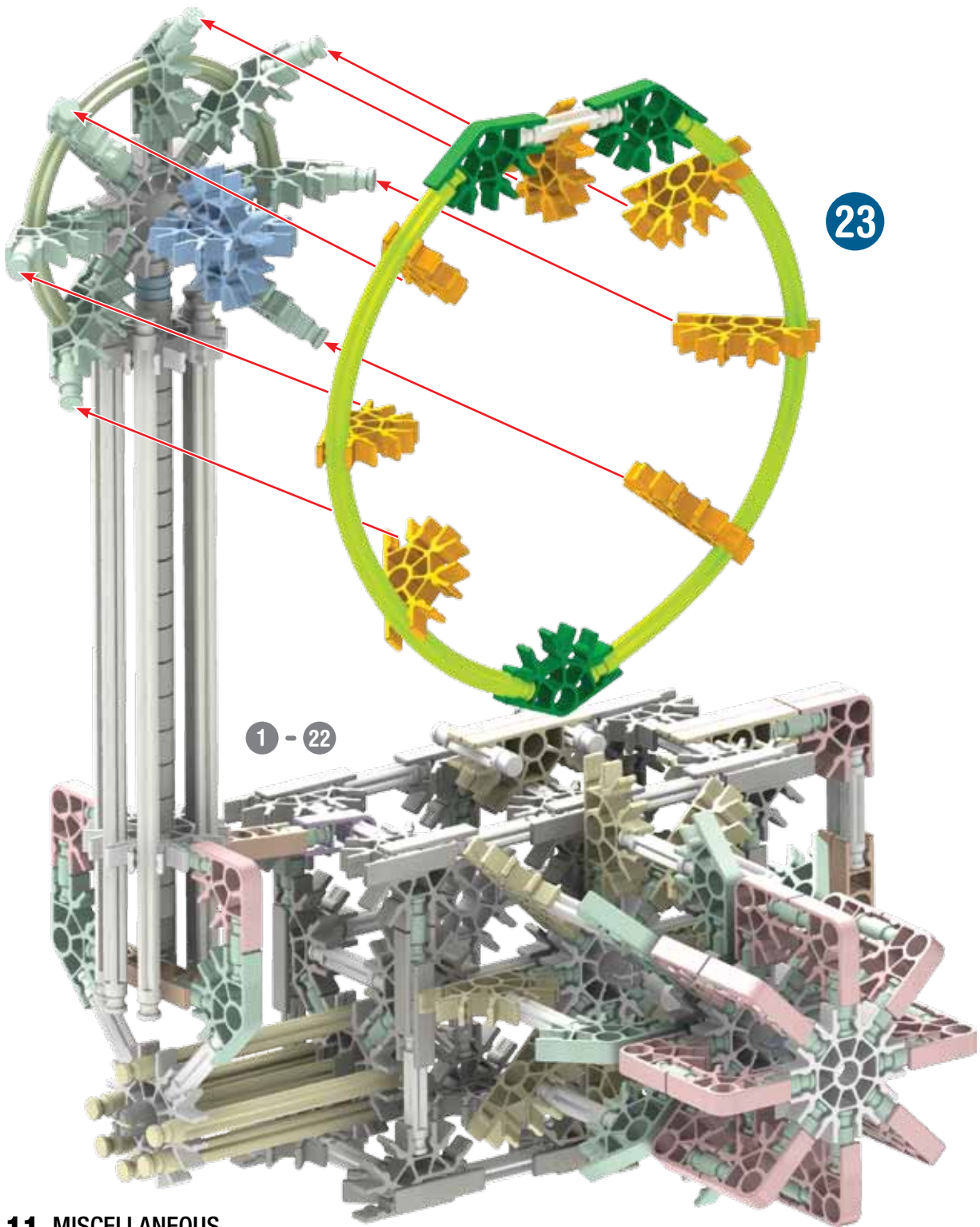

23

1 - 22



Camera

1 - 23

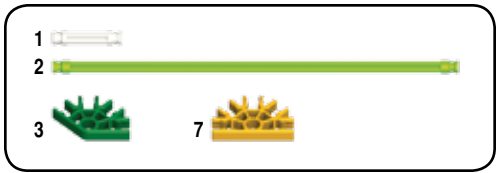

# Car

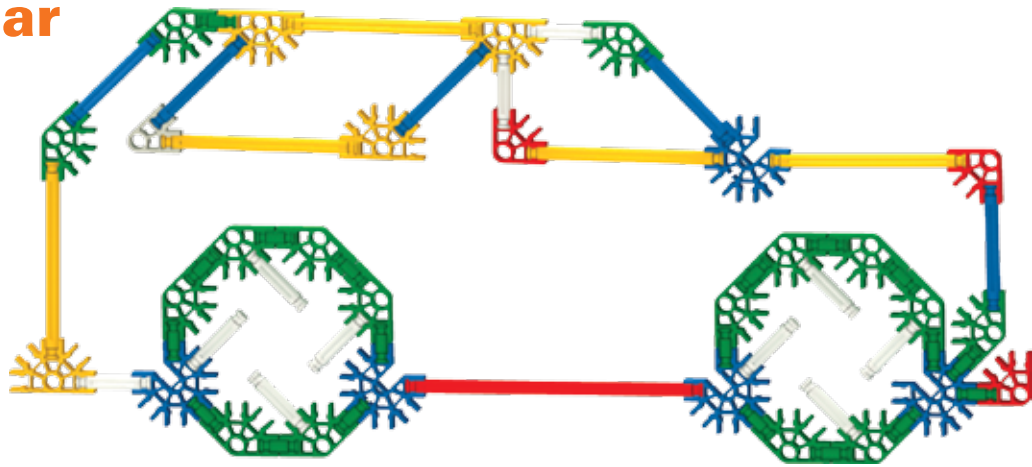

19		4		5	
11					
5					
5					
1					
1		3		16	

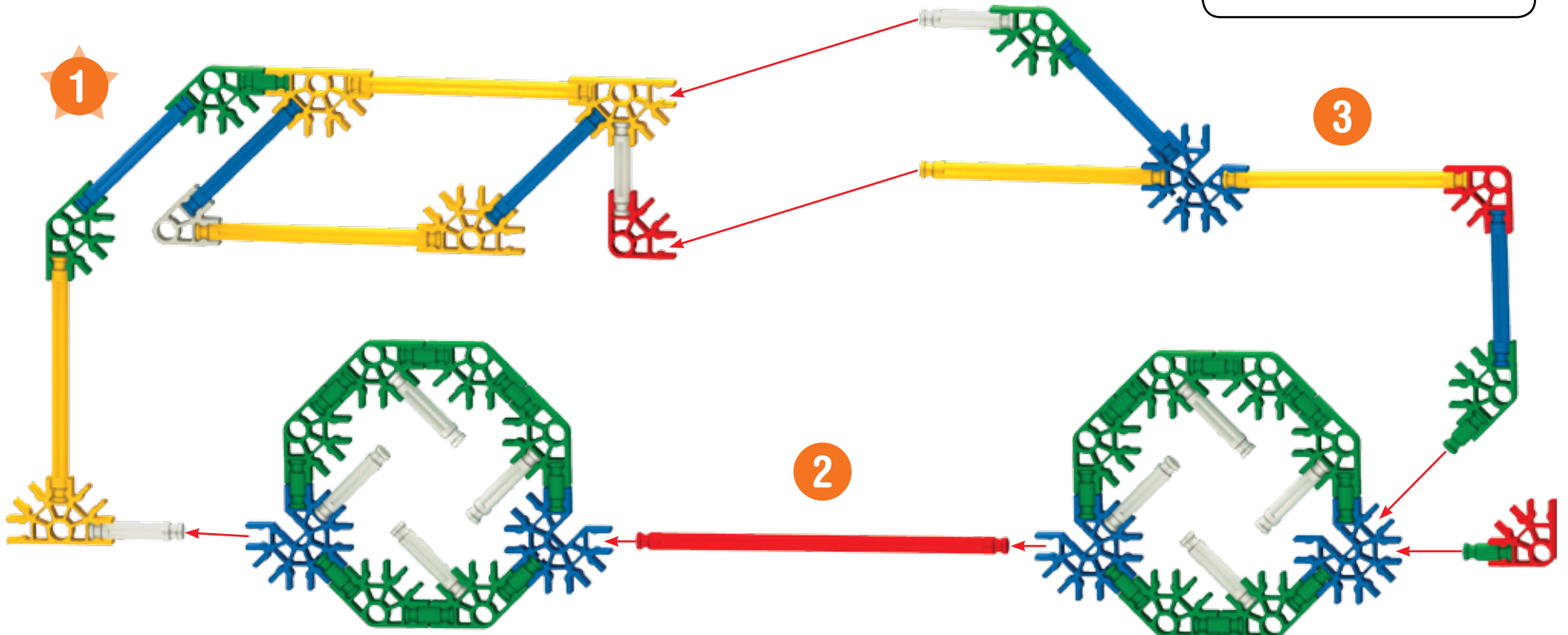

# Drum Kit

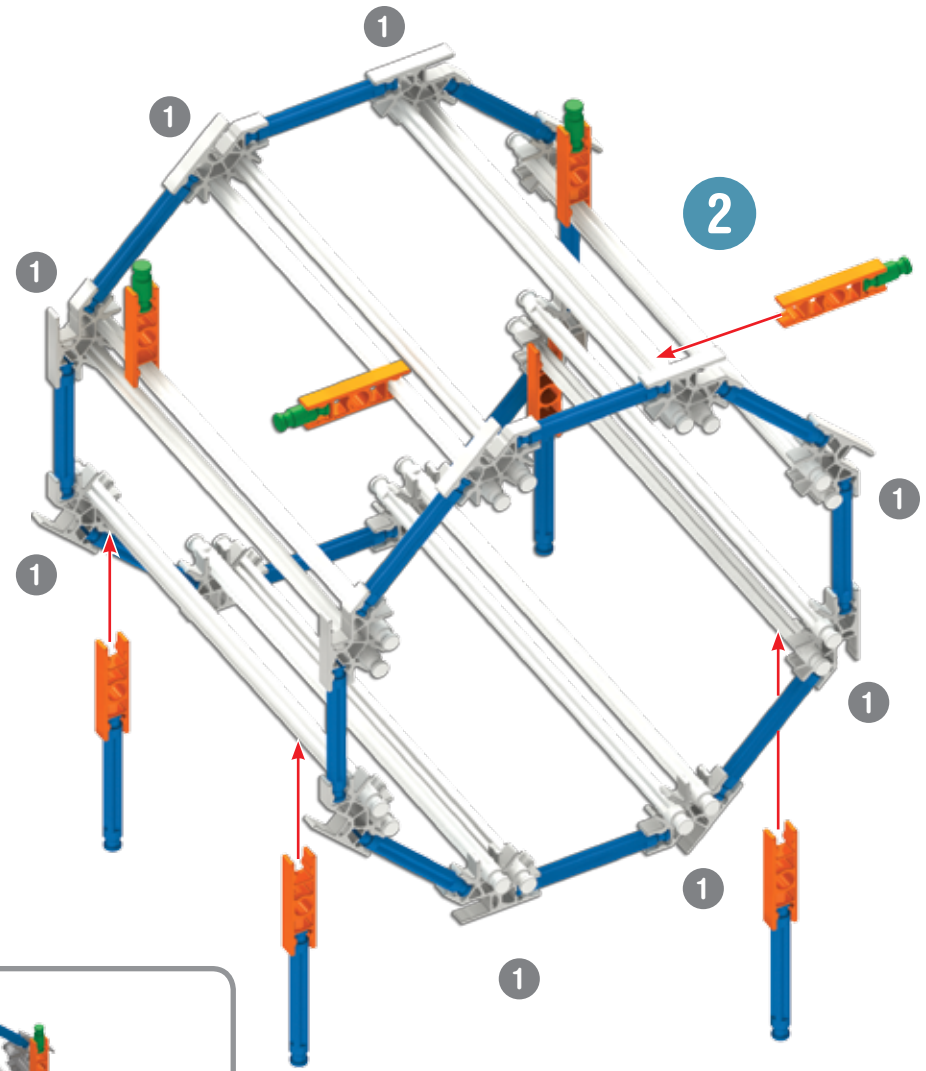
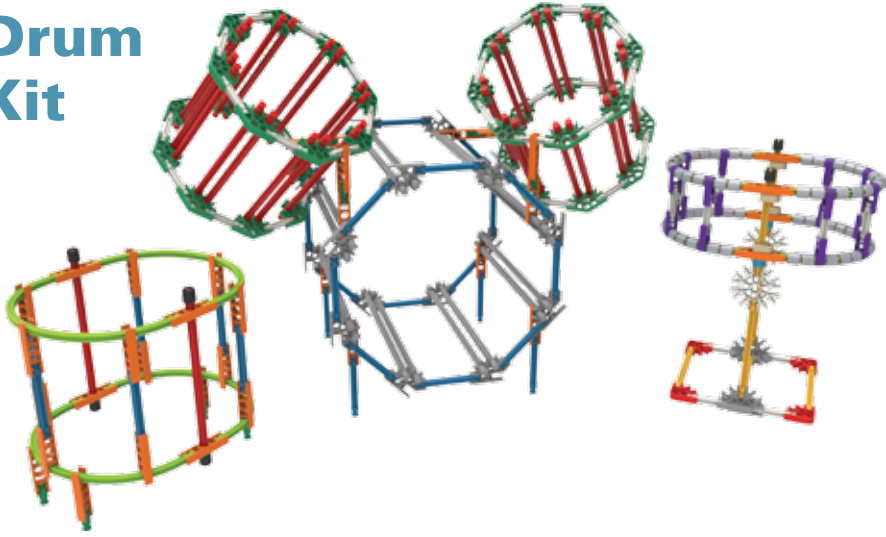

x8

1

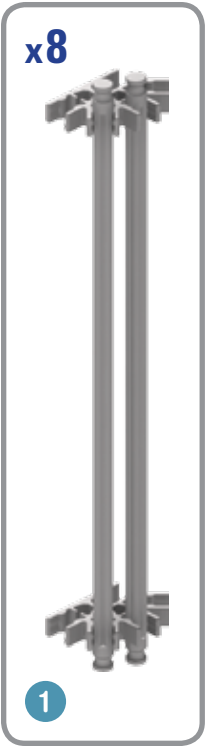

x8

1

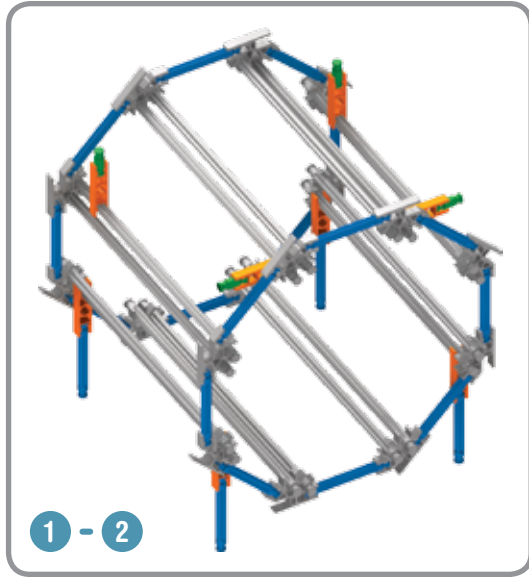

1 - 2

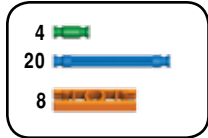

x16

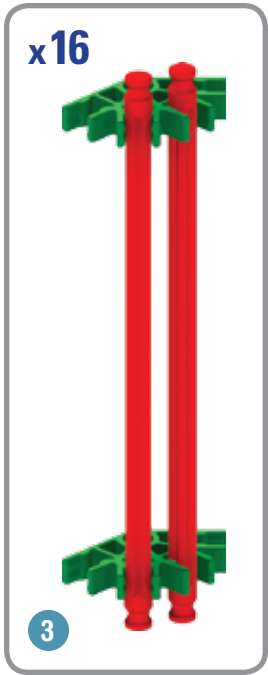
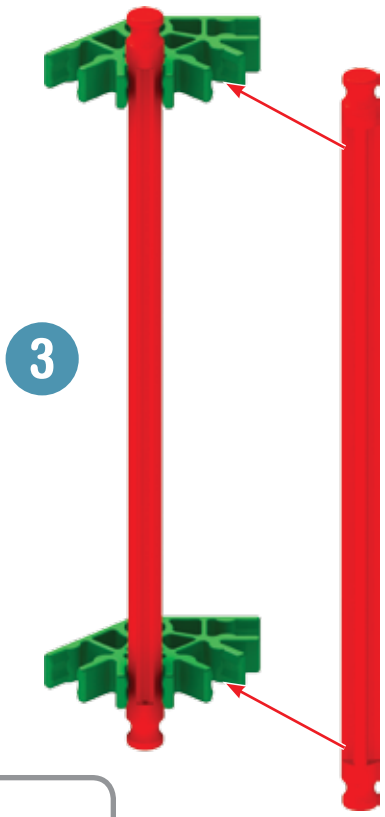

x2

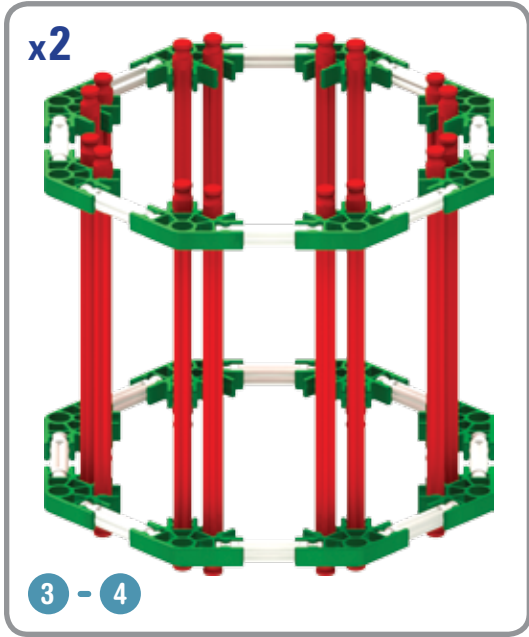
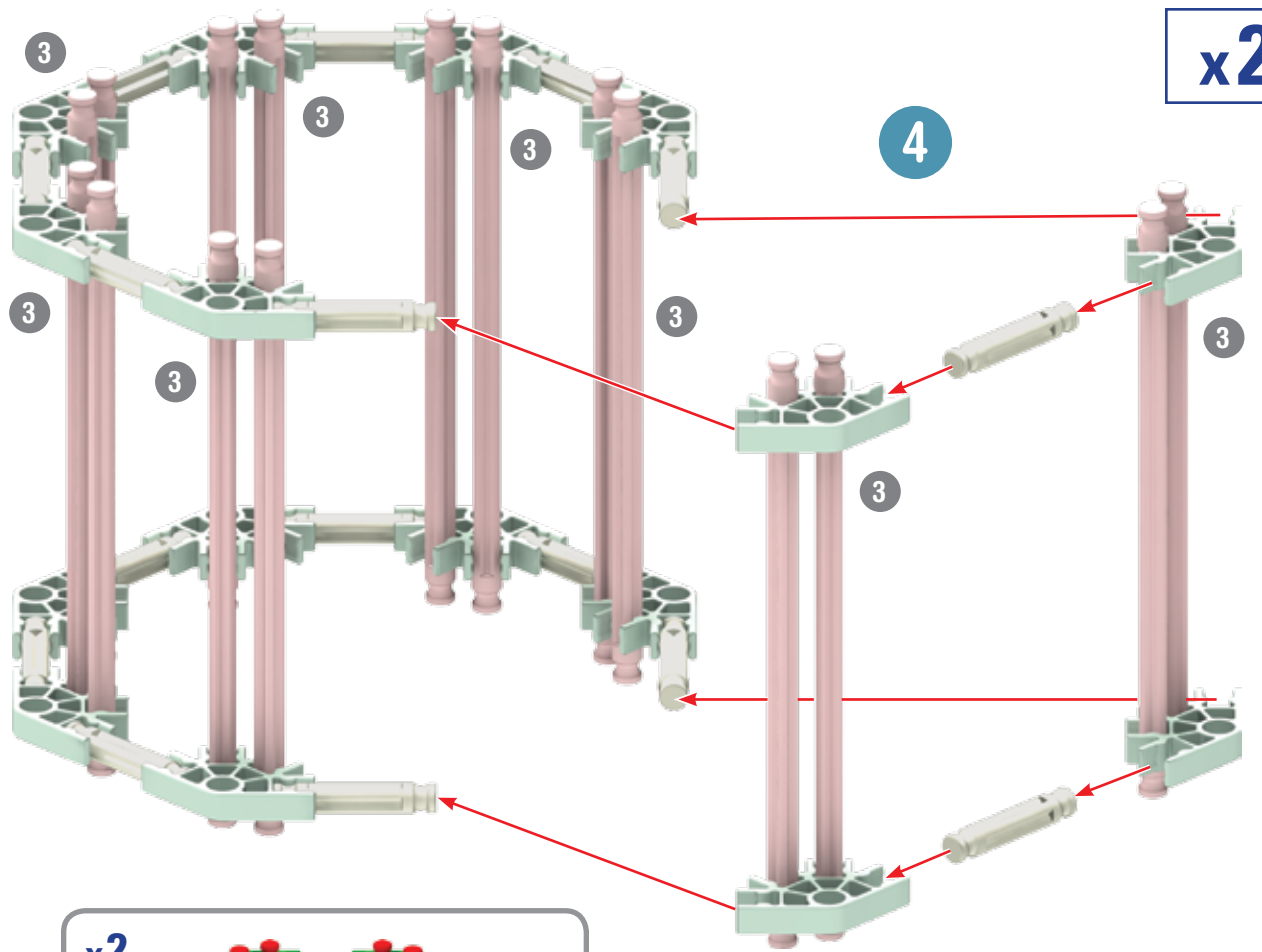

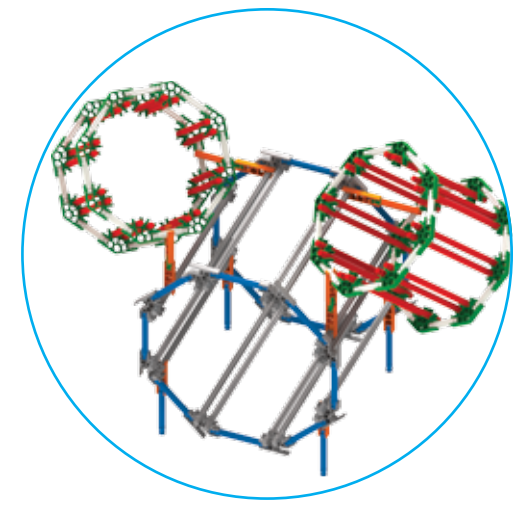
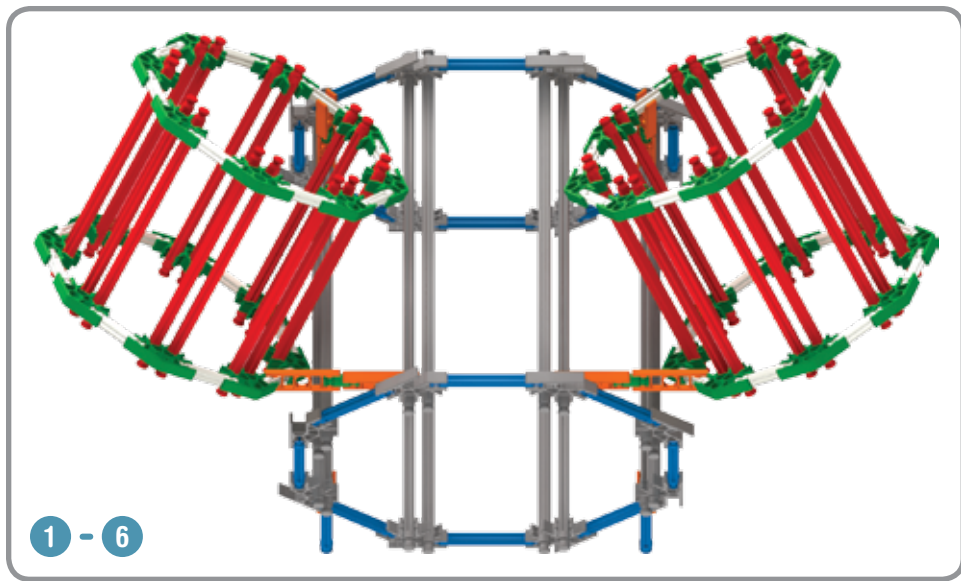
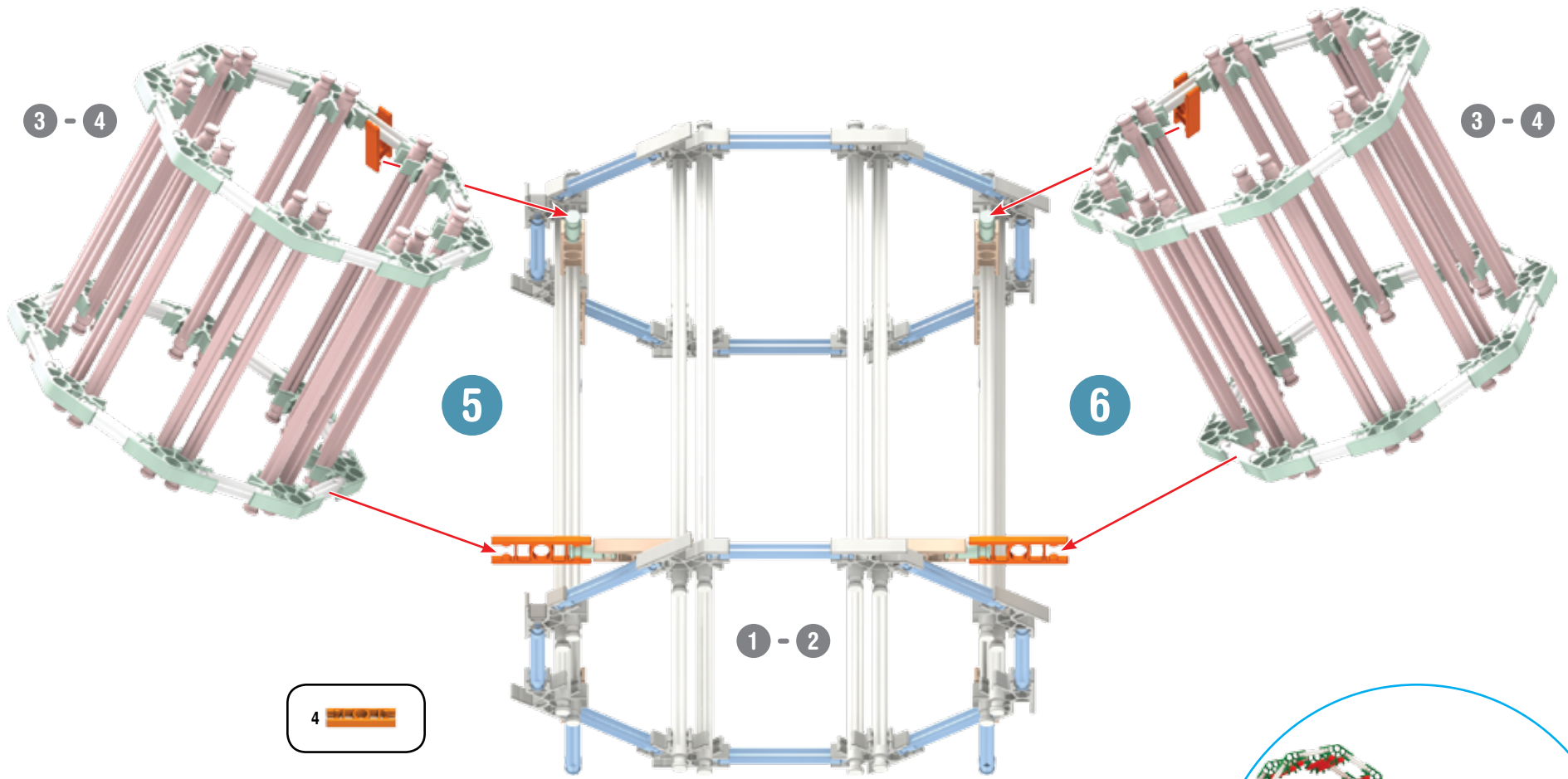



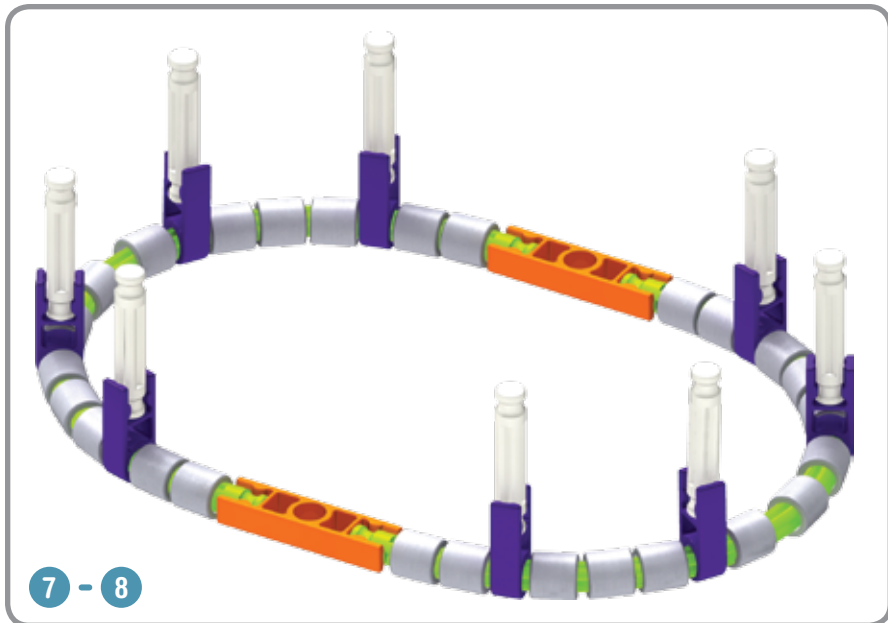
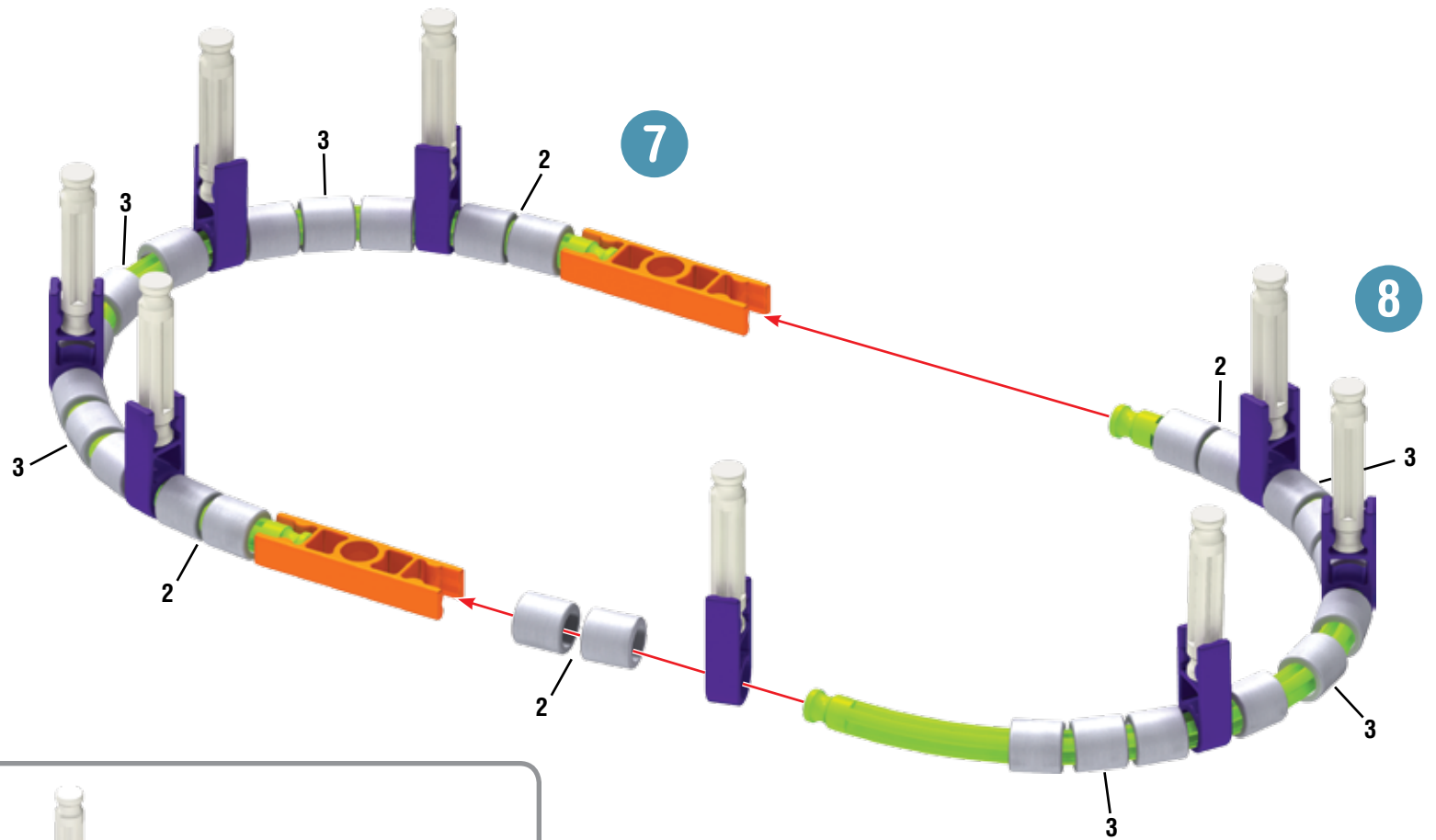

26		8		2	
8					
2					

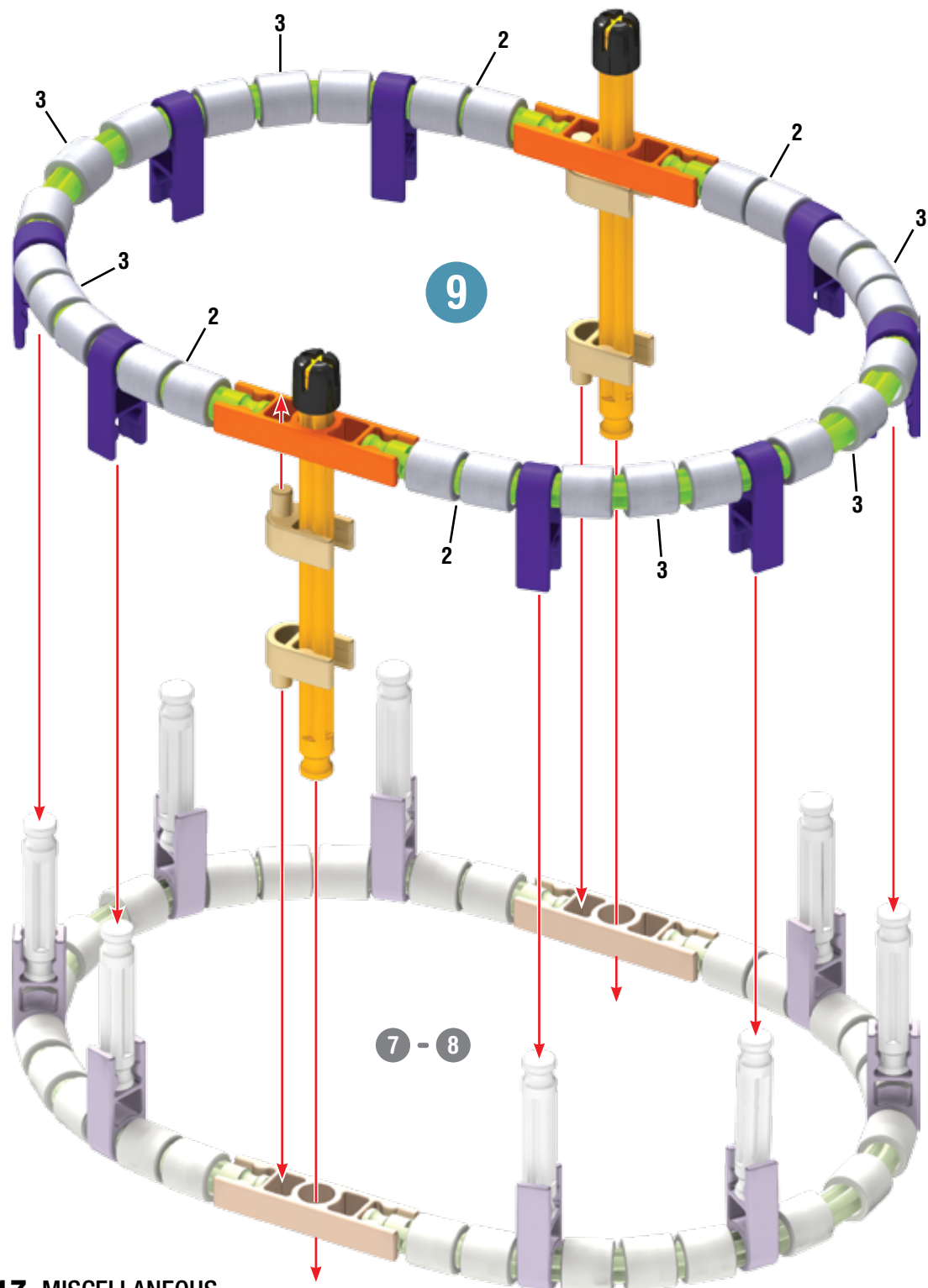

2		2		26	
2					
4		8		2	

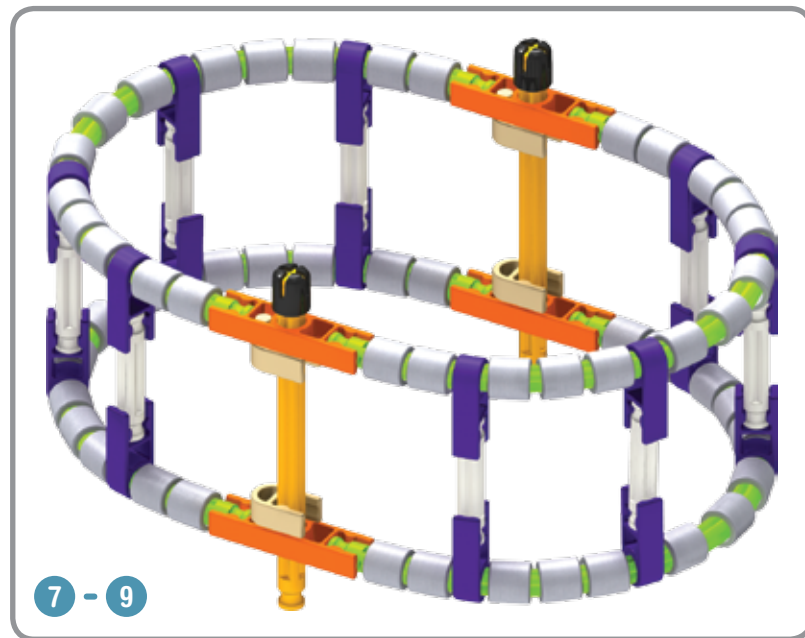

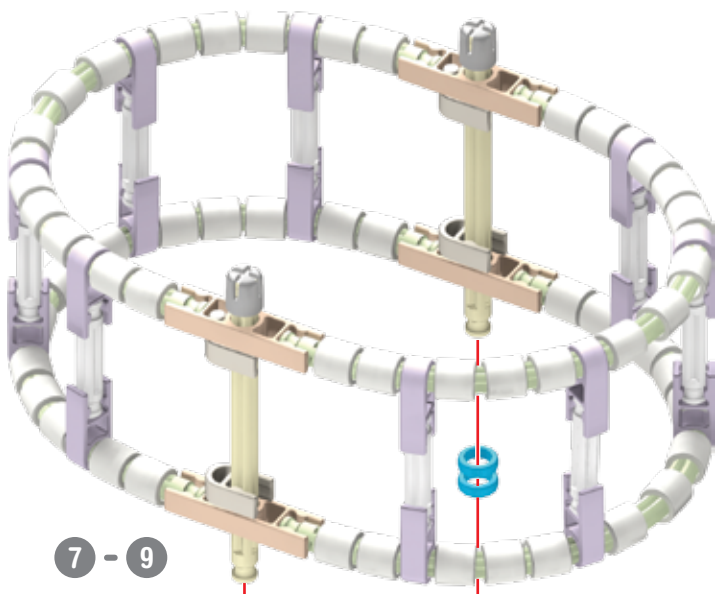

7 - 9

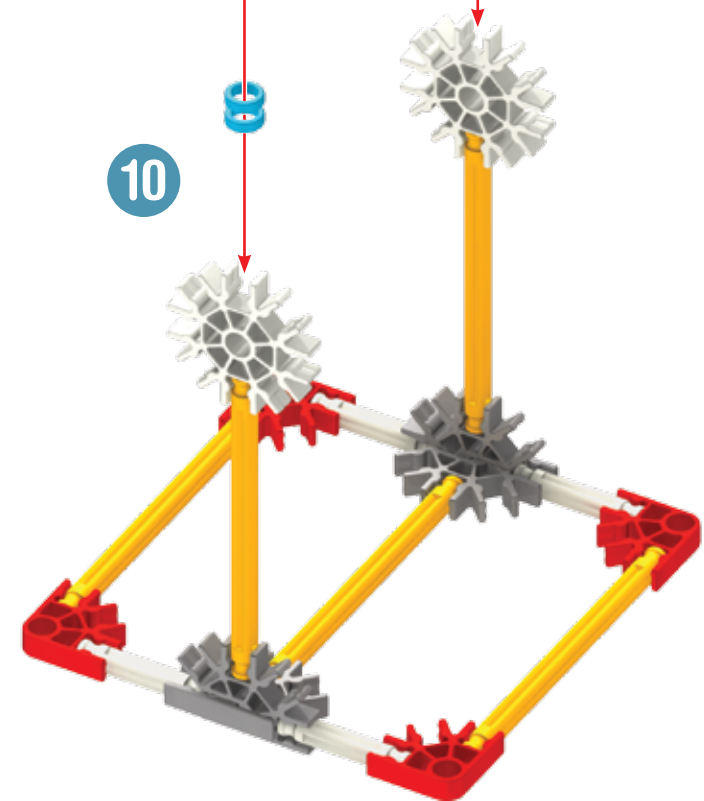

10

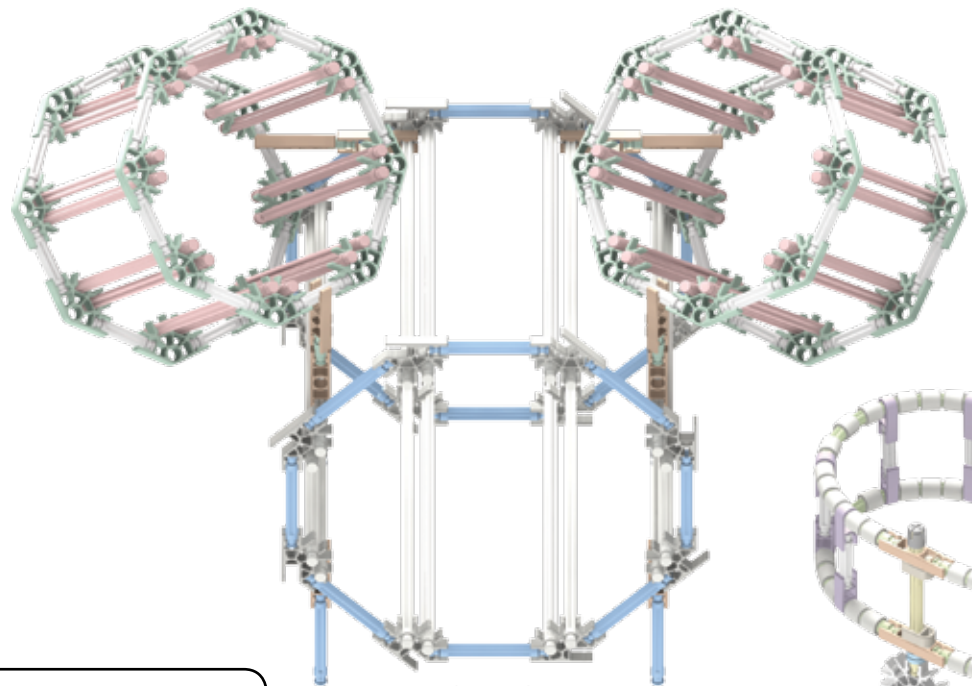

1 - 6



11

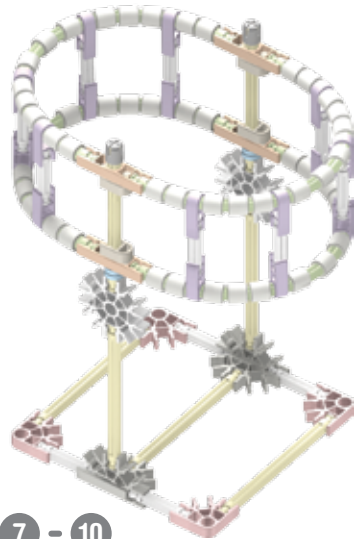

7 - 10

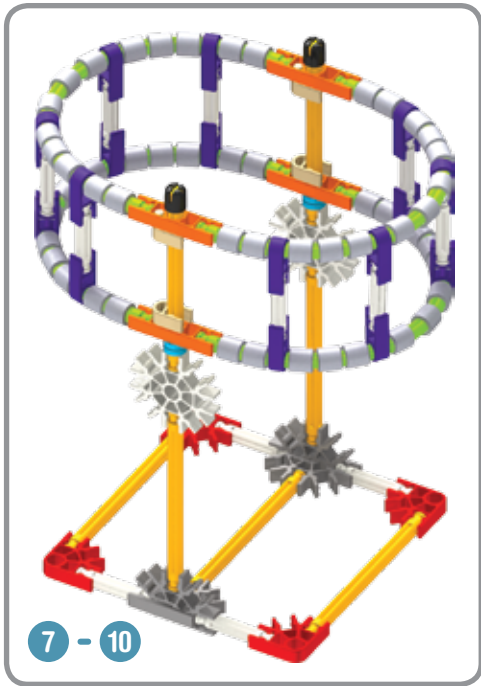

7 - 10

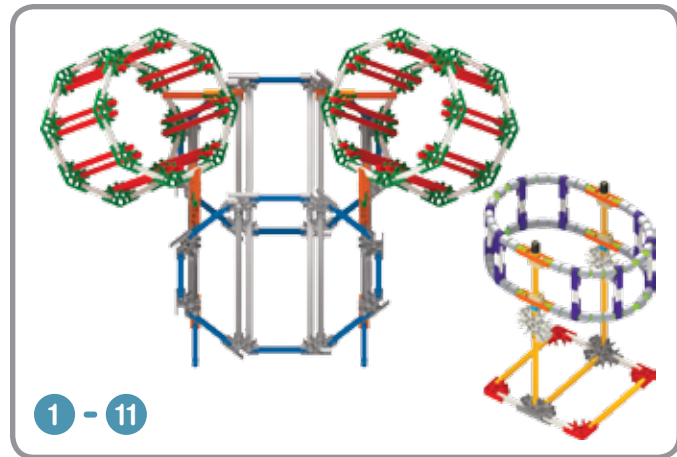

1 - 11

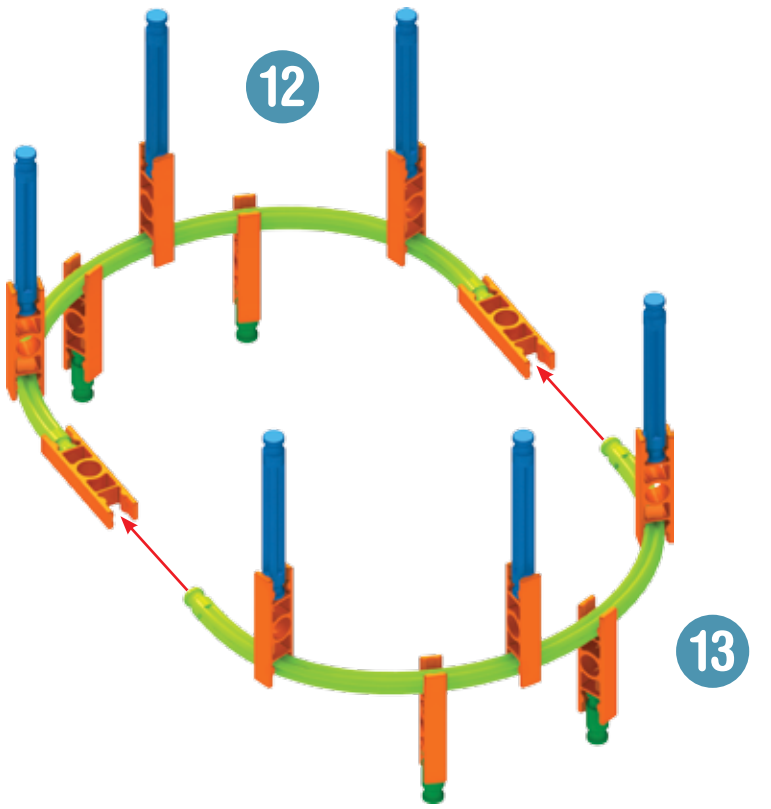

12

13

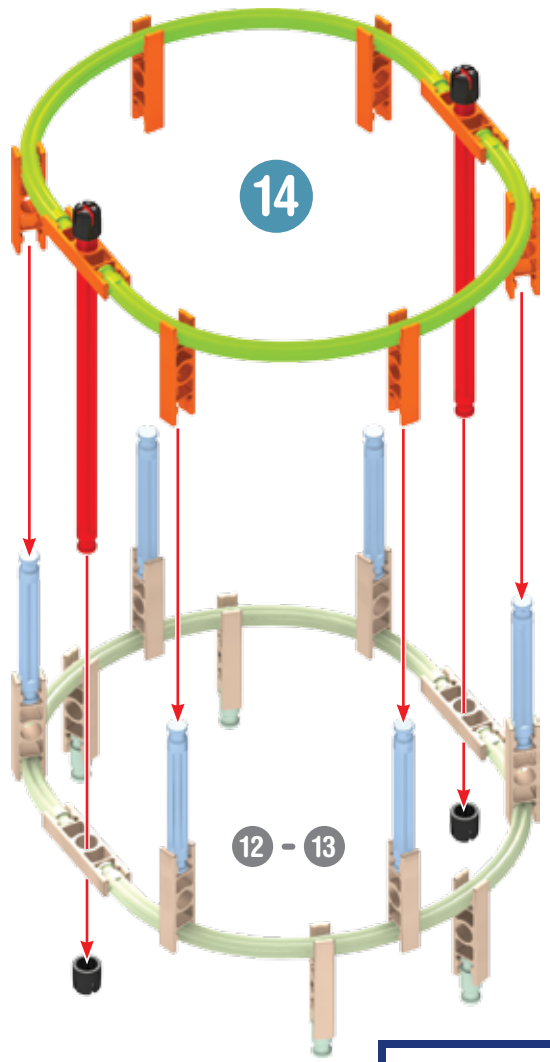
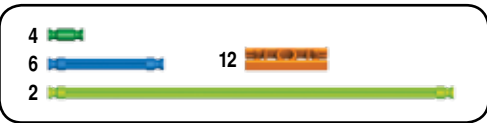

14

12 - 13

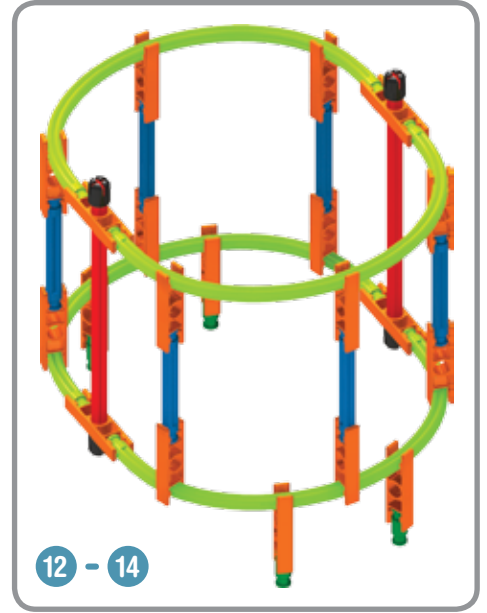
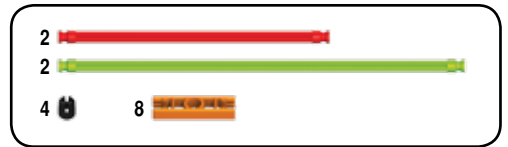

12 - 14

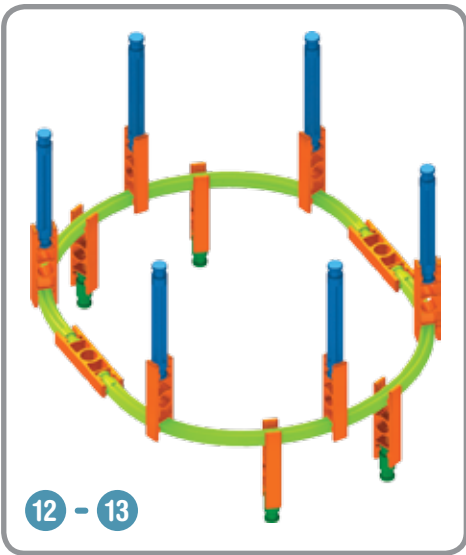

12 - 13

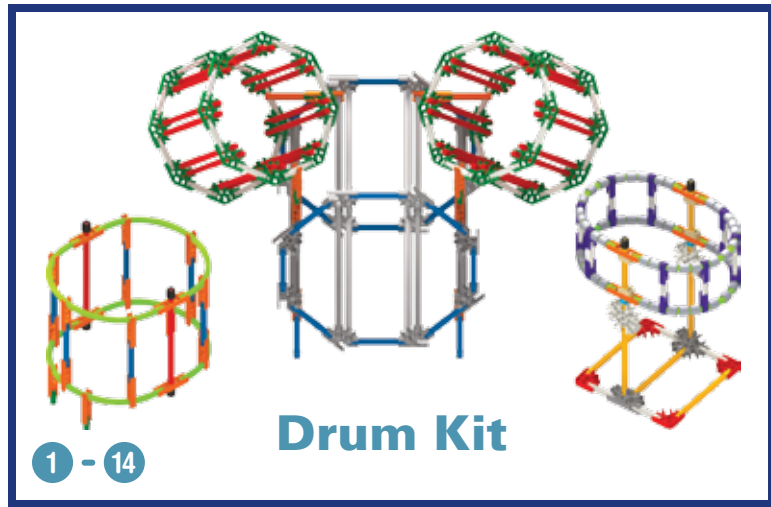

1 - 14

Drum Kit

# Flick Cannon

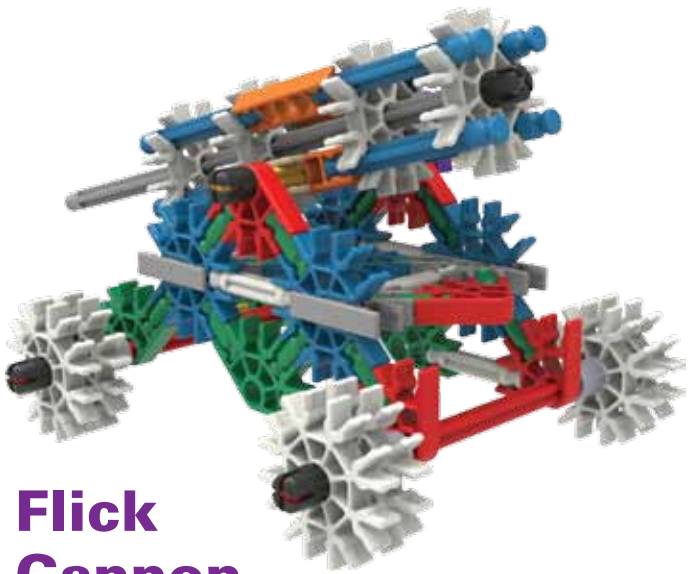

- |    |  |   |  |   |  |
|----|--|---|--|---|--|
| 16 |  | 4 |  | 5 |  |
| 4  |  | 4 |  | 4 |  |
| 1  |  | 4 |  |   |  |

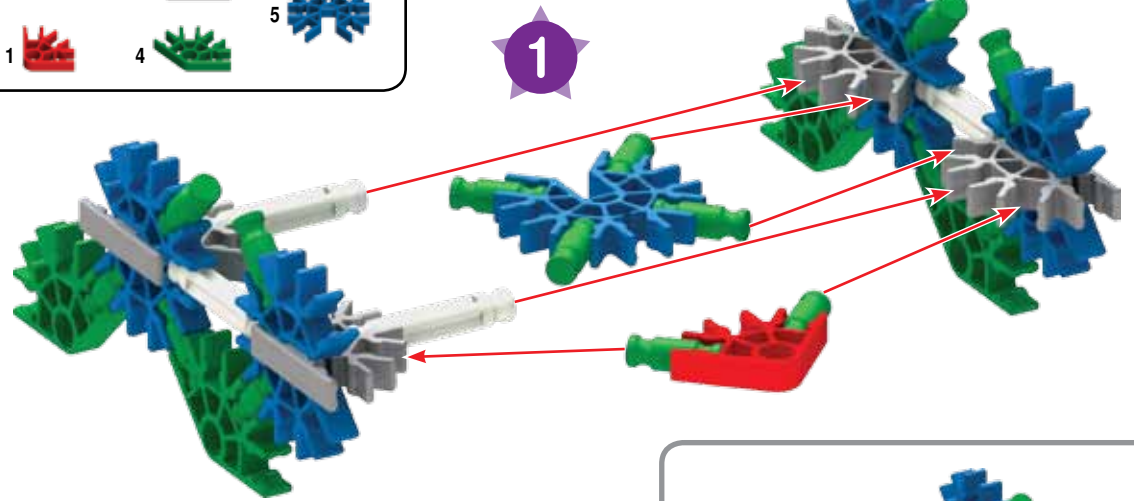

**CAUTION:** Do not launch in the direction of people, animals, or walls; You could cause injury or damage. Never attempt to launch any projectile other than the intended K'NEX projectile. Do not aim K'NEX projectile at eyes or face.

**ATTENTION :** Ne pas lancer en direction des personnes, des animaux ni des murs. Risque de blessure ou d'endommagement. Ne jamais tenter de lancer un projectile quelconque autre que le projectile K'NEX prévu. Ne pas viser projectile K'NEX aux yeux ou le visage.

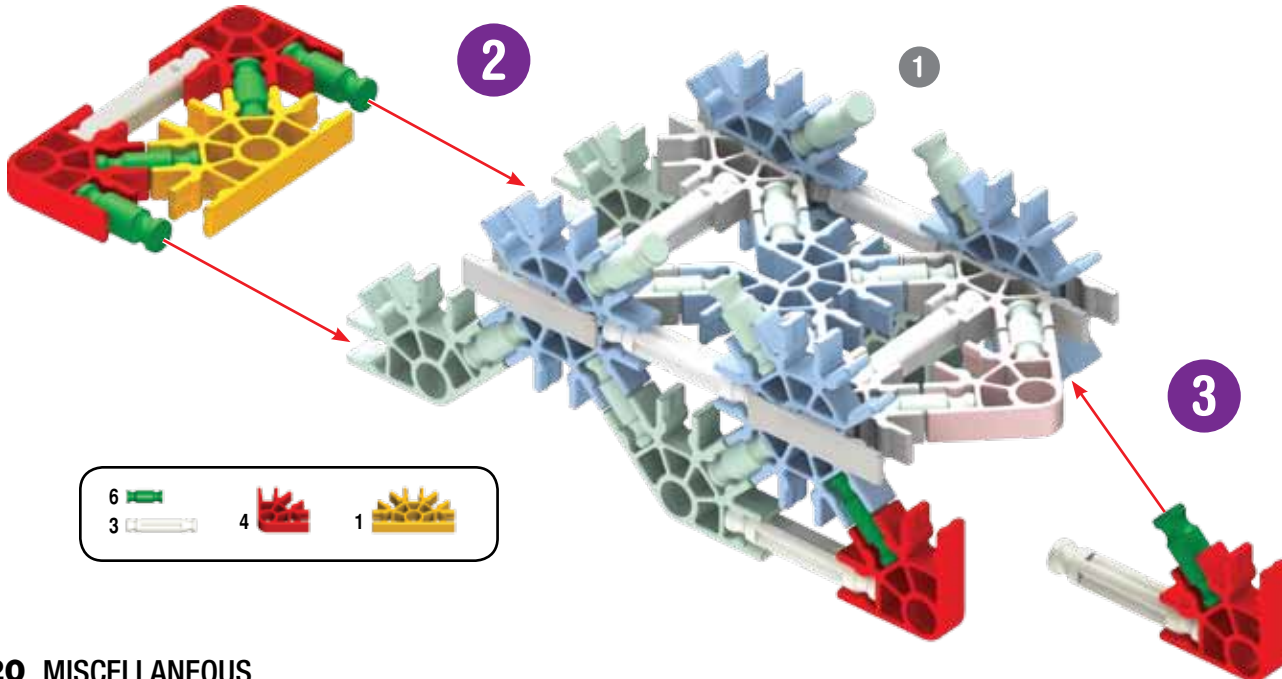
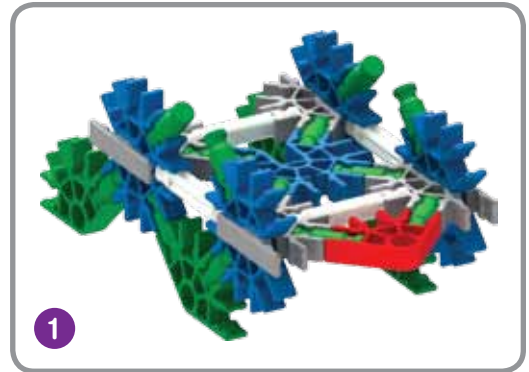

- |   |  |   |  |   |  |
|---|--|---|--|---|--|
| 6 |  | 4 |  | 1 |  |
| 3 |  |   |  |   |  |

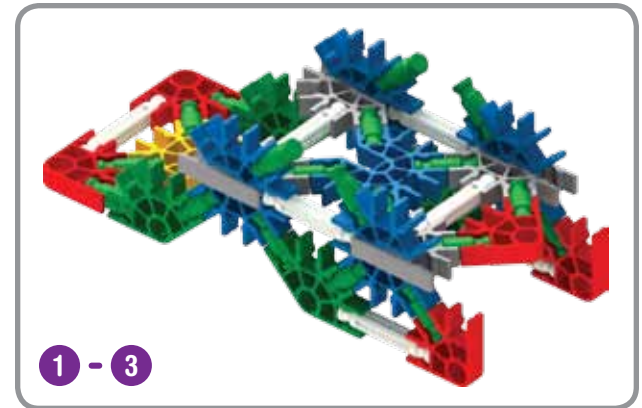

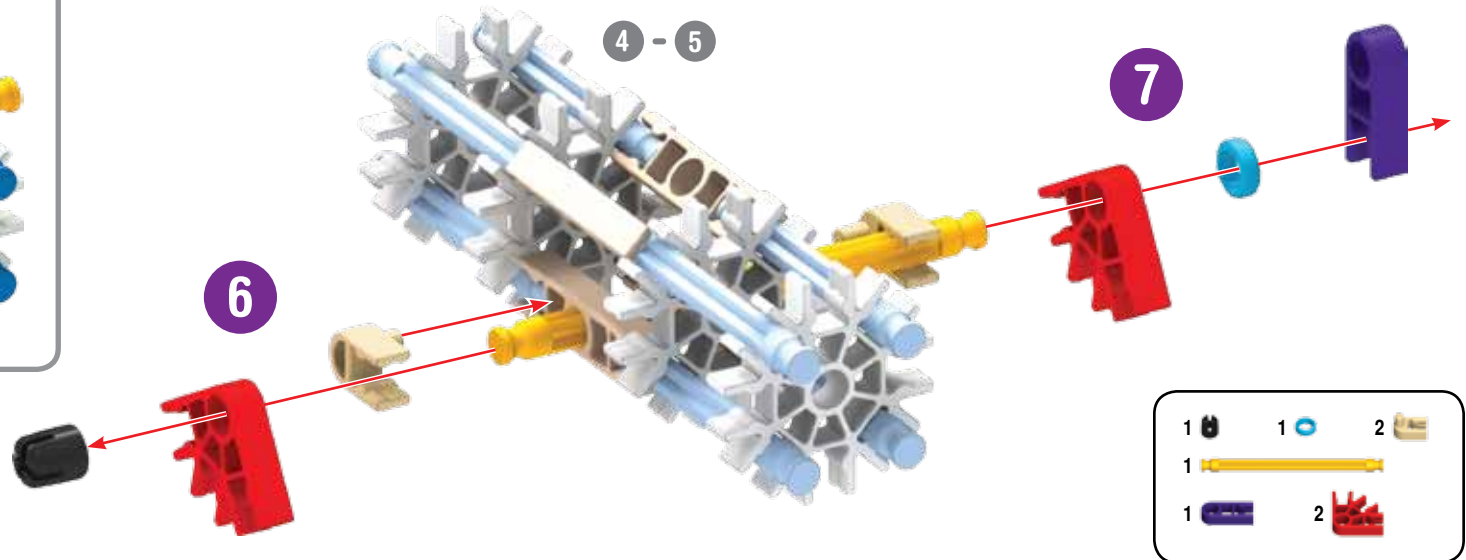
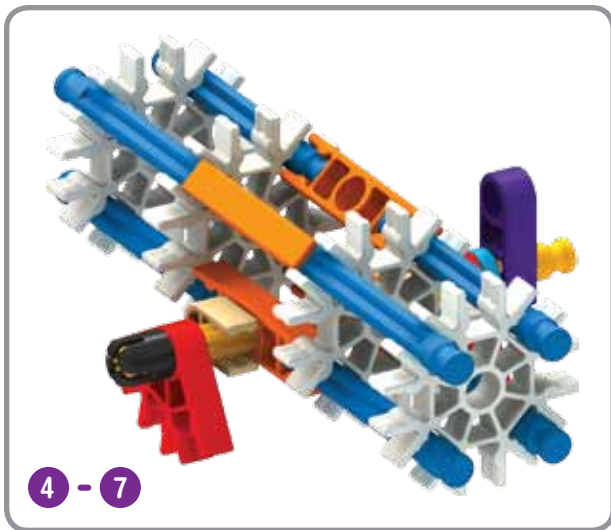
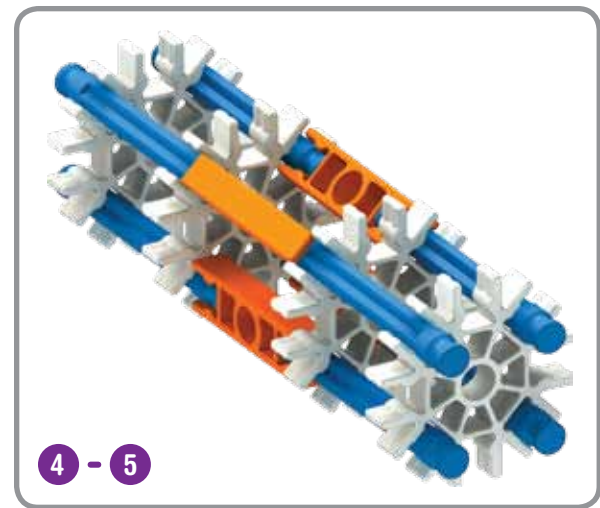
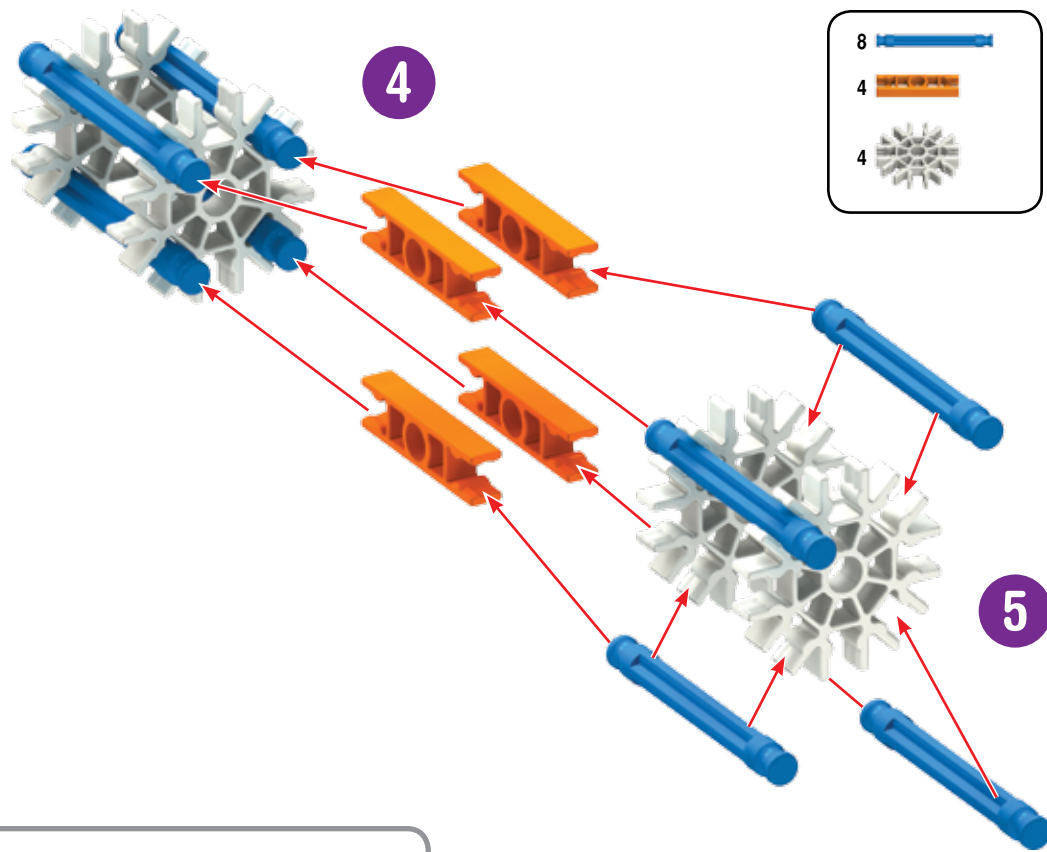

1 - 3

8

4 - 7

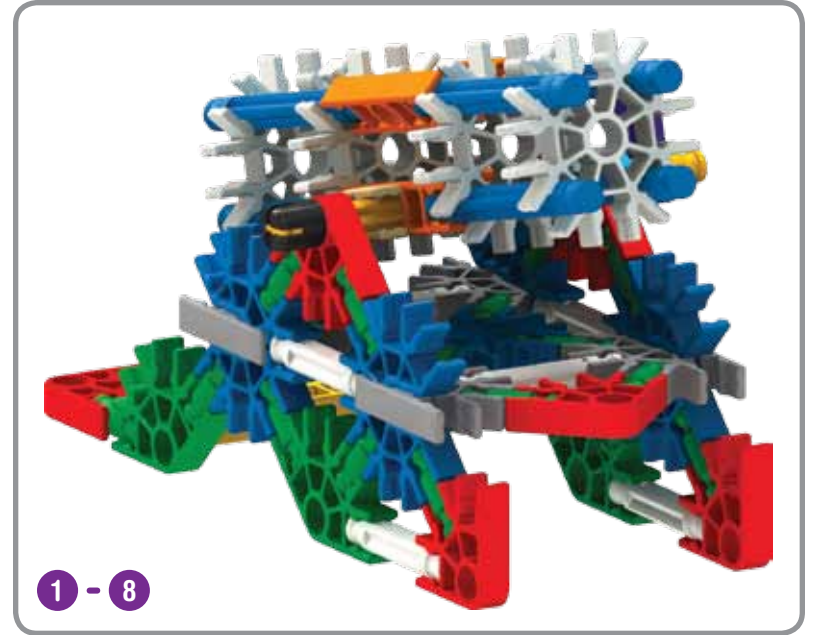
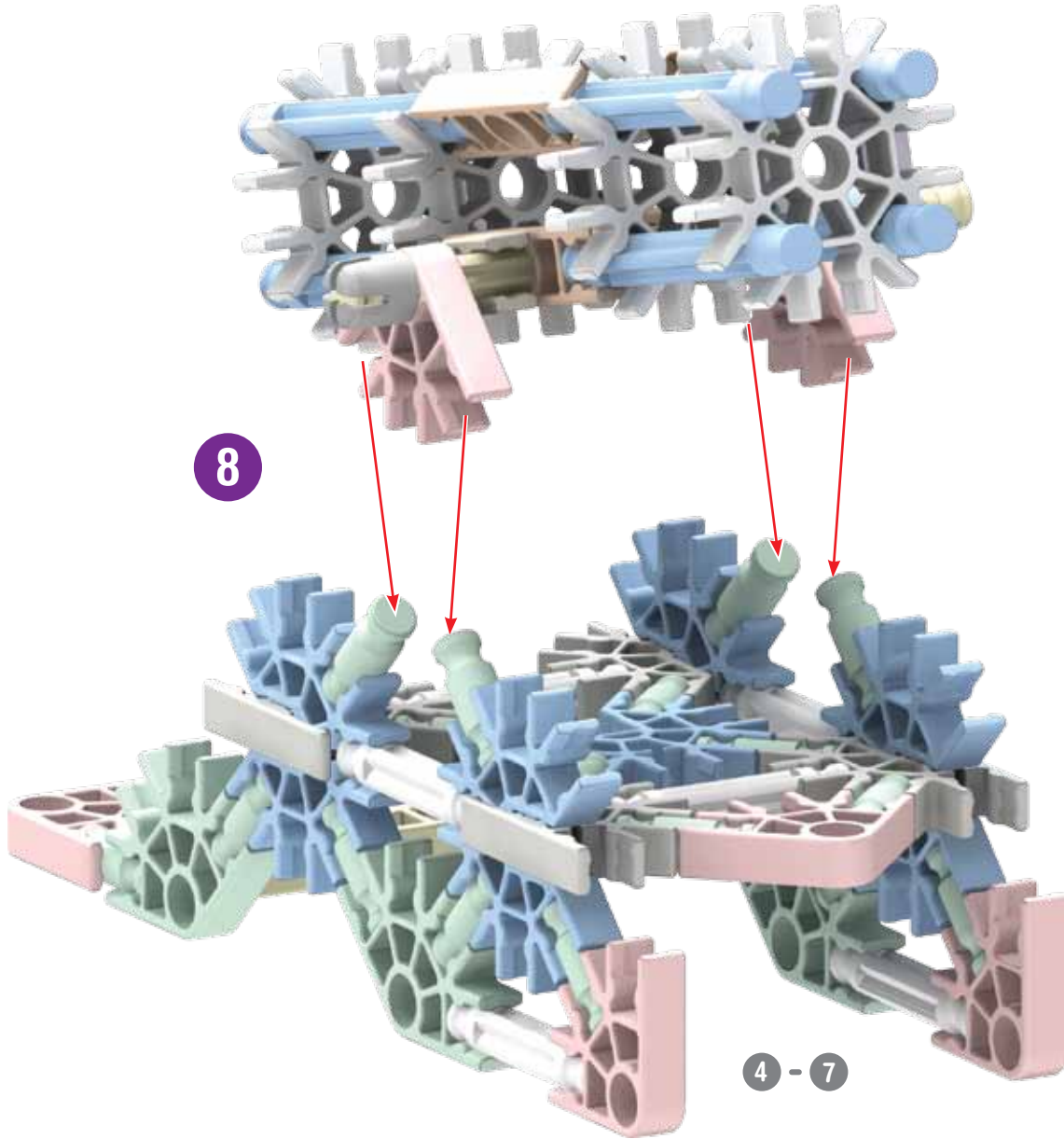

4 4 4 8

2

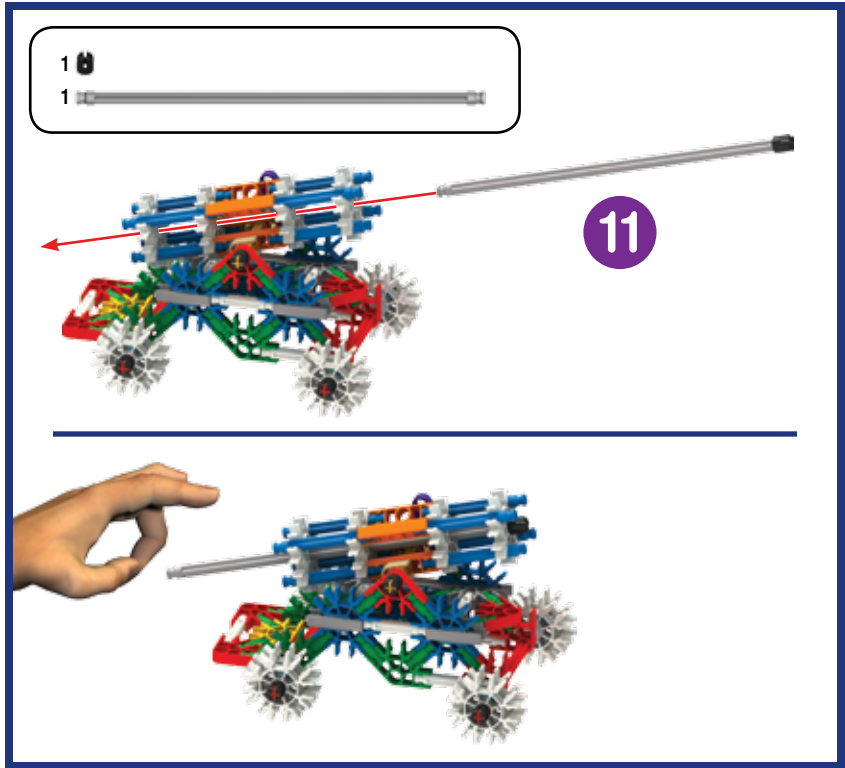
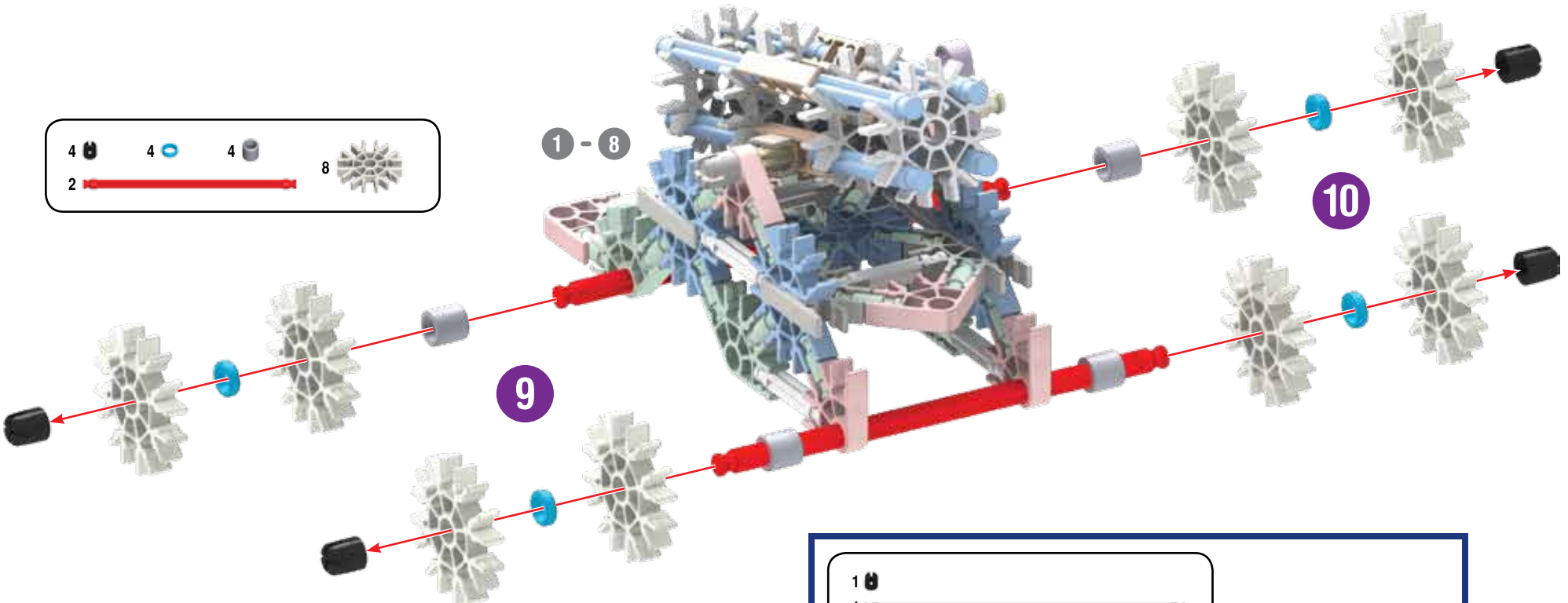



# Gravitron

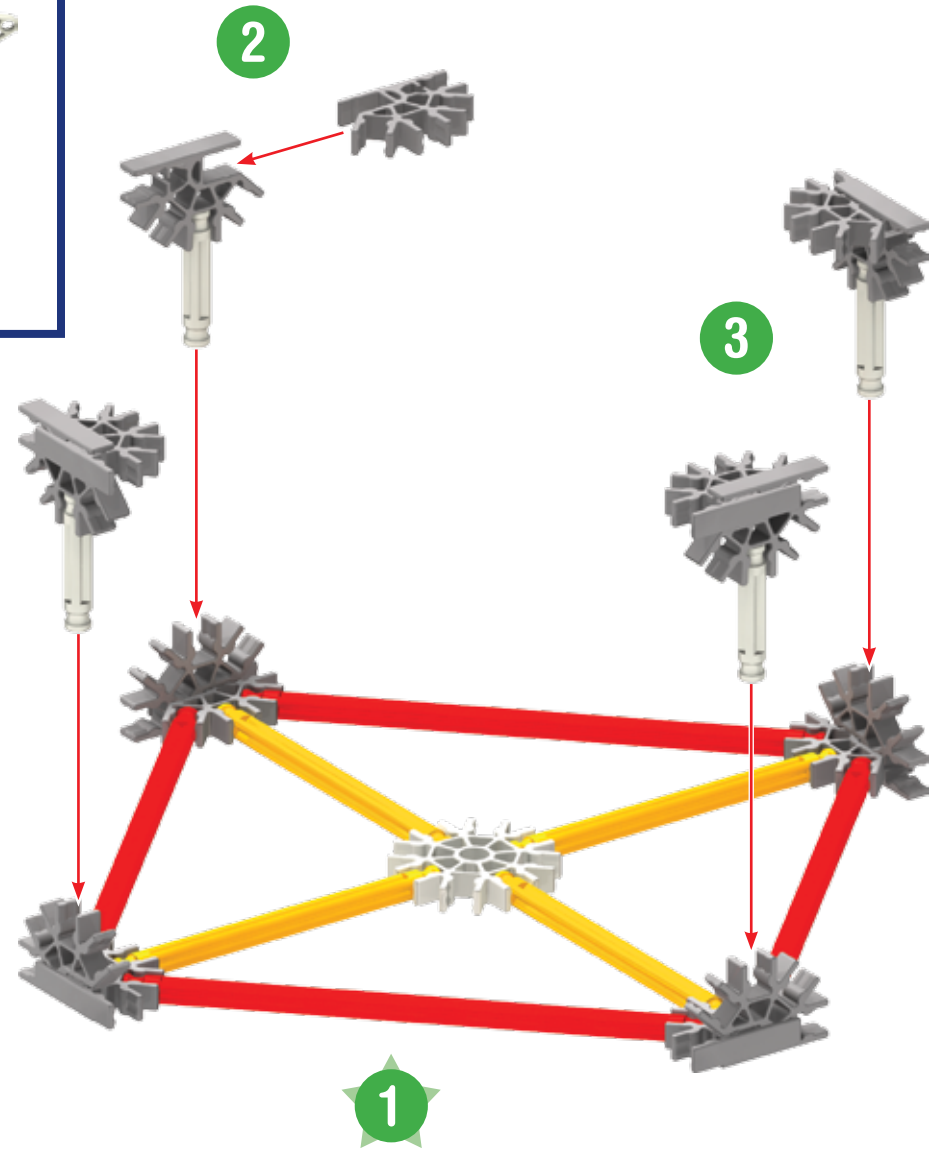
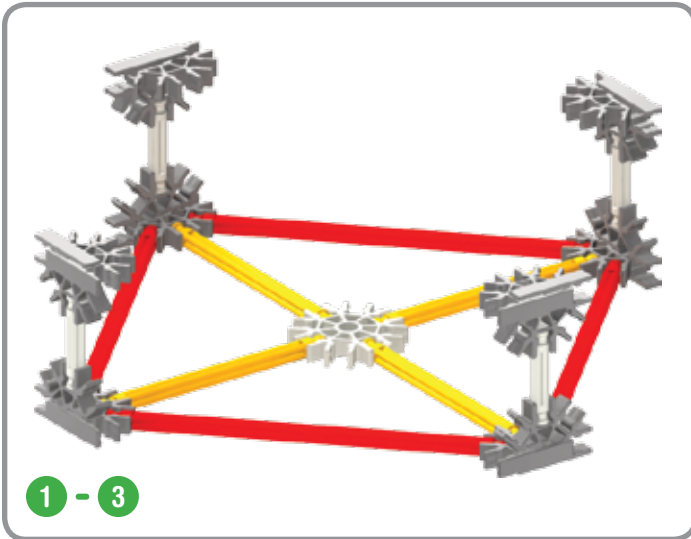
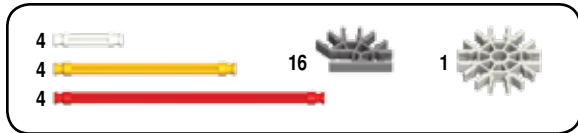

4

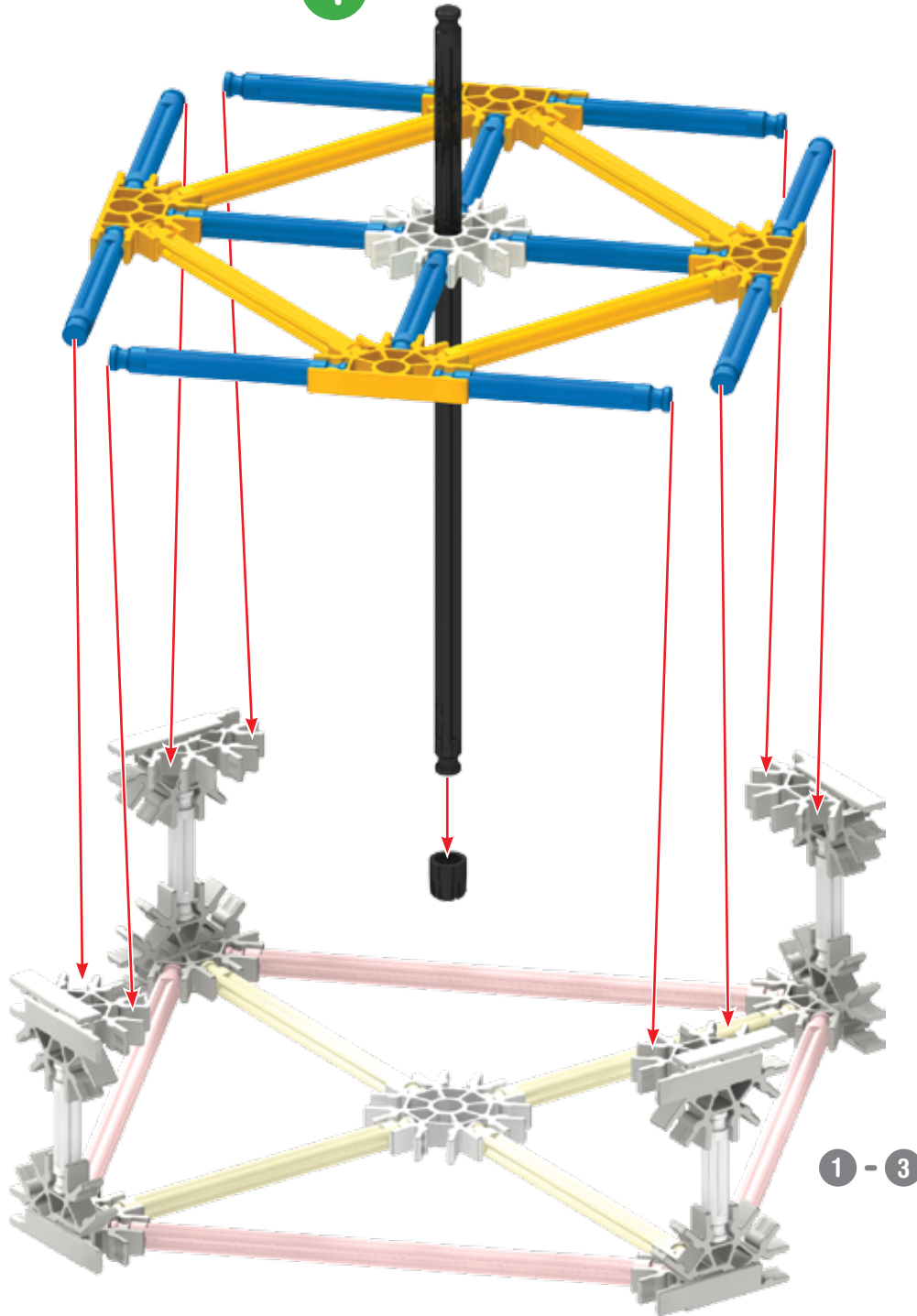

12		1		4		1	
4							
1							

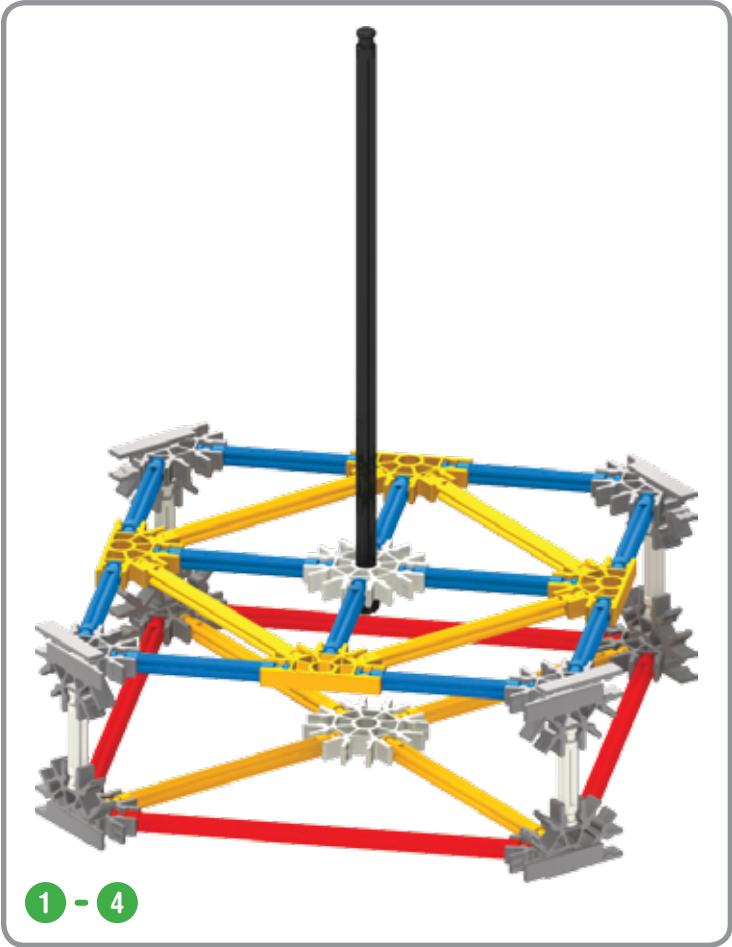

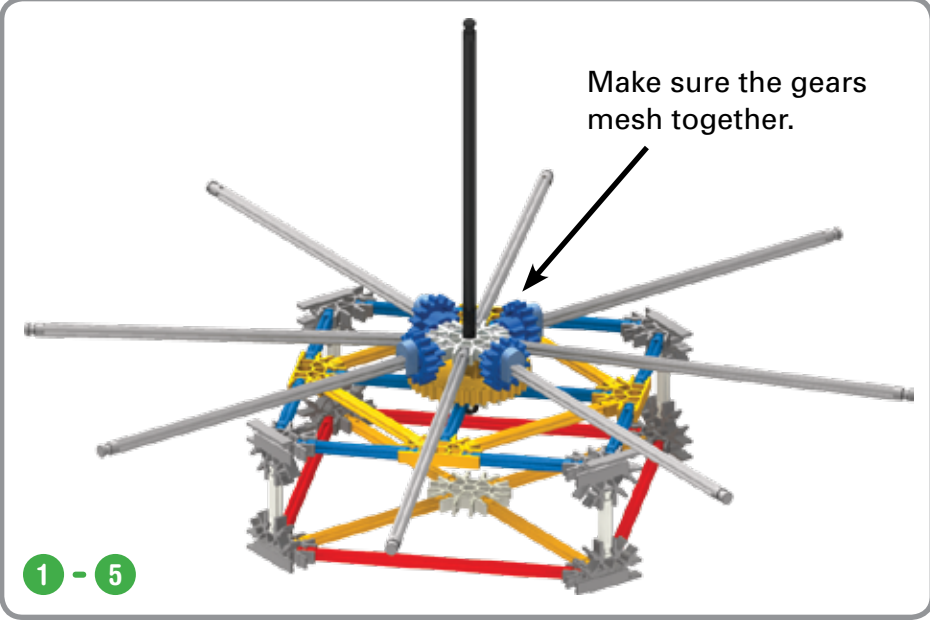
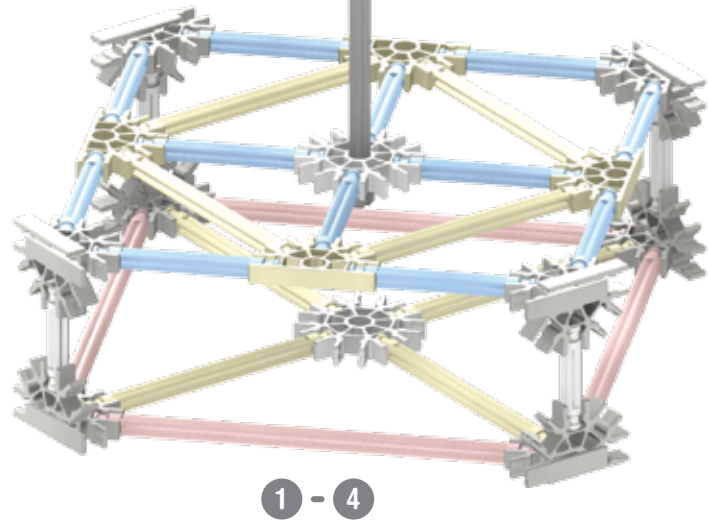
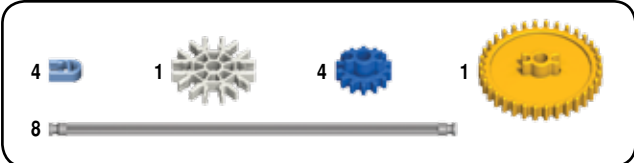
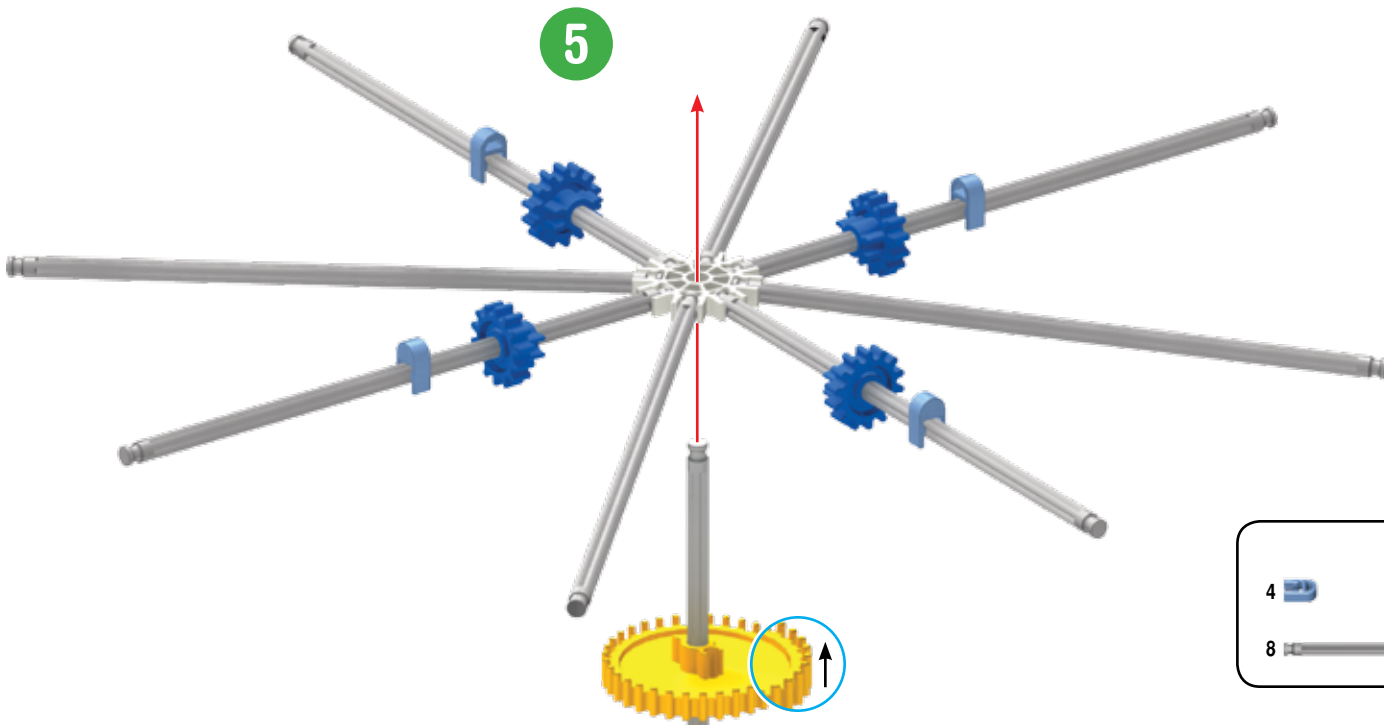

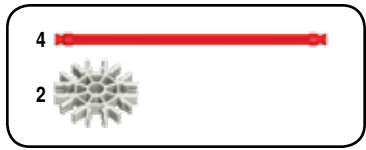

6

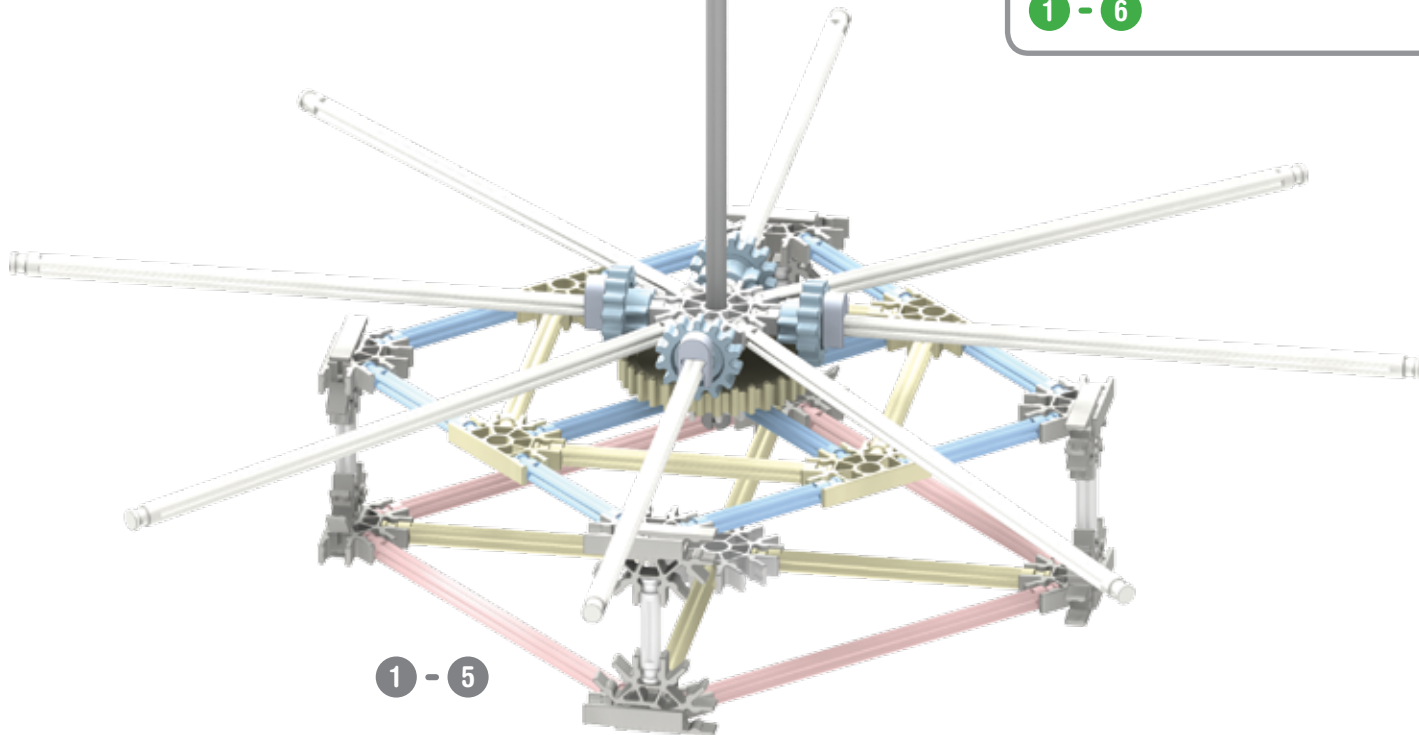
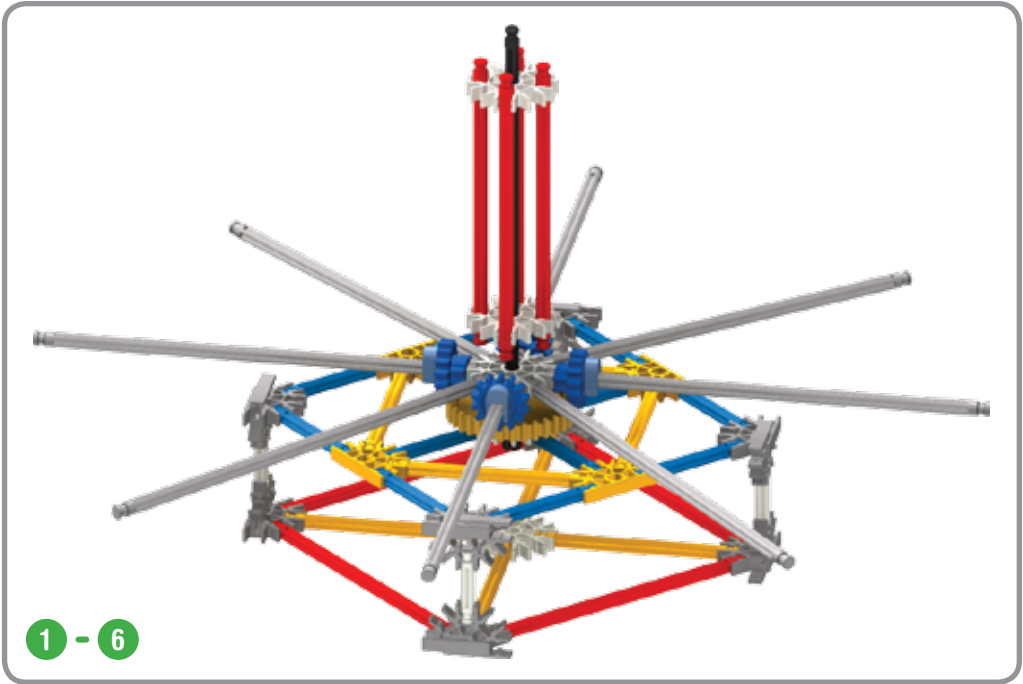
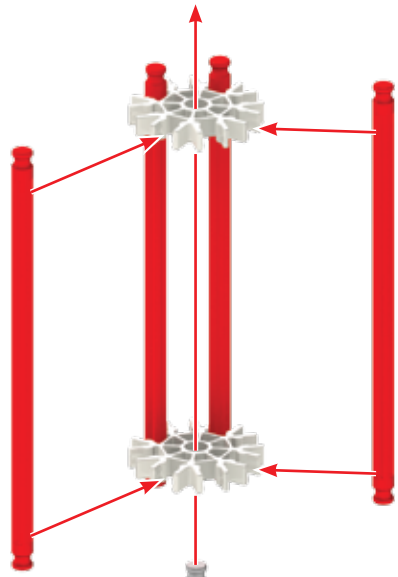

1 - 5

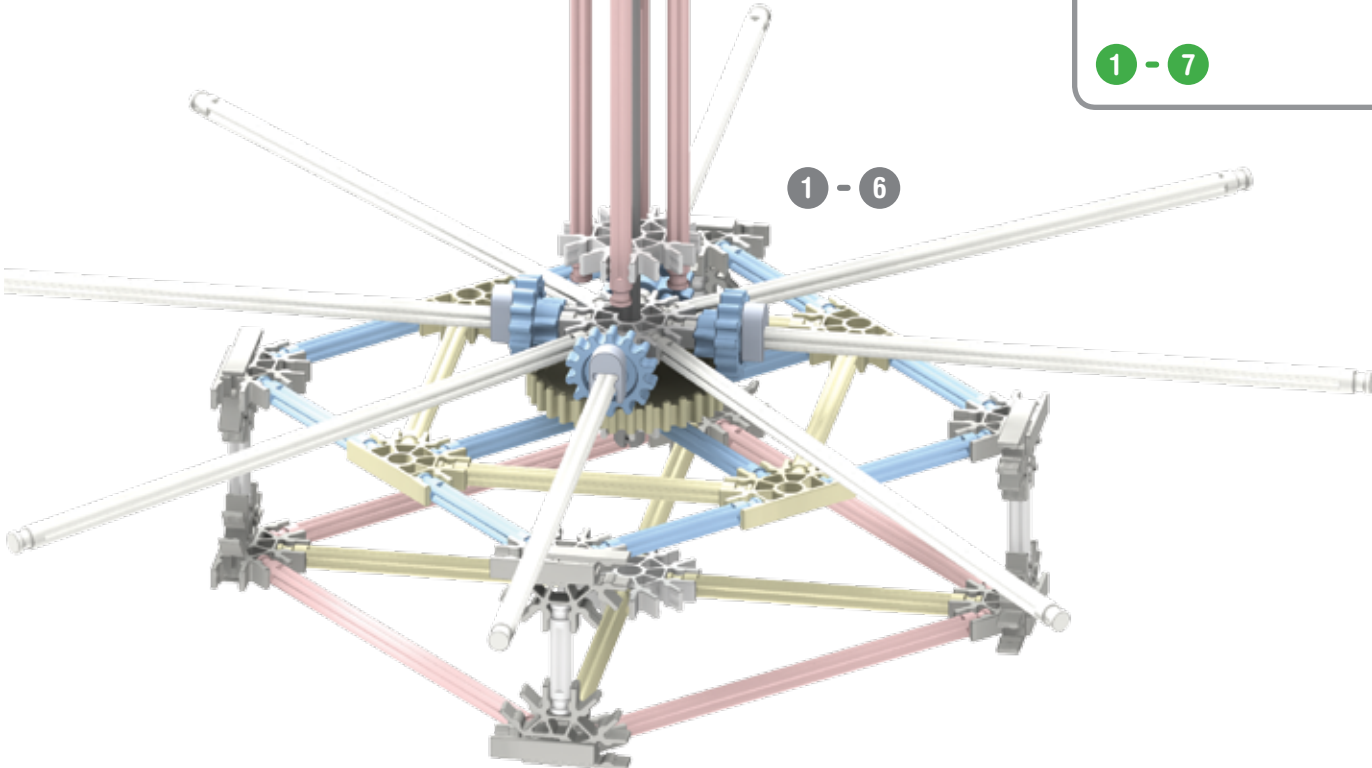
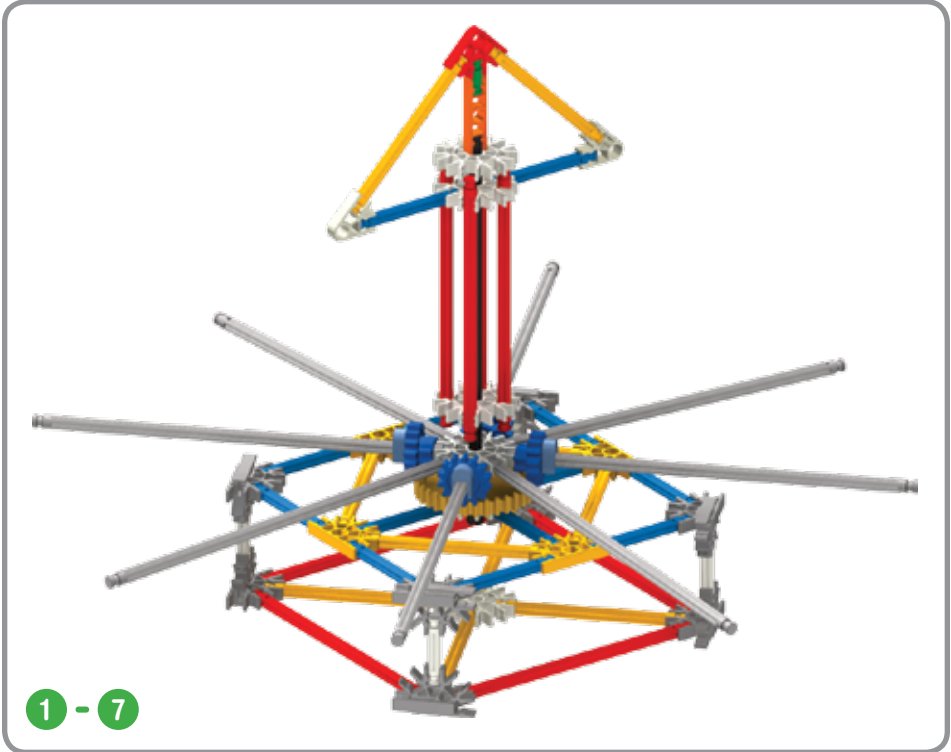
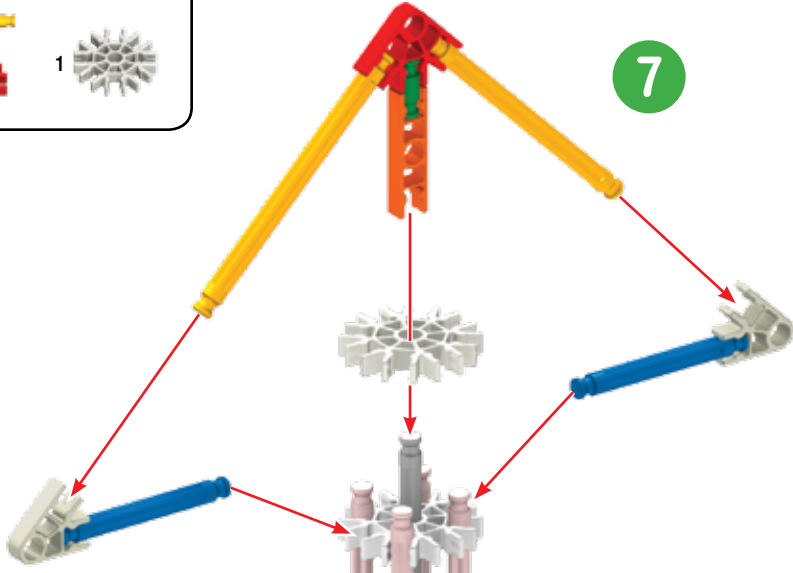
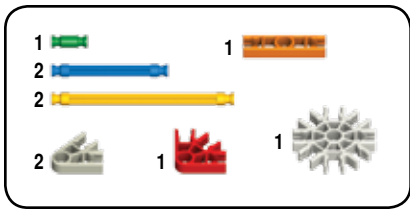

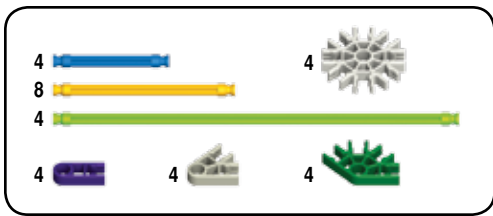

x4

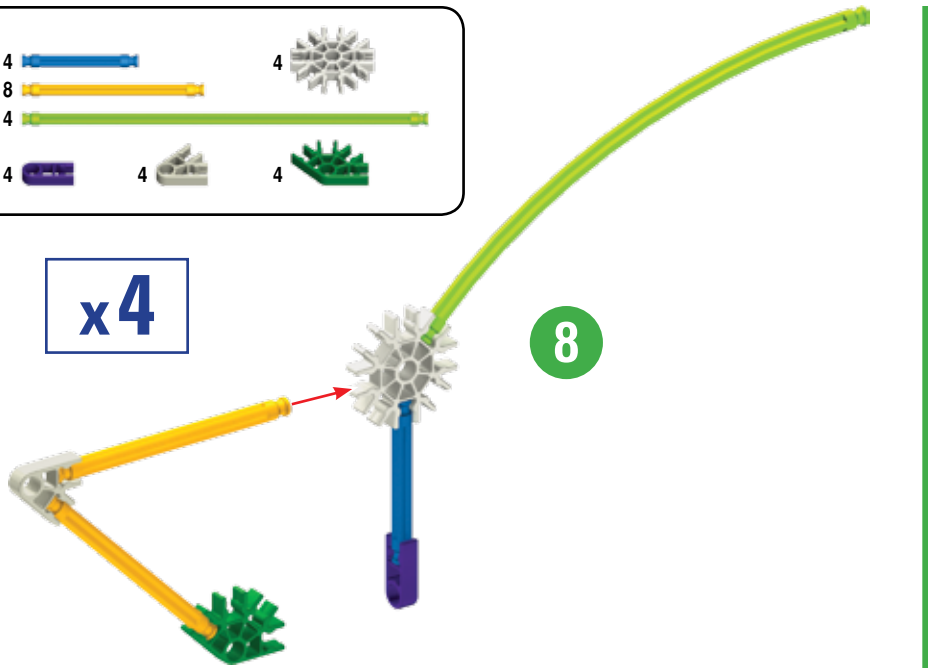

8

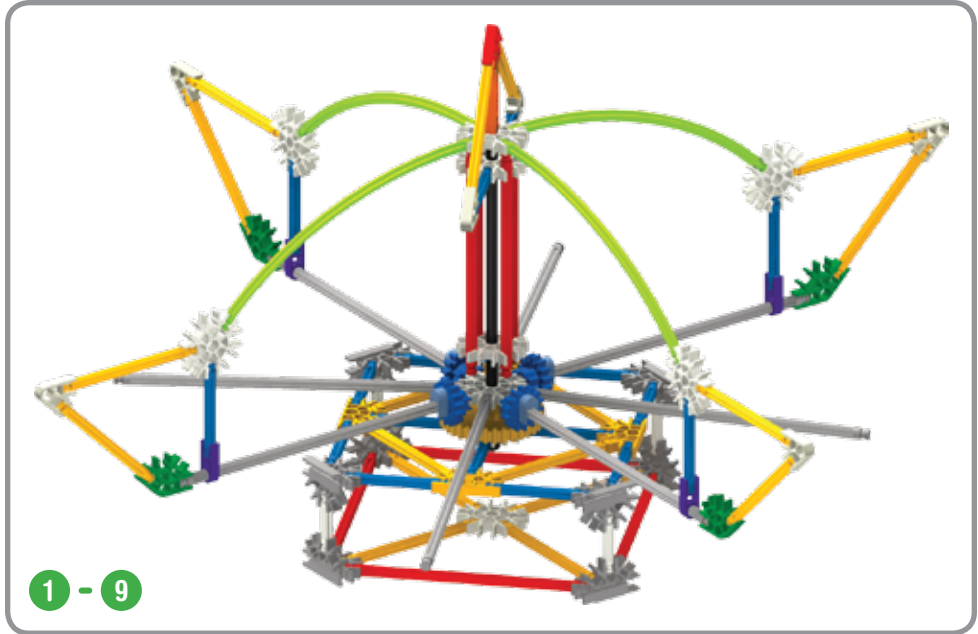

1 - 9

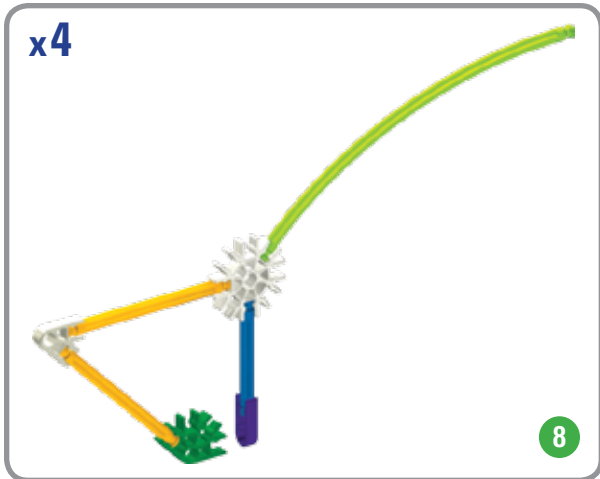

8

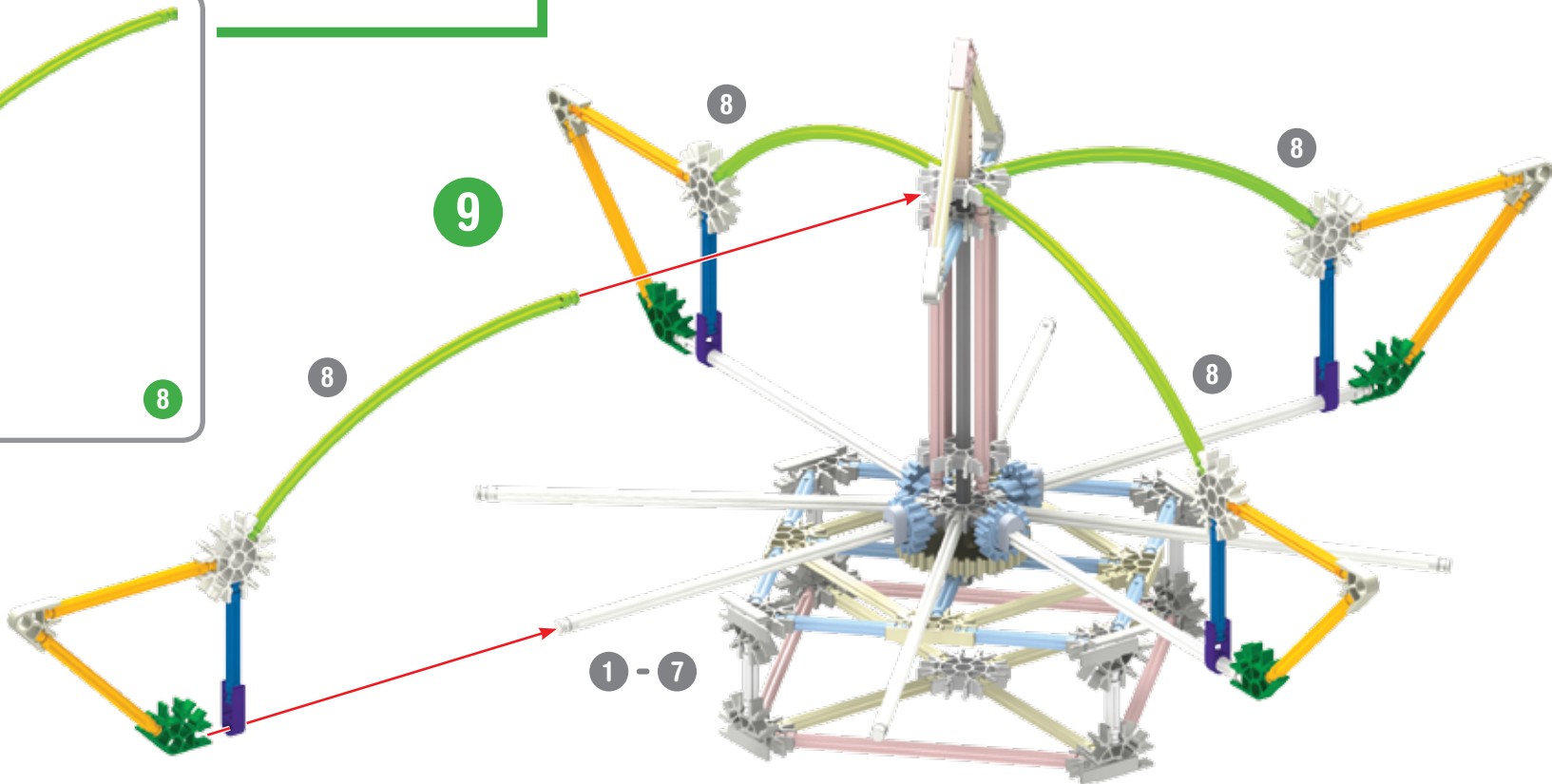

9

8

8

1 - 7

- 8
- 4
- 4
- 8
- 4
- 4
- 4
- 8
- 4
- 4
- 4

x4

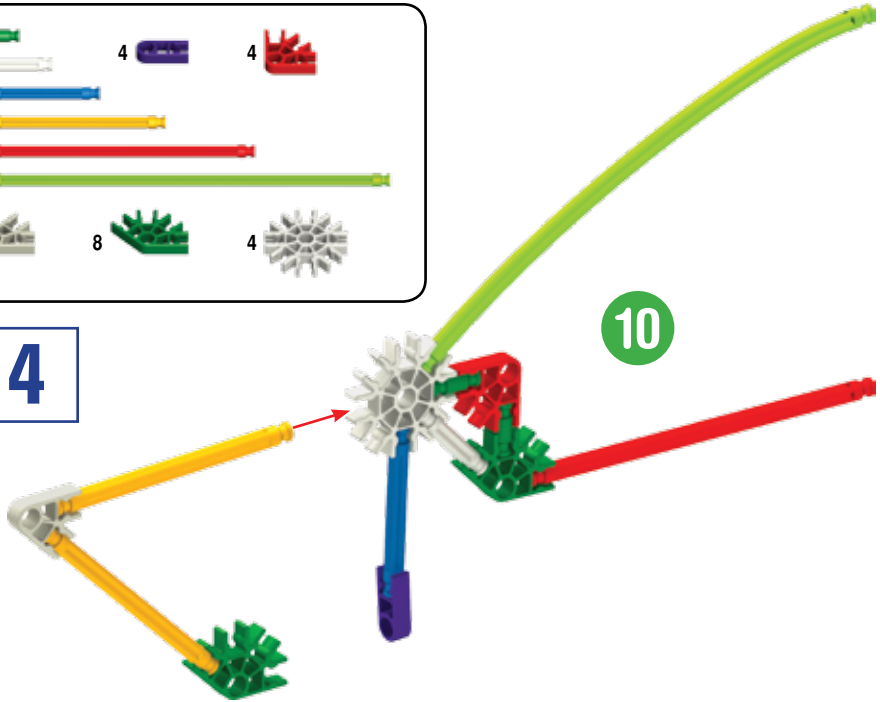

10

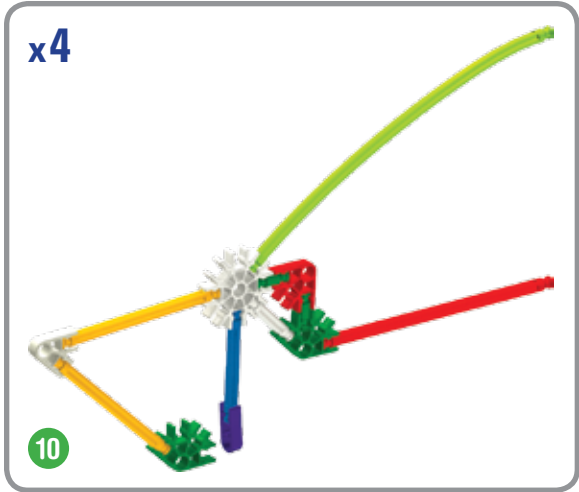

x4

10



### Gravitron

1 - 11

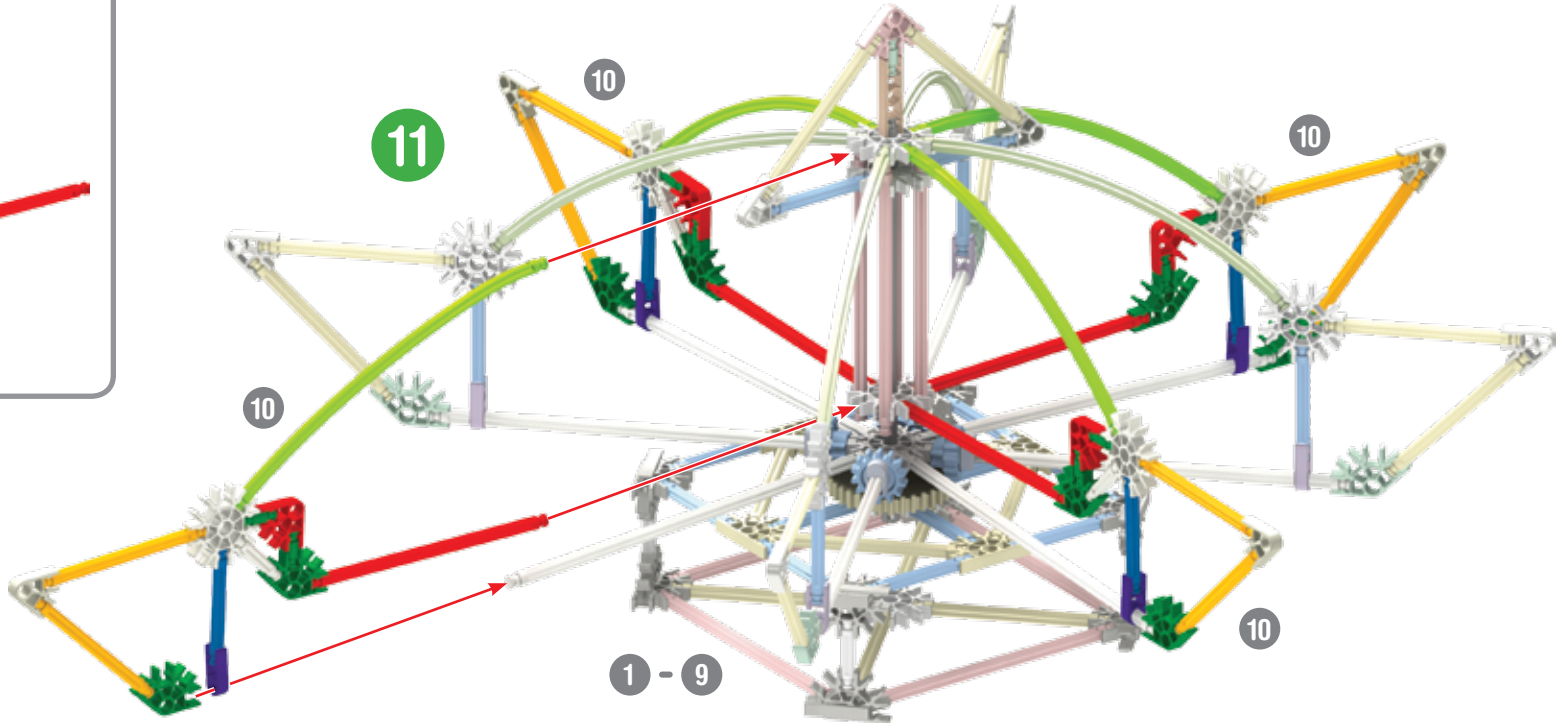

11

10

10

10

1 - 9

10

# Guitar

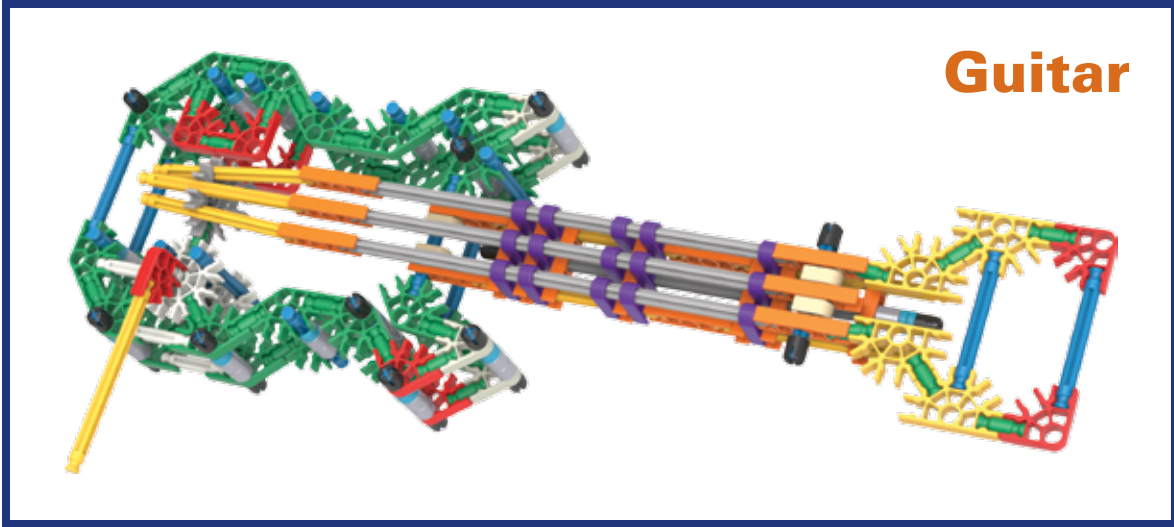

x2

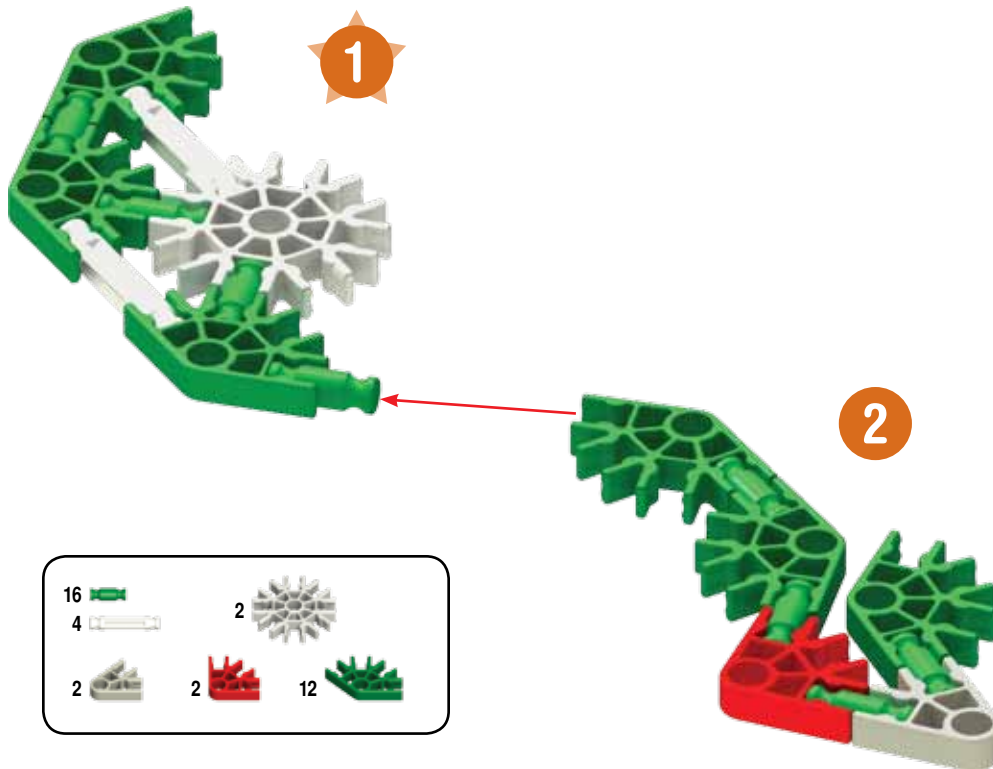

- |    |  |    |  |
|----|--|----|--|
| 16 |  | 2  |  |
| 4  |  | 2  |  |
| 2  |  | 12 |  |



x2

1 - 2

2



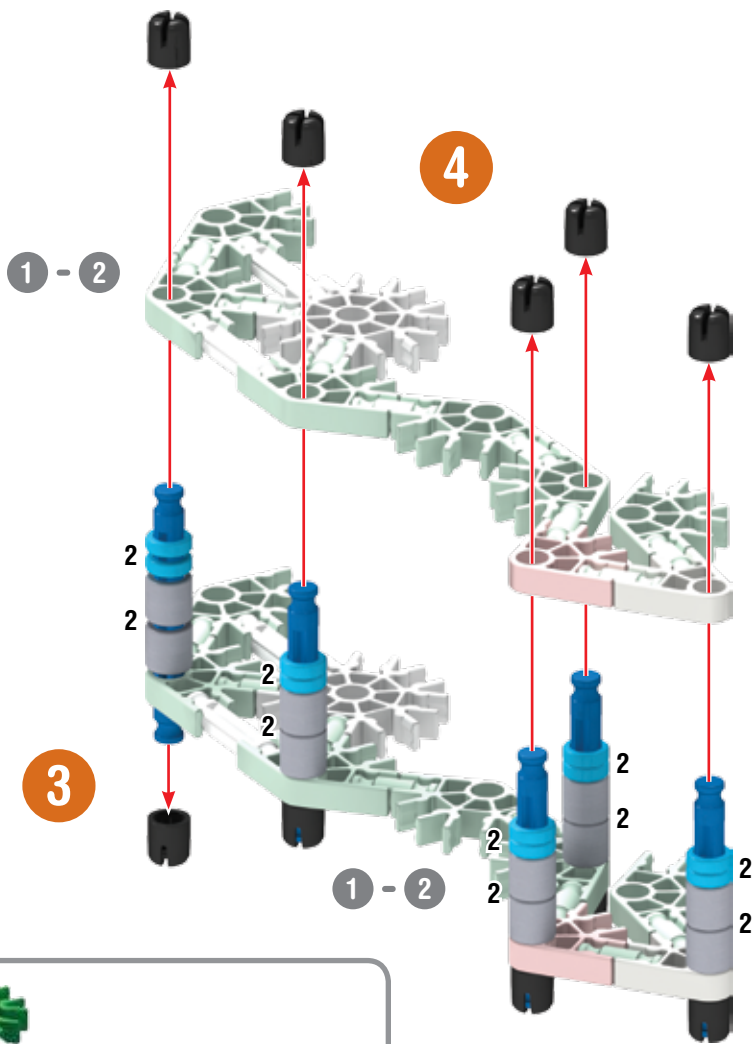

- |    |    |    |
|----|----|----|
| 10 | 10 | 10 |
| 5  |    |    |

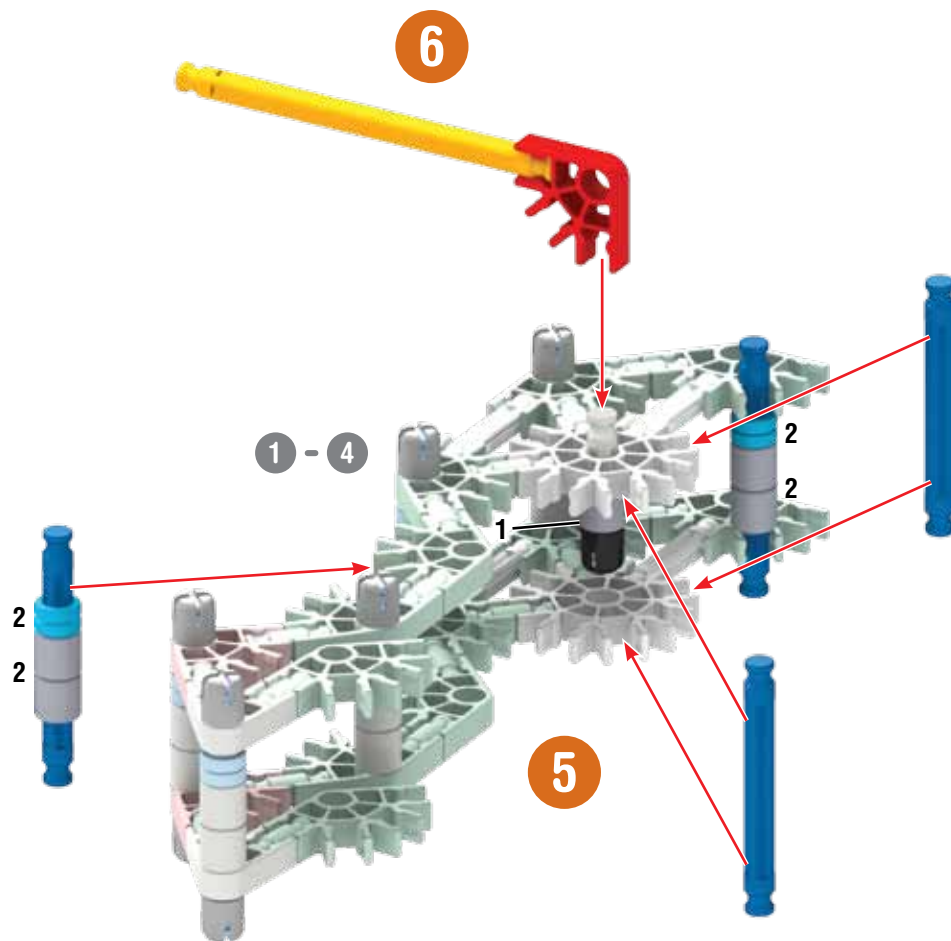

- |   |   |   |
|---|---|---|
| 1 |   | 1 |
| 4 |   |   |
| 1 |   |   |
| 1 | 4 | 5 |



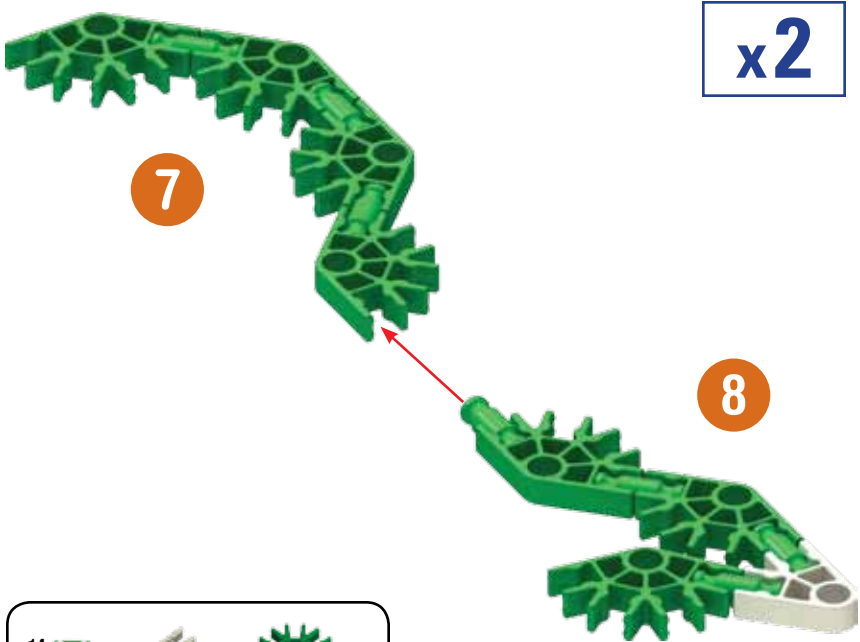

x2

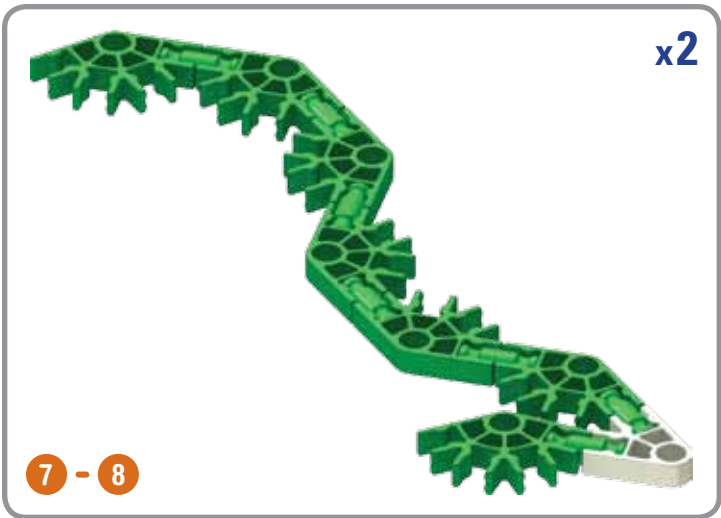

x2

7 - 8



7 - 10

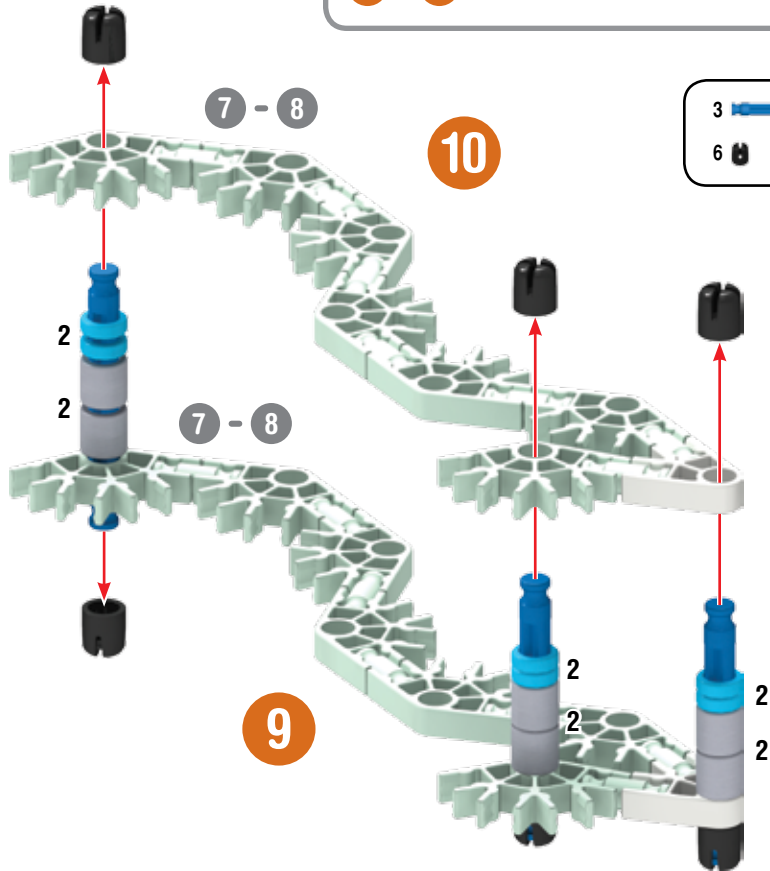

7 - 8

10

7 - 8

9

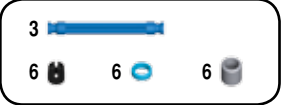

- 6
- 6
- 10 10
- 4

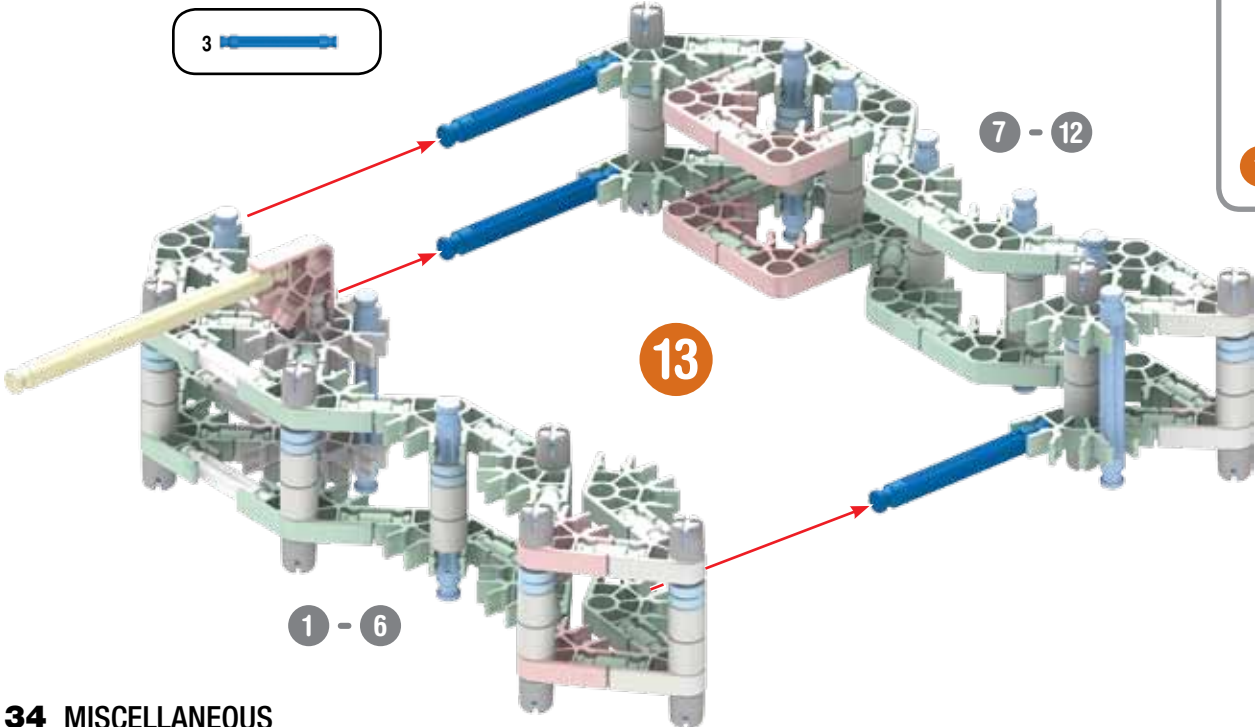
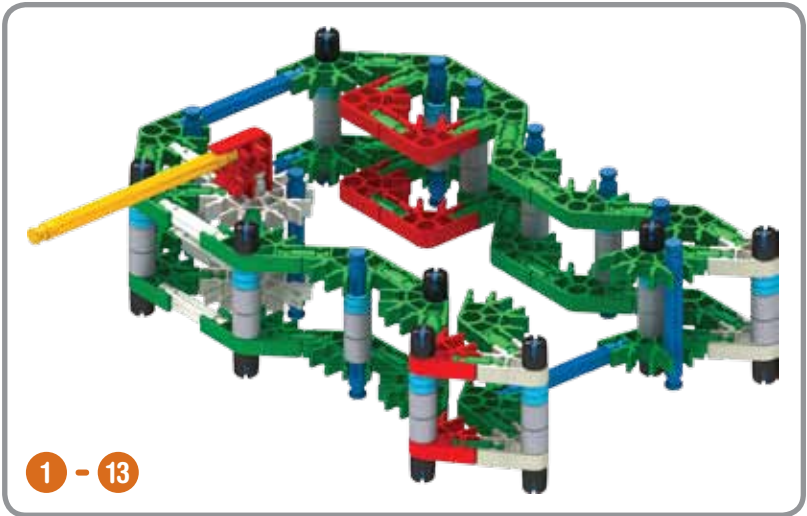
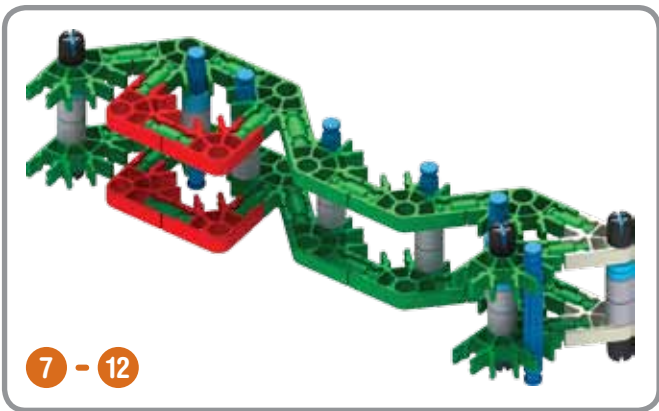
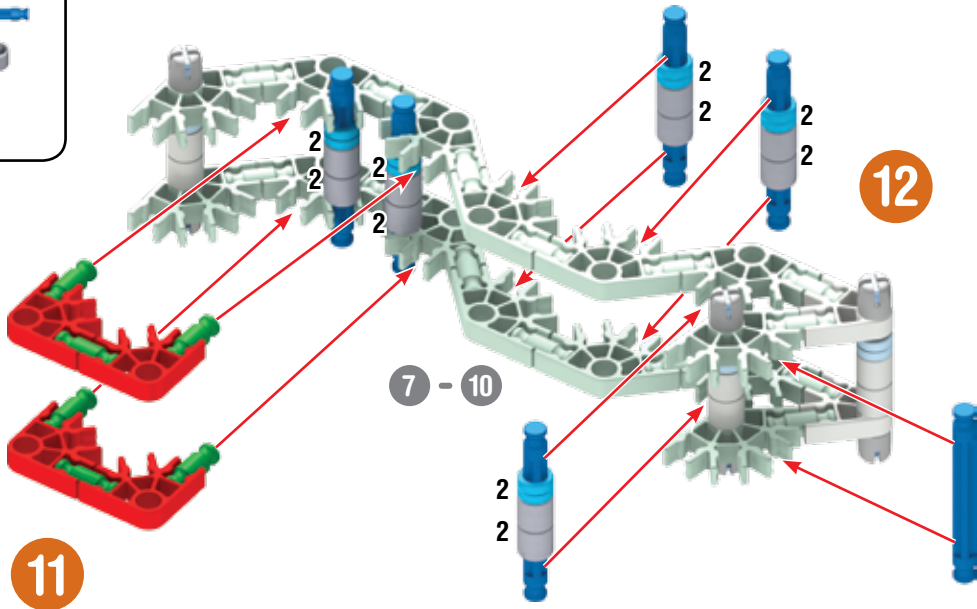

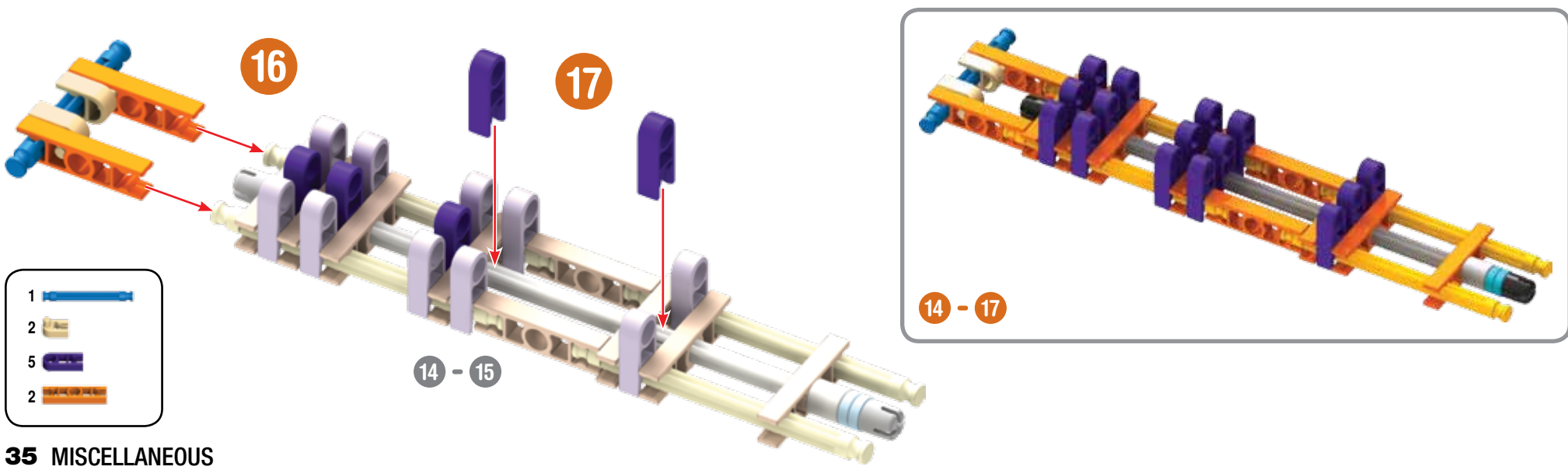
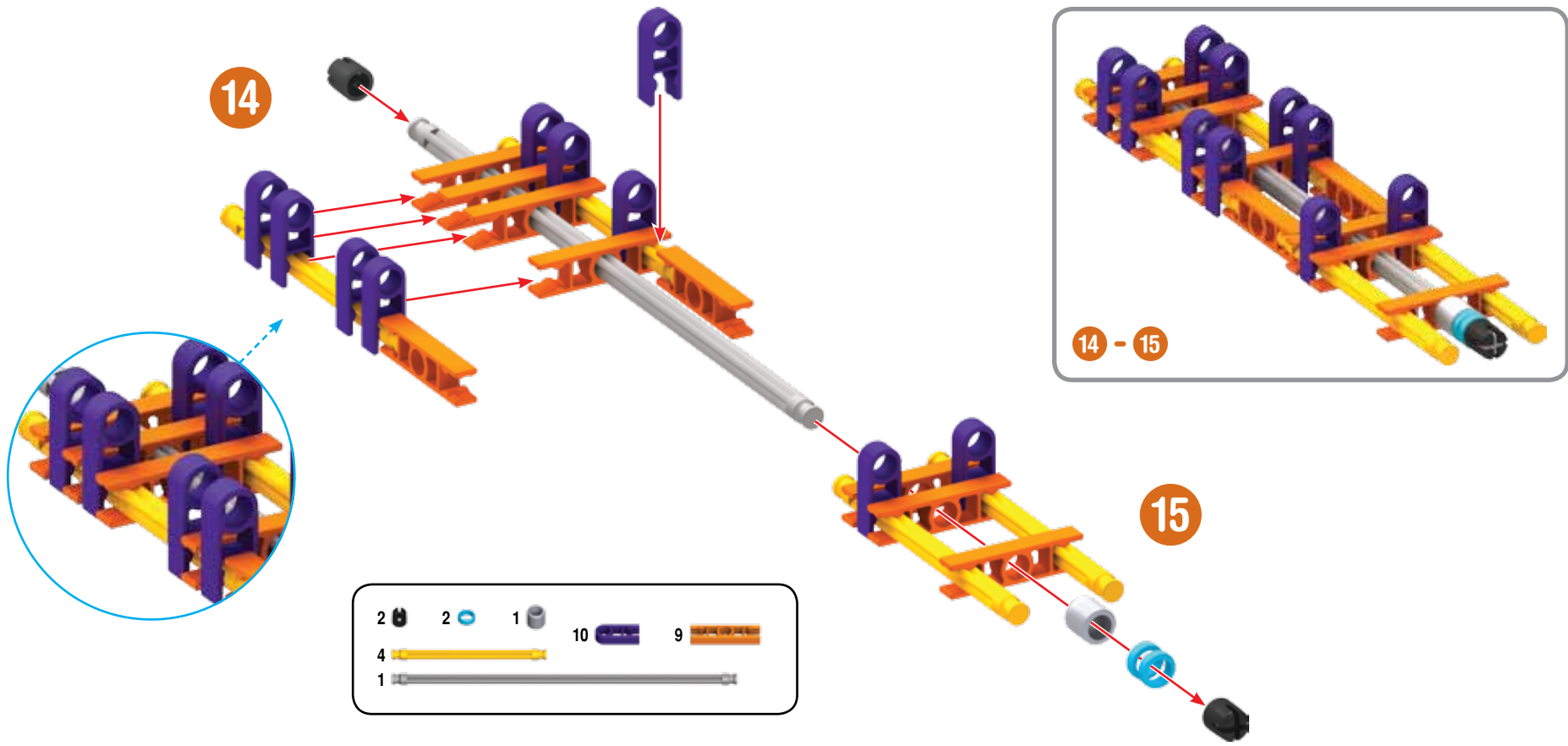

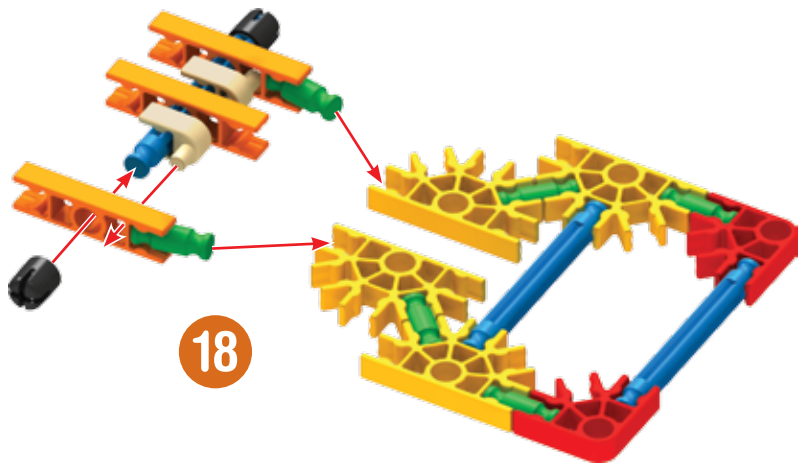

18

- |   |  |   |  |   |  |
|---|--|---|--|---|--|
| 6 |  | 2 |  | 2 |  |
| 3 |  |   |  |   |  |
| 3 |  | 2 |  | 4 |  |

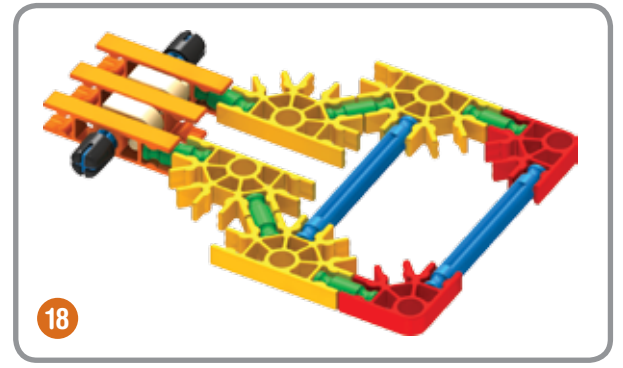

18

- |   |  |   |  |   |  |
|---|--|---|--|---|--|
| 1 |  | 3 |  | 2 |  |
| 3 |  |   |  |   |  |
| 3 |  |   |  |   |  |

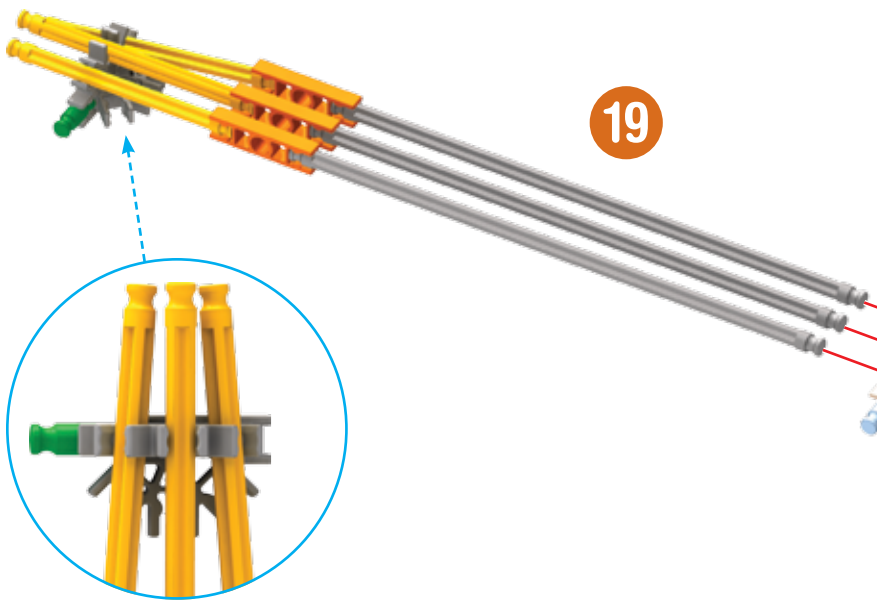

19

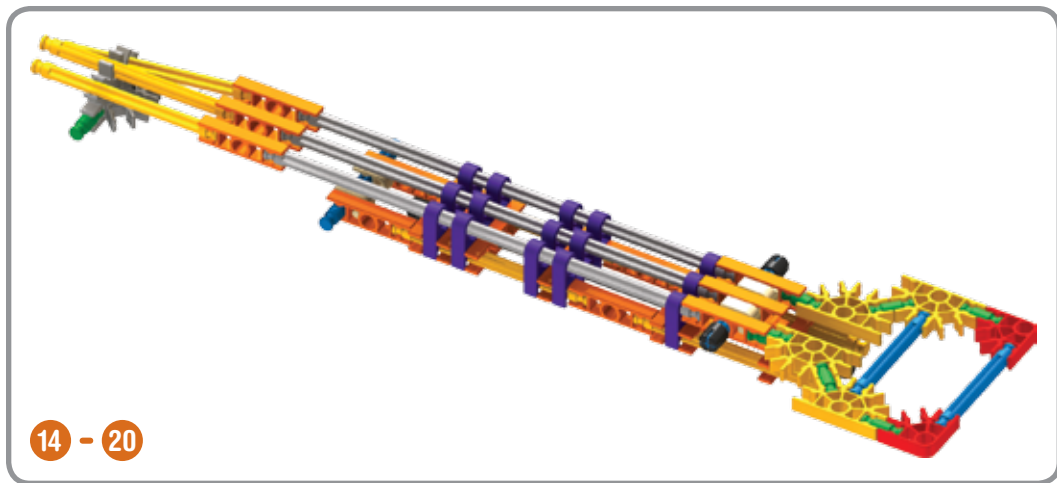

14 - 20

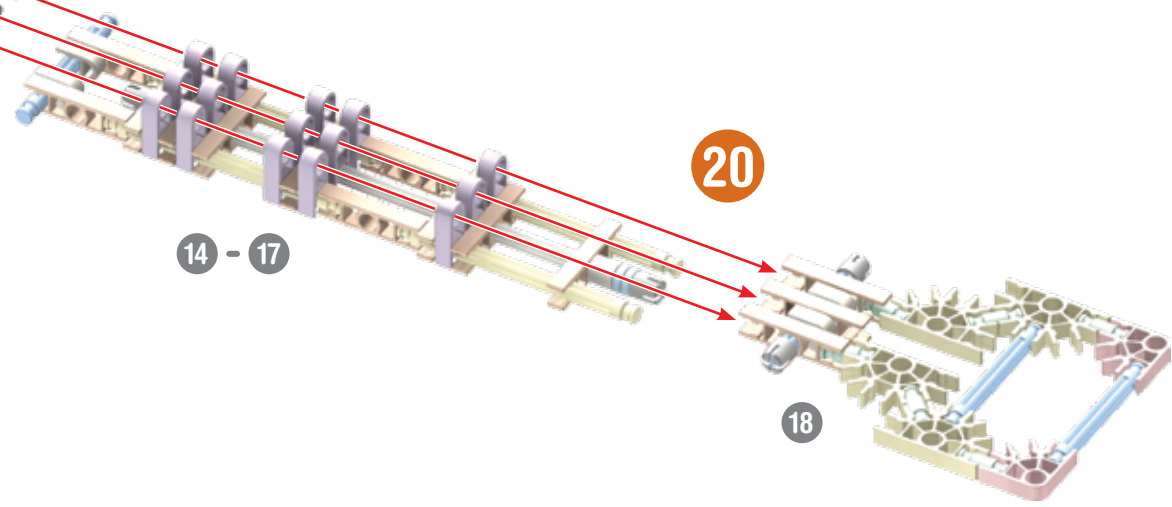

20

14 - 17

18

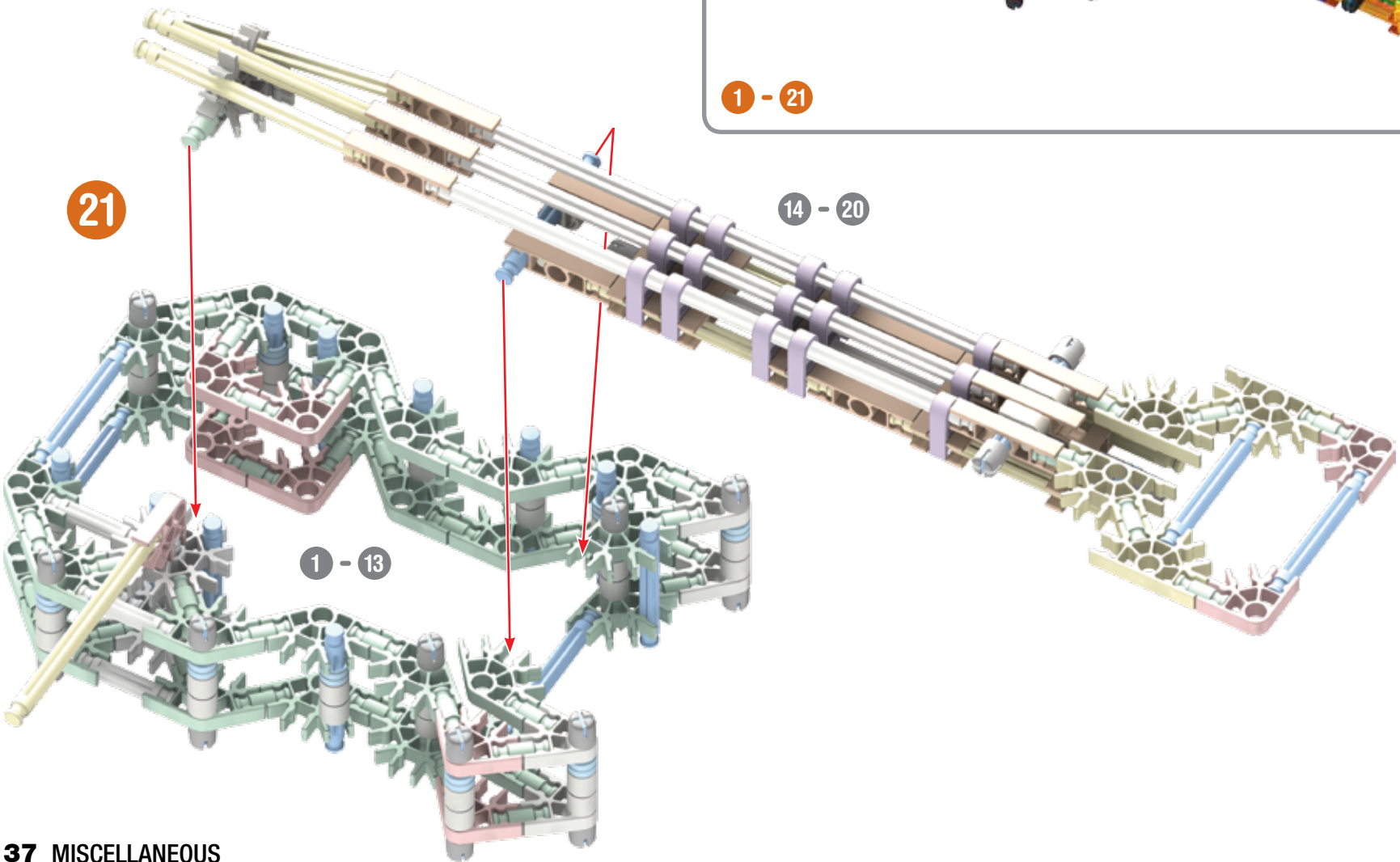

# Mech

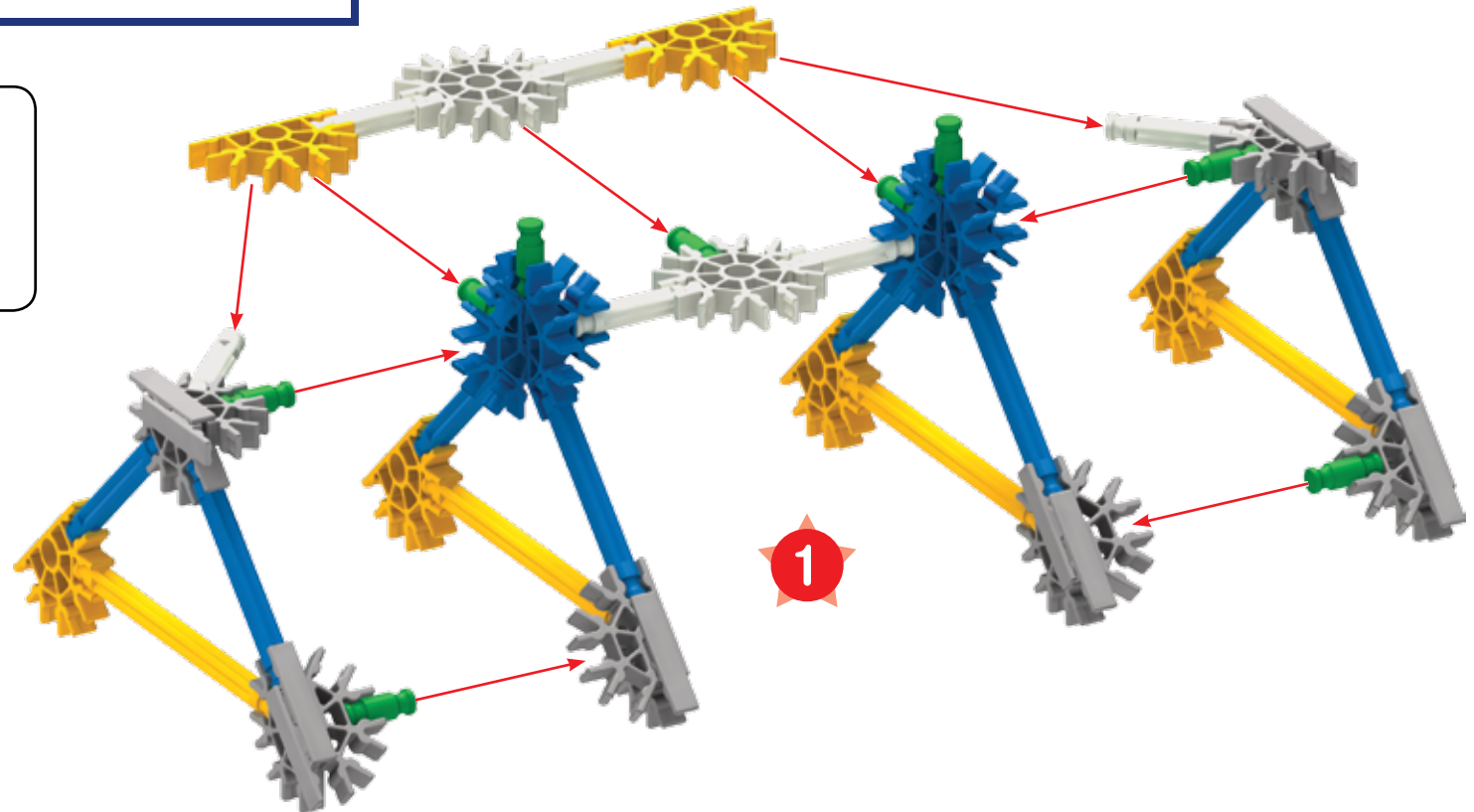
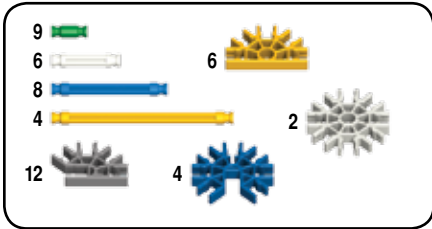
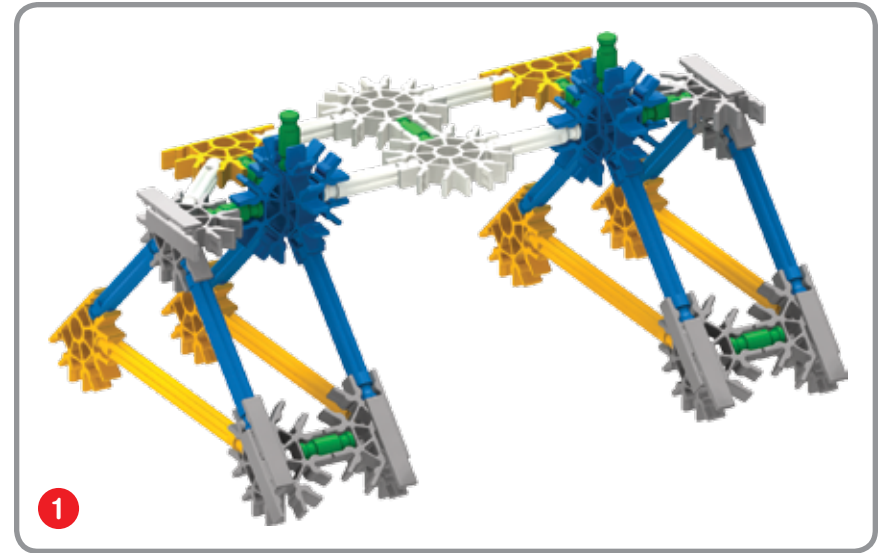

- 14
- 6
- 2
- 2
- 2
- 1
- 2
- 6
- 6
- 2

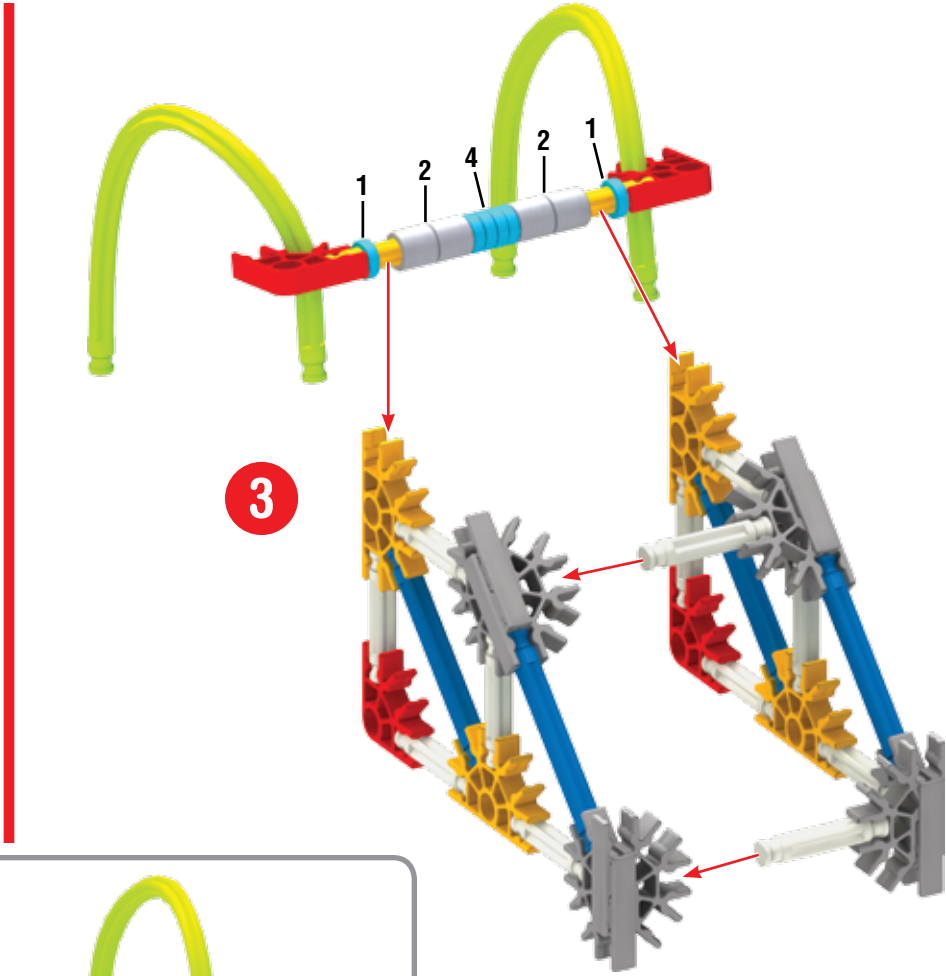
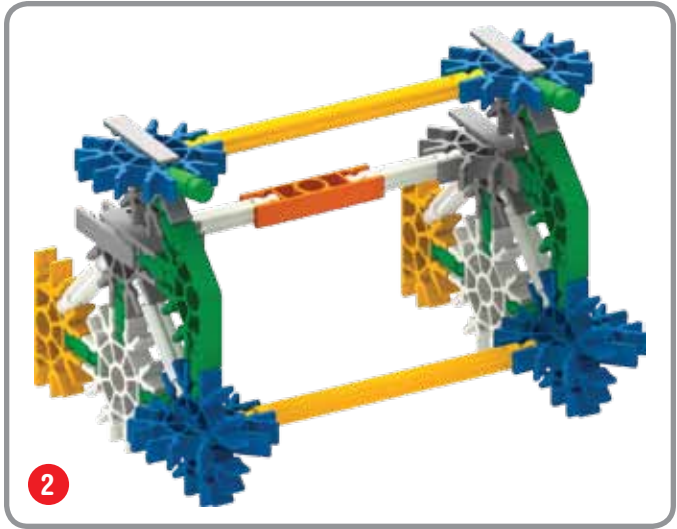
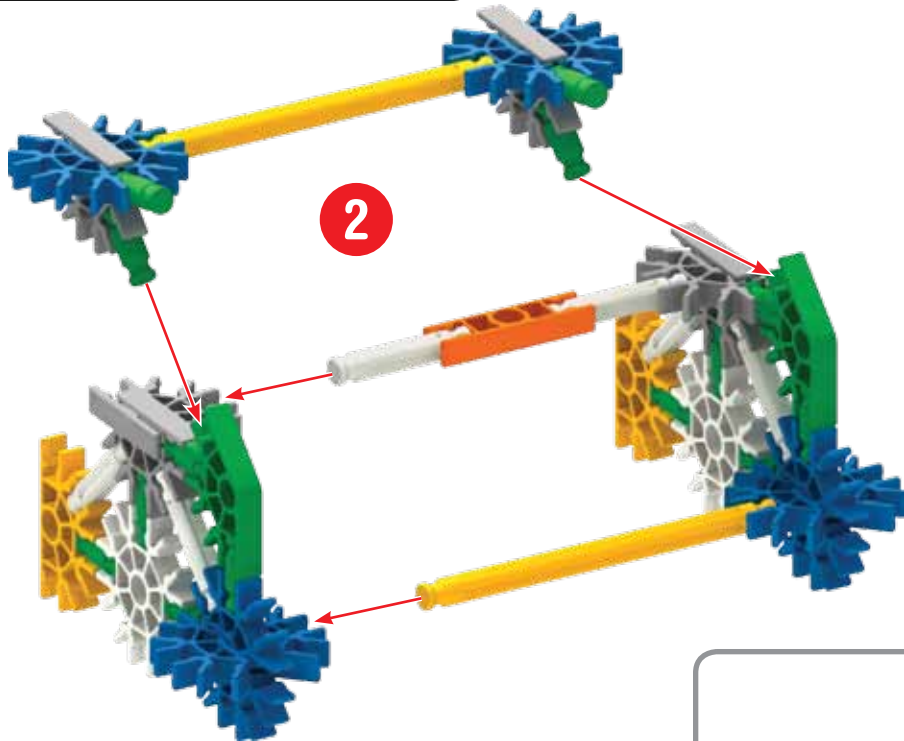

- 12
- 4
- 1
- 2
- 4
- 6
- 4
- 4
- 8



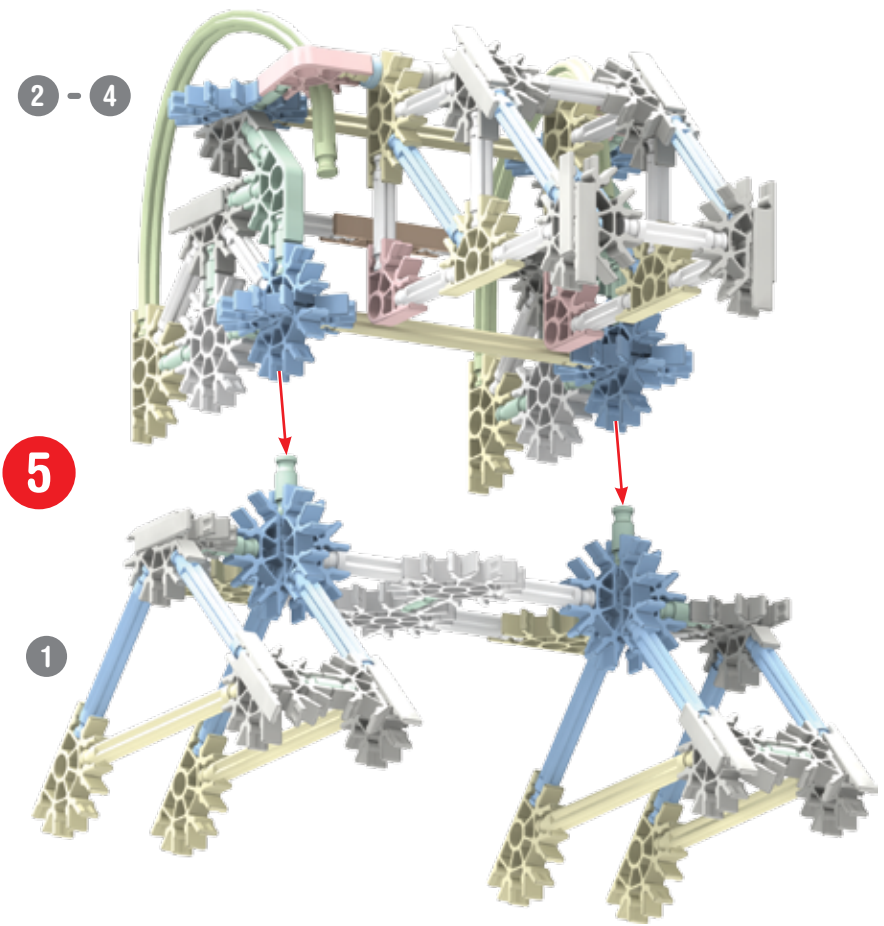
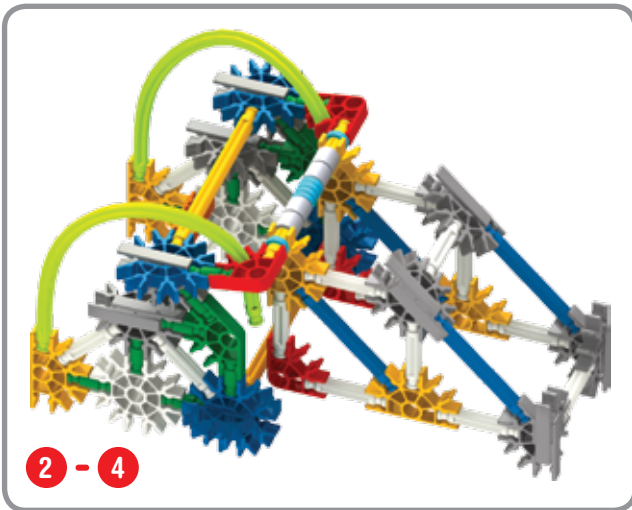
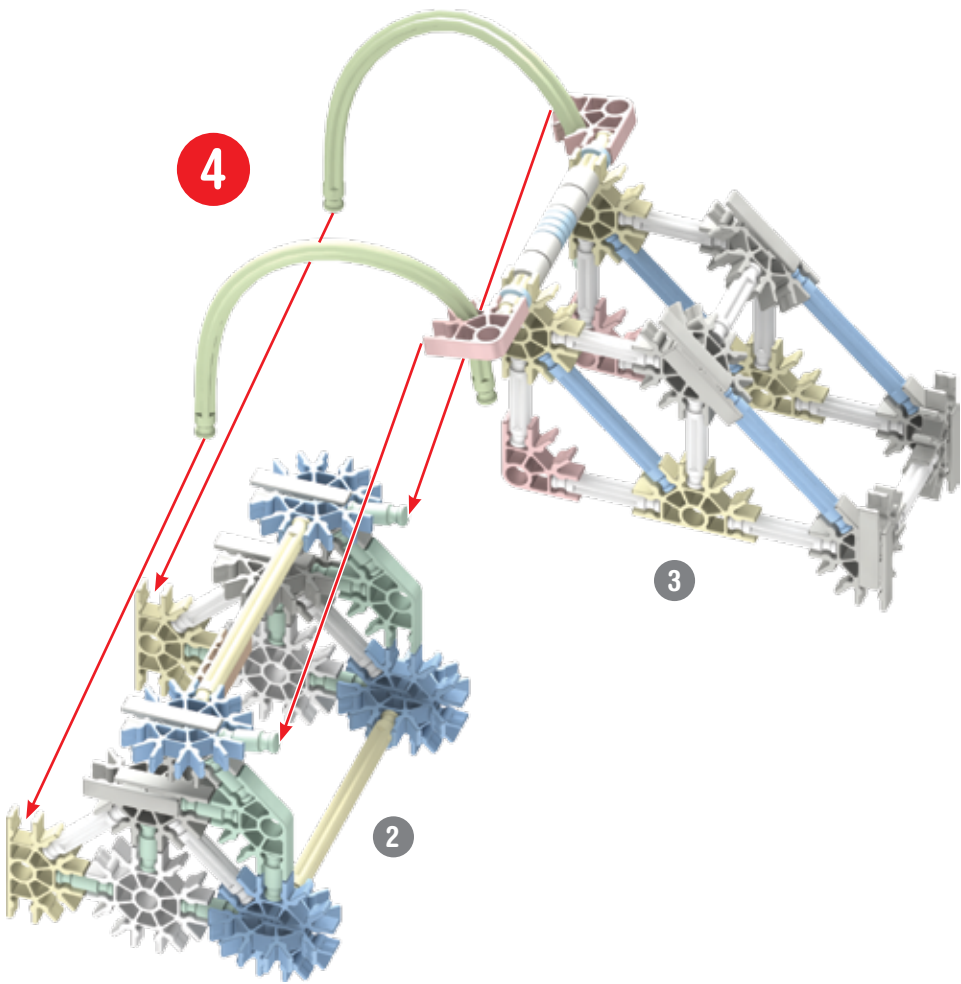



- |   |  |   |  |   |  |   |  |   |  |   |  |
|---|--|---|--|---|--|---|--|---|--|---|--|
| 4 |  | 4 |  | 4 |  | 2 |  | 2 |  | 2 |  |
| 9 |  |   |  | 2 |  |   |  |   |  |   |  |
| 4 |  |   |  | 4 |  |   |  |   |  |   |  |
| 2 |  |   |  |   |  |   |  |   |  |   |  |

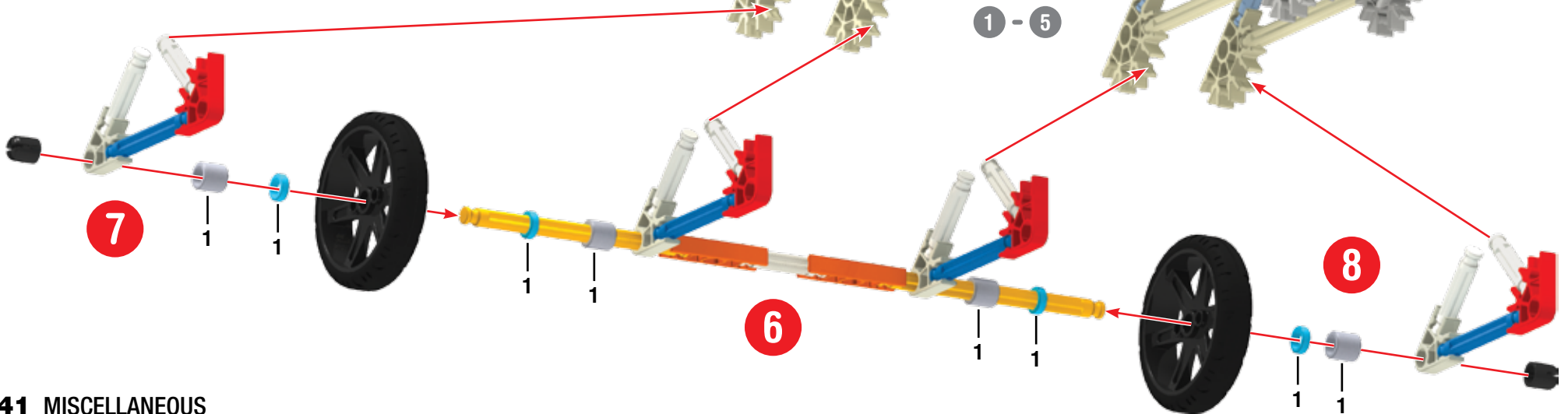
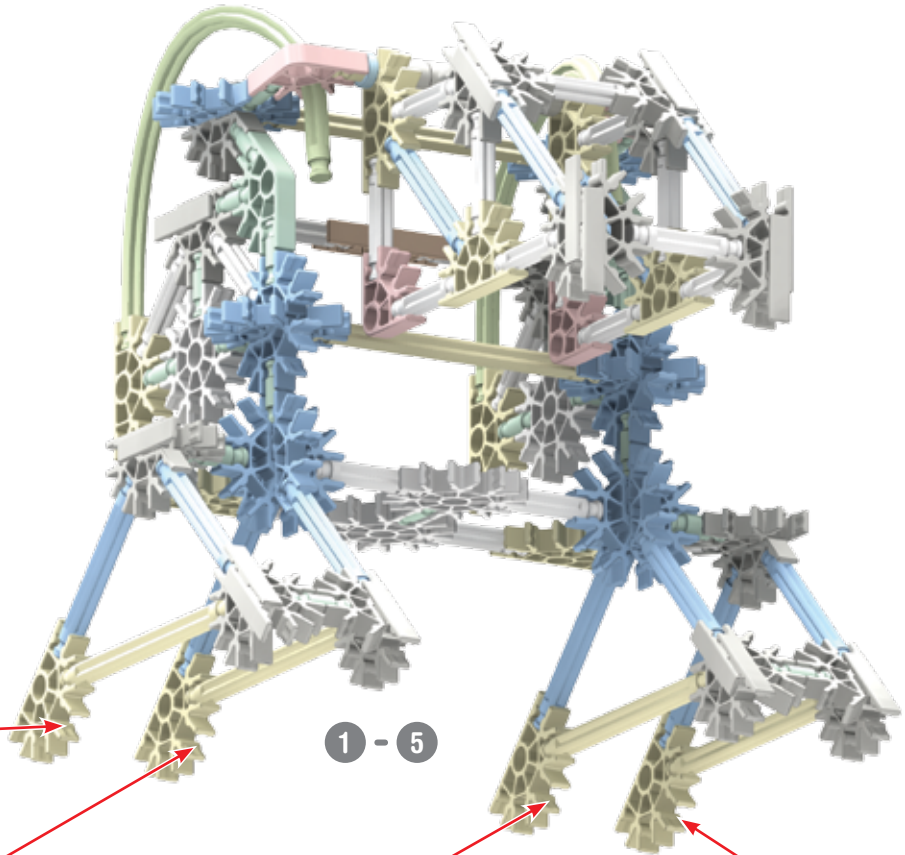

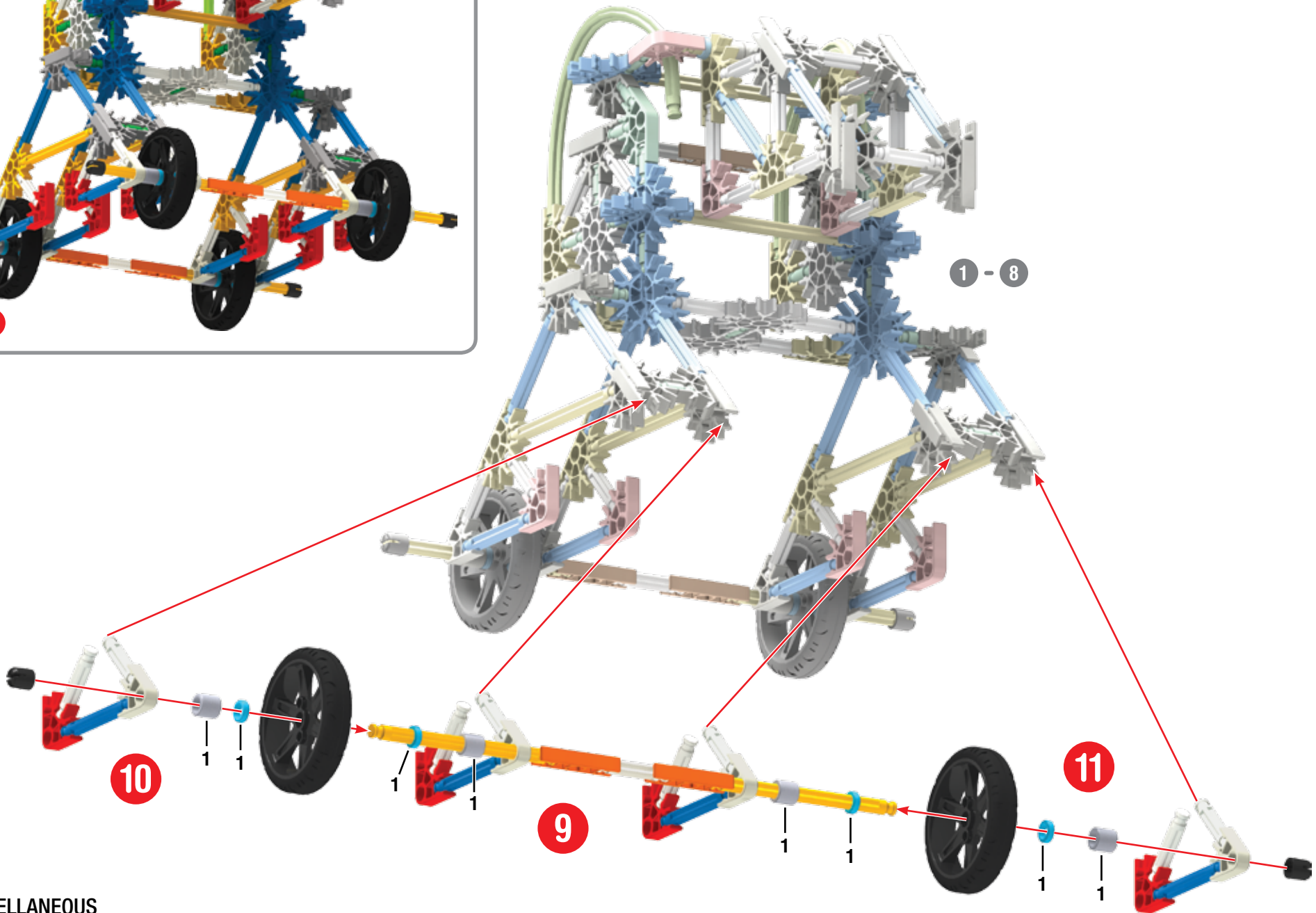
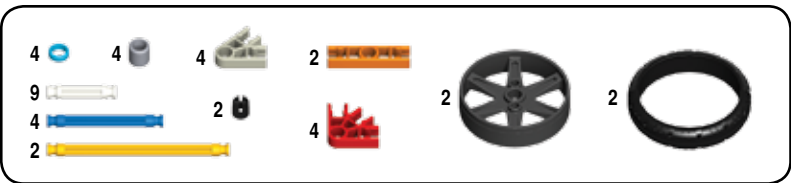
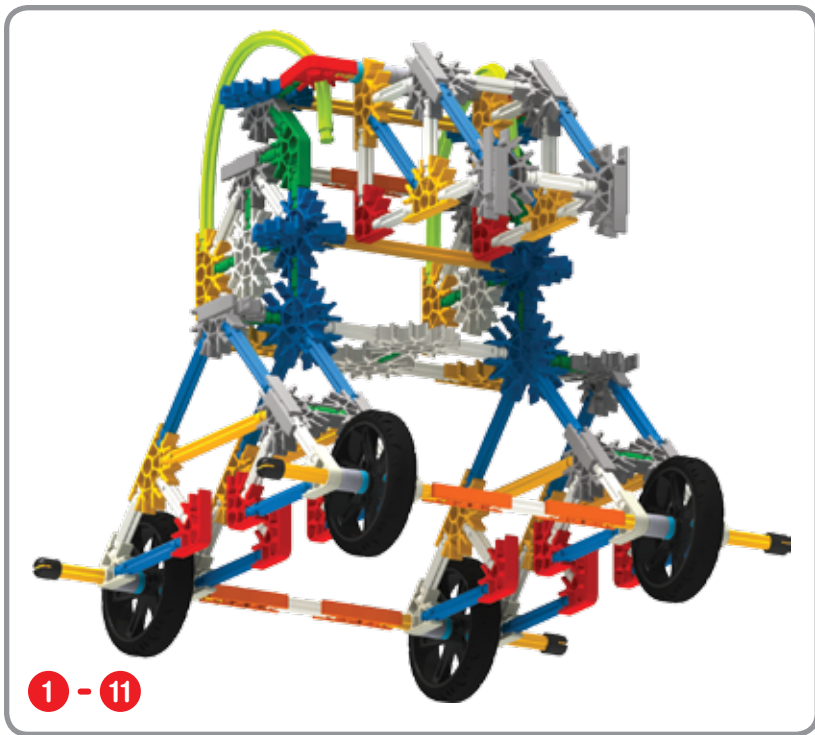

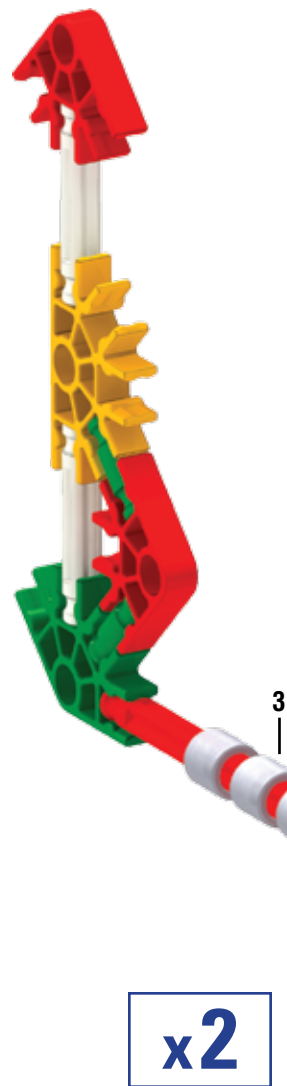

x2

- |    |  |   |  |   |  |   |  |  |
|----|--|---|--|---|--|---|--|--|
| 20 |  | 2 |  | 4 |  | 8 |  |  |
| 4  |  |   |  |   |  |   |  |  |
| 8  |  |   |  |   |  |   |  |  |
| 2  |  |   |  |   |  |   |  |  |
| 12 |  | 2 |  | 2 |  |   |  |  |

12

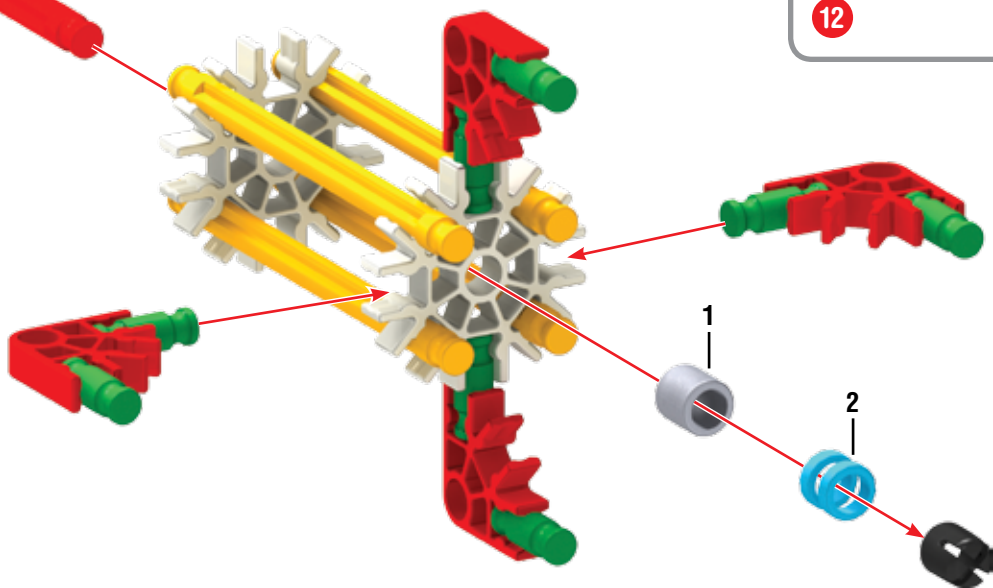

x2

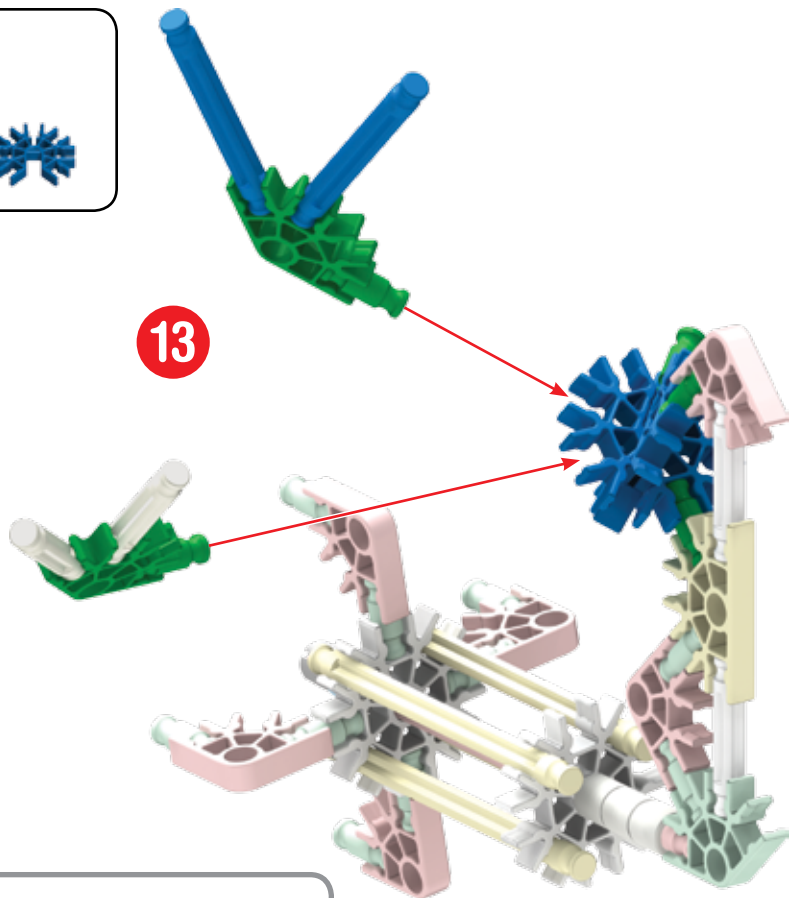
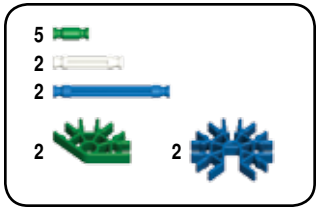

13

12



12 - 13

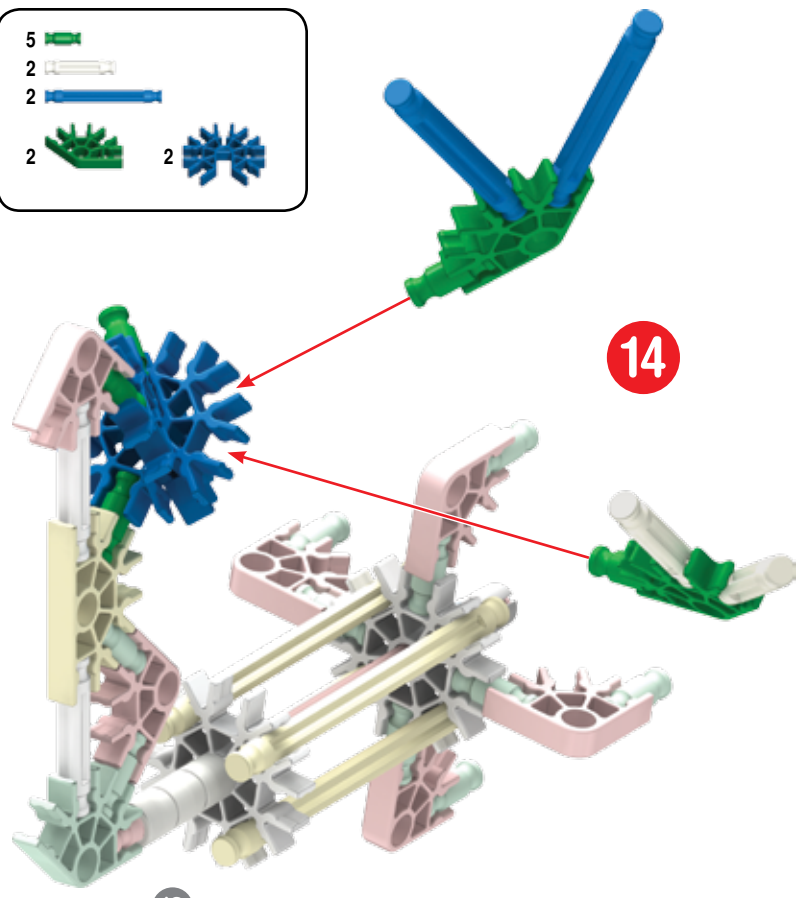
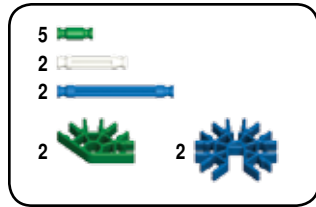

14

12



12, 14

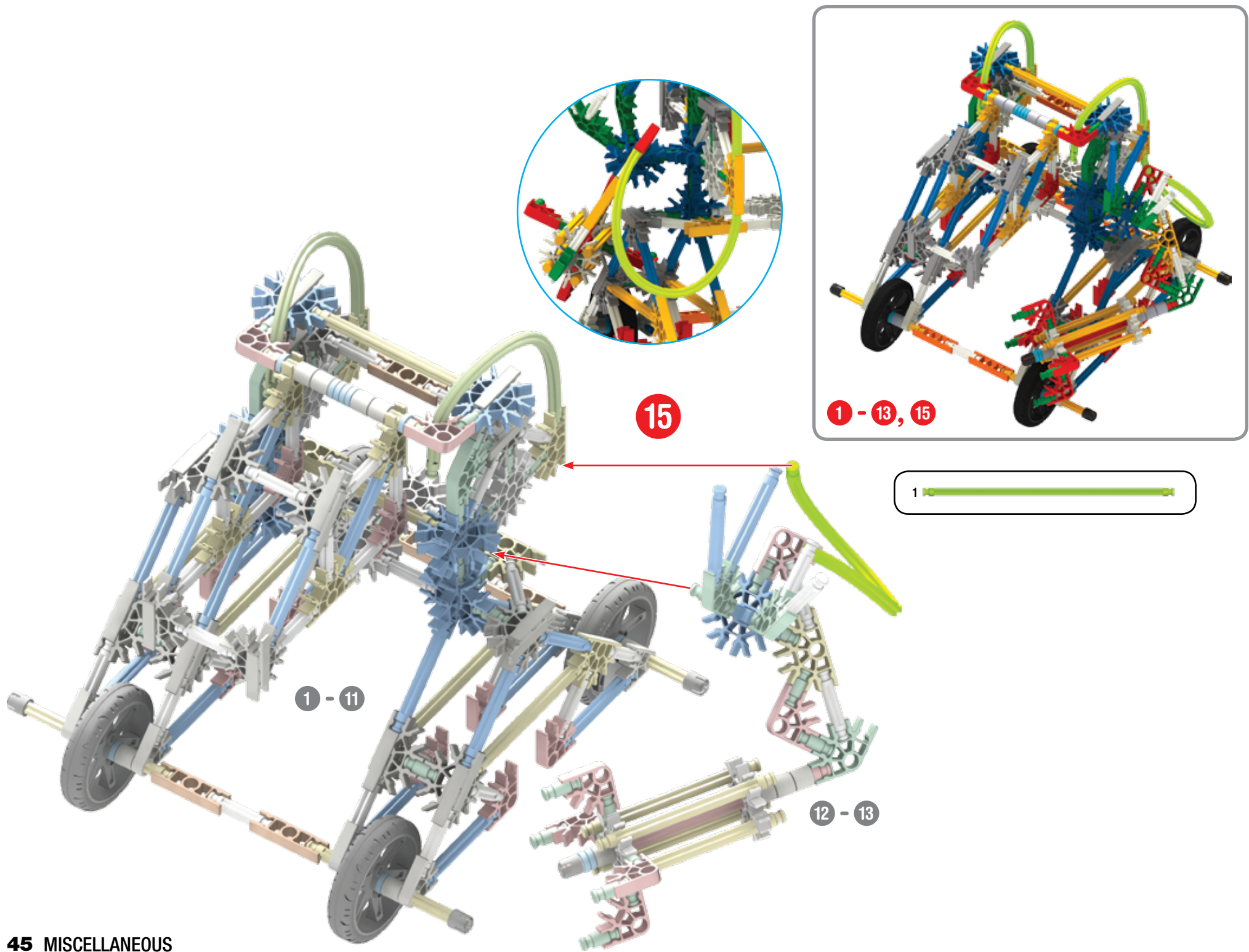

# Mech

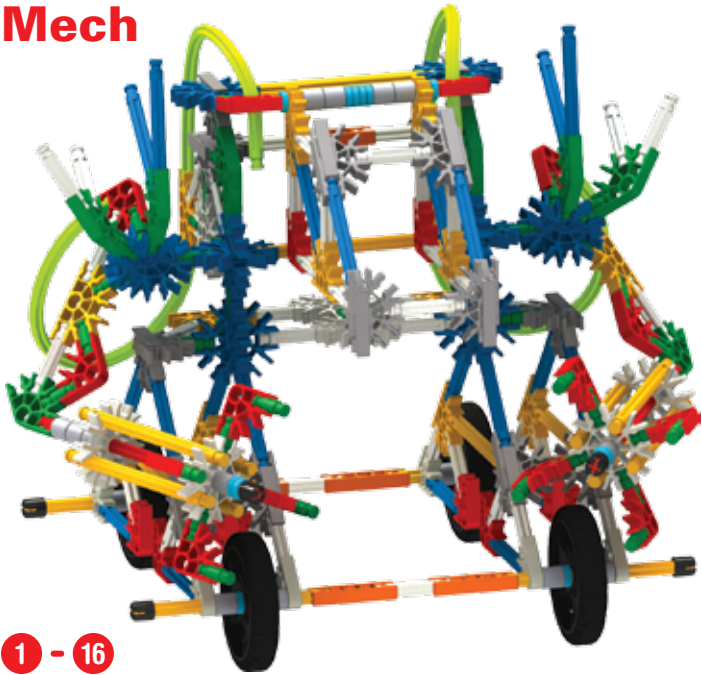

1 - 16

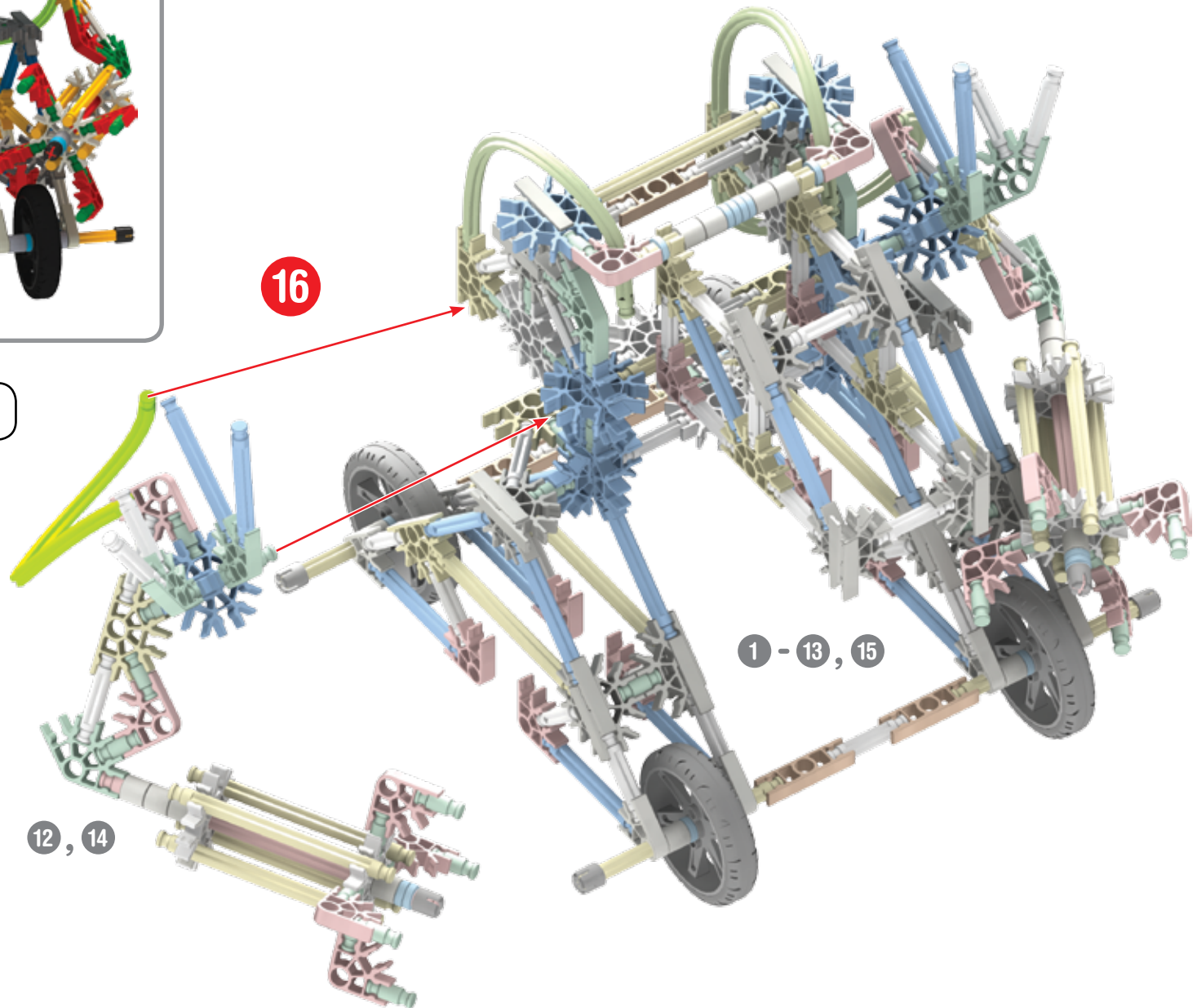

16

1 - 13, 15

12, 14



**Metal  
Detector**

- |    |  |  |   |  |   |
|----|--|--|---|--|---|
| 10 |  |  | 8 |  | 8 |
| 12 |  |  |   |  |   |
| 4  |  |  |   |  |   |

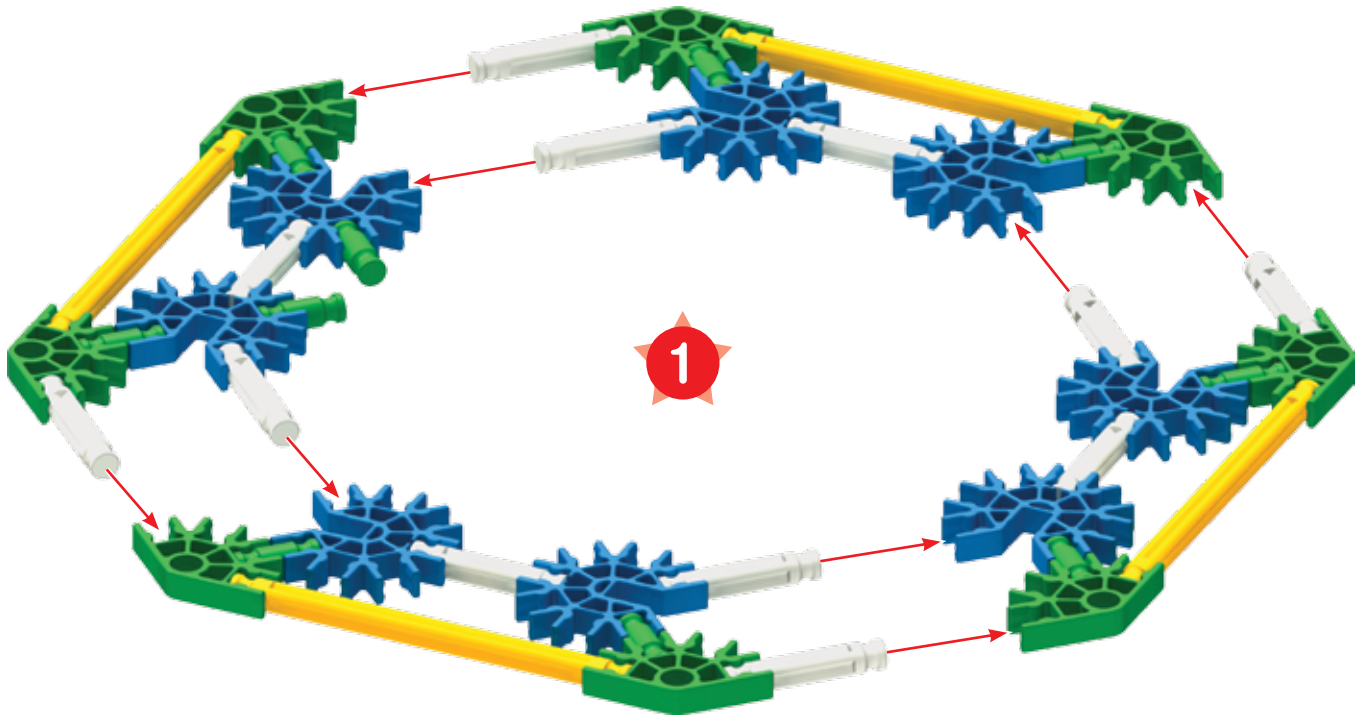
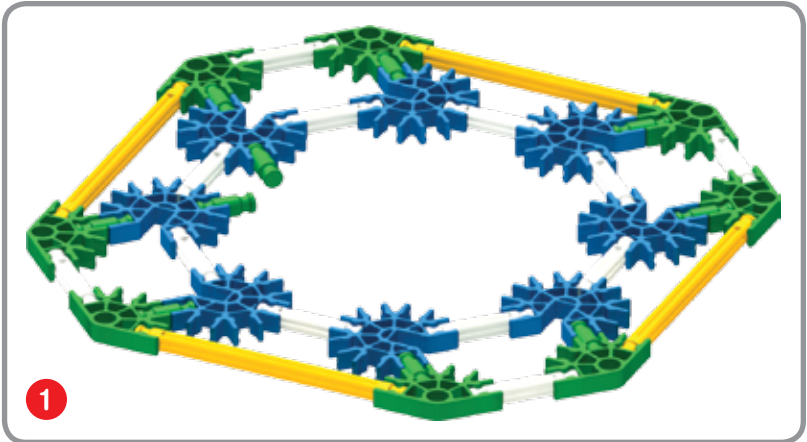



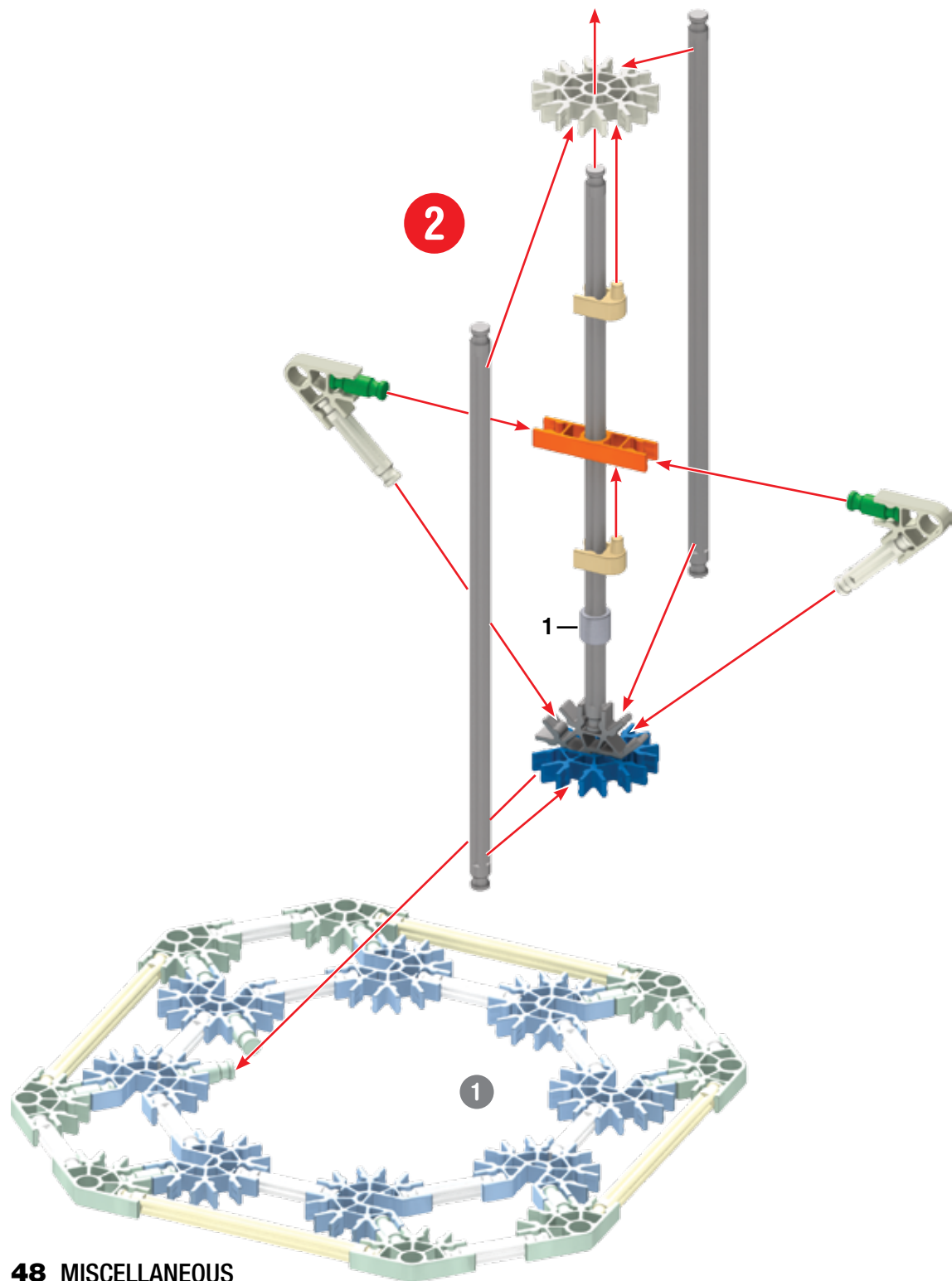

2		1		2		1	
2							
3							
2		1		1		1	

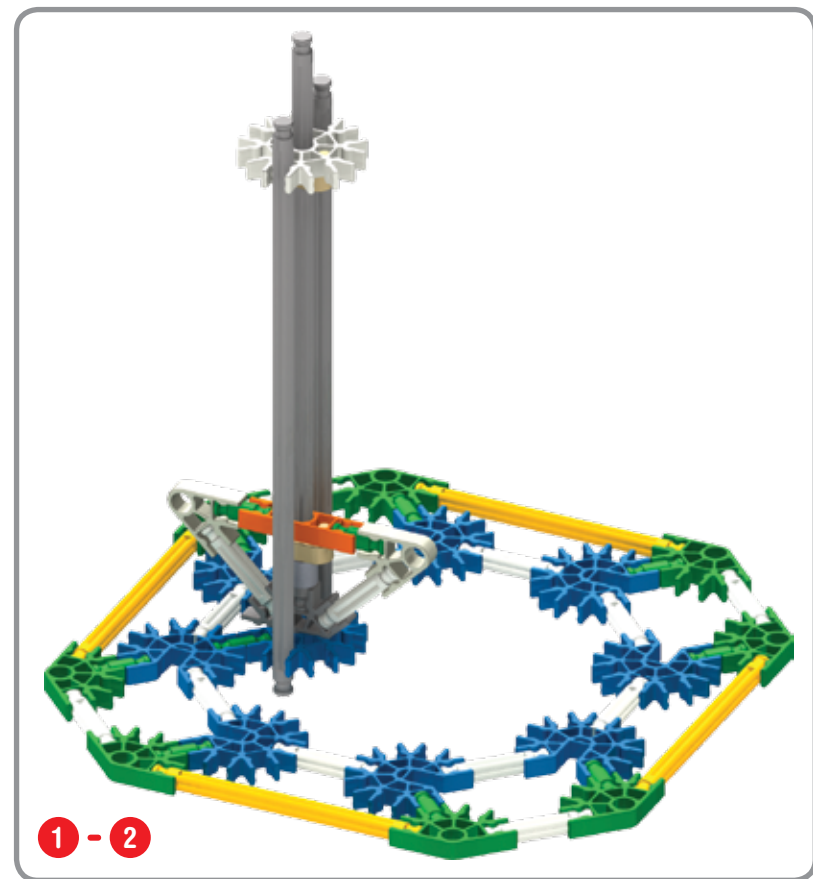

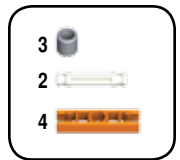
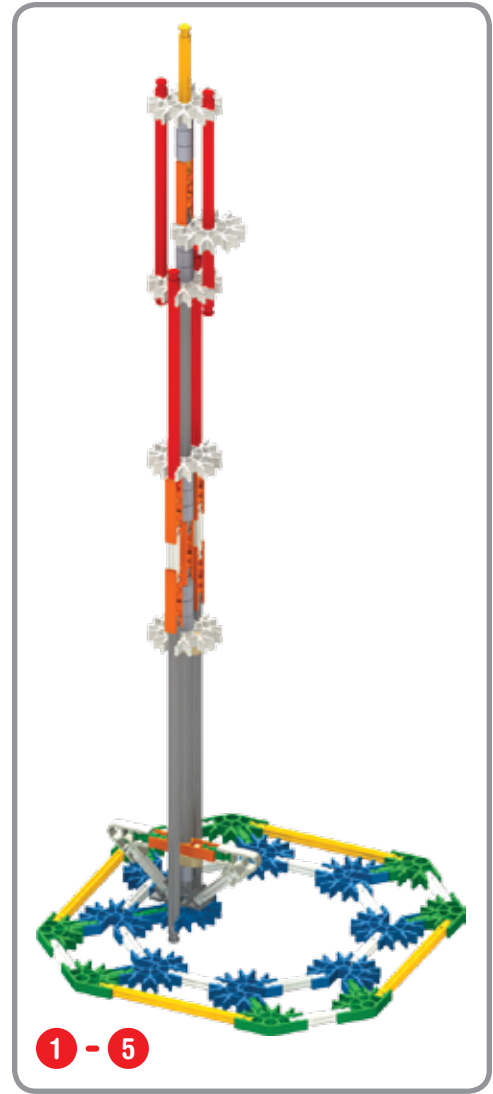
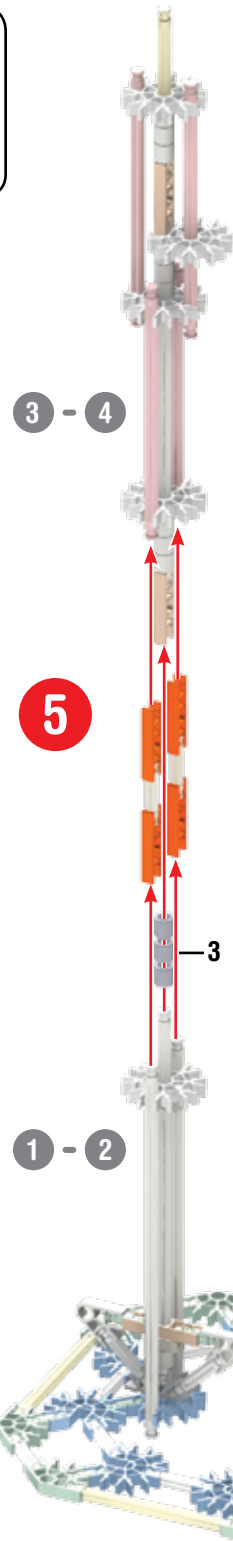
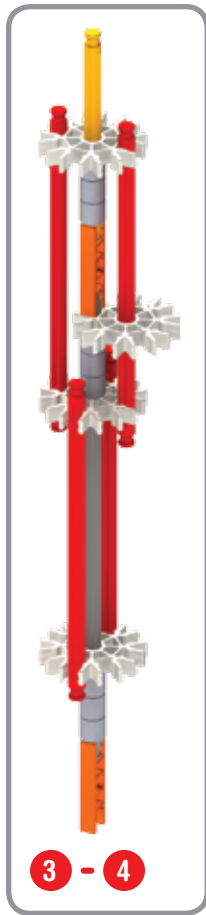
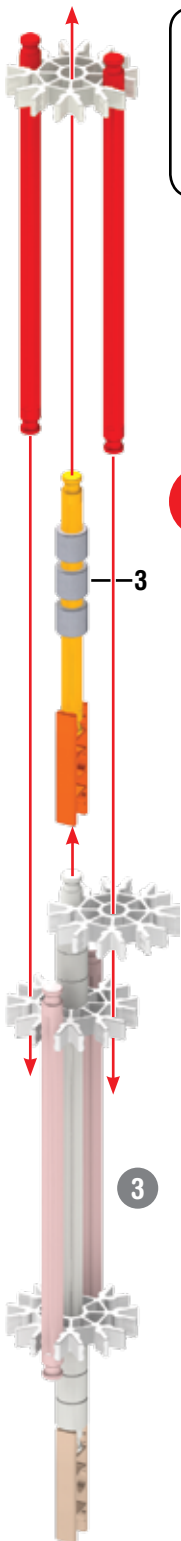
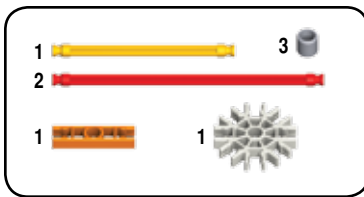
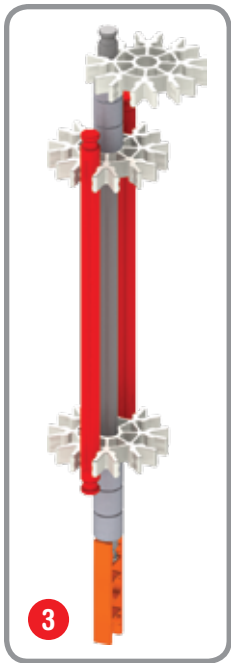
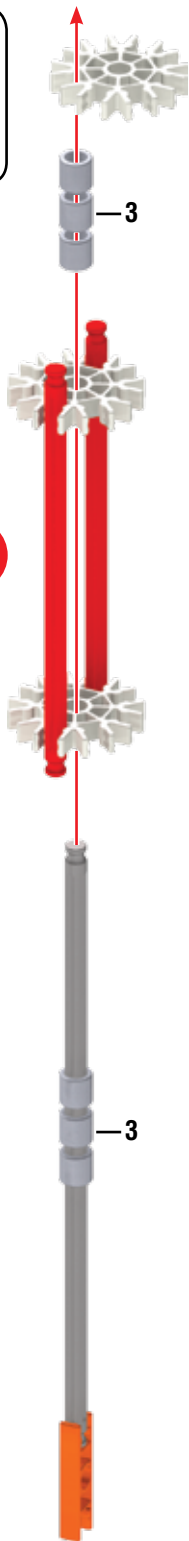
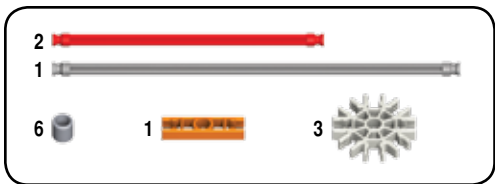

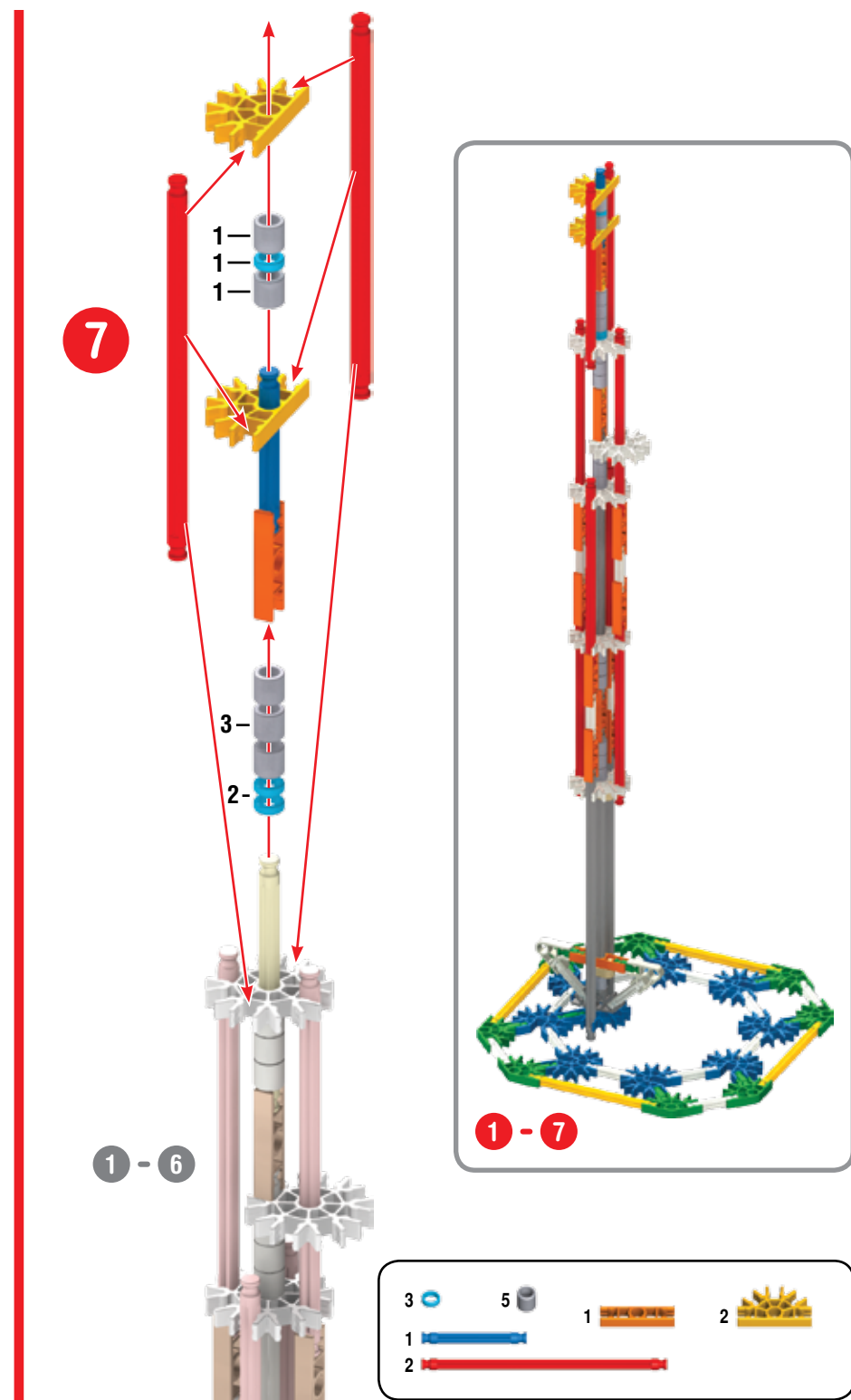
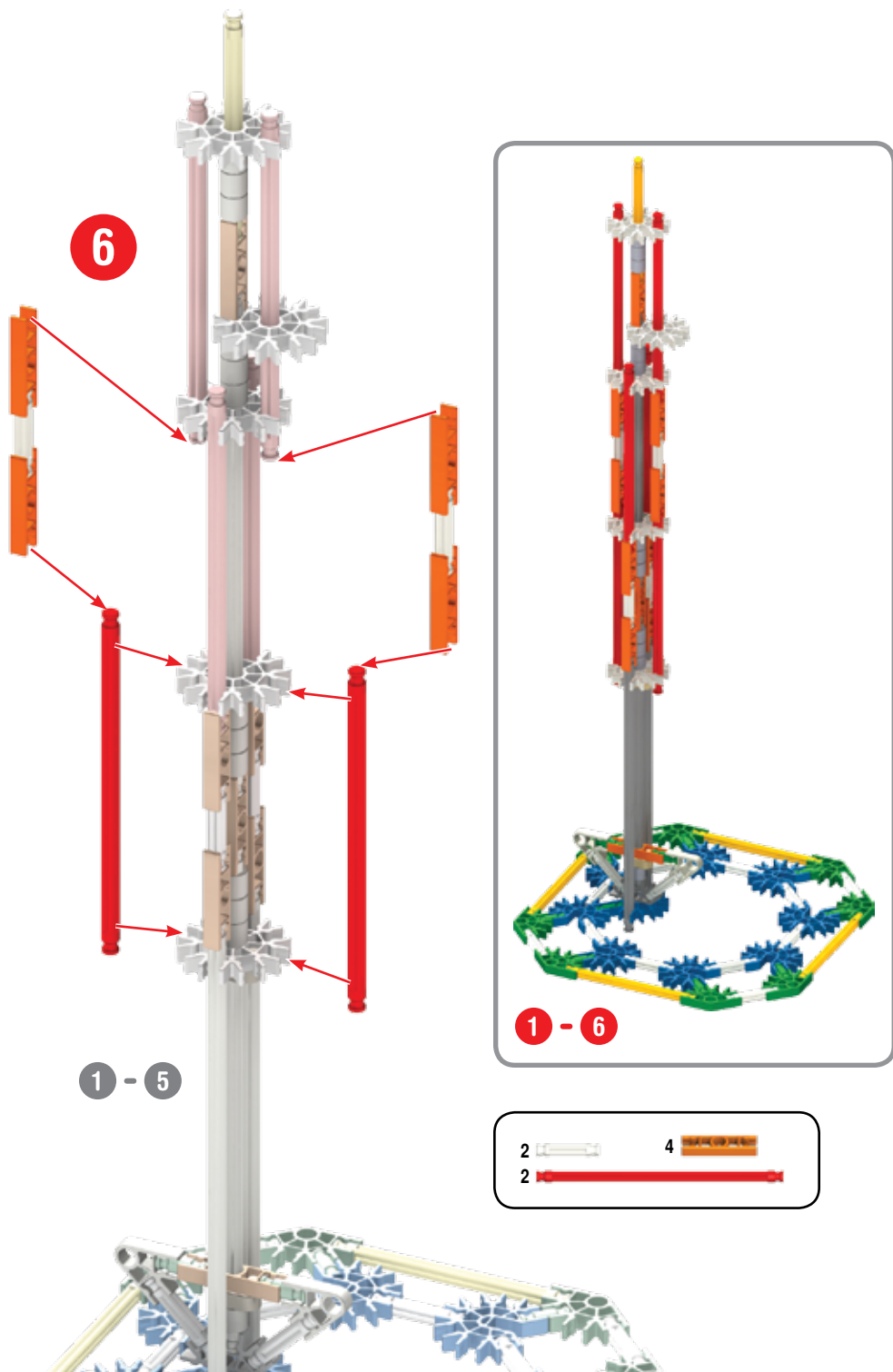

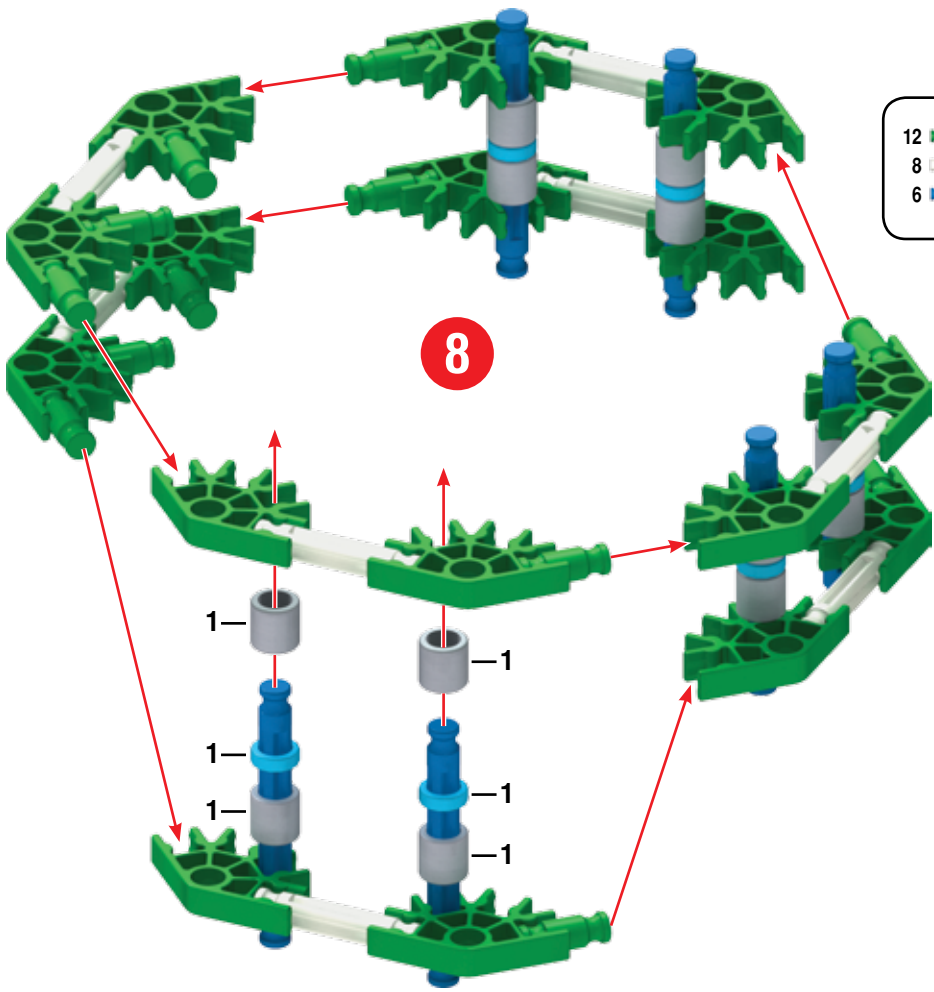

- |    |  |   |  |    |  |
|----|--|---|--|----|--|
| 12 |  | 6 |  | 12 |  |
| 8  |  | 6 |  | 16 |  |
| 6  |  |   |  |    |  |

8

- 1
- 1
- 1
- 1
- 1
- 1
- 1
- 1

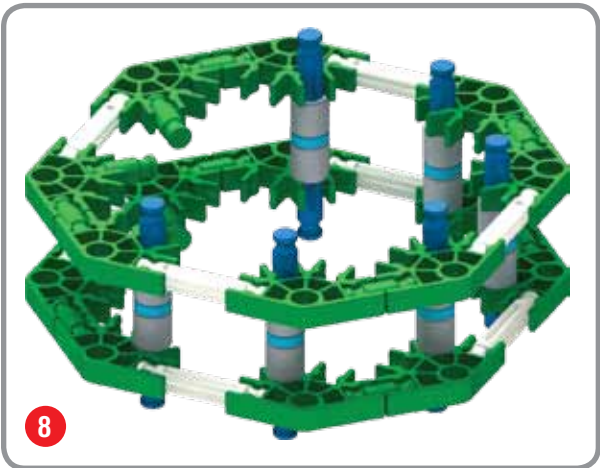

8

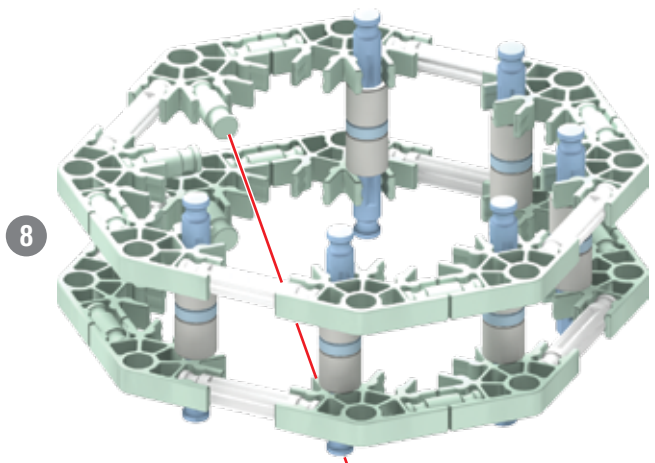

8

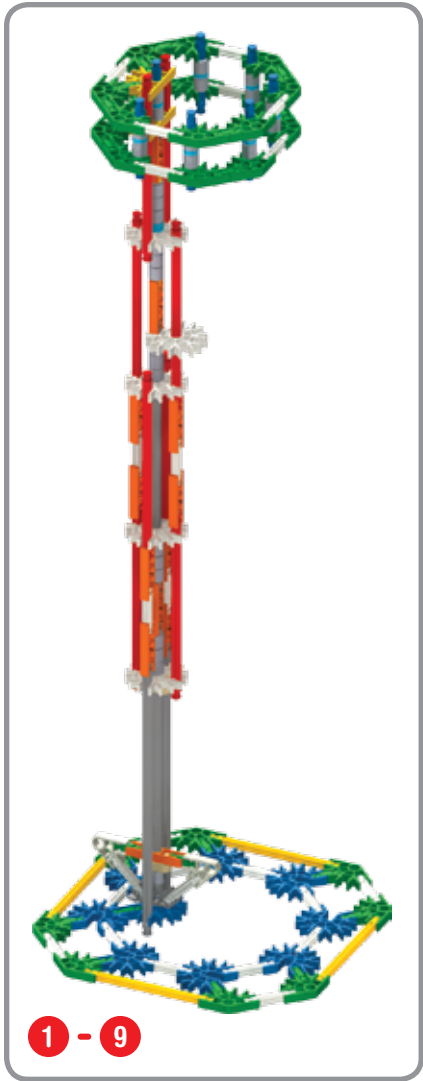

1 - 9

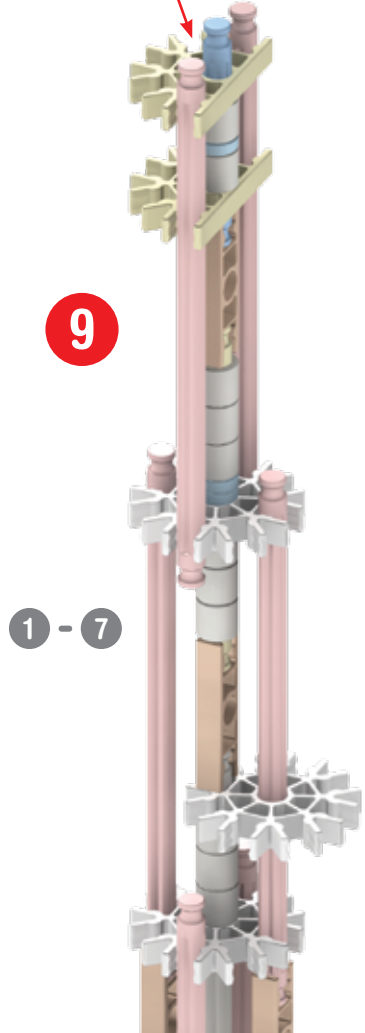

9

1 - 7

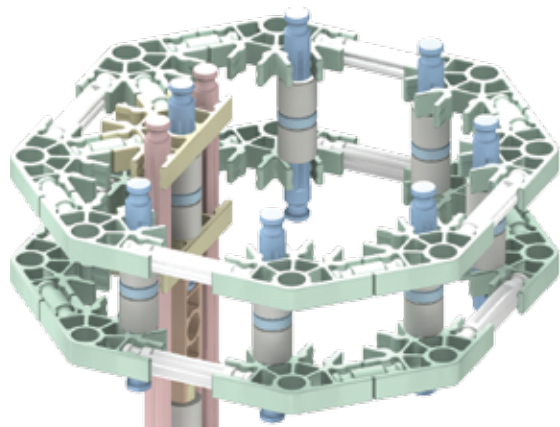

1 - 9

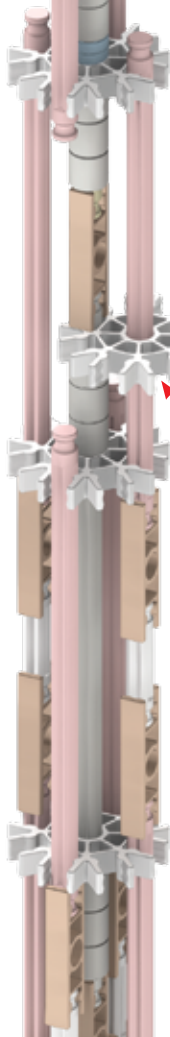
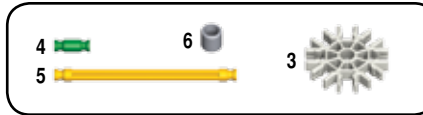

10

11

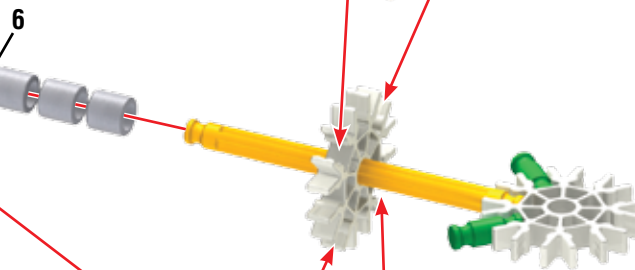
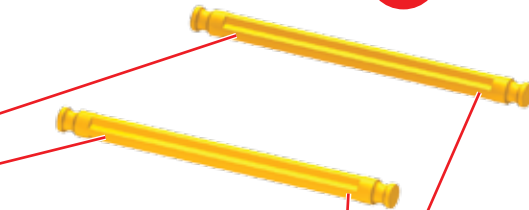

12

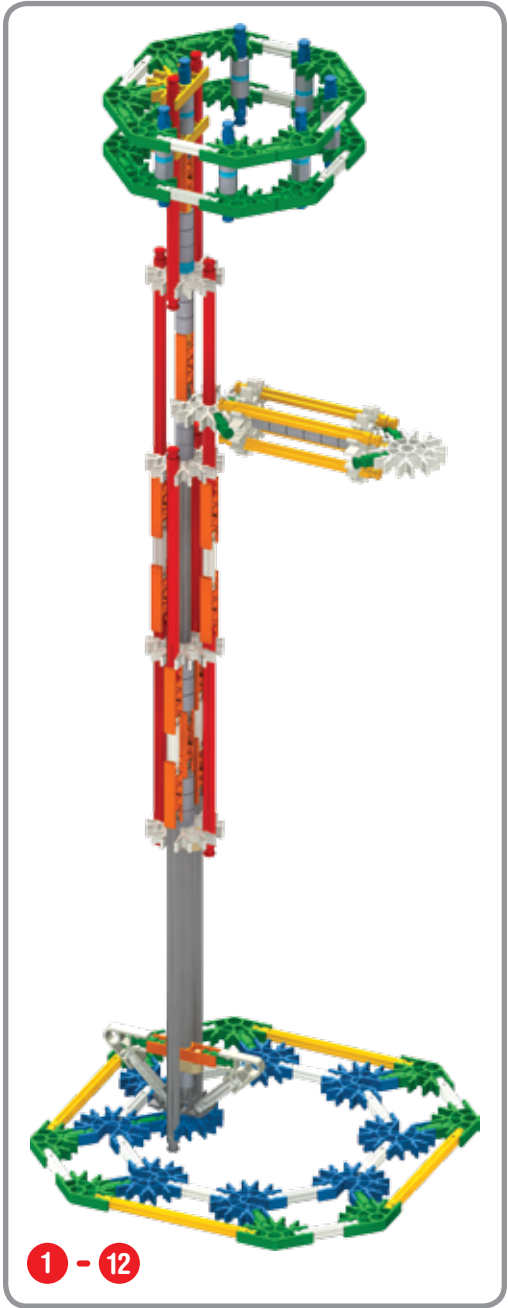
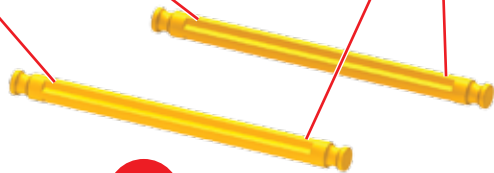

1 - 12

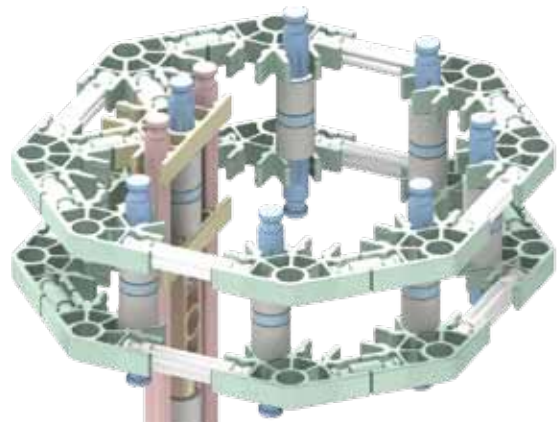

- |   |  |   |  |
|---|--|---|--|
| 6 |  | 4 |  |
| 4 |  |   |  |
| 2 |  |   |  |
| 1 |  |   |  |
| 2 |  | 2 |  |

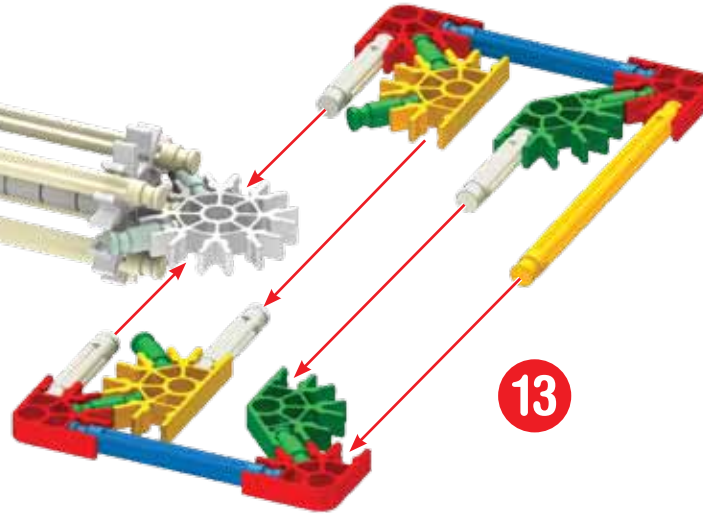

1 - 12



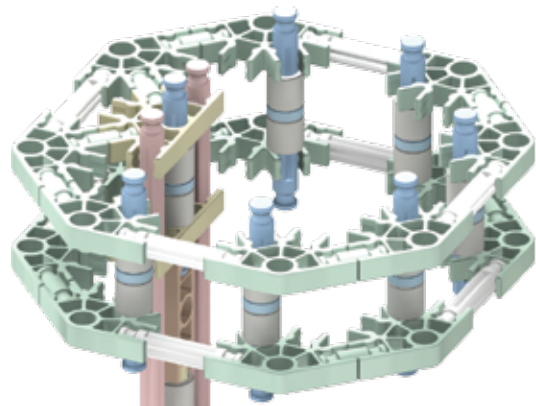

- 4 [white pin]
- 2 [blue pin]
- 2 [yellow pin]
- 8 [black pin]
- 4 [blue bush]
- 4 [red connector]

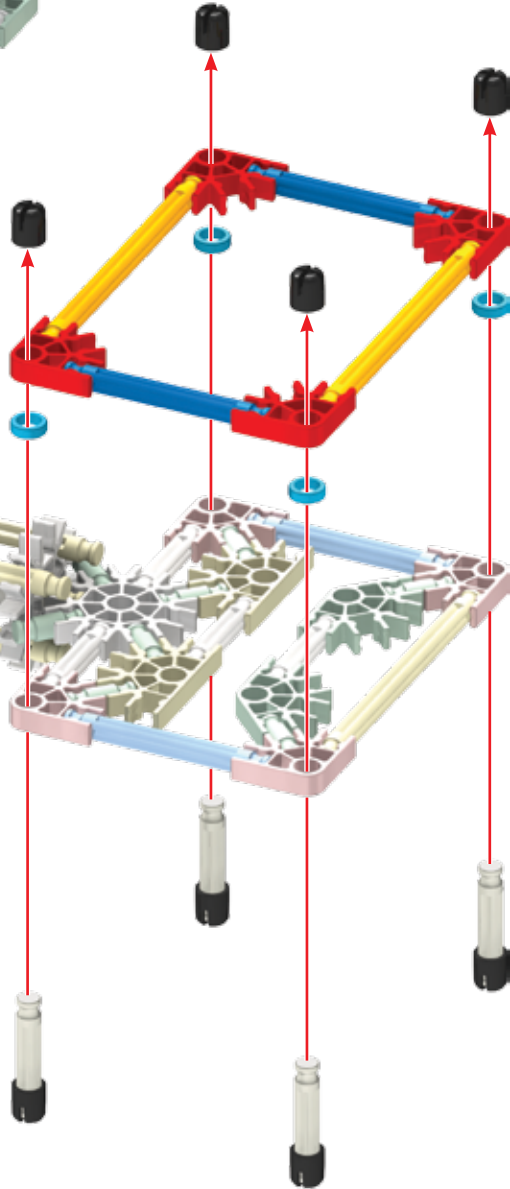

14

1 - 13



**Metal  
Detector**

1 - 14

# Picture Frame

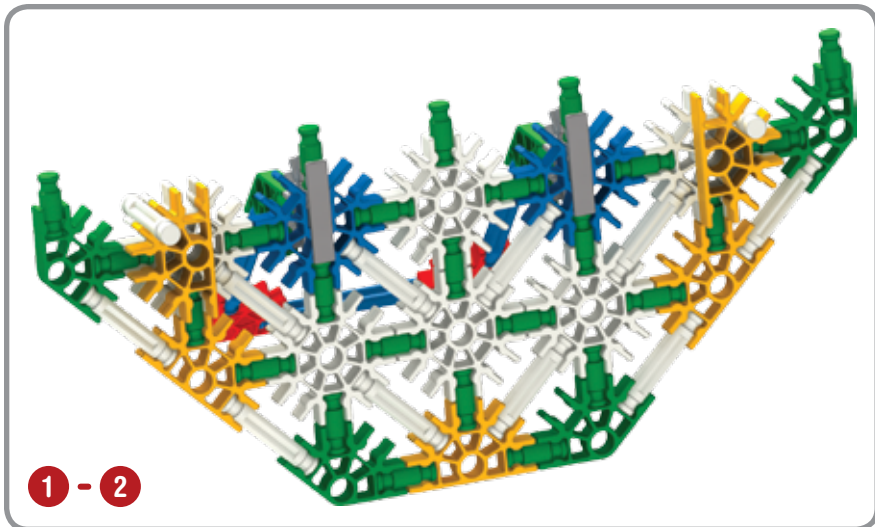
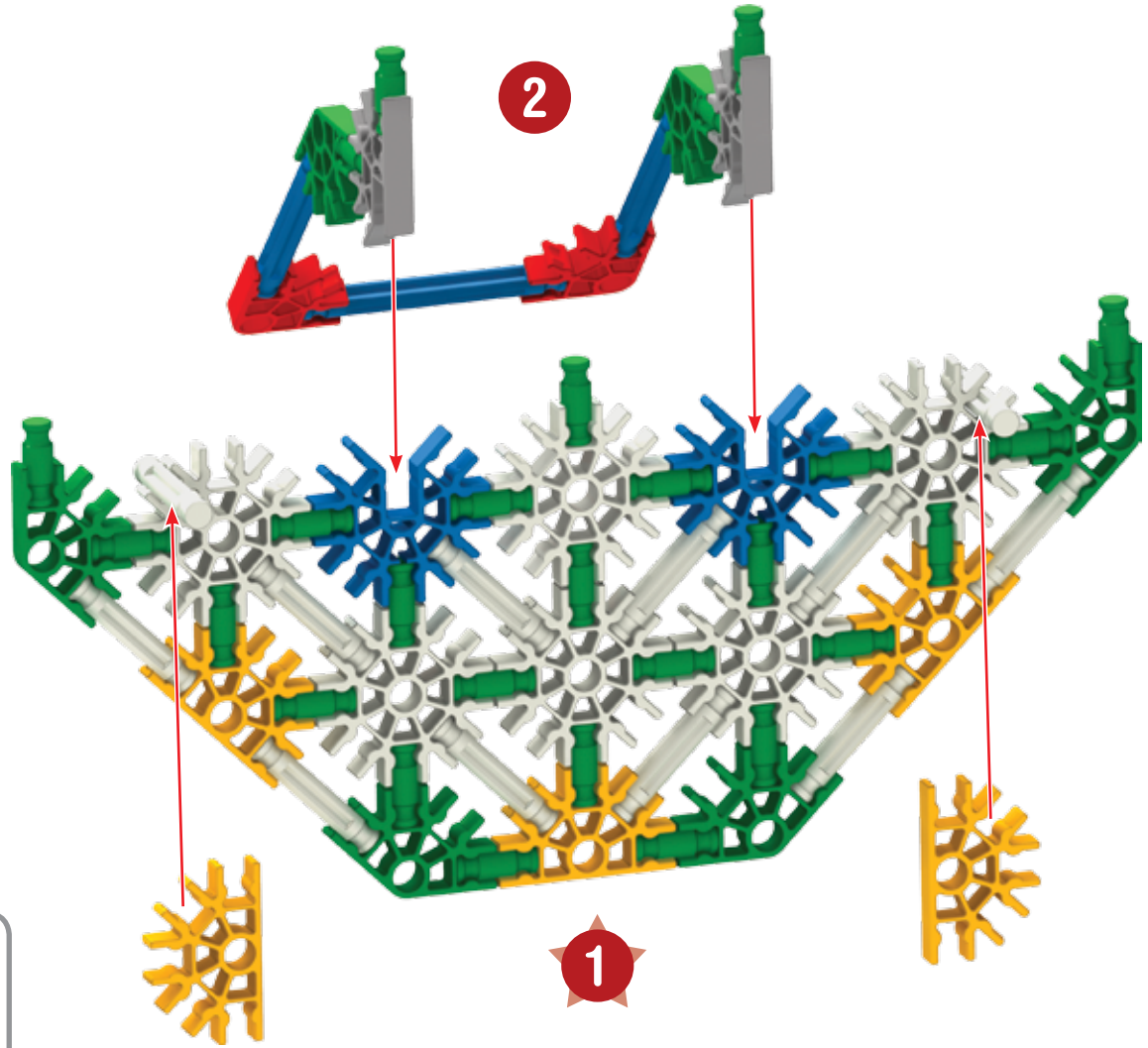
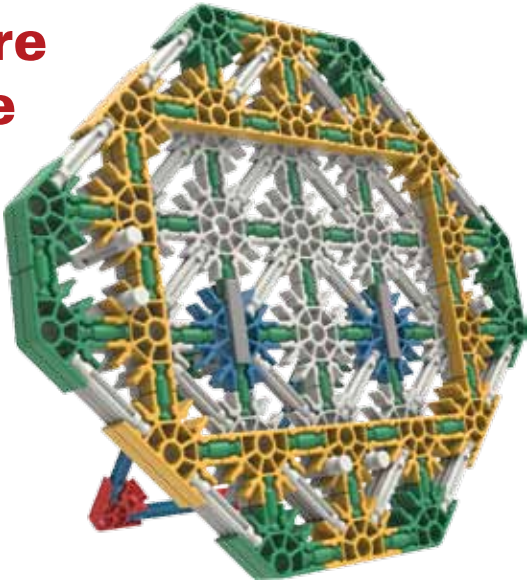

- |    |  |   |  |   |  |   |  |
|----|--|---|--|---|--|---|--|
| 27 |  | 2 |  | 6 |  | 6 |  |
| 12 |  |   |  |   |  |   |  |
| 3  |  |   |  |   |  |   |  |
| 5  |  | 2 |  | 2 |  |   |  |



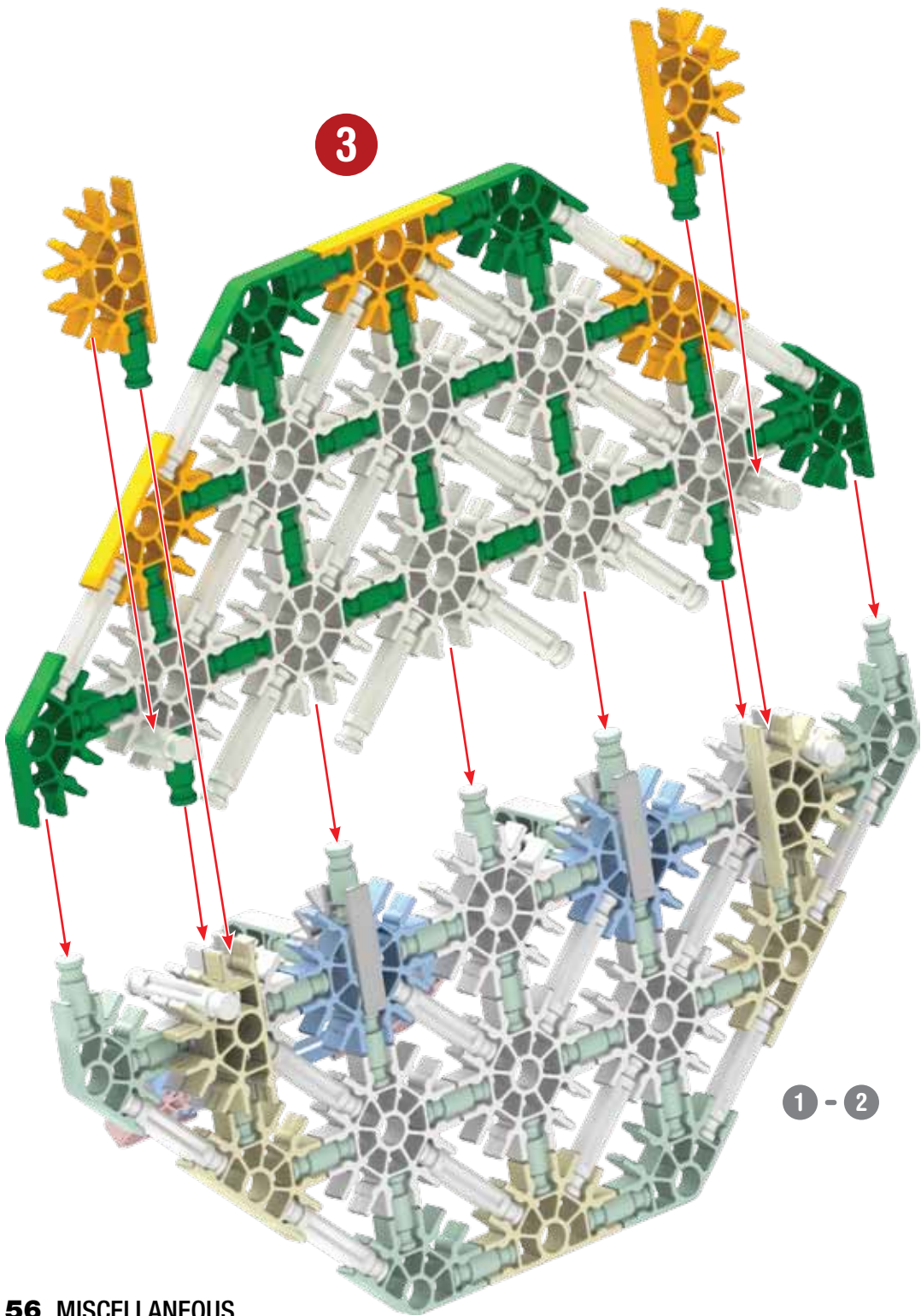

24		8	
16			
4		5	

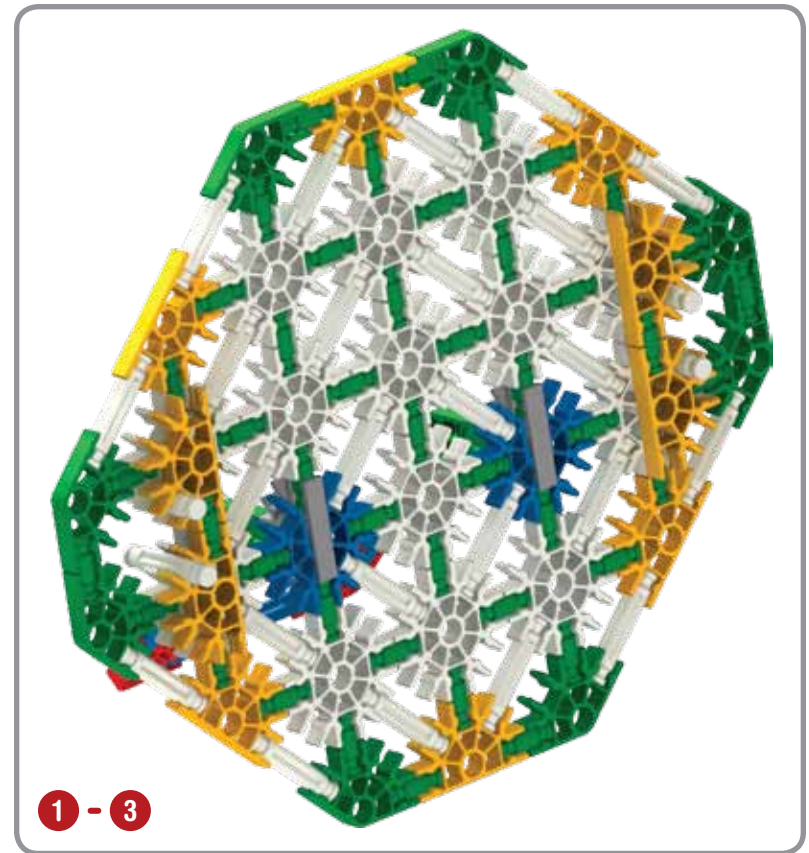

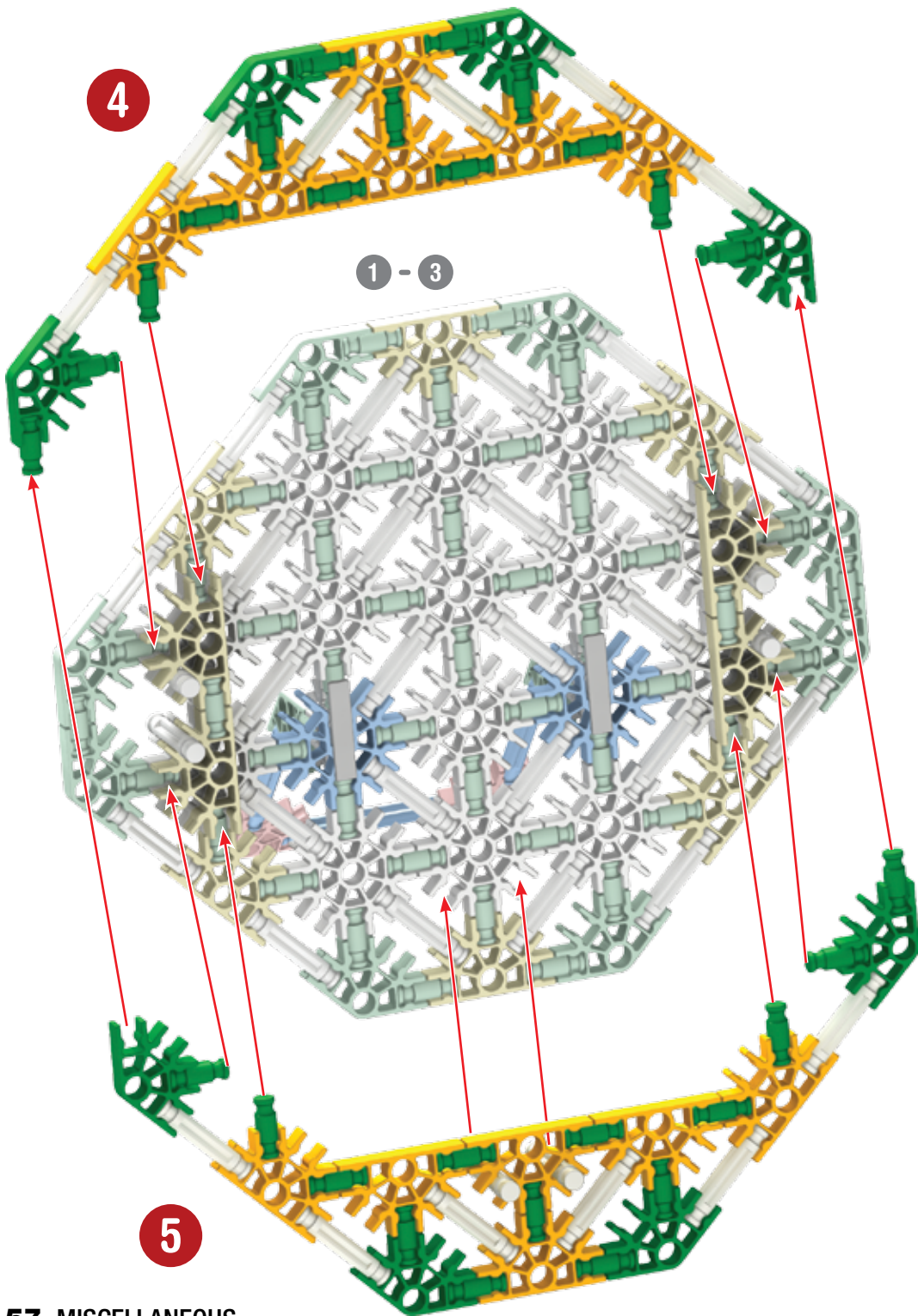

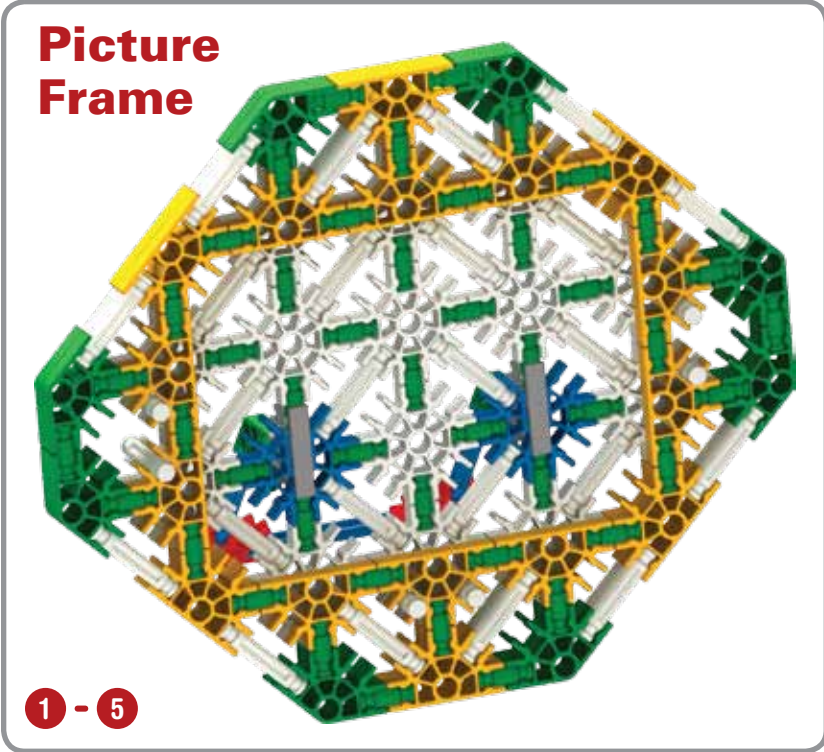

28		8		12	
14					

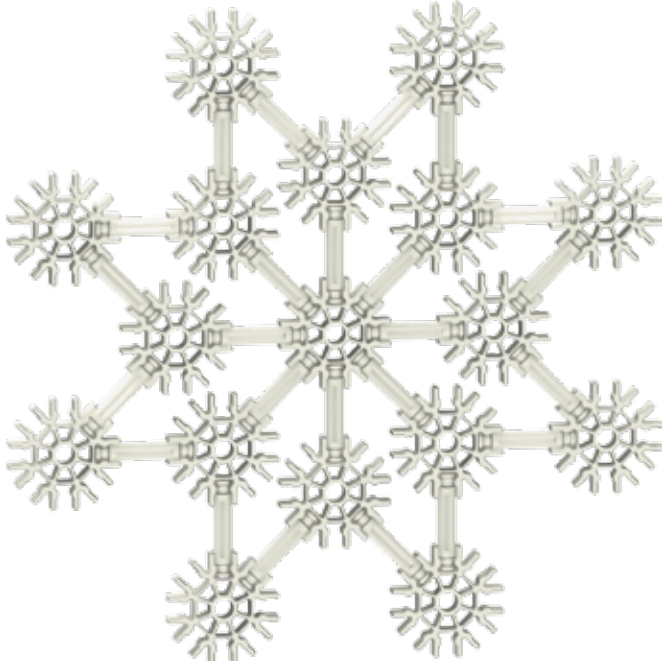

# Snowflake



24 

17 

1

2

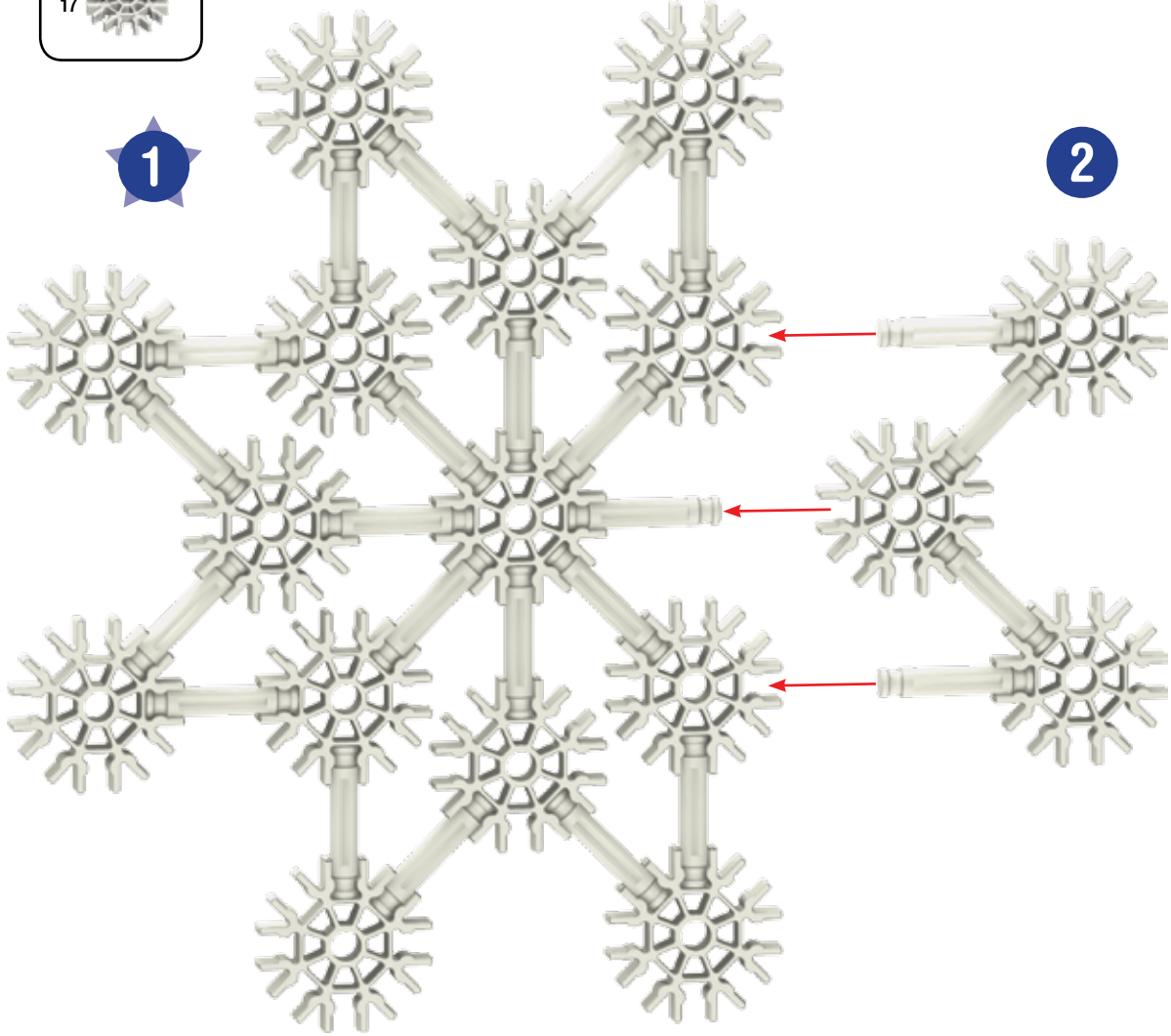



9		1		1		1	
4							
1							
4		4		2			

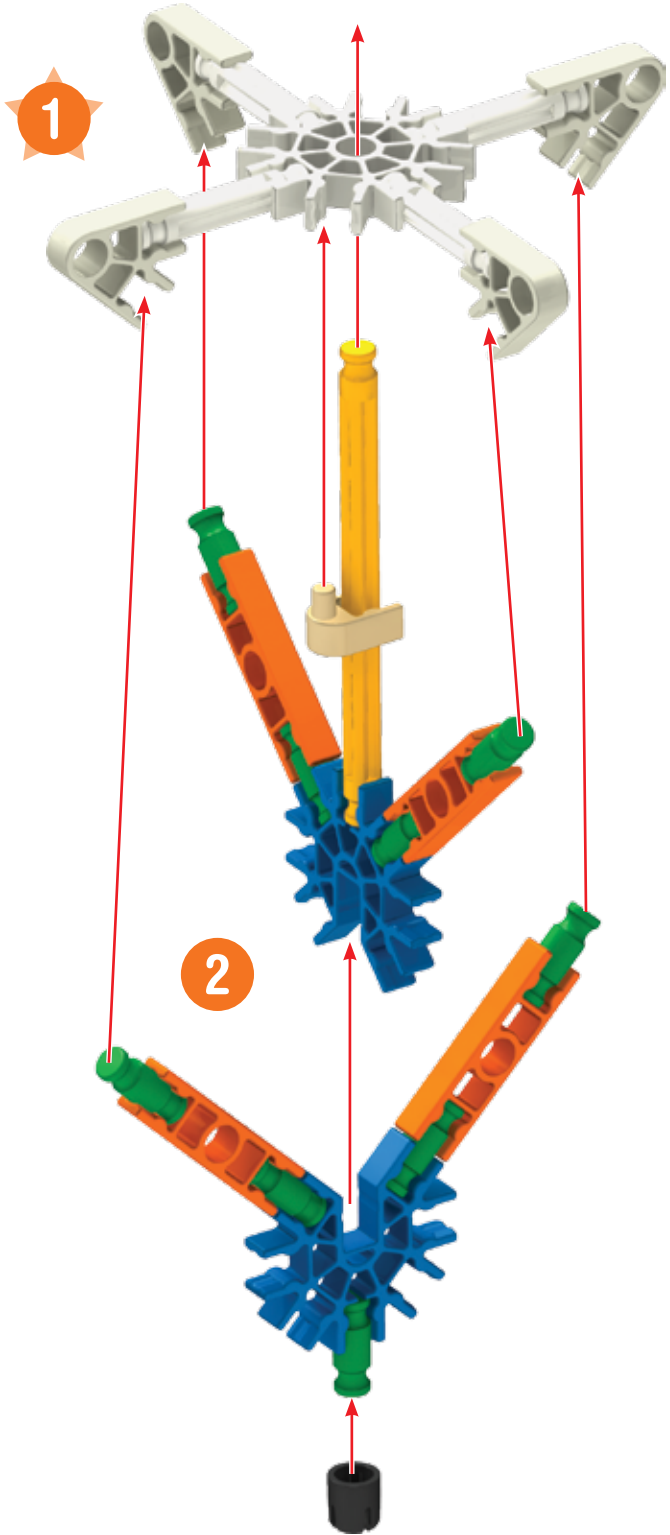

# Starburst

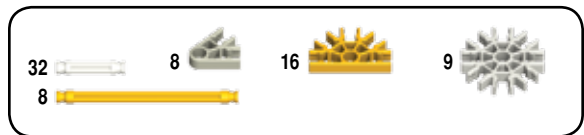
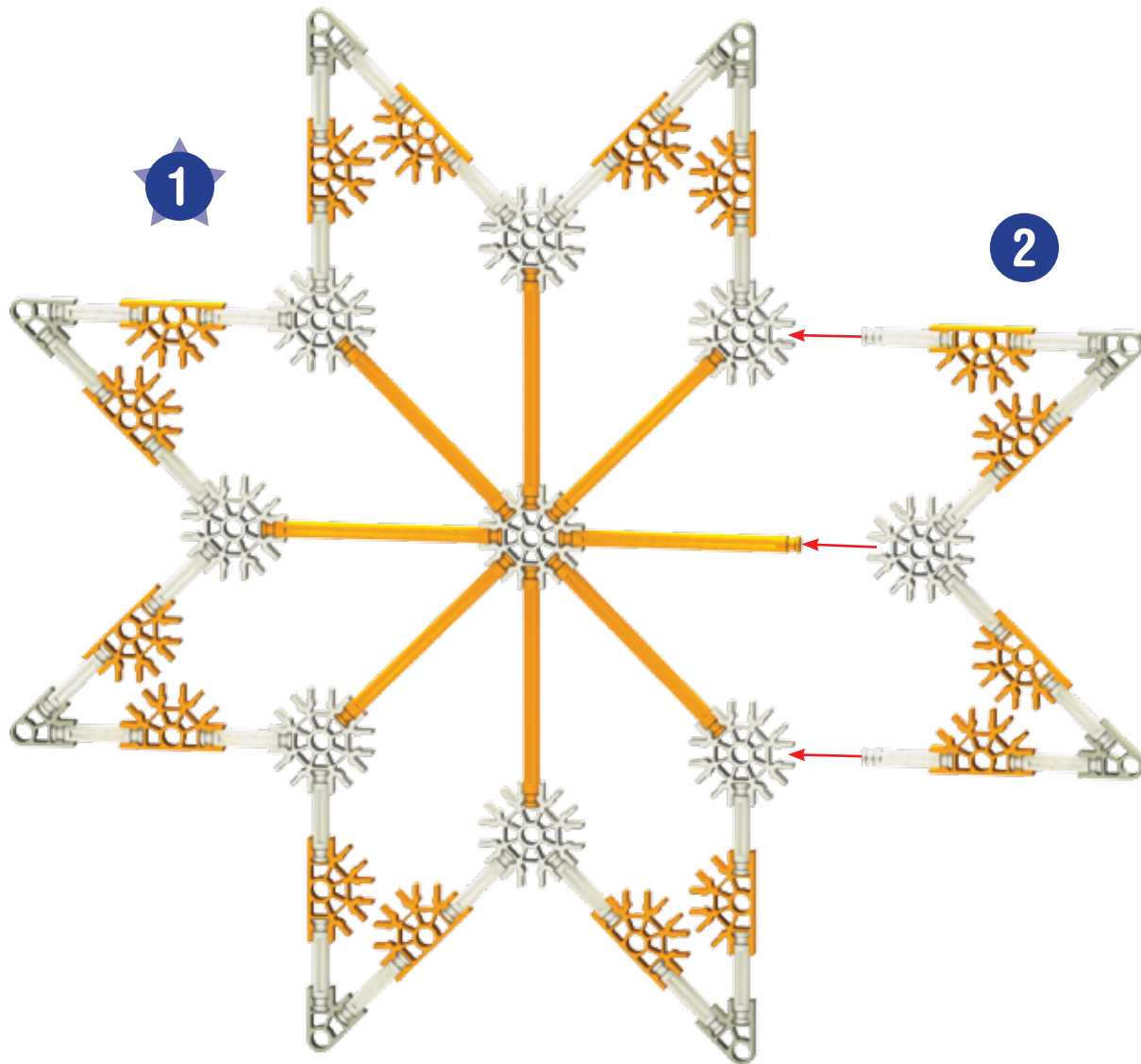

# Table Tennis

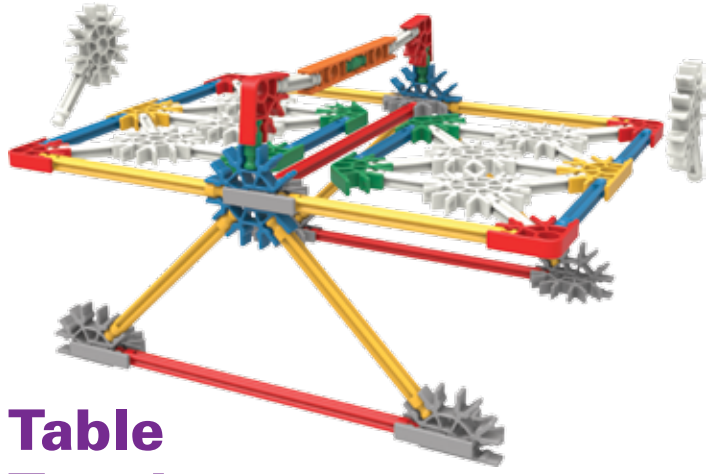

- 4 10 2
- 3

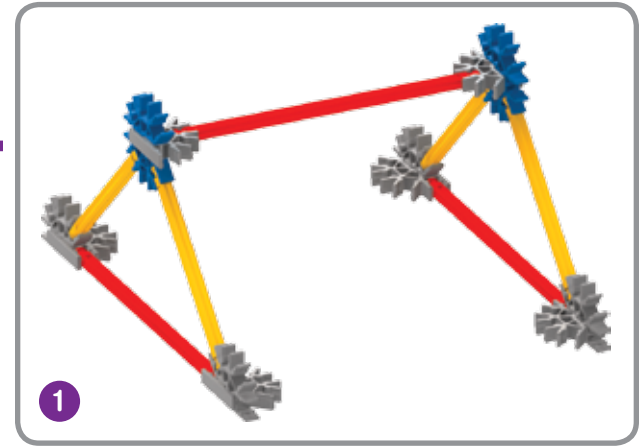
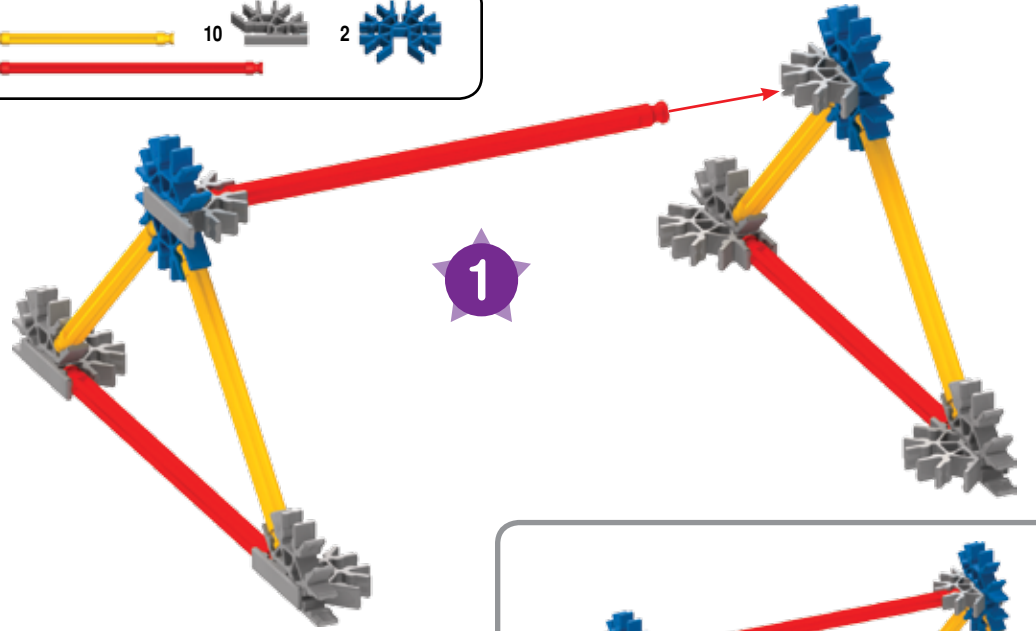

- 9 2
- 3
- 2
- 2
- 1
- 3

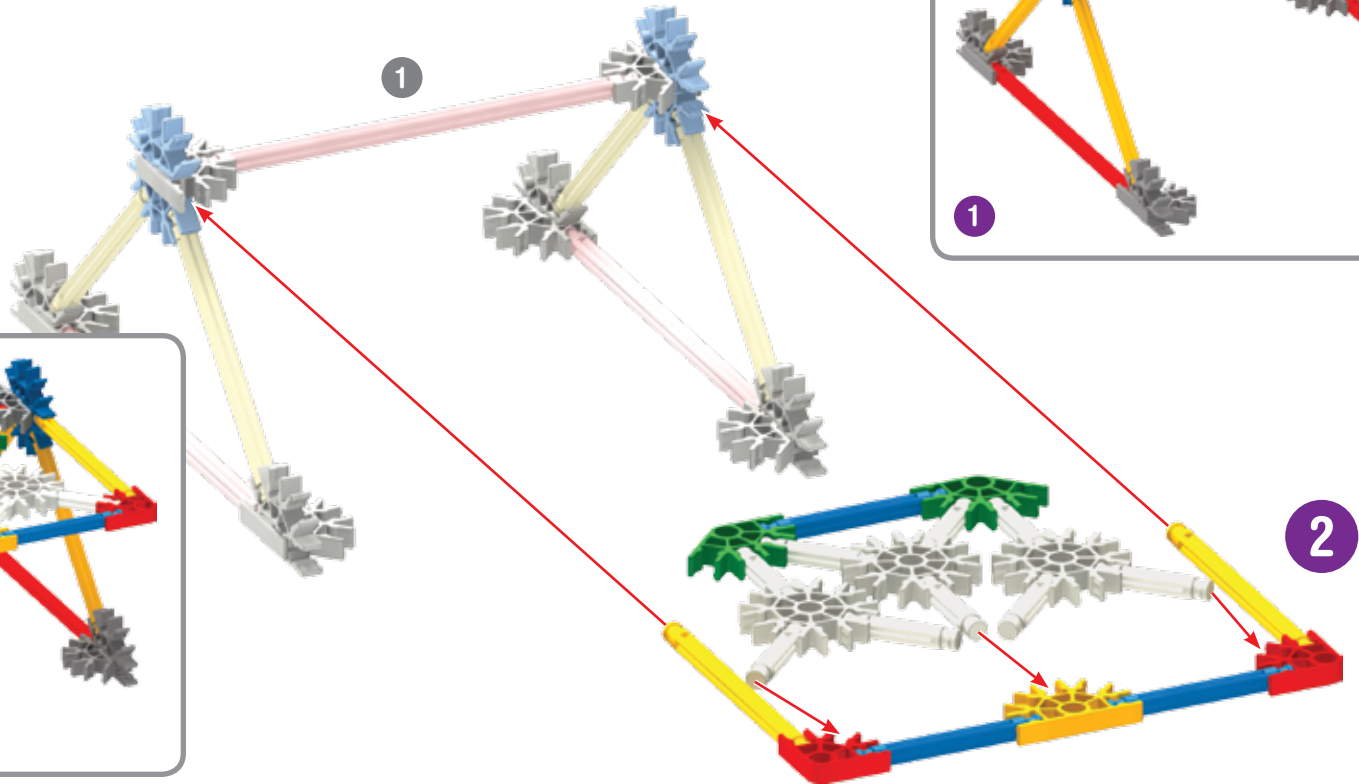
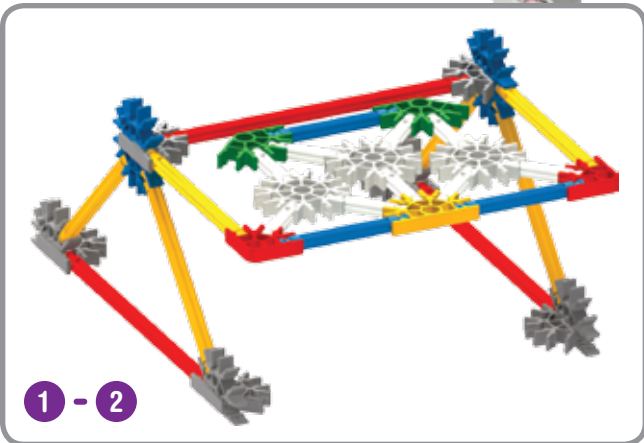

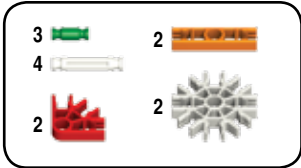
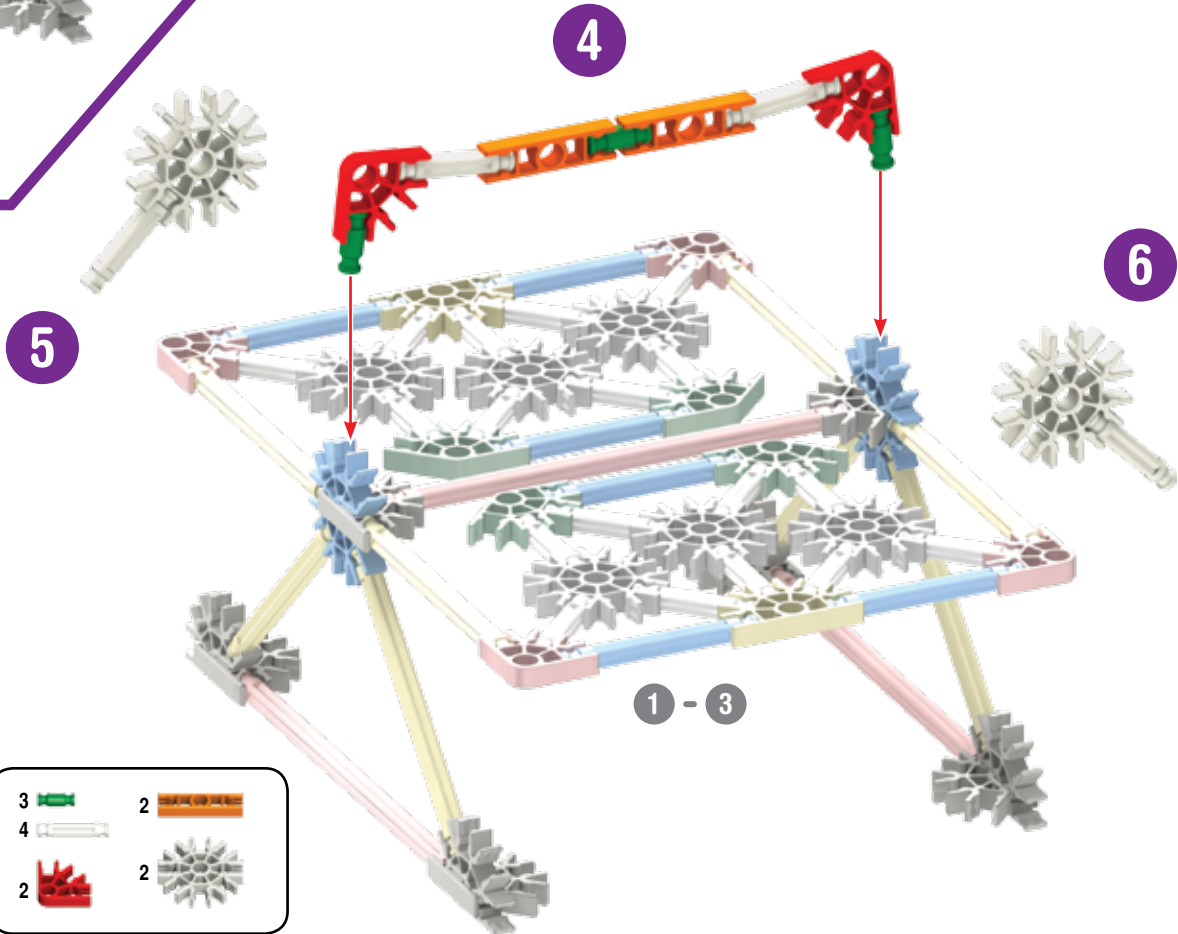
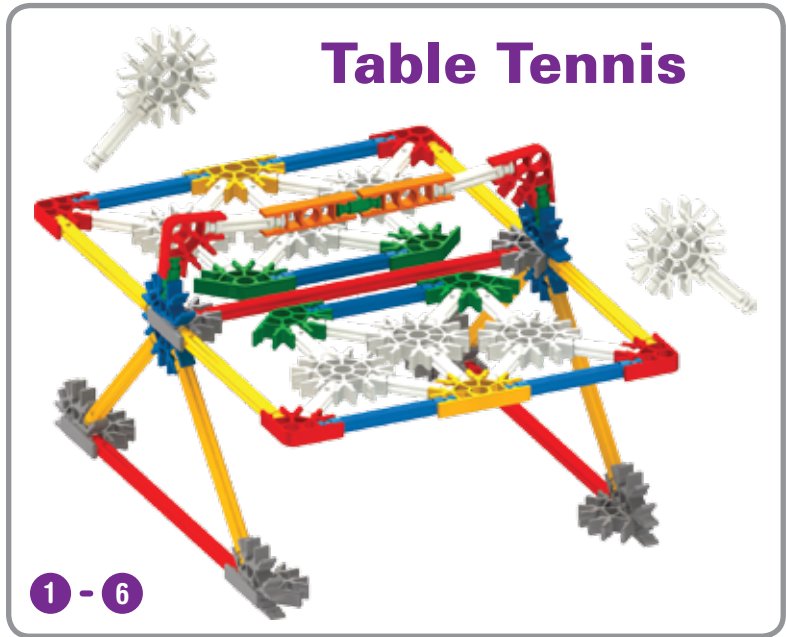
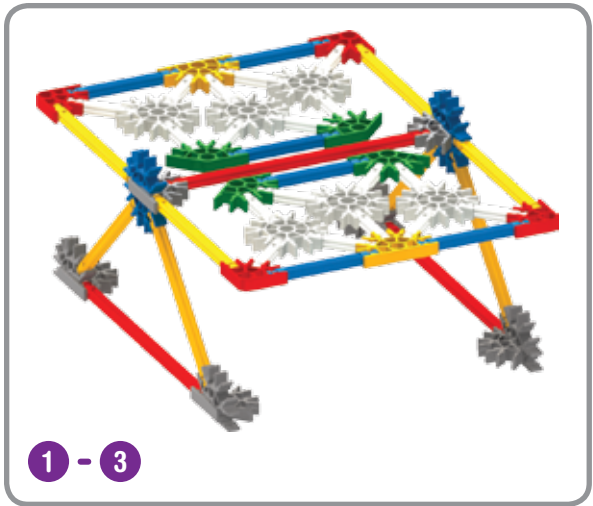
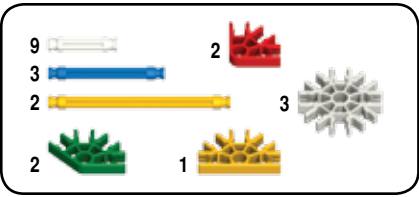
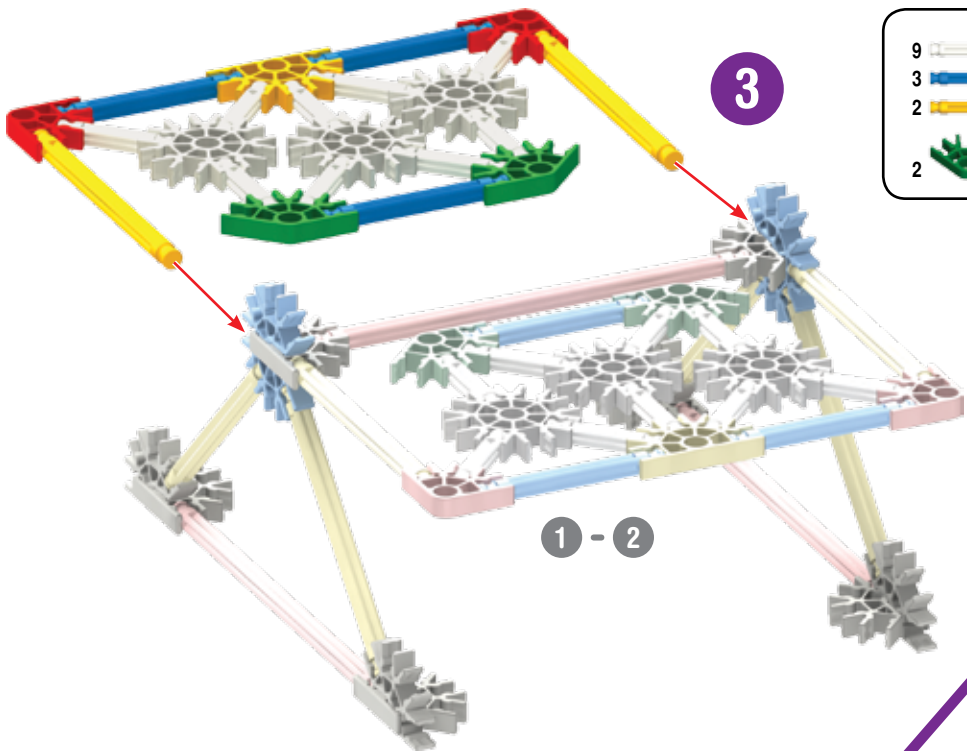

# Telephone



12		2		2	
6					
6					
2					
1					
3		10		4	

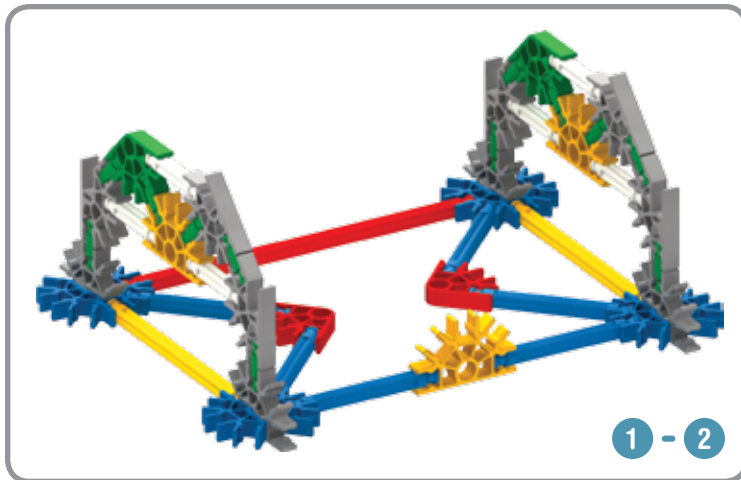
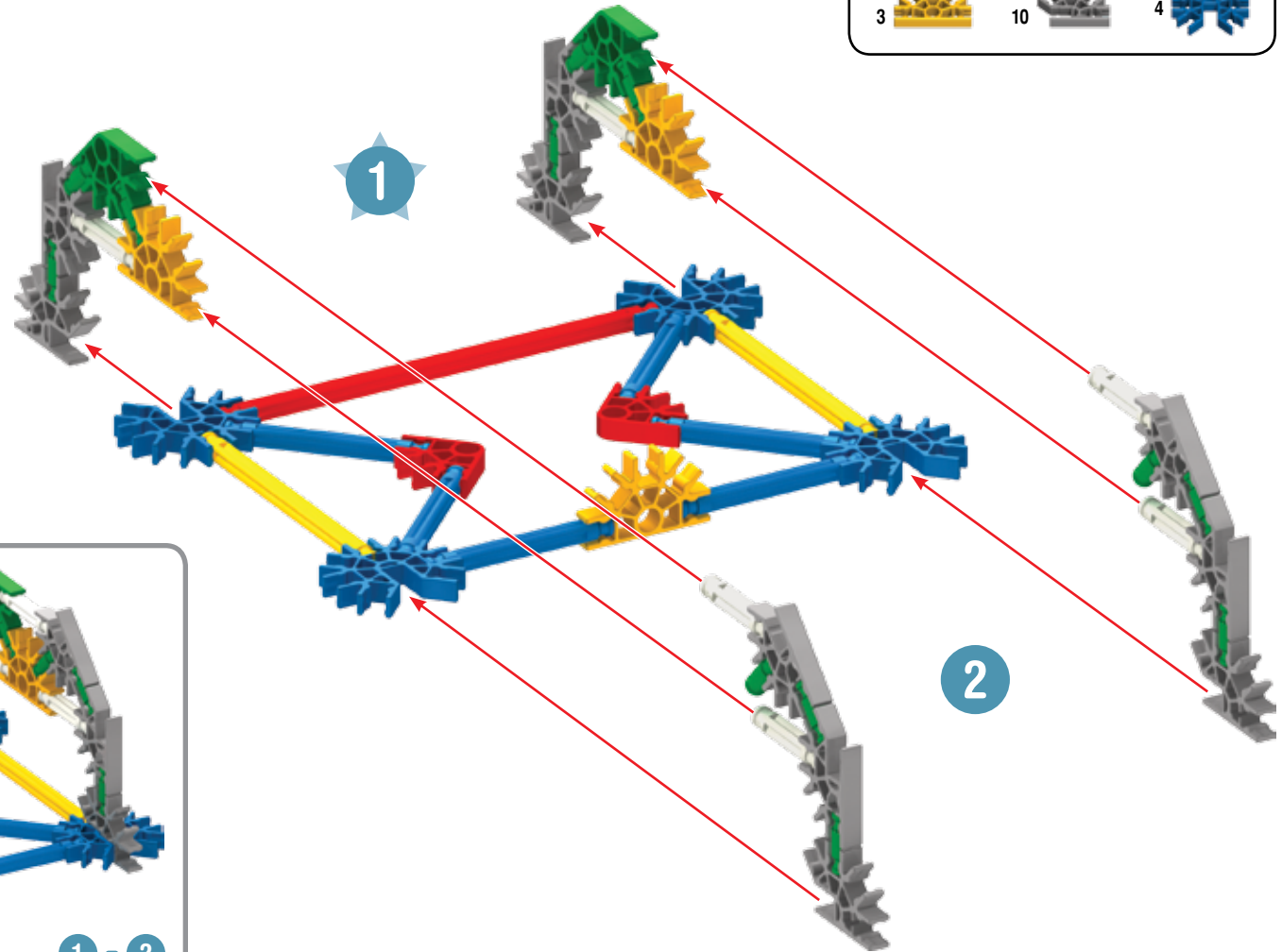

1 - 2



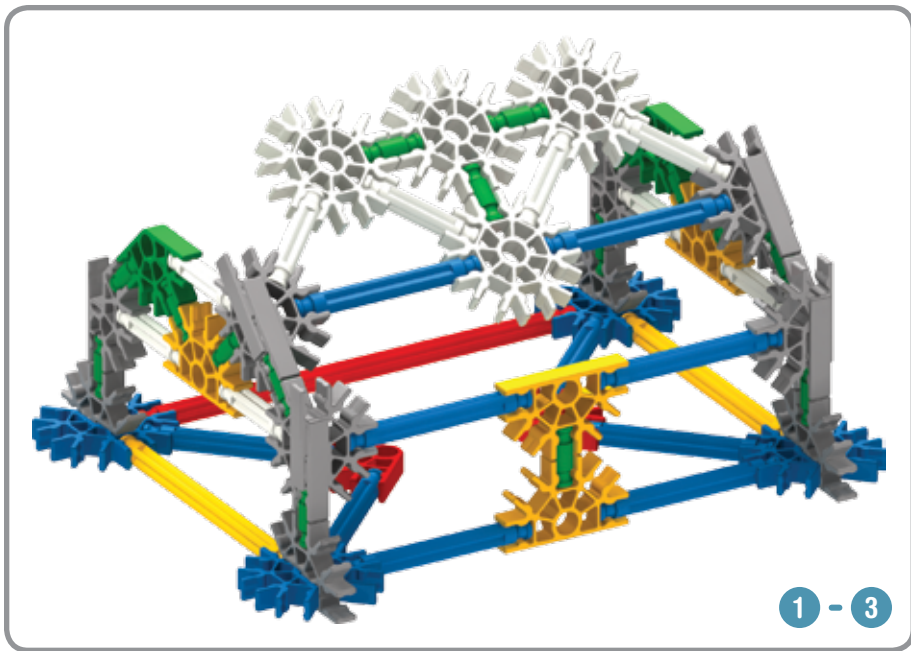

3

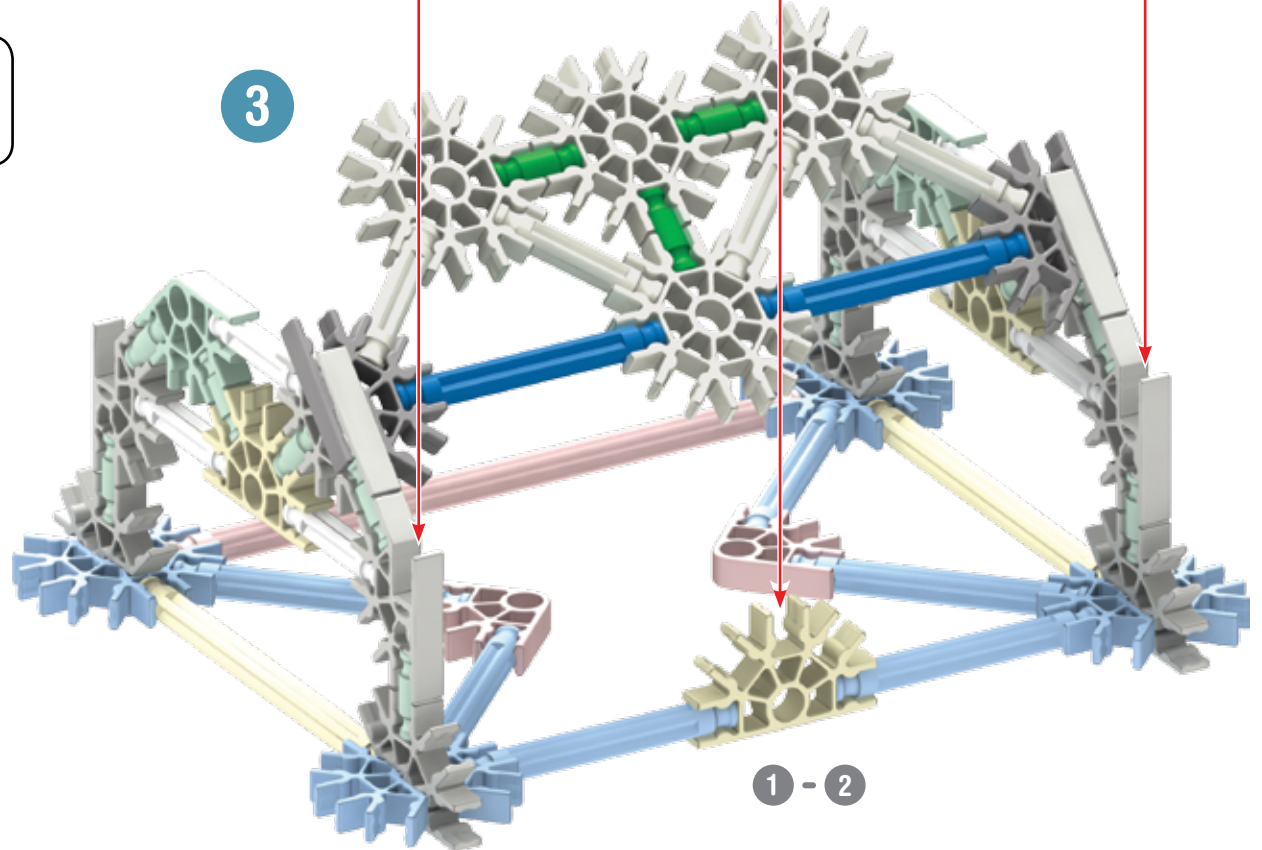
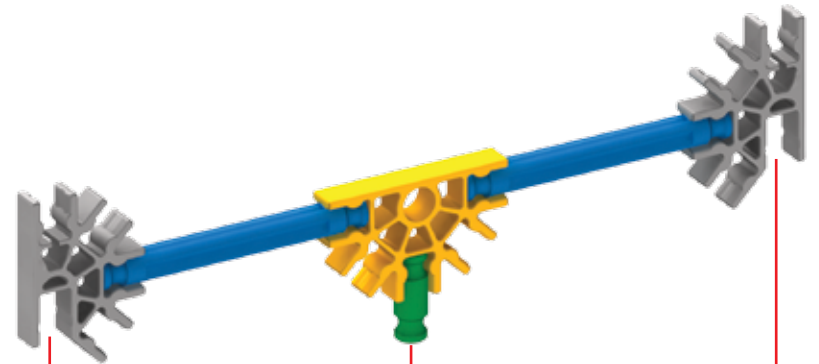

1 - 2

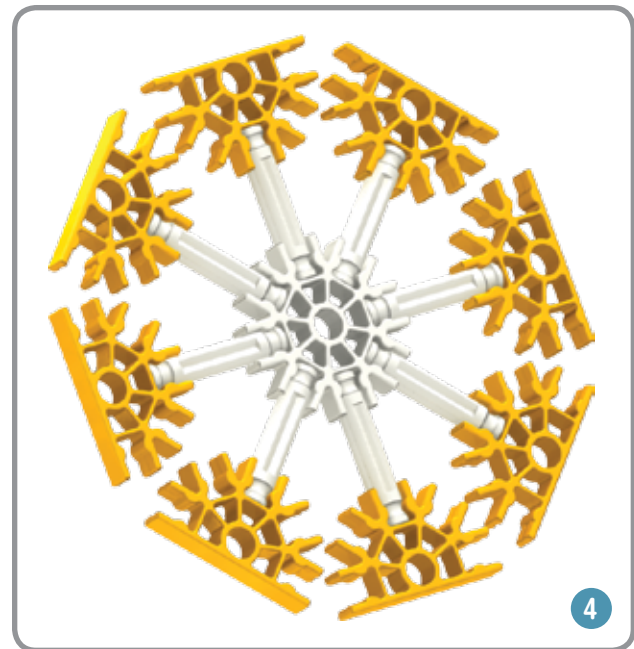
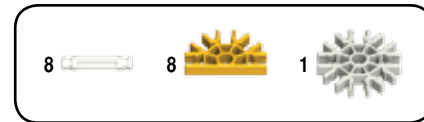
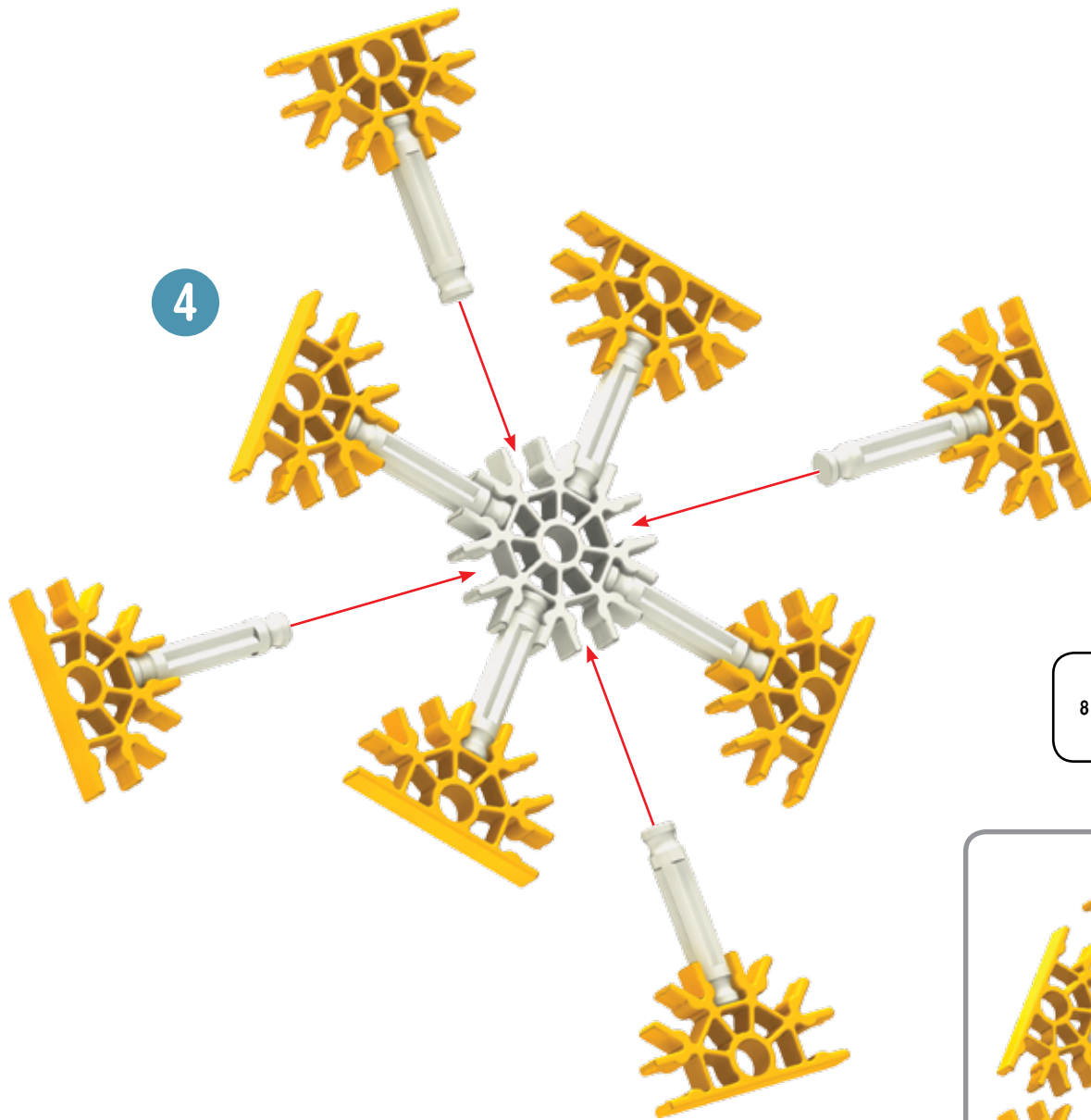

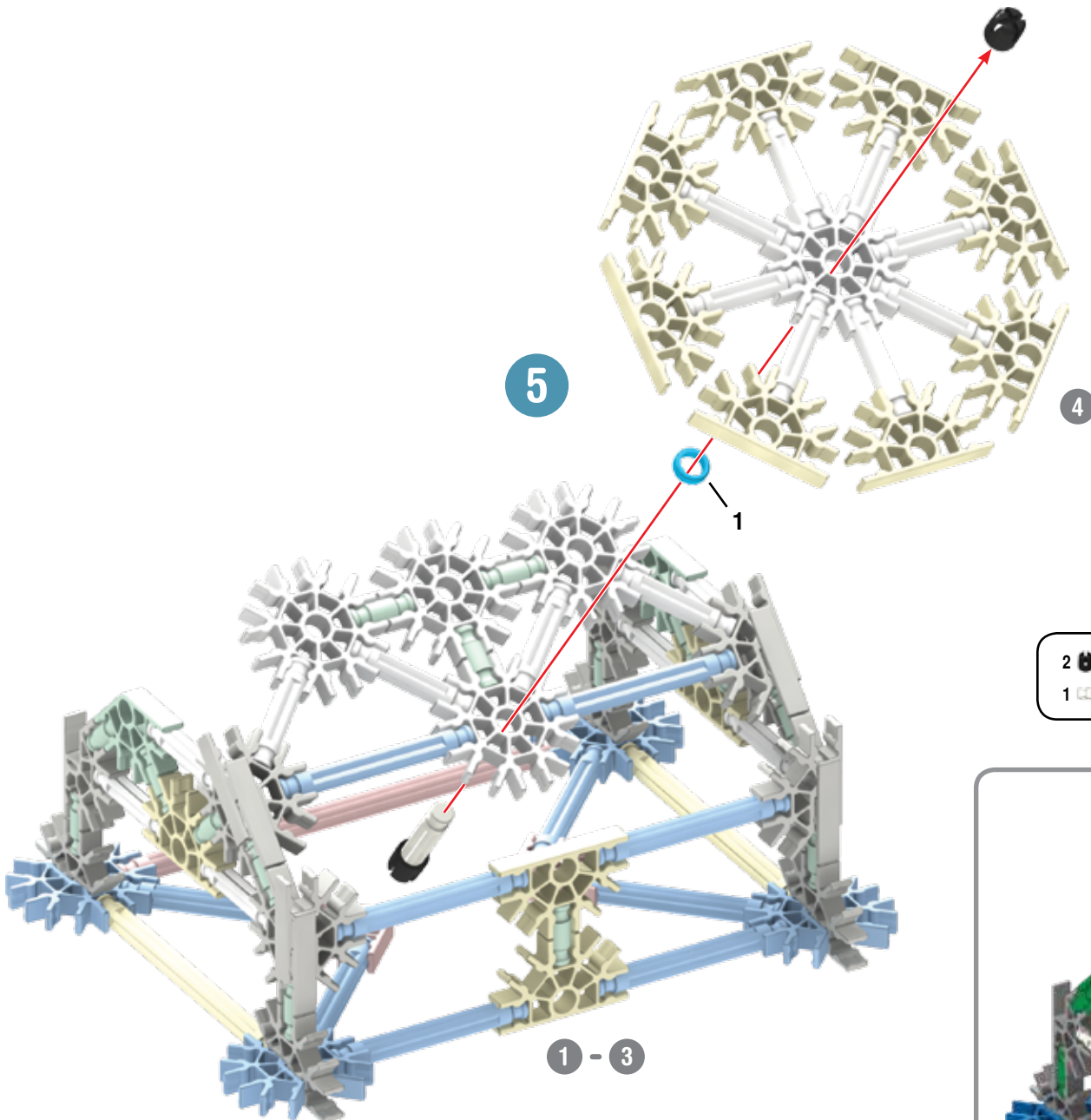



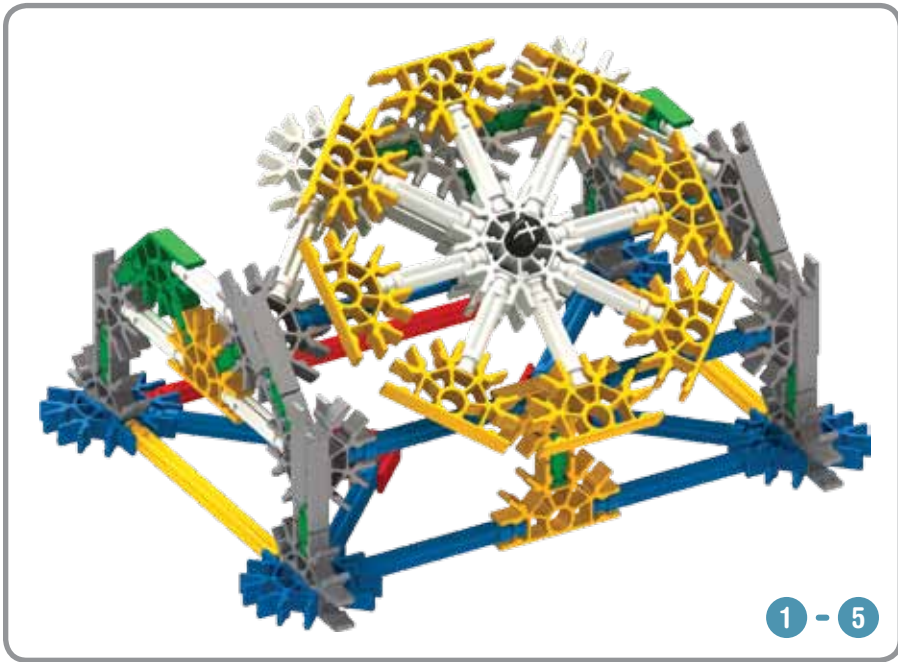

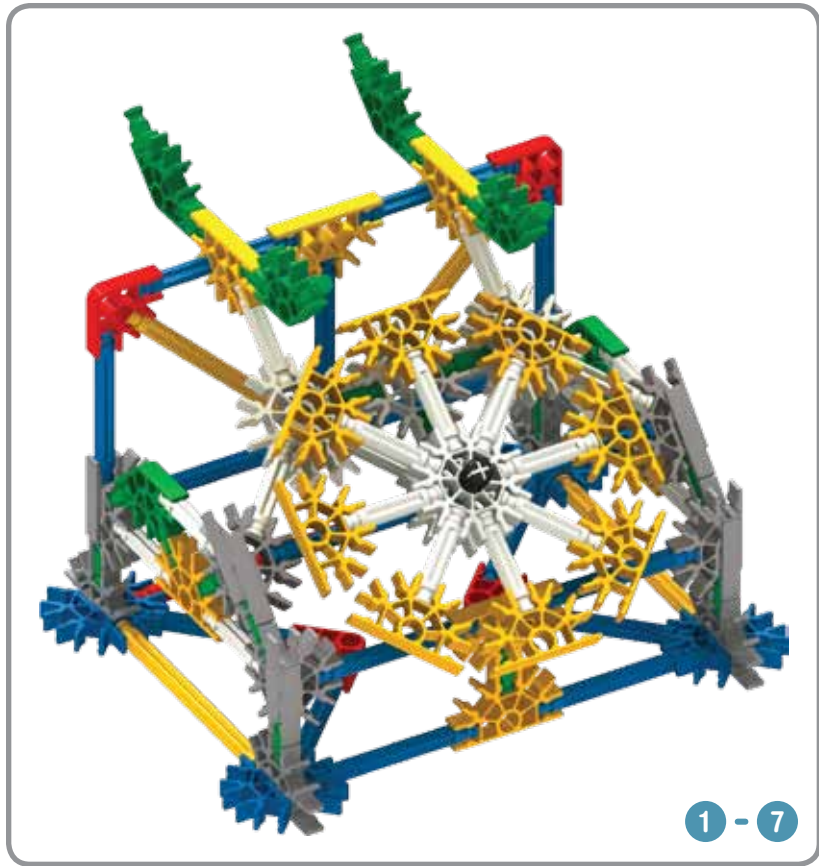
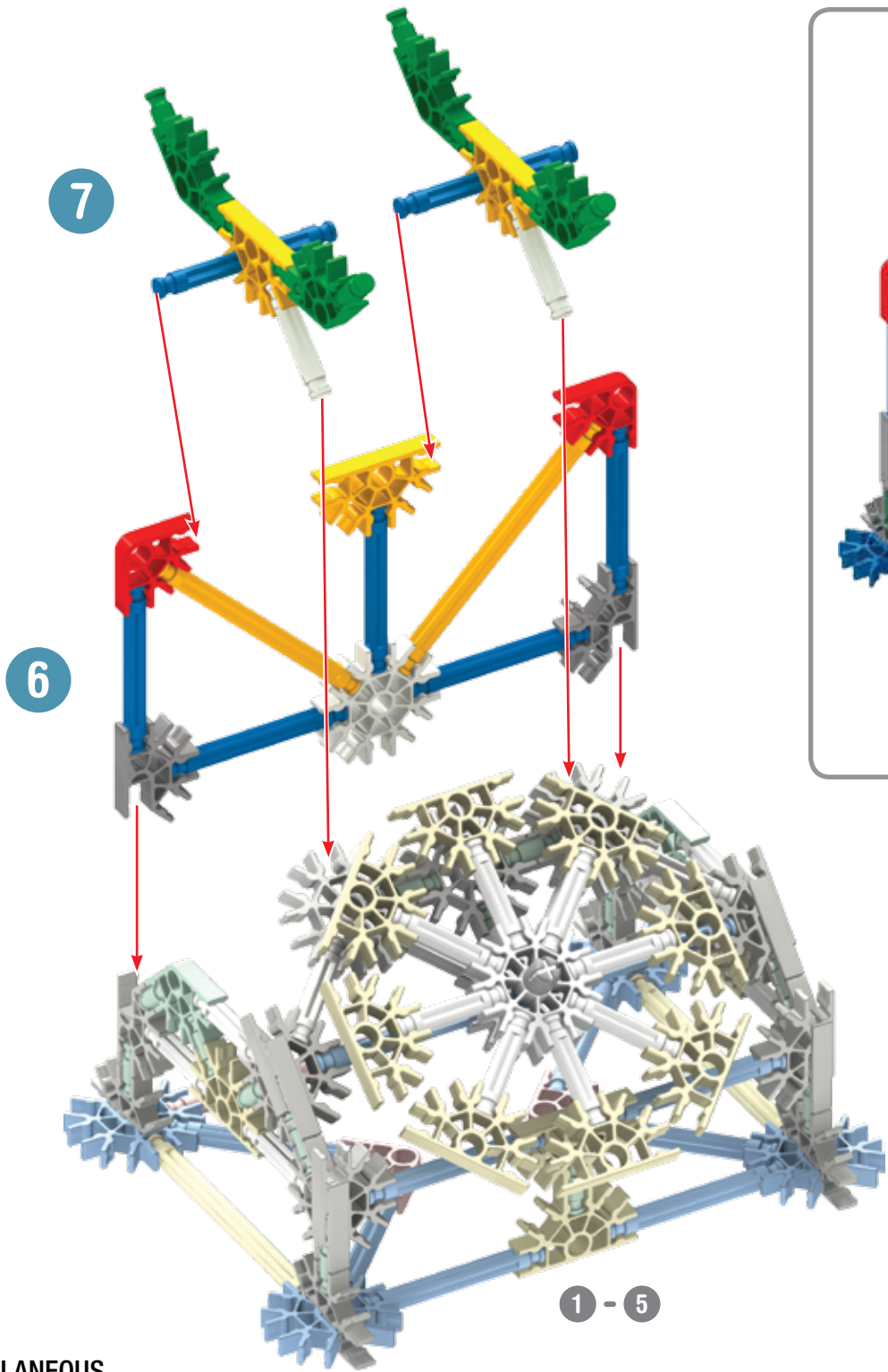



- |   |  |   |  |
|---|--|---|--|
| 2 |  | 1 |  |
| 1 |  |   |  |





- |   |   |   |   |   |   |
|---|---|---|---|---|---|
| 8 |   | 2 |  | 4 |  |
| 2 |  | 7 |  | 2 |  |
| 3 |  | 2 |  | 1 |  |

x2

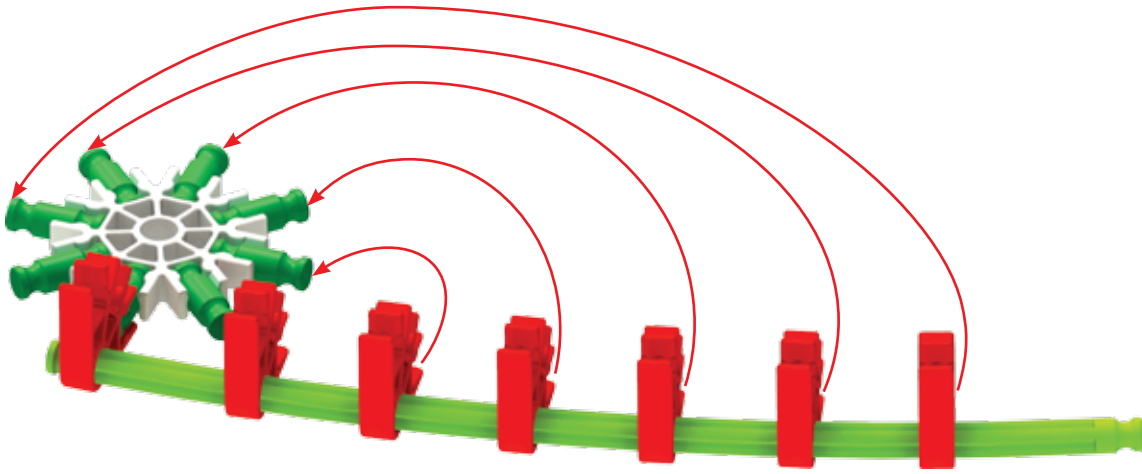

8

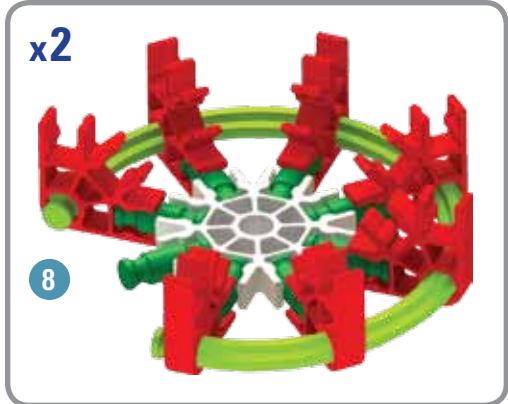

x2

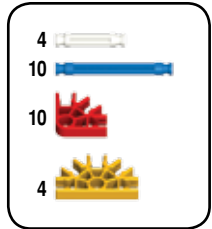
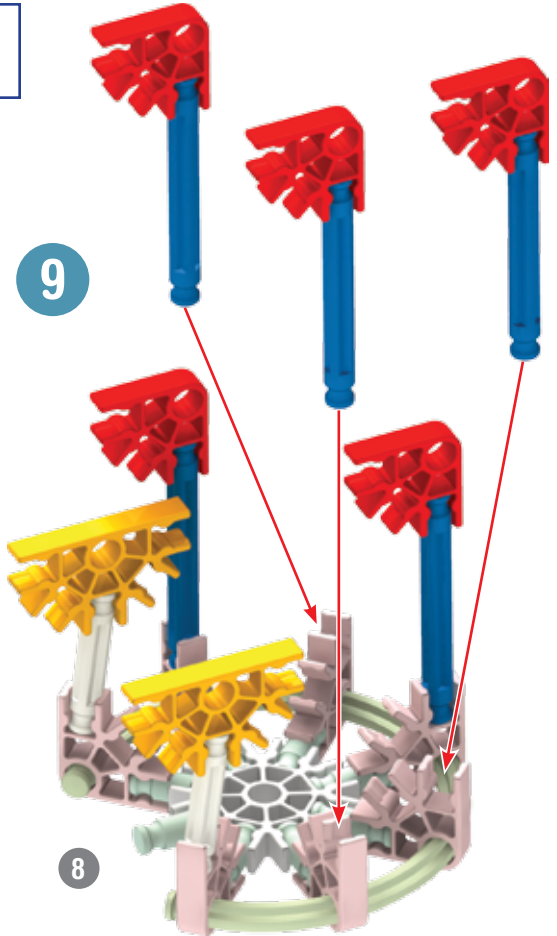

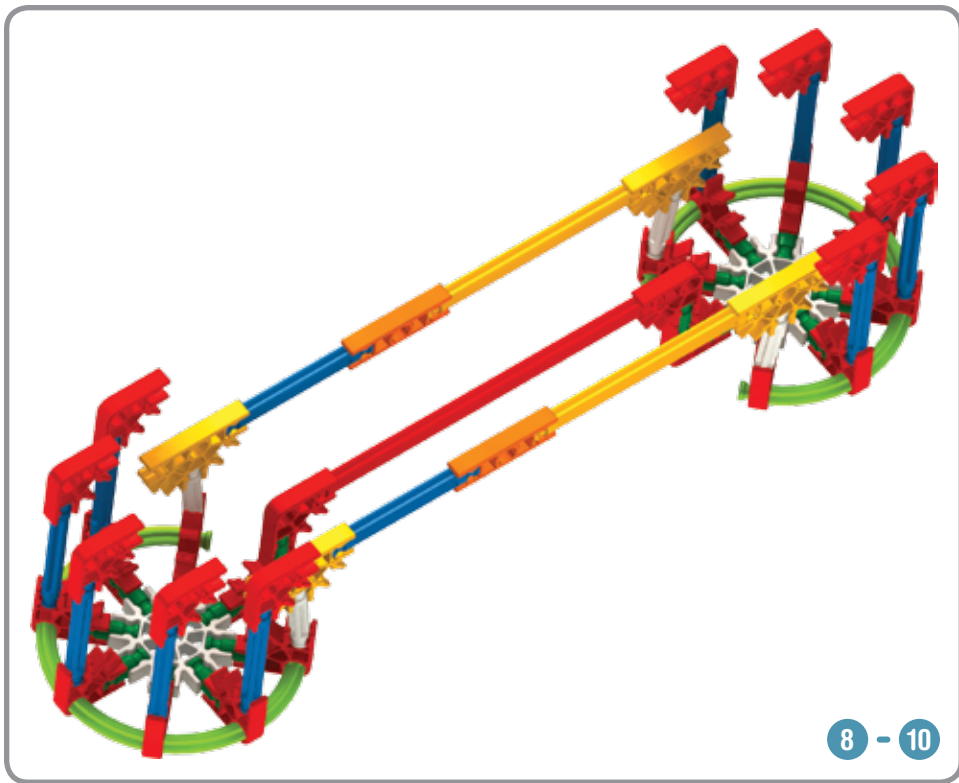

8 - 10

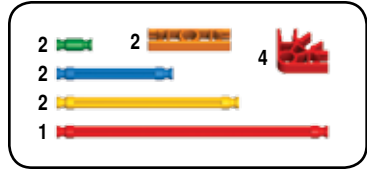

8 - 9

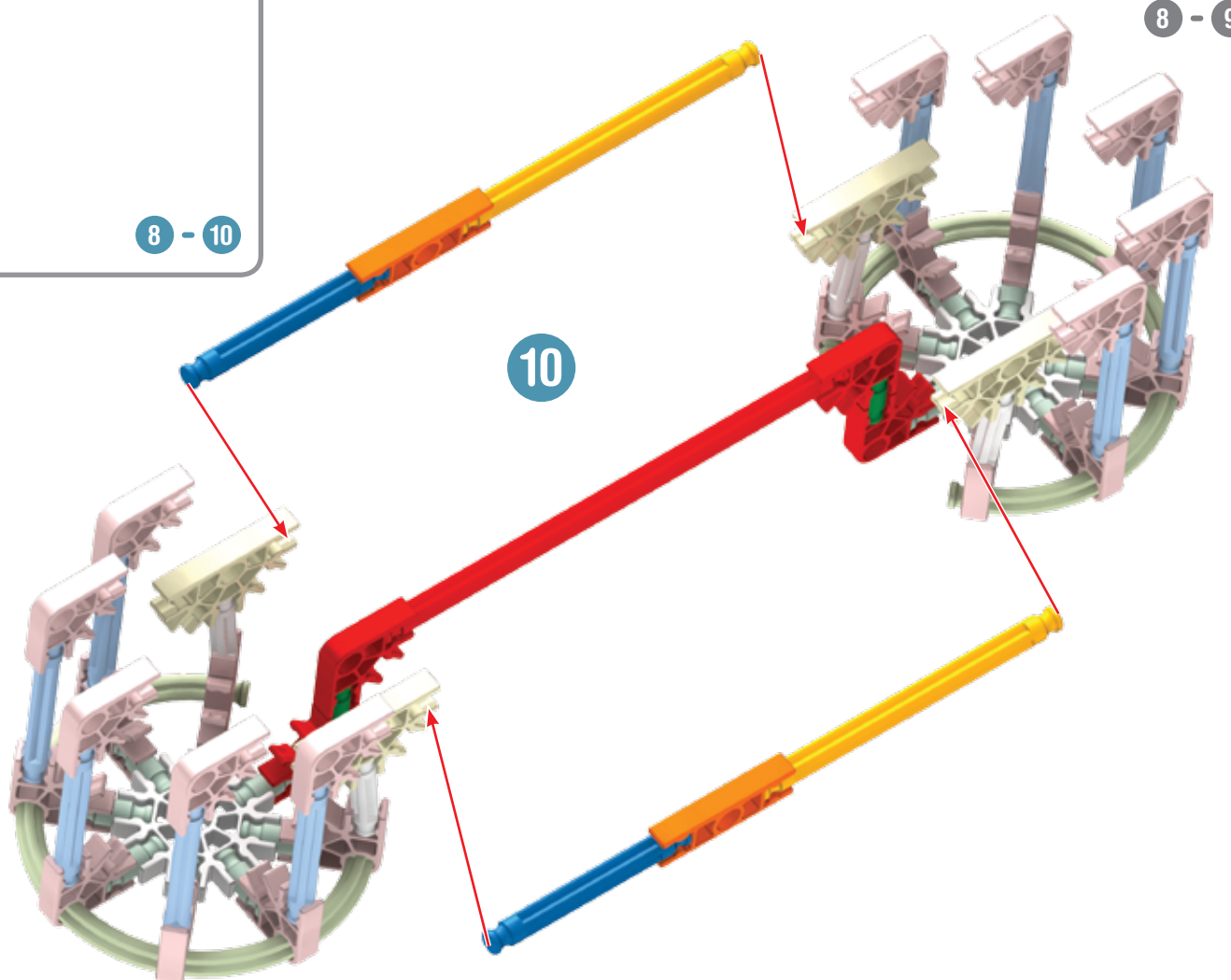

10

8 - 9

11

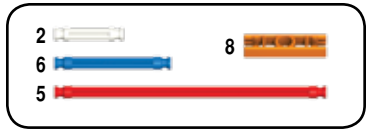
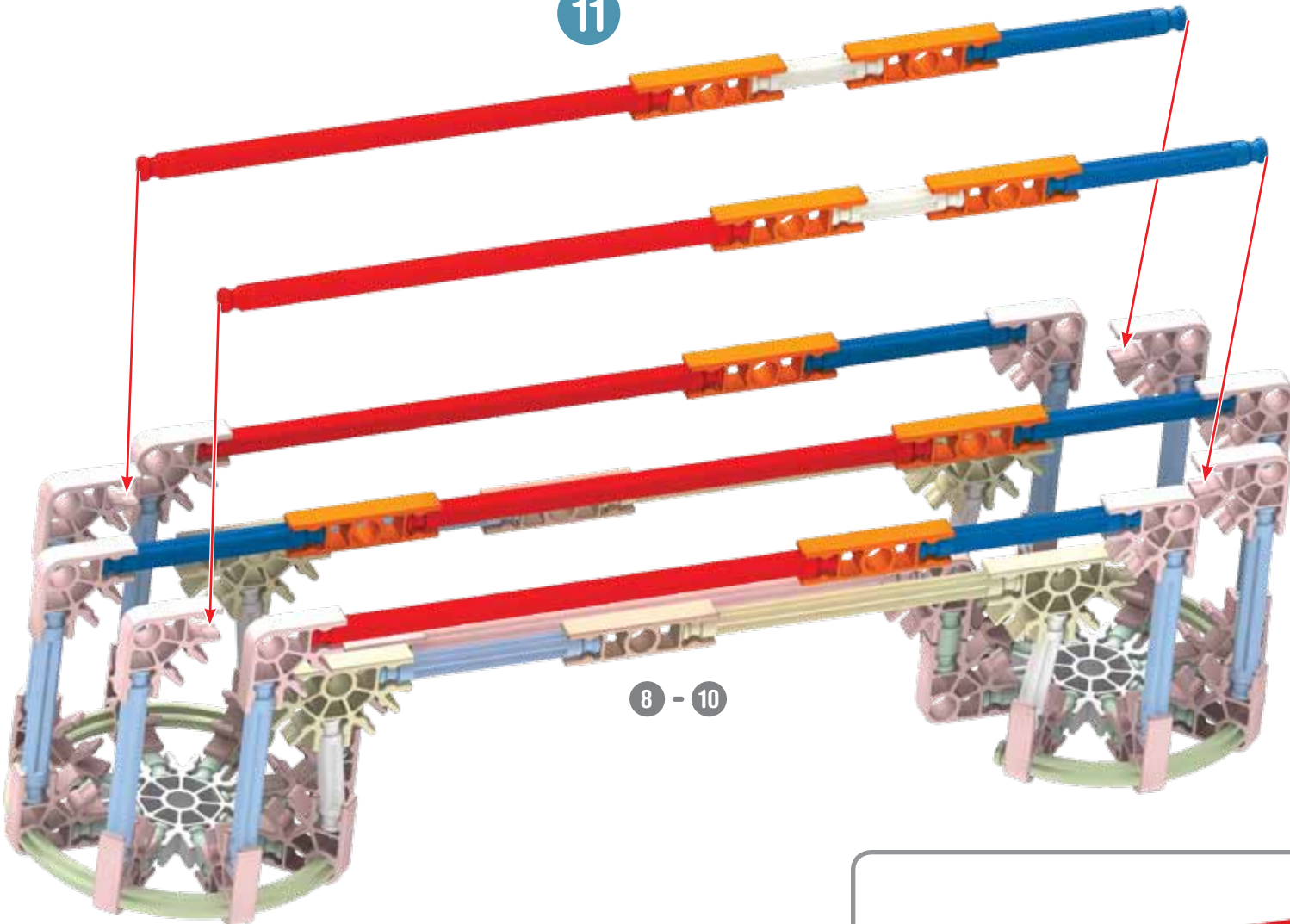

8 - 10



8 - 11

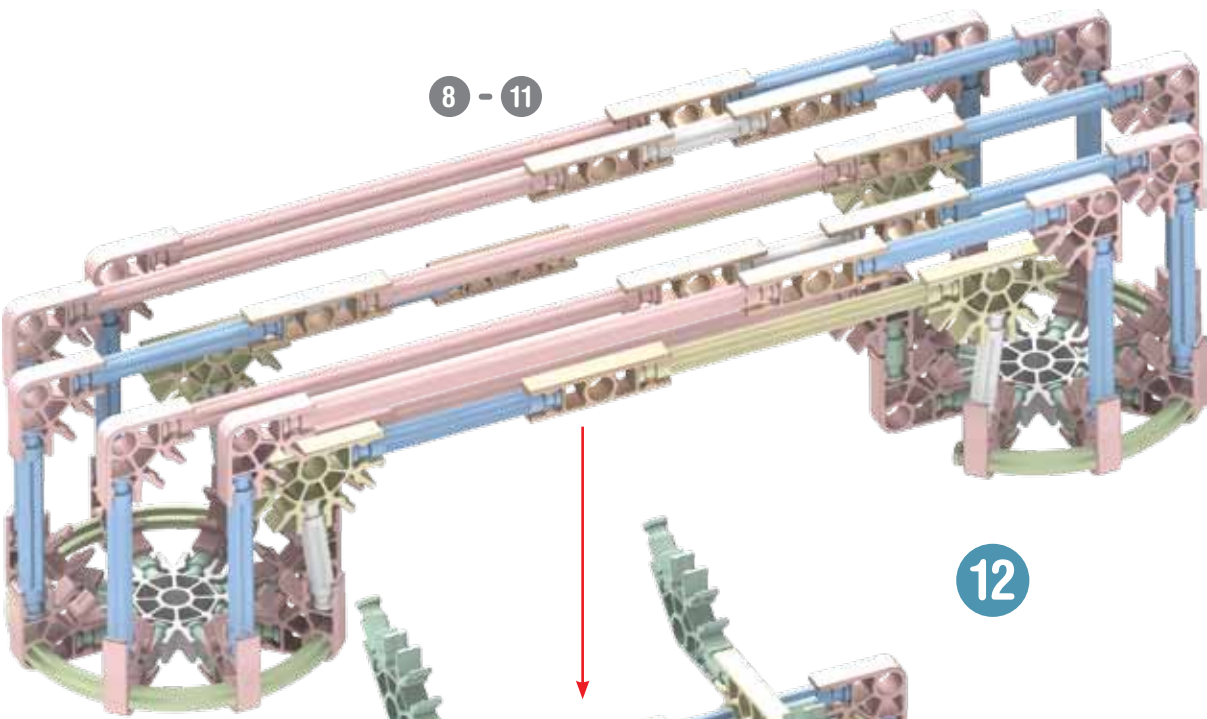

12

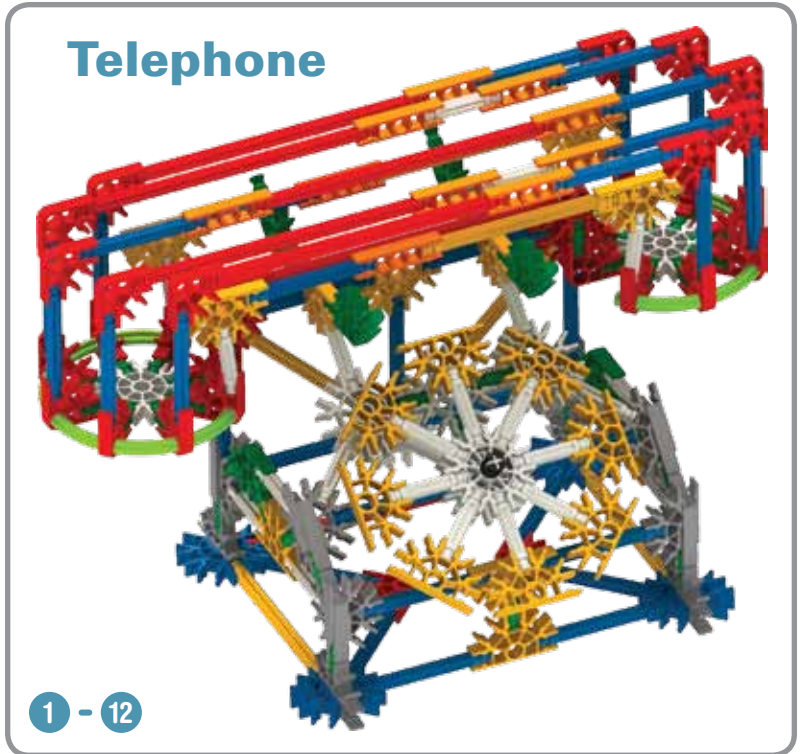
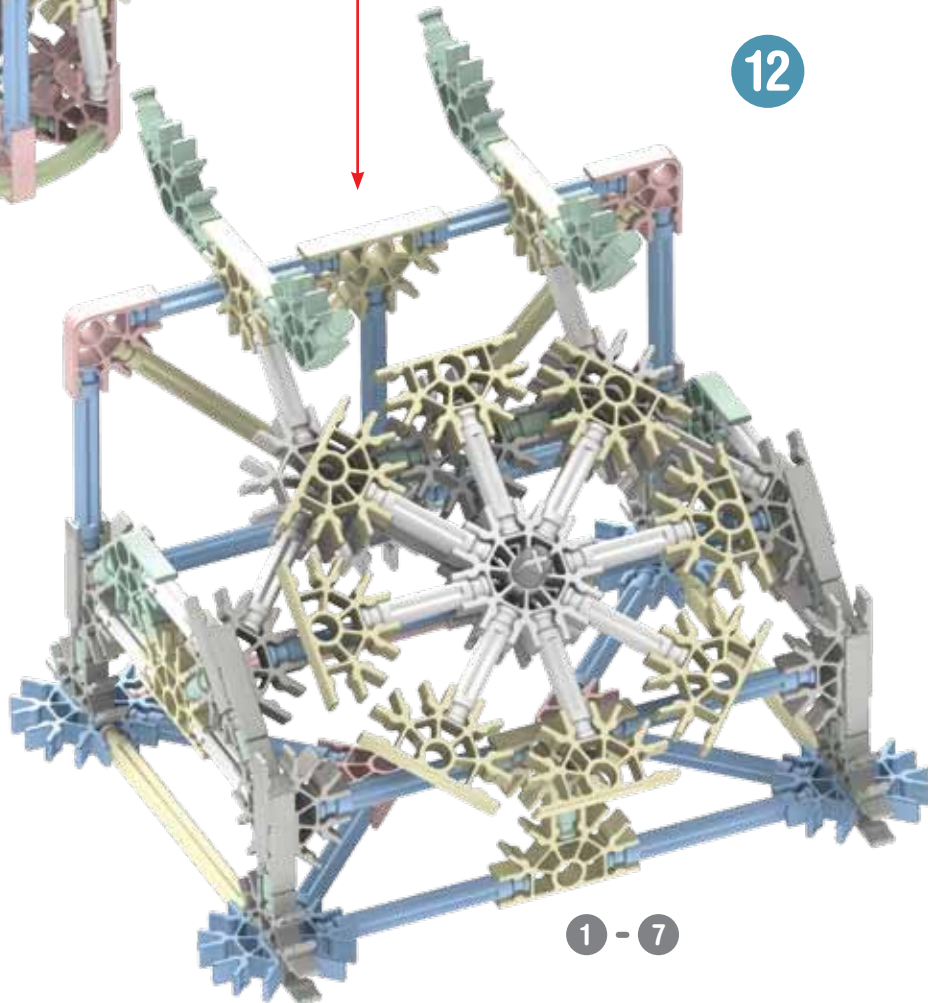



TV



x2

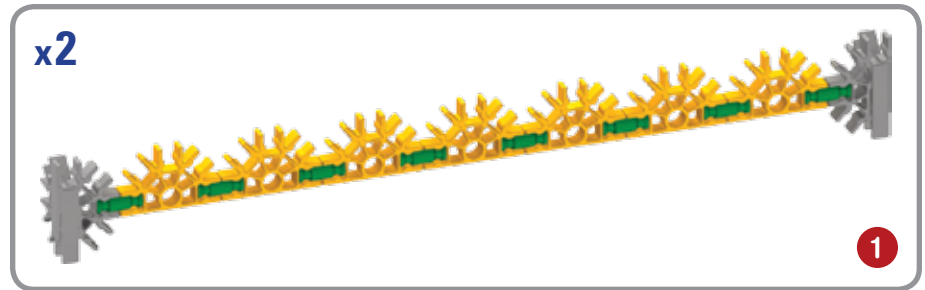

x2

1

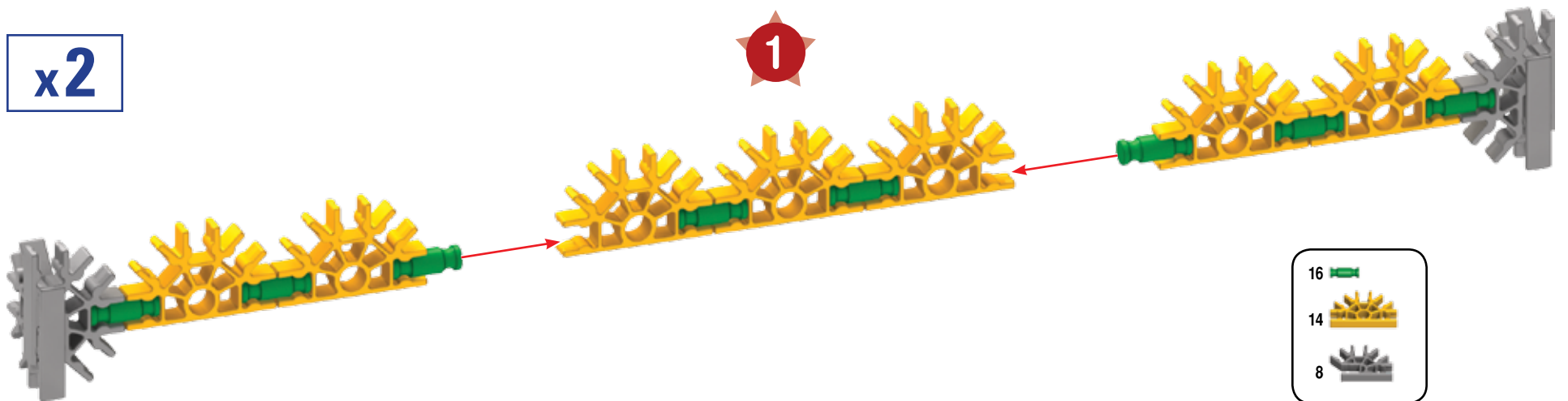

16

14

8

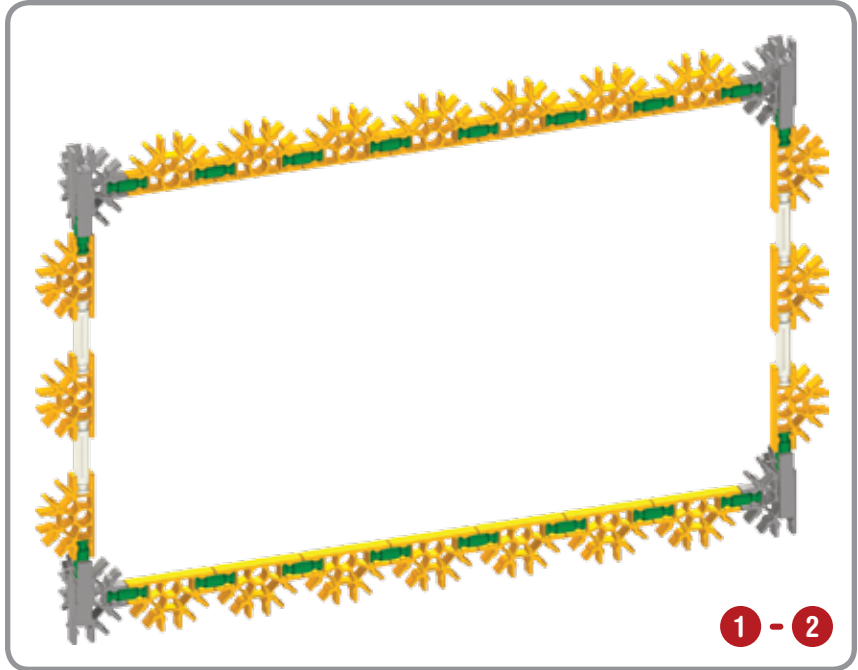
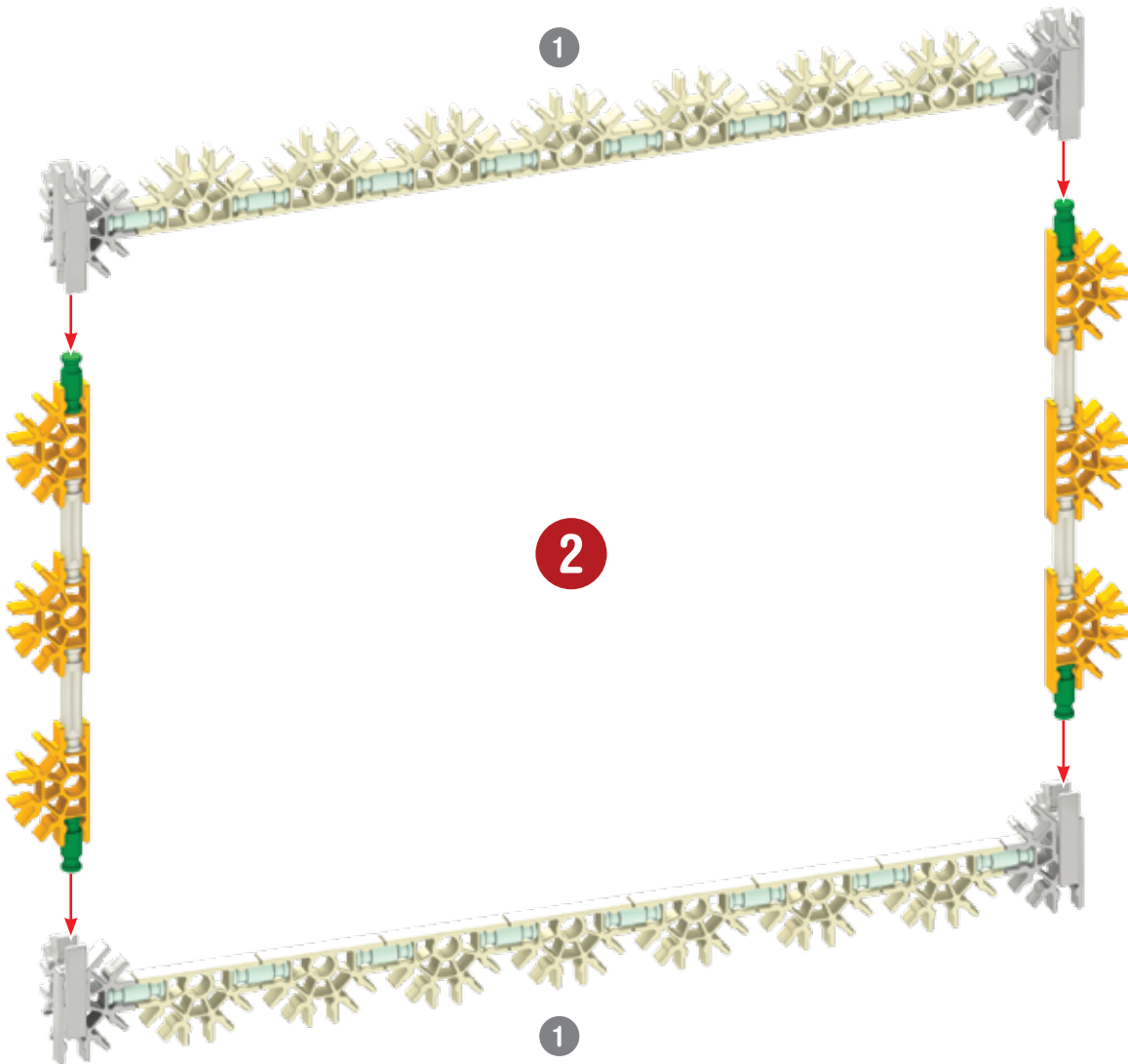

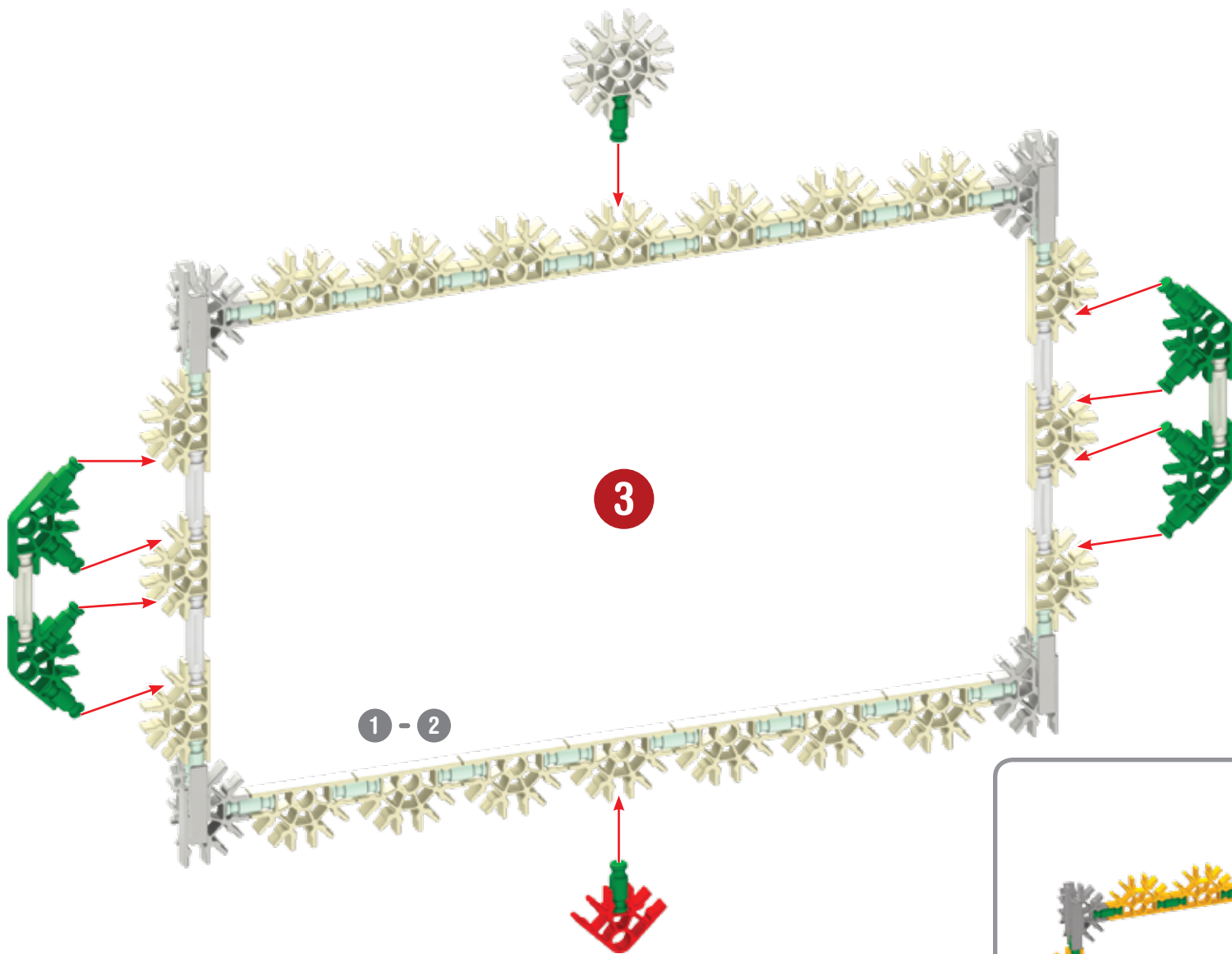

- |    |  |   |  |   |  |   |  |
|----|--|---|--|---|--|---|--|
| 10 |  | 1 |  | 4 |  | 1 |  |
| 2  |  |   |  |   |  |   |  |



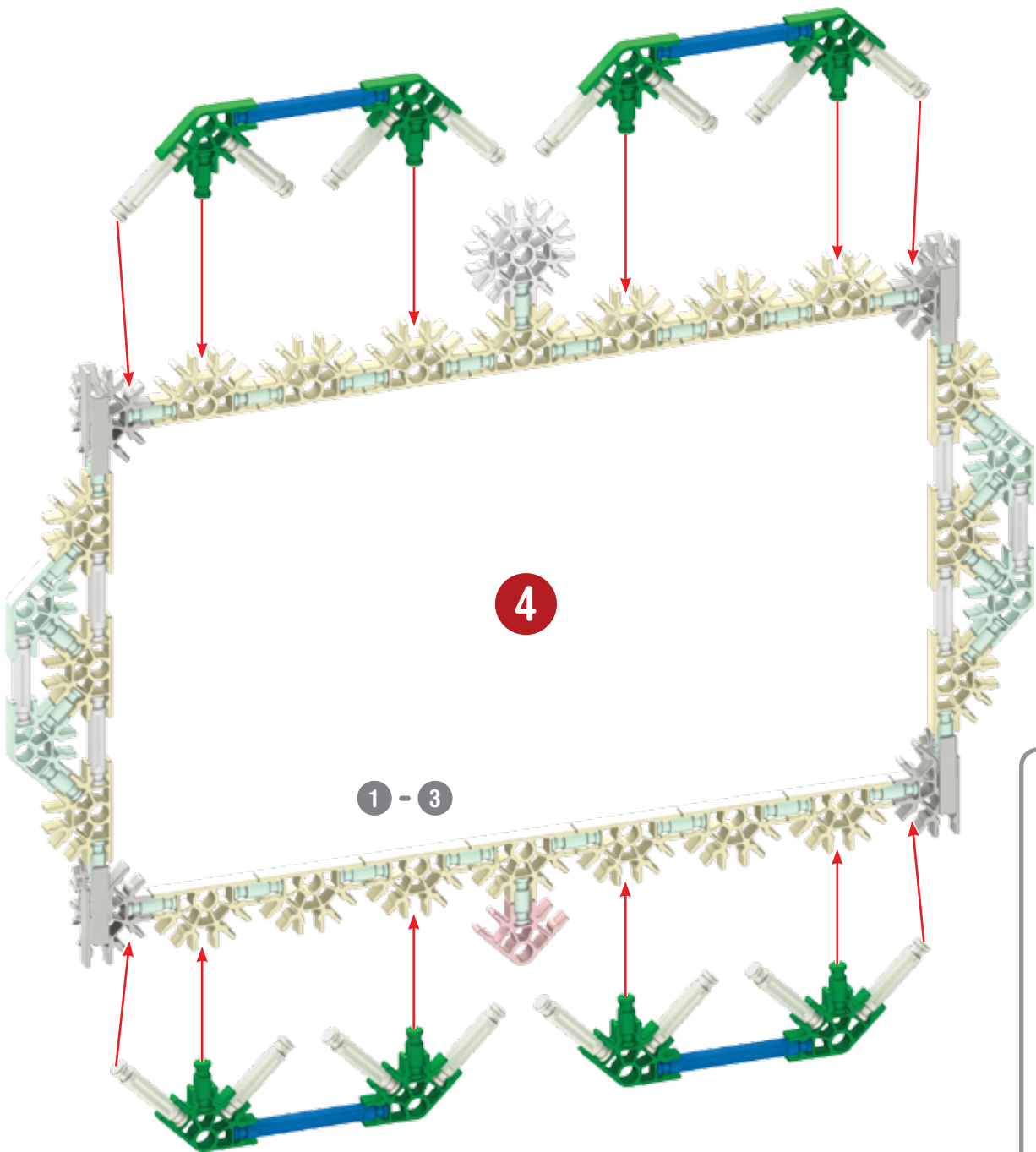

1 - 3

4

8		8	
16			
4			



1 - 4

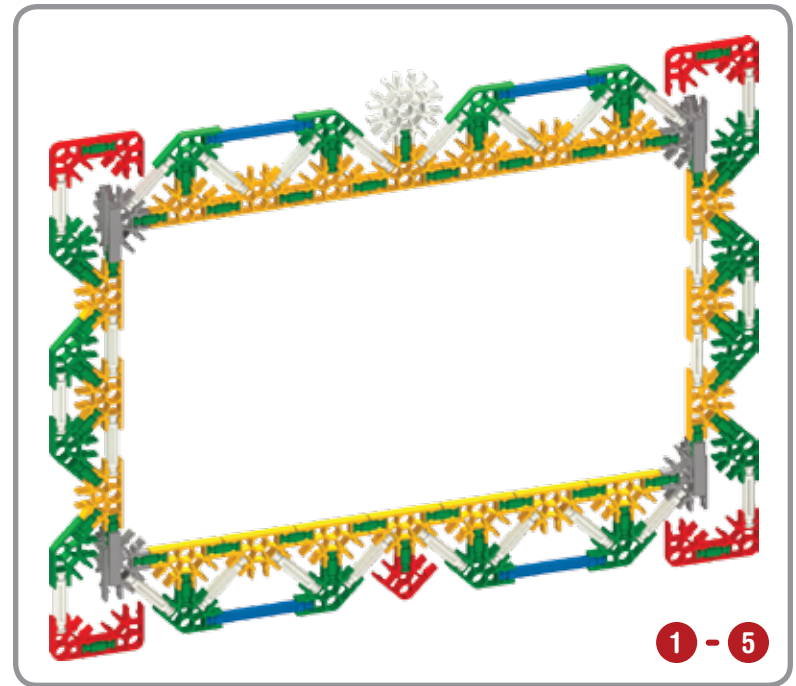
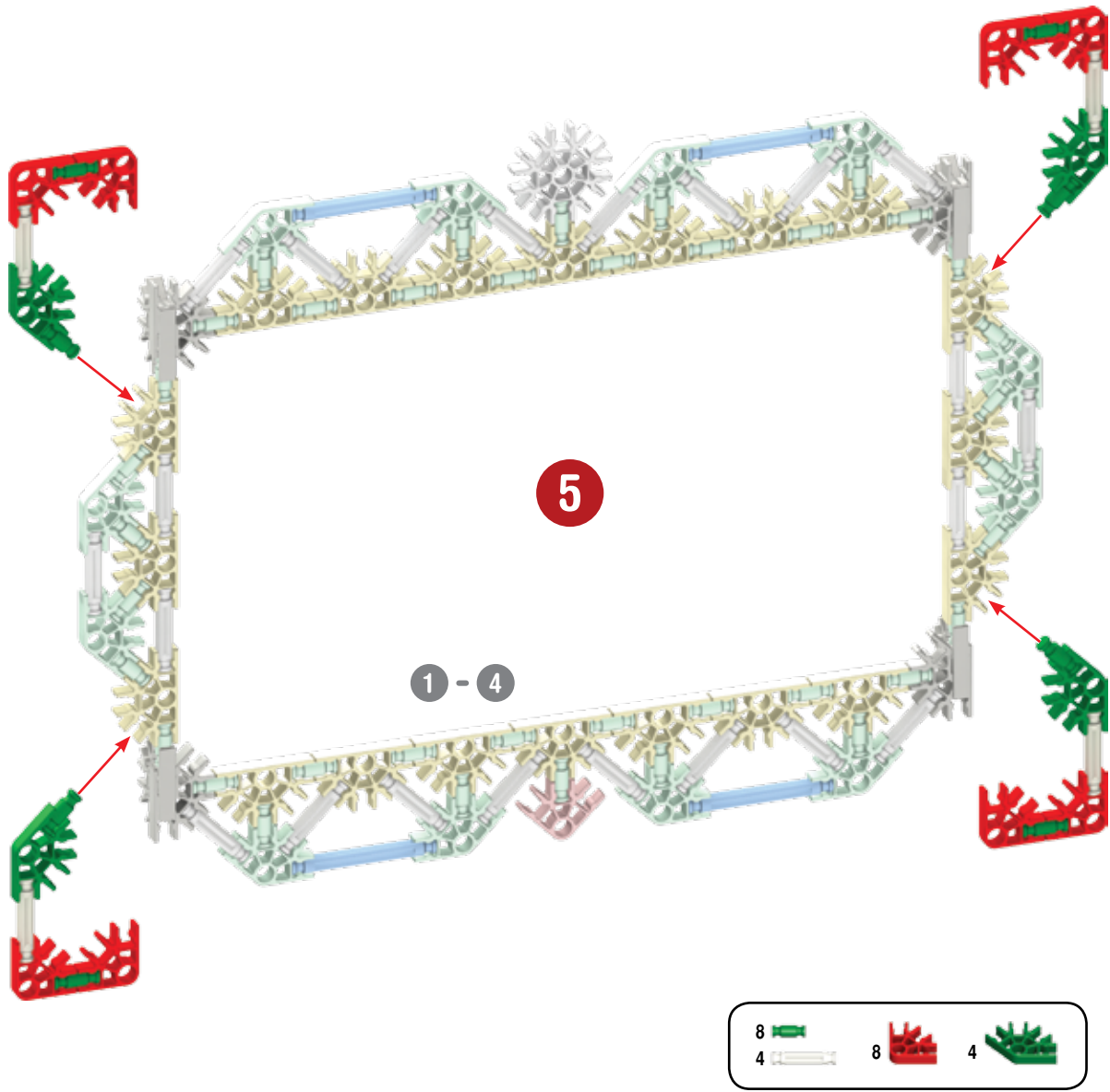

TV

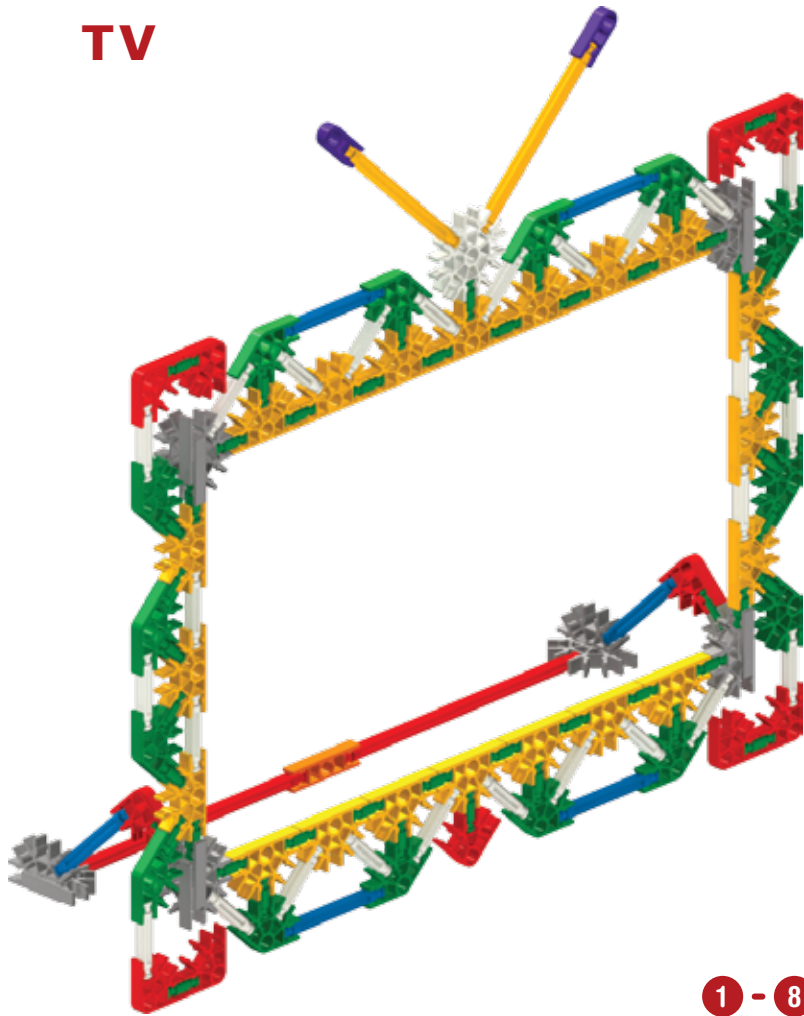

1 - 8

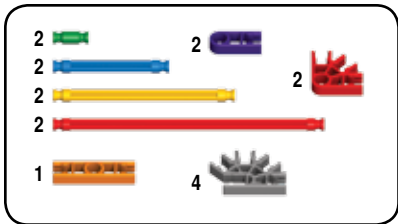

8

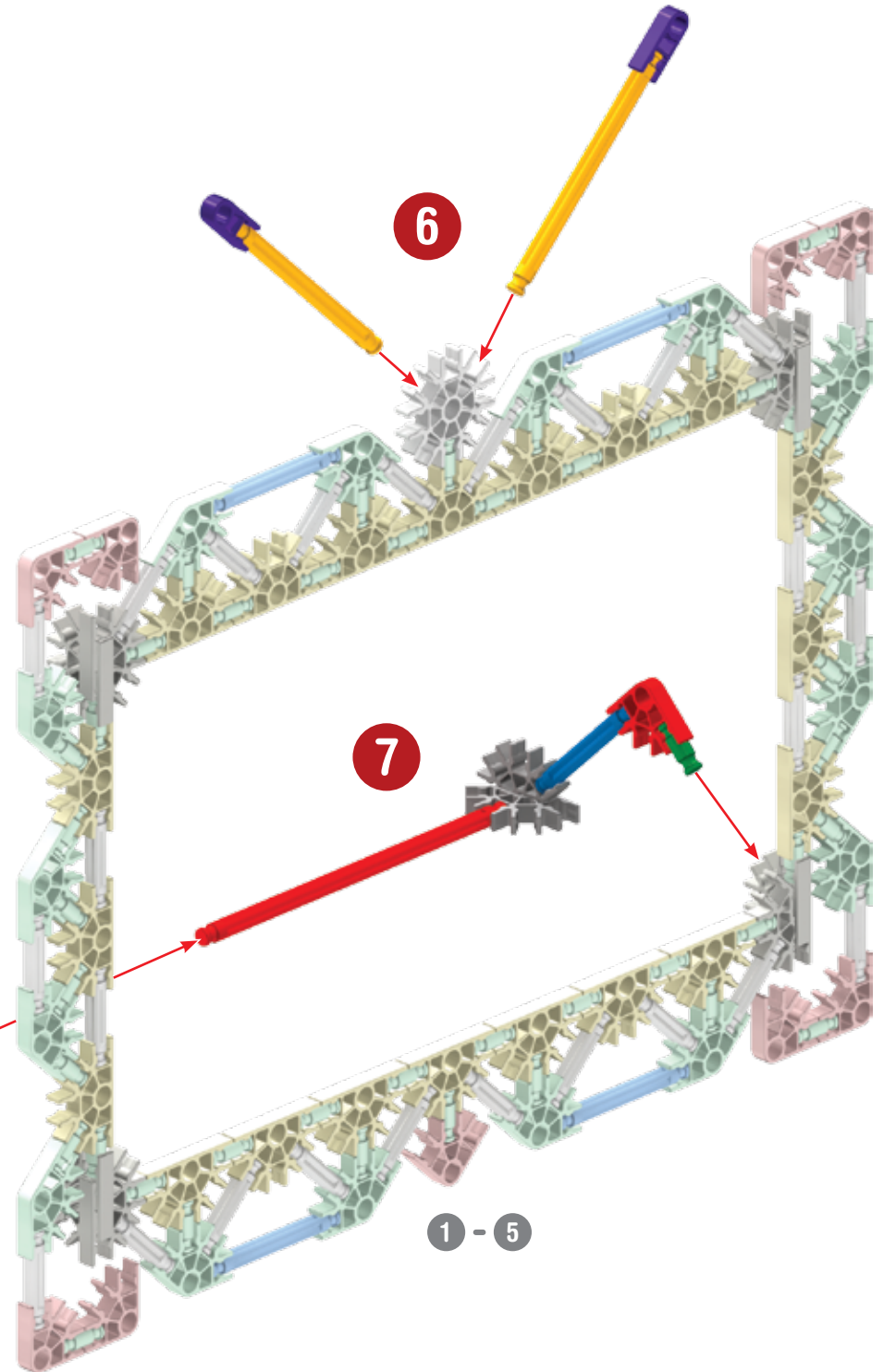

6

7

1 - 5