

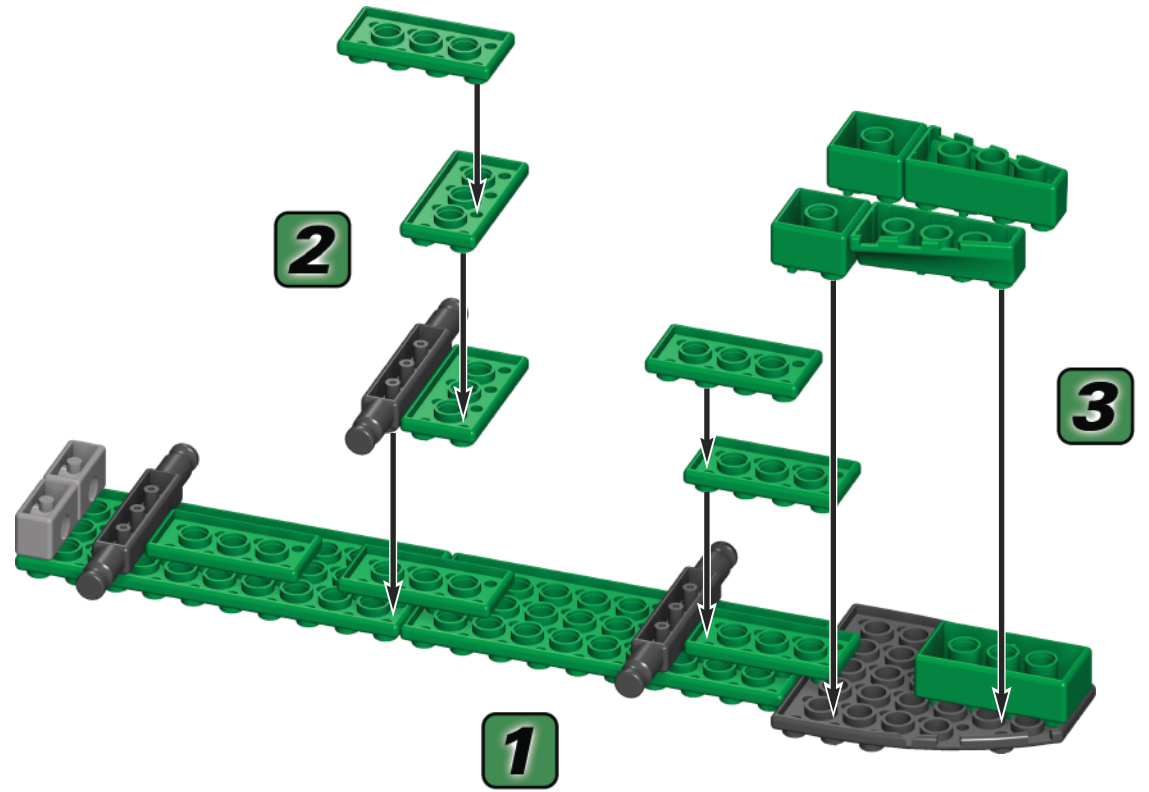

Aircraft Trailer

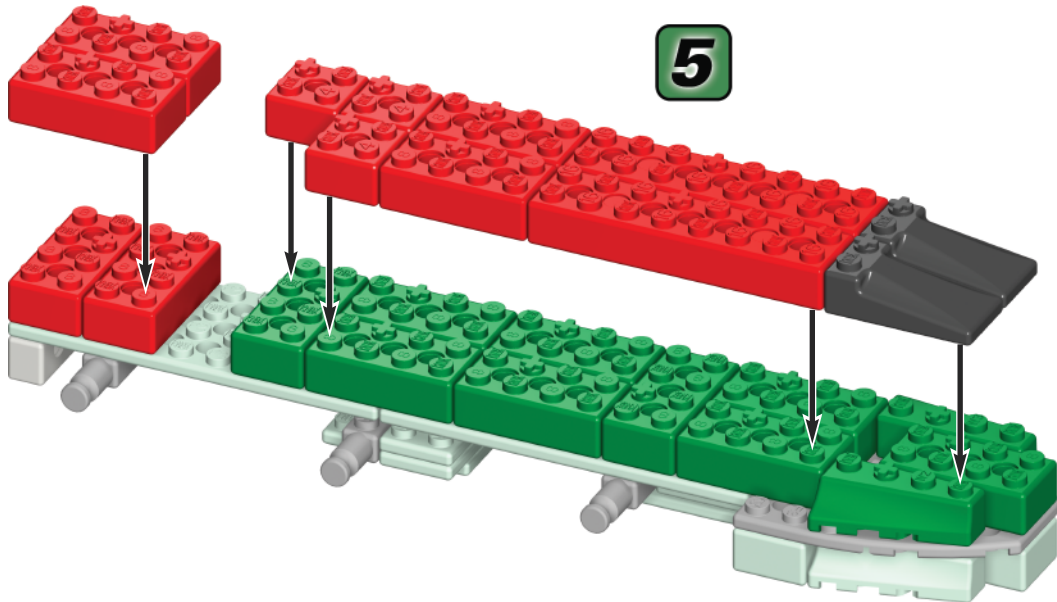

4



5

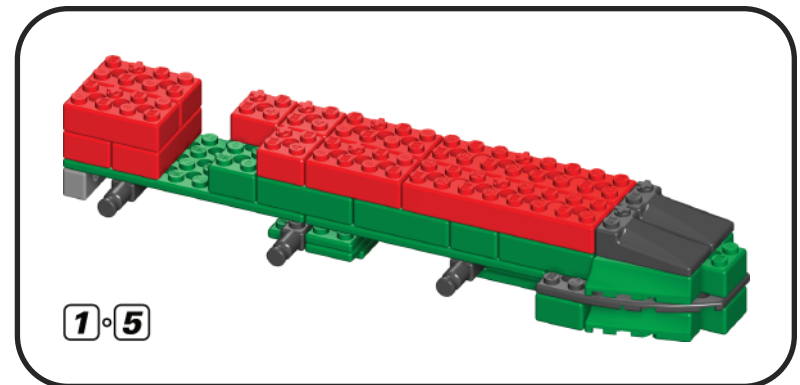

1-5

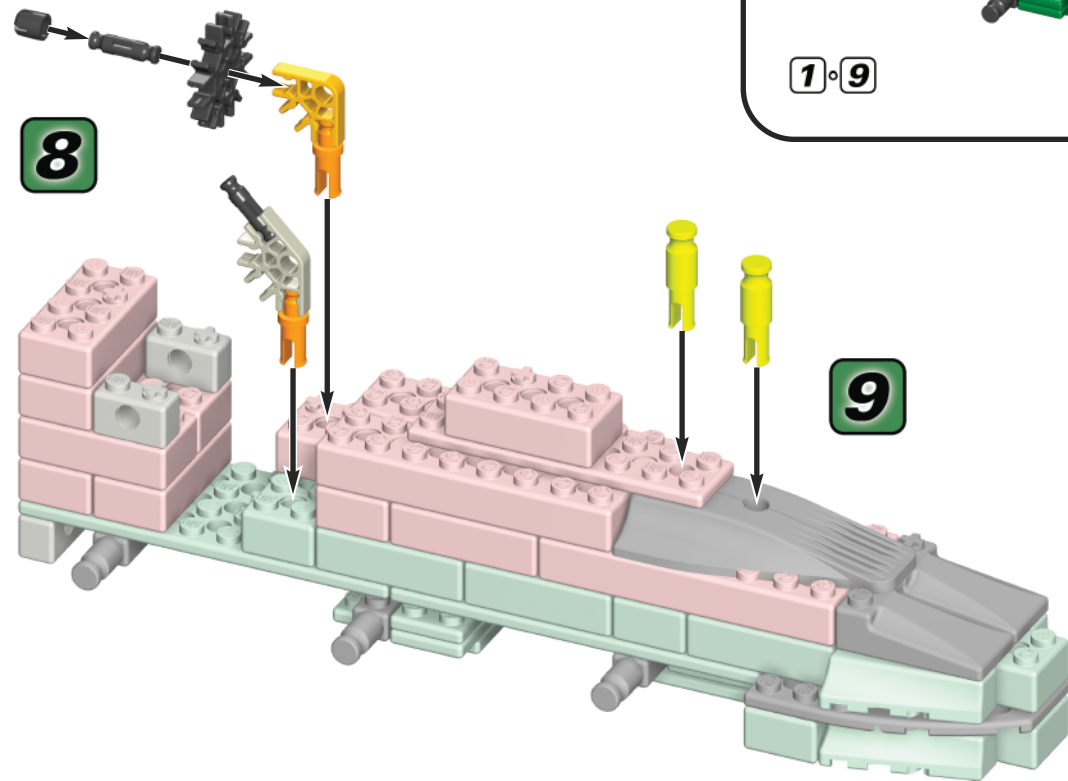
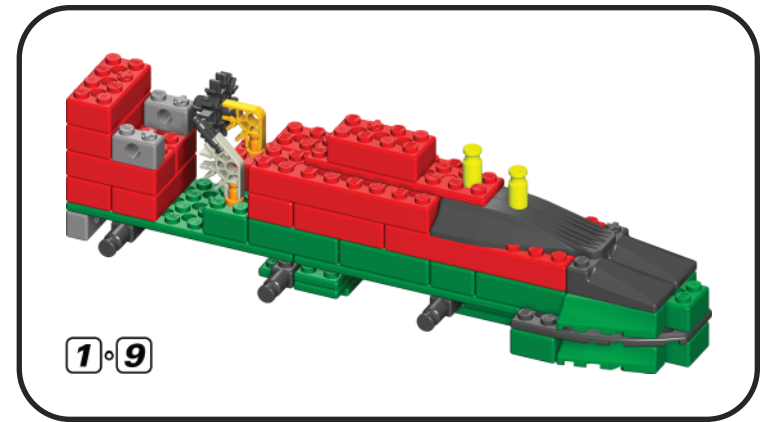
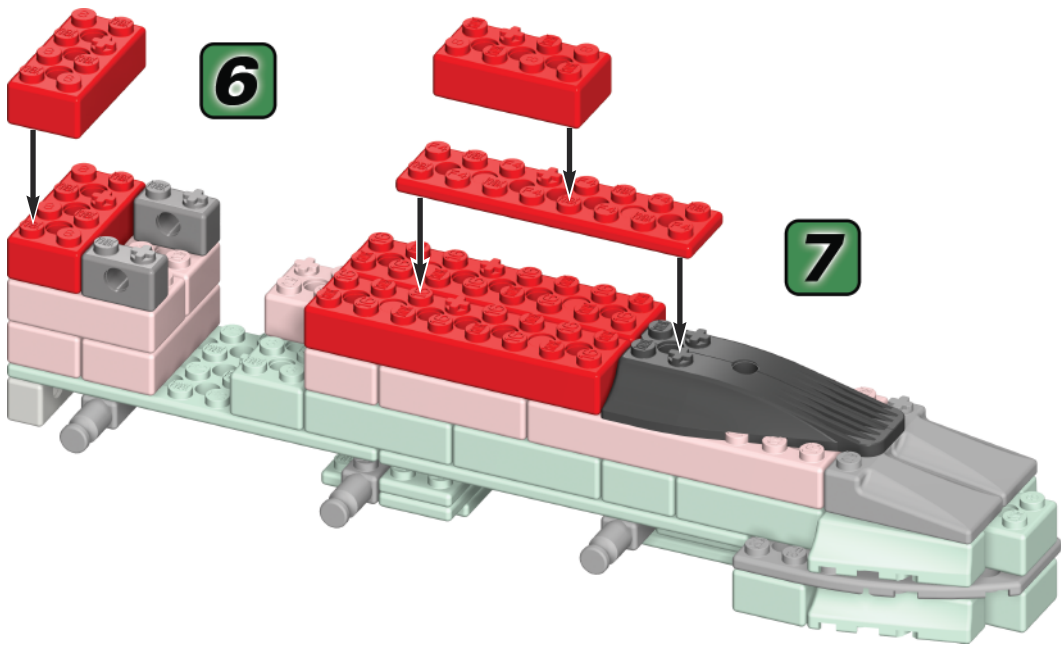

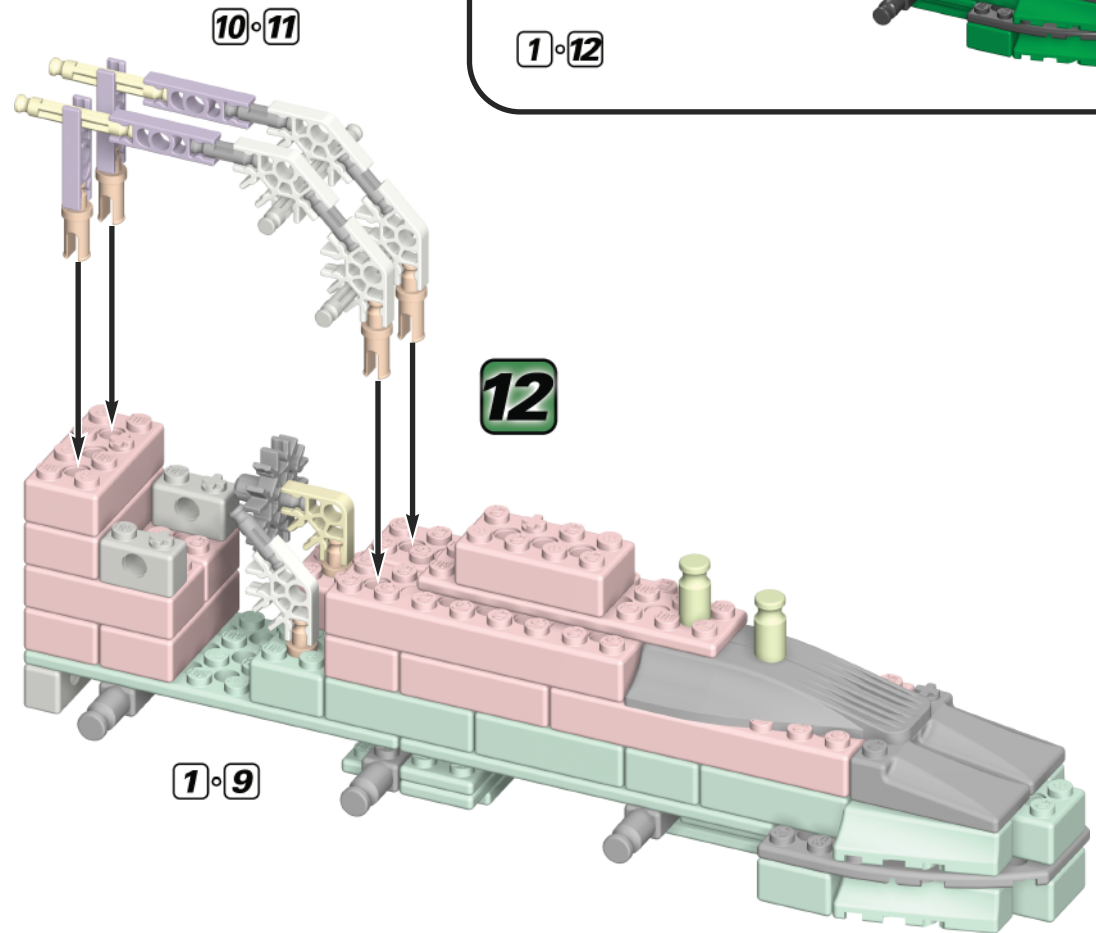
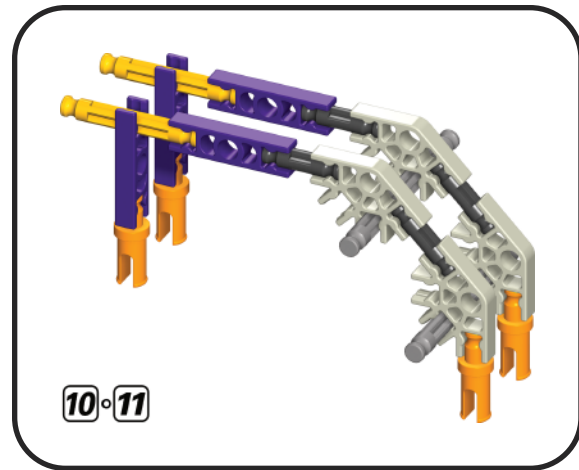
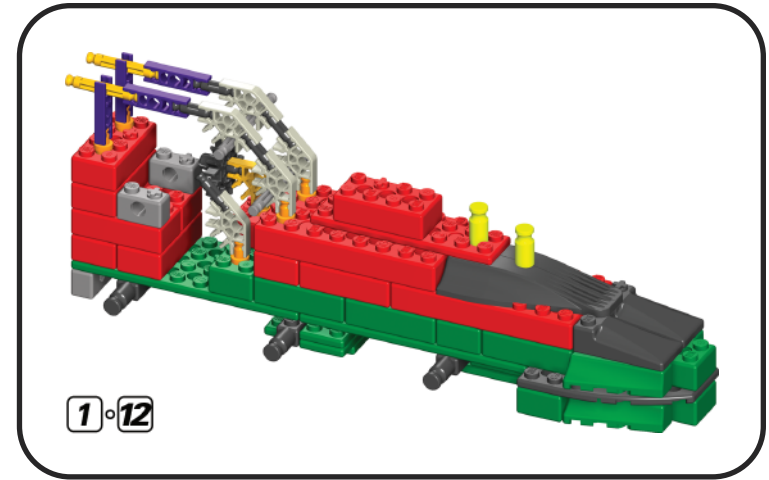
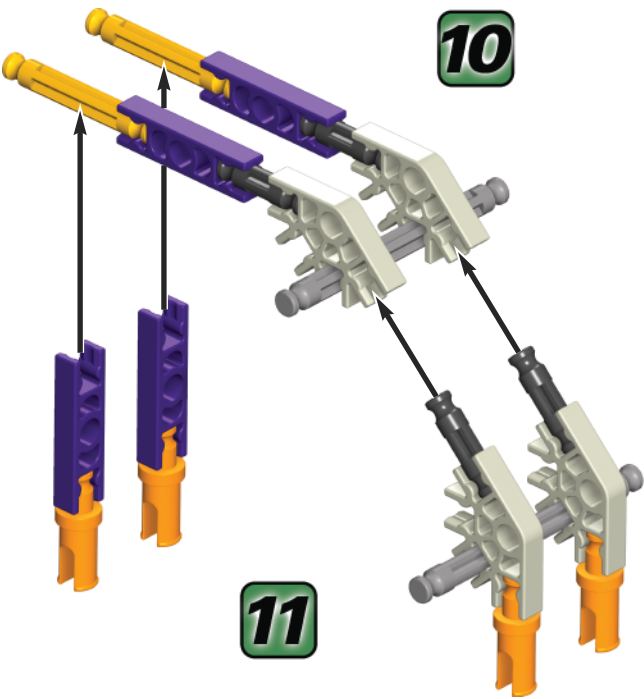

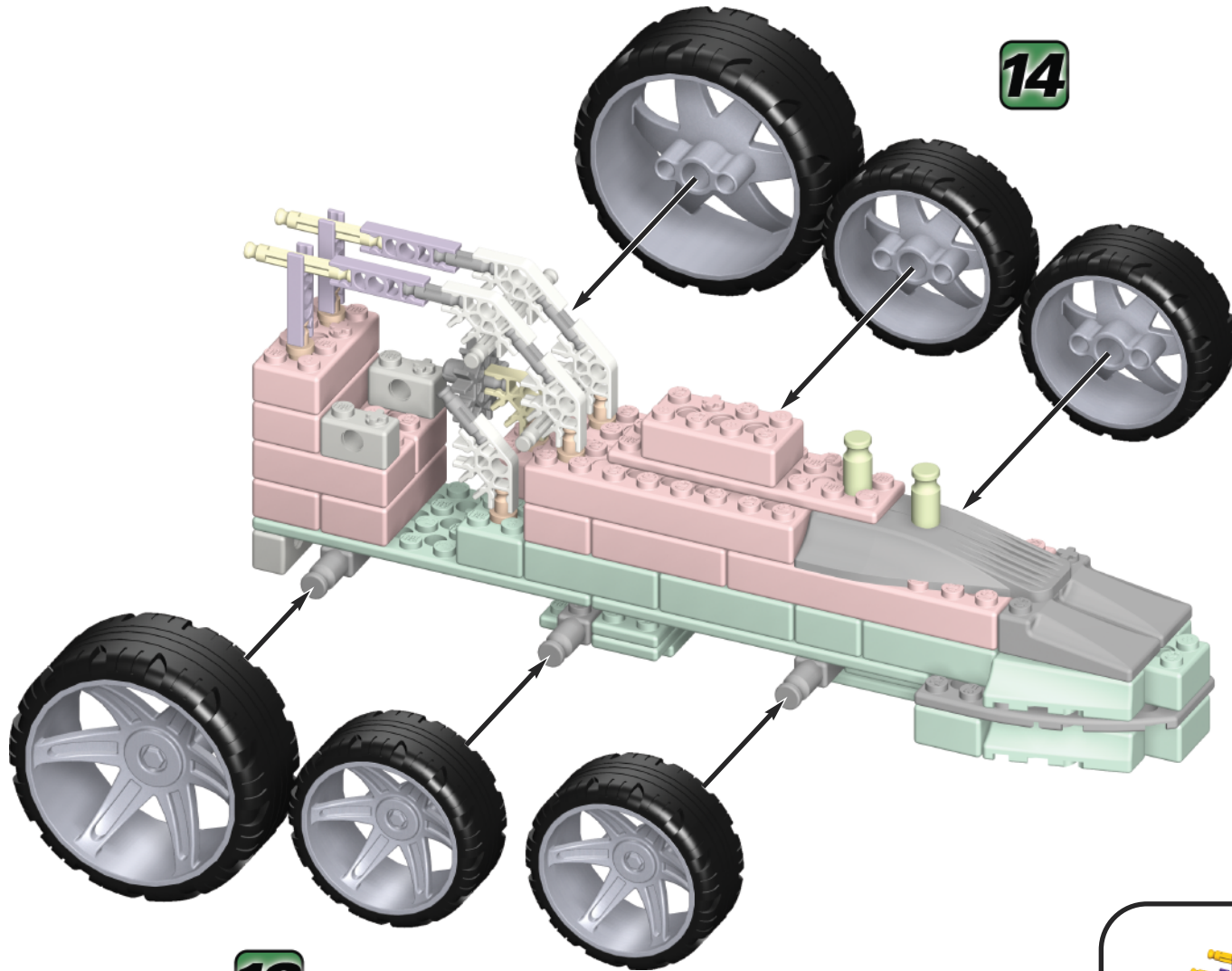

14

13

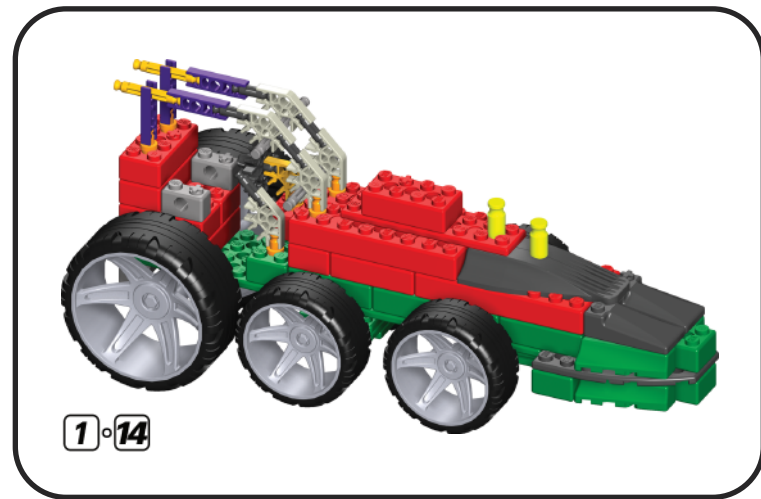

1-14

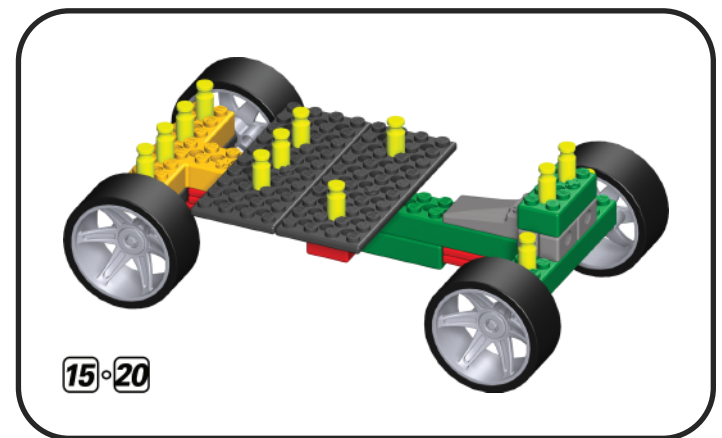
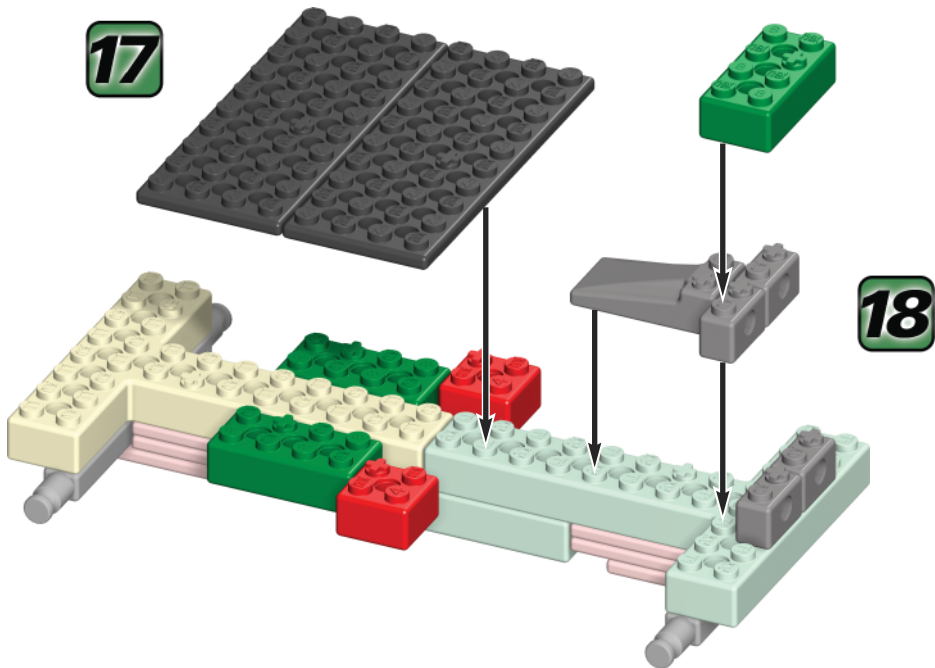
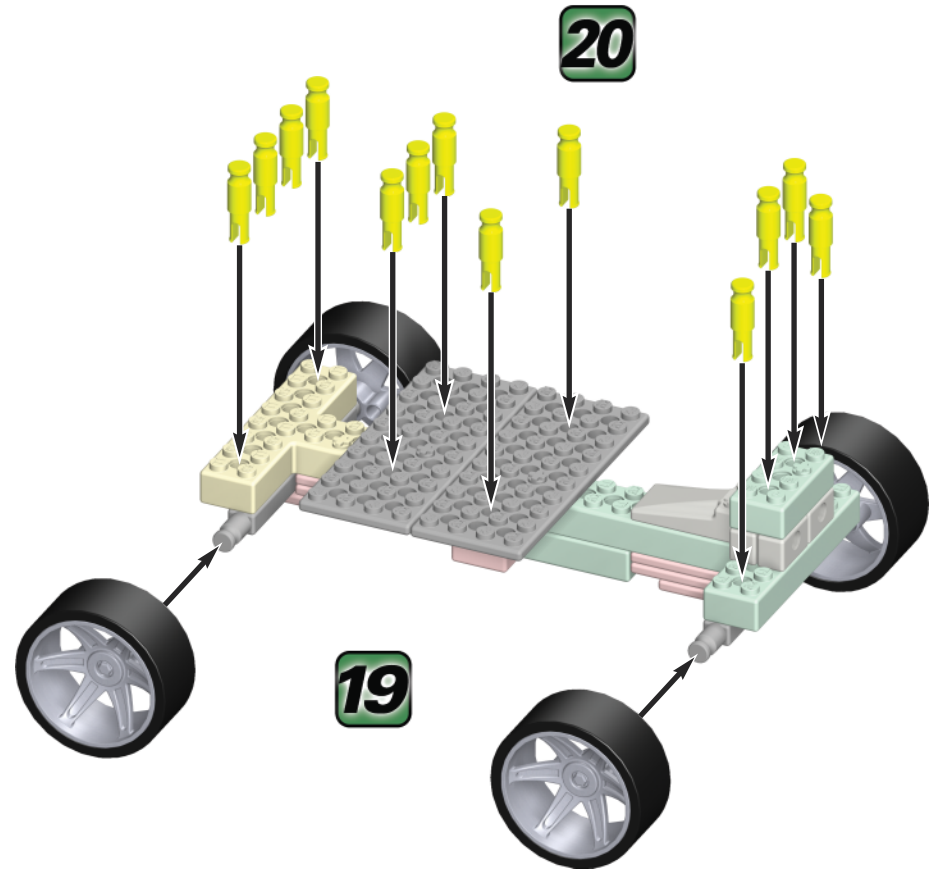
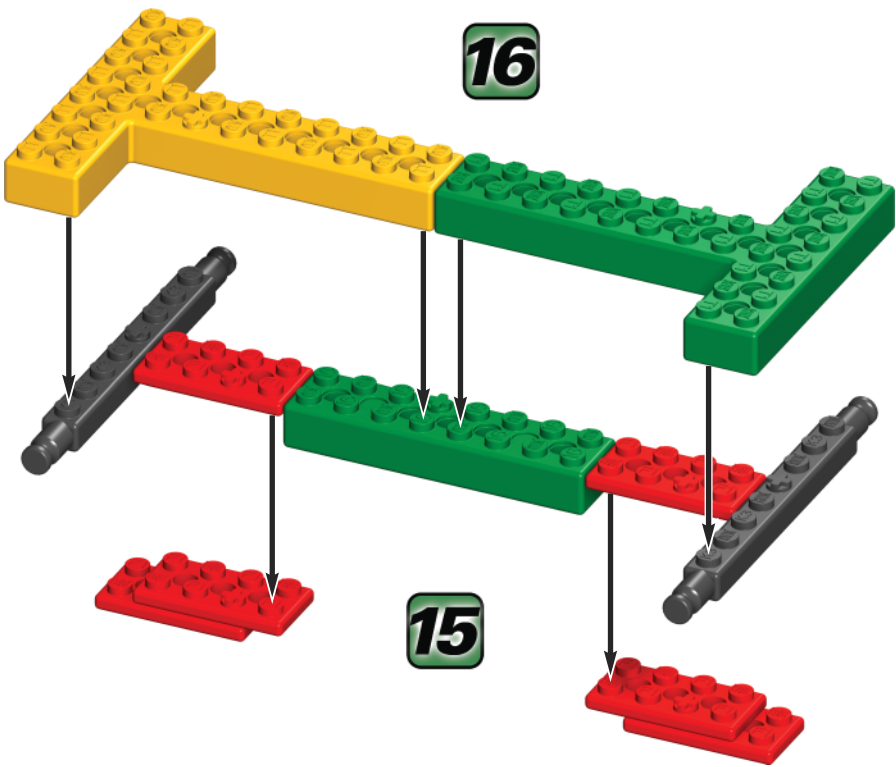

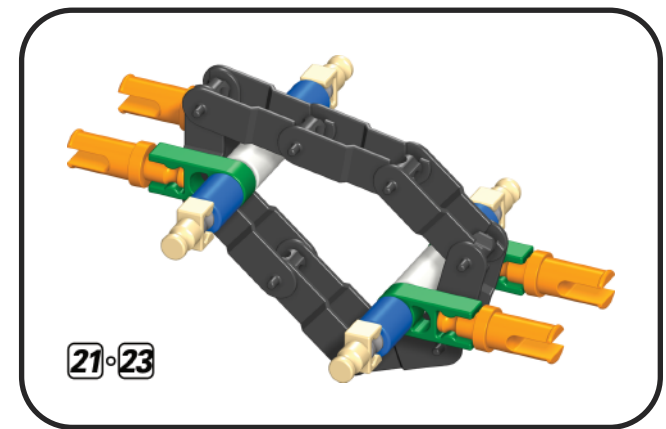
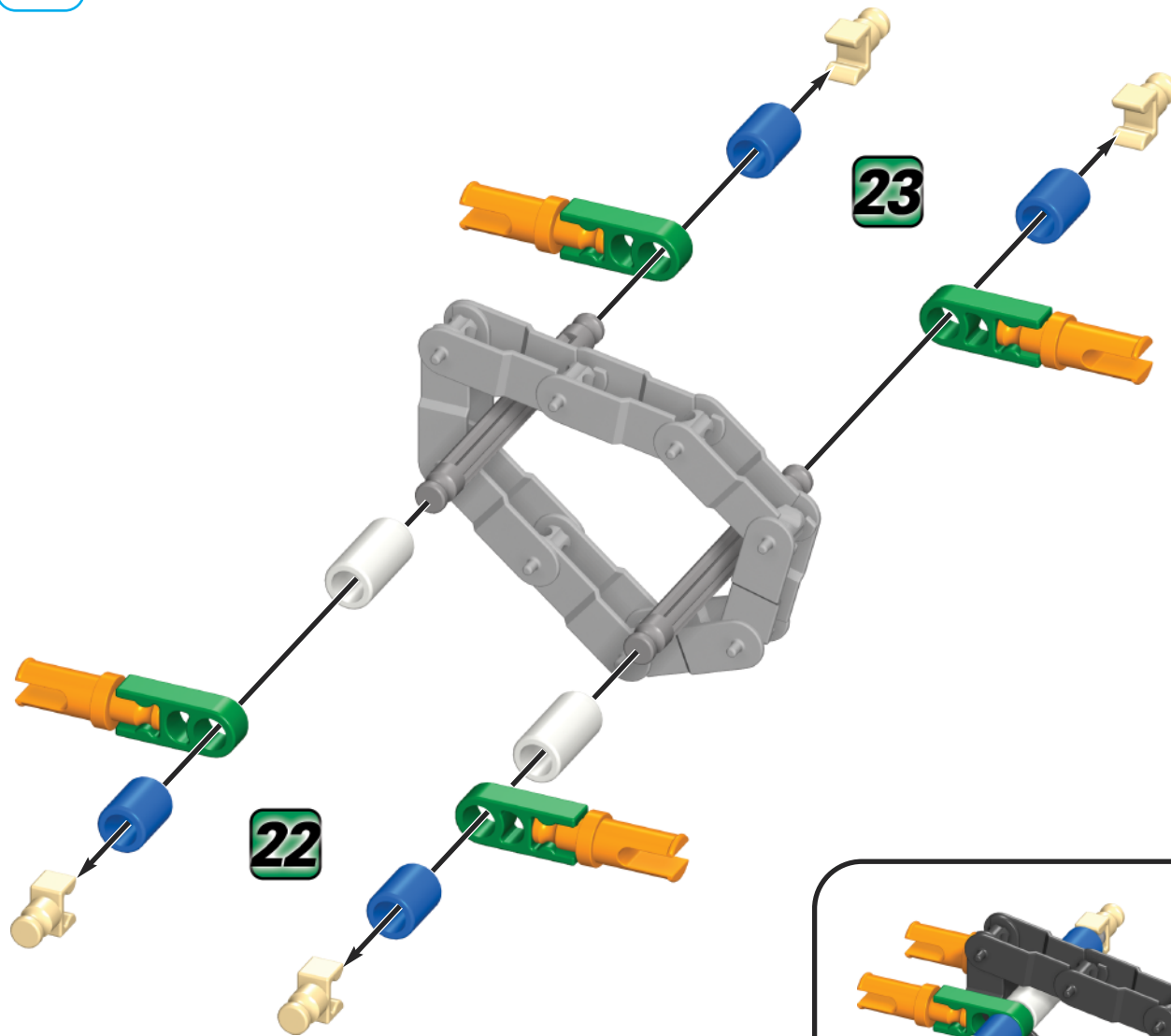
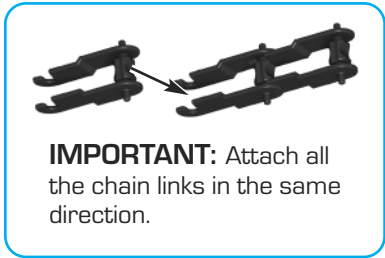
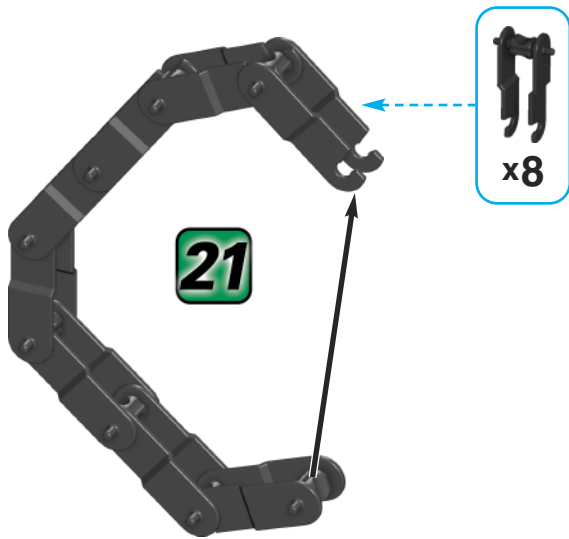

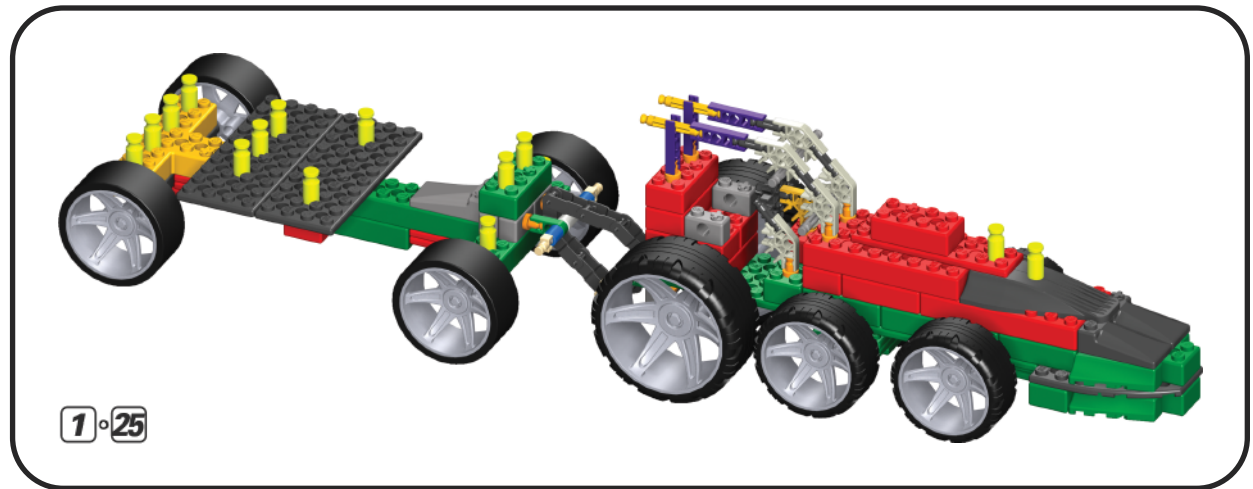
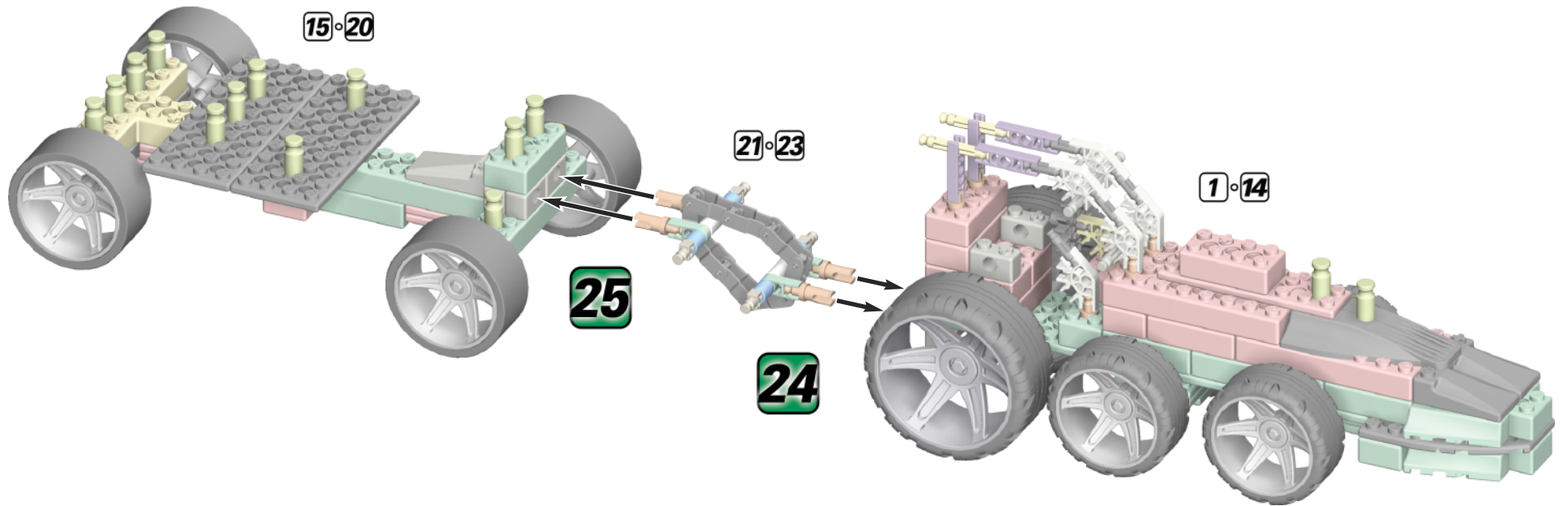

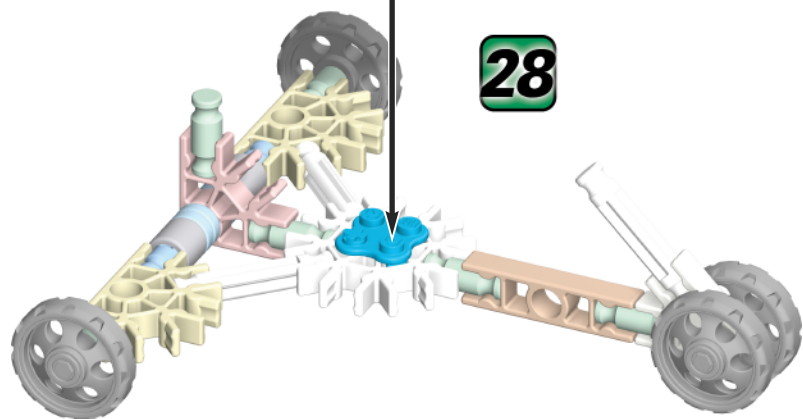
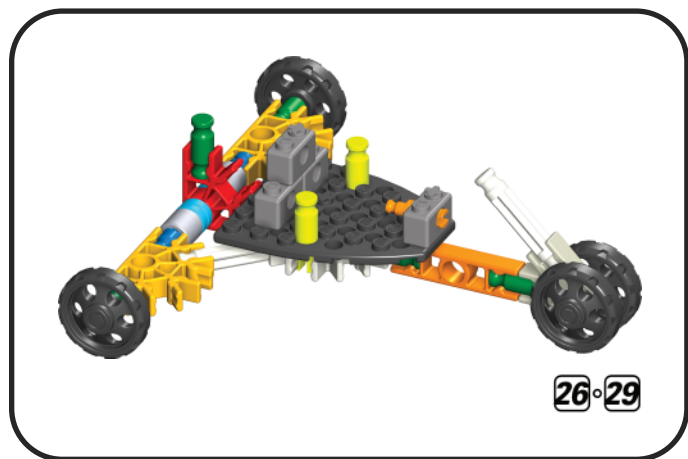
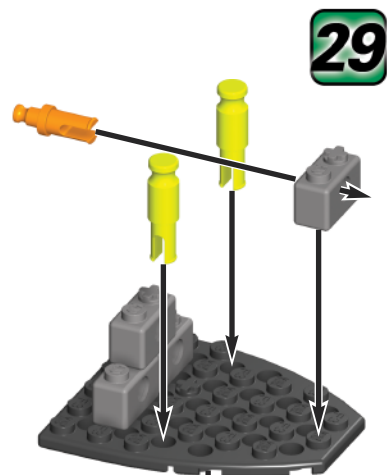
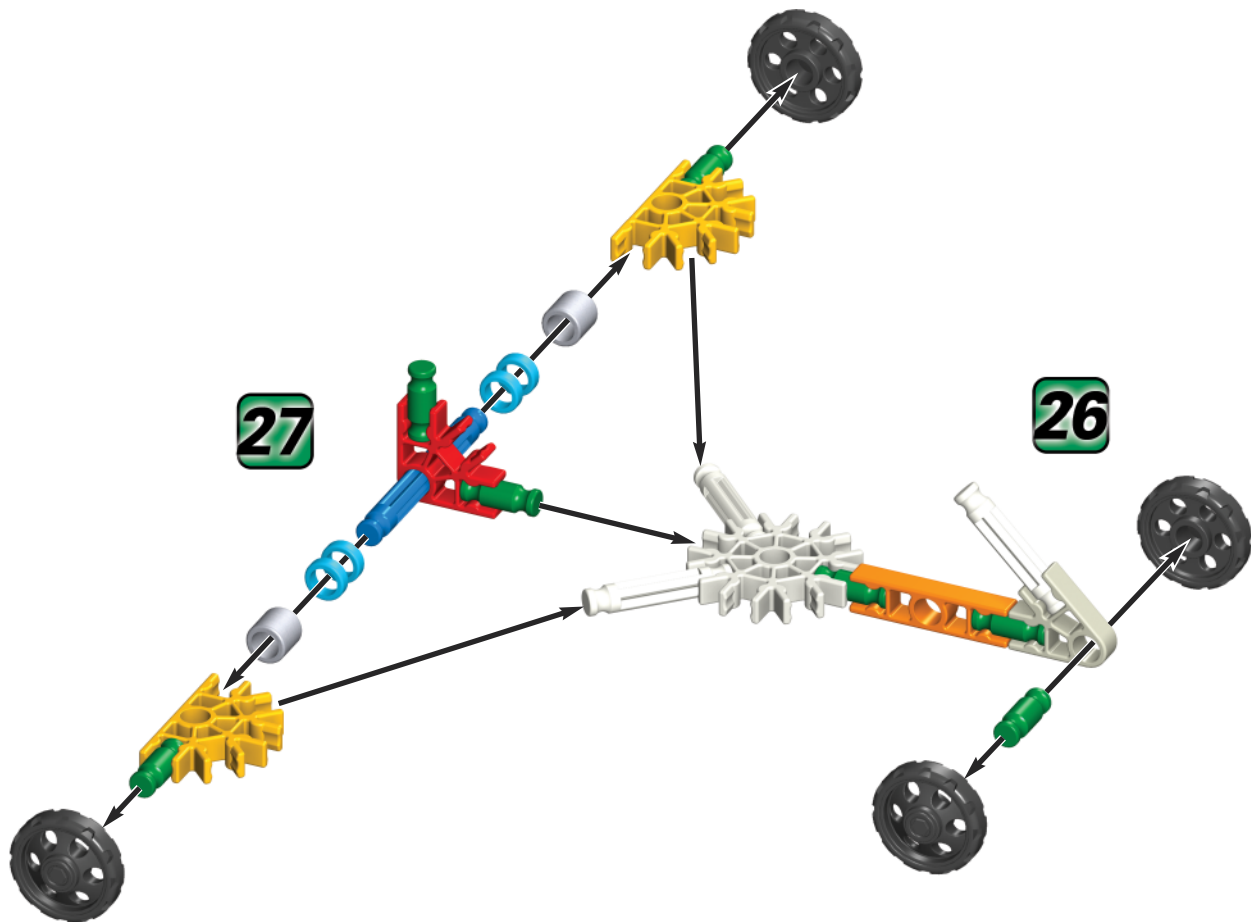



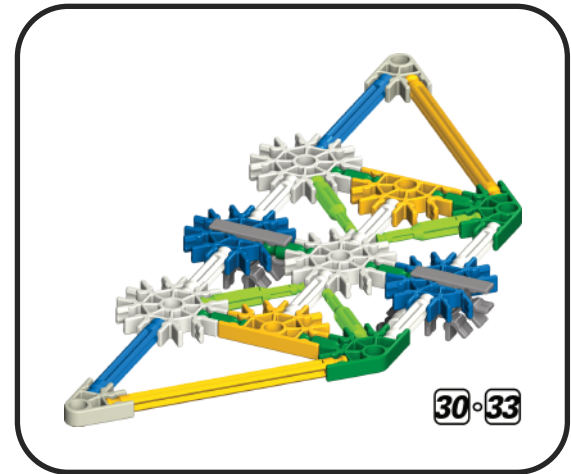
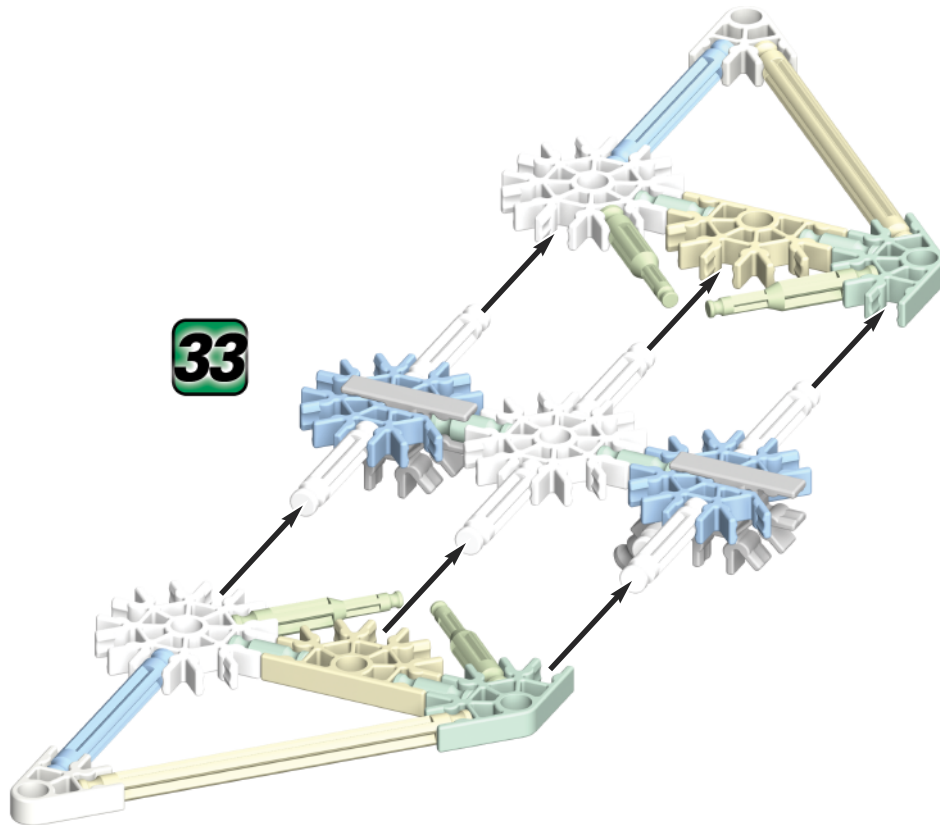
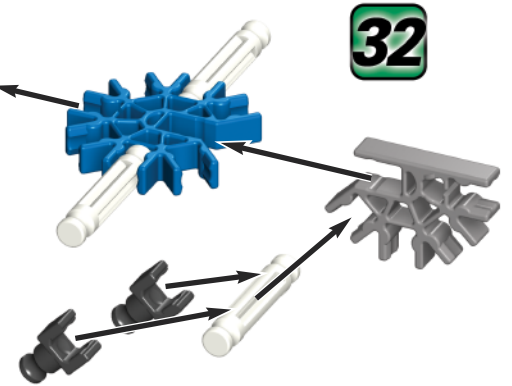
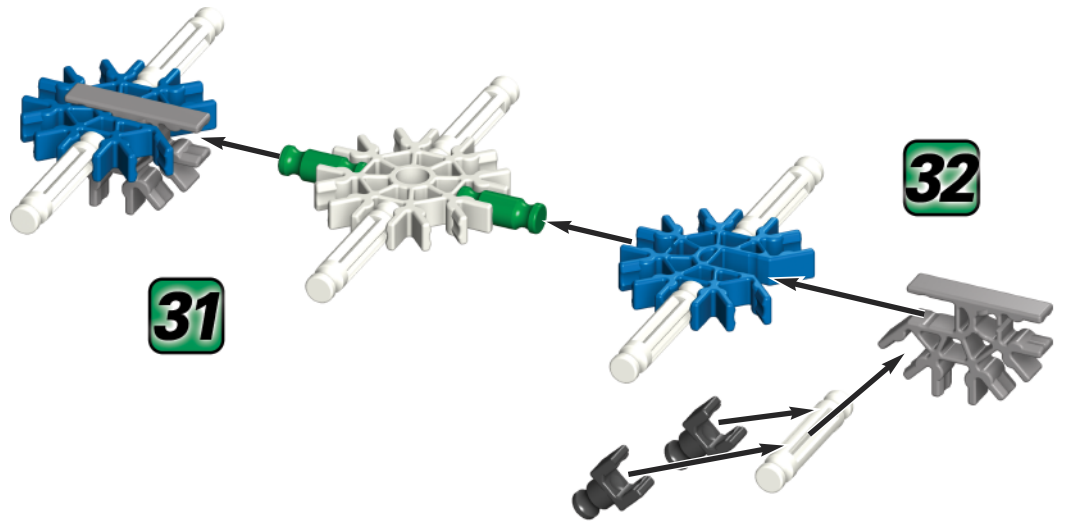
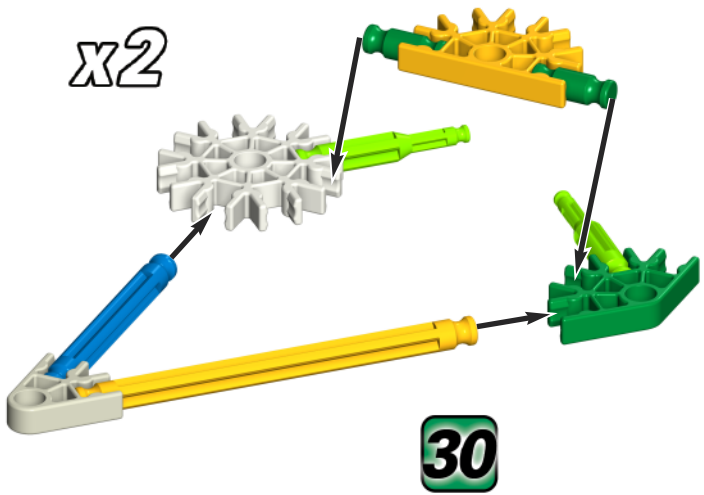

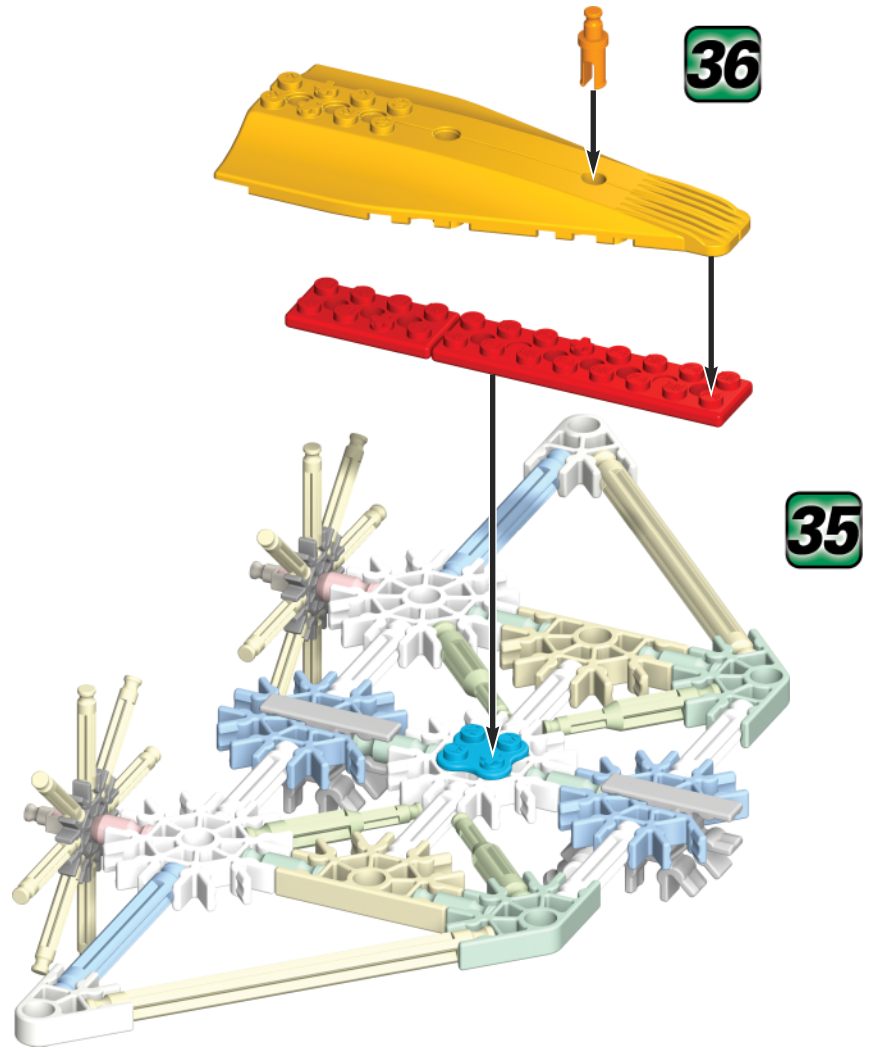
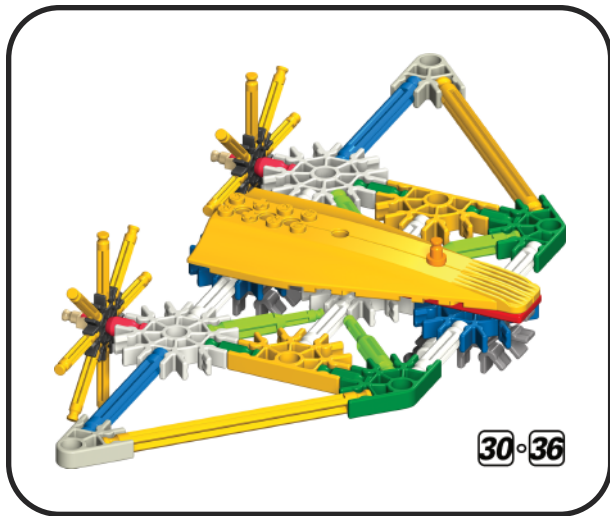
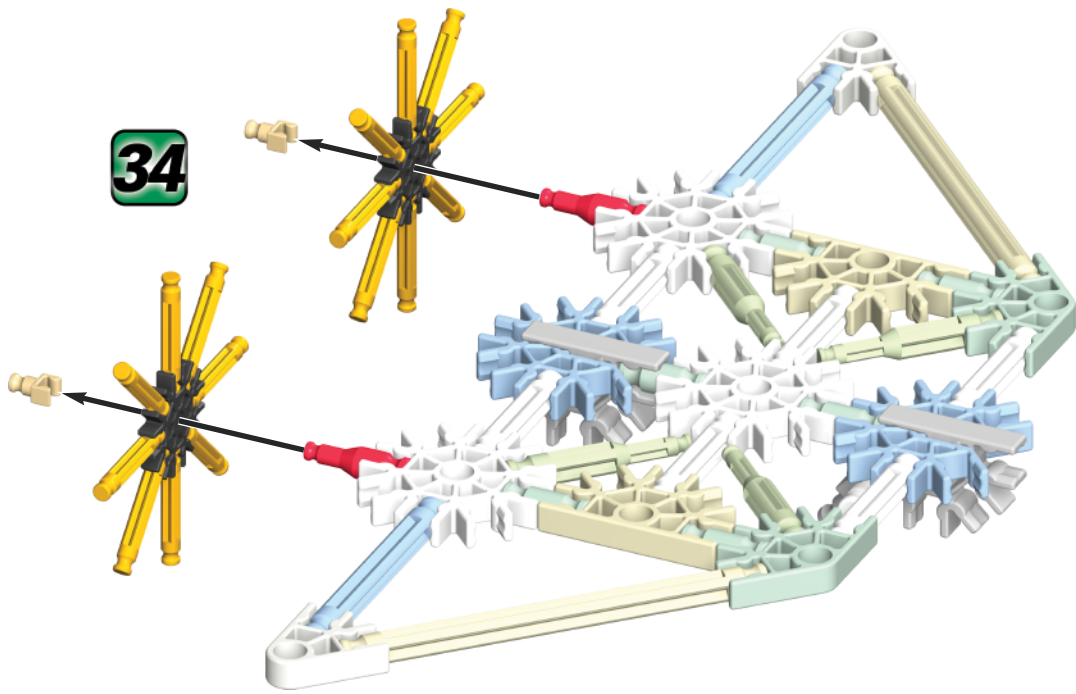

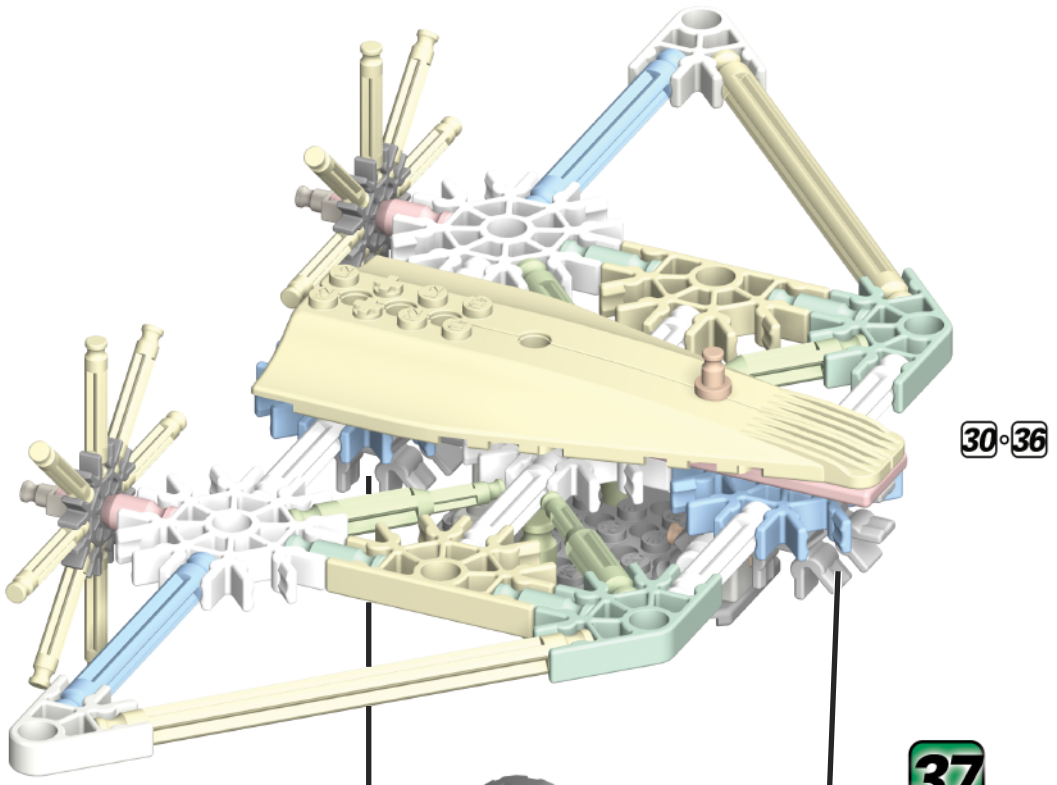

30-36

37

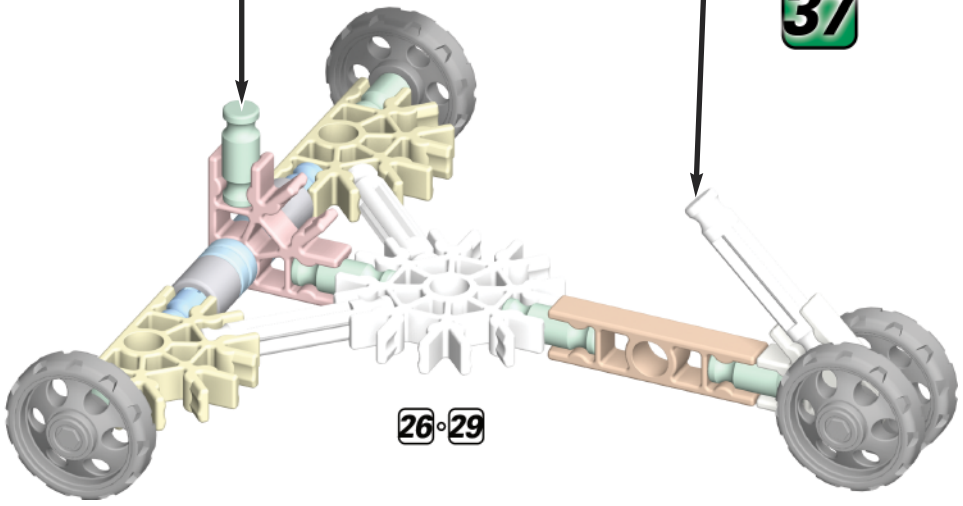

26-29



26-37

