

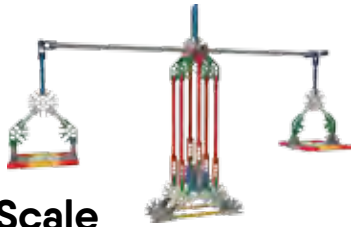

25th Anniversary Ultimate Builder's Case



Scale
page 132



Sea Monster
page 137

Swimming Pool
page 143



Table & Chairs
page 151

Teapot
page 158

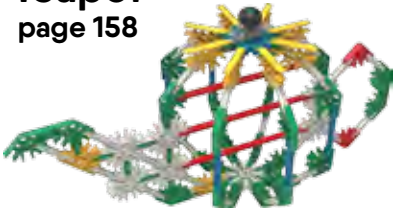

Tow Truck
page 161



Tractor
page 168



Tree
page 171



Wasp
page 175



Wave
page 181



Whale
page 182

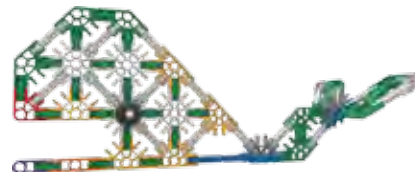

Windmill
page 184



SCALE

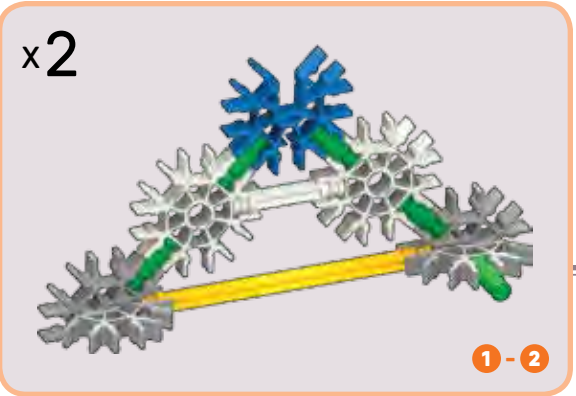
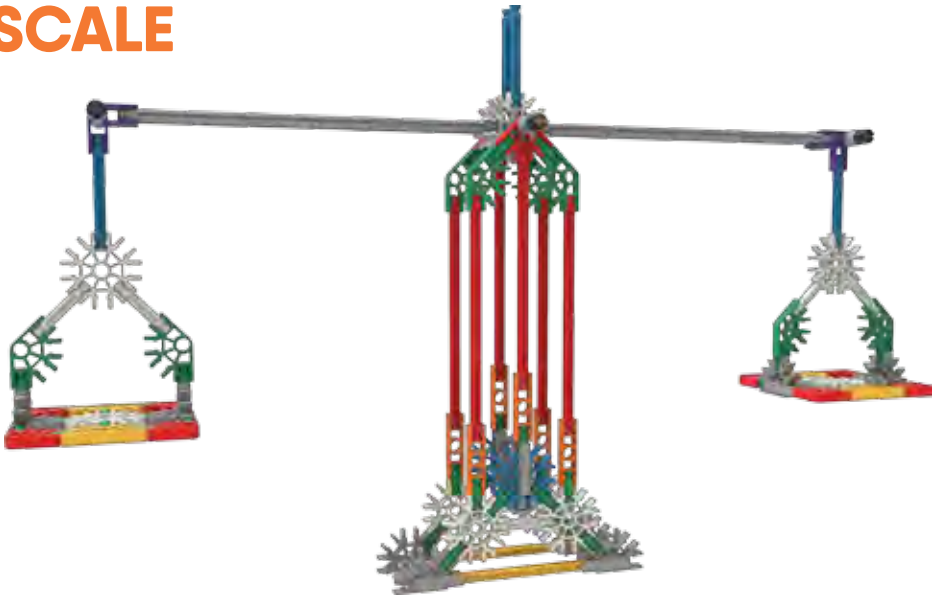

x2

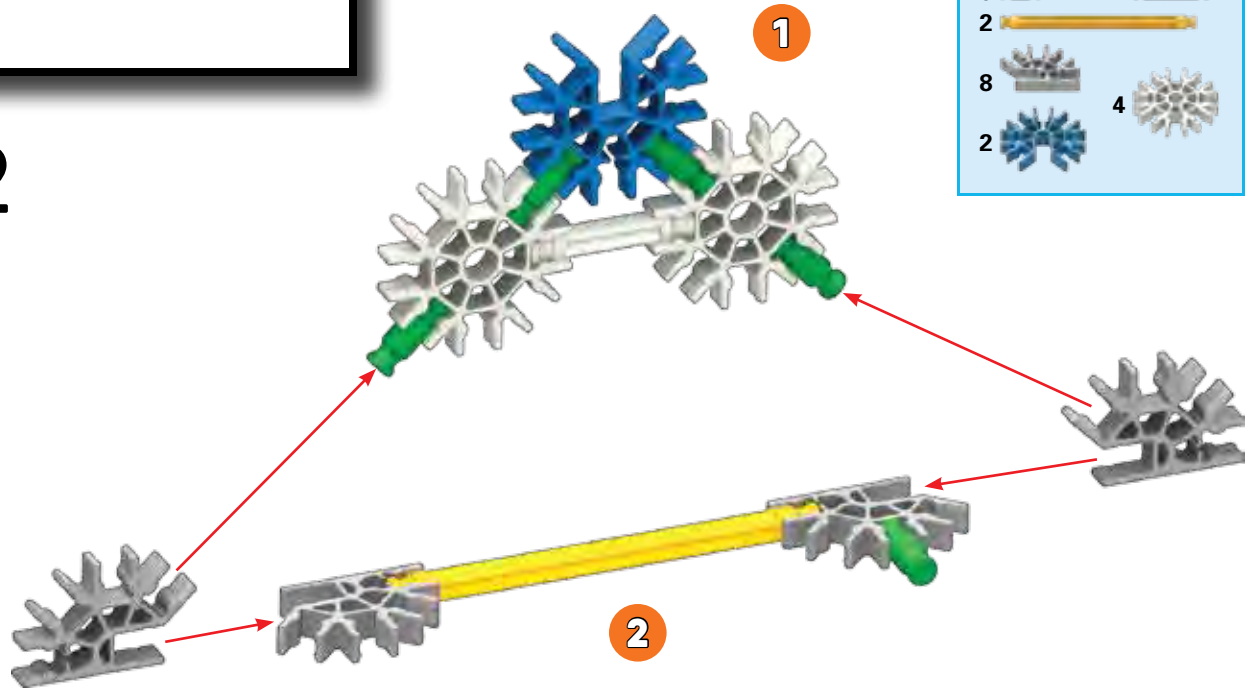

- | | | | |
|----|--|---|--|
| 10 | | 2 | |
| 2 | | | |
| 8 | | 4 | |
| 2 | | | |

x2

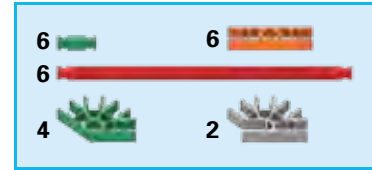
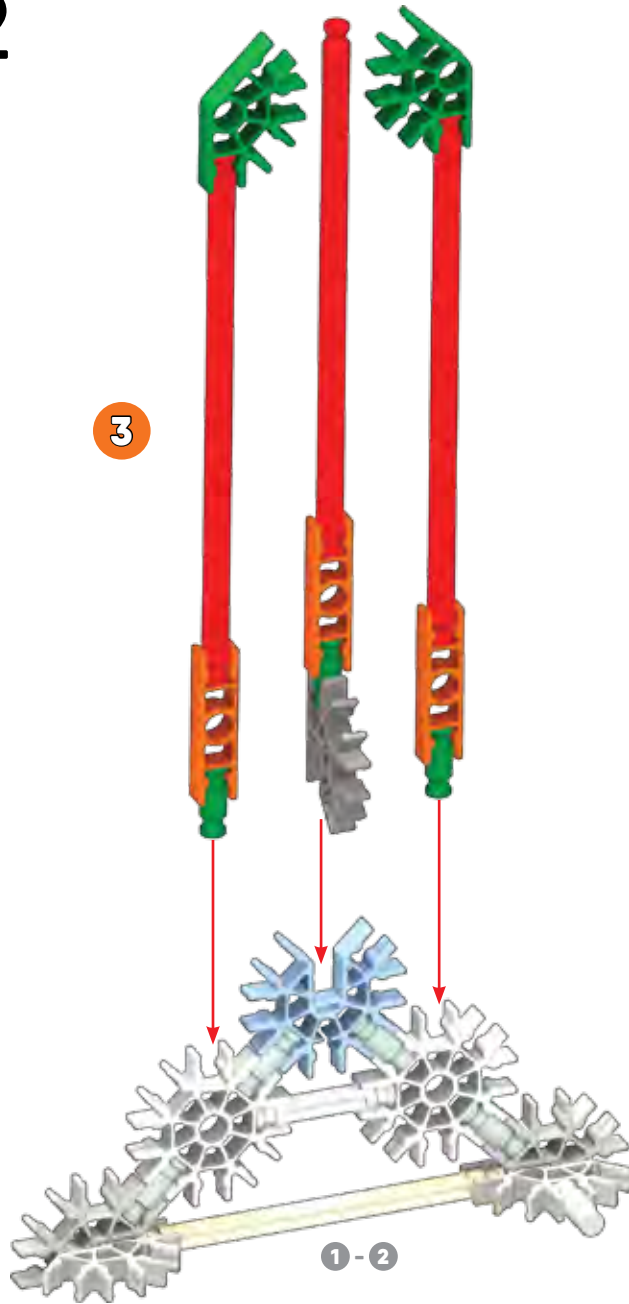

x2

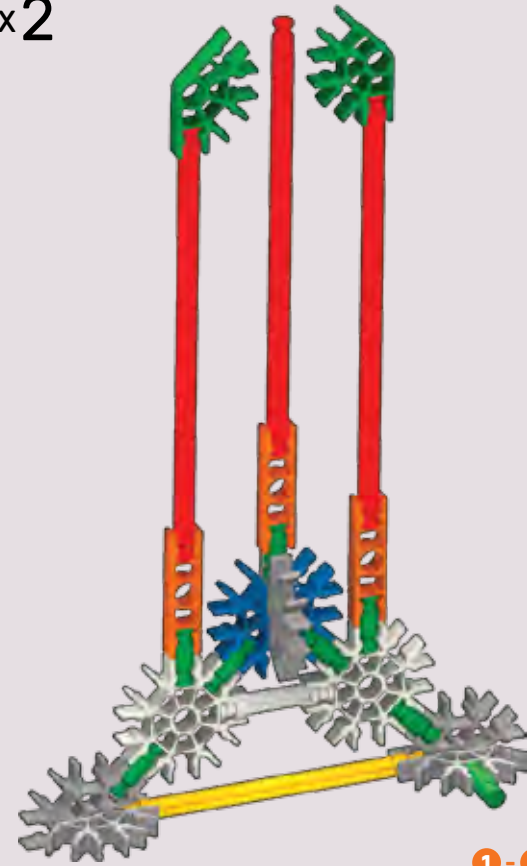

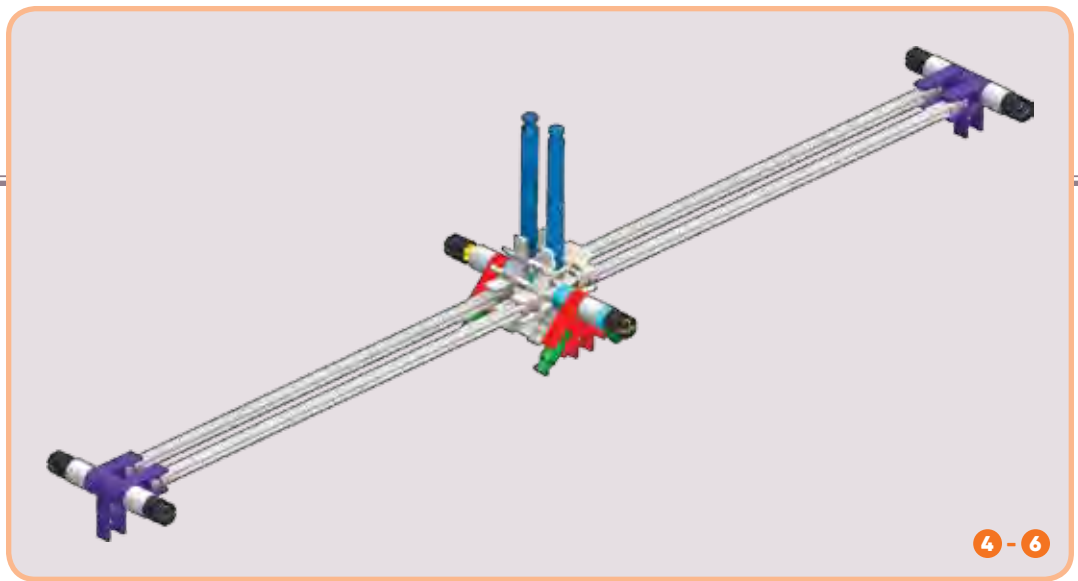
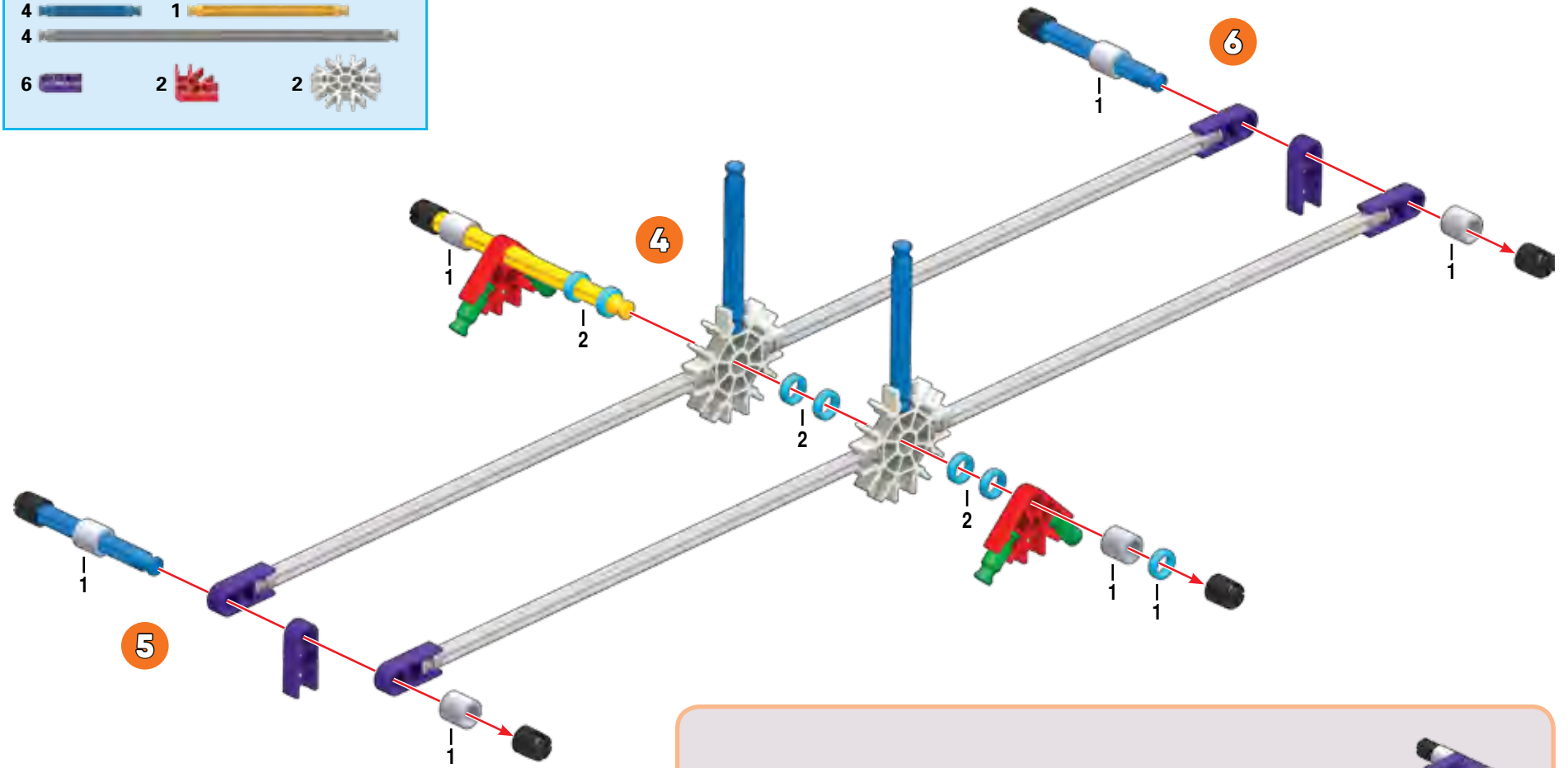

4-6

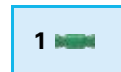
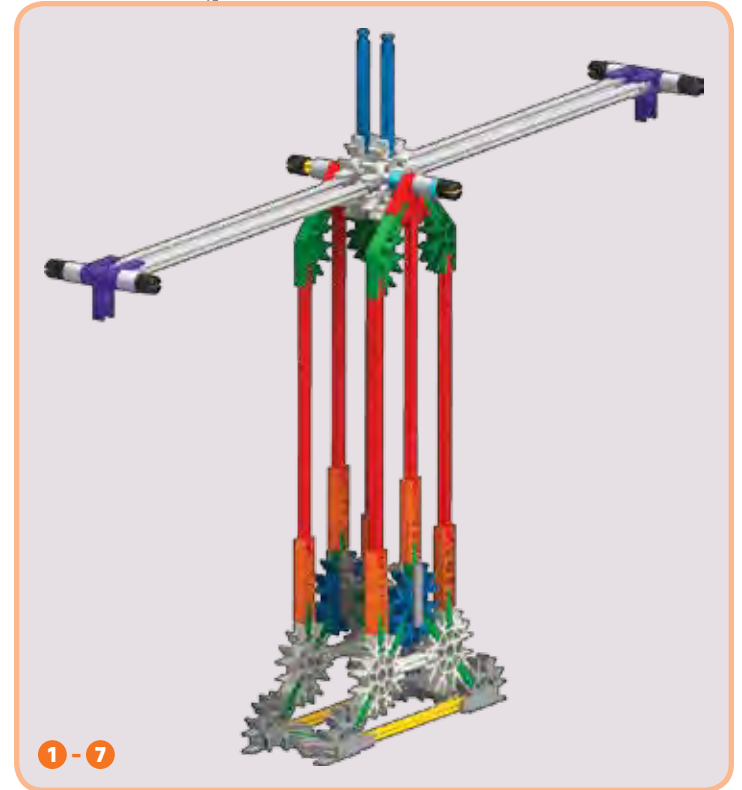
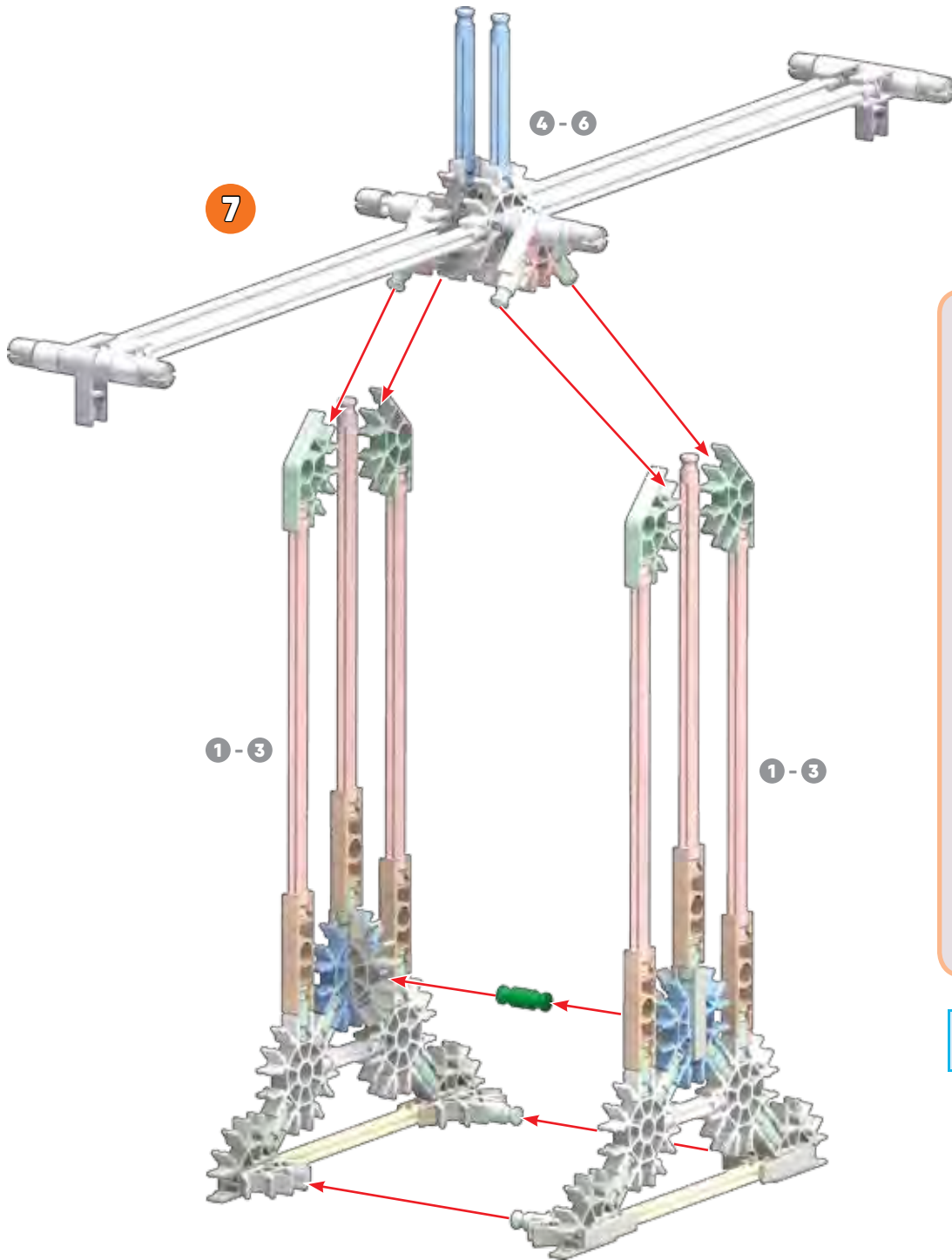

x2

9

28		4	
2		4	
8		4	
8		4	
4			

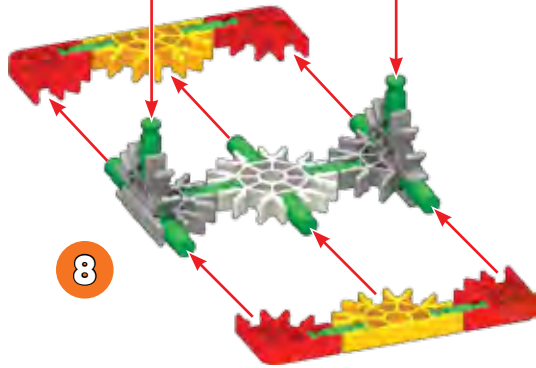

8

x2



8-9

SCALE

1-11

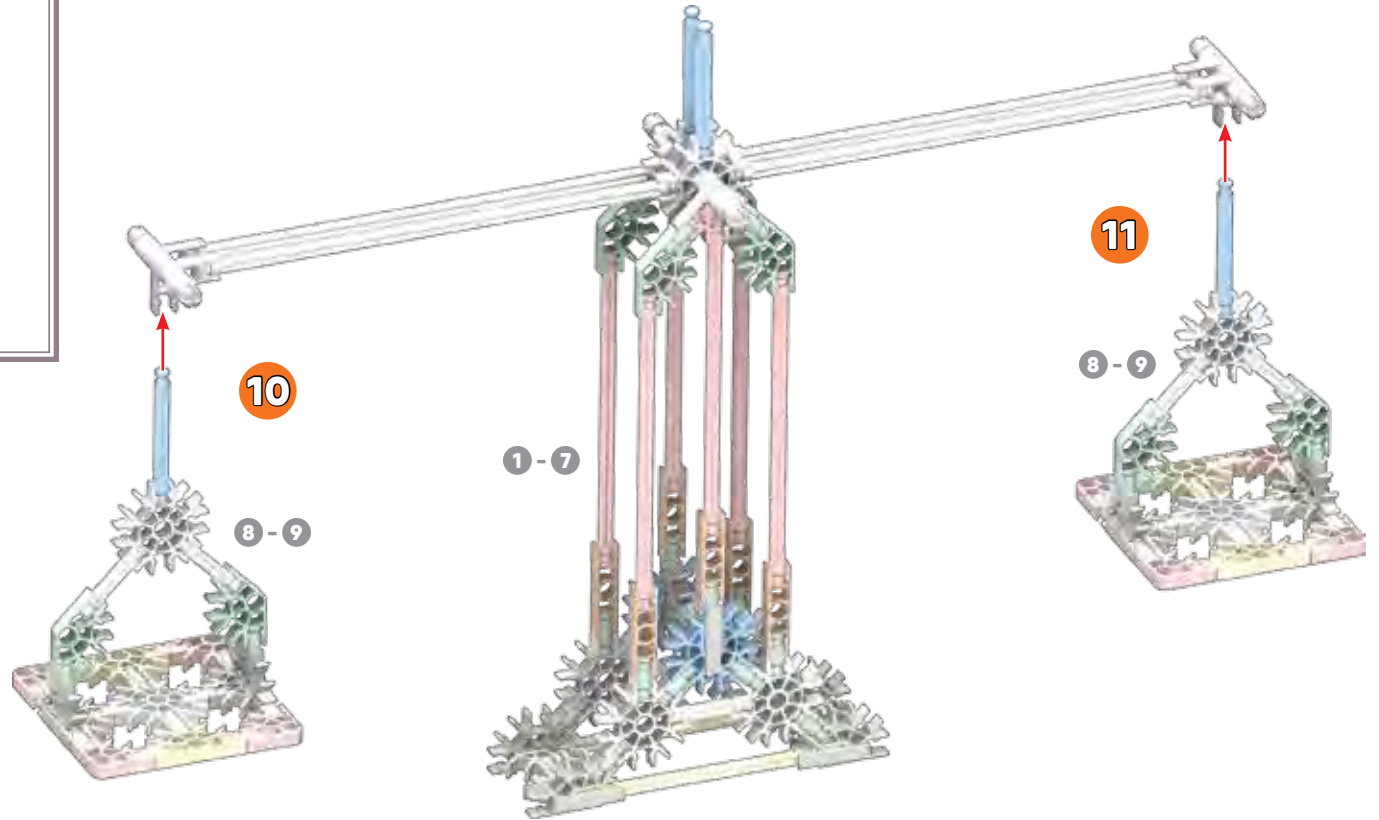
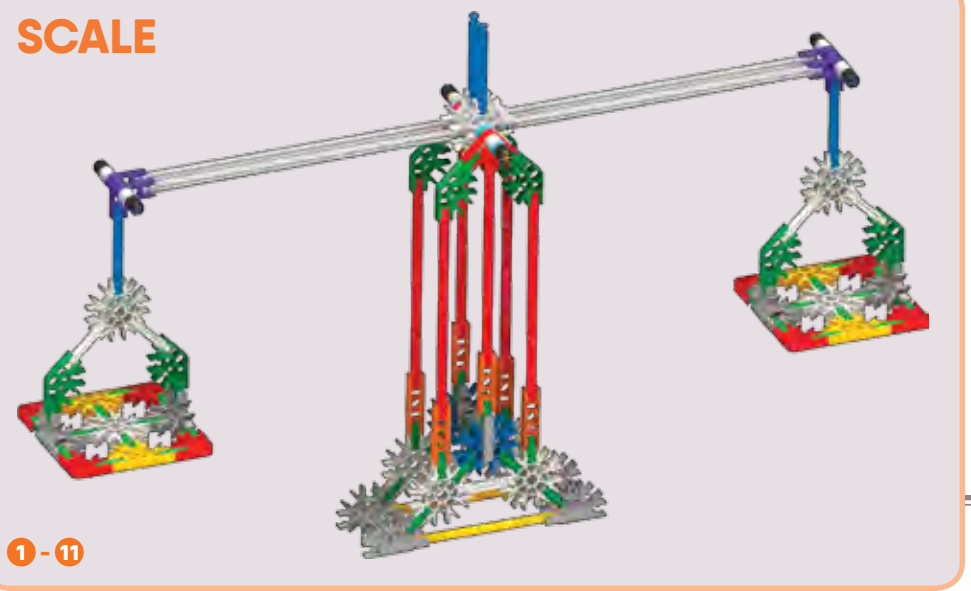

10

8-9

1-7

11

8-9

SEA MONSTER



10		7	
1		2	
8		2	

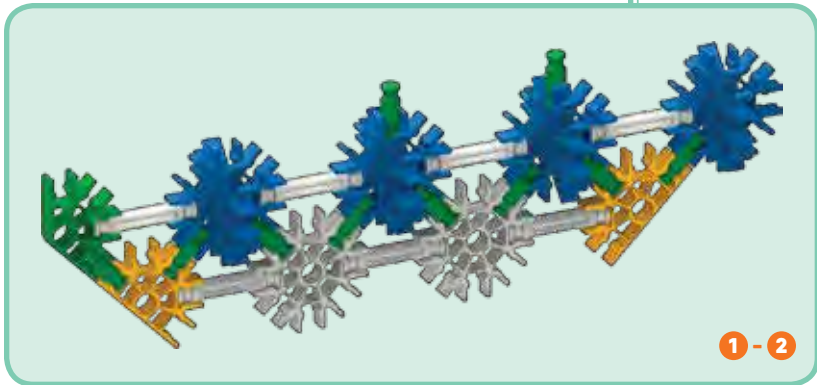
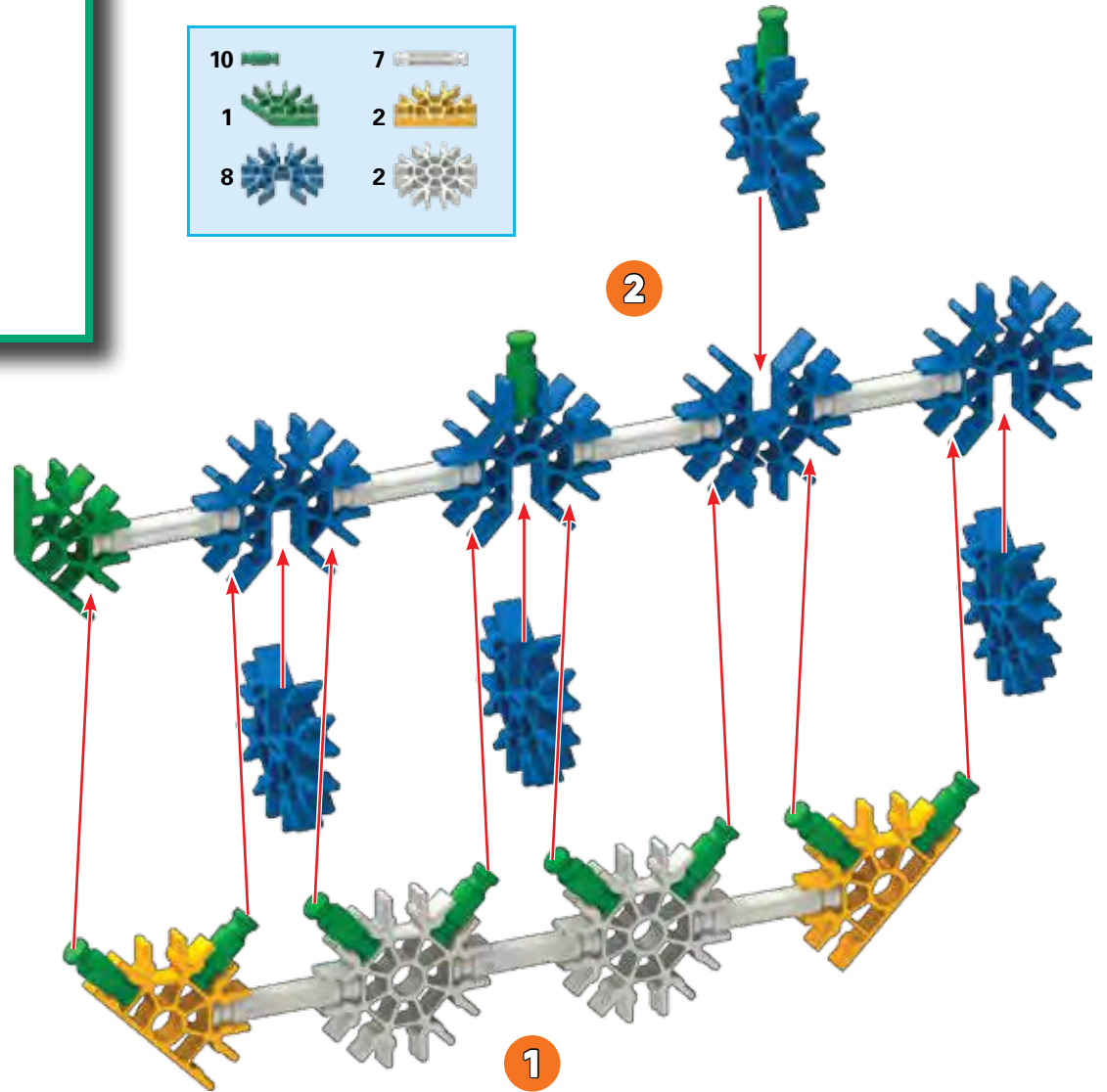

- | | | | |
|----|--|---|--|
| 12 | | 2 | |
| 5 | | 2 | |
| 1 | | | |

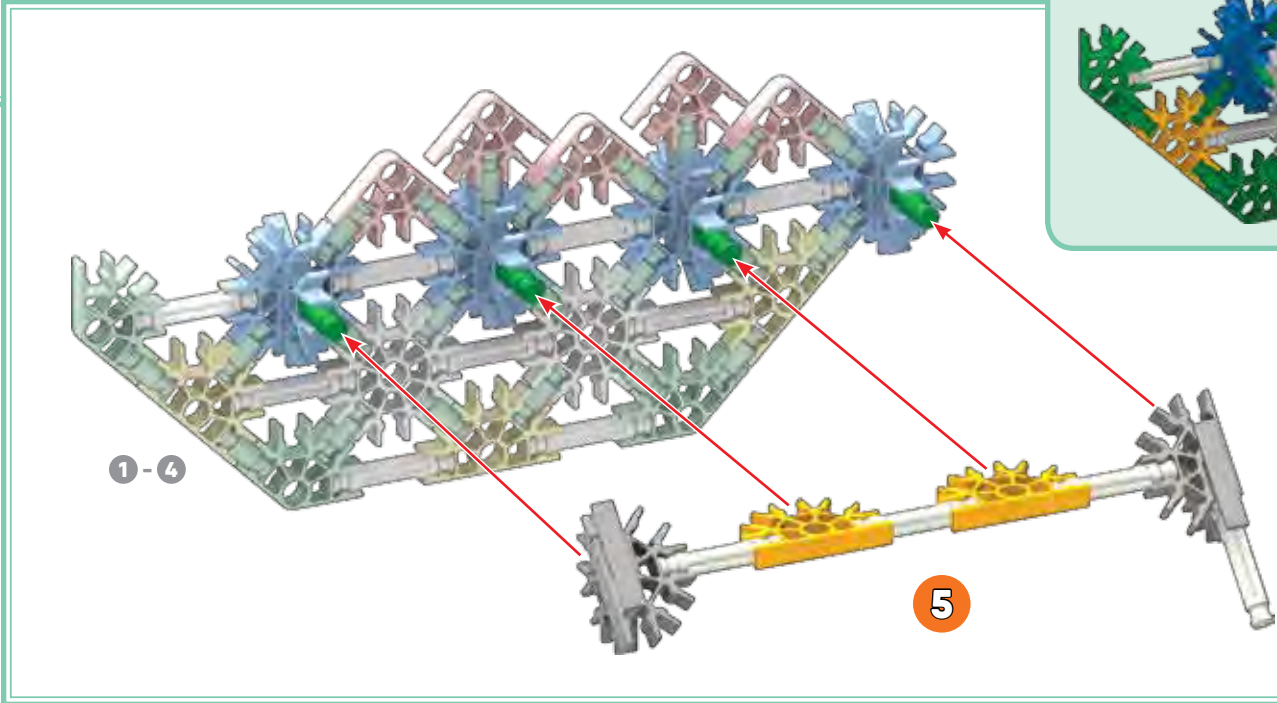
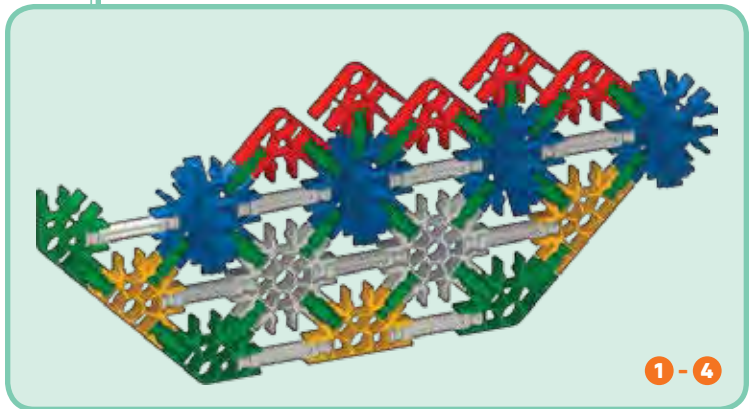
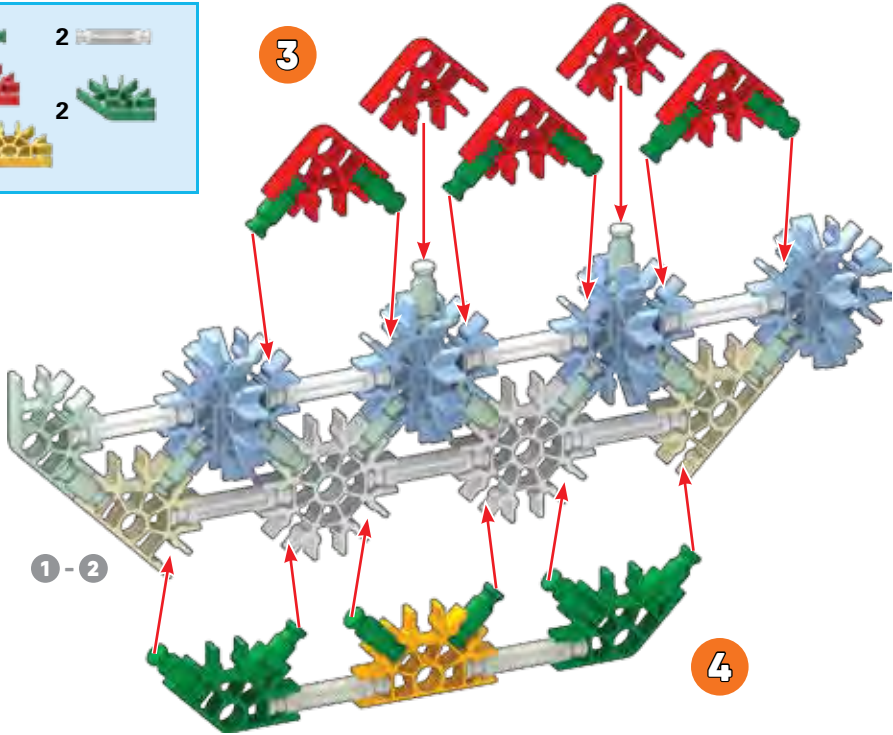

- | | | | |
|---|--|---|--|
| 4 | | 4 | |
| 4 | | 2 | |

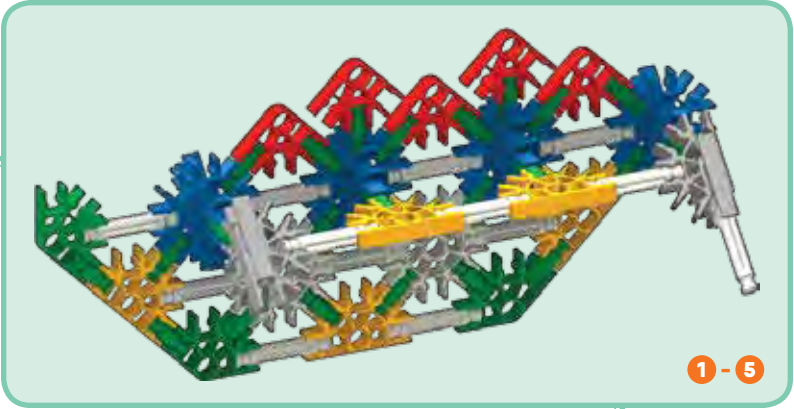

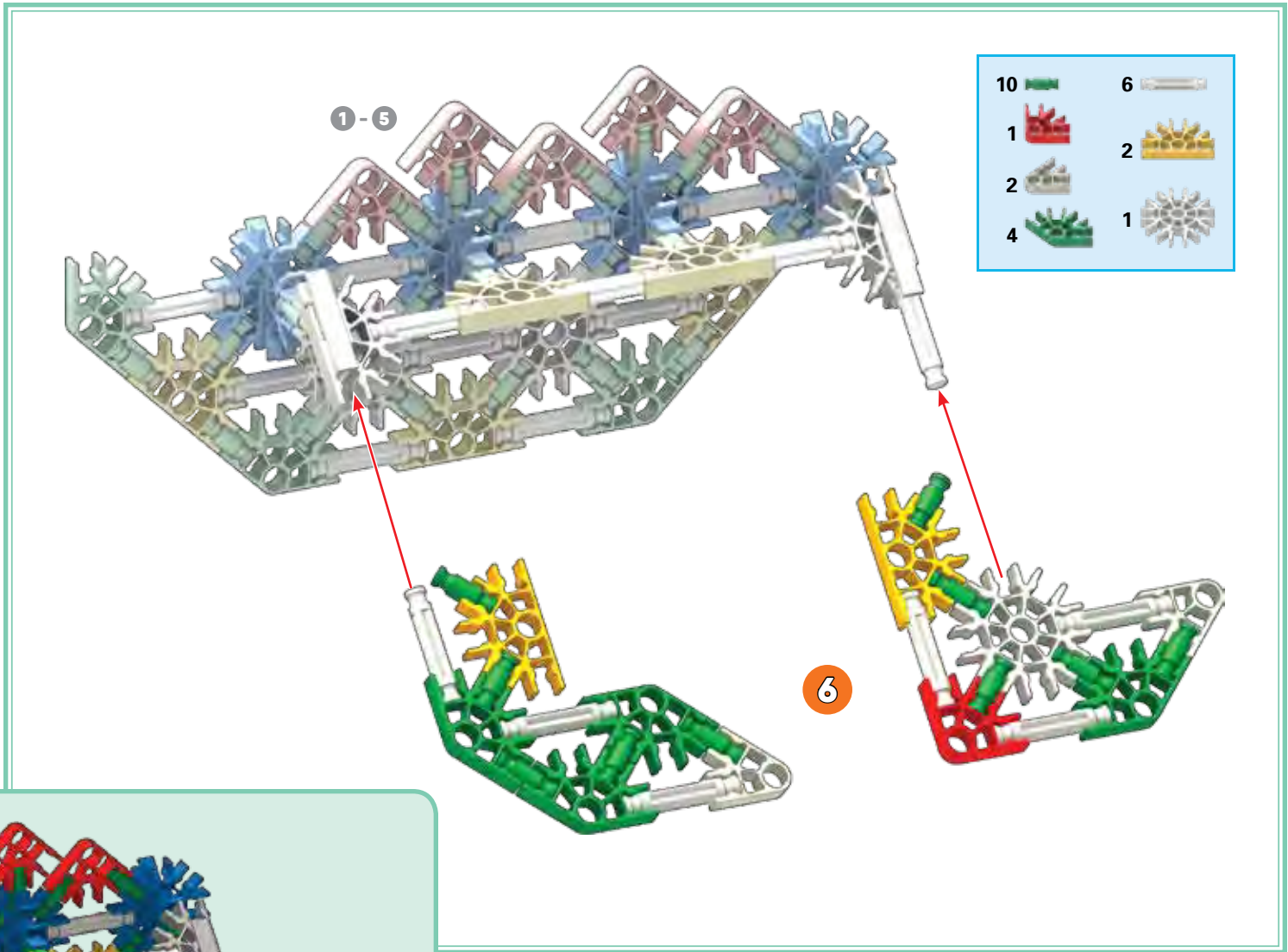

rotate model

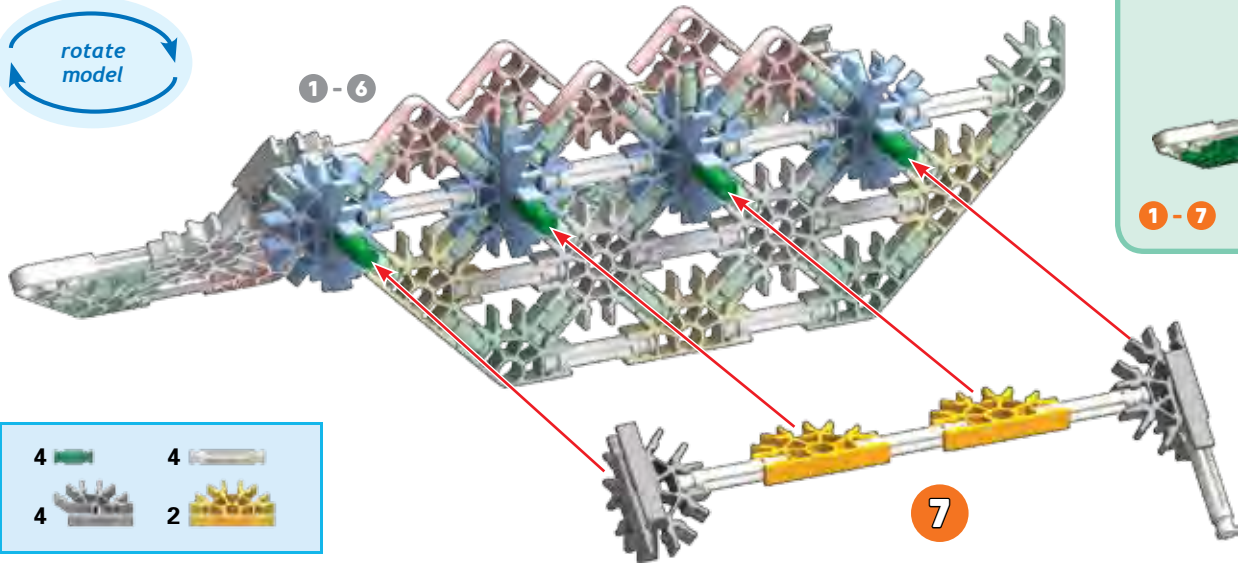

- | | |
|---|---|
| 4 | 4 |
| 4 | 2 |

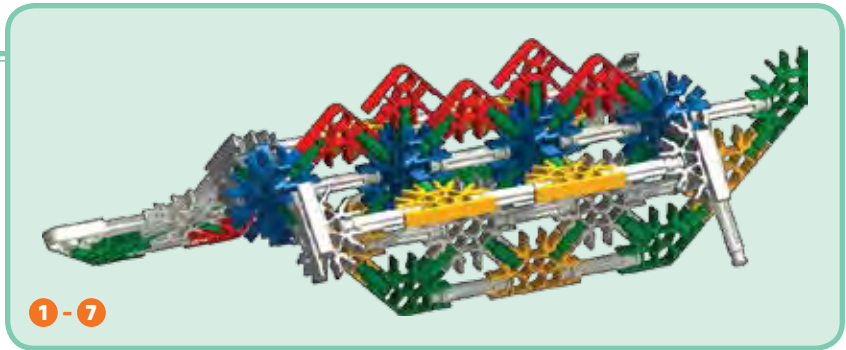

- | | |
|----|---|
| 10 | 6 |
| 1 | 2 |
| 2 | 1 |
| 4 | 1 |

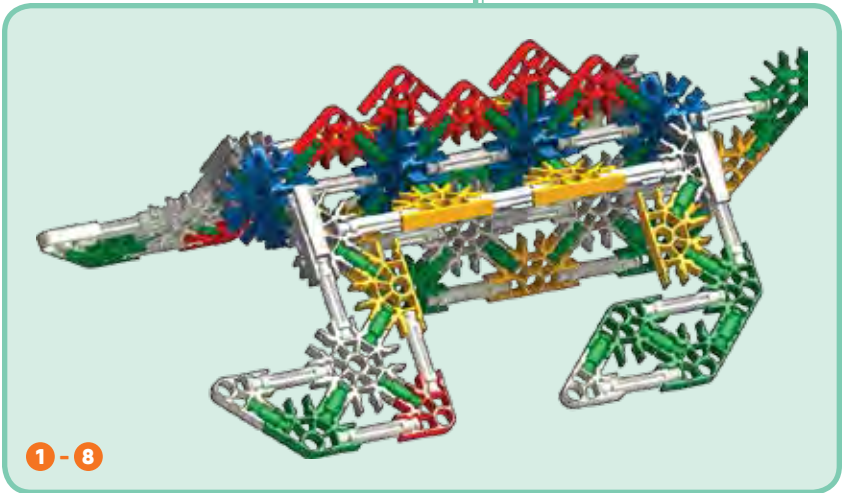
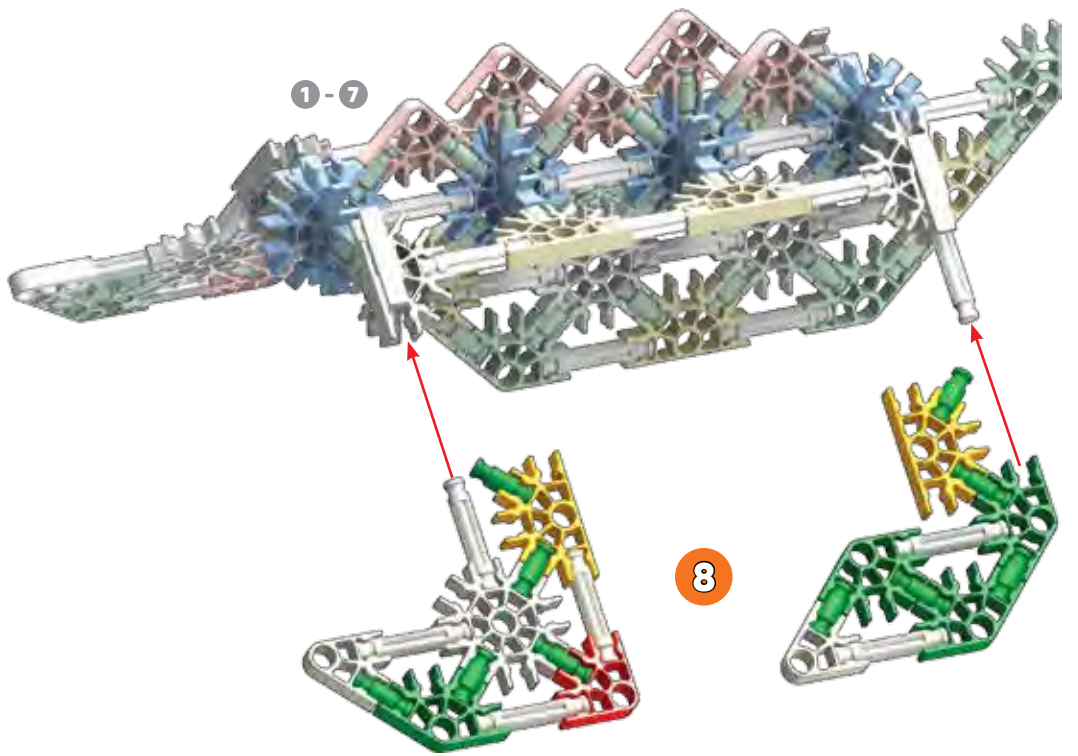

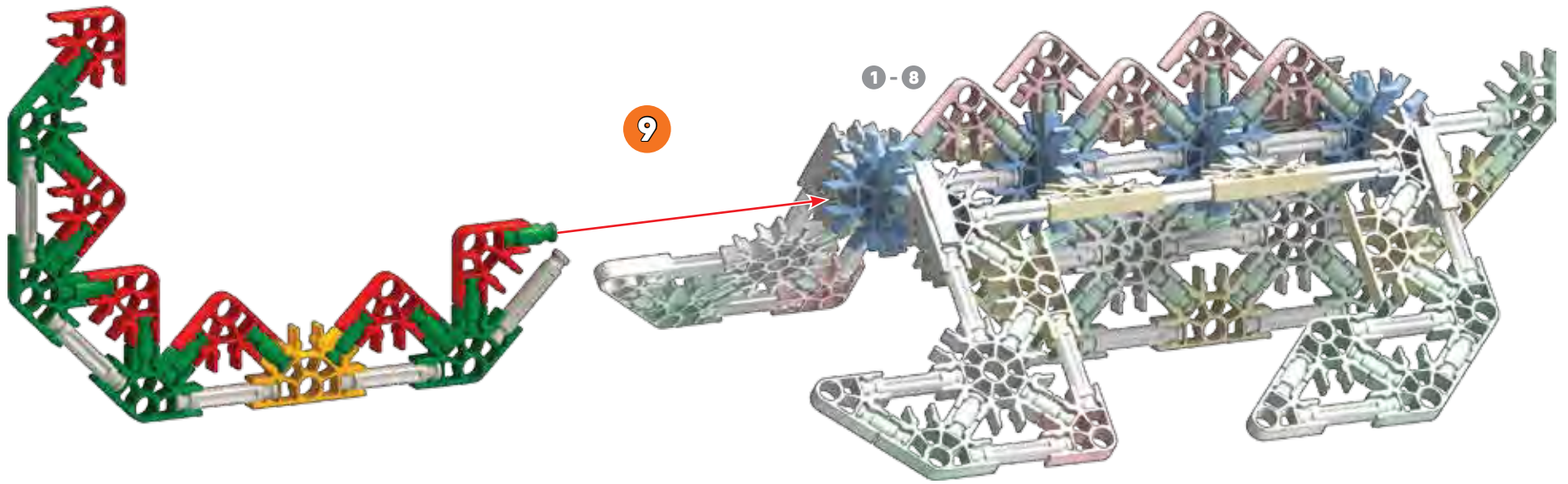

- | | |
|----|---|
| 11 | 5 |
| 6 | 4 |
| 1 | |



SEA MONSTER

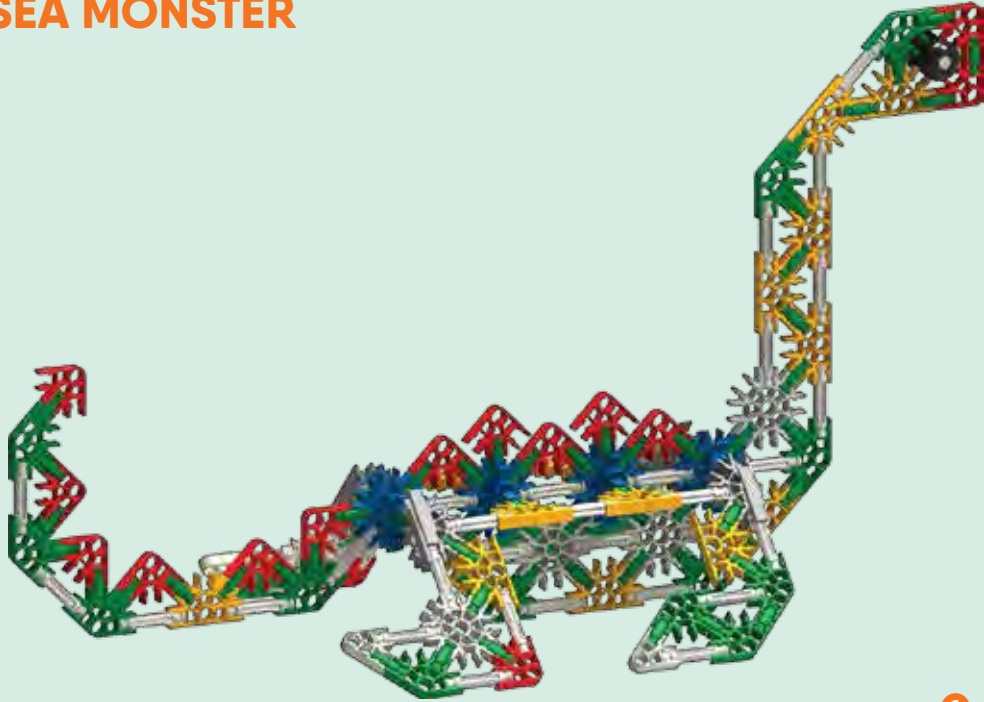

1 - 10

10



1 - 9

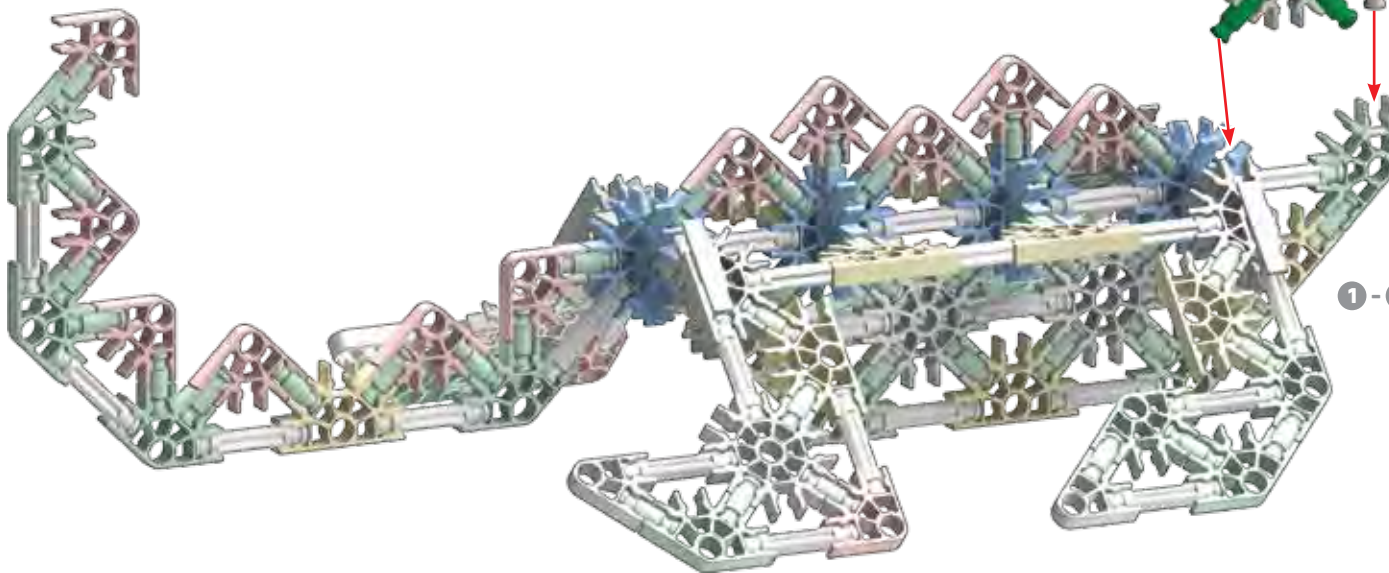

1		2	
12		7	
2		1	
2		5	

SWIMMING POOL

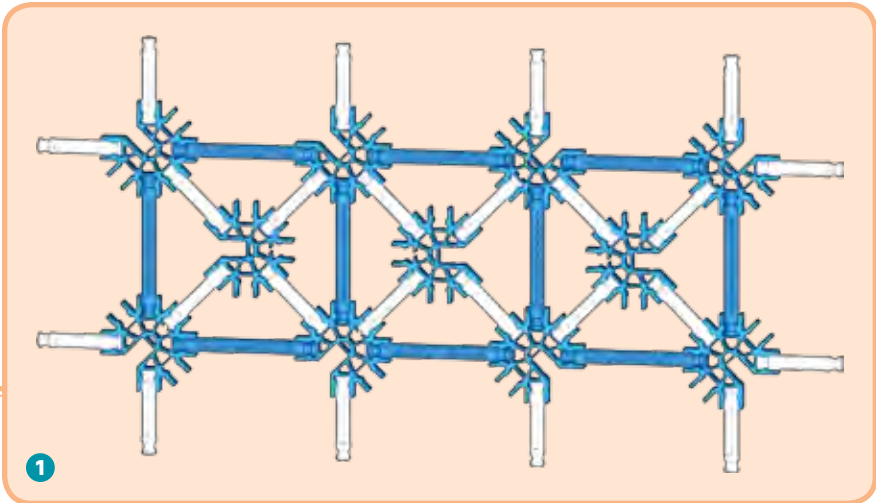

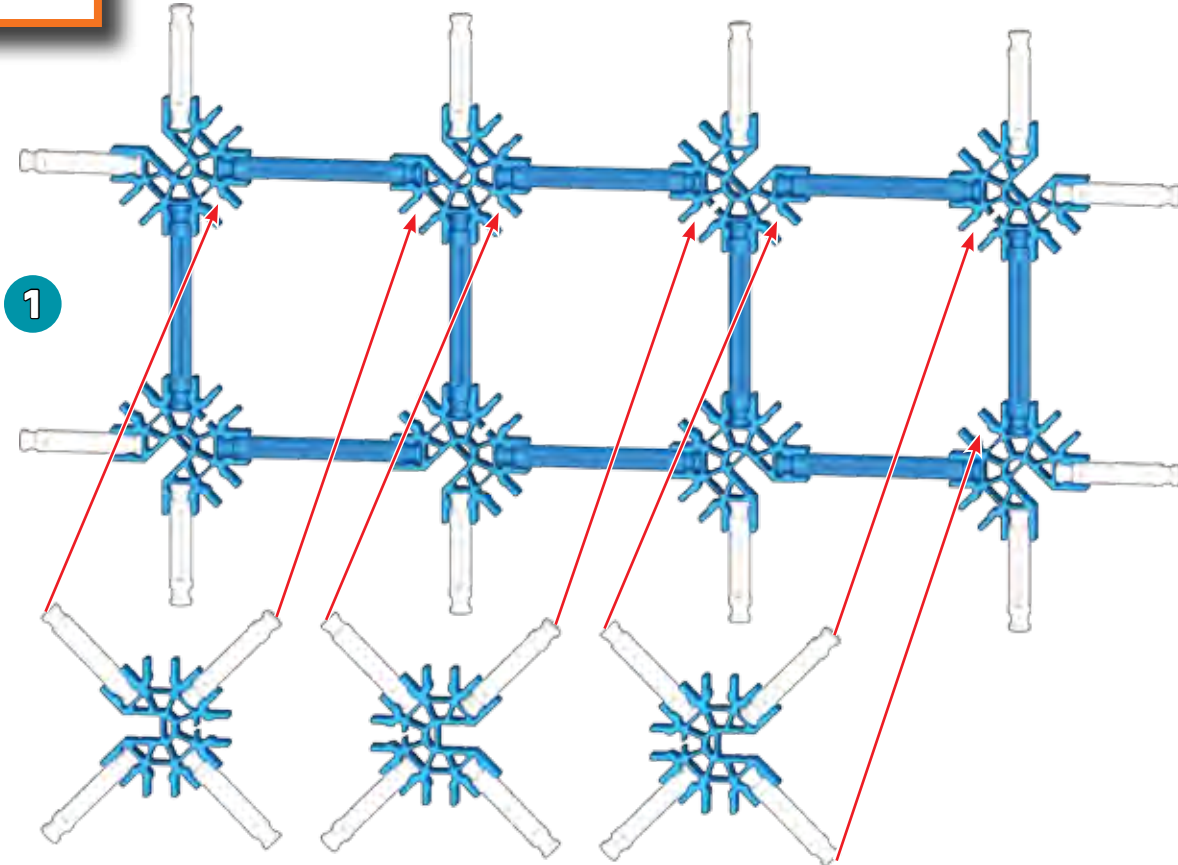

- 24
- 10
- 11

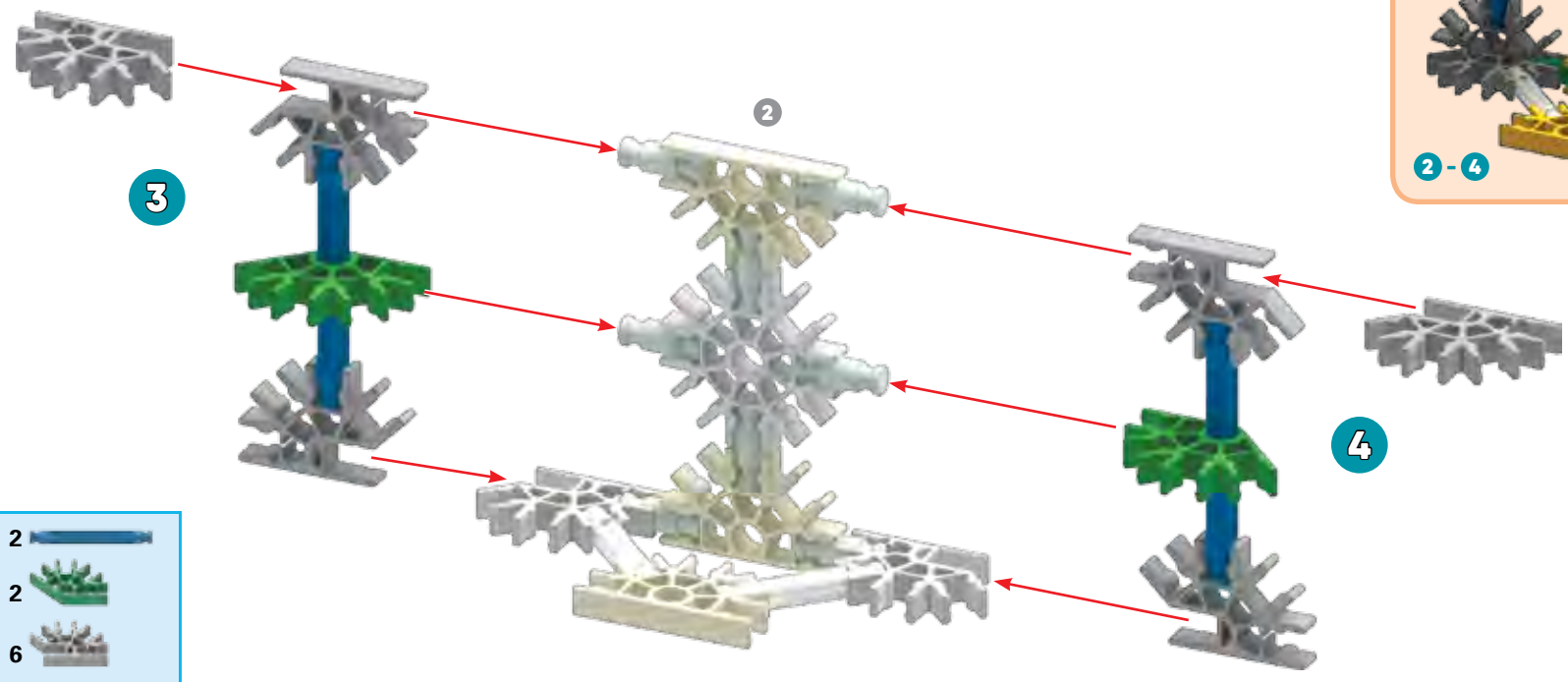
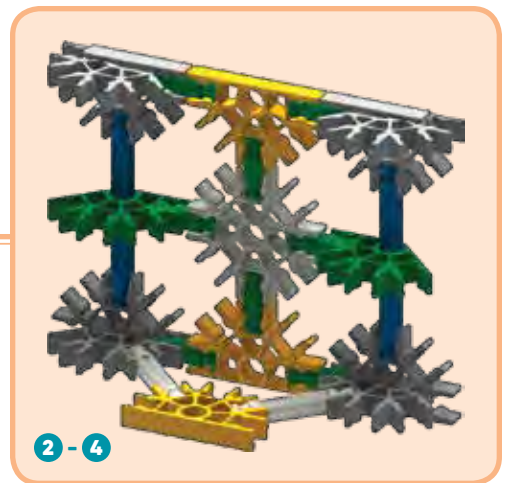
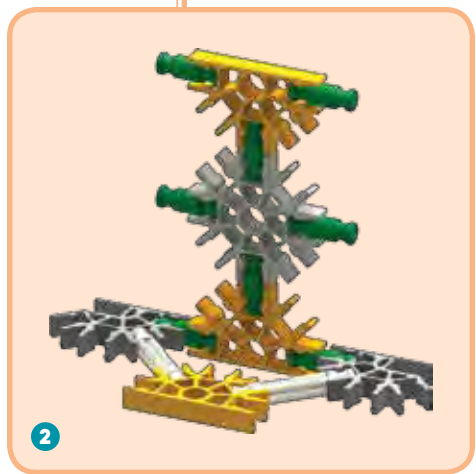
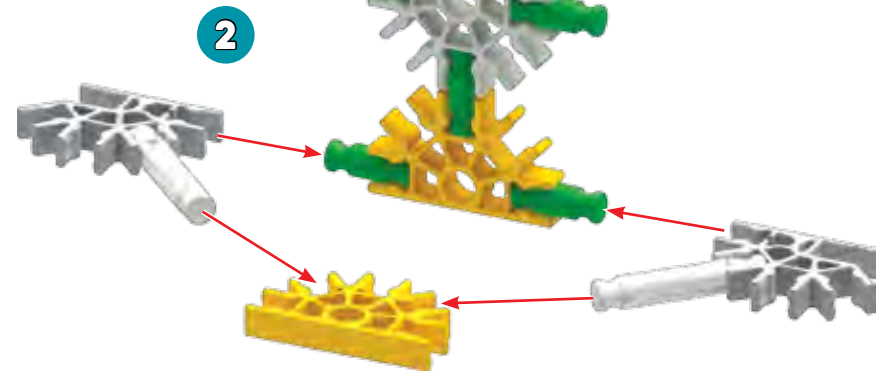

- 8 
- 2 
- 2 
- 3 
- 1 



- 2 
- 2 
- 6 

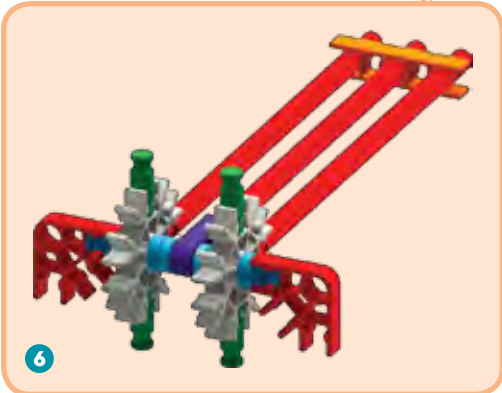
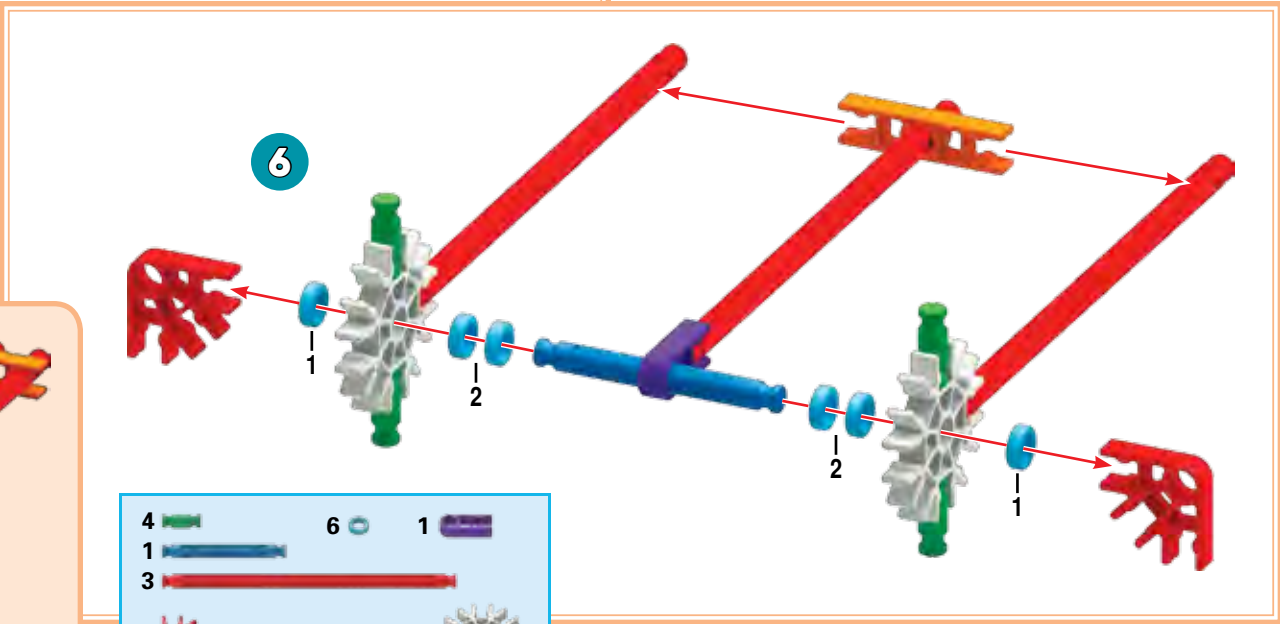
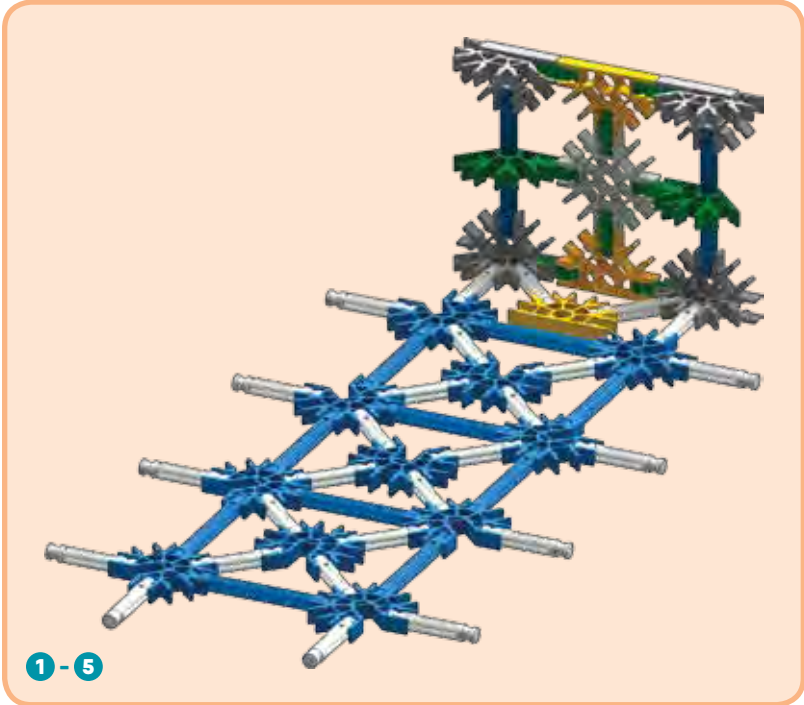
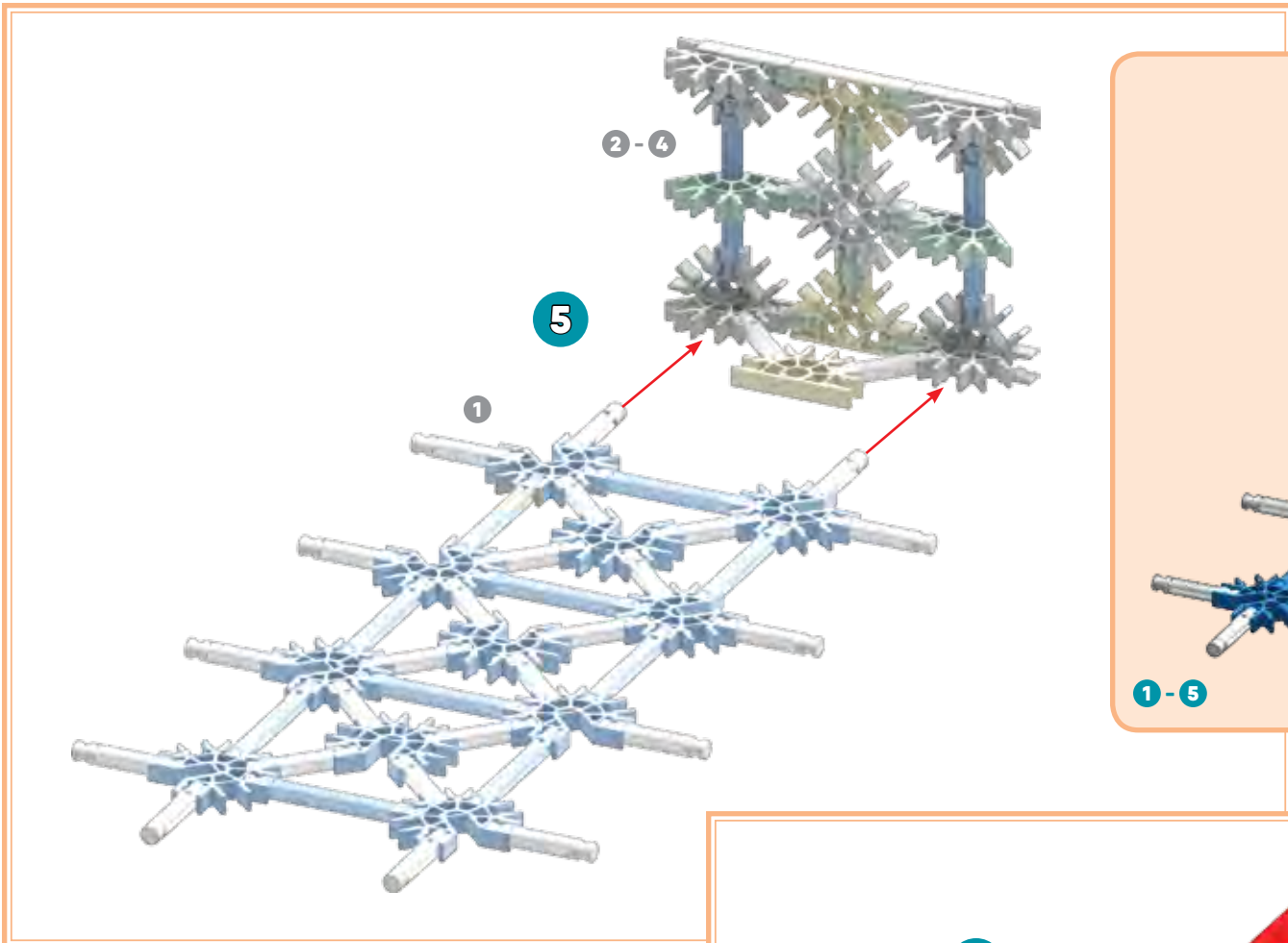

- | | | |
|---|---|---|
| 4 | 6 | 1 |
| 1 | | |
| 3 | | |
| 2 | 1 | 2 |

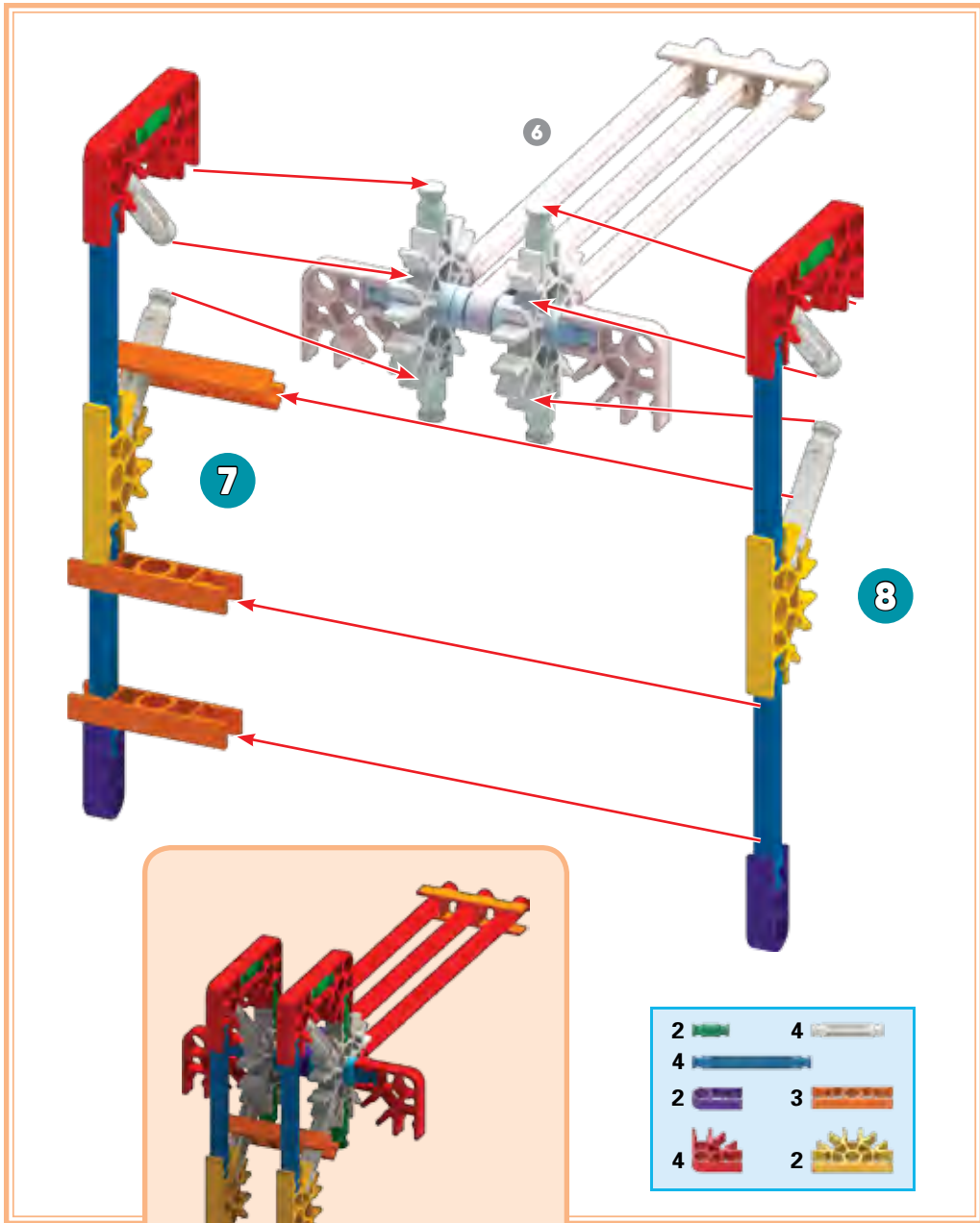

- | | | | |
|---|--|---|--|
| 2 | | 4 | |
| 4 | | 3 | |
| 2 | | 2 | |
| 4 | | | |

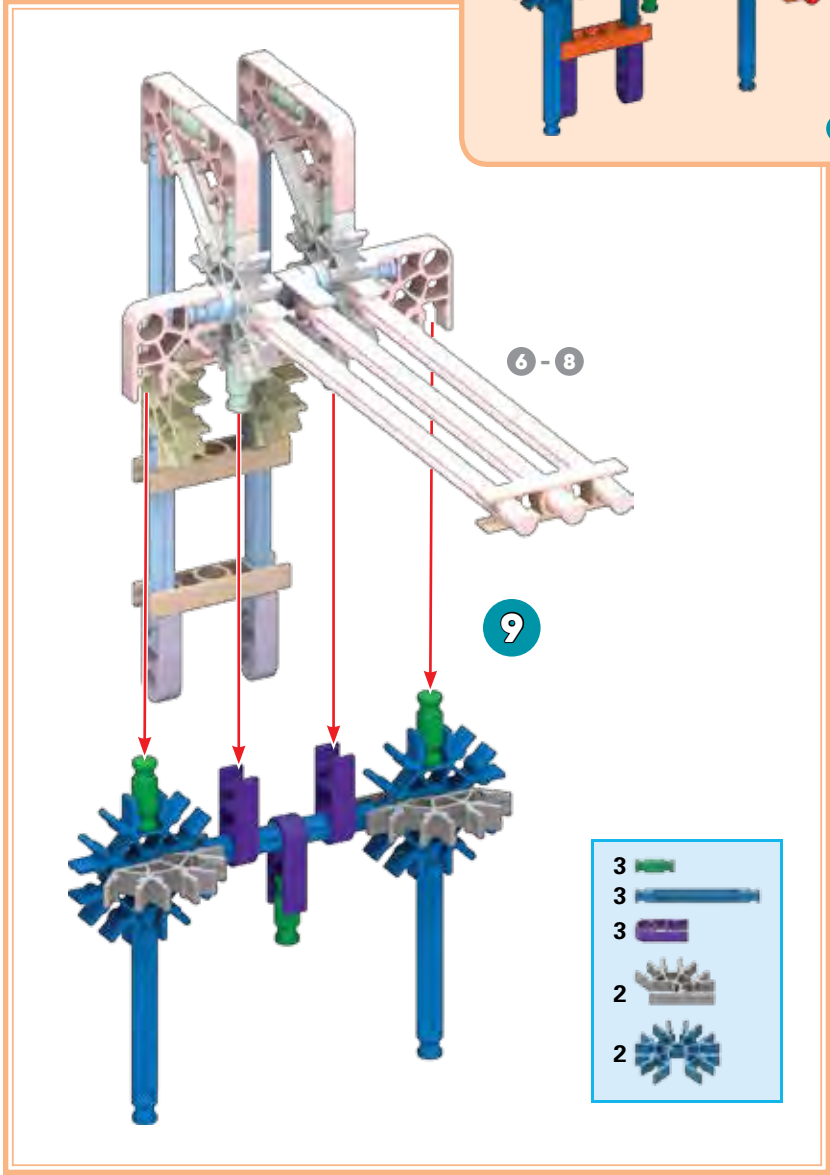

- | | |
|---|--|
| 3 | |
| 3 | |
| 3 | |
| 2 | |
| 2 | |

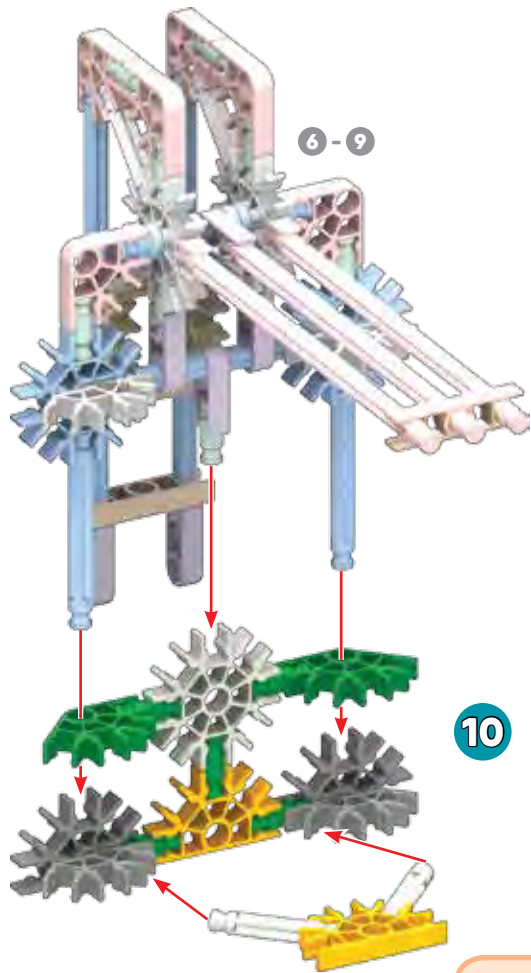

10

5	2
4	2
2	1

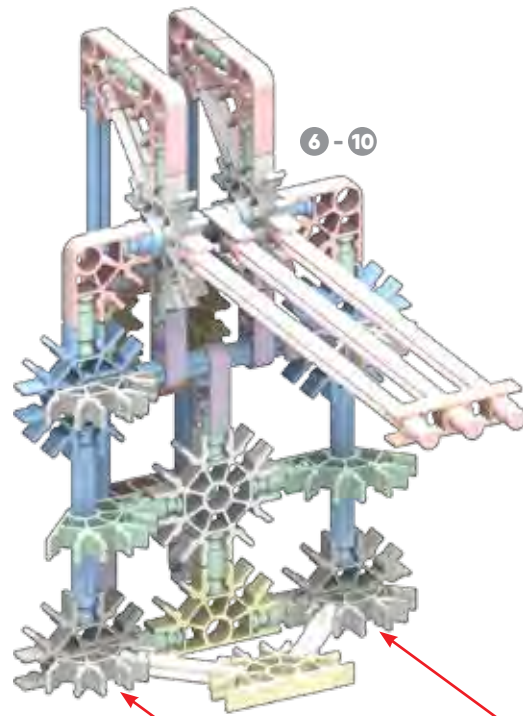

6-10

11

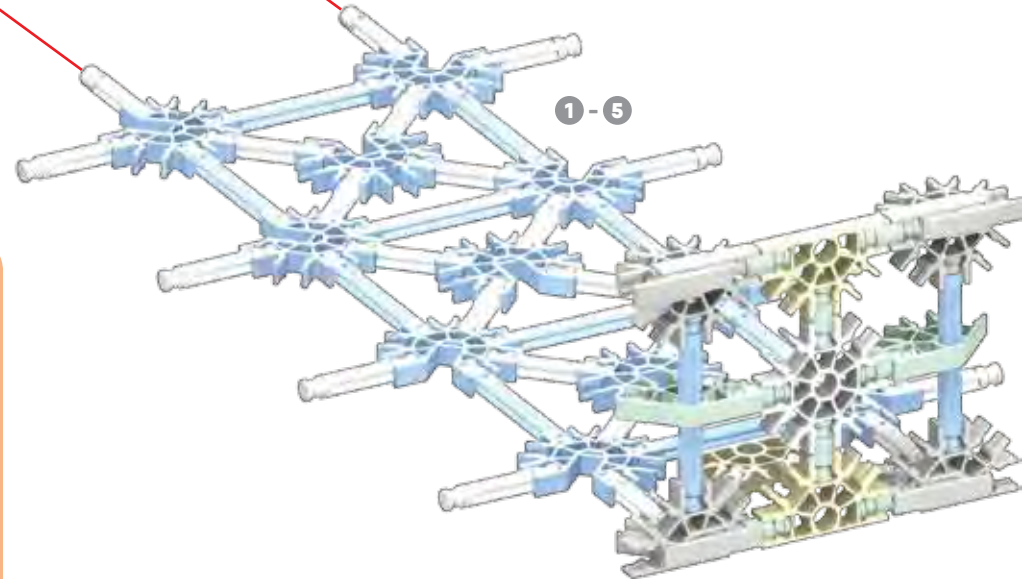

1-5

1-11



6-10

x2

12



20		4	
4		6	
8		4	

x2

12

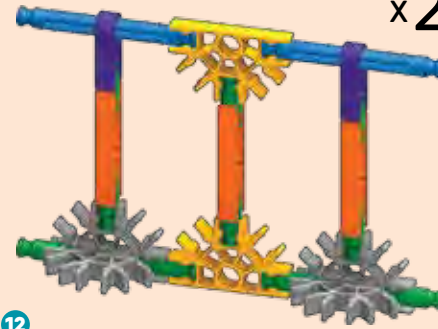

x2

13

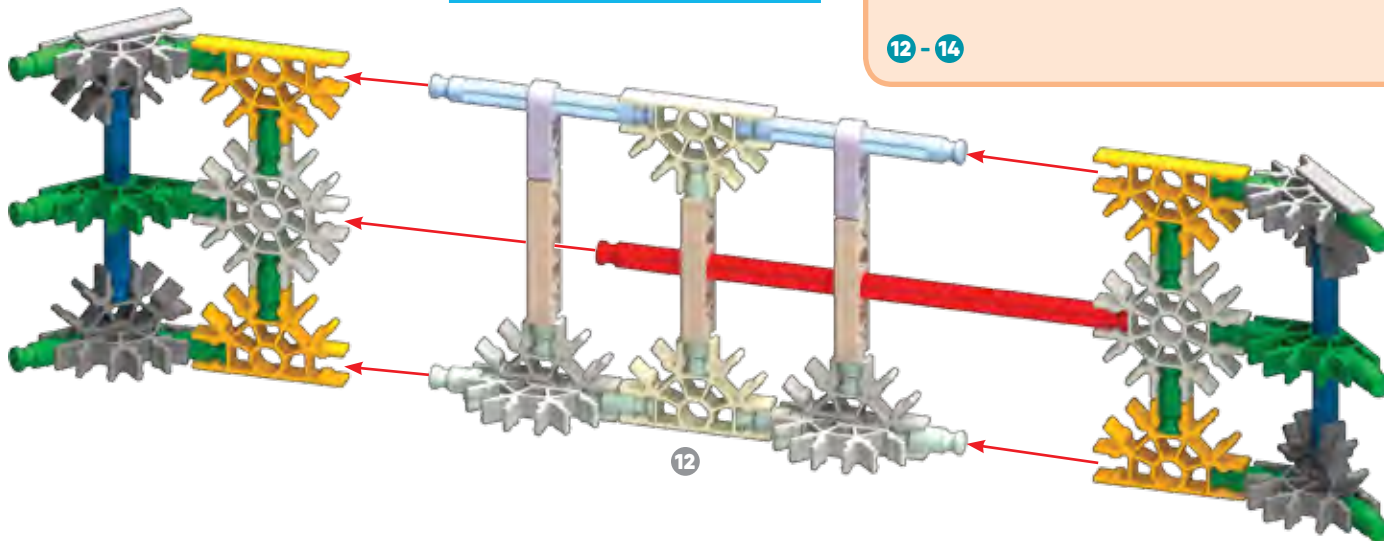

32		8	
4			
2			
16		4	
4			

12

x2

12-14

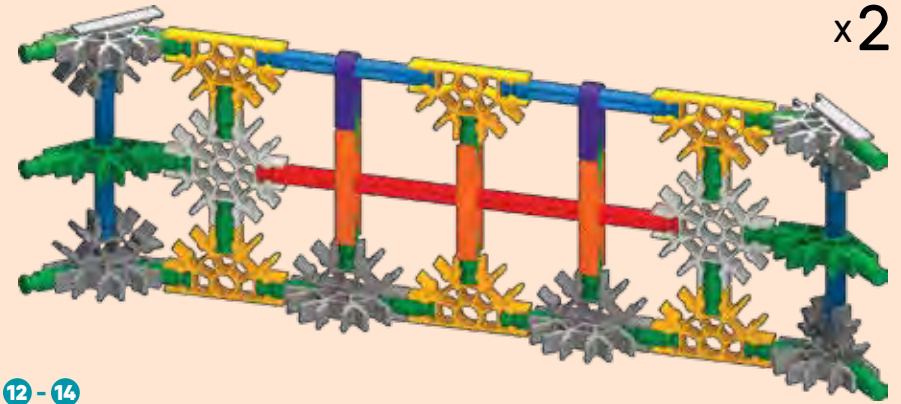

14

x2

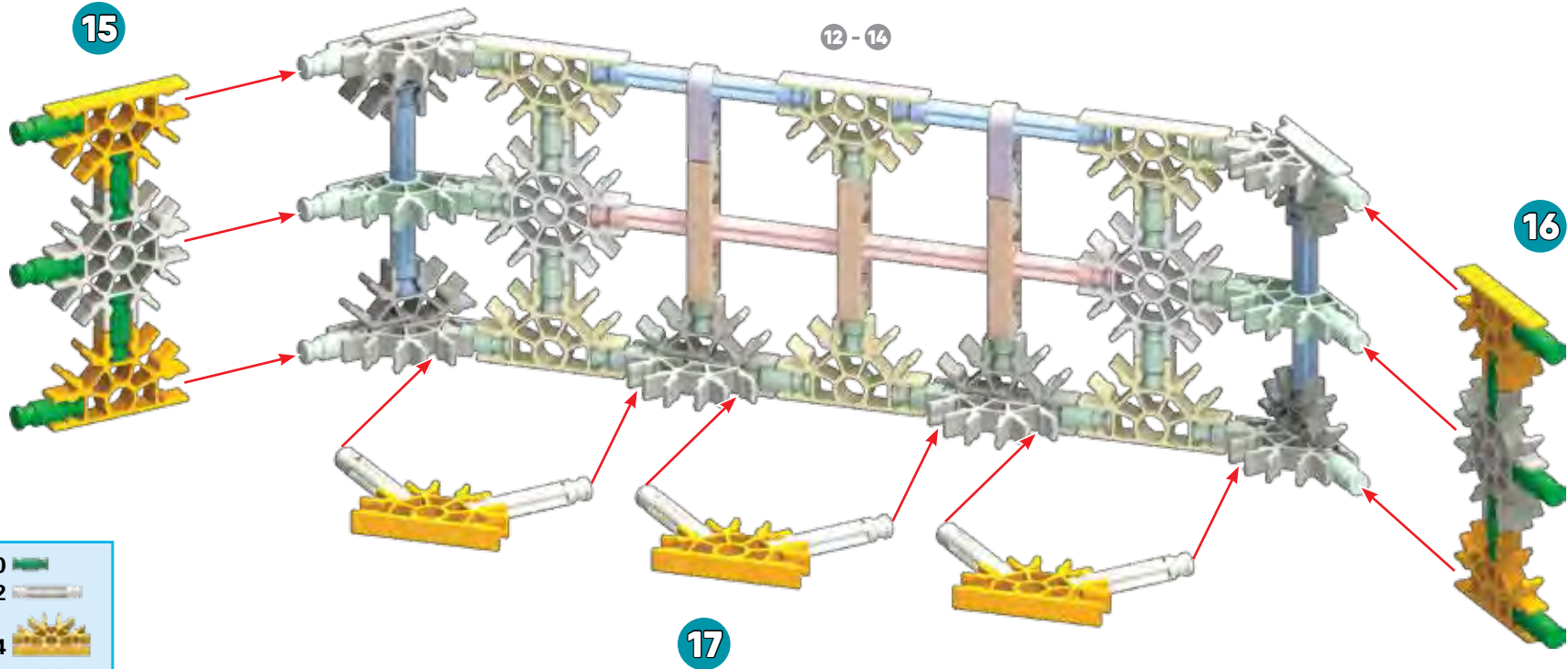

- 20
- 12
- 14
- 4

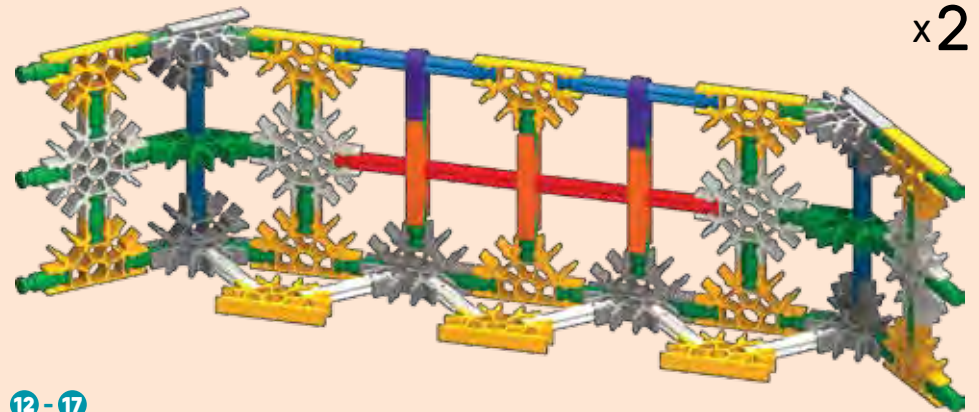

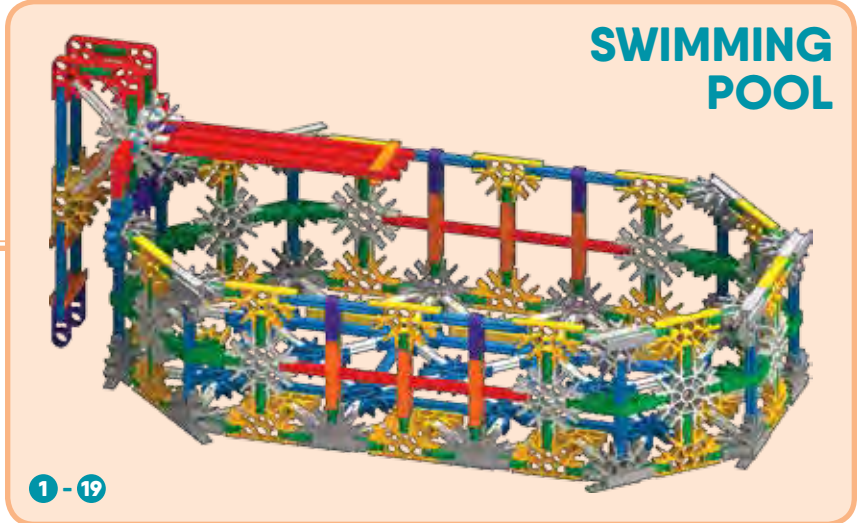
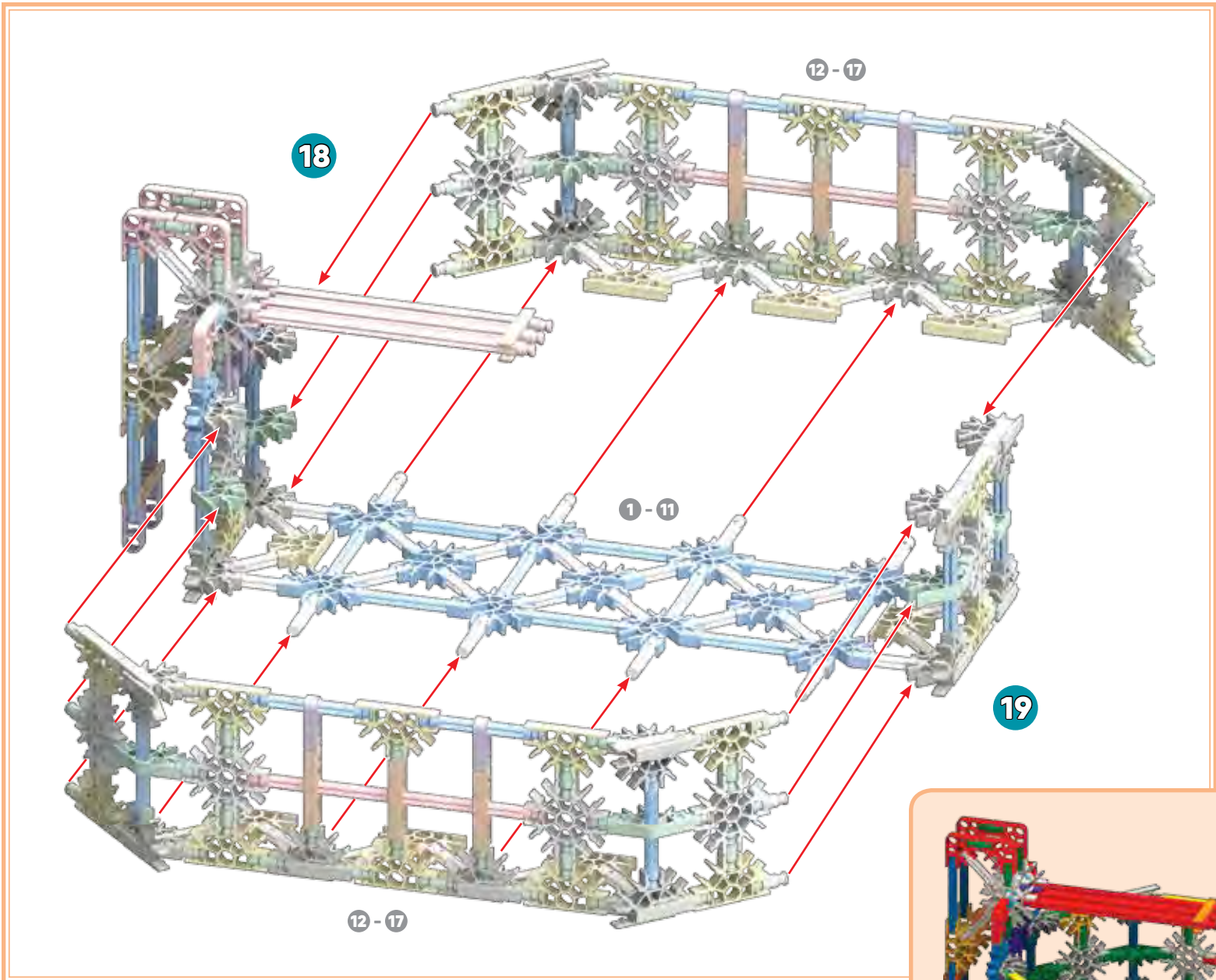
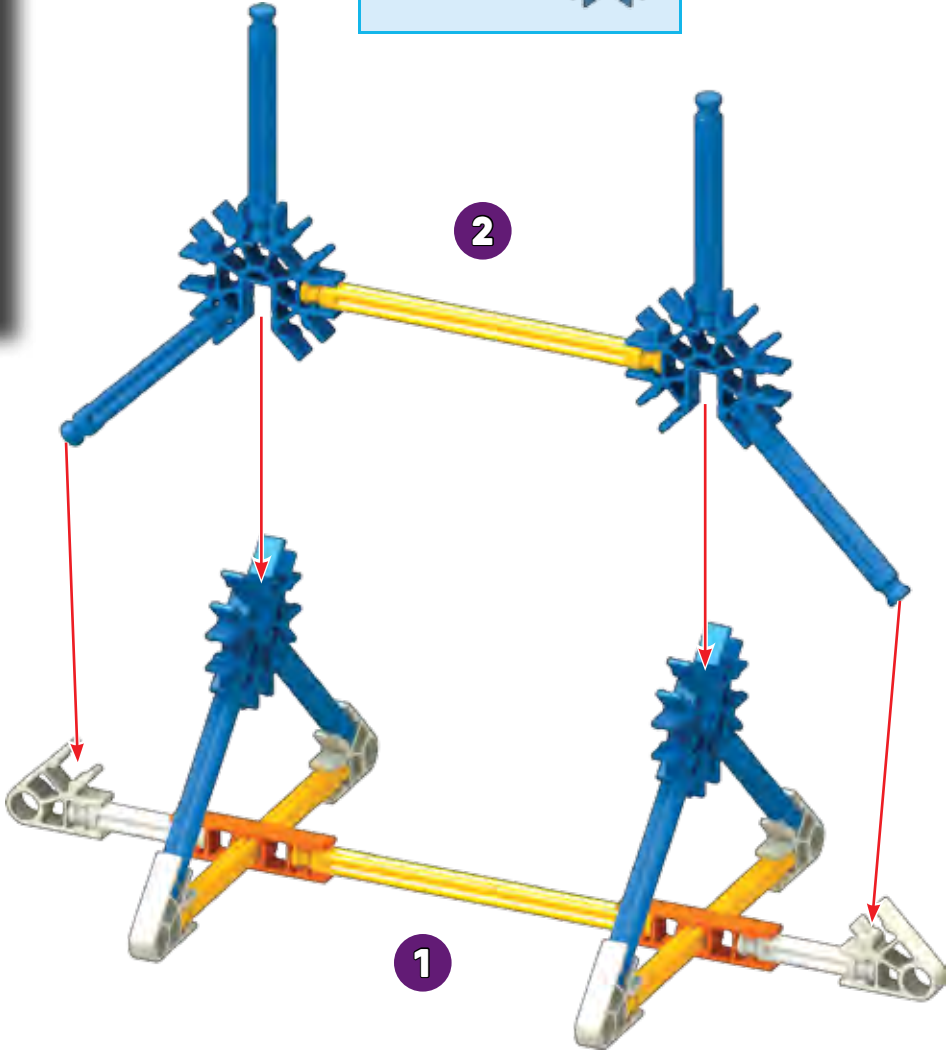
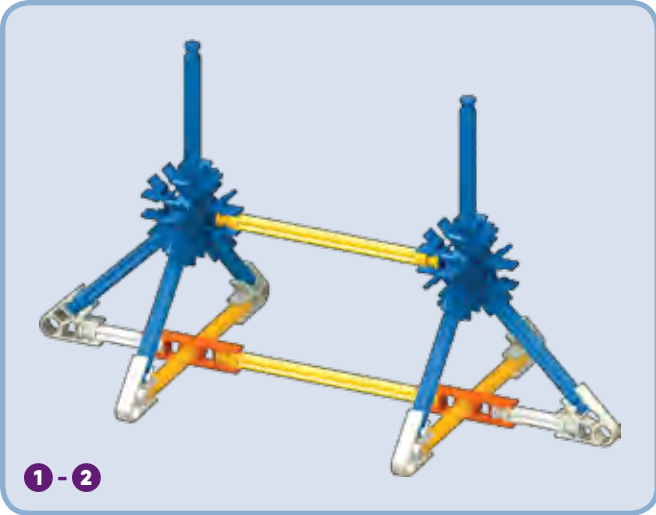
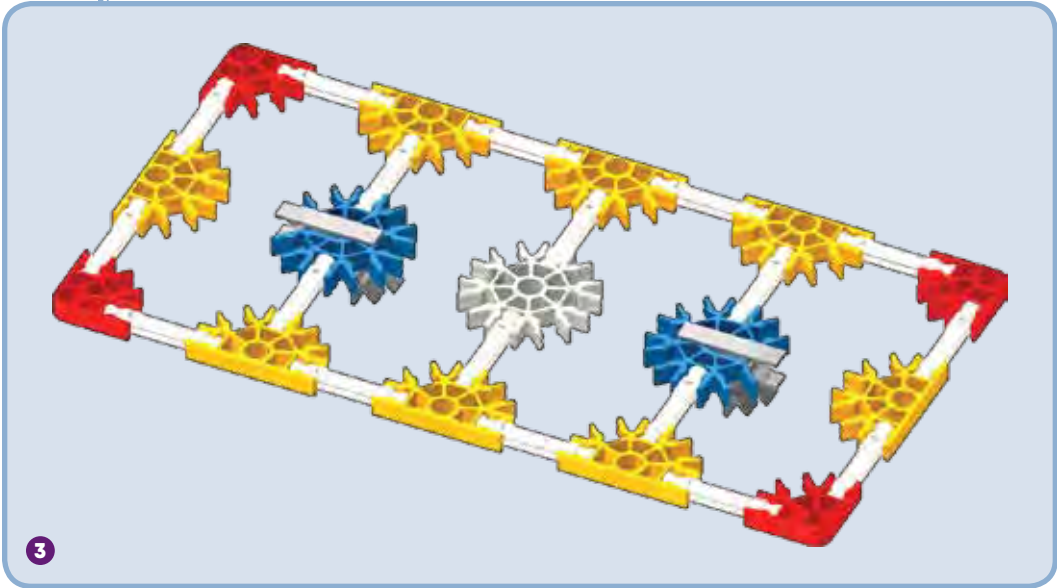
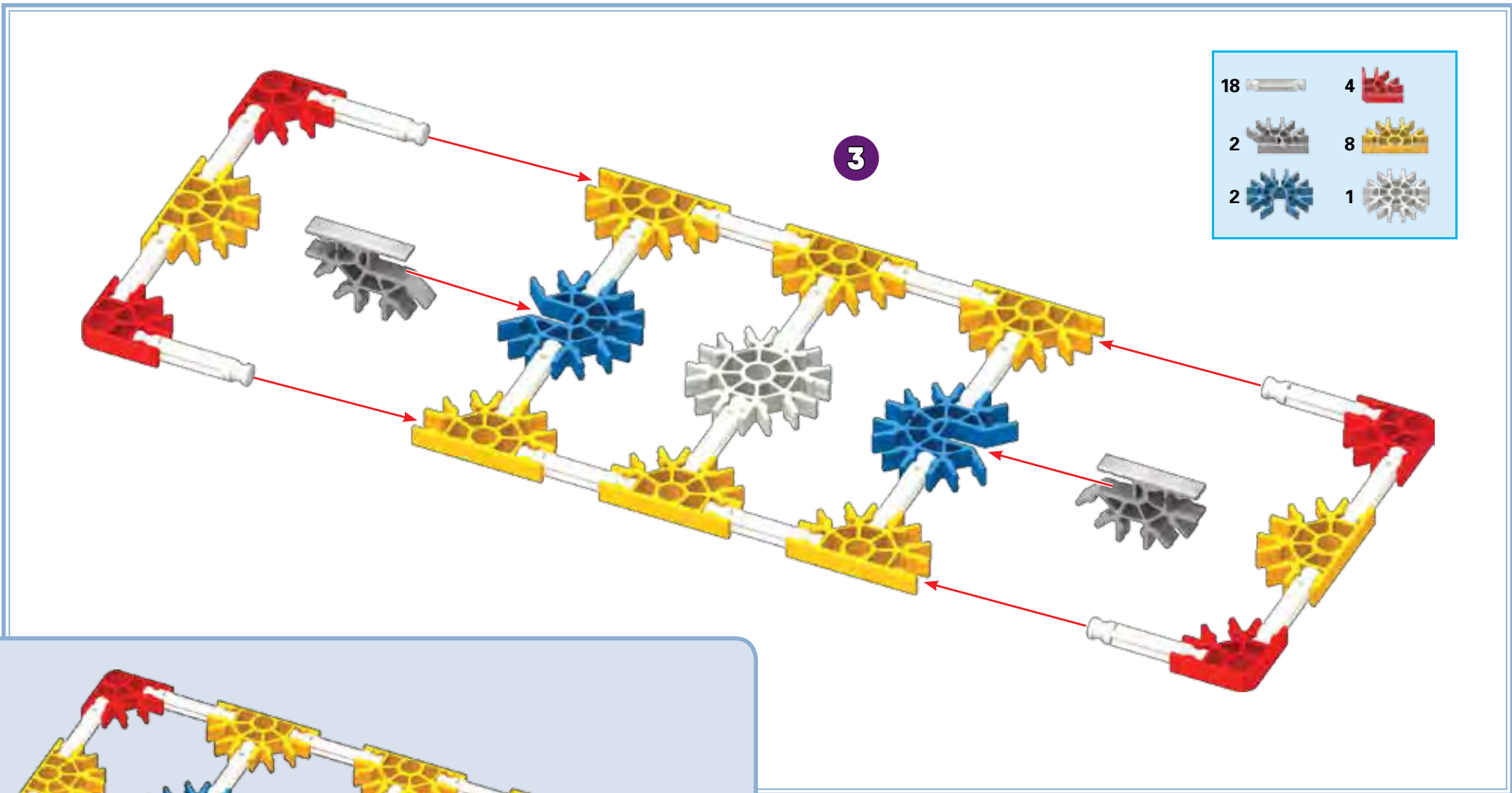

TABLE & CHAIRS



- 2
- 8
- 4
- 2
- 6
- 4





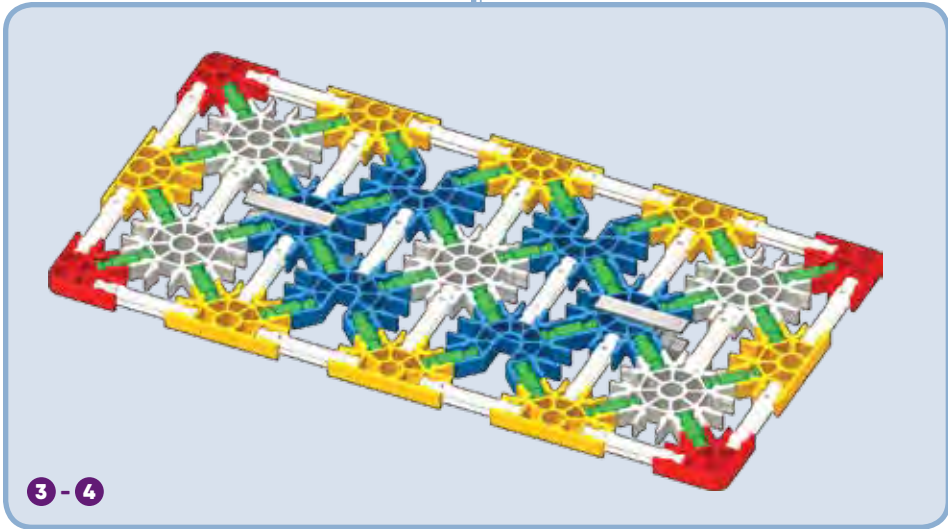
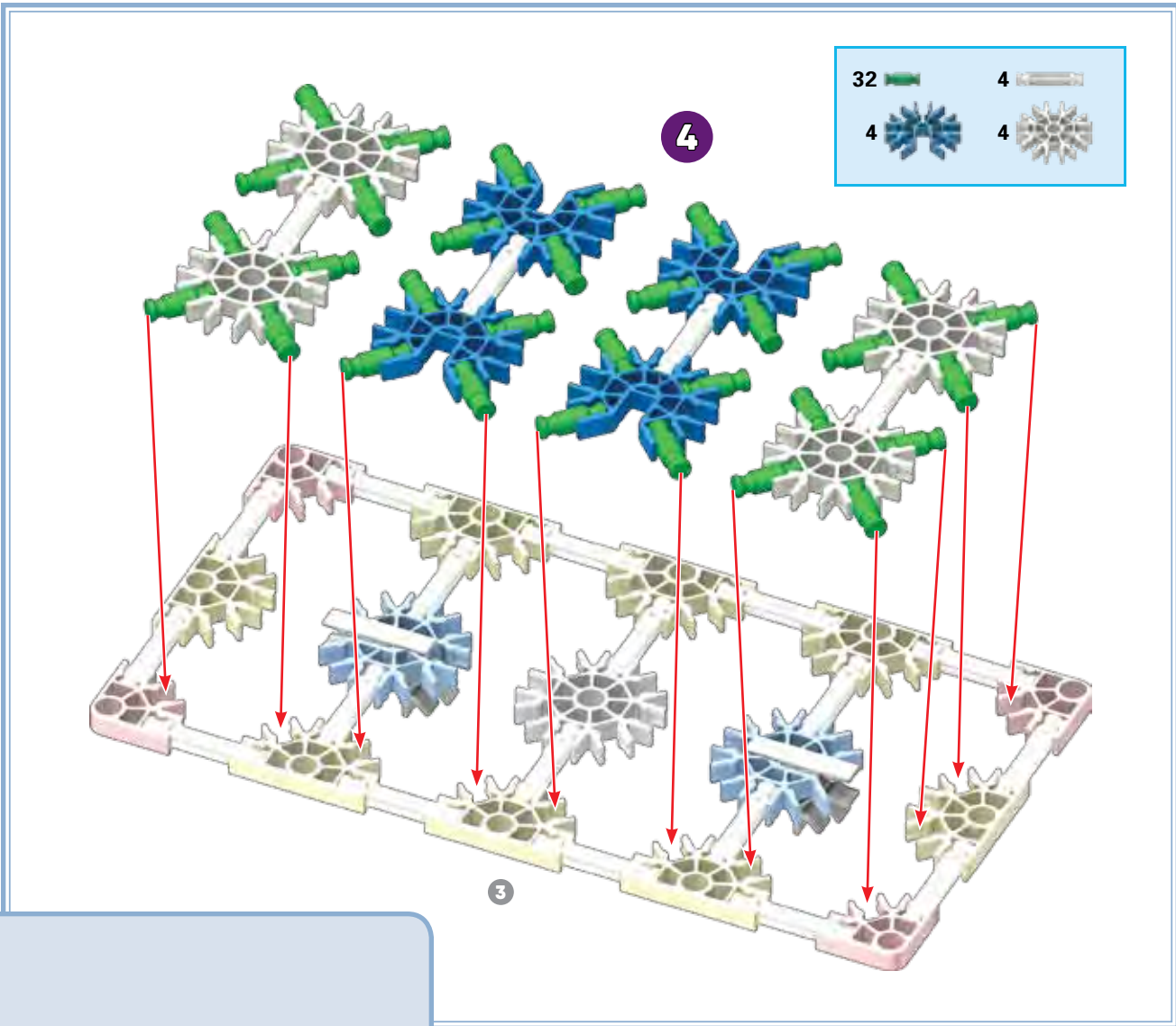

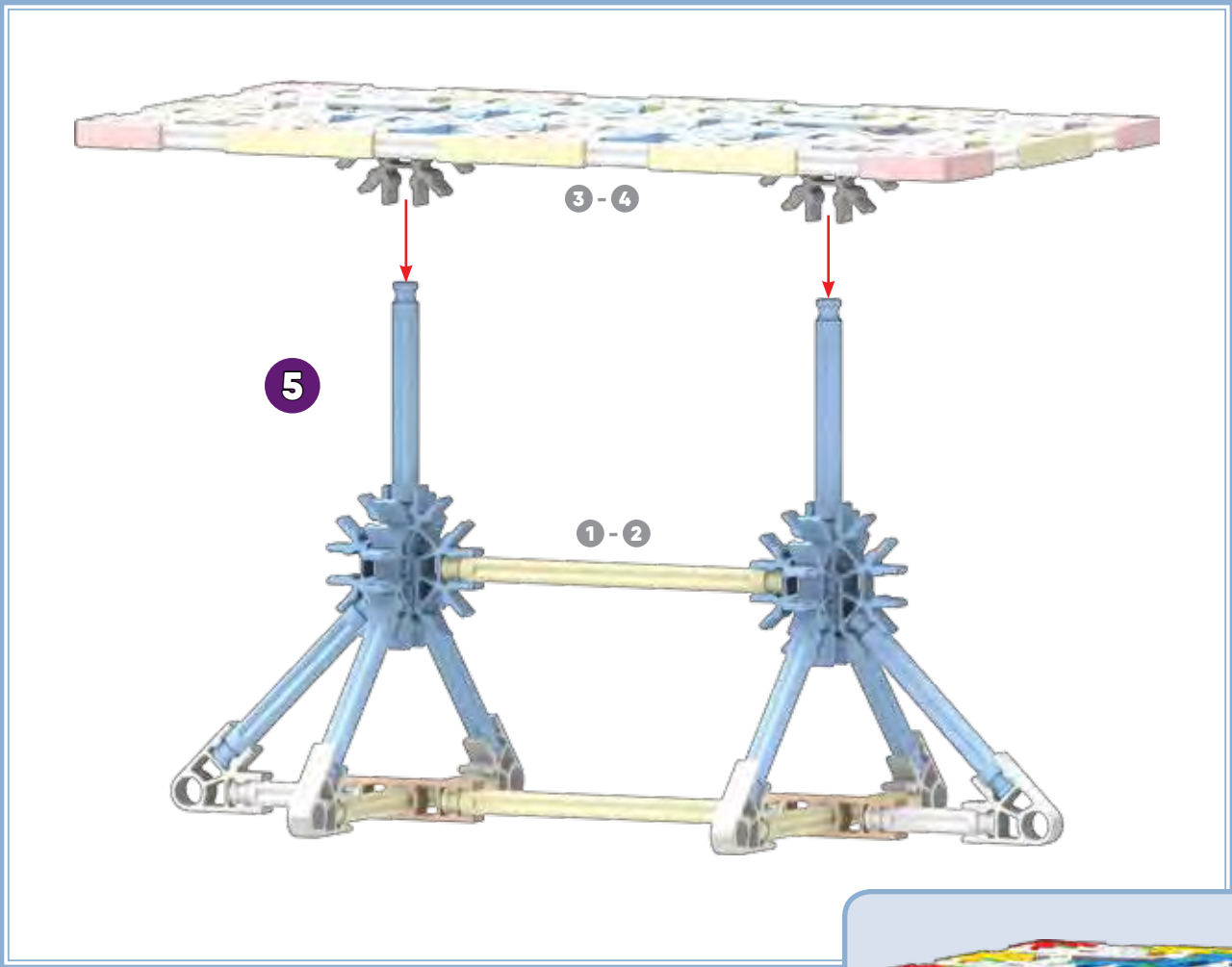

x2

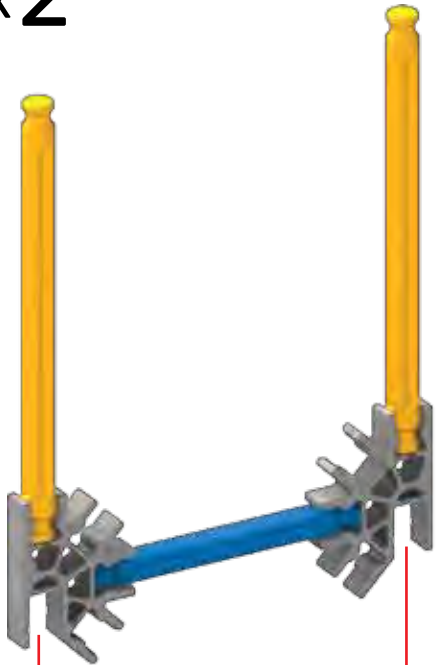

- 12
- 6
- 4
- 8
- 4

6

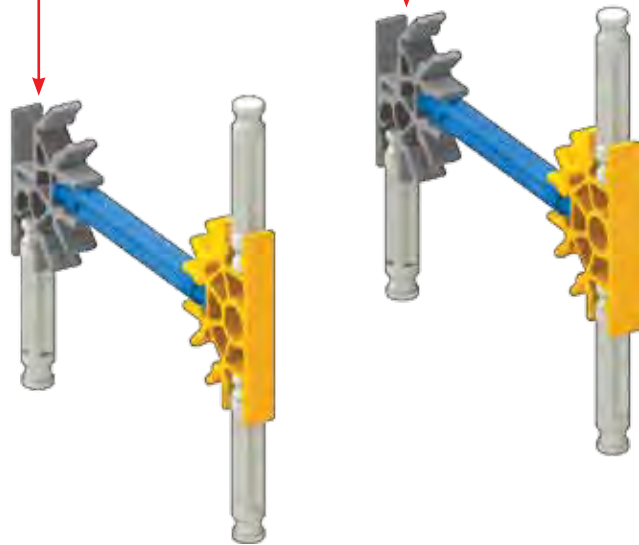

x2

- 8
- 4
- 2
- 4
- 4
- 8
- 2
- 2

7

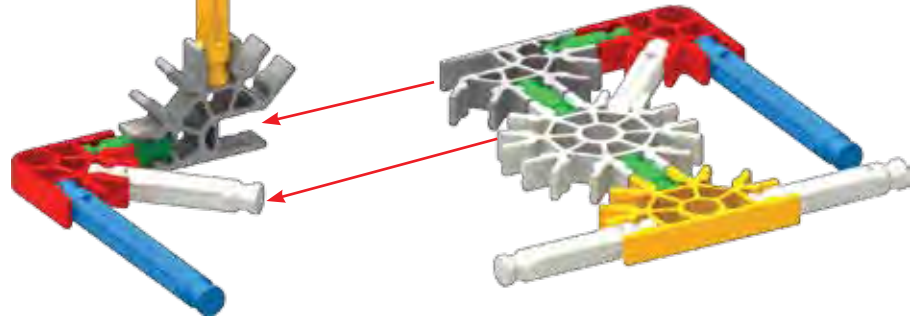

x2

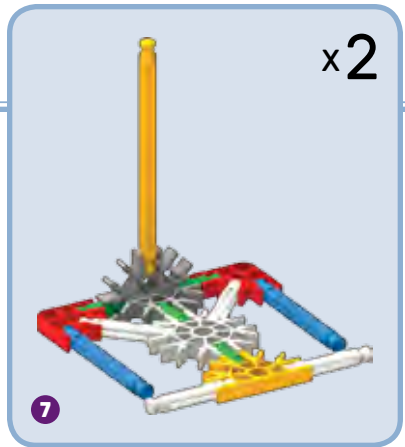

7

x2

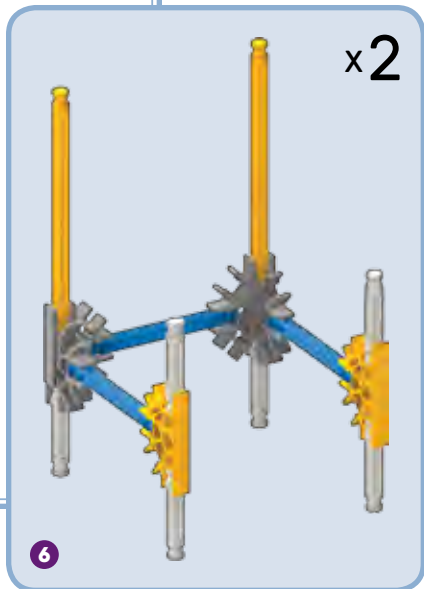

6

x2

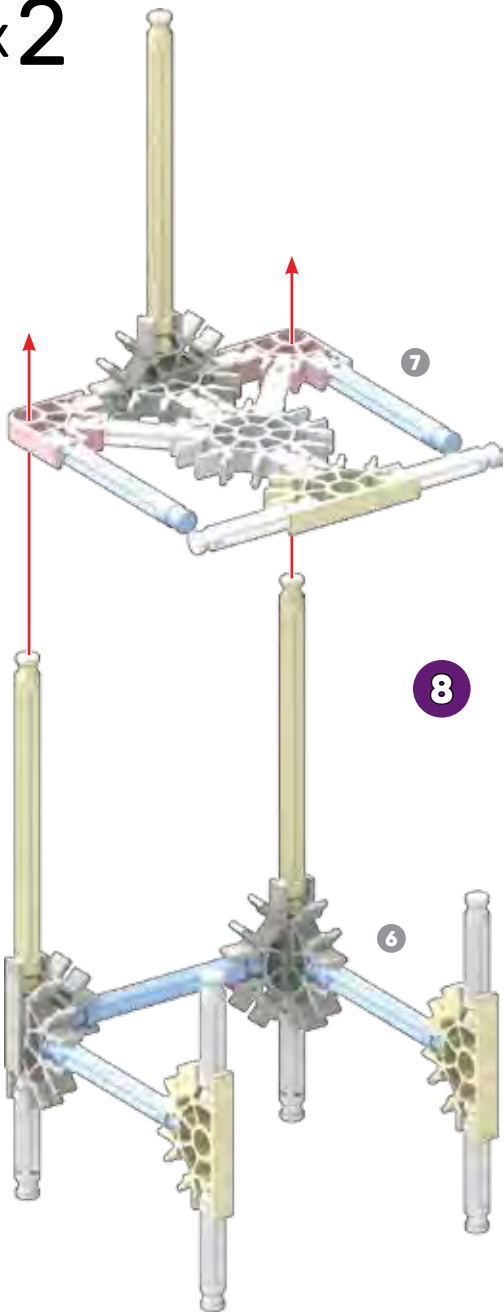

x2

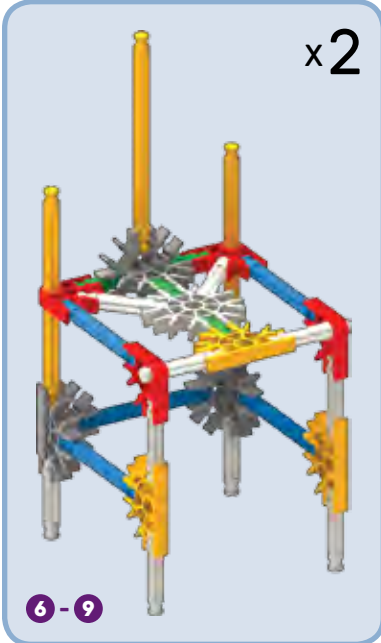
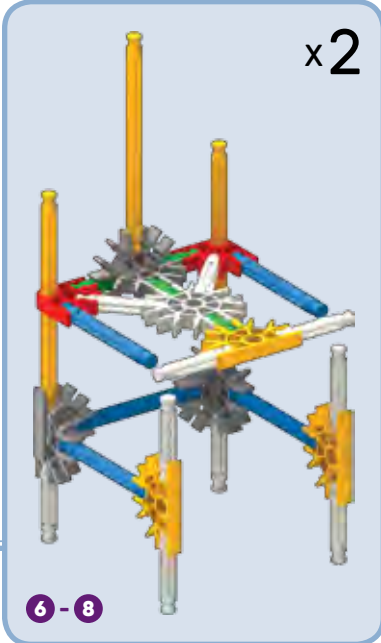
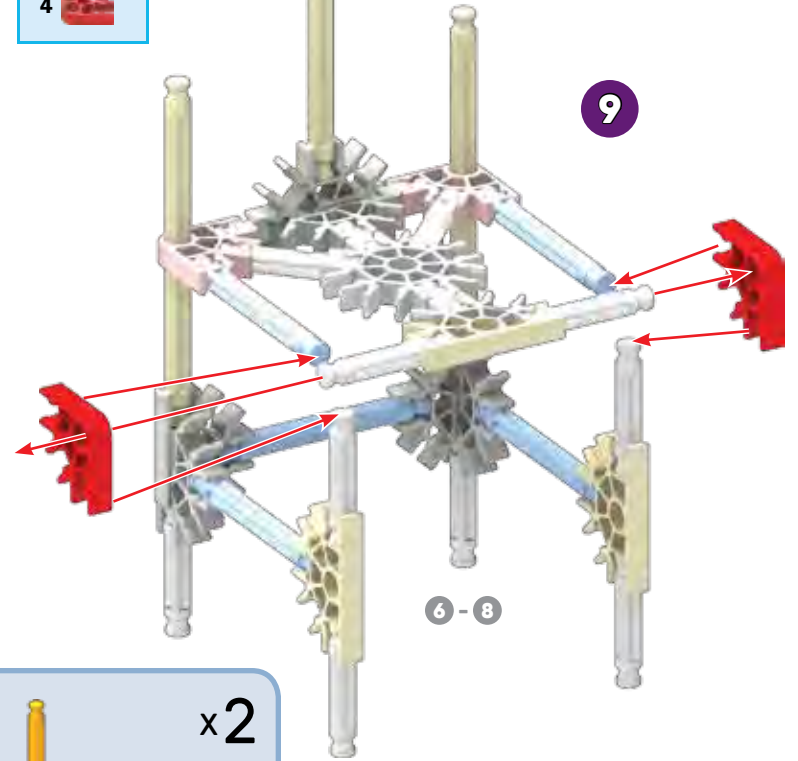
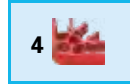

x2

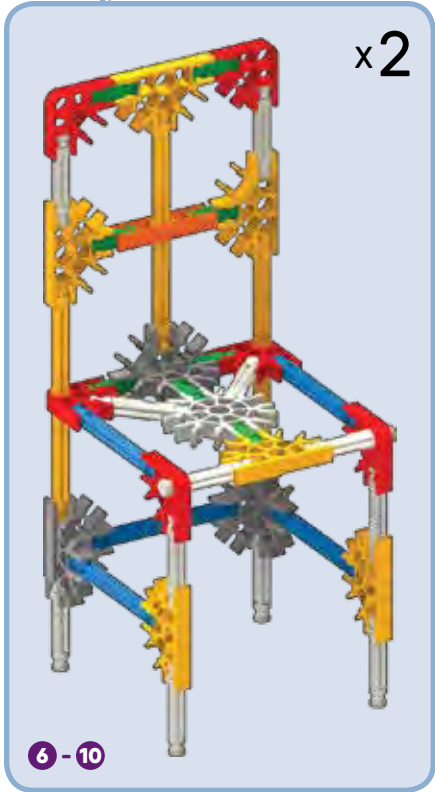
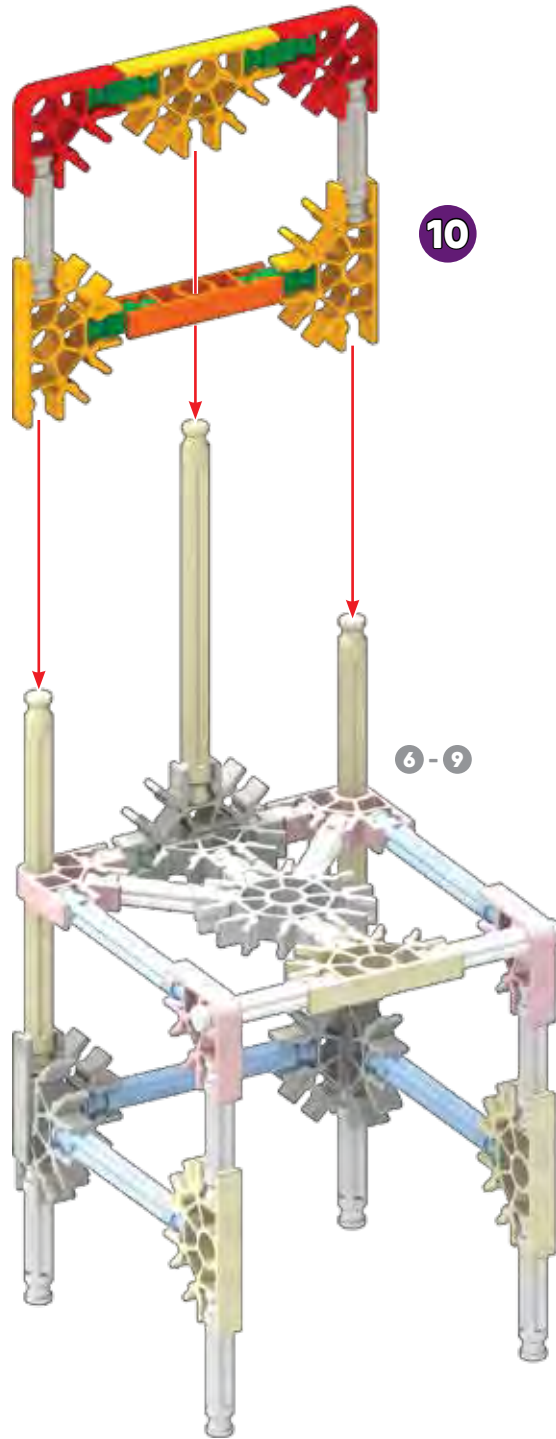

TEAPOT

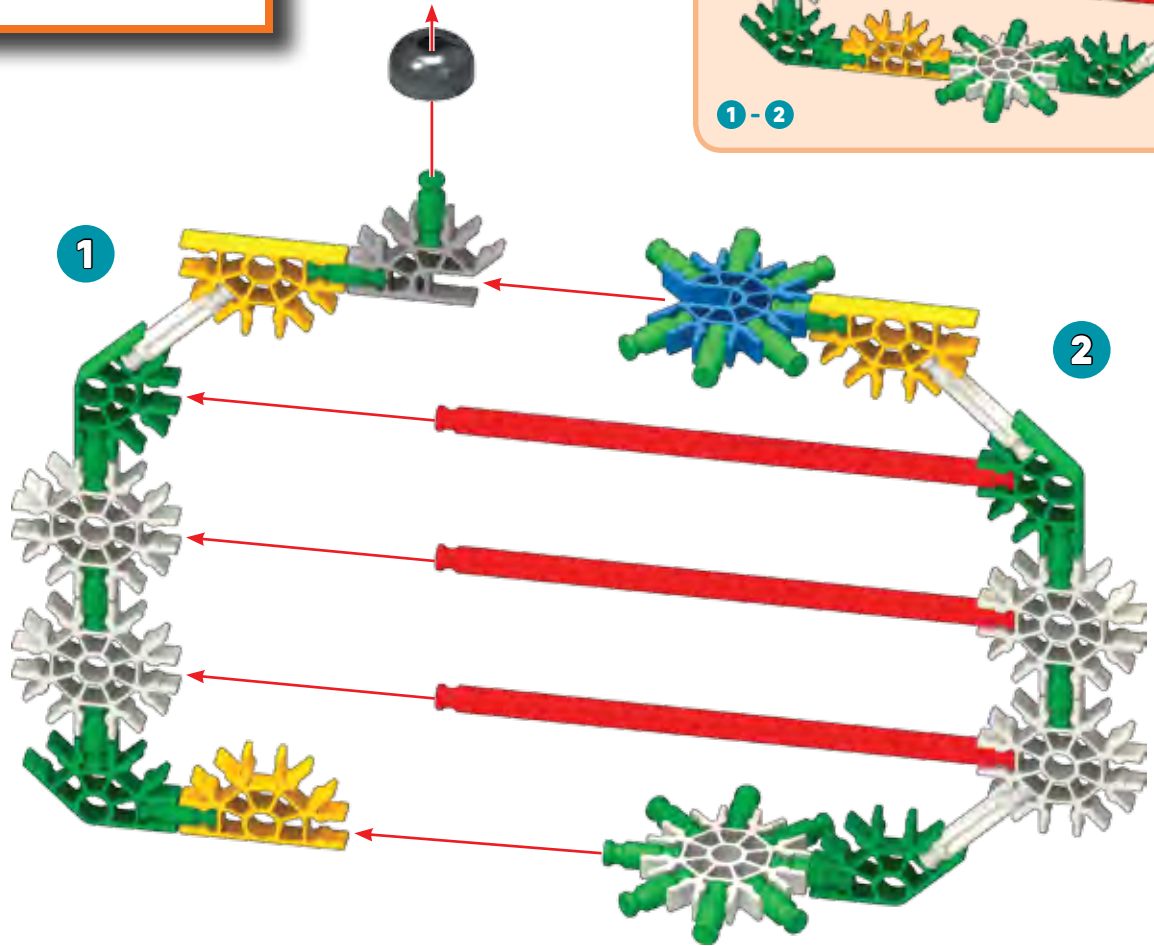
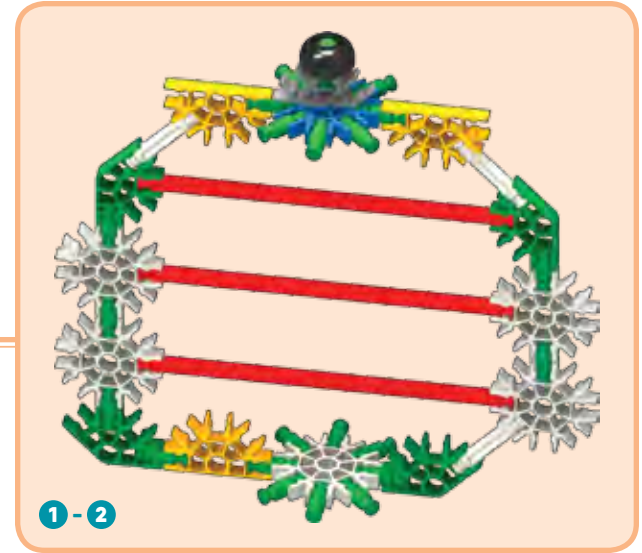
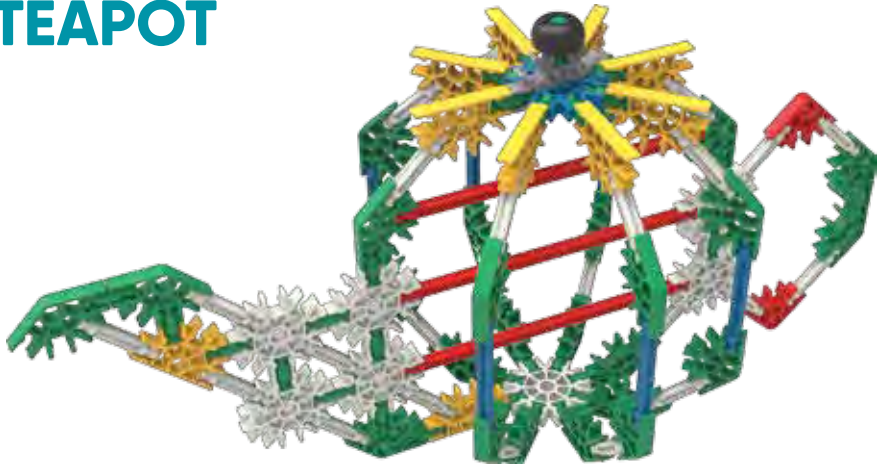

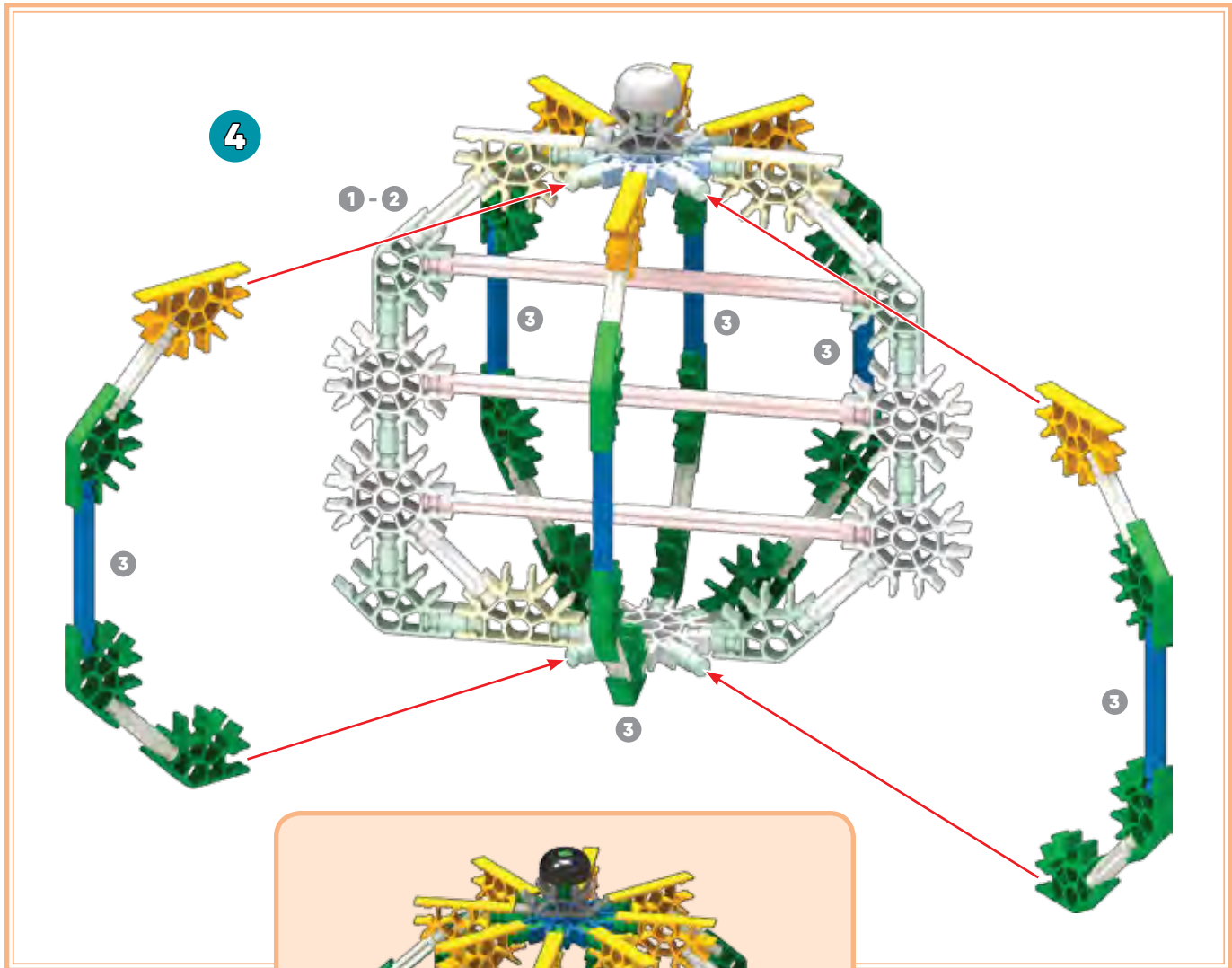
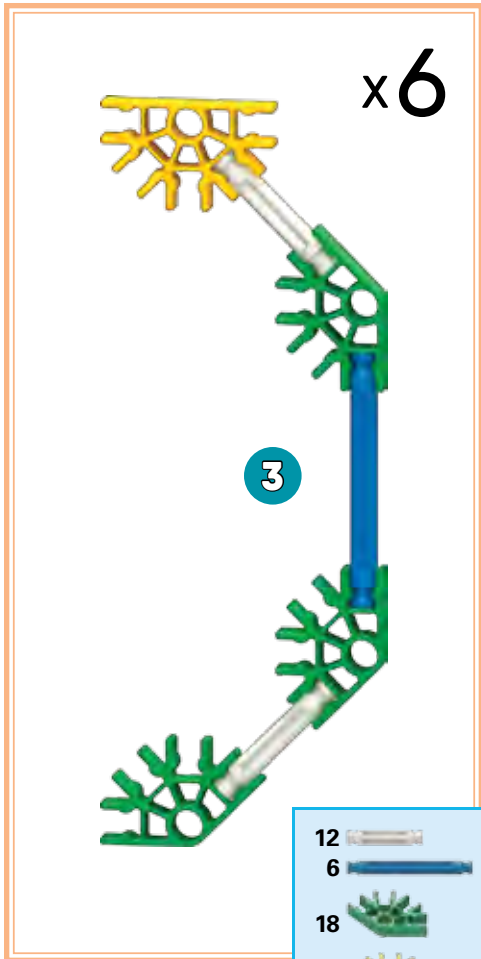

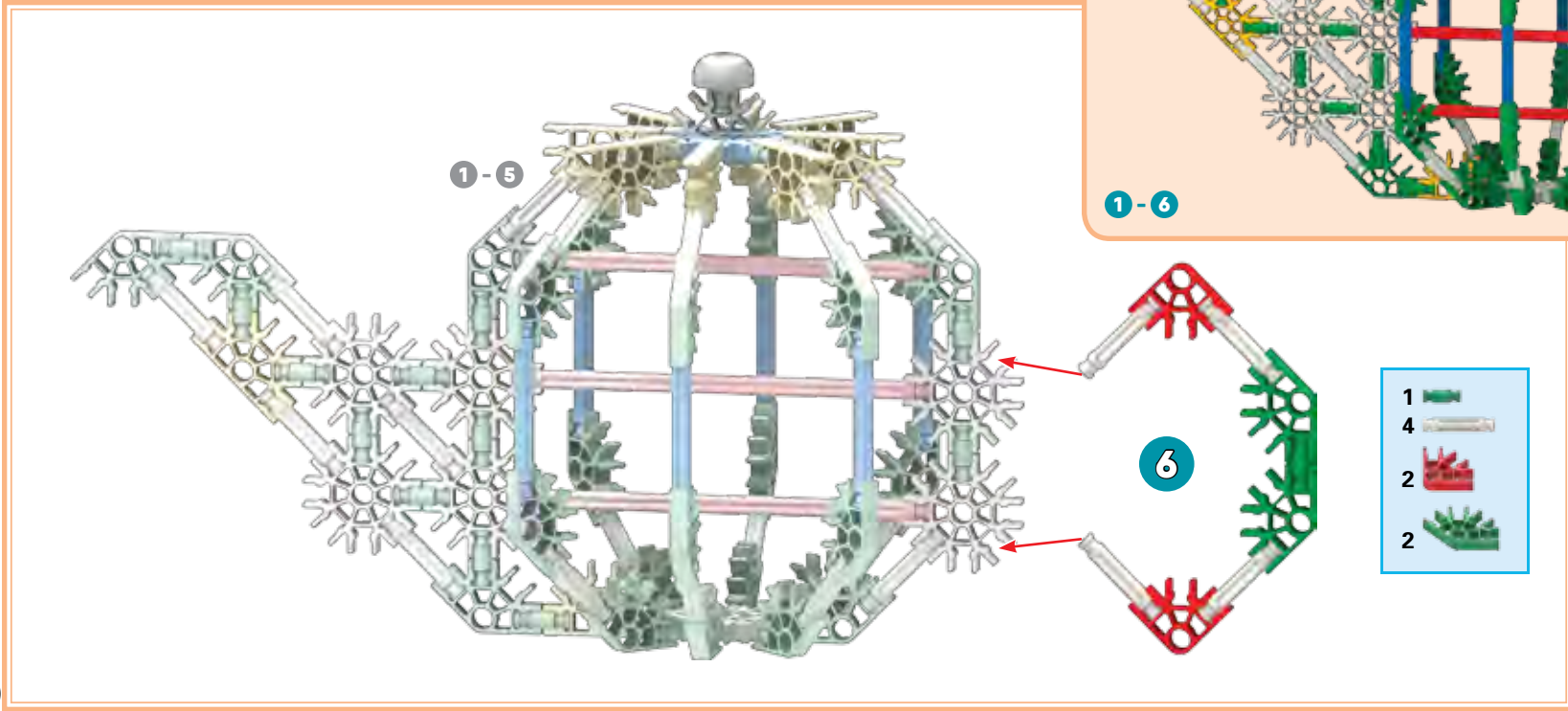
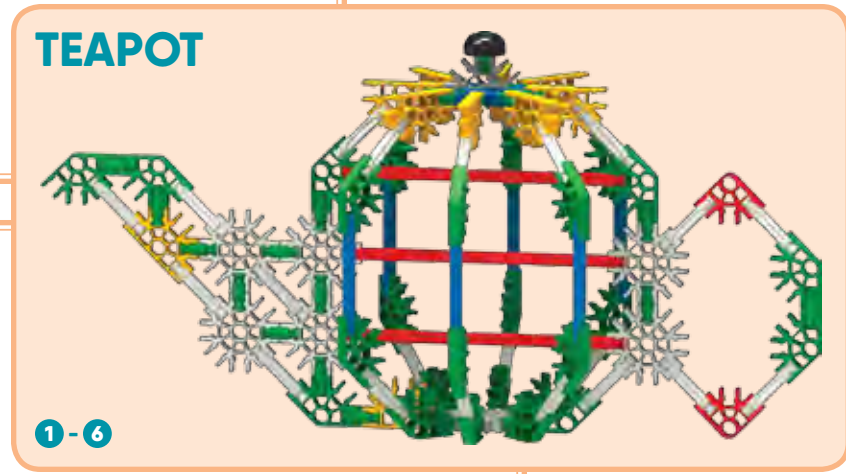
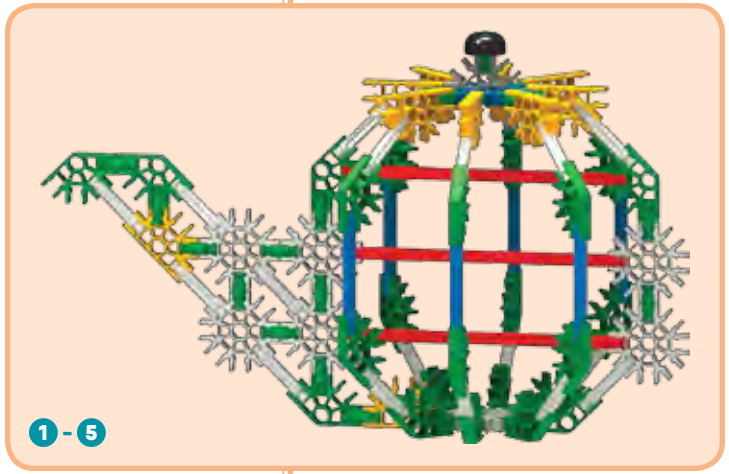
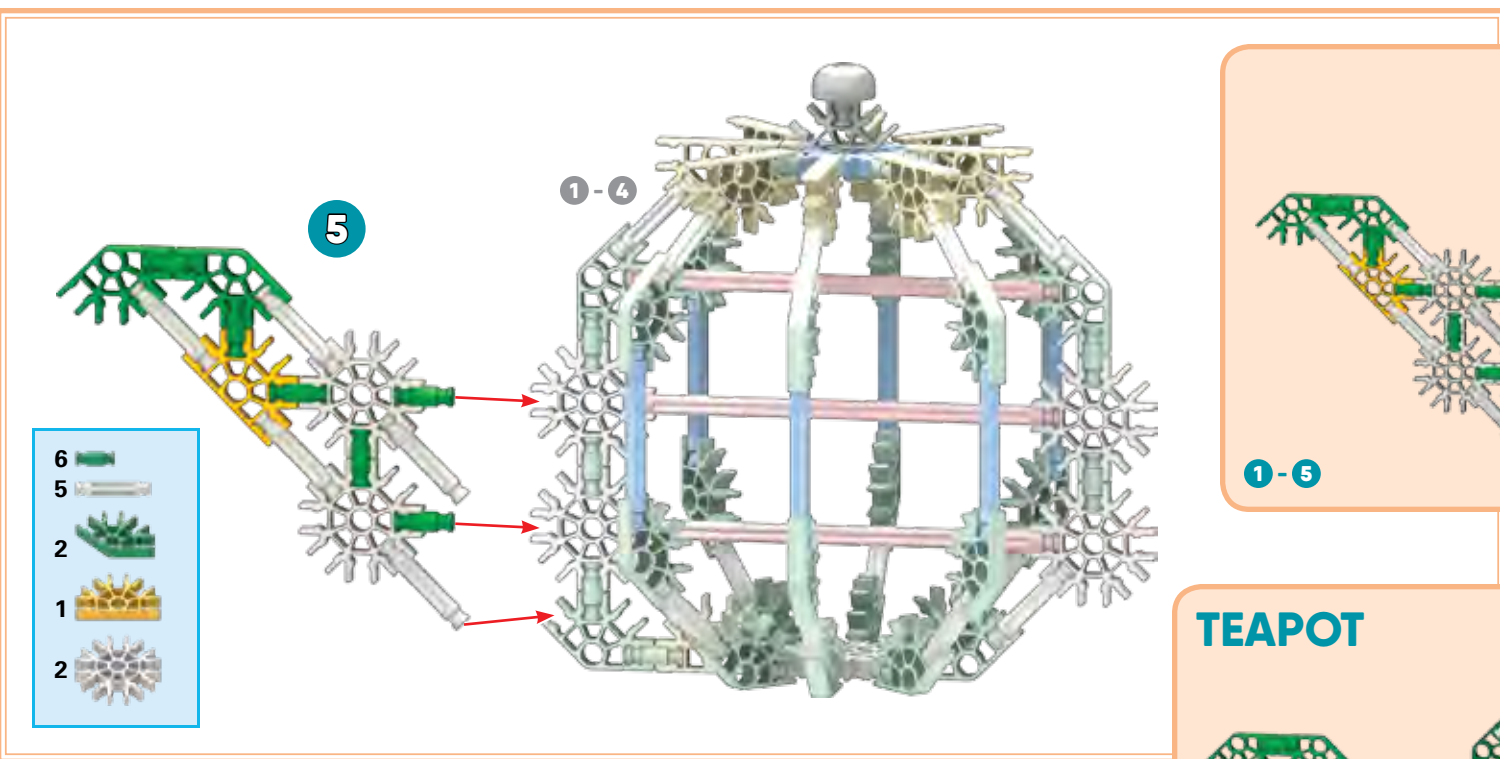

TOW TRUCK

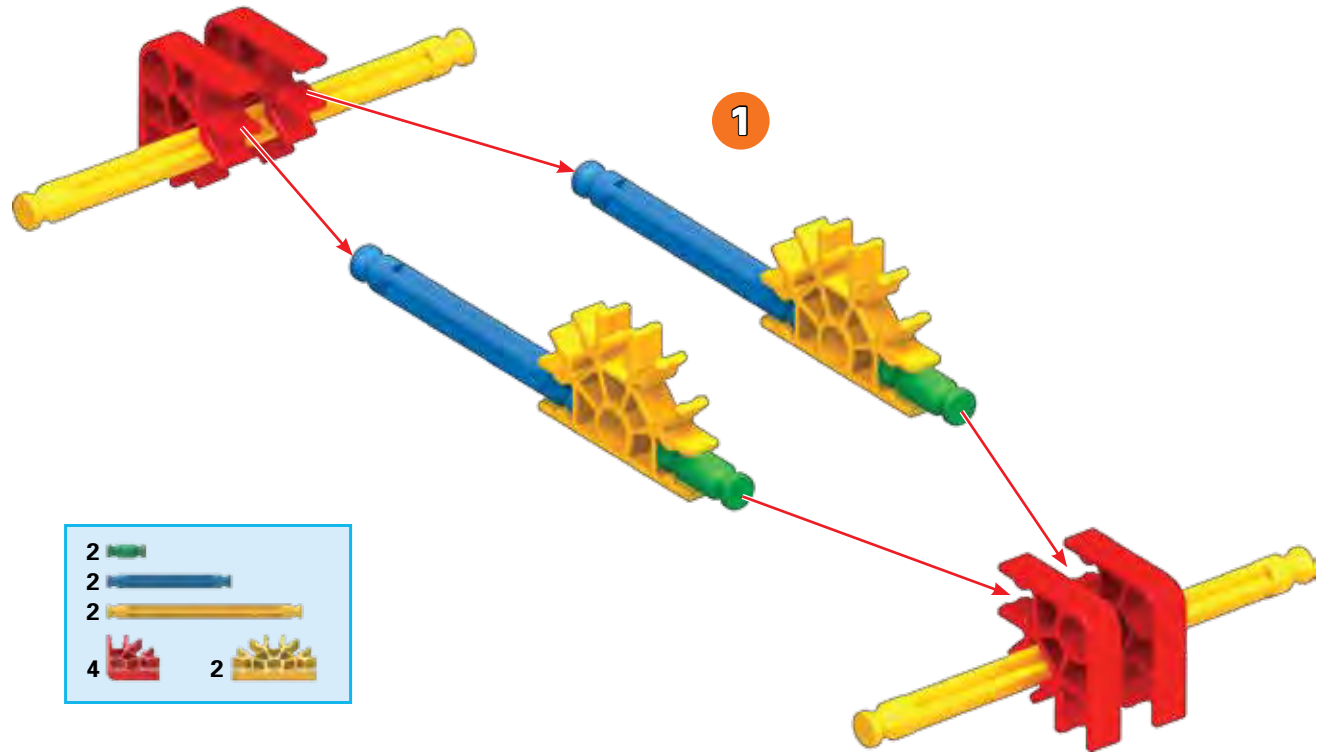
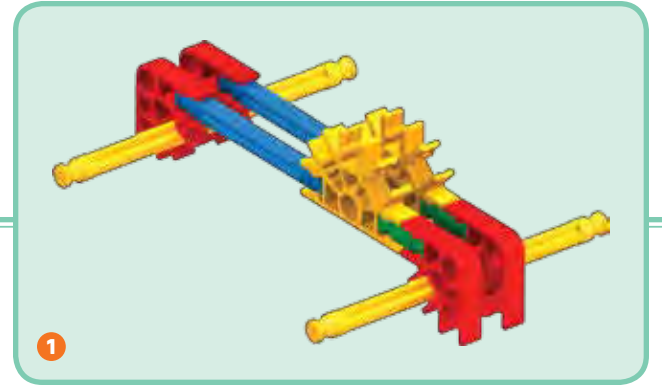

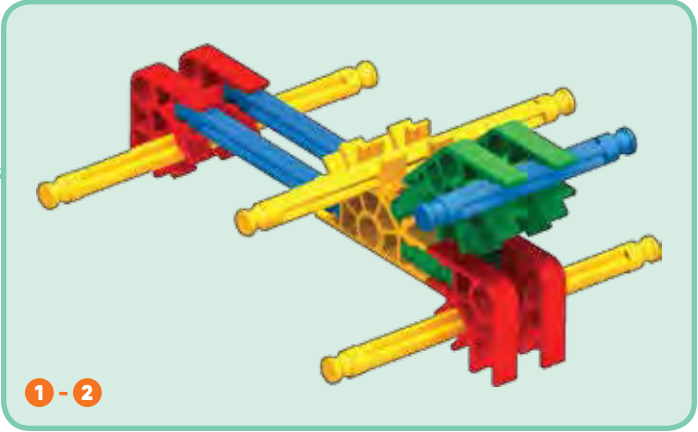
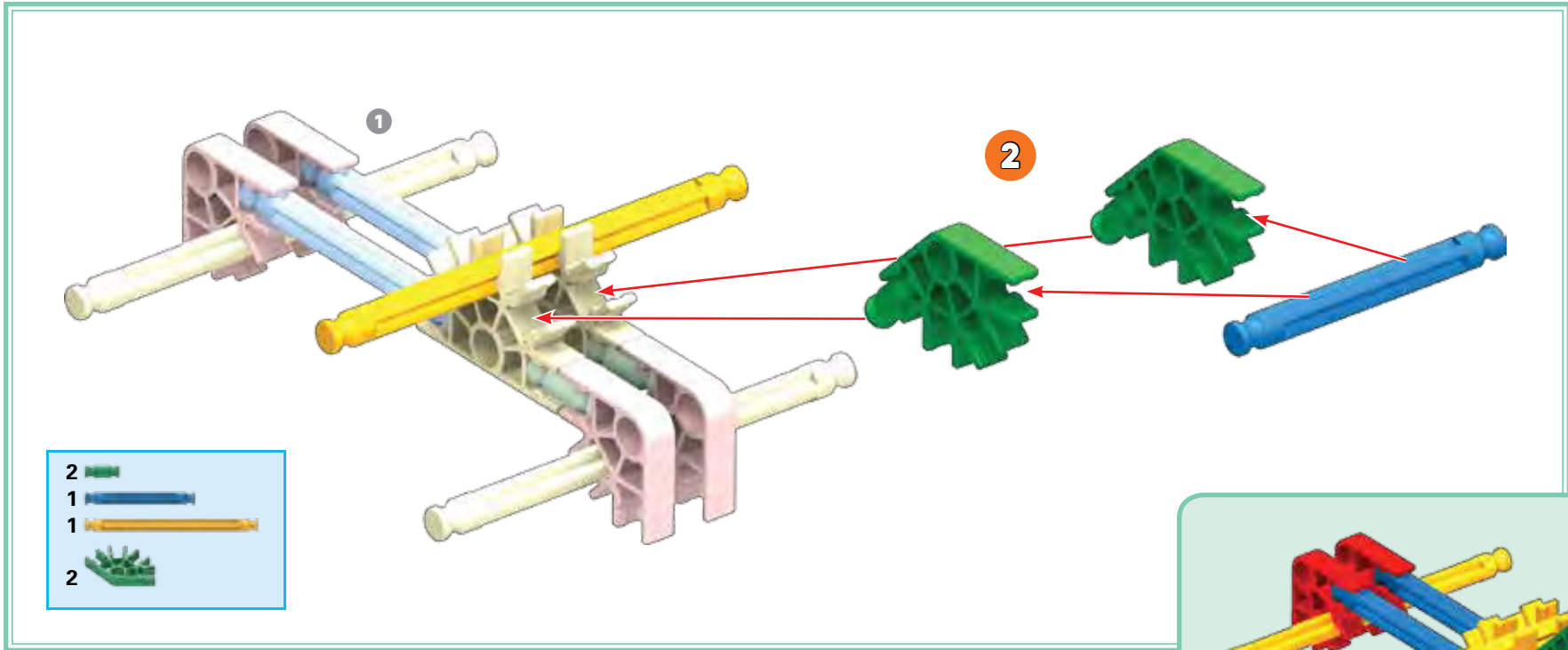

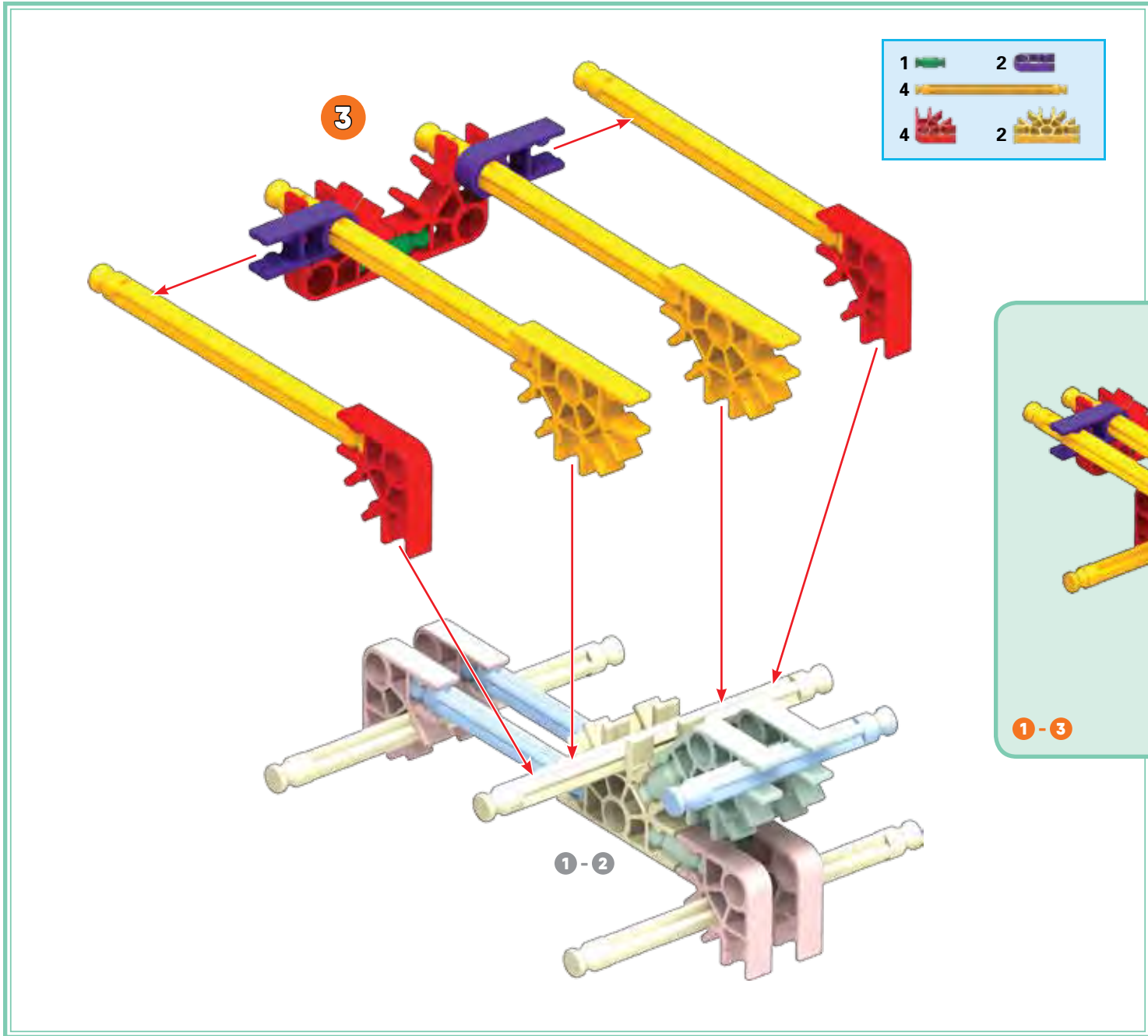

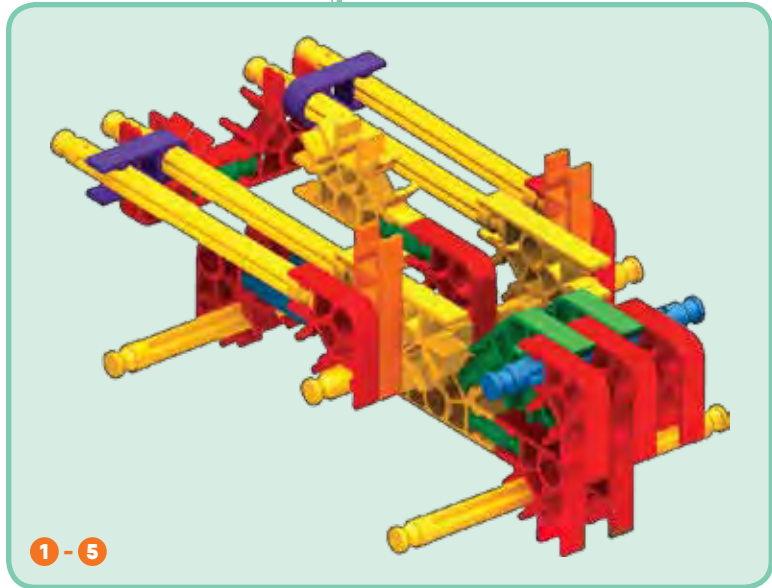
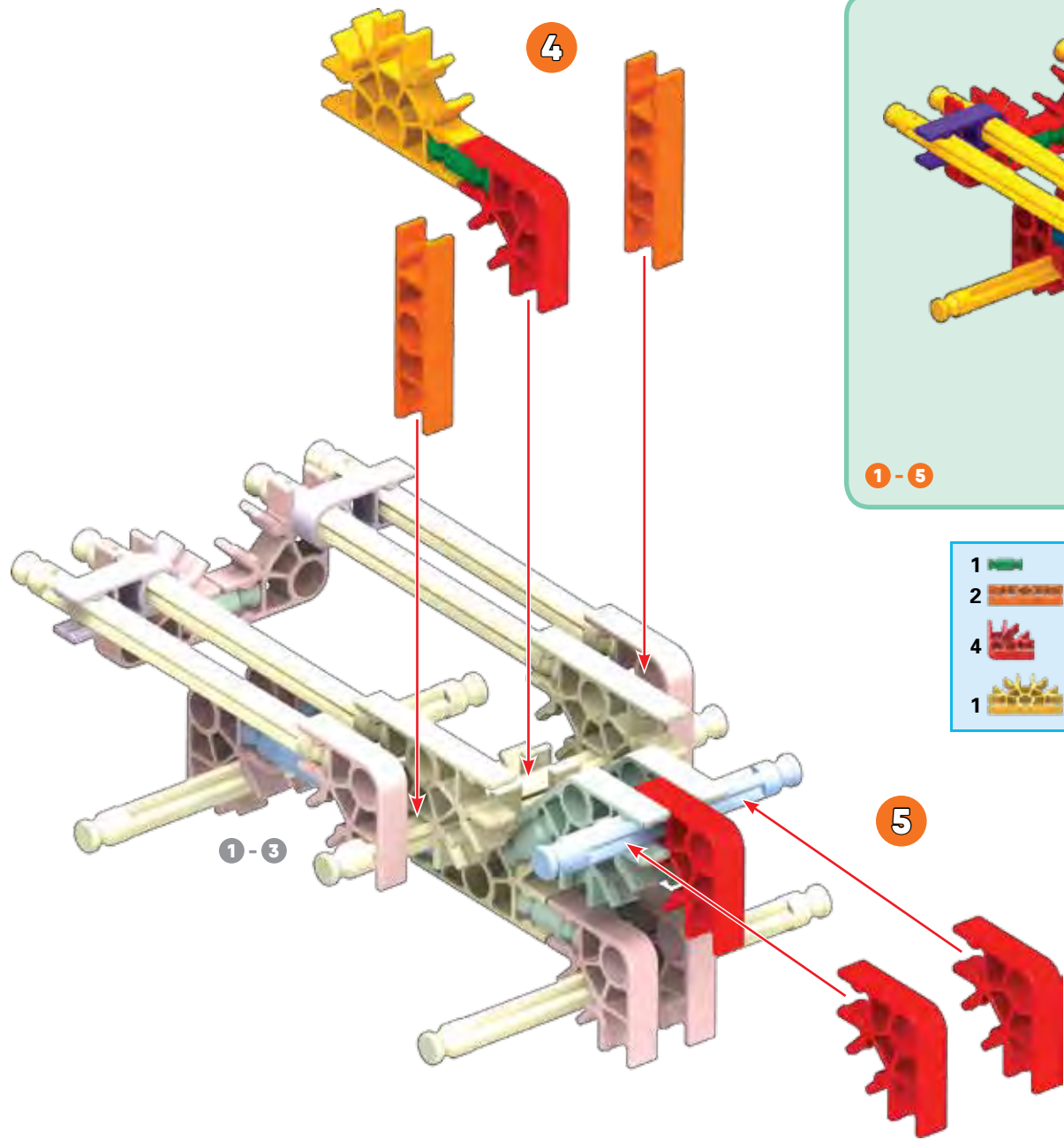

- 1
- 2
- 4
- 1

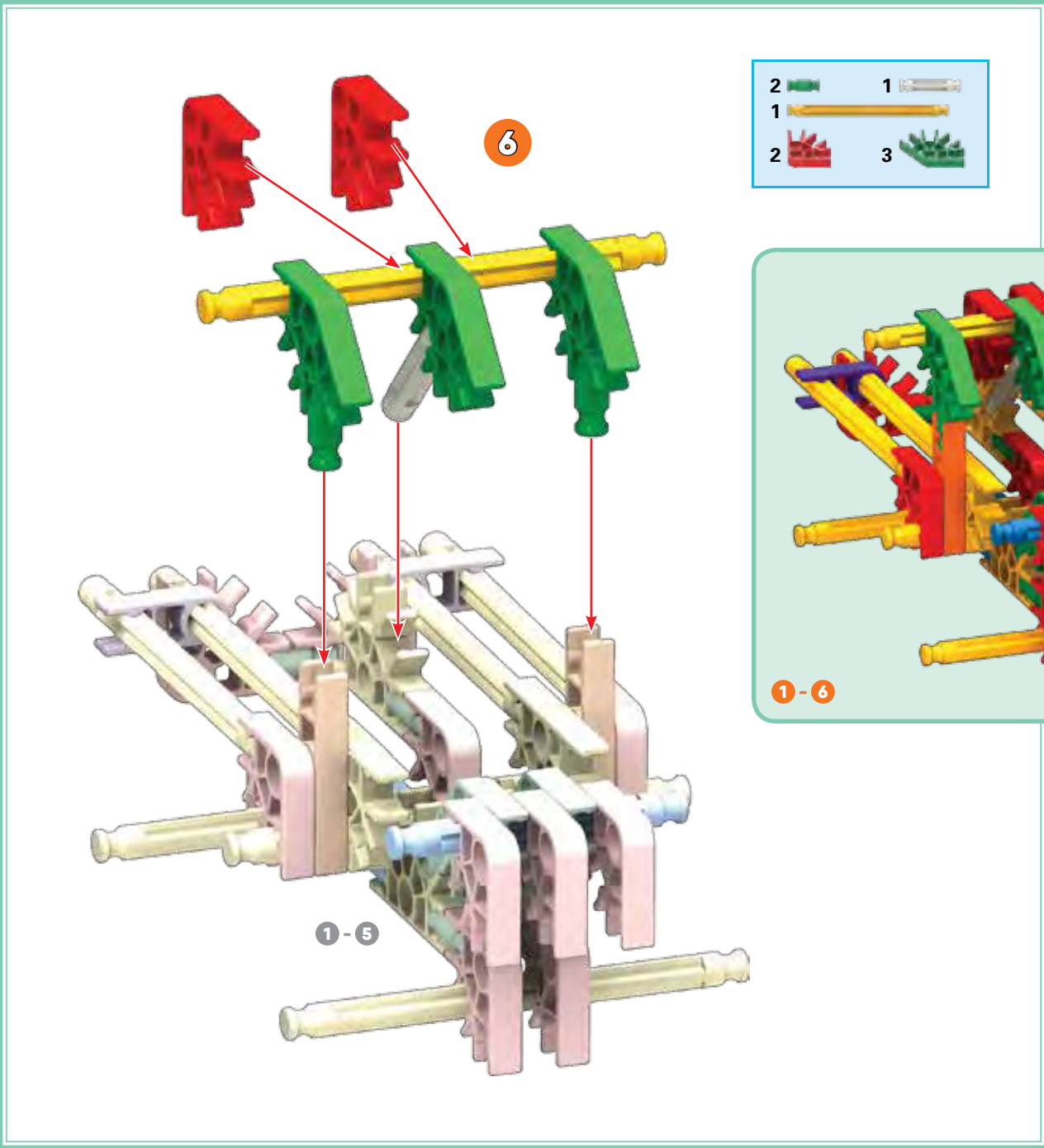

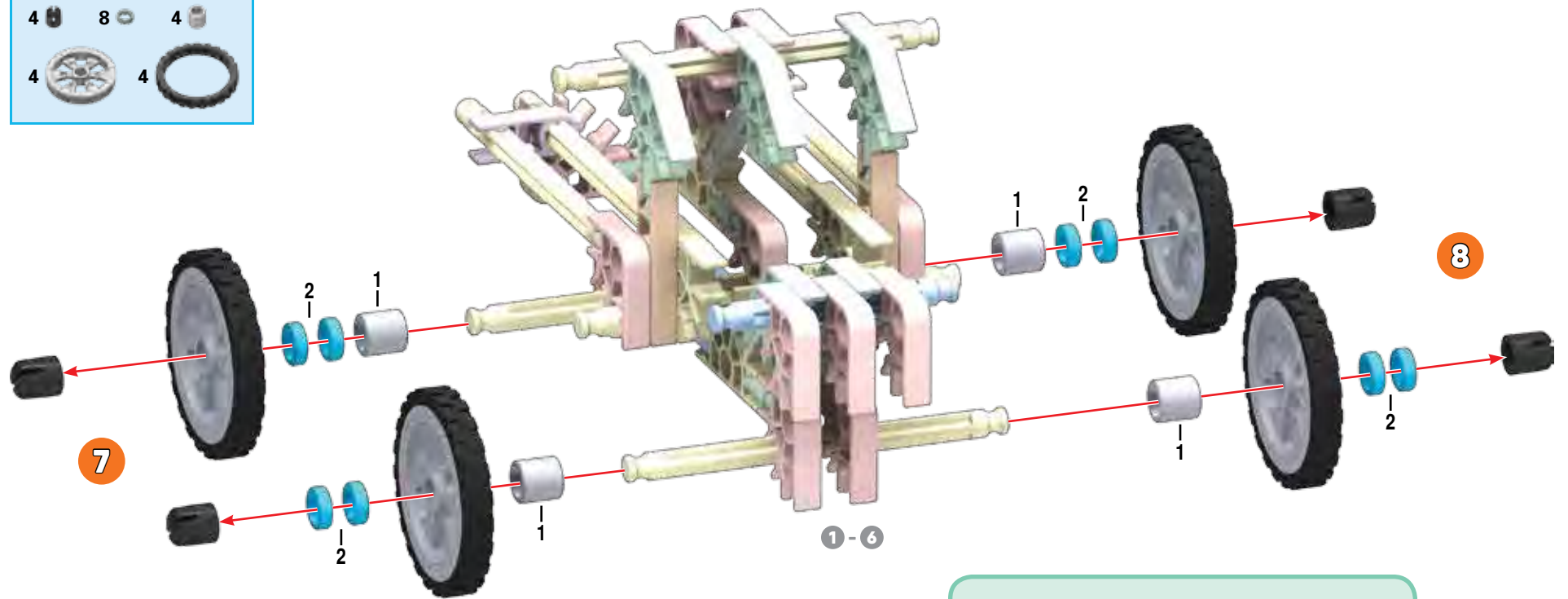





TOW TRUCK



1-9

rotate model

- | | | | |
|---|--|---|---|
| 1 |  | 2 |  |
| 2 |  | | |
| 1 |  | 1 |  |

9

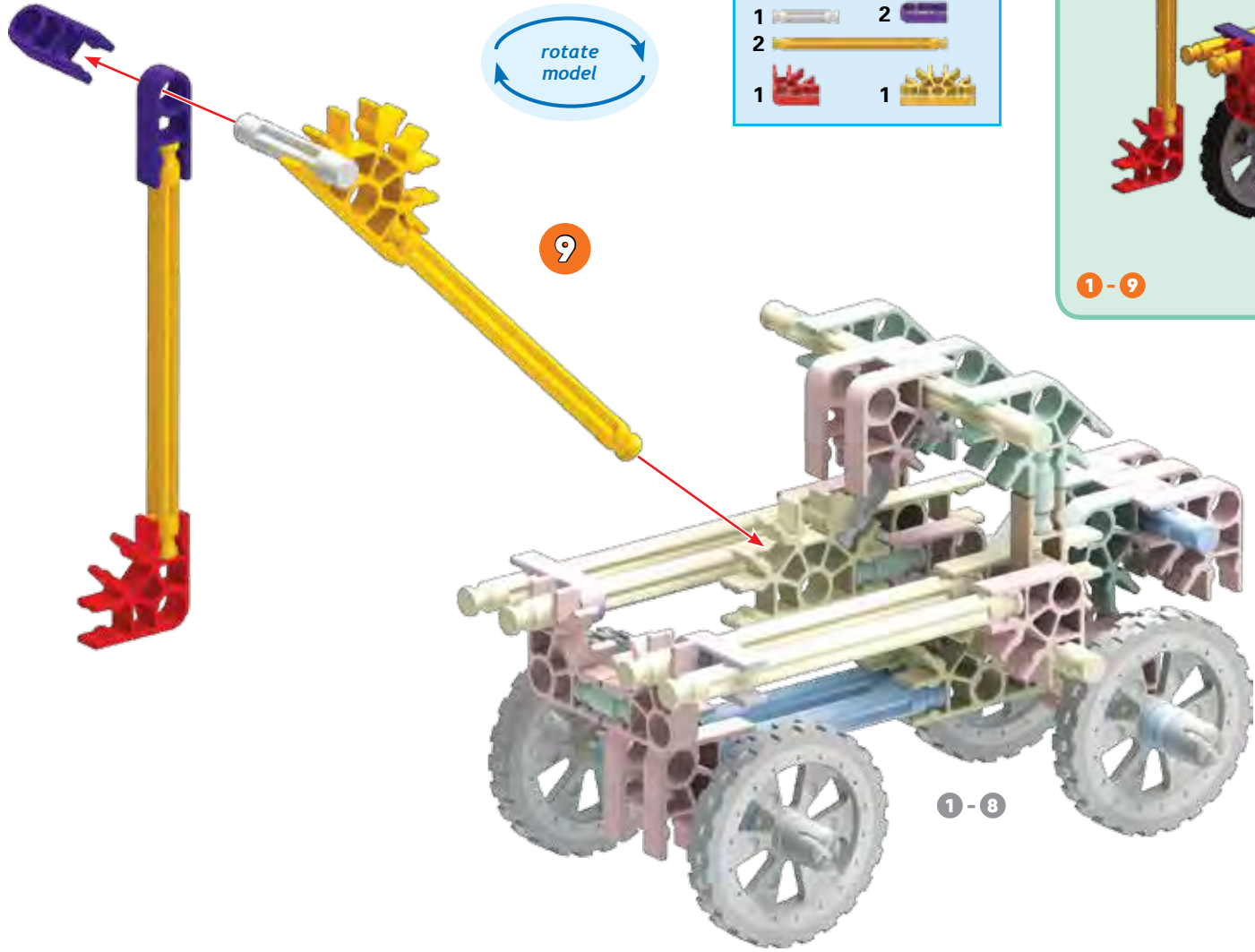

1-8

TRACTOR



- | | | | |
|---|--|---|--|
| 8 | | 2 | |
| 2 | | 2 | |
| 2 | | 4 | |

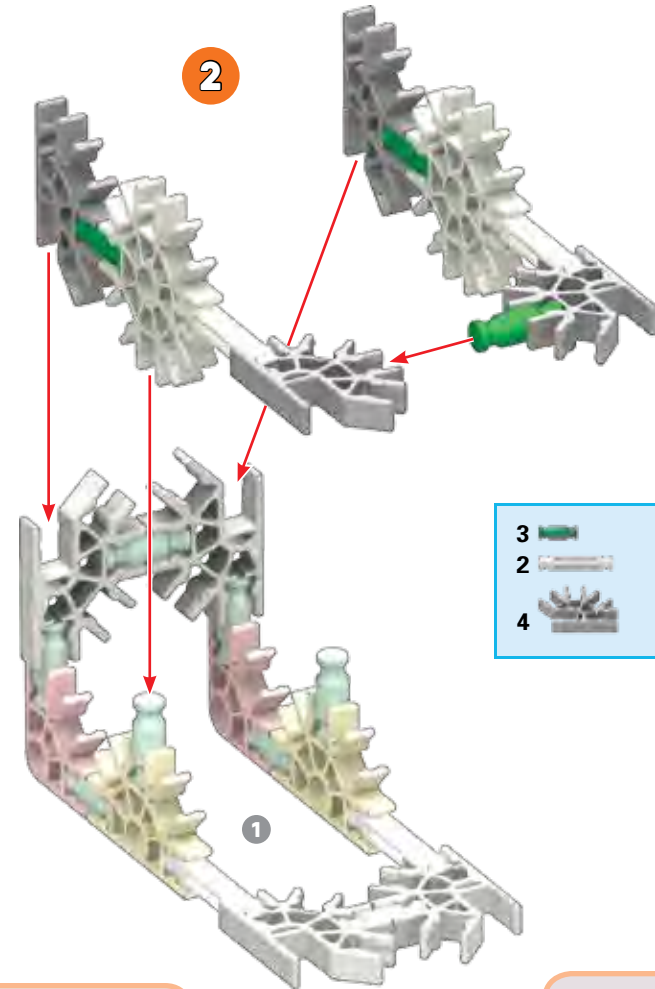
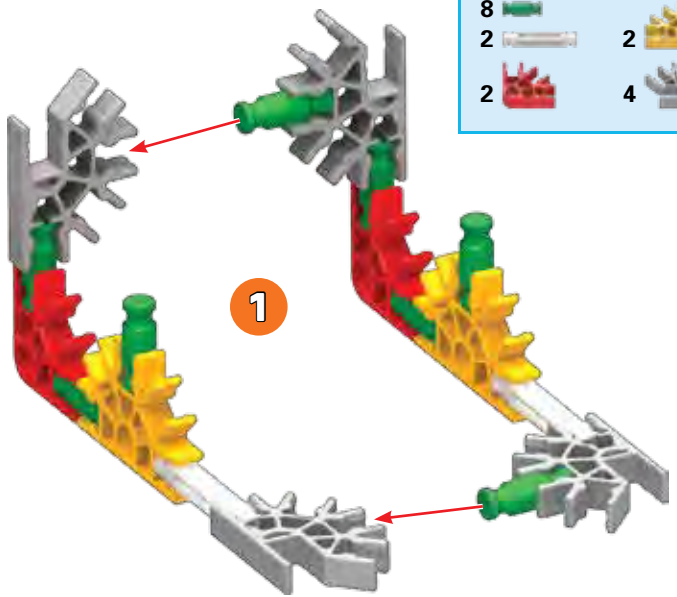

- | | | | |
|---|--|---|--|
| 3 | | 2 | |
| 2 | | | |
| 4 | | | |

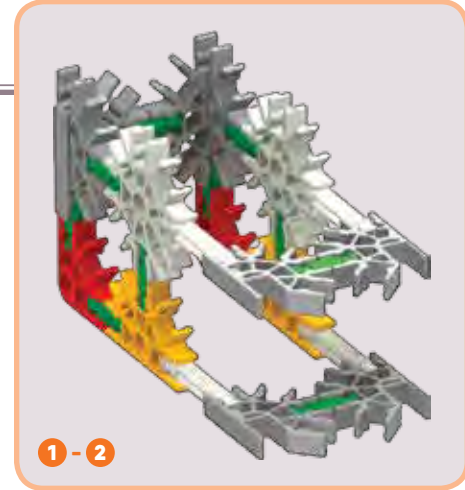
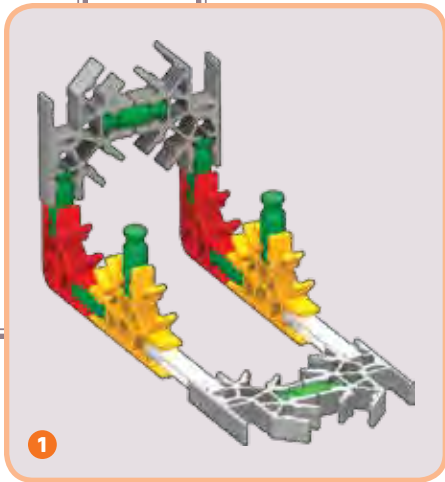

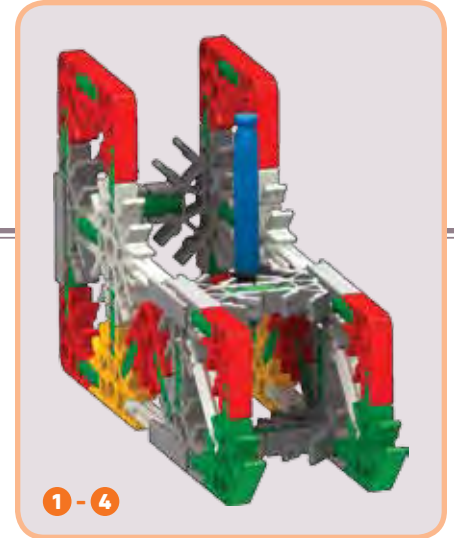
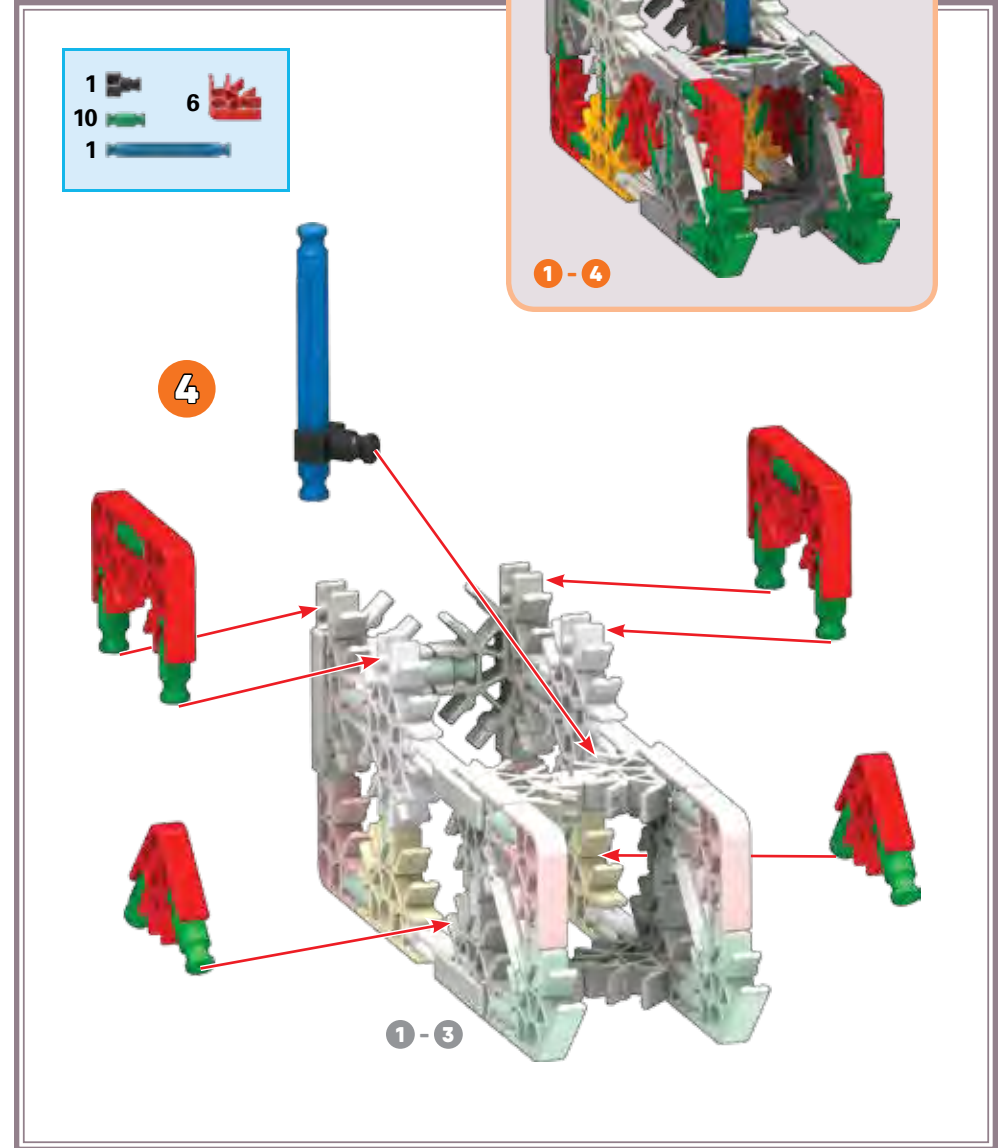
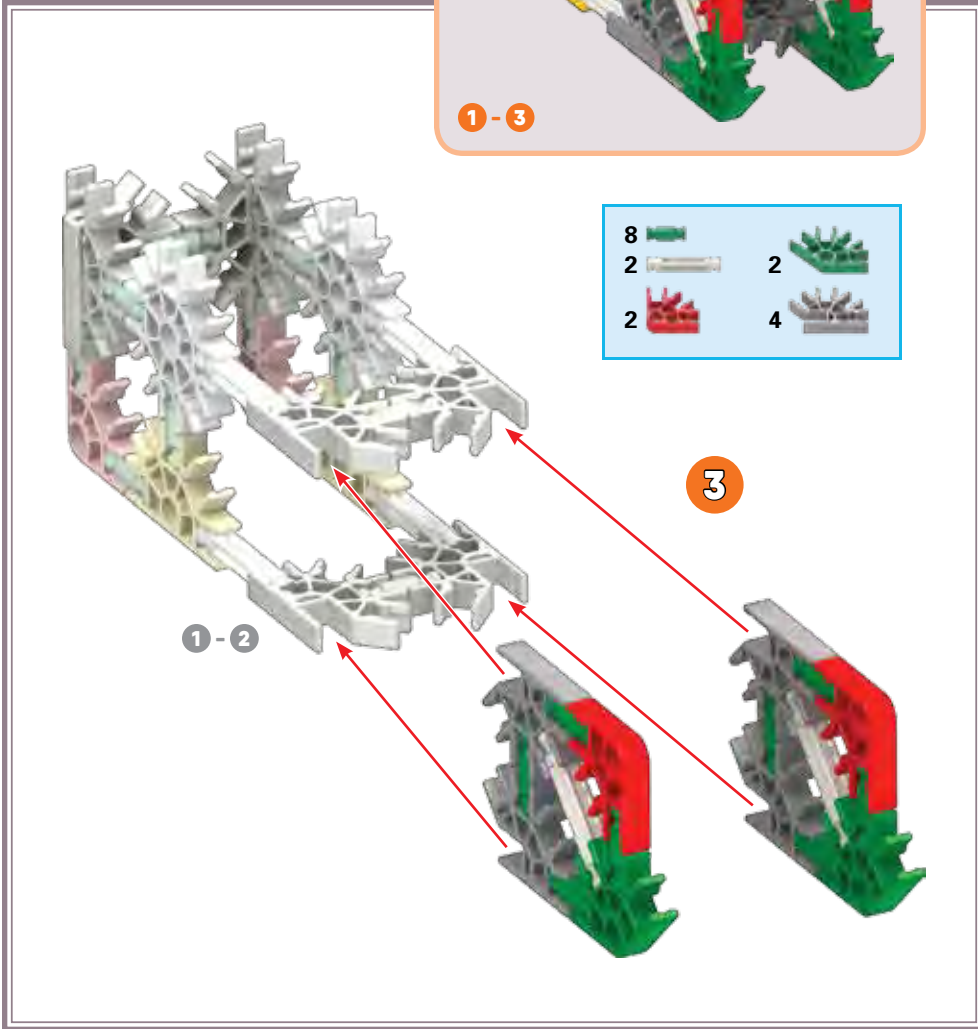

TRACTOR

1 - 6

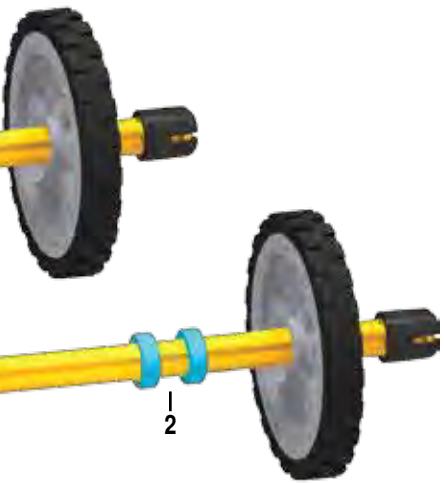
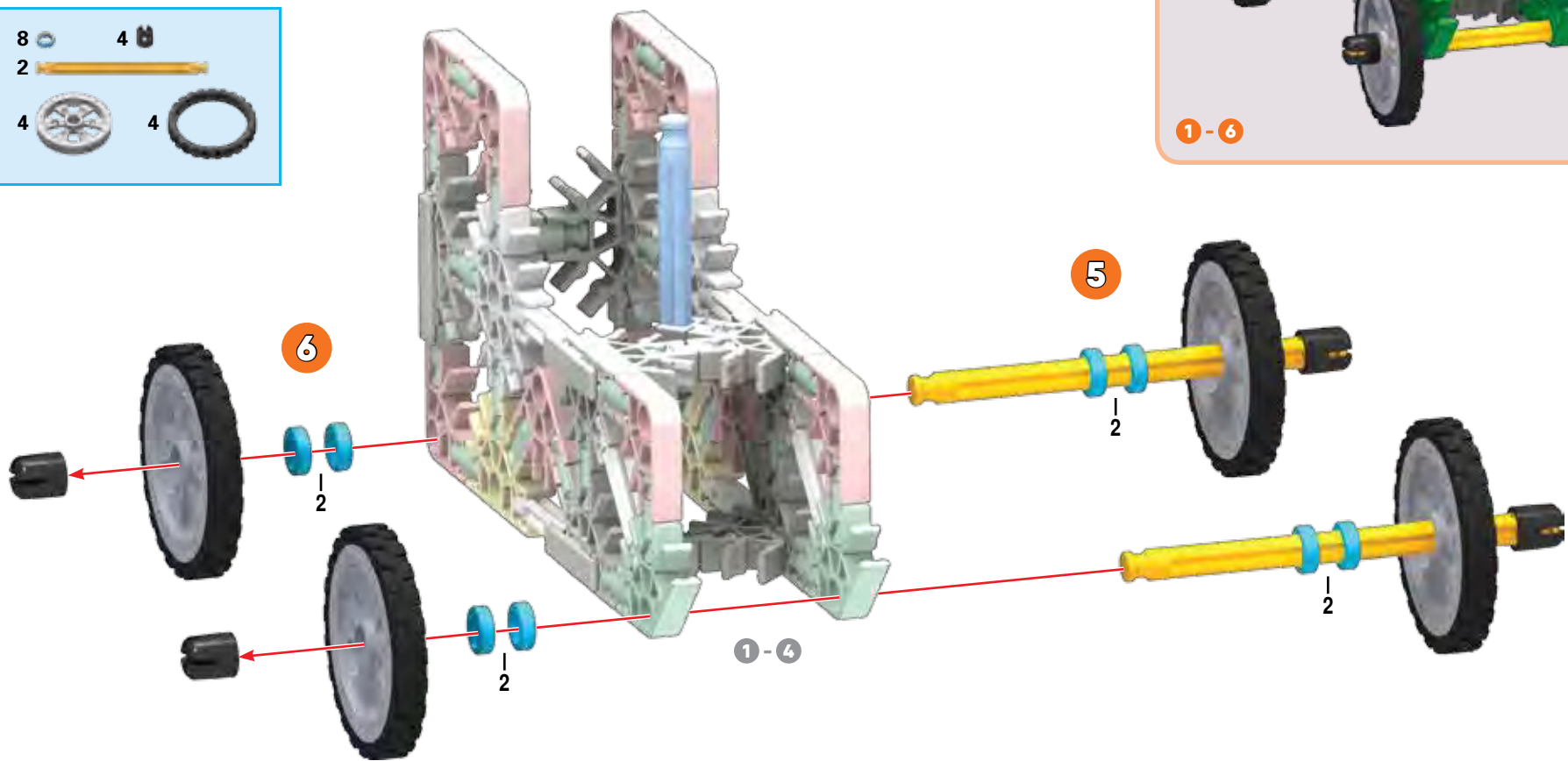
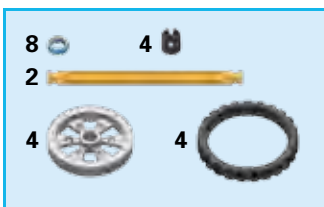

TREE

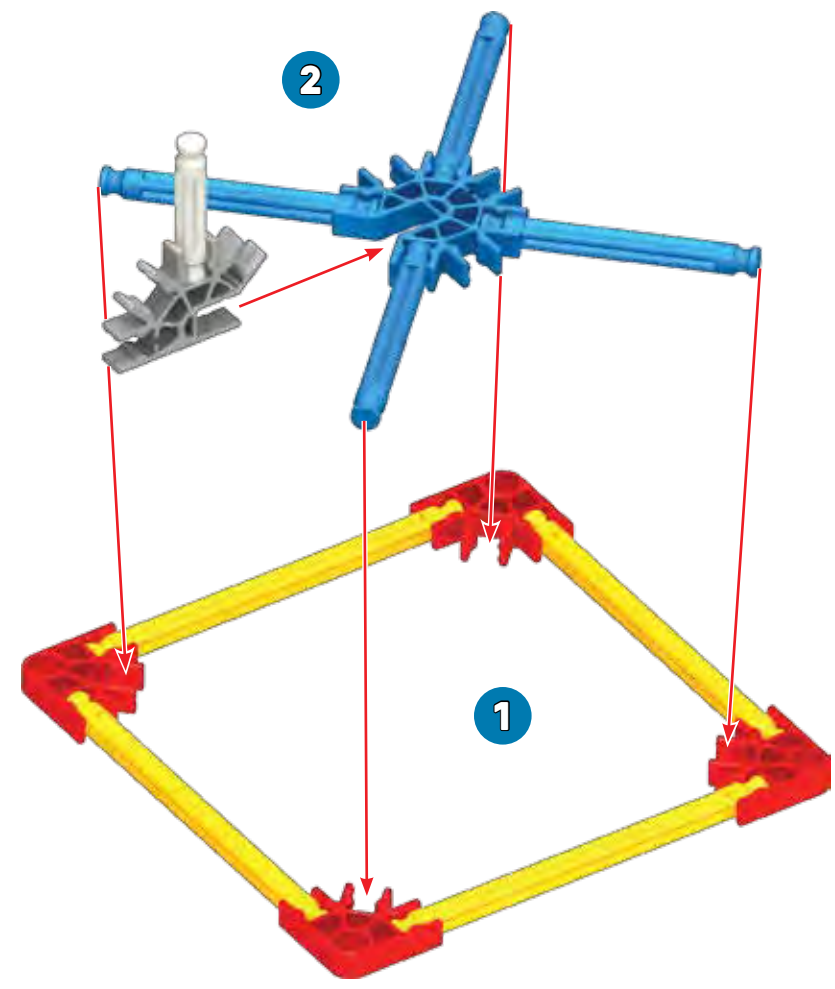
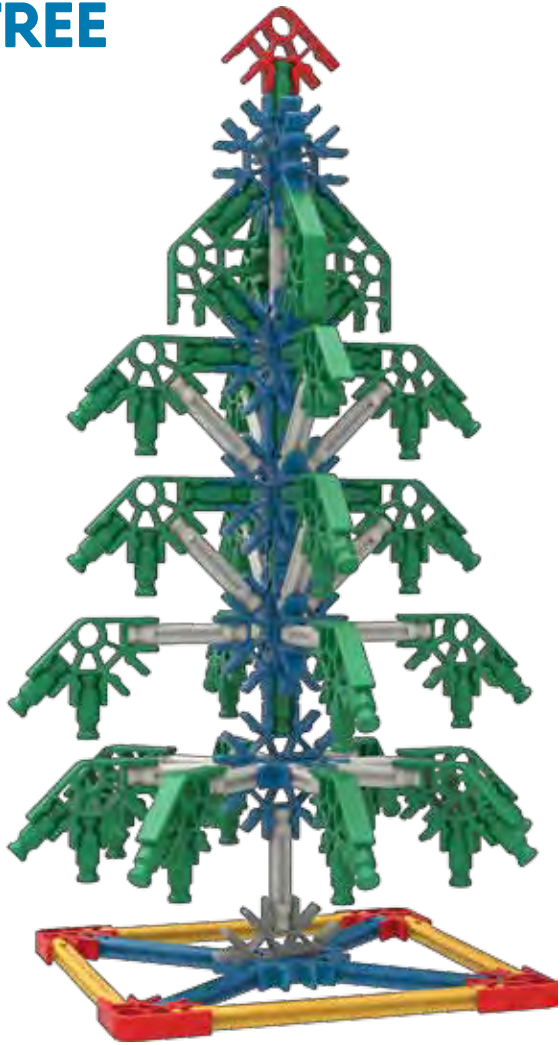

- 1
- 4
- 4
- 4
- 1
- 1

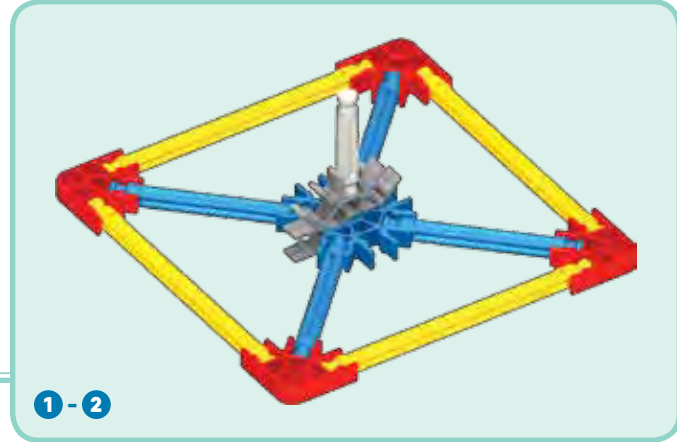

- 17 
- 8 
- 8 
- 2 

3

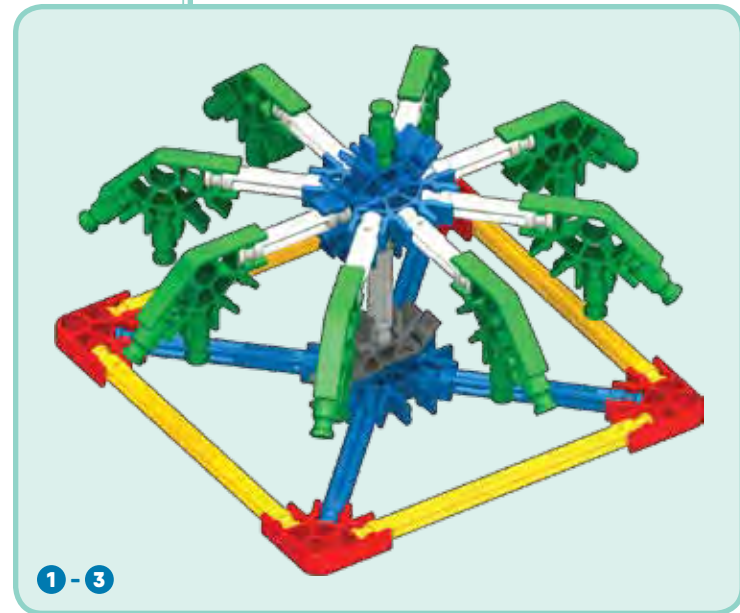
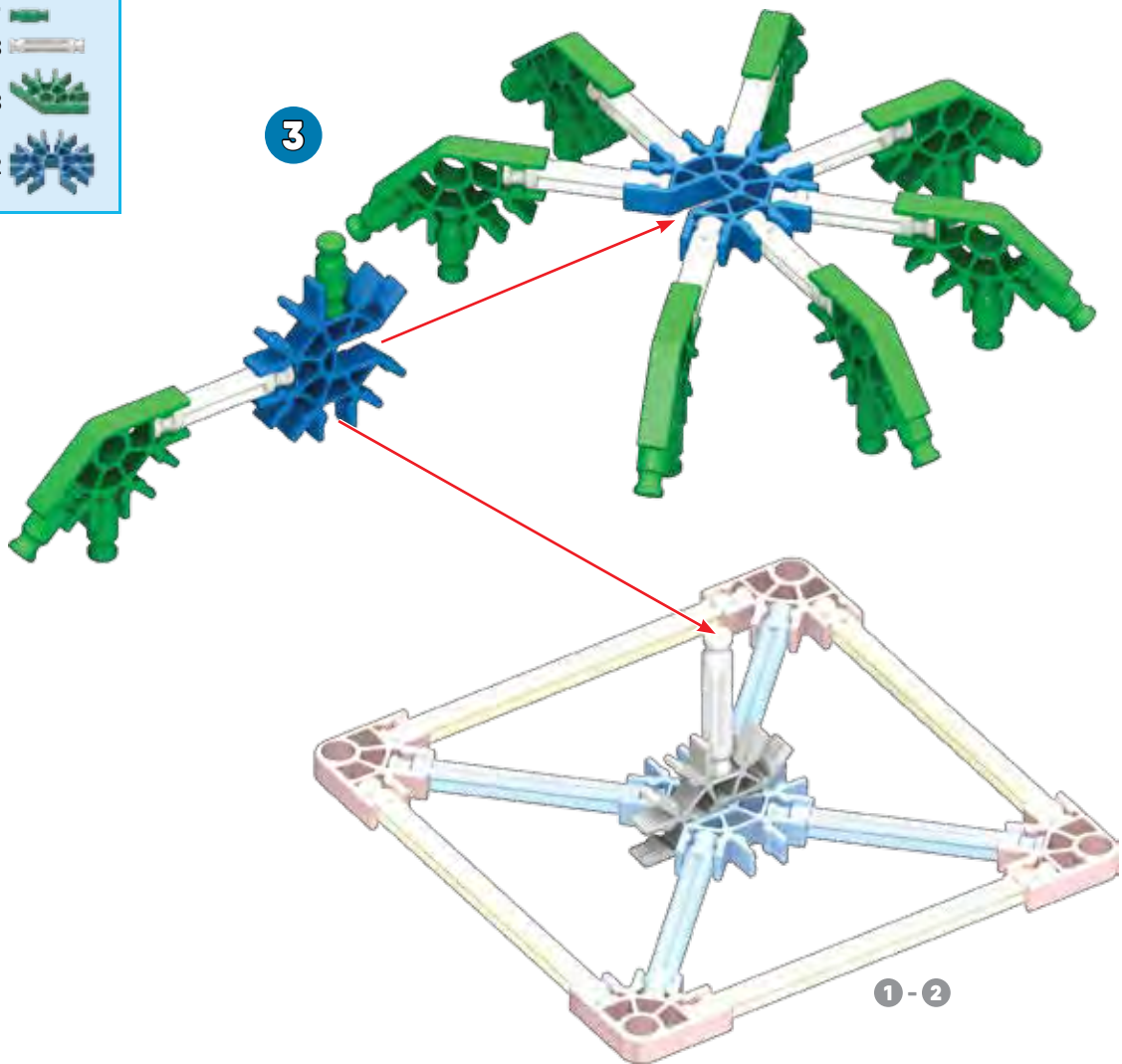



1-4

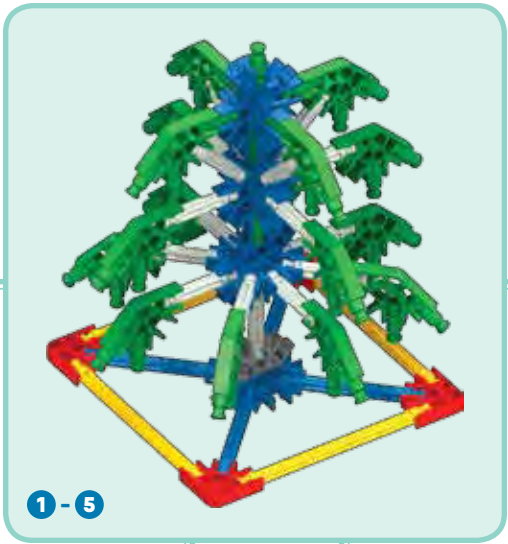

1-5

- 9
- 4
- 4
- 2

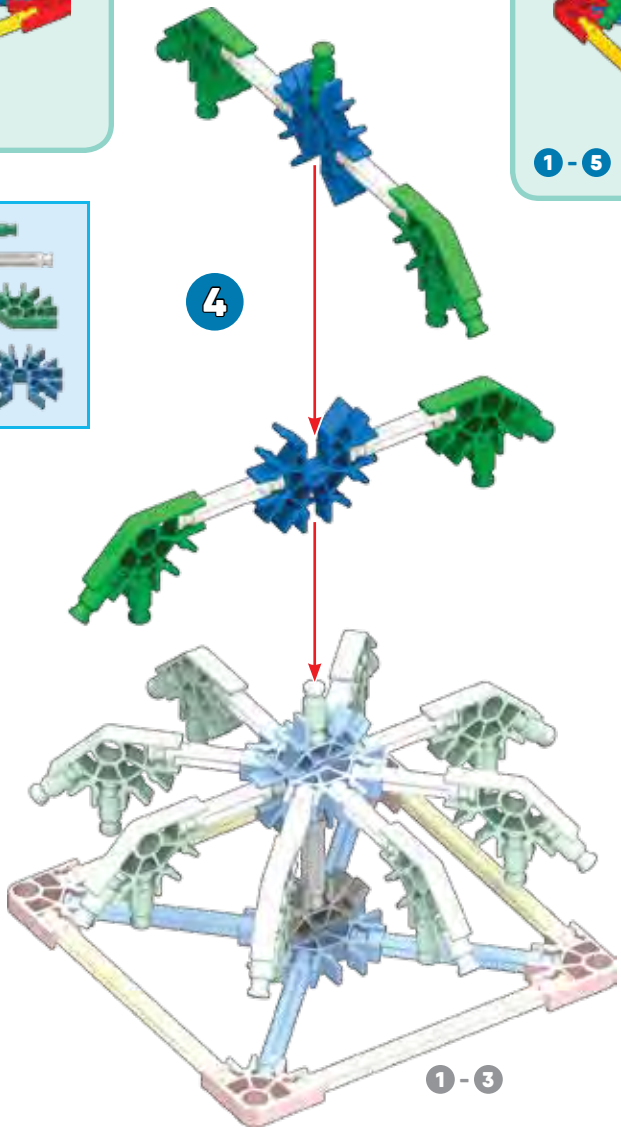

4

1-3

- 13
- 4
- 4
- 2

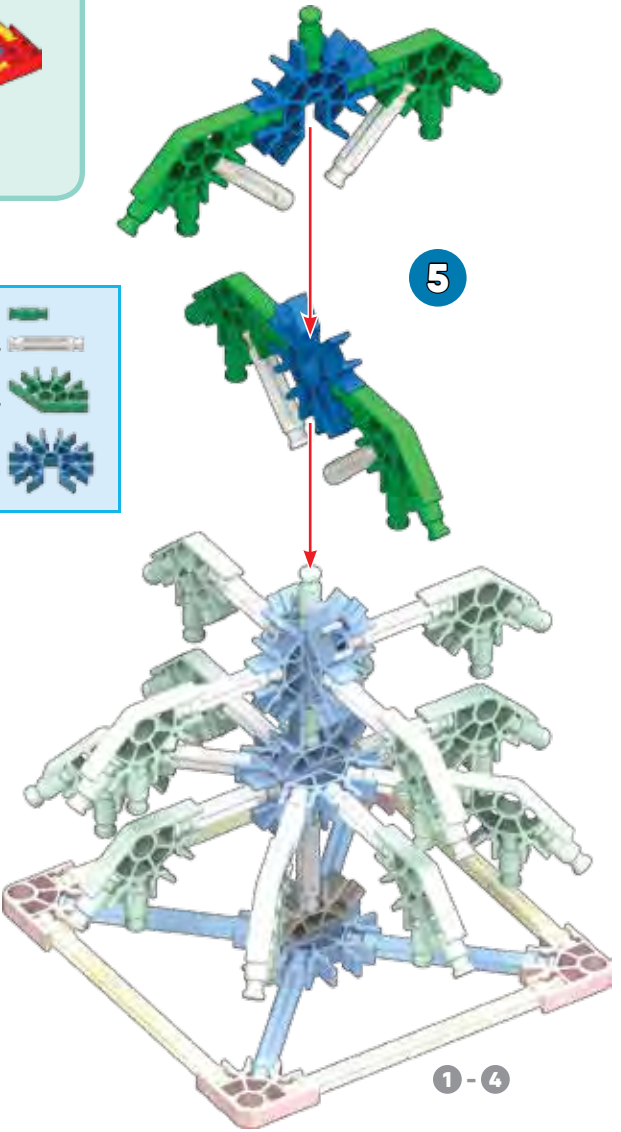

5

1-4

- 8 
- 5 
- 4 
- 2 

6

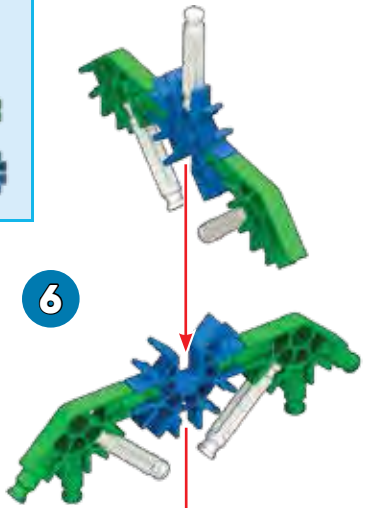

1-6

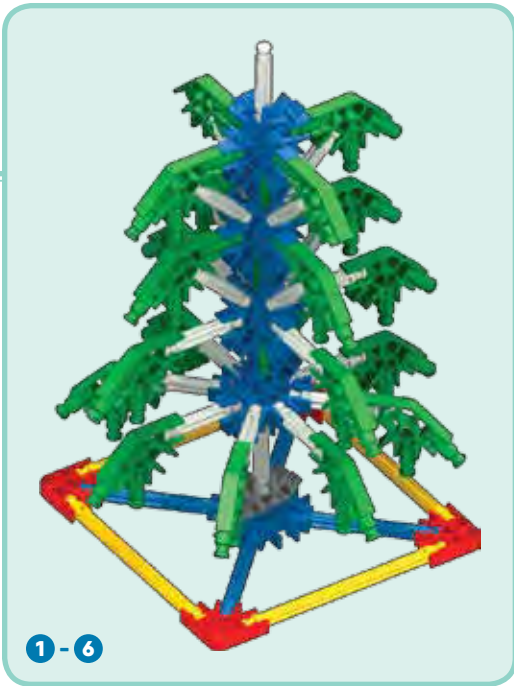

7

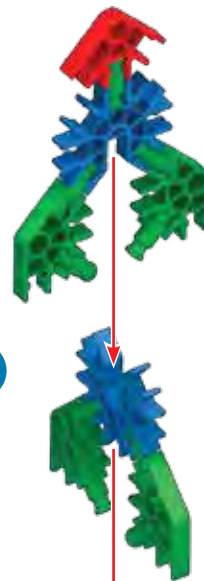

1-7



- 9 
- 1 
- 4 
- 2 

1-6

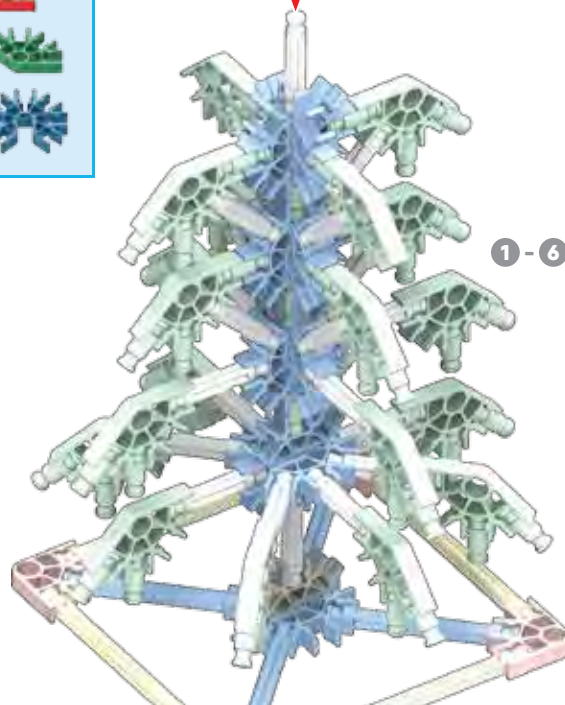

WASP

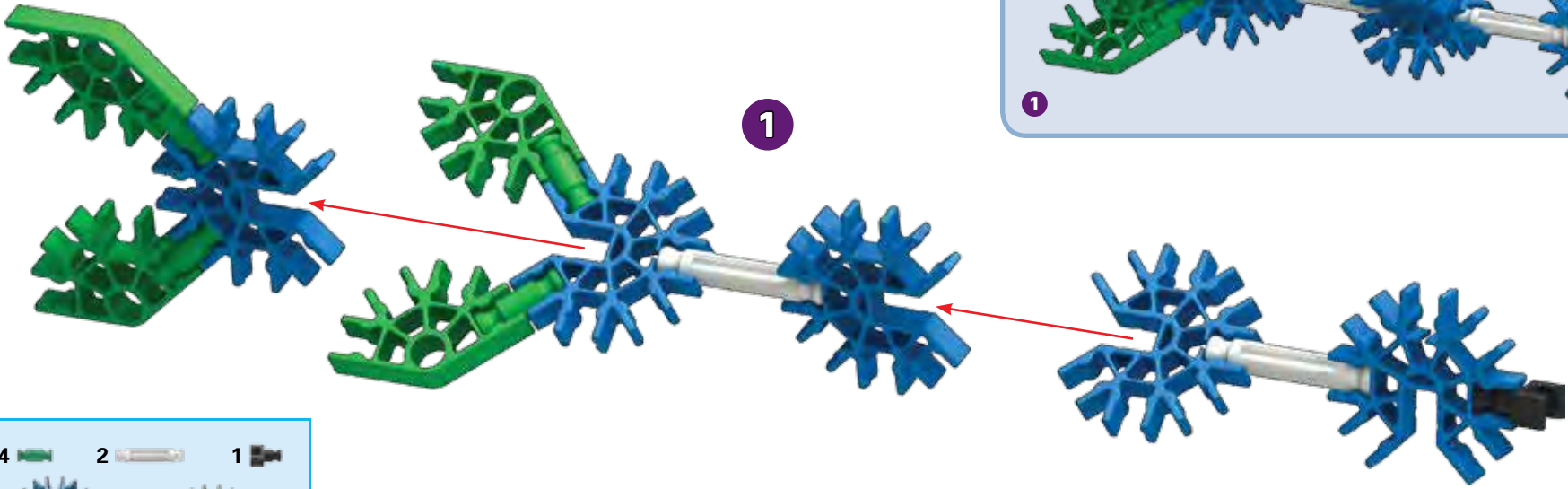
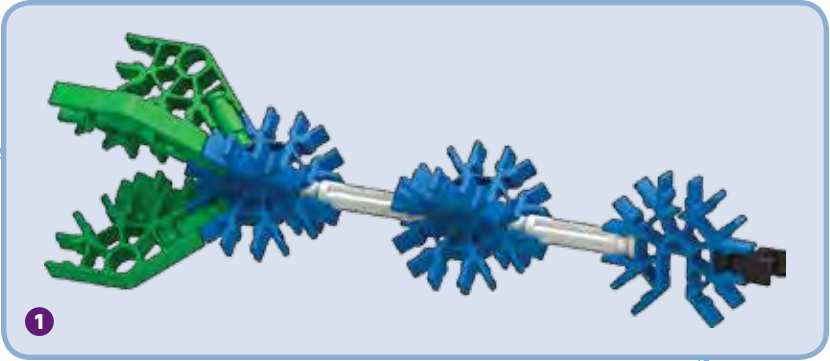

- | | | |
|---|---|---|
| 4 | 2 | 1 |
| 5 | 4 | |

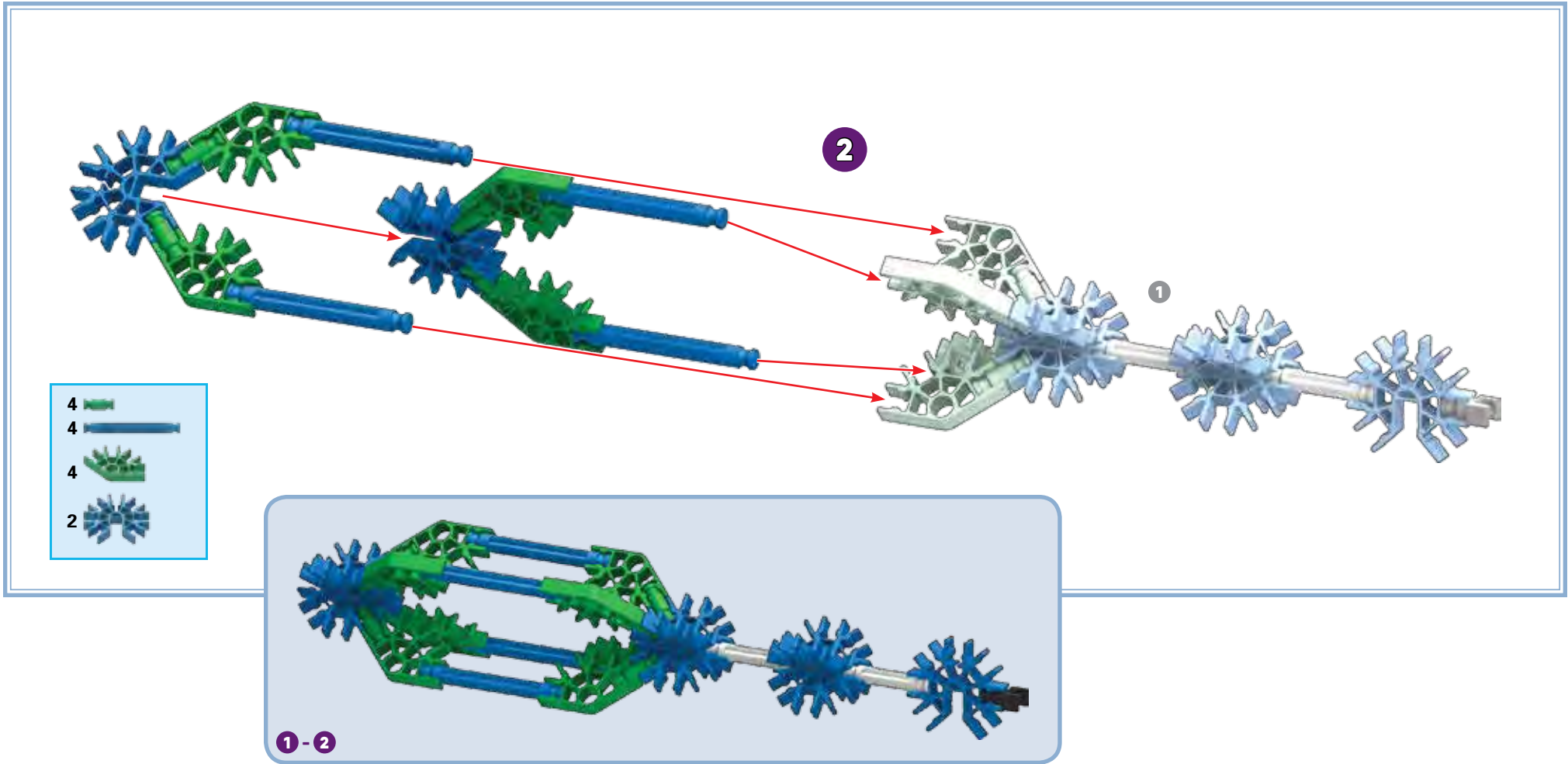

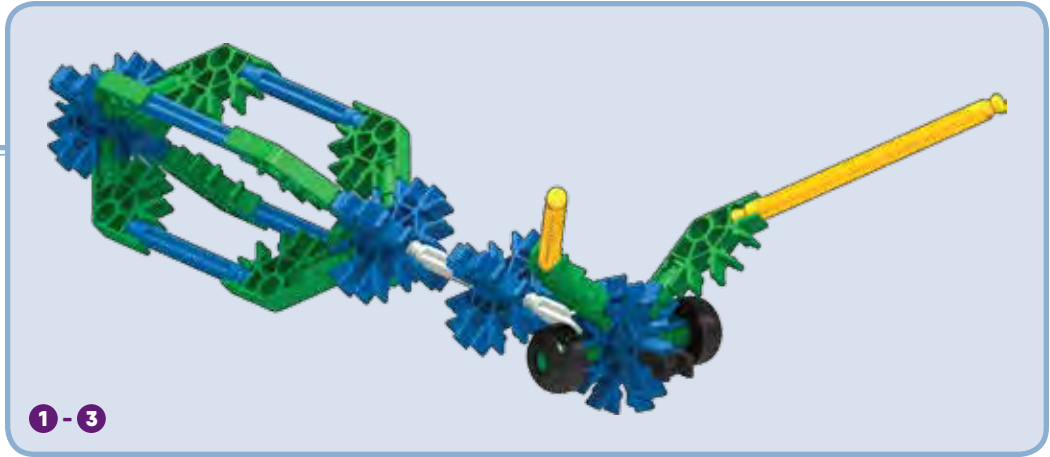
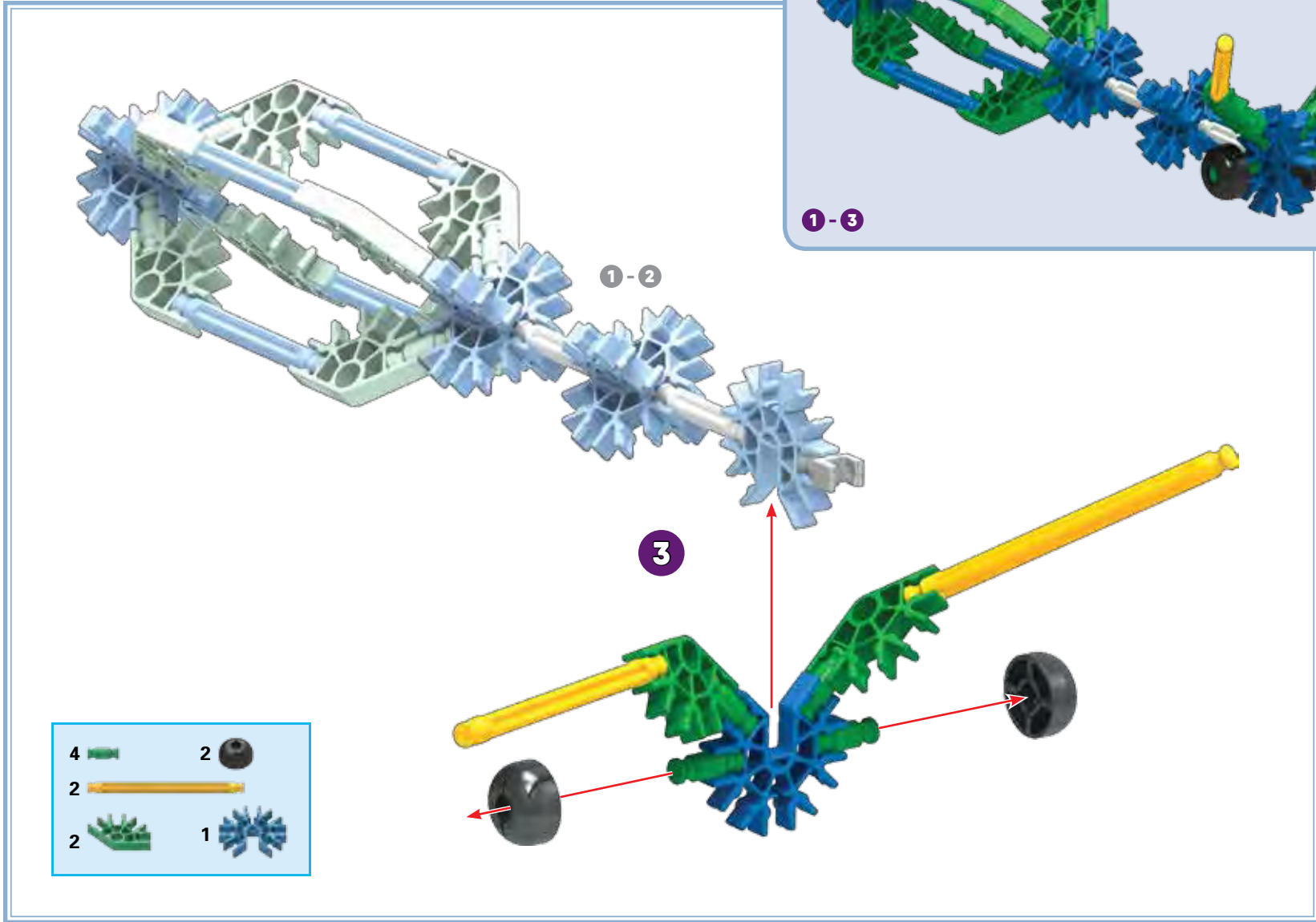

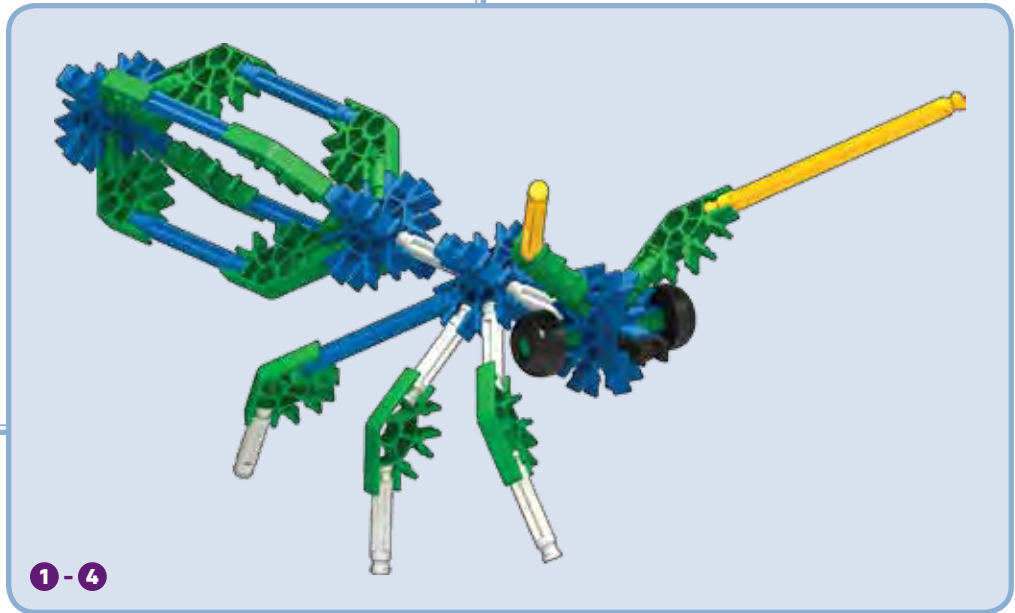
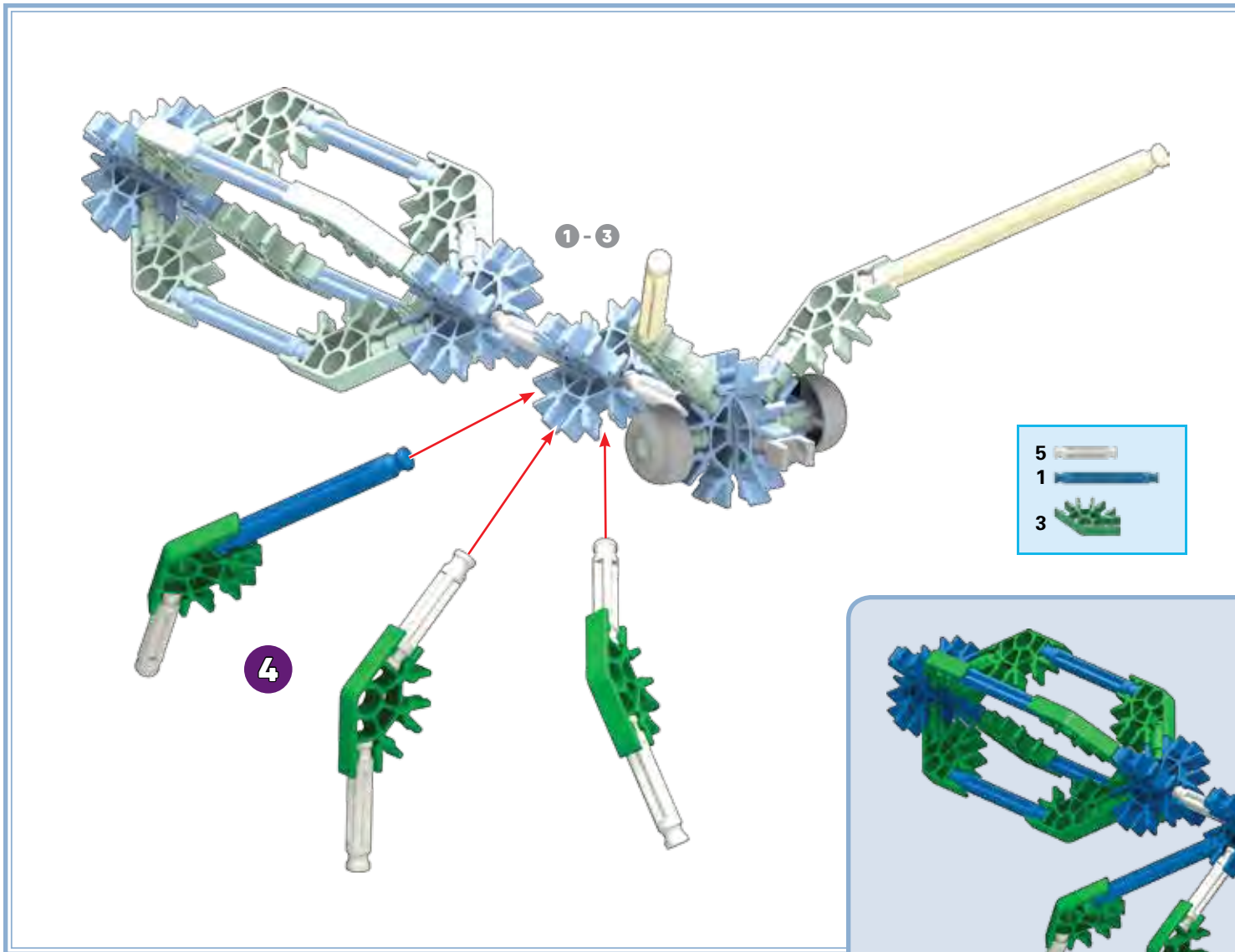

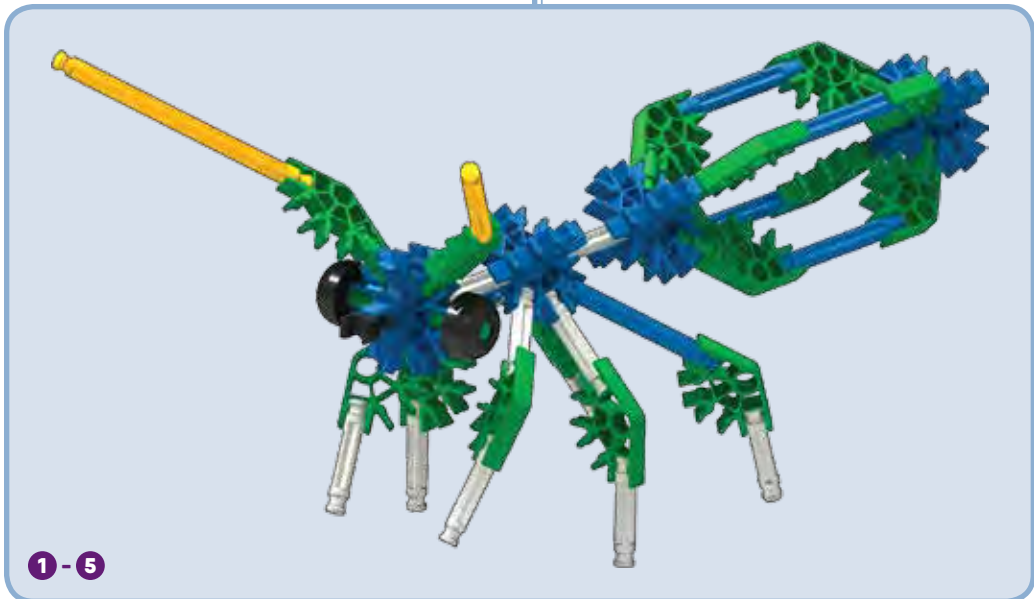
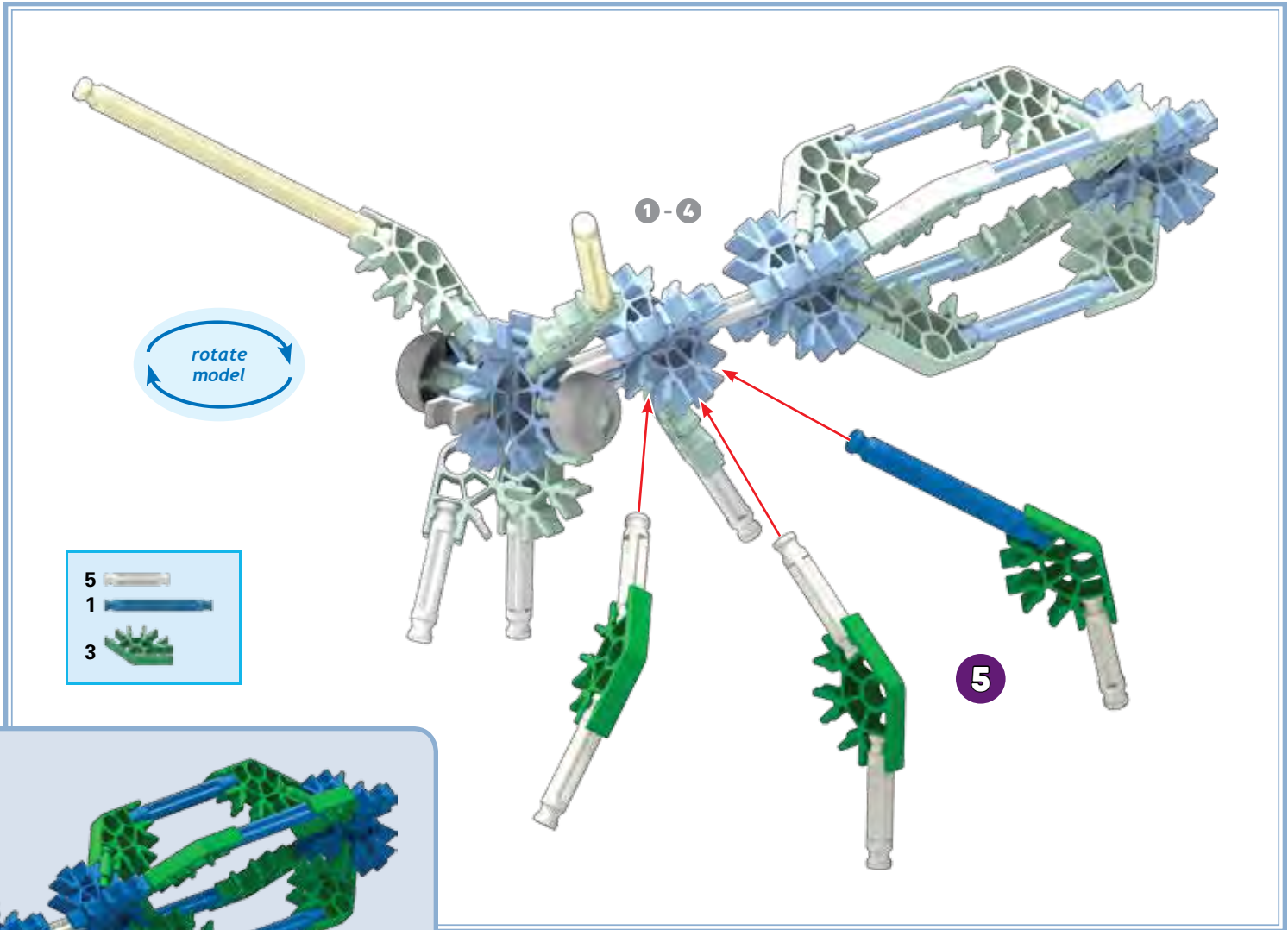

x2

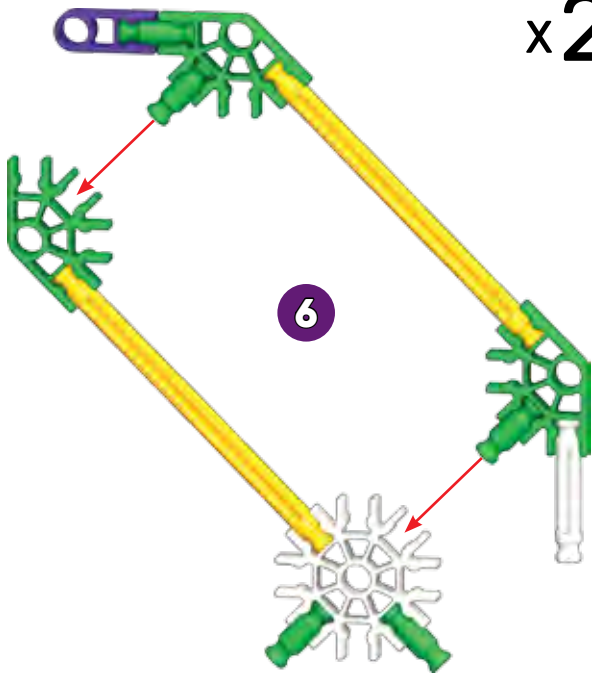

6

WASP

1 - 8

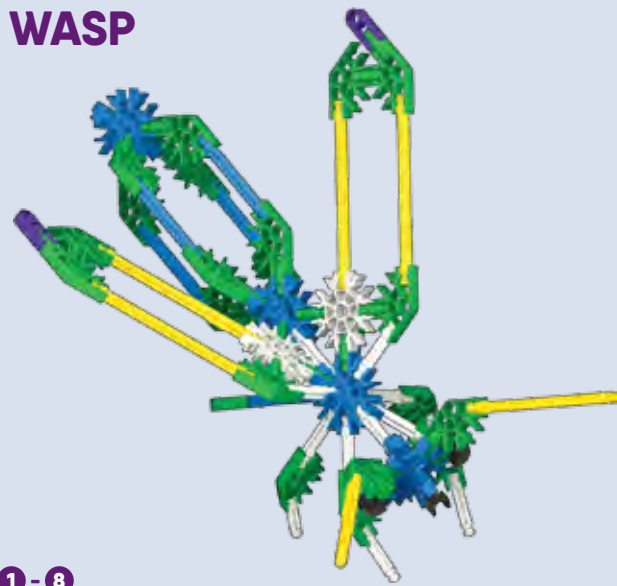

- | | |
|----|---|
| 10 | 2 |
| 4 | 2 |
| 6 | 2 |

x2

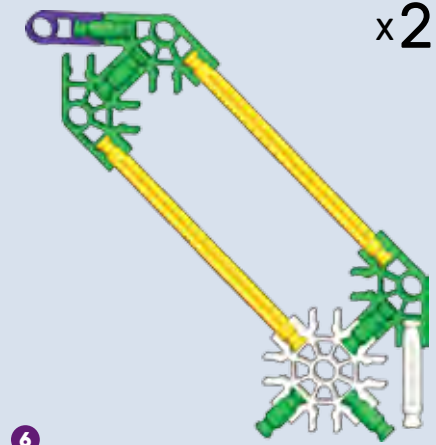

6

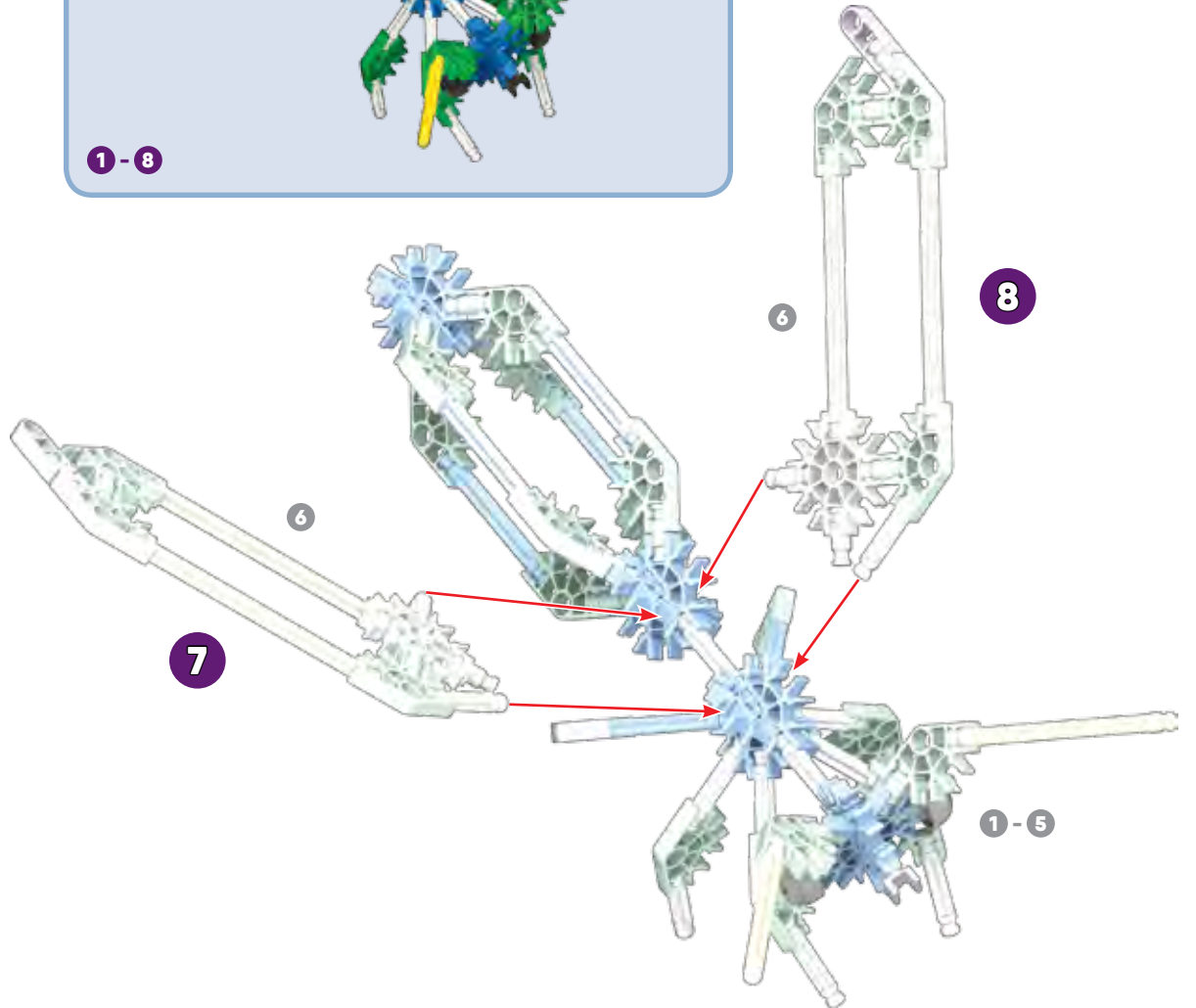

8

6

7

1 - 5

WAVE

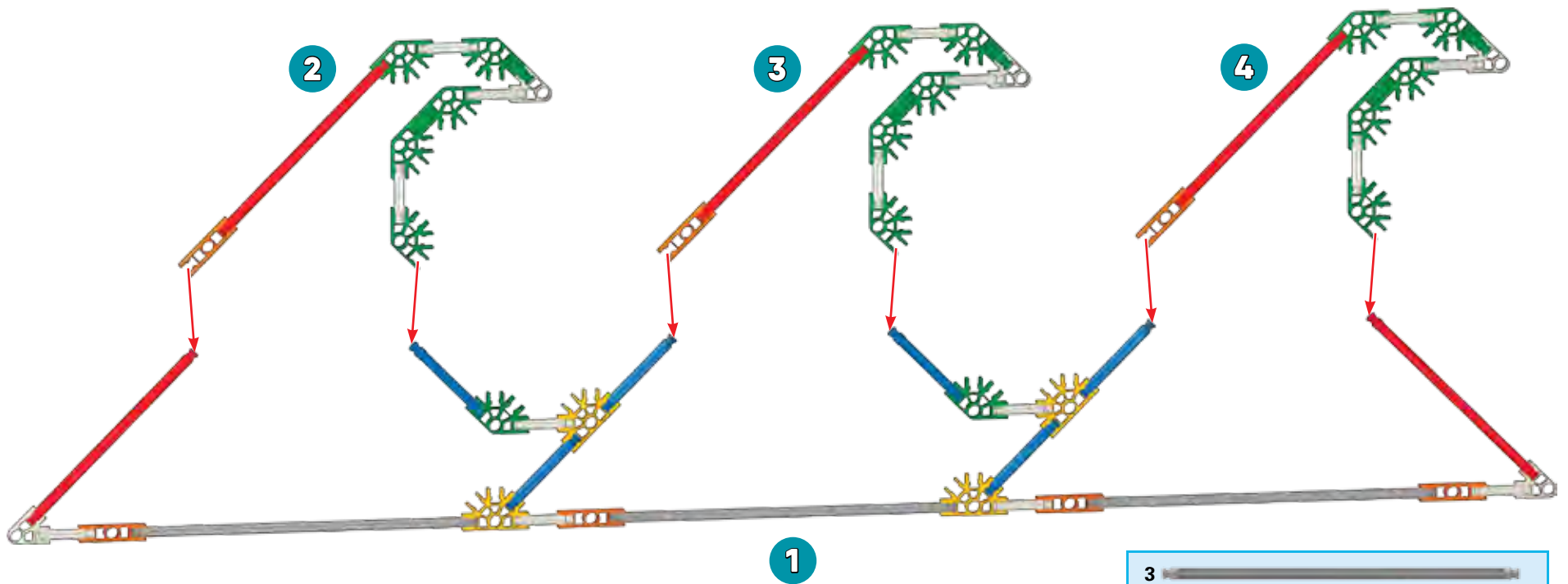
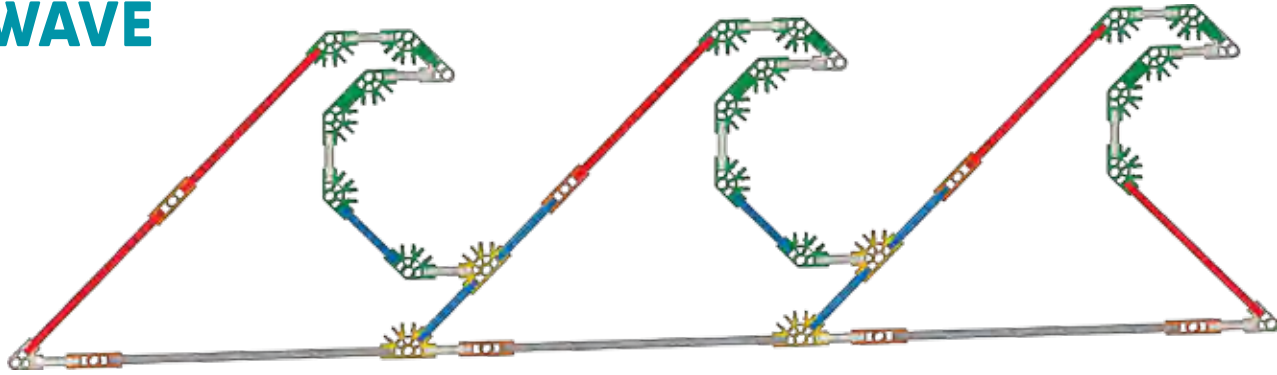

3			
5			
6		15	
6			7
5		4	
		17	





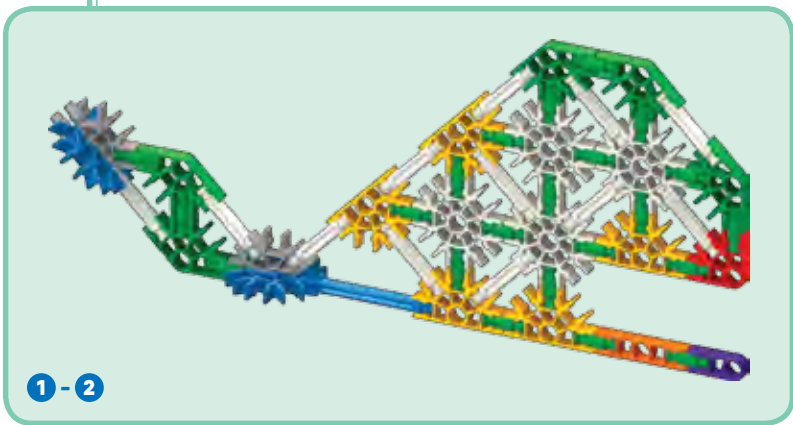
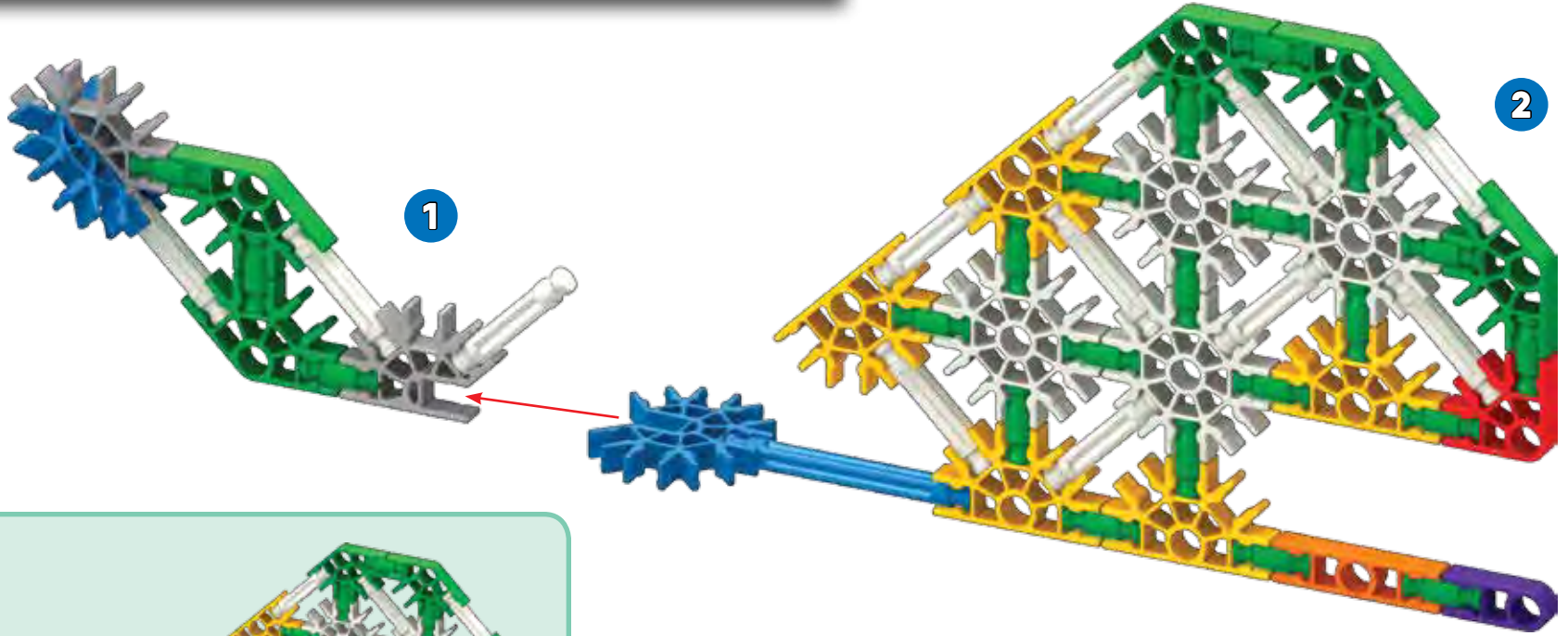

WHALE



22		12	
1		1	
1		1	
1		5	
2		5	
2		4	



1-2

2		2	
6		5	
2		4	

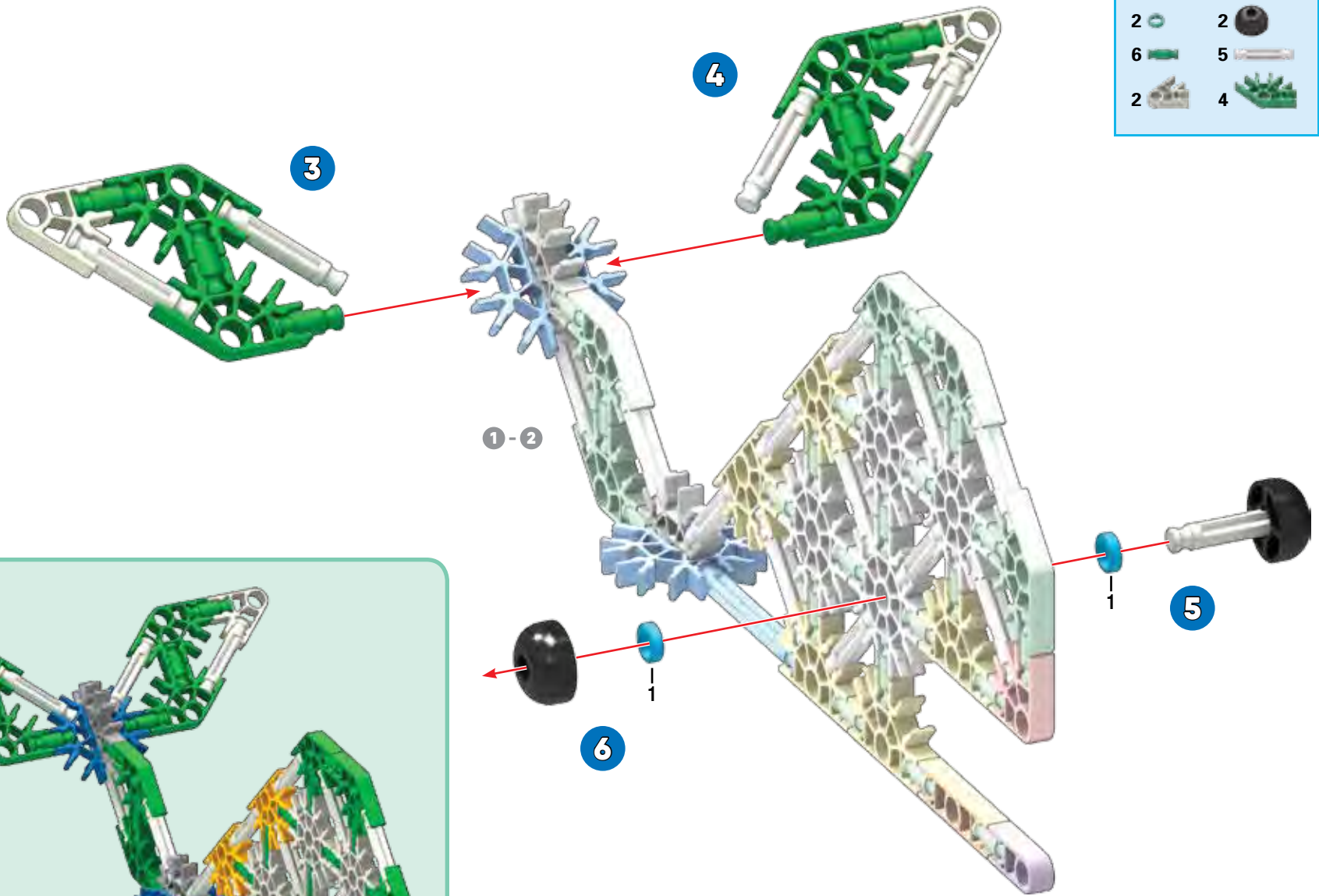

WHALE

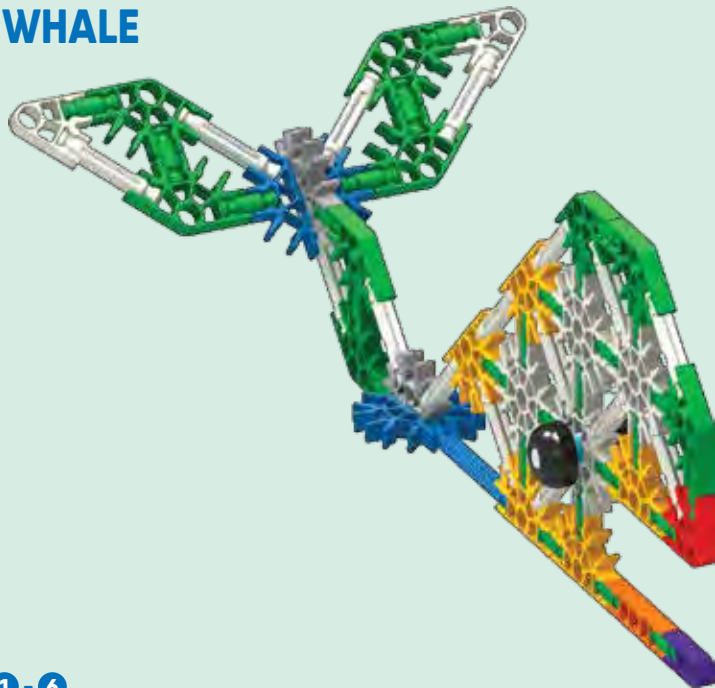

1 - 6

WINDMILL



- 2
- 2
- 4
- 8
- 6
- 8

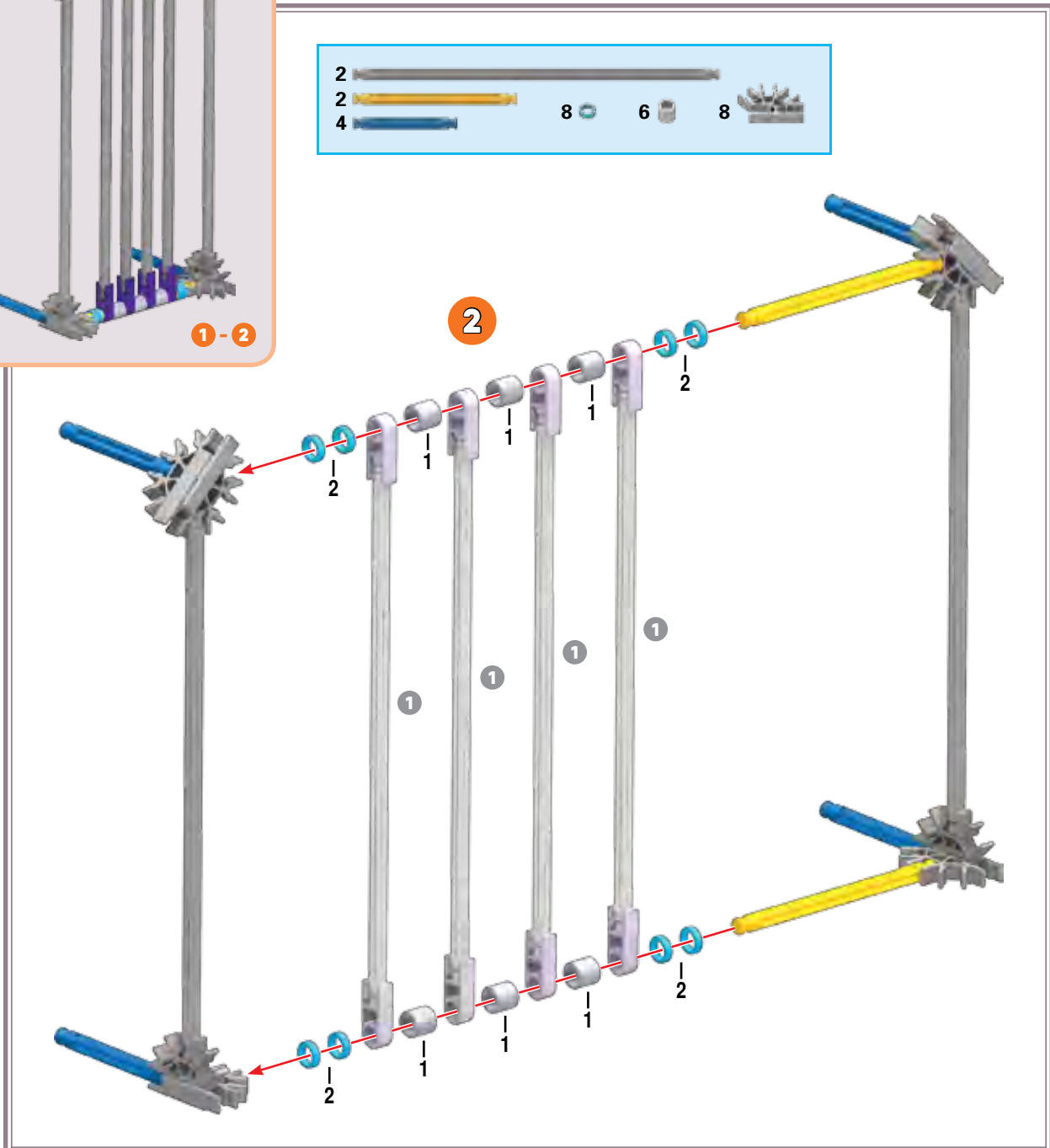
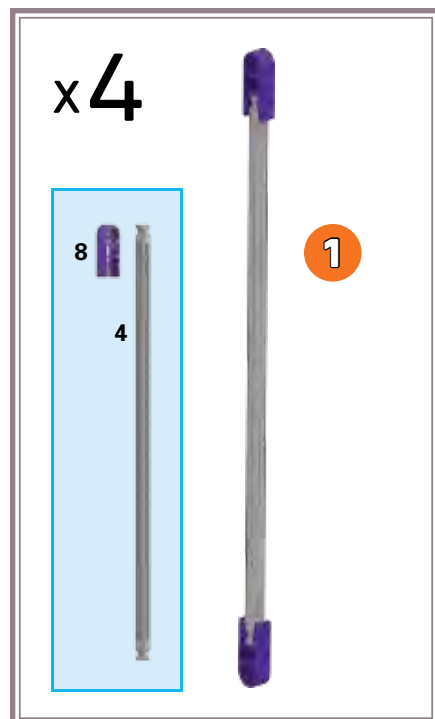

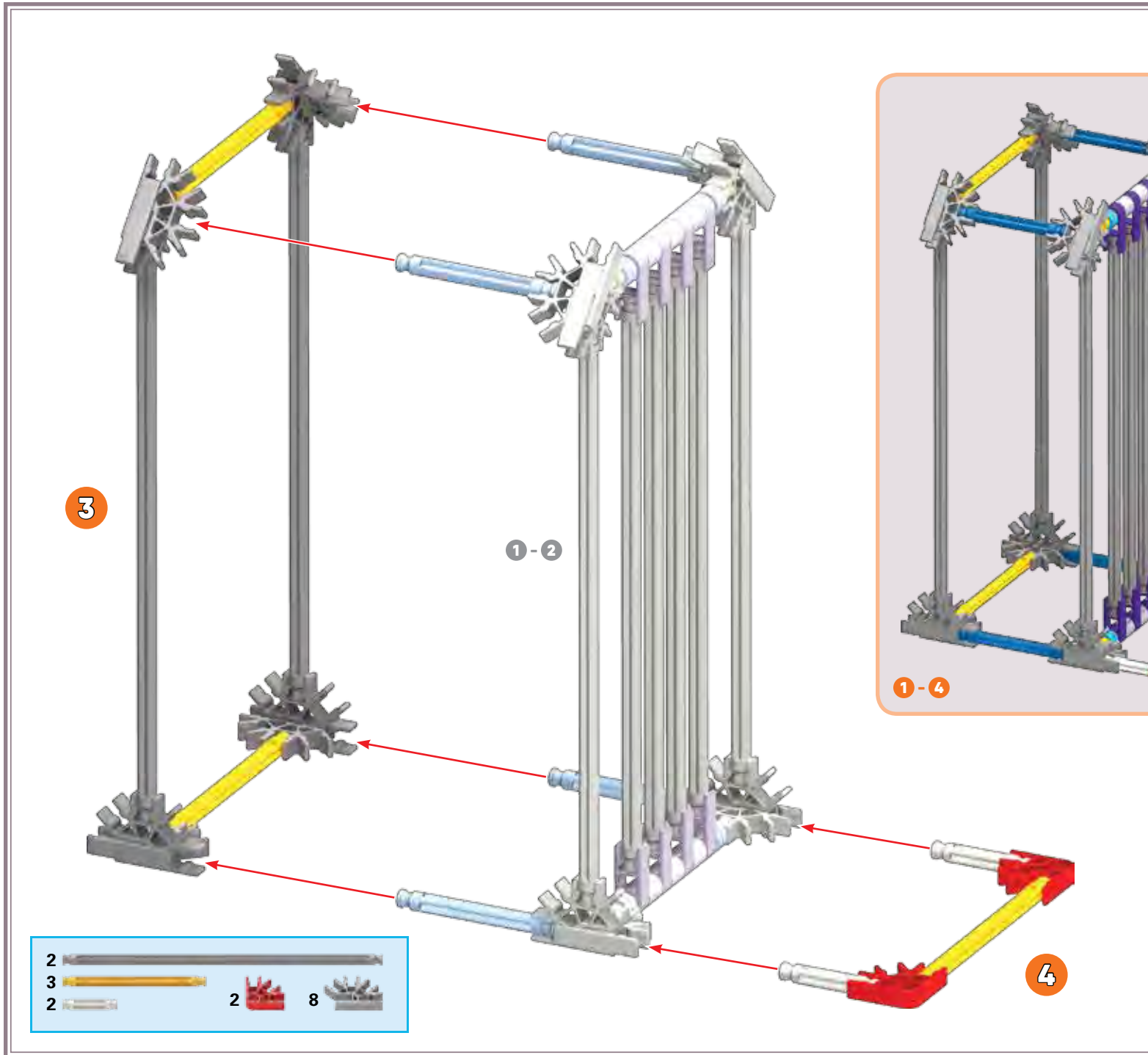

3

1 - 2

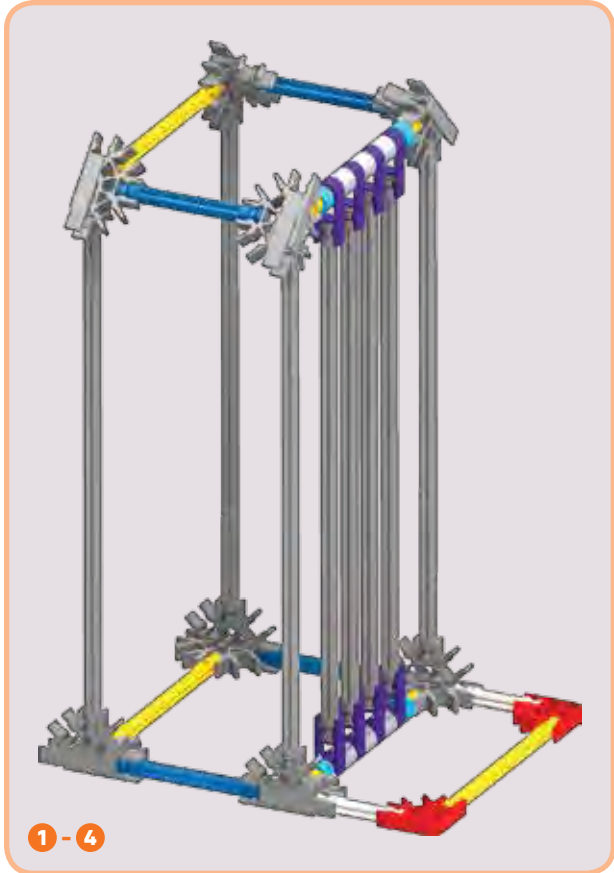

1 - 4

4

- 2
- 3
- 2
- 2
- 8

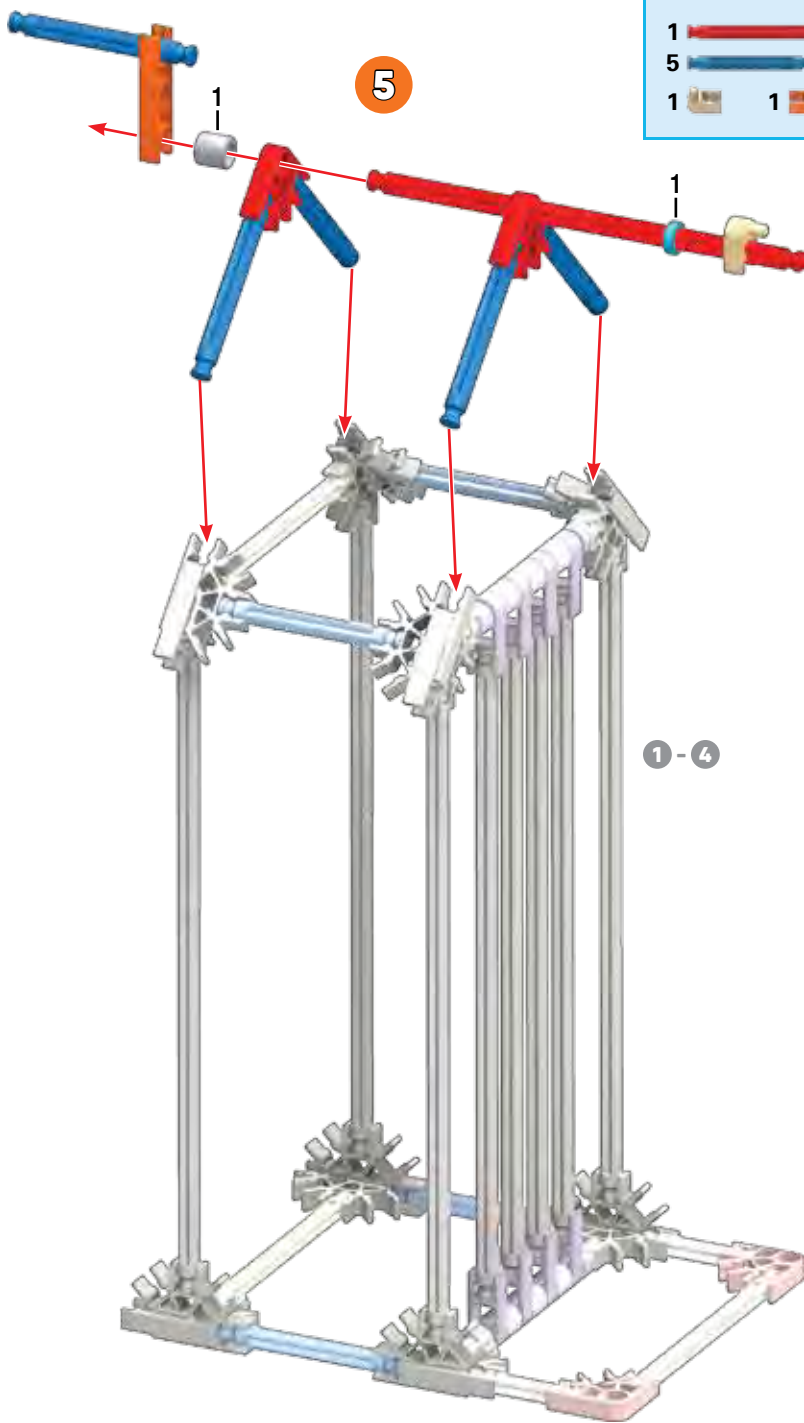

- | | | | |
|---|--|---|--|
| 1 | | 1 | |
| 5 | | 1 | |
| 1 | | 1 | |
| | | 2 | |
| | | 1 | |

1-4

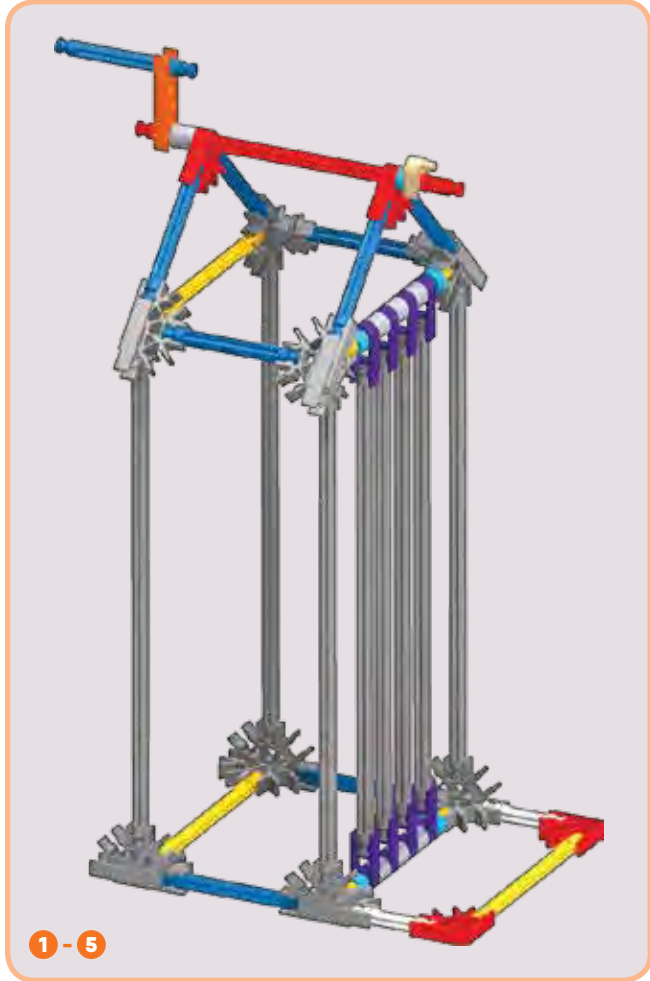

1-5

- | | | | |
|----|--|----|--|
| 16 | | 12 | |
| 4 | | 4 | |
| 8 | | 1 | |

6

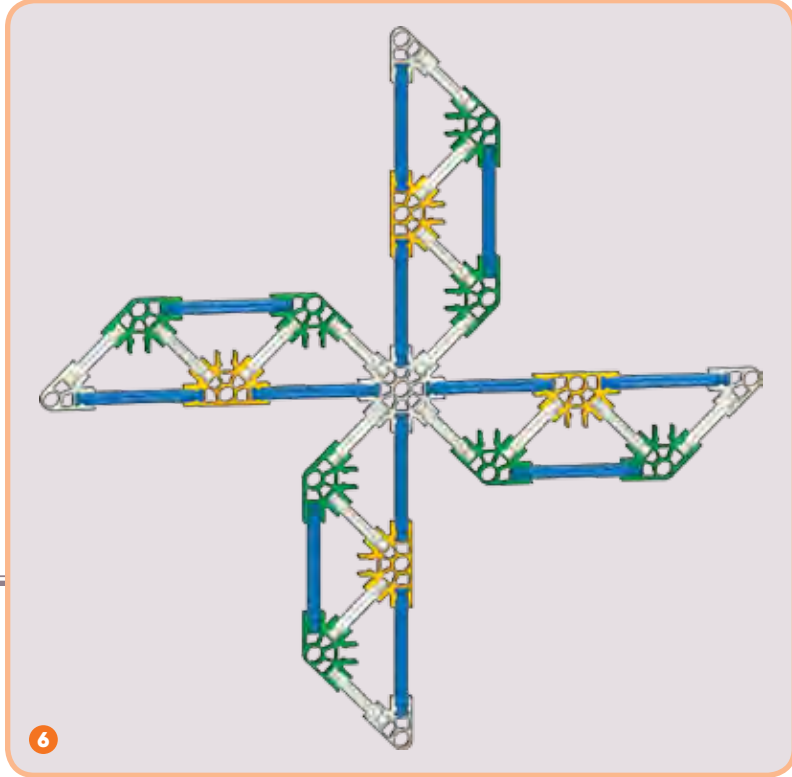
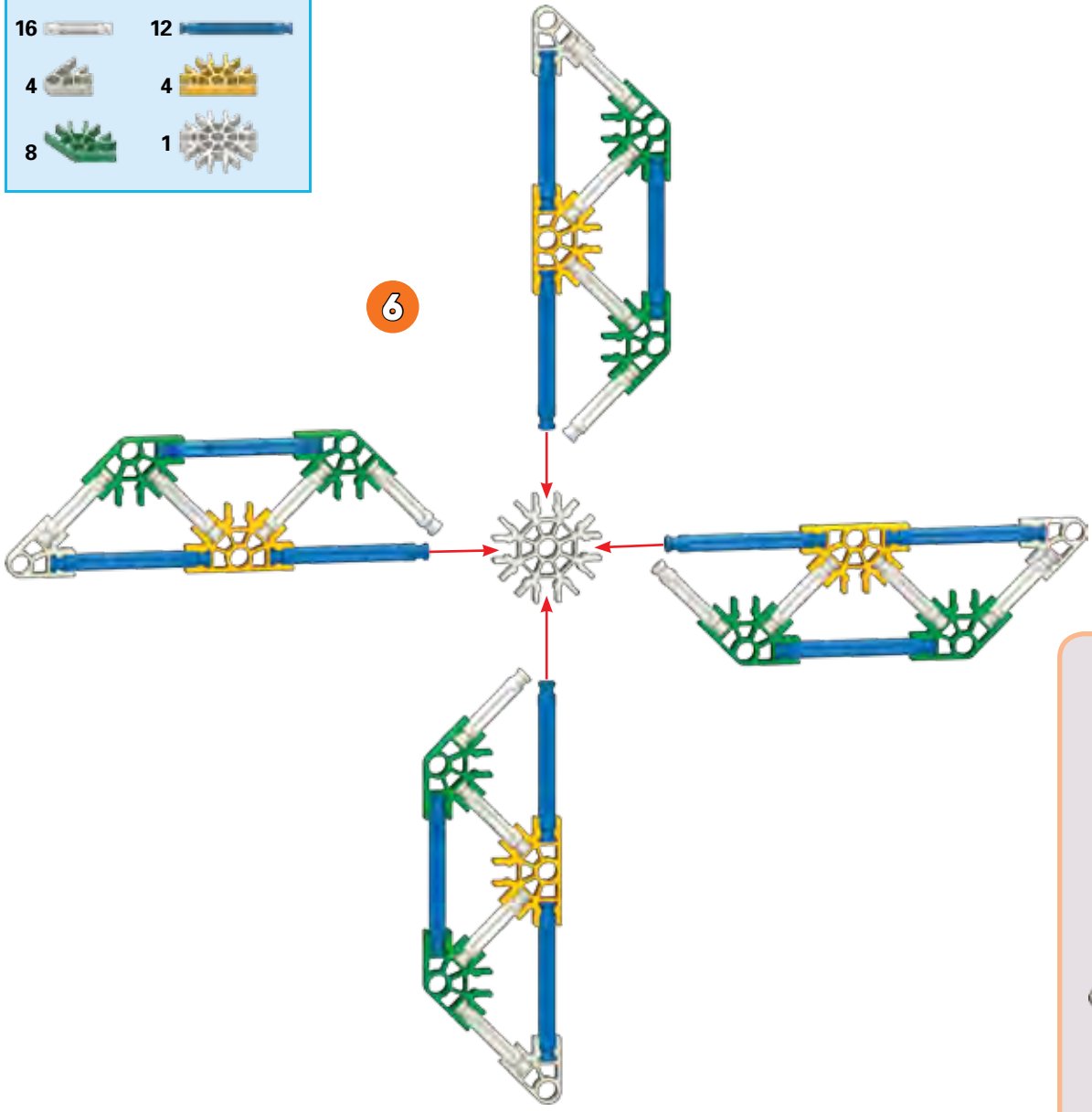

6

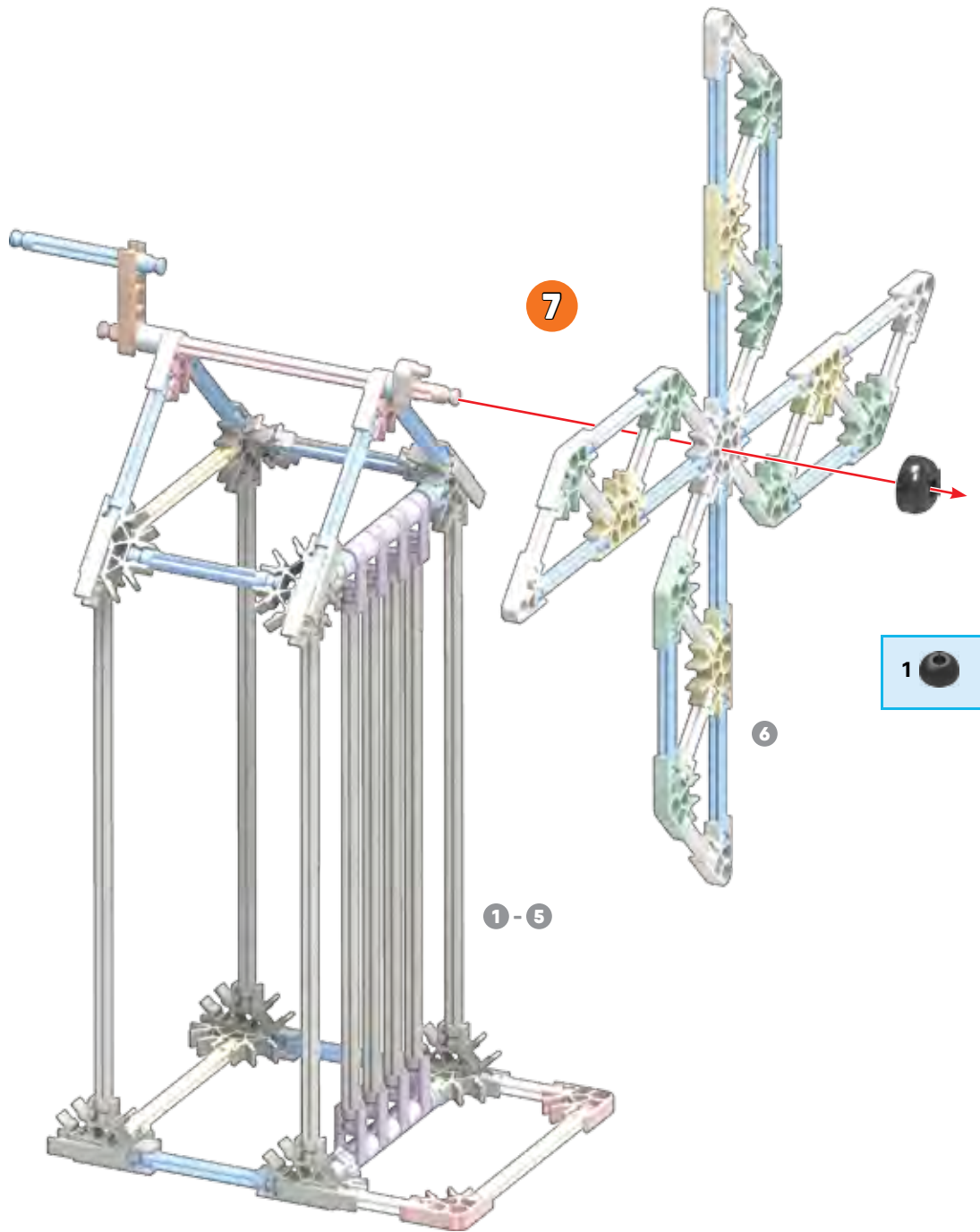

WINDMILL

