

3 Wheeler

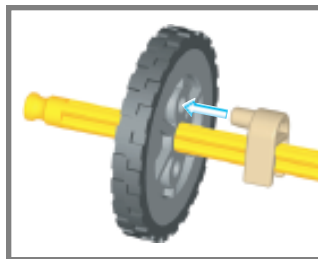

Boat Ride

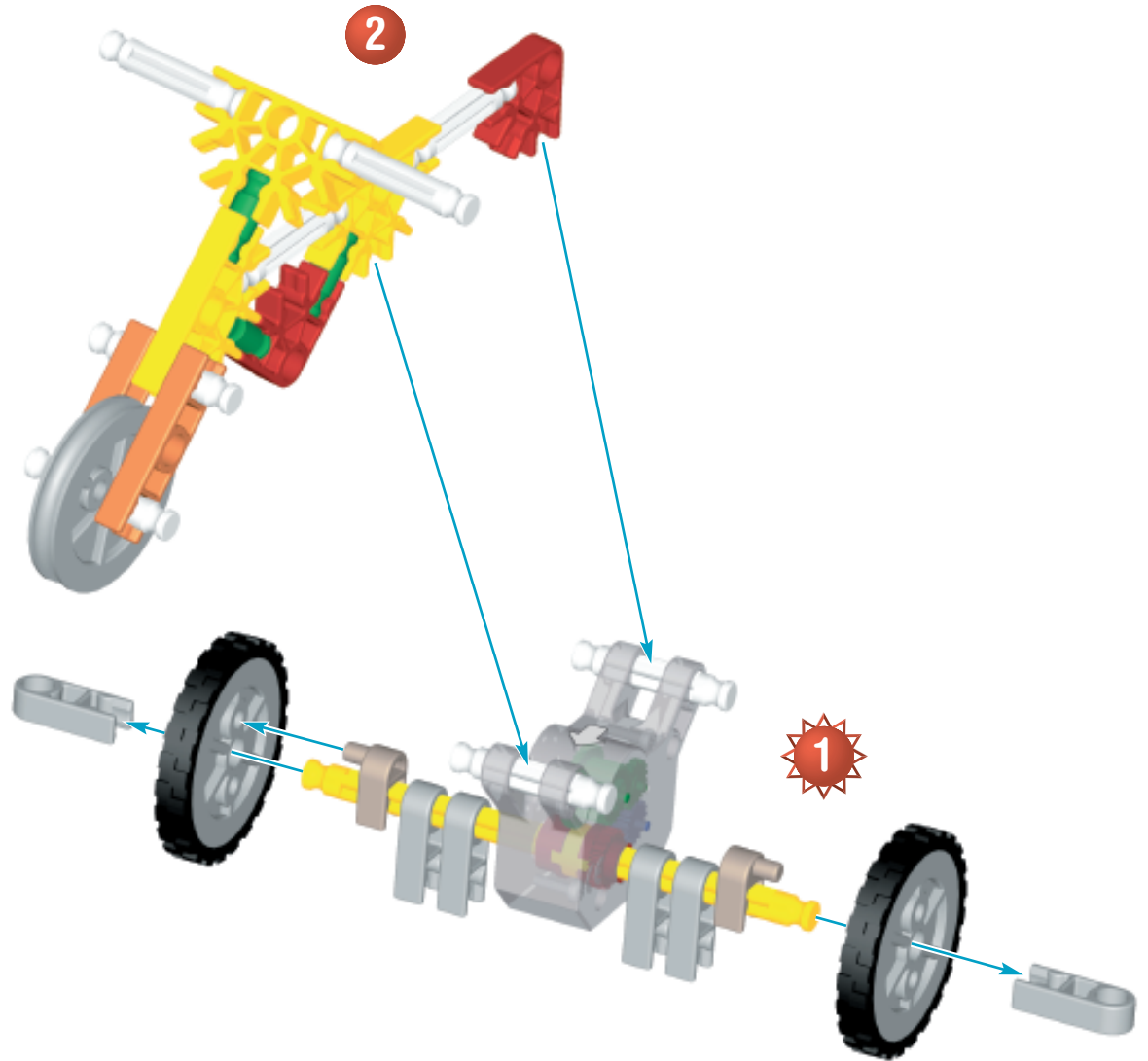

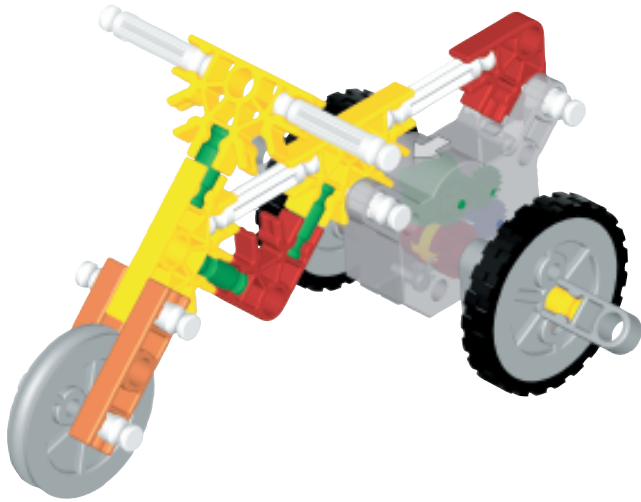
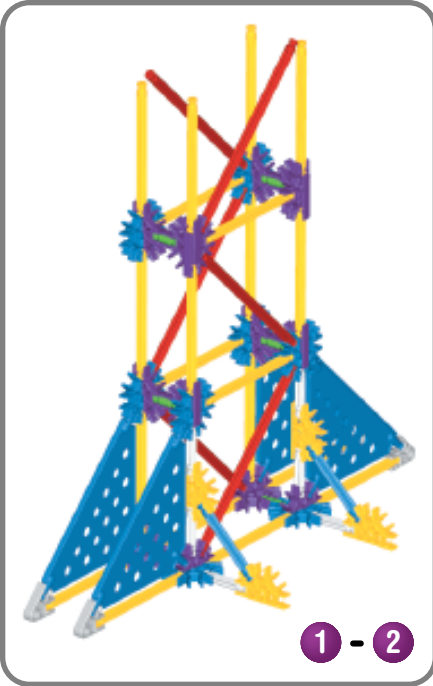
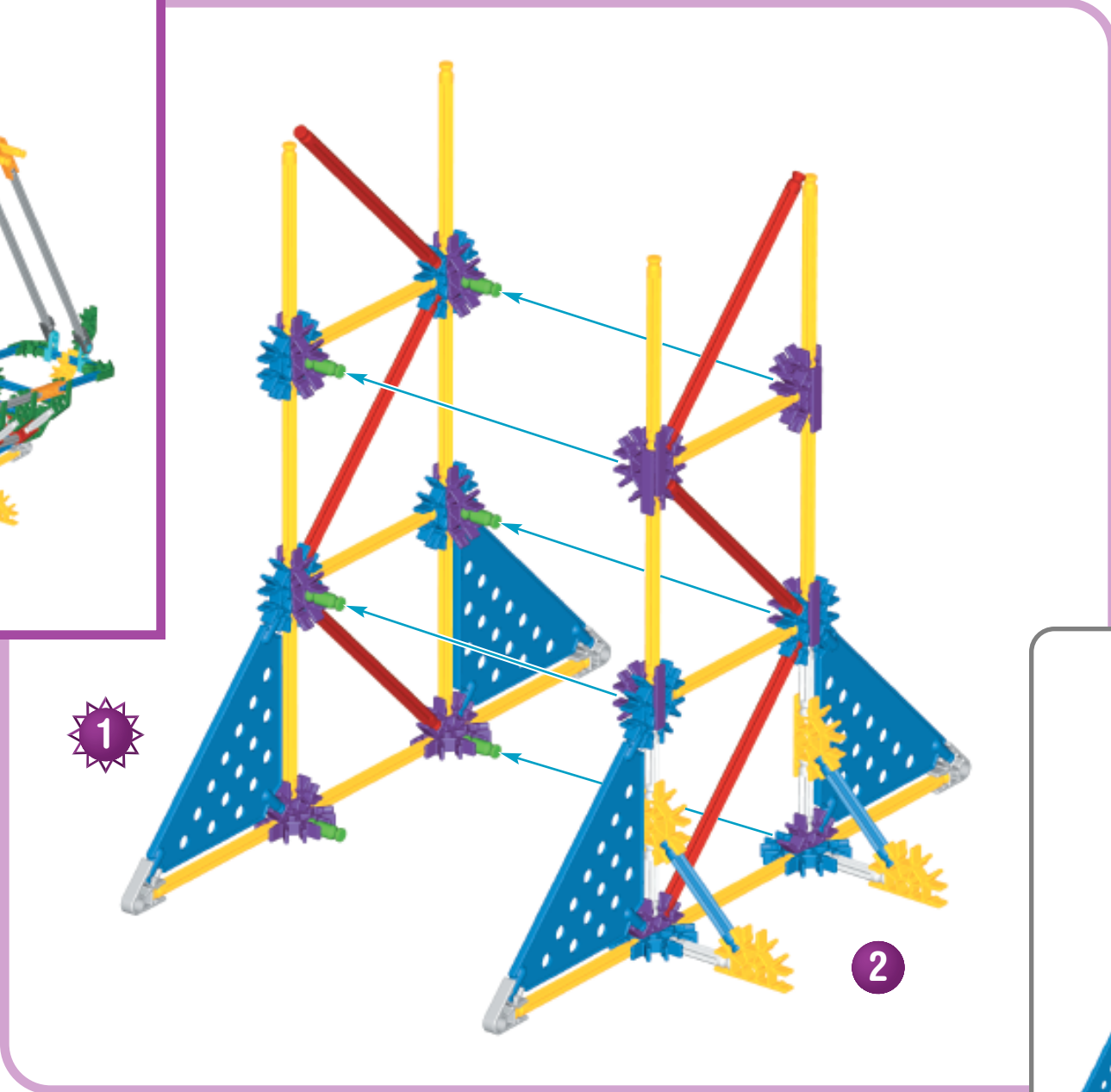
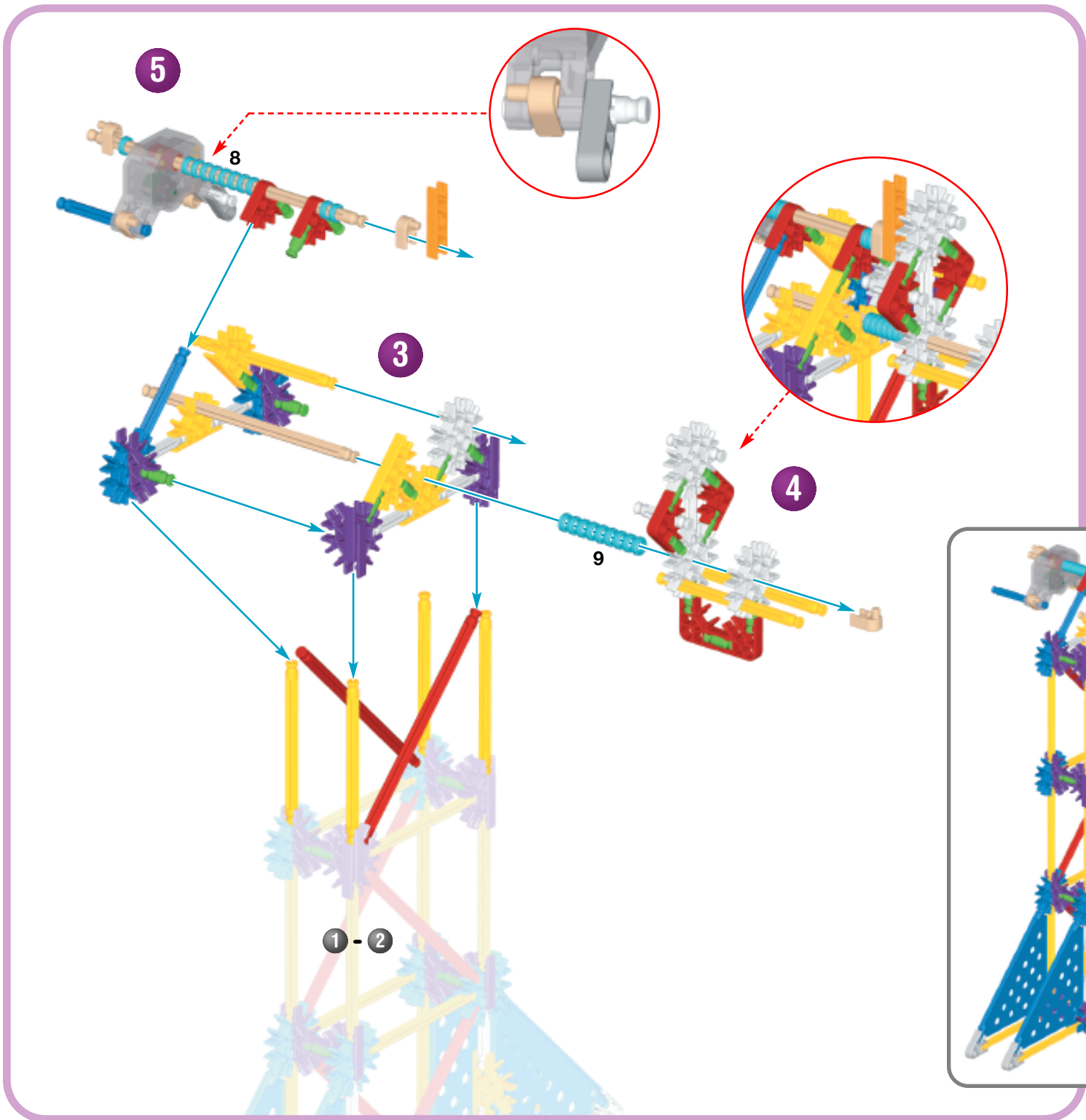

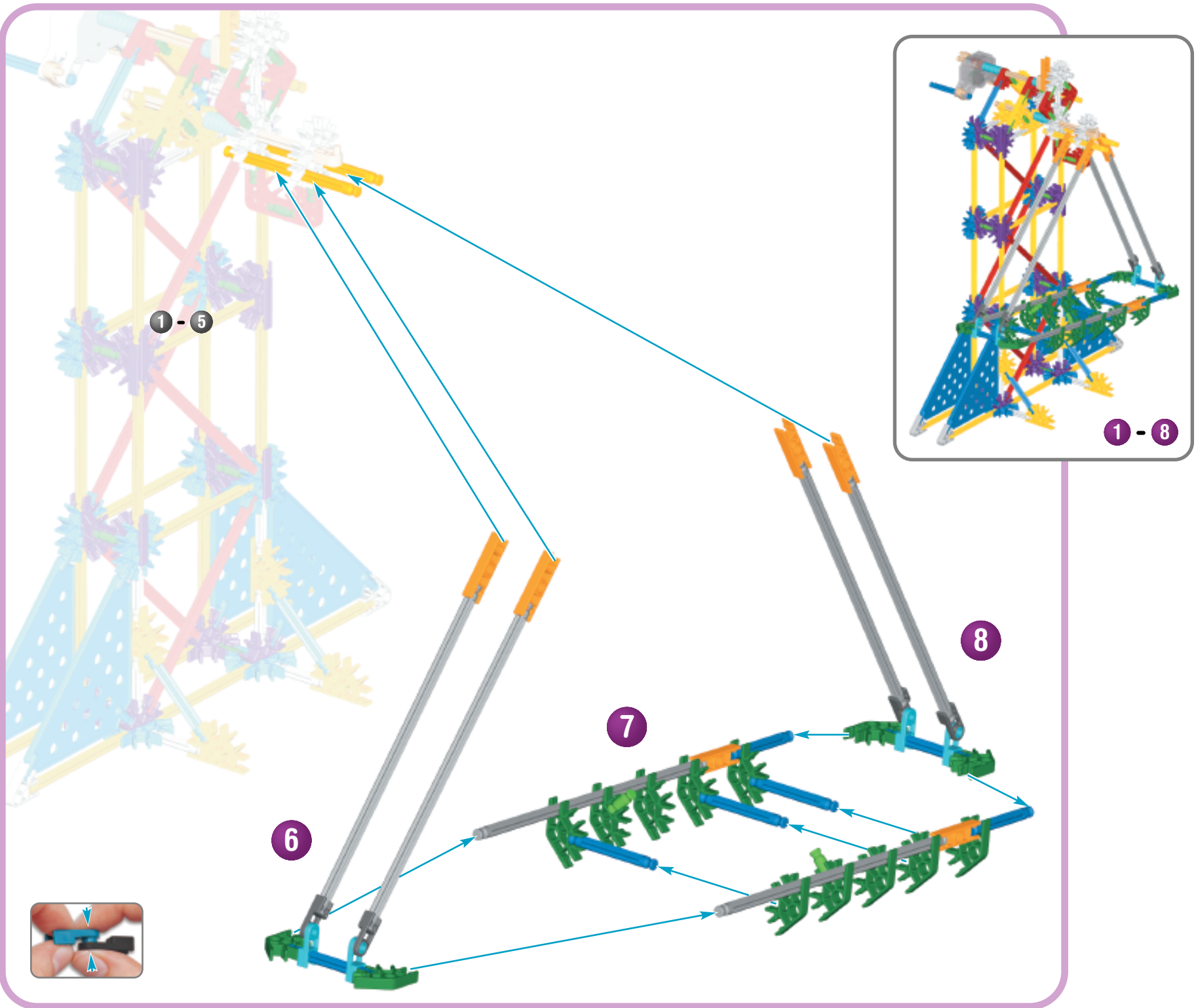

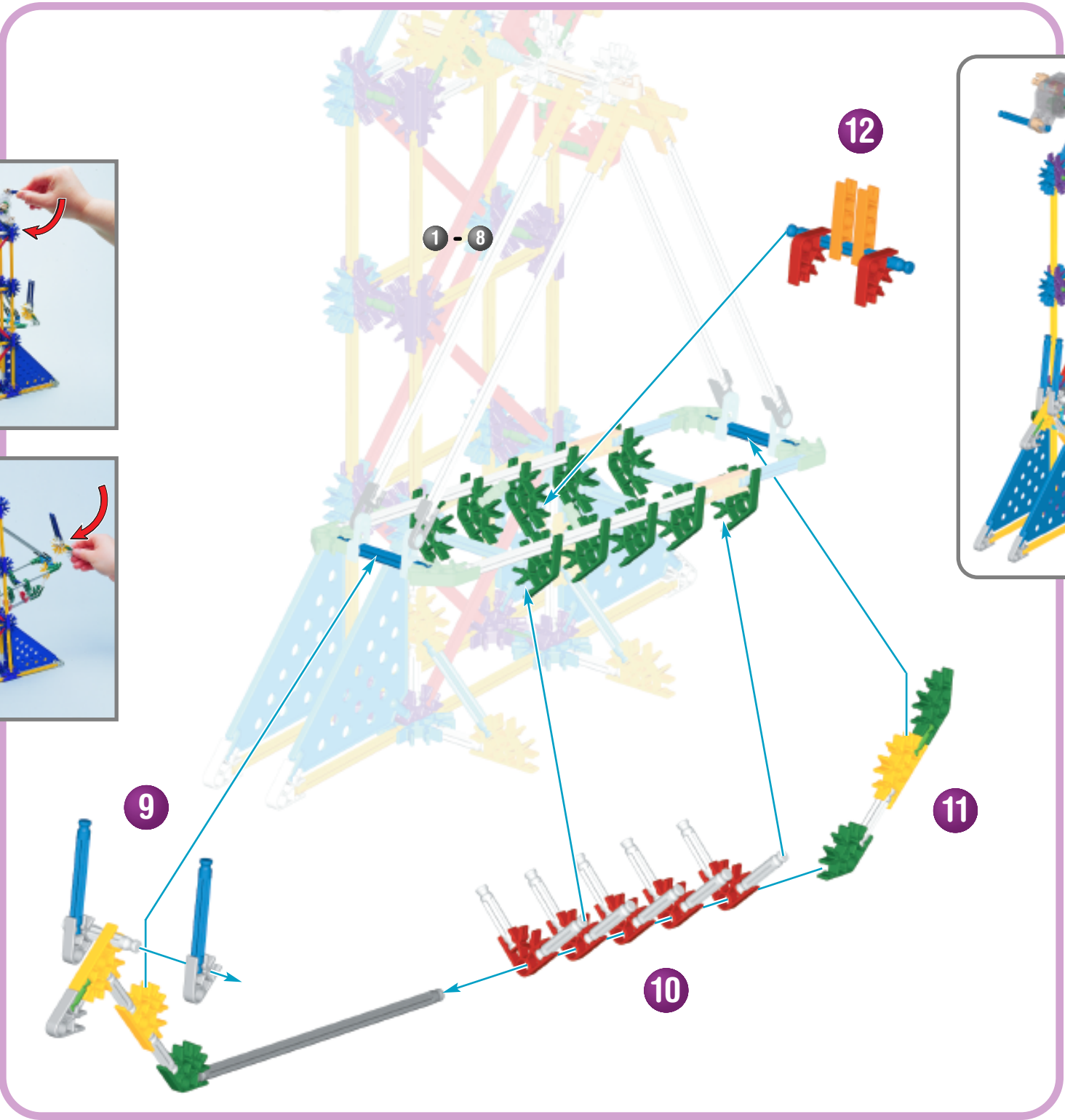

Catamaran

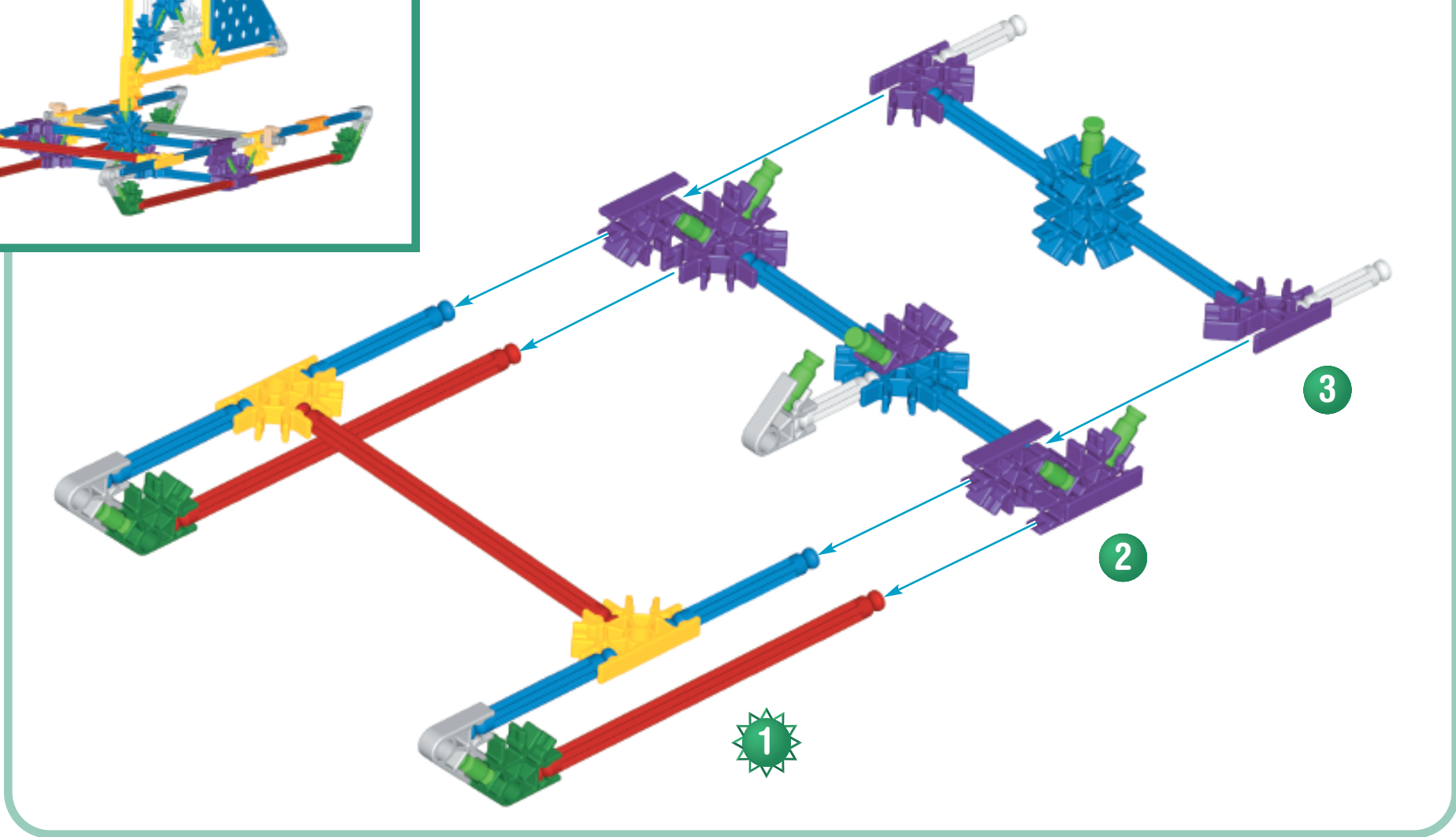
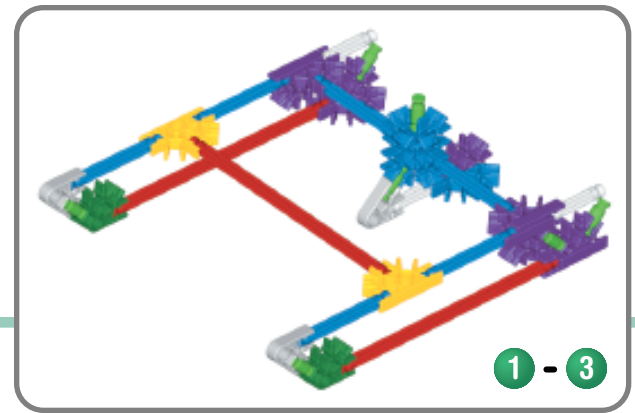

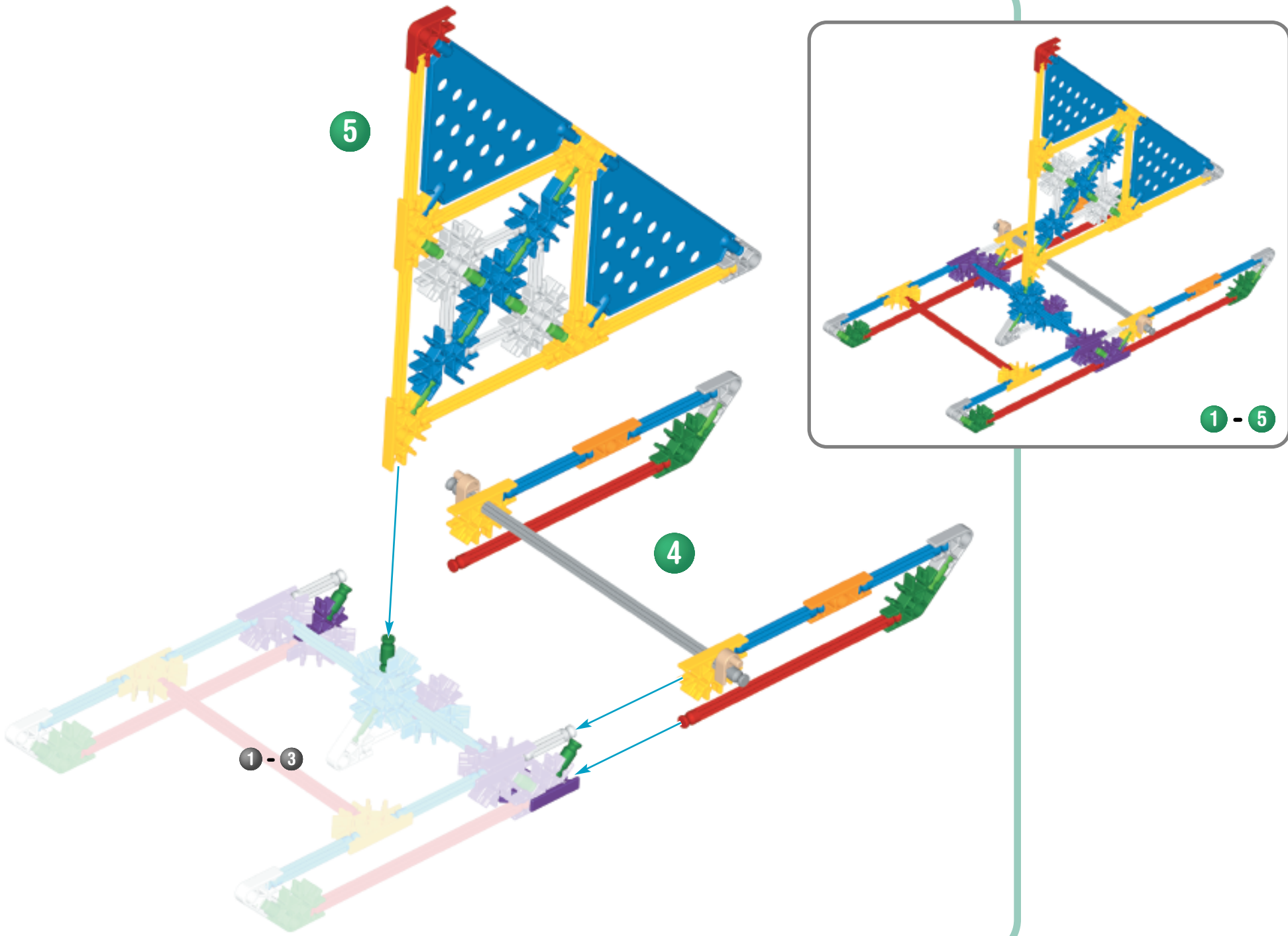

CD Holder

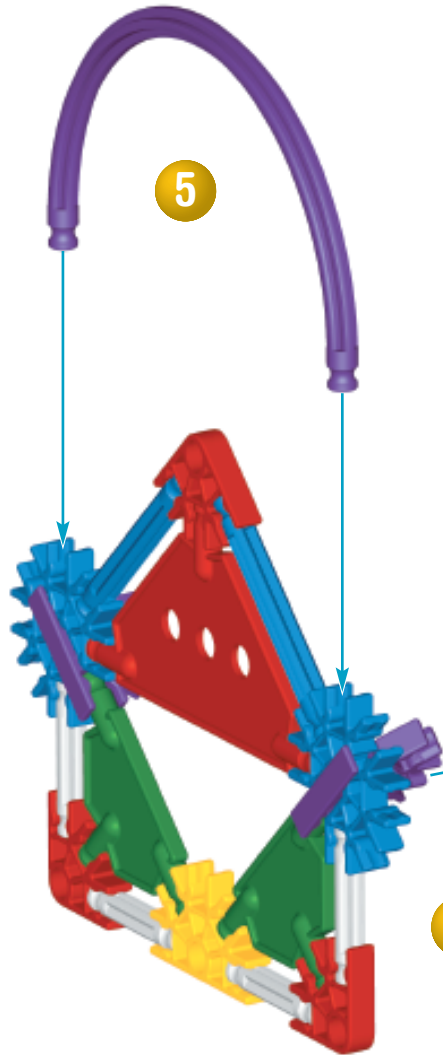
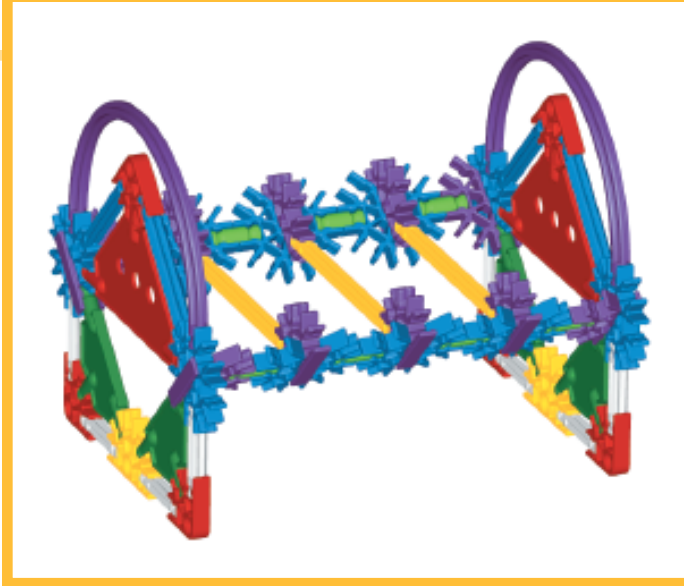

2

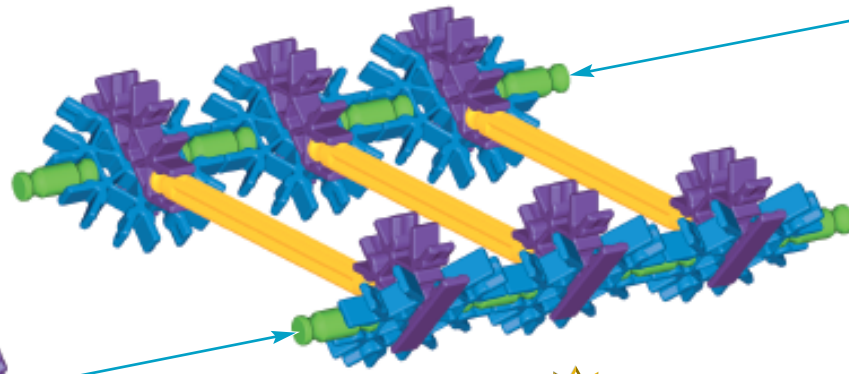

1

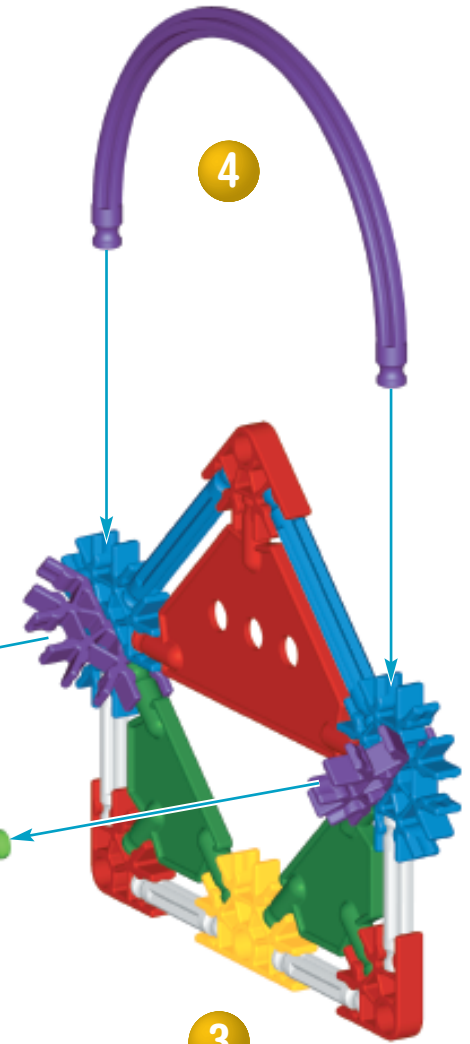

3

Crank Fan

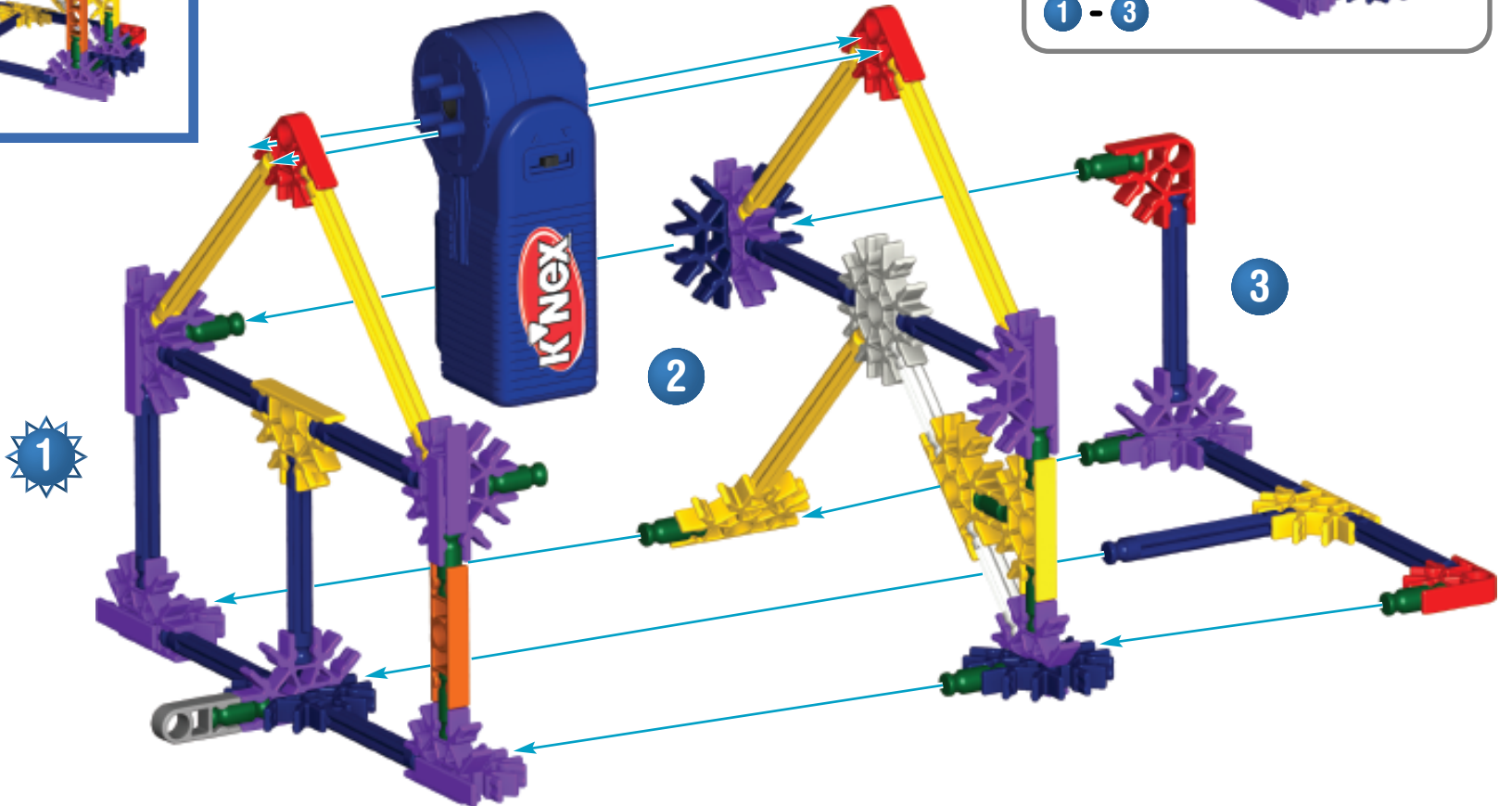
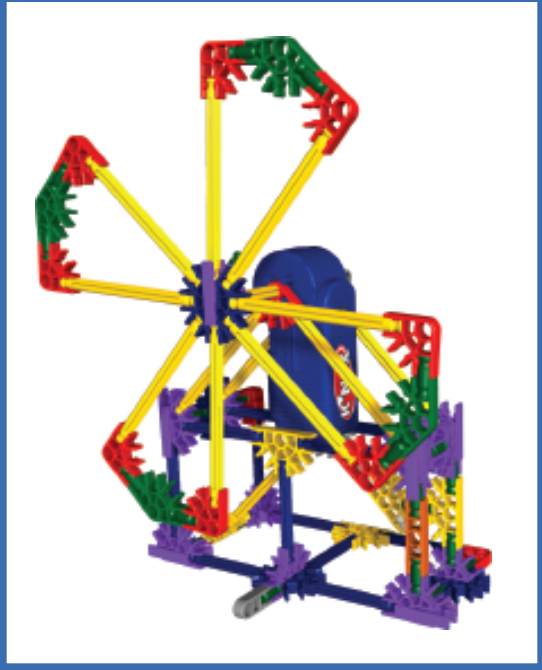

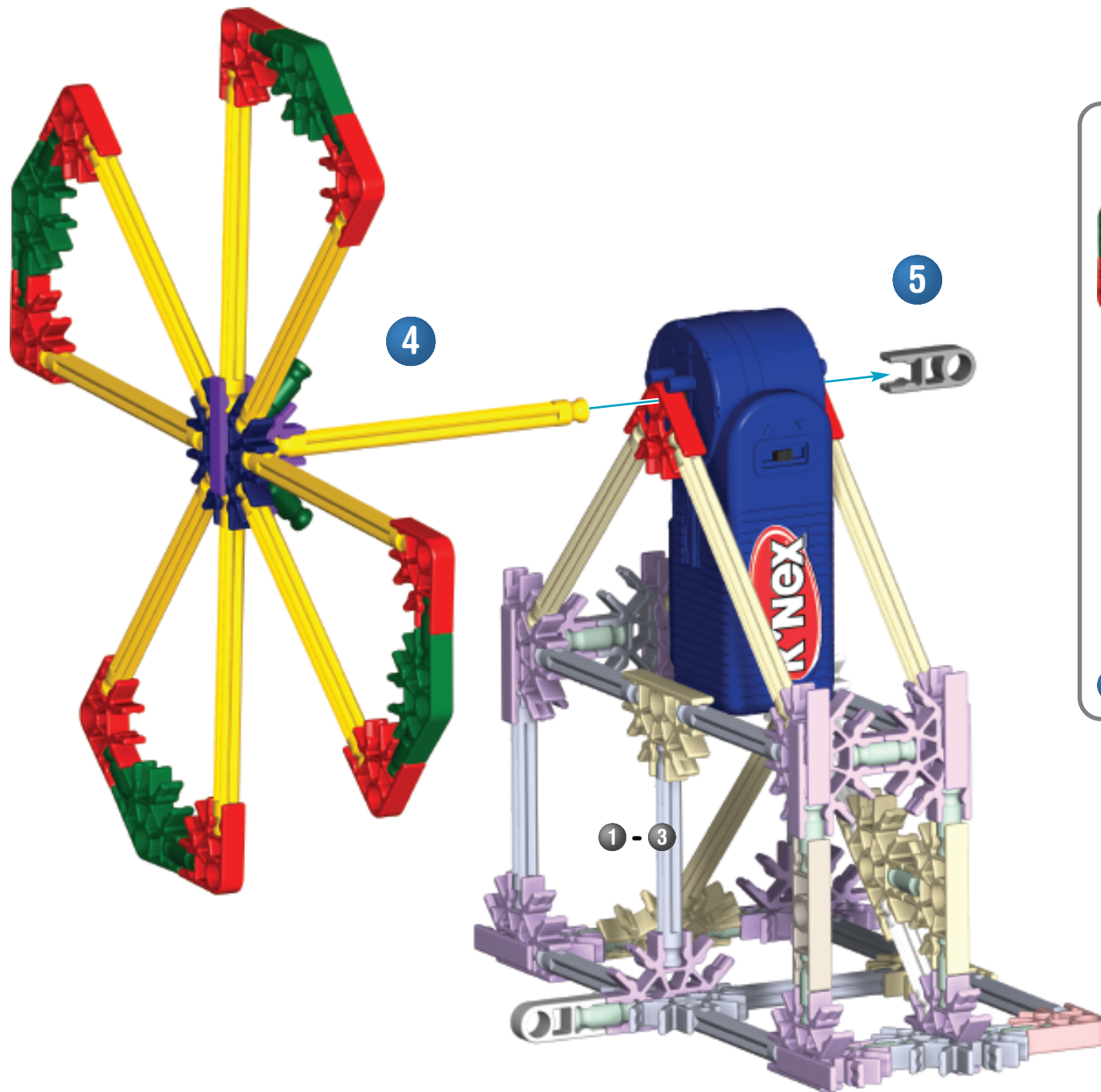

Hockey Stick

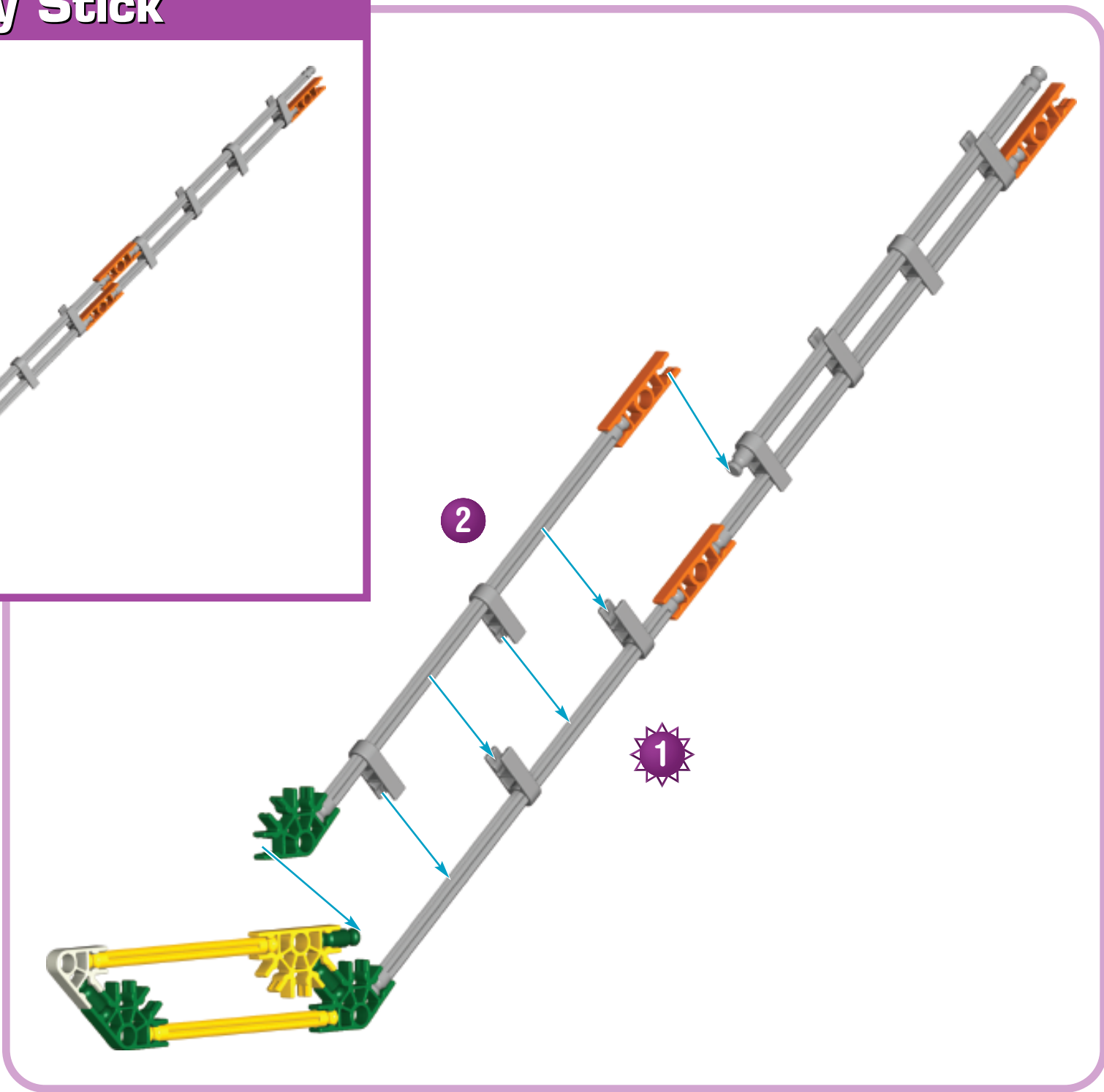
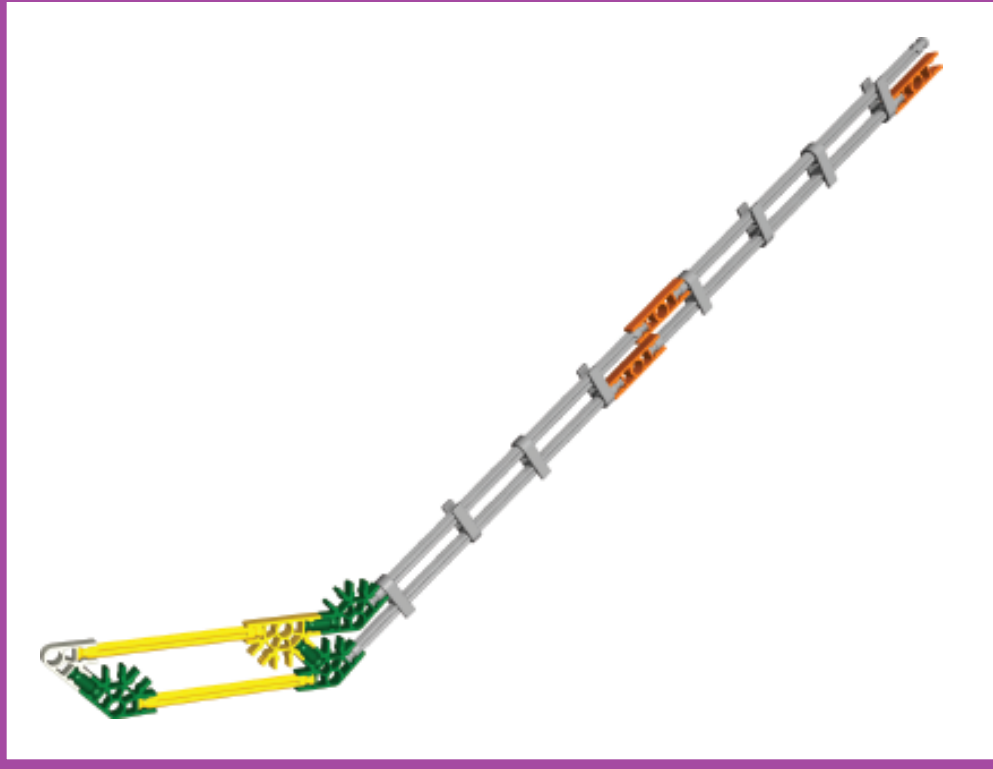

Kart Racer

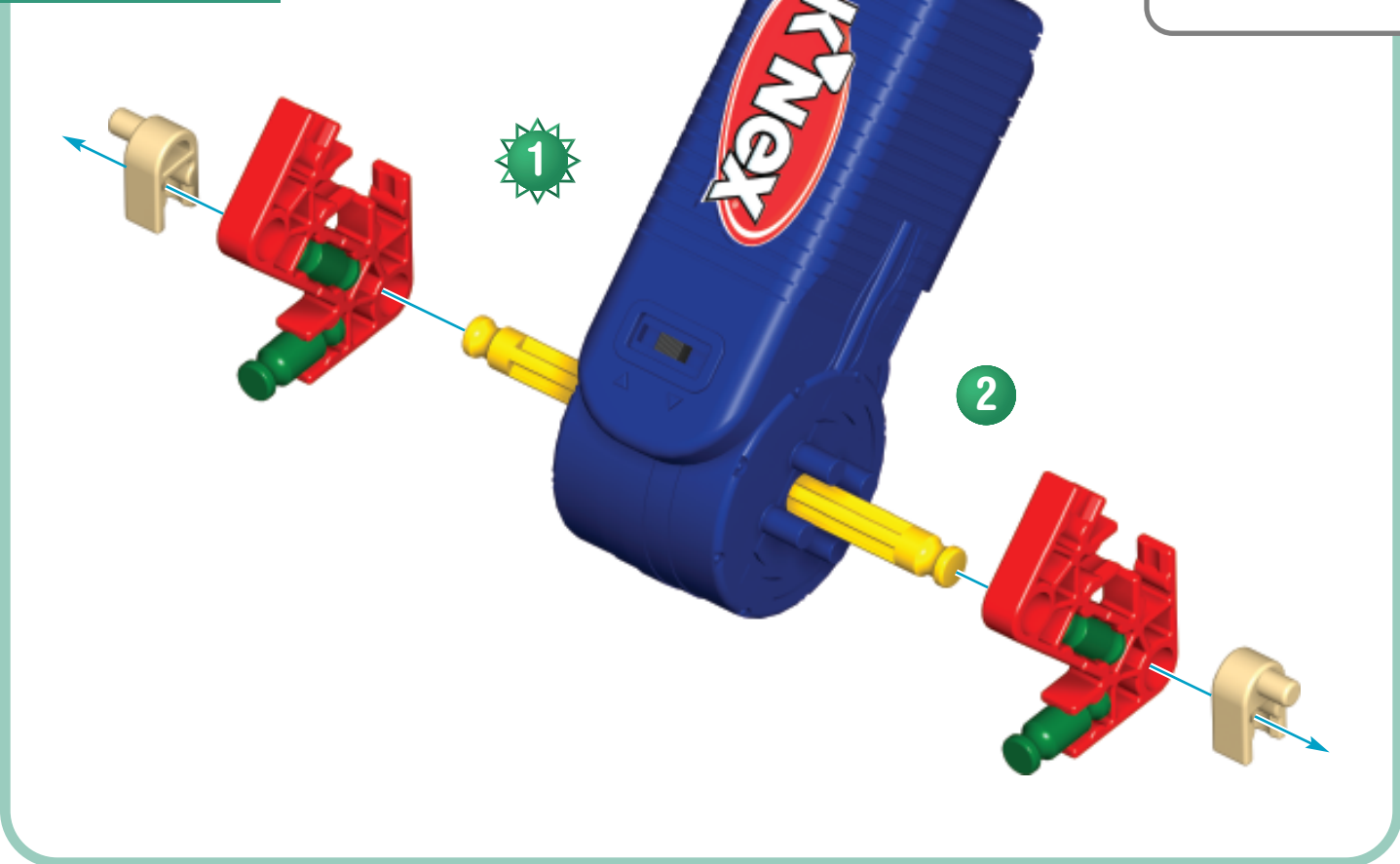

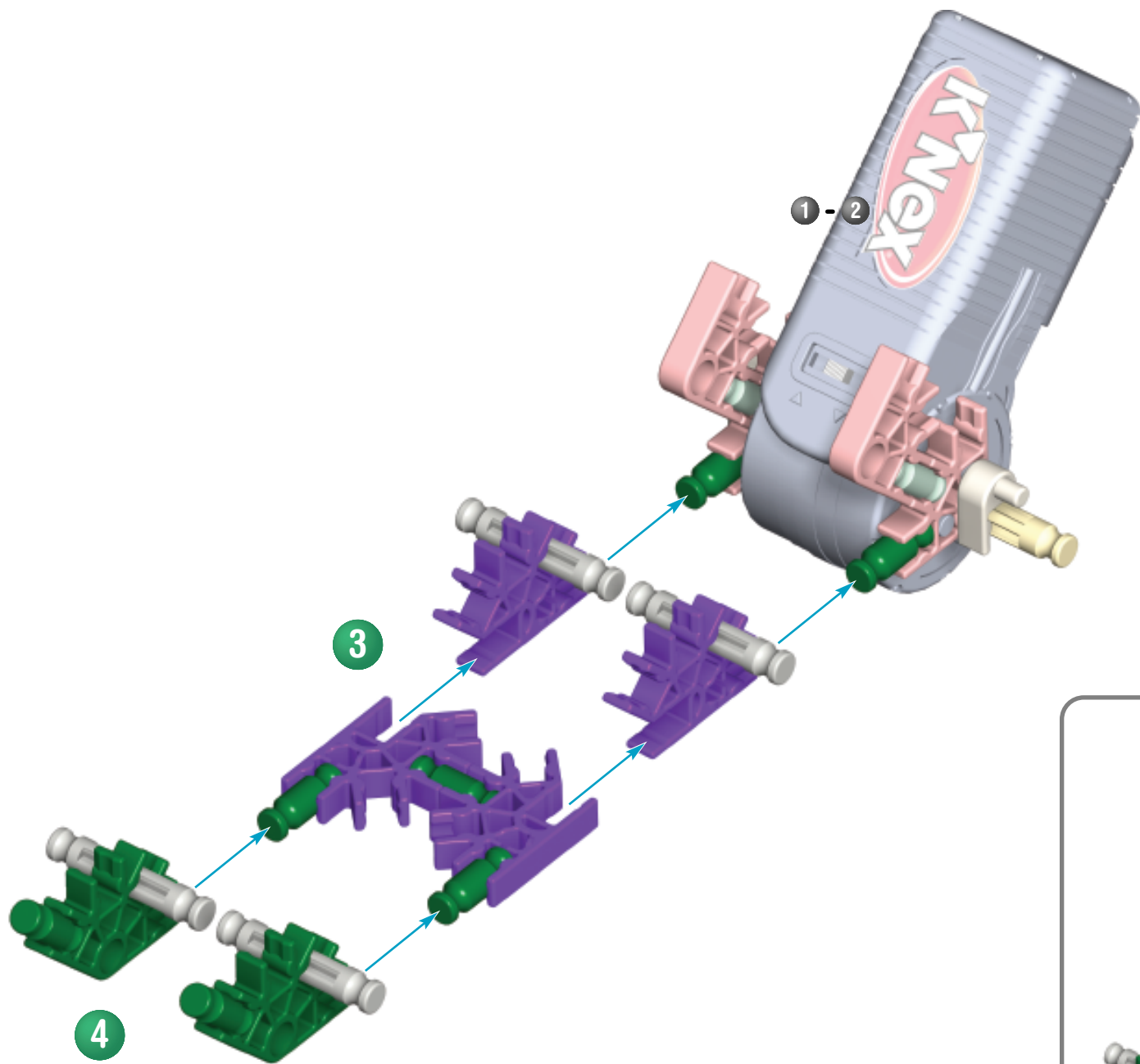

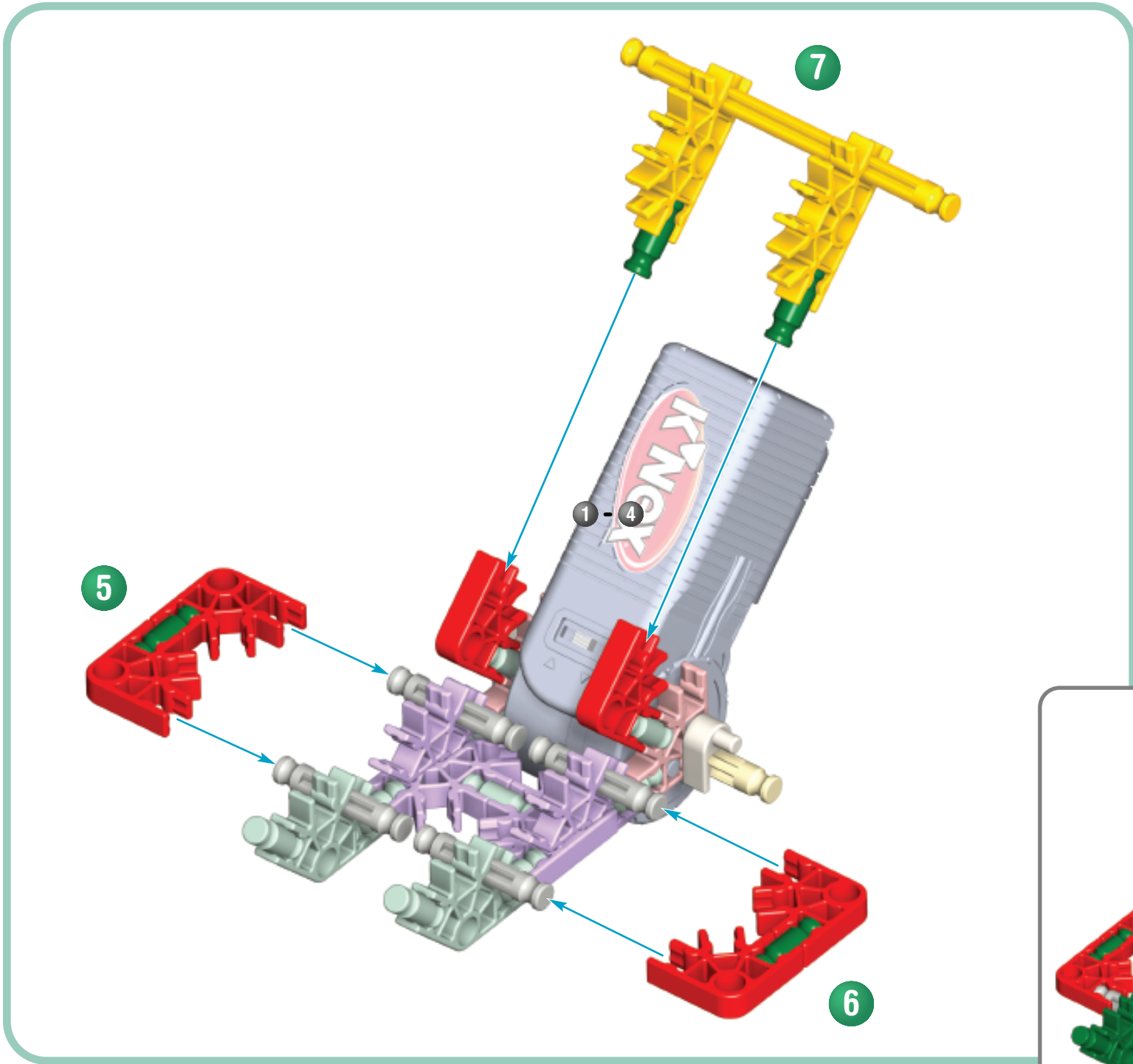

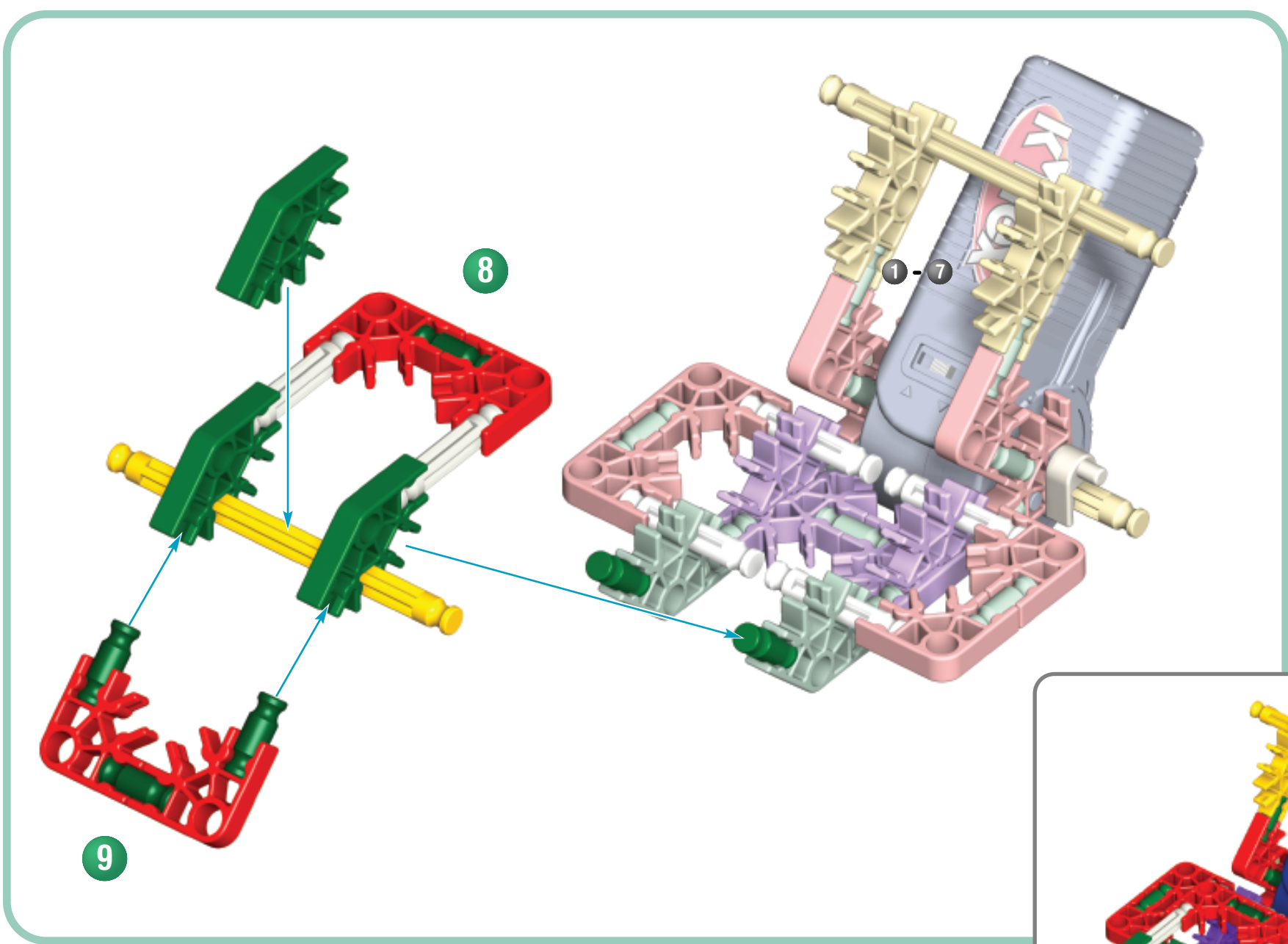

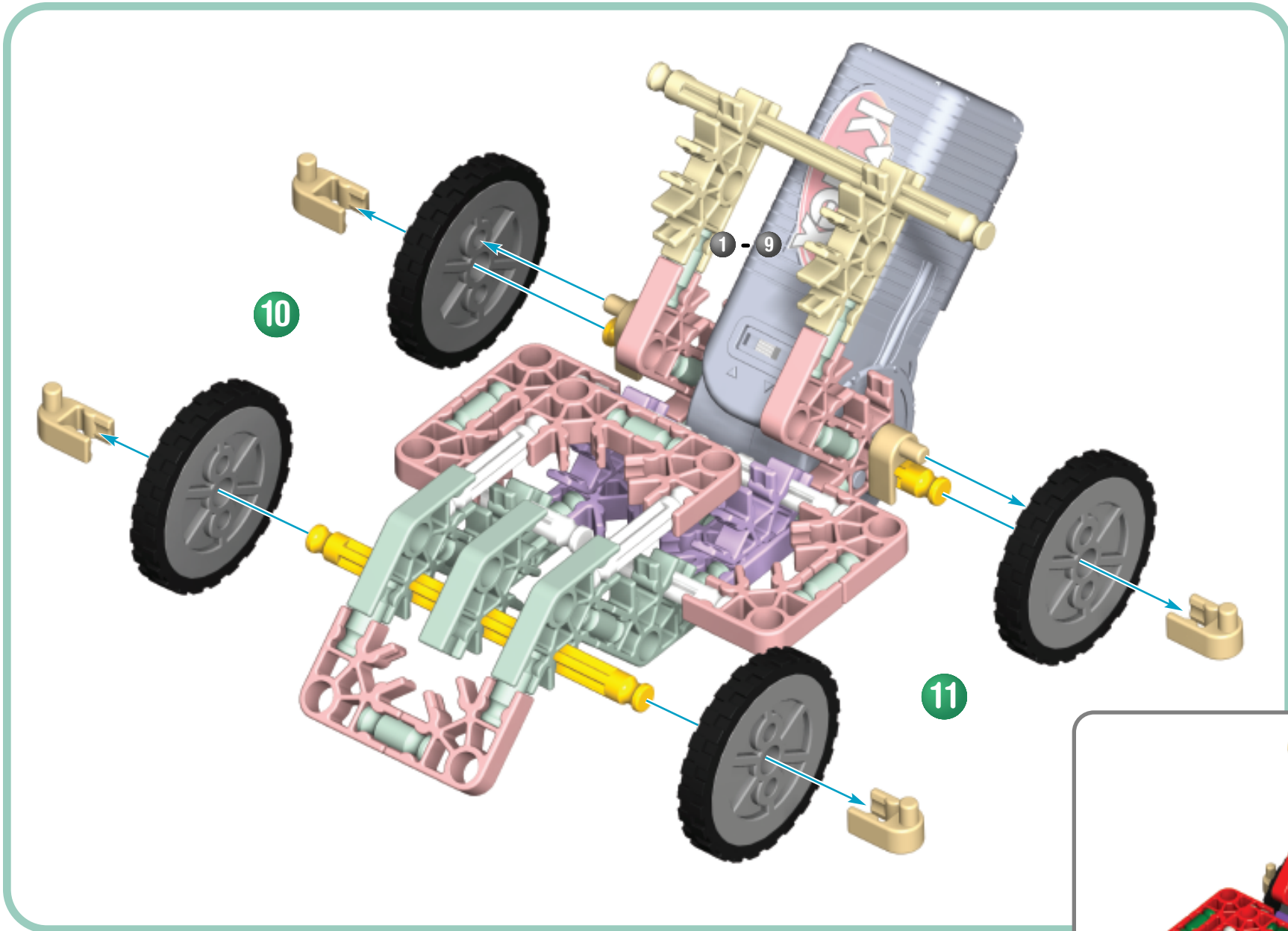

Low Rider

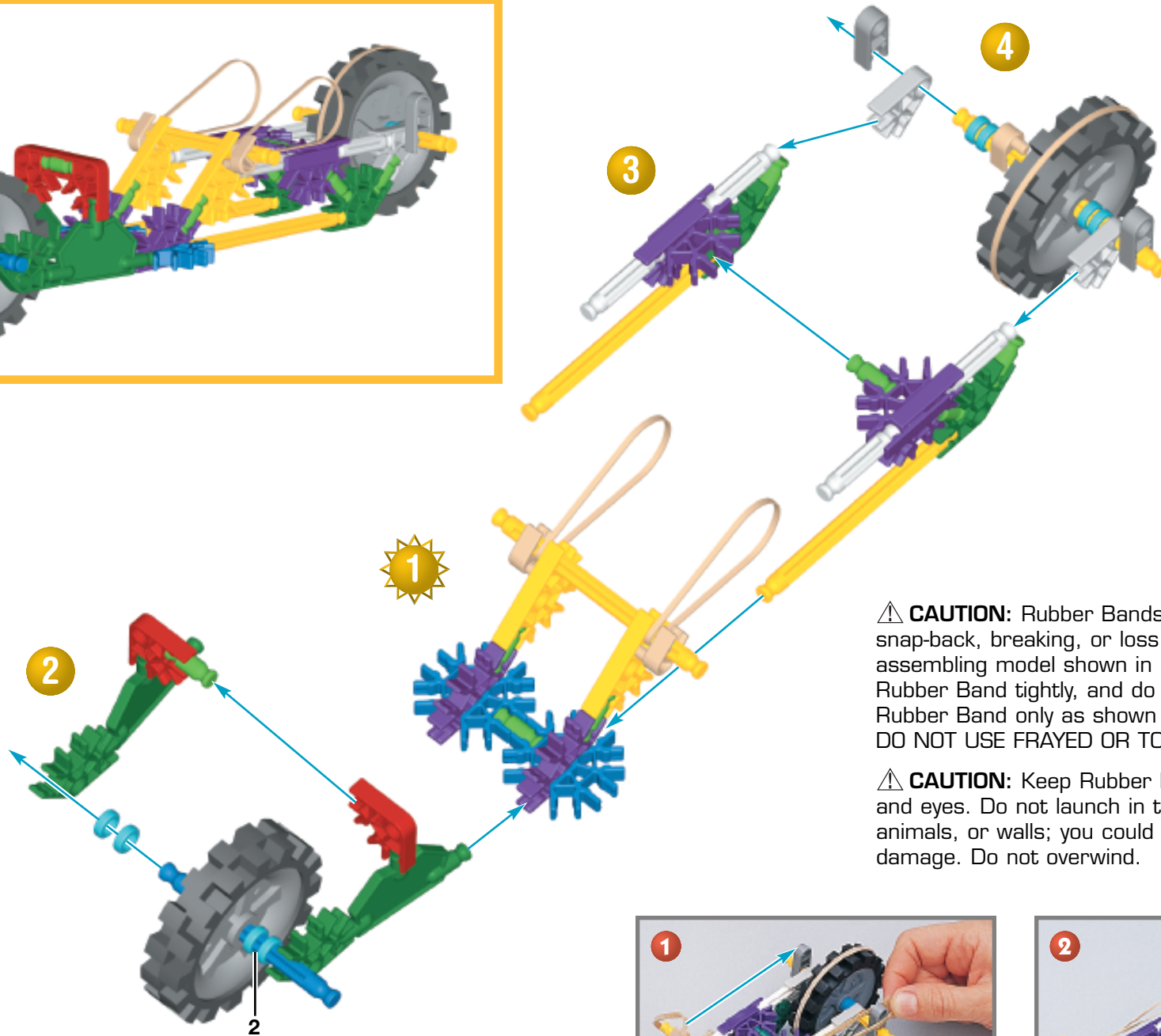

⚠ CAUTION: Rubber Bands can cause injury from snap-back, breaking, or loss of control. While assembling model shown in instructions, hold Rubber Band tightly, and do not overstretch. Use Rubber Band only as shown in these instructions. DO NOT USE FRAYED OR TORN RUBBER BANDS.

⚠ CAUTION: Keep Rubber Band away from face and eyes. Do not launch in the direction of people, animals, or walls; you could cause injury or damage. Do not overwind.

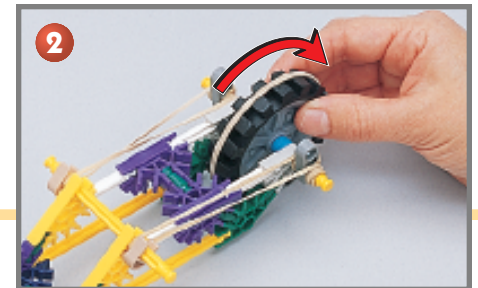
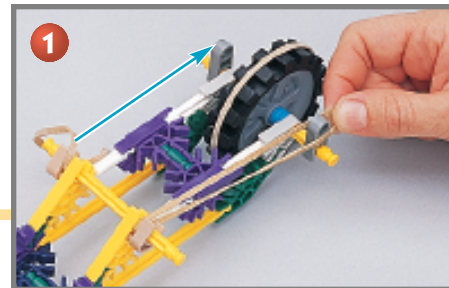

Manta

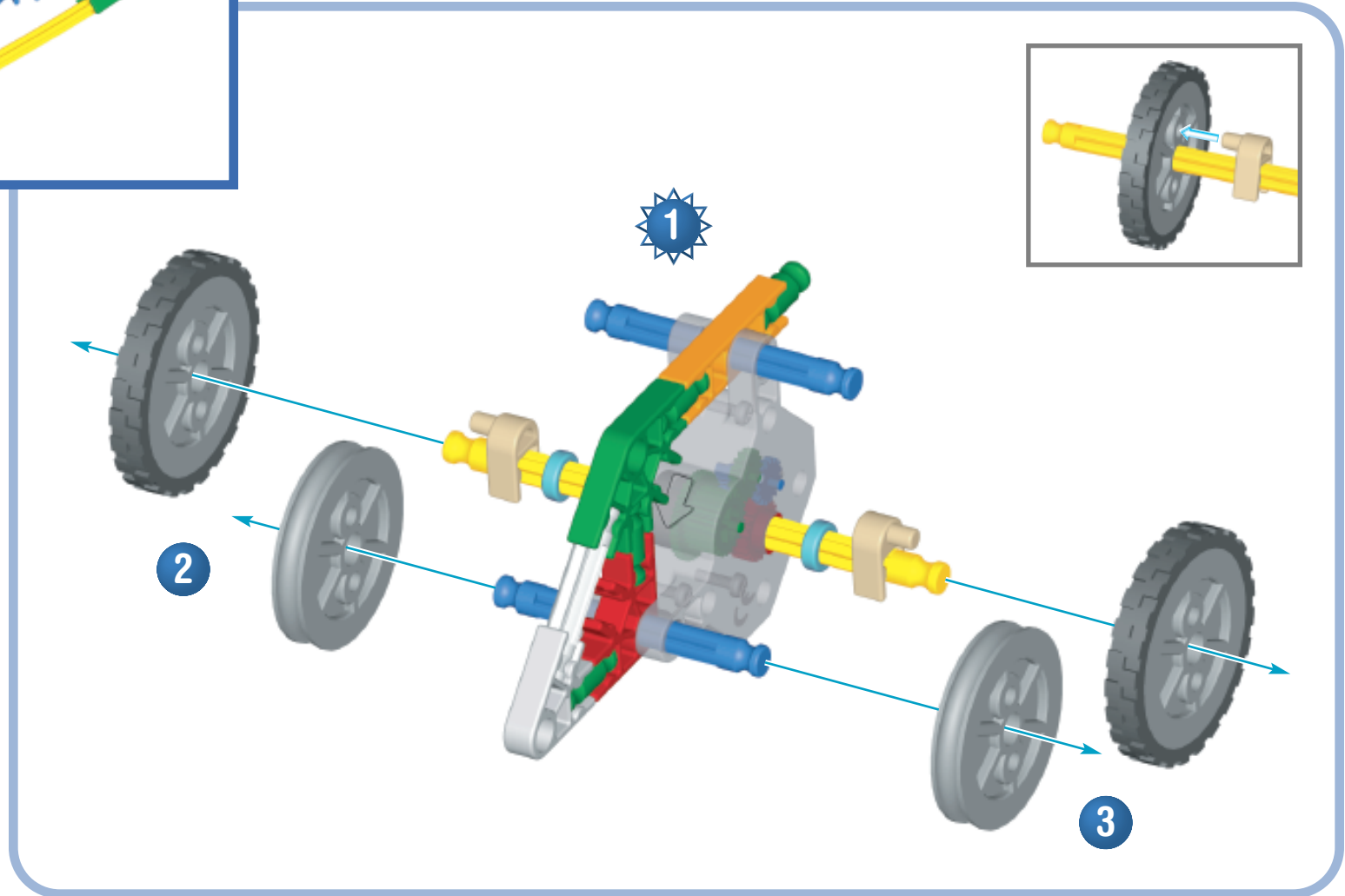
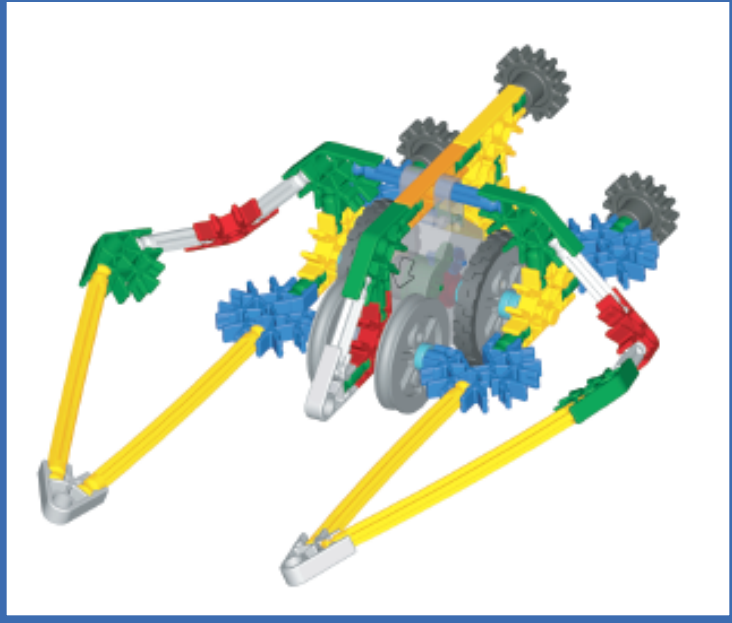

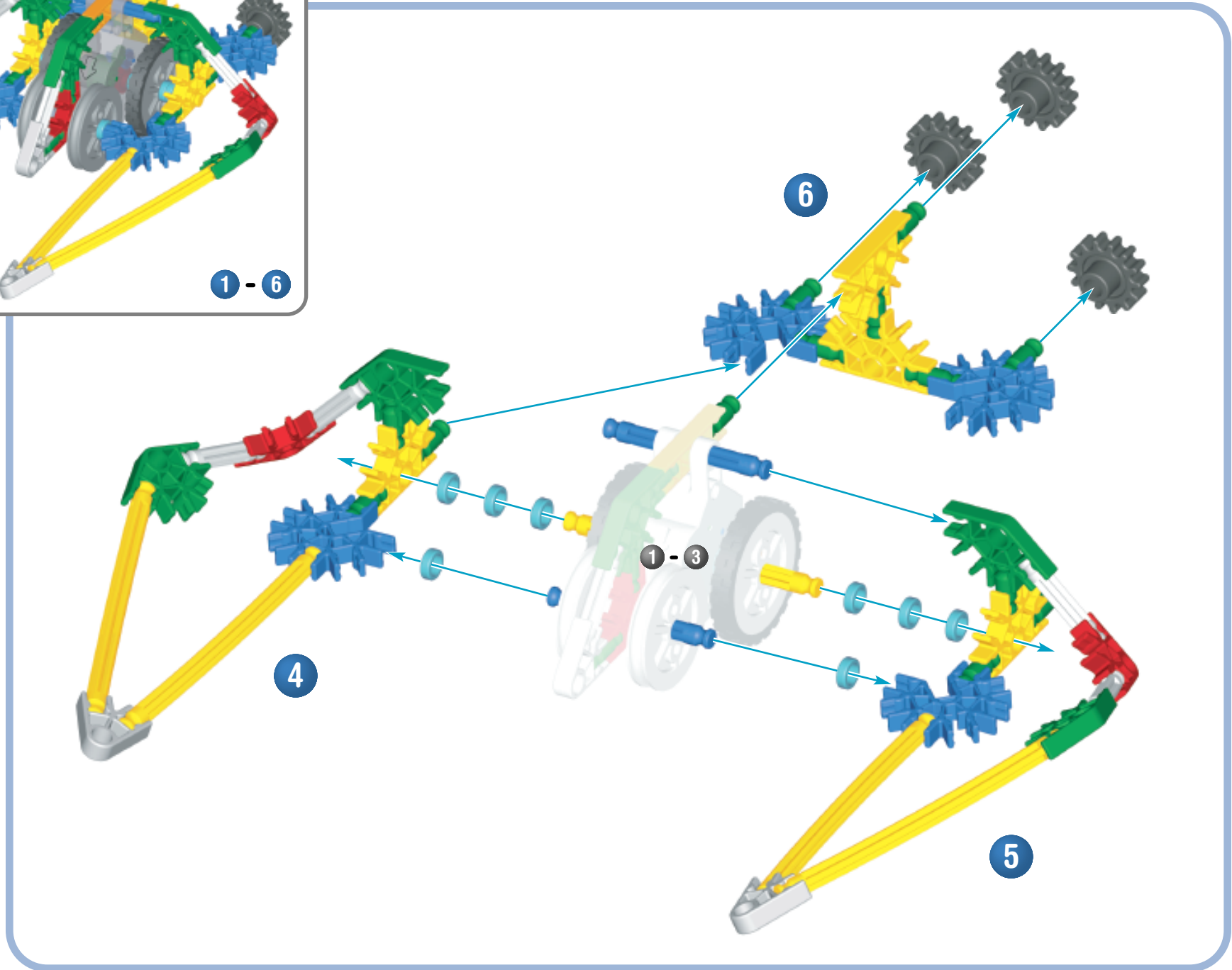
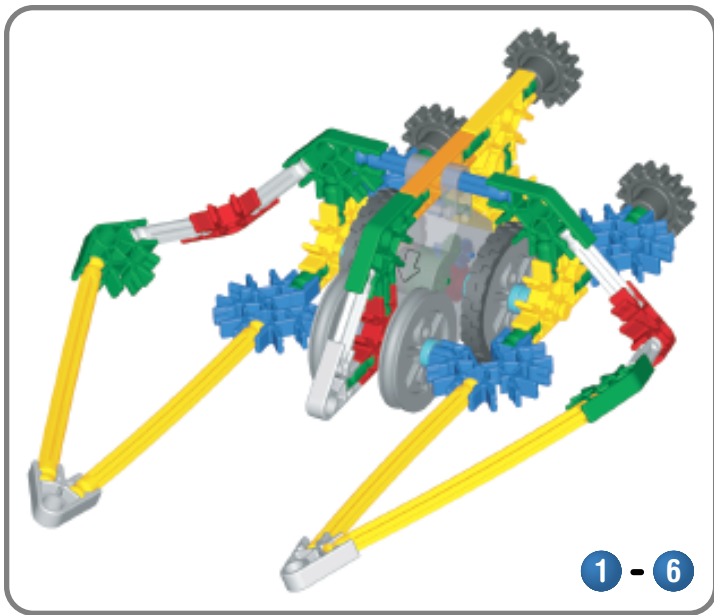

Rubber Band Dragster

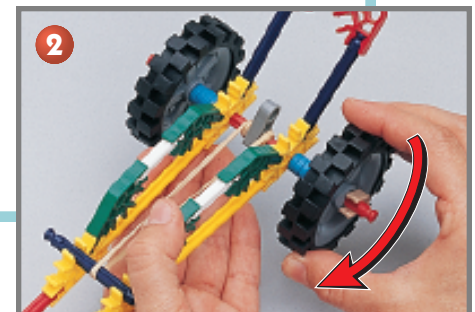
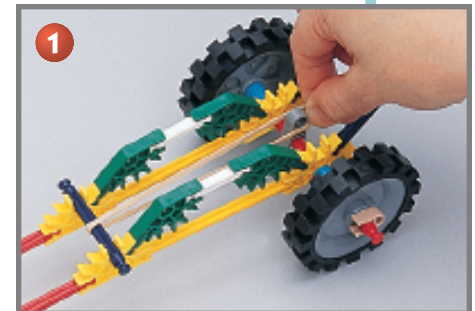
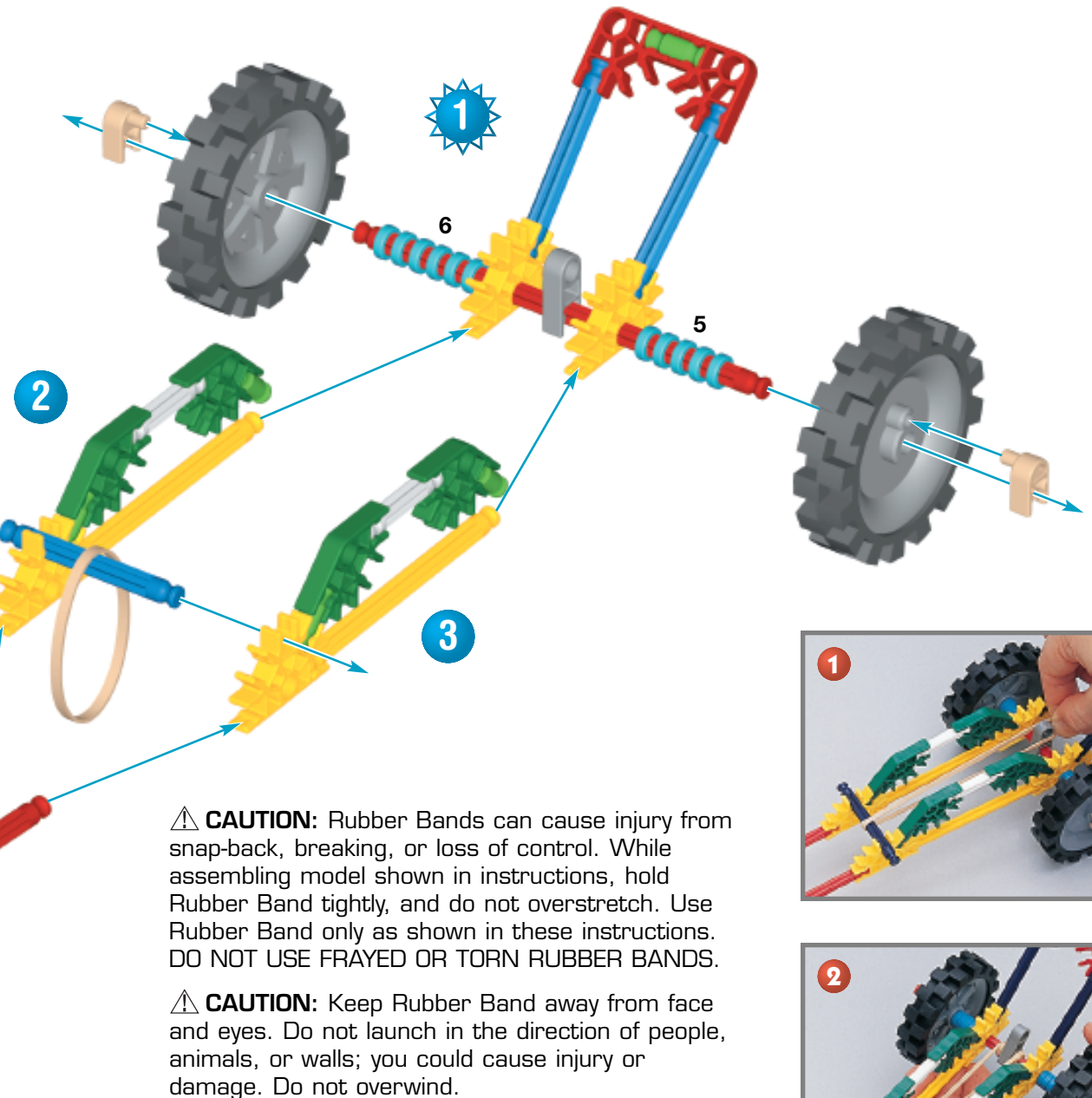
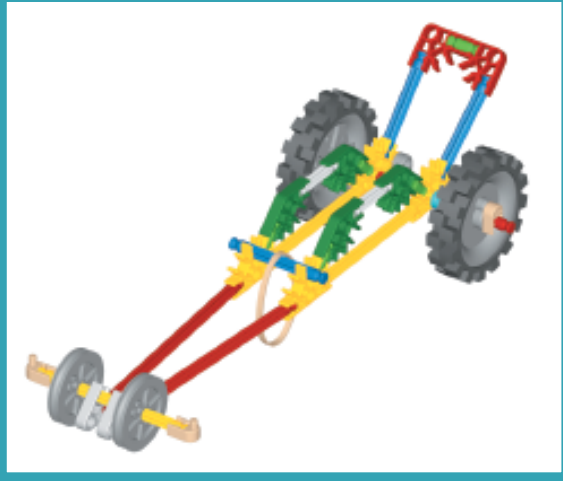

CAUTION: Rubber Bands can cause injury from snap-back, breaking, or loss of control. While assembling model shown in instructions, hold Rubber Band tightly, and do not overstretch. Use Rubber Band only as shown in these instructions. **DO NOT USE FRAYED OR TORN RUBBER BANDS.**

CAUTION: Keep Rubber Band away from face and eyes. Do not launch in the direction of people, animals, or walls; you could cause injury or damage. Do not overwind.

Ring Toss Game

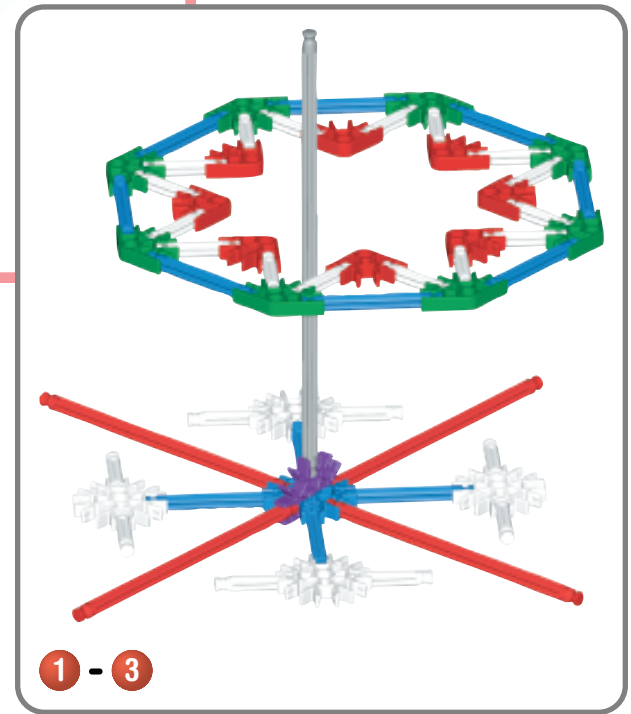
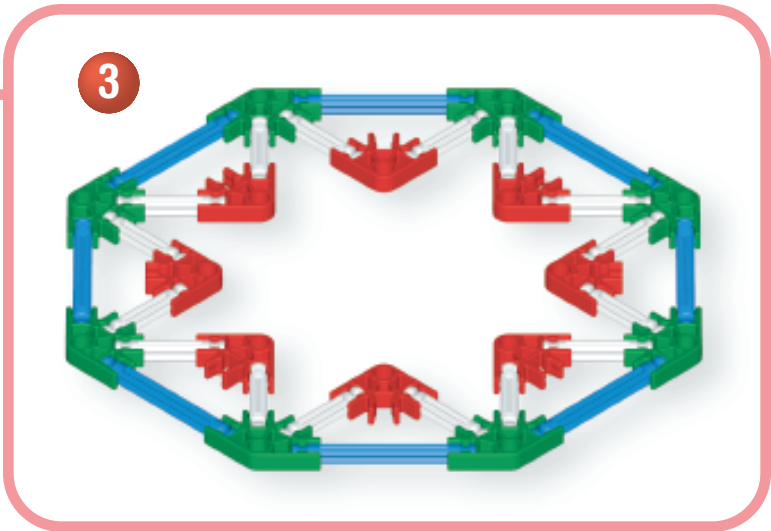
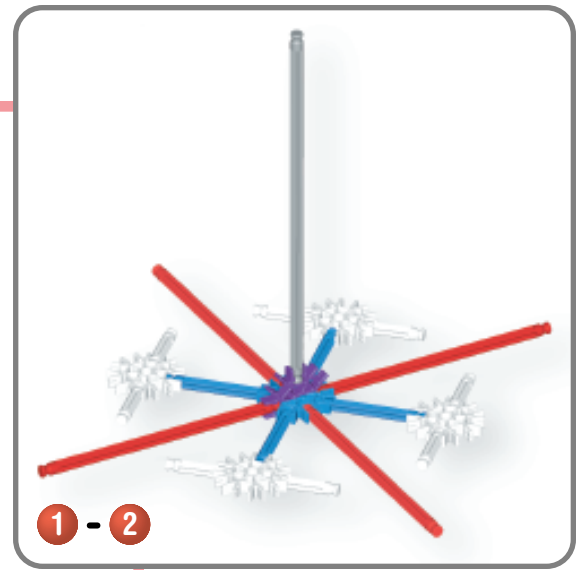
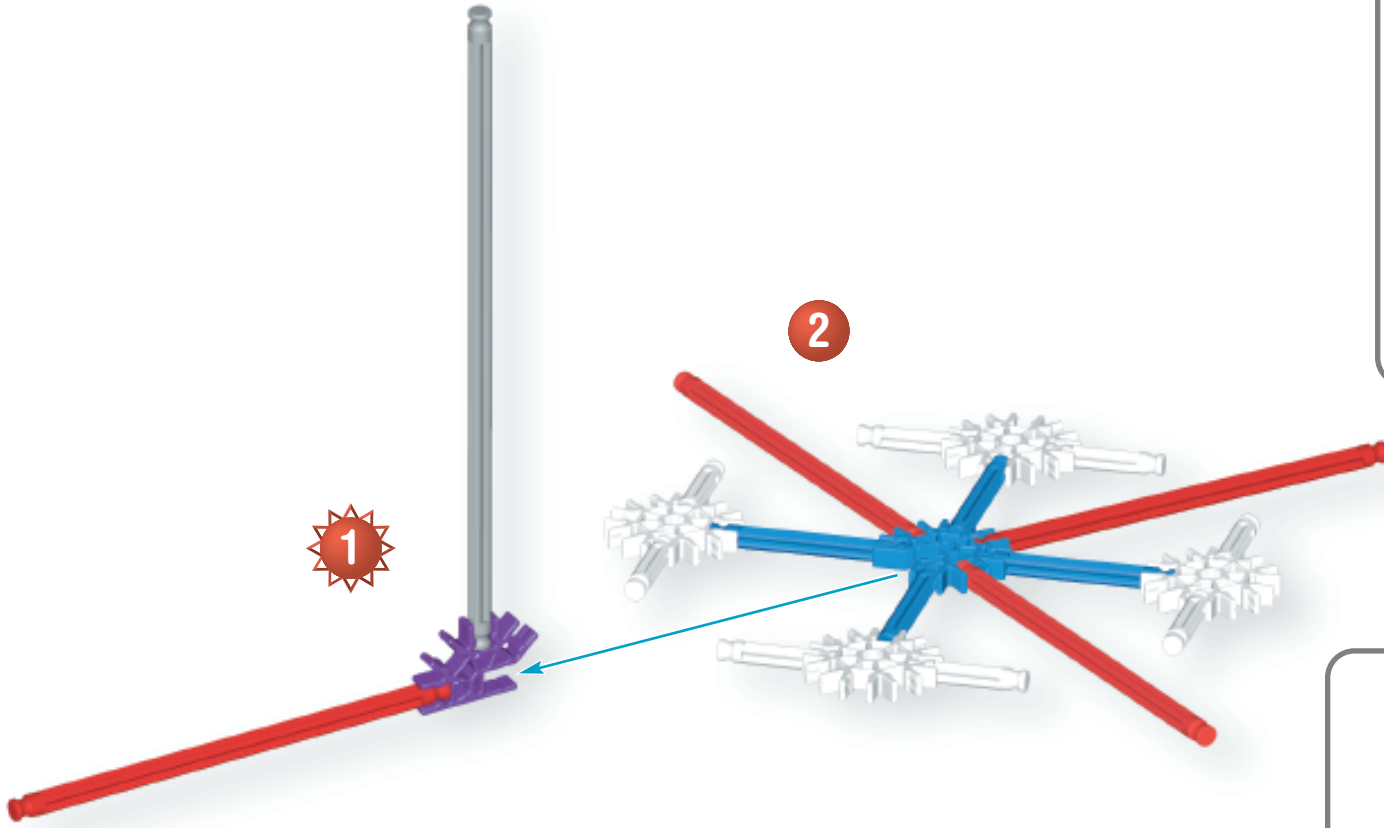

Sailboat

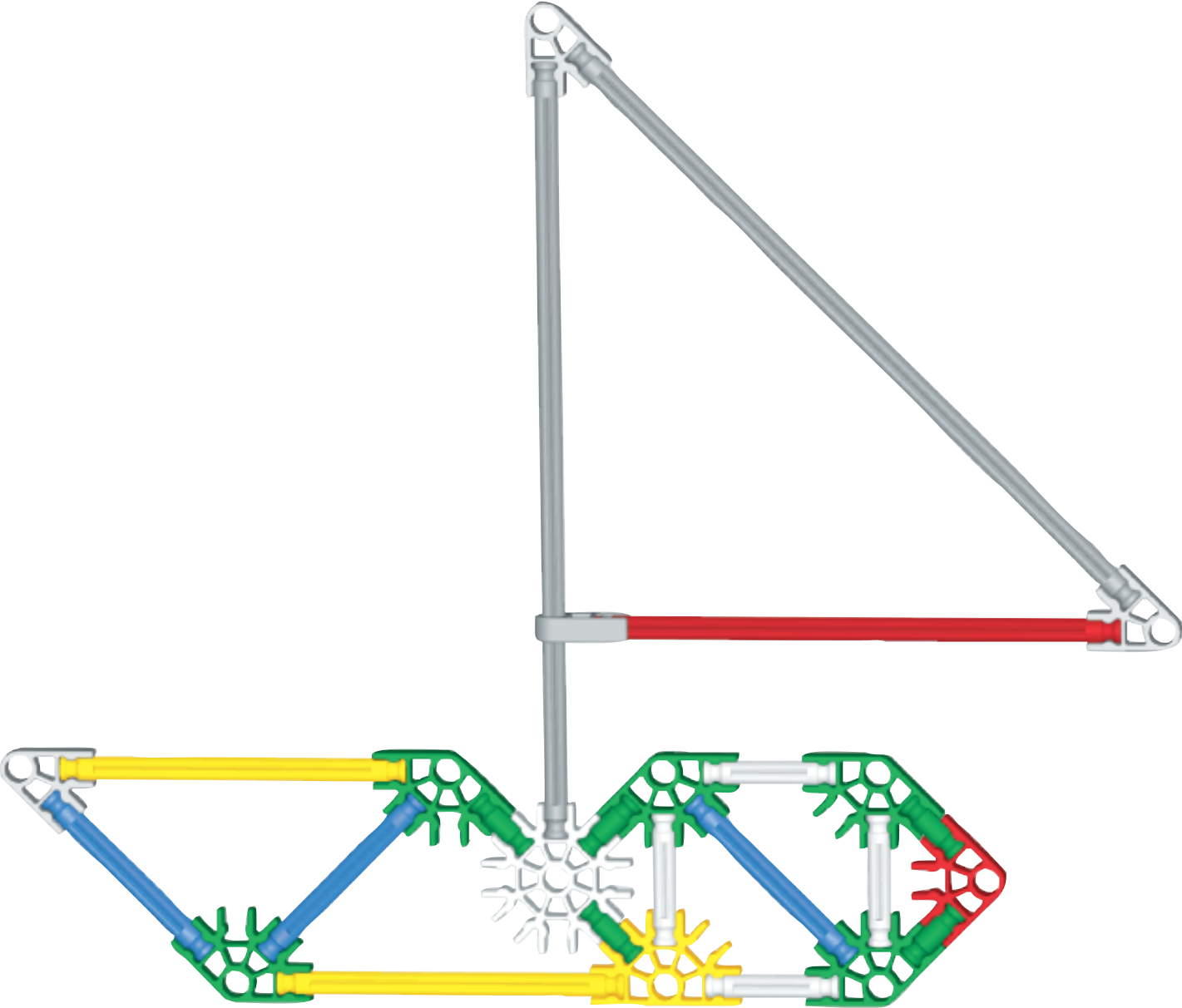

Space Transporter

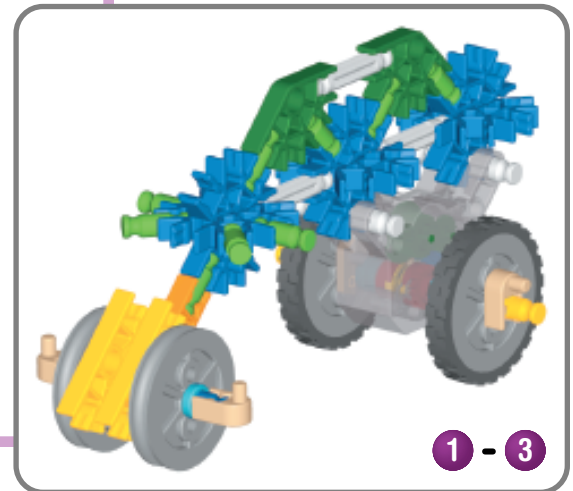
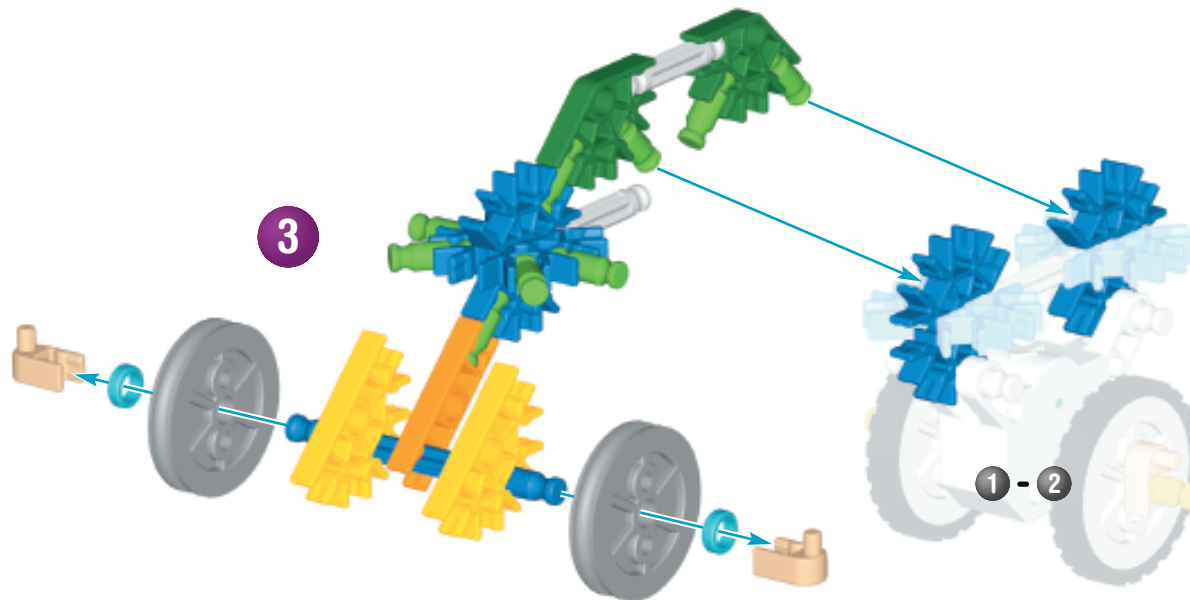
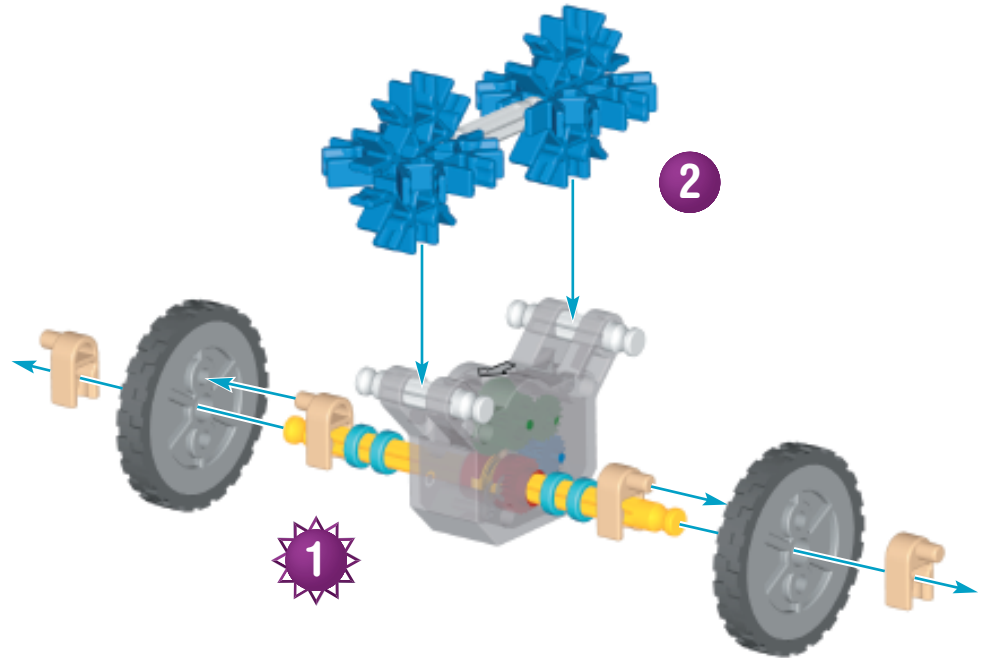
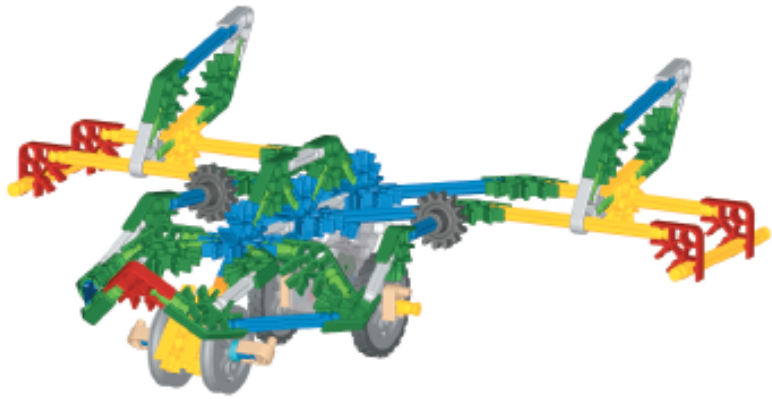

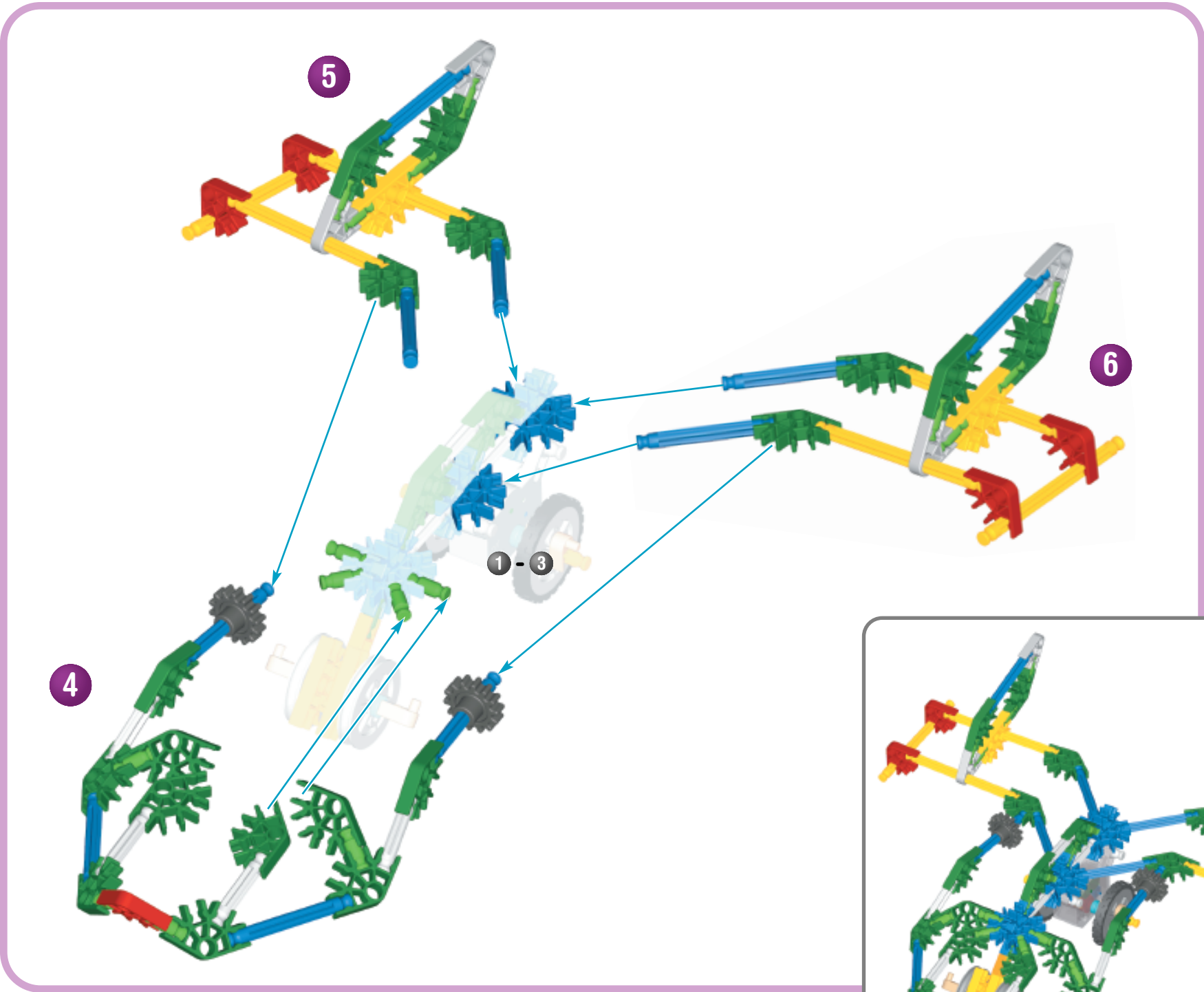

Swing Ride

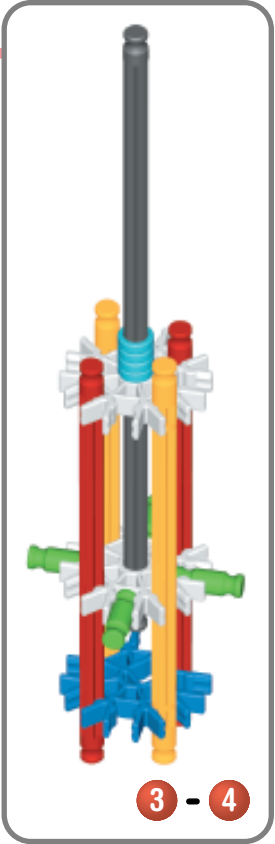
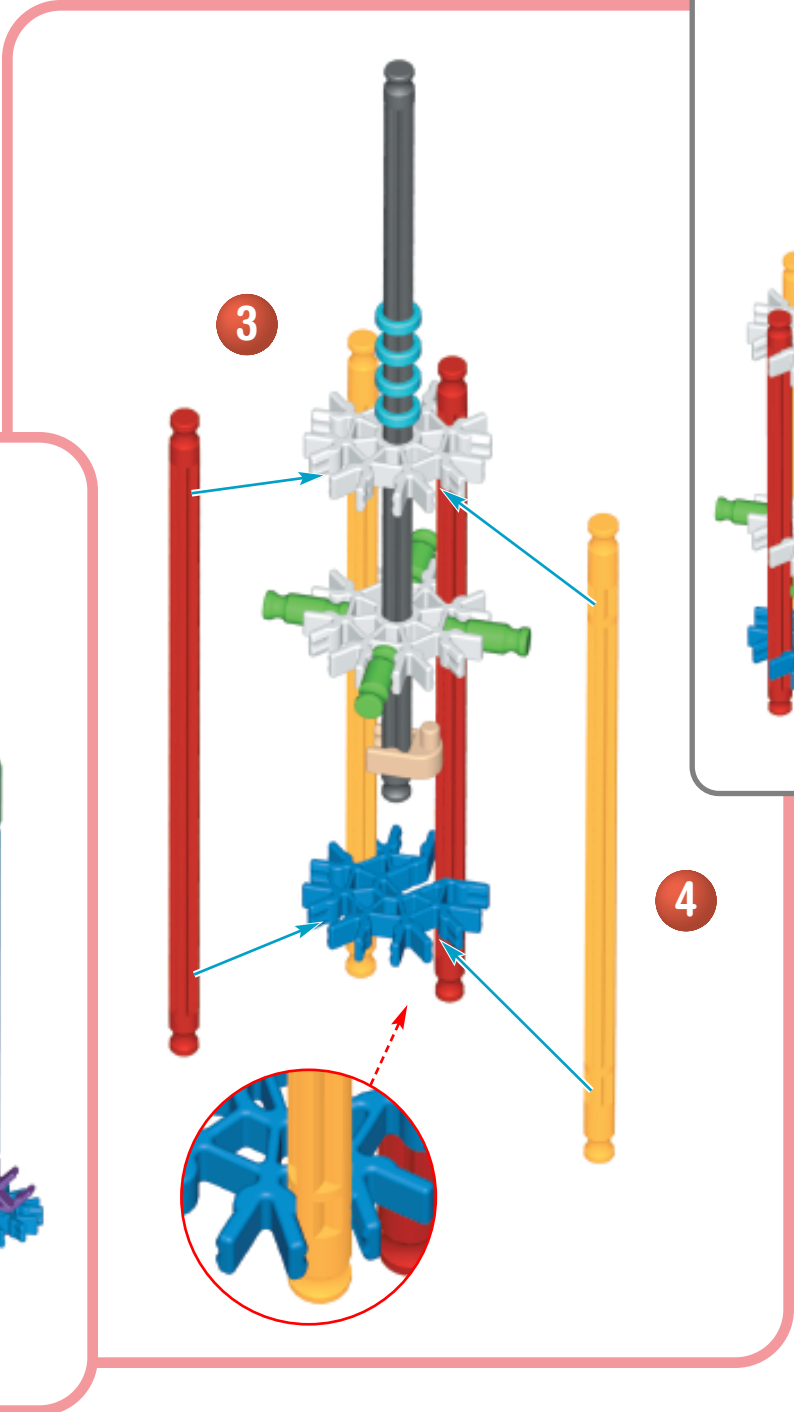
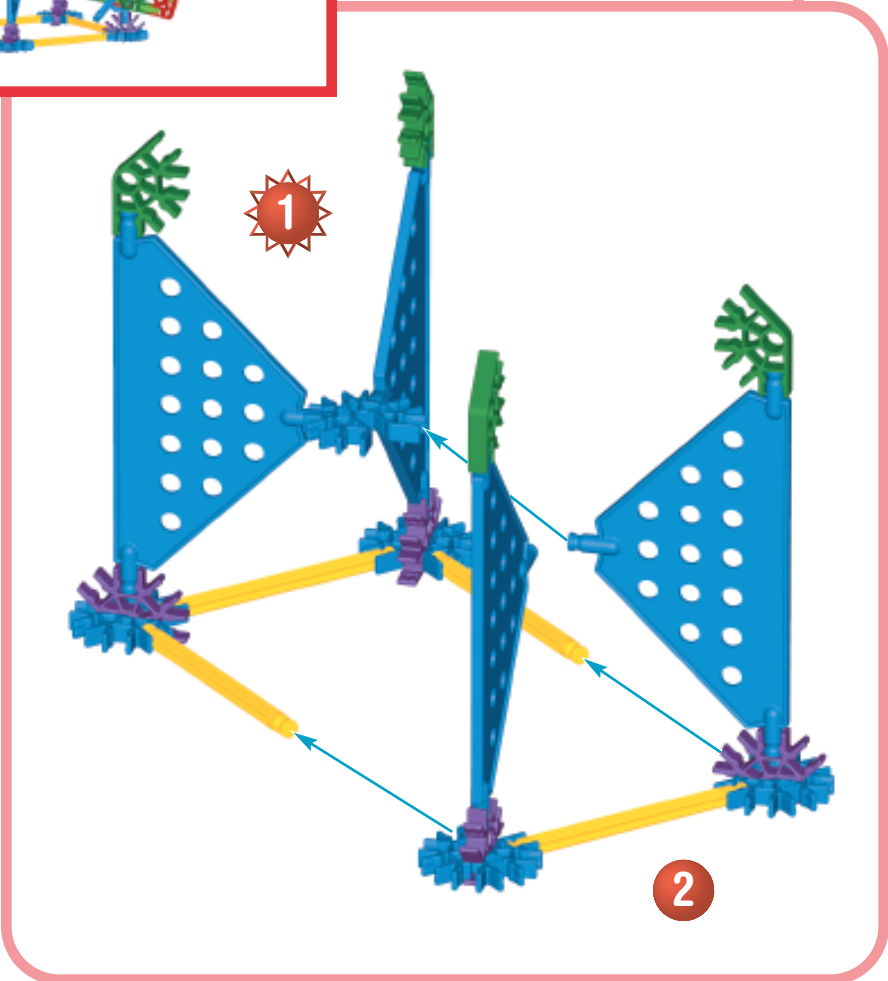

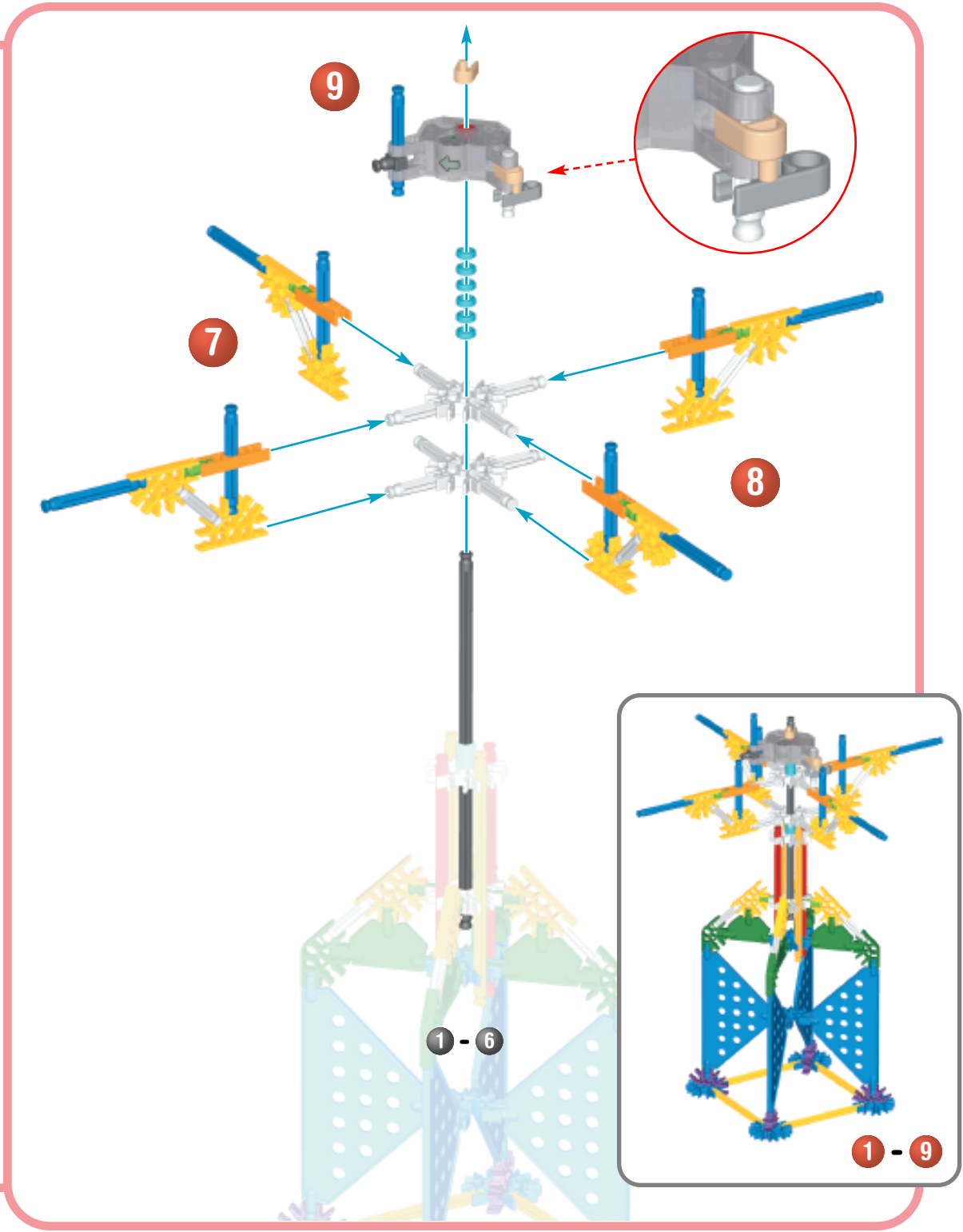
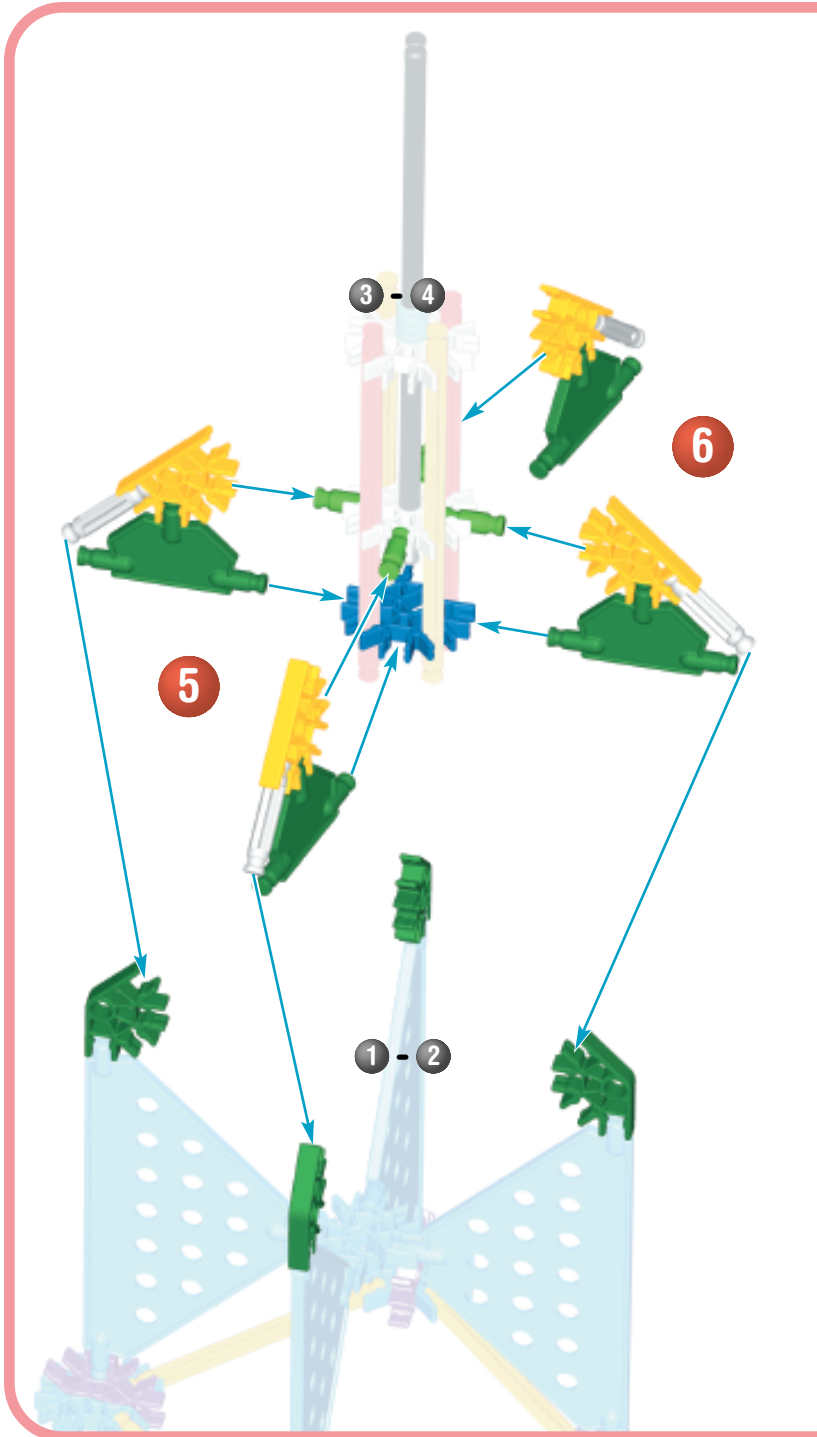

2 Swing Ride

x4

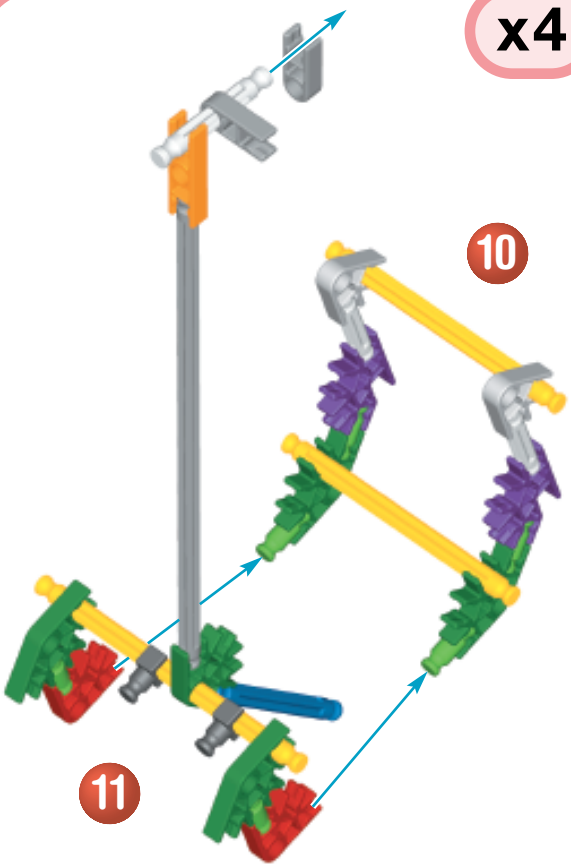

10

11

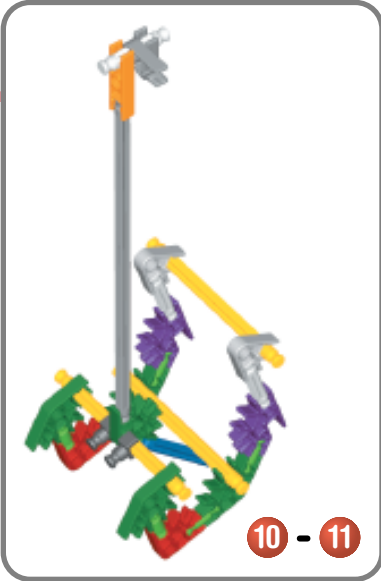

10 - 11

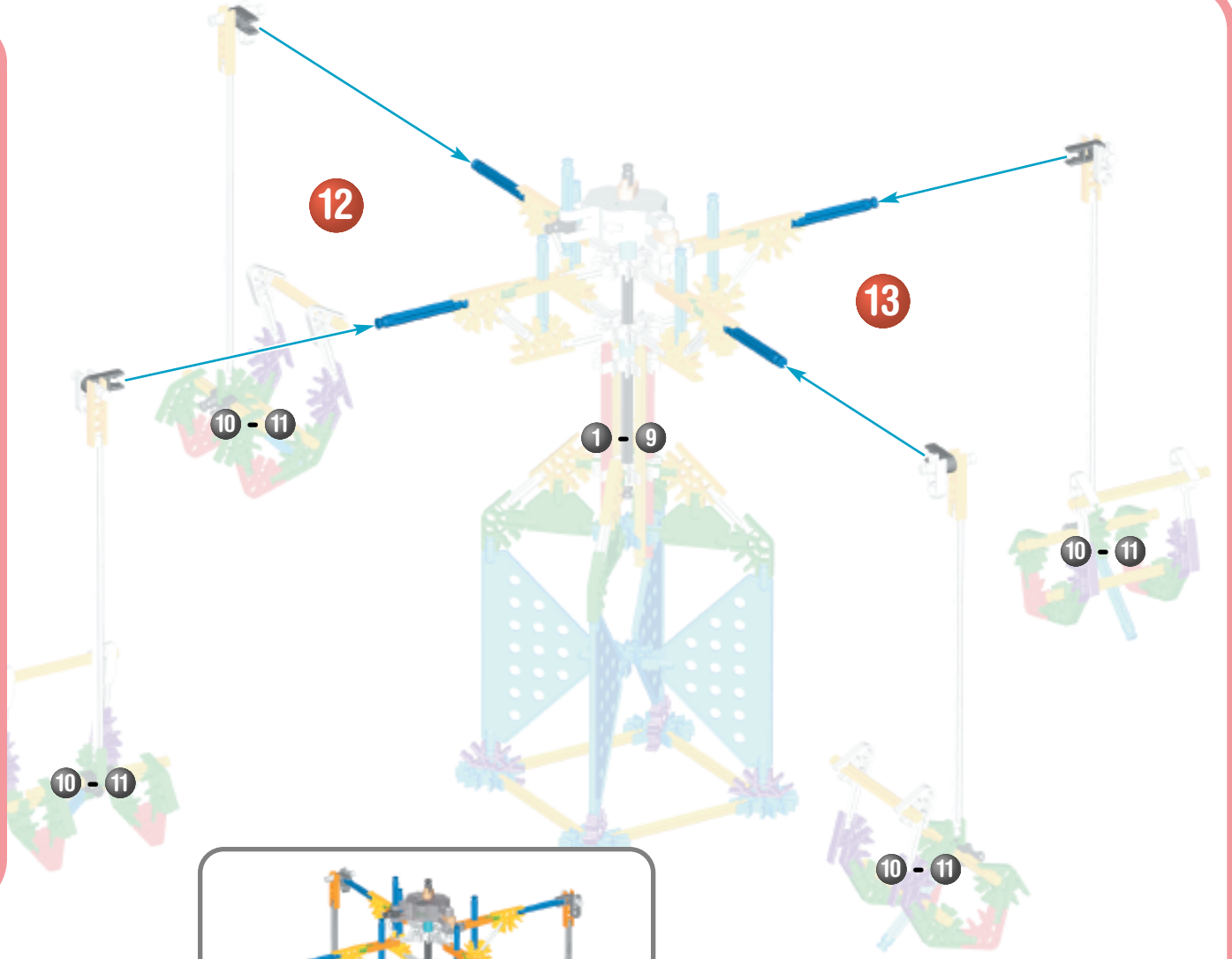

12

13

10 - 11

1 - 9

10 - 11

10 - 11

10 - 11



1 - 13

3 Swing Ride

Windmill

