

KNEX®

Imagine • Build • Play™

LOTS OF VALUE TUB™

325 pcs



WARNING:

CHOKING HAZARD - Small parts.
Not for children under 3 years.



AVERTISSEMENT:

DANGER D'ÉTOUFFEMENT - Pièces de petite taille.
Ne pas donner aux enfants de moins de 3ans.

6+

325 pcs/pzs/pzas

12073/12073A/04857



Welcome!

The fun is about to begin!

I designed the K'NEX building system for kids like you – kids who want to build in a whole new way. Using our snap-together Rods, Connectors and color-coded instructions, you can build the models we've designed – or you can use your imagination and build cool models of your own! That's what K'NEX is all about – getting an idea and making it happen. Just like I did when I invented K'NEX!

Joel Glickman
Inventor of K'NEX

About the Set

Do you love to build? This building set is especially for you! Use the step-by-step instructions or use your imagination to build creations of your own. There's something for everyone, from beginners through K'NEXperts.

CAUTION: Keep hair, fingers, face, and clothing away from all moving parts.

WHAT'S INCLUDED INSTRUCTIONS

Building Instructions:	
Space Shuttle	4
Motorcycle	5
Owl	6
Dragster	6
Windsurfer	7
Steam Ship	8
Mini Ferris Wheel	8
Tow Truck	9
Ring Toss	10
Trike	11
Galaxy Woman	13
Road Grader	14
Spin-O-Matic	16
Suspension Car	17
Castle	20
Picture Frame	21
Helicopter	22
Mini Carousel	24
Flat Frog	26
Windmill	28

Translations:	
Français	30
Español	30
Deutsch	30
Italiano	30
Português	30
Nederlands	31
Svenska	31
Dansk	31
Norsk	31
Suomi	31

Parts Checklist

Note that some parts vary in color from the instruction pictures. Compare the parts in your set with the parts listed here. If any parts are missing, look at the back cover of this instructions booklet to contact us.



K'NEX Building Basics

Hi! I'm your K'NEX building buddy. You'll find models for three levels of building. Look for me before each build, holding up a sign to show you how difficult each model will be. Look for the 3 building buddies below:



Friendly Challenge



Moderate Challenge



Greater Challenge

Spacers

There are places in your model where you need to use Spacers. Be sure to count them carefully.

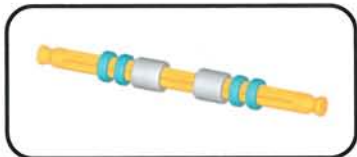

Ready, Set, Build

To begin your model, find the  and follow the numbers. Each piece has its own shape and color. Just look at the picture, find the pieces in your set that match what you see, and snap them together. Try to hold your model in the same direction as in the picture so you will attach your pieces to the right place.

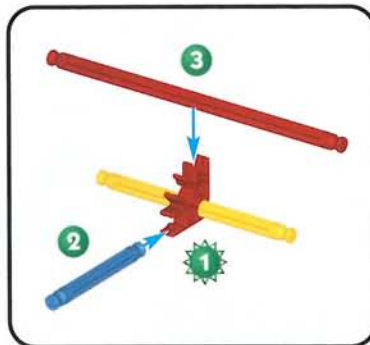

Moving On

The faded colors tell you this section is already built. You'll want to connect the new section to the place where the arrows are pointing. This piece will be in full color.

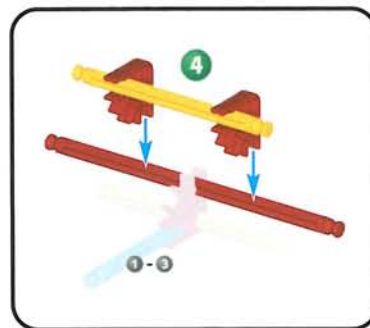

Connectors

It's very important to position blue and gray Connectors in a specific direction. Pay close attention to the instructions, and position these Connectors horizontally or vertically exactly as they are shown. Push together tightly until you hear a "click".

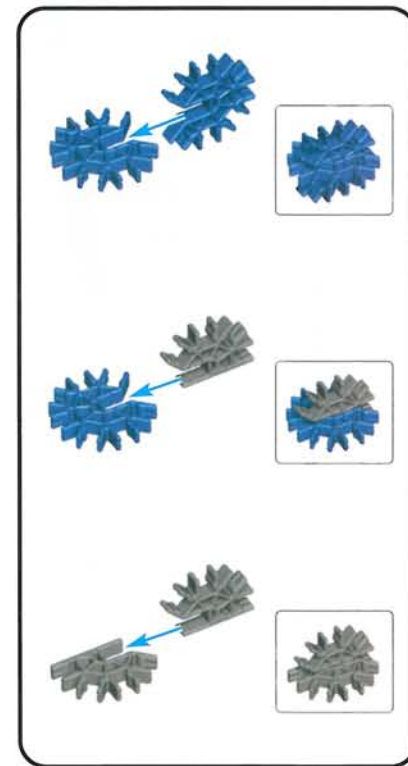

Space Shuttle

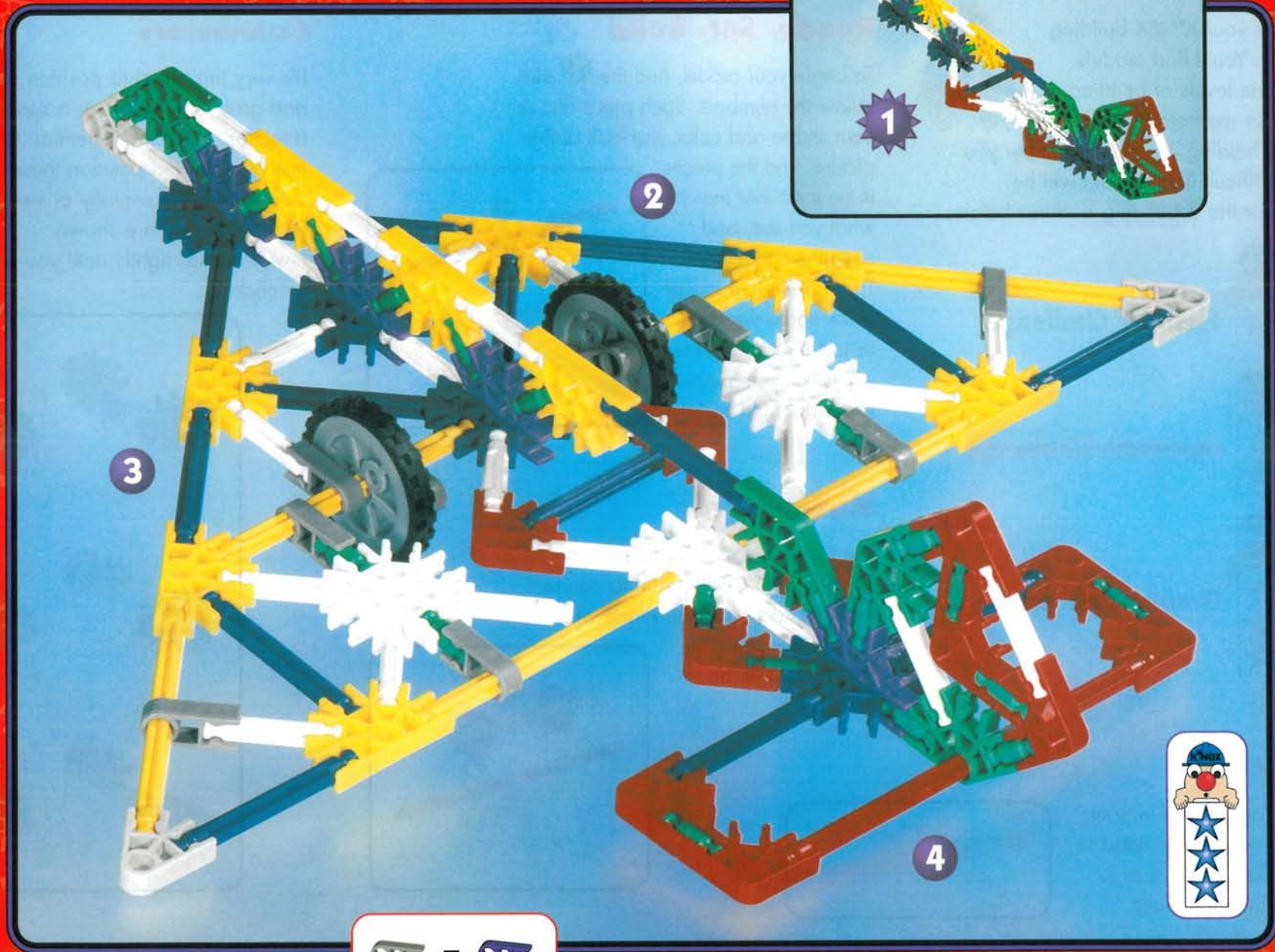

Motorcycle



Owl



Dragster



Windsurfer

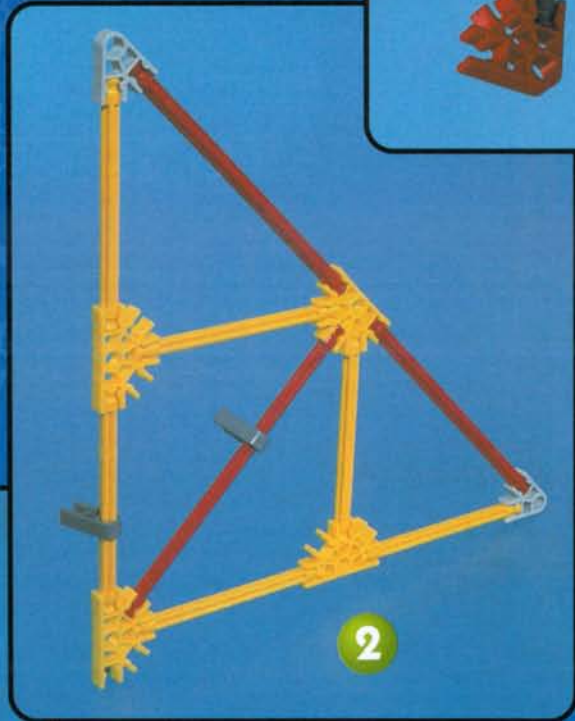
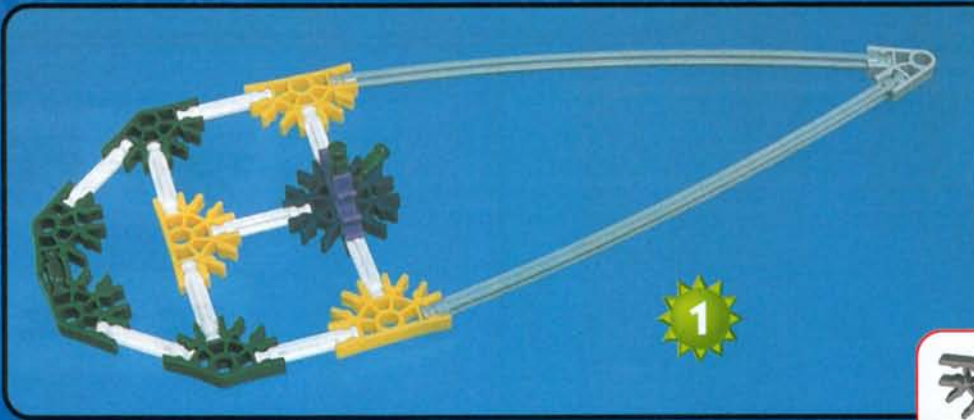

Mini Ferris Wheel

Steam Ship

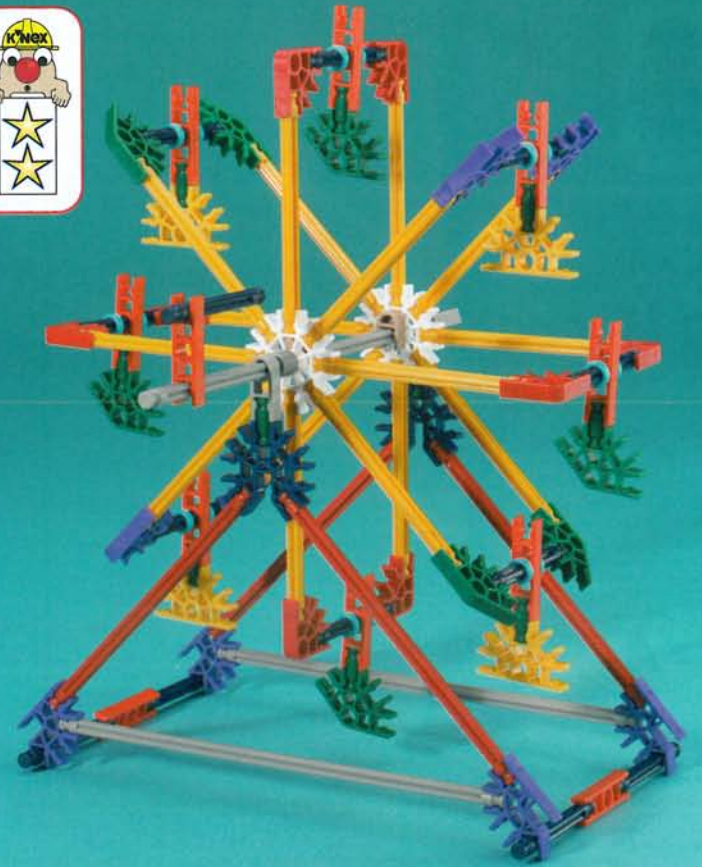
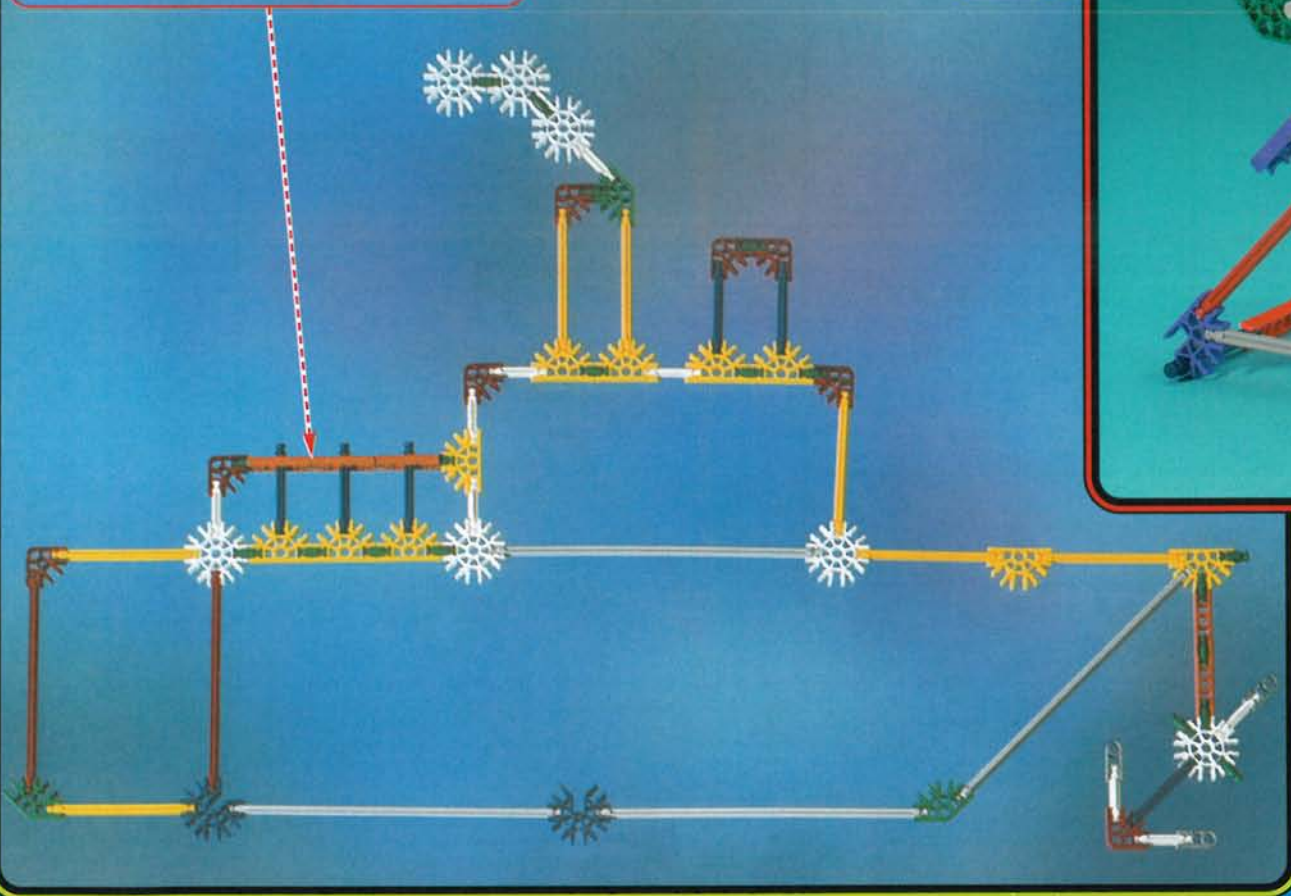

Tow Truck

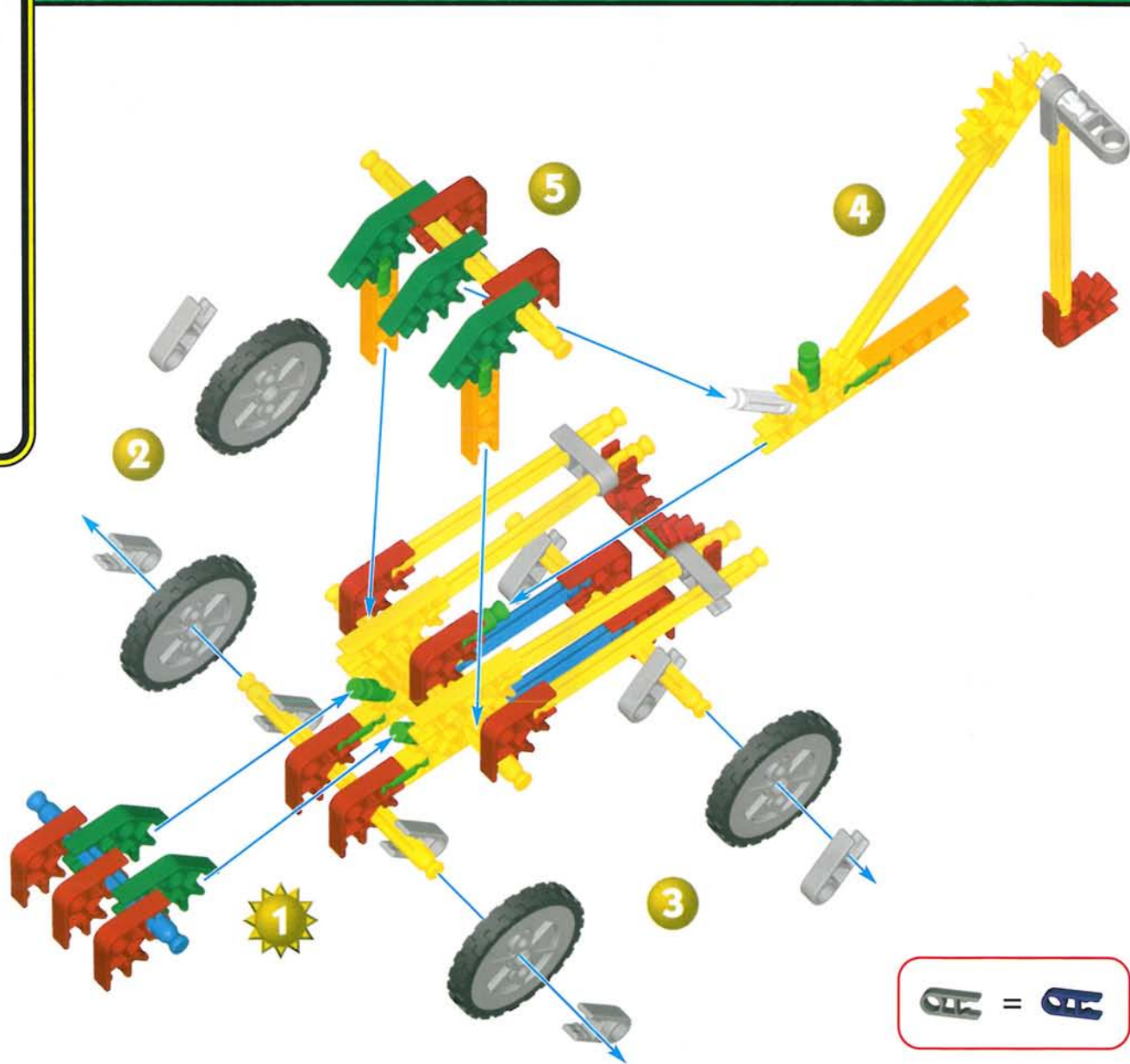

1 - 5

Ring Toss

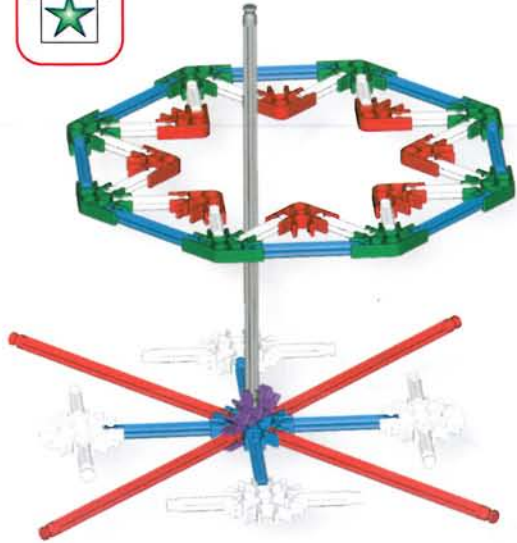

1

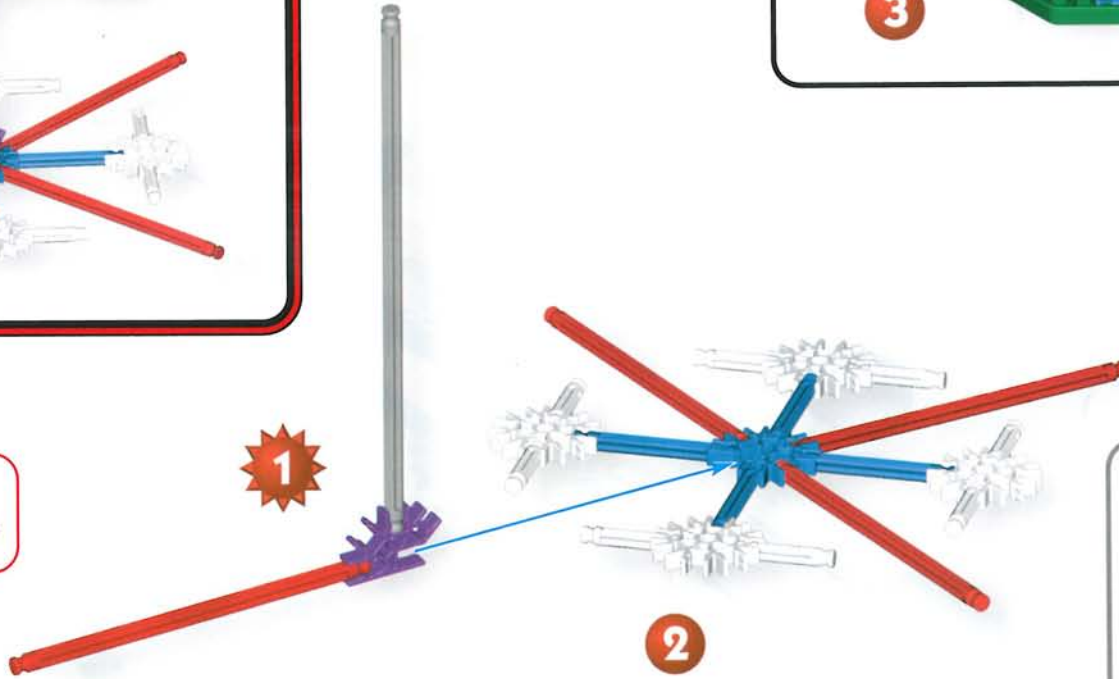

2

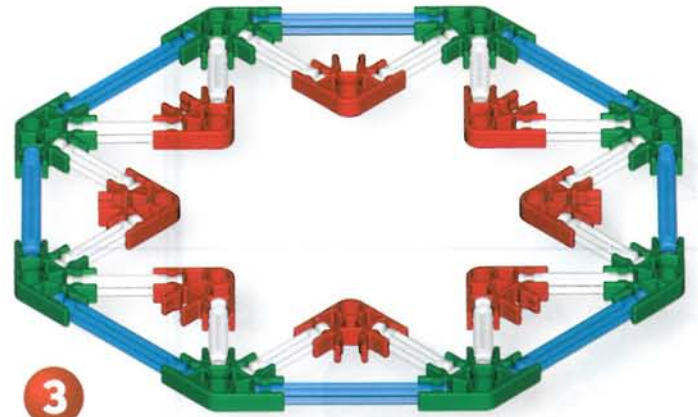

3



1 - 2

Trike

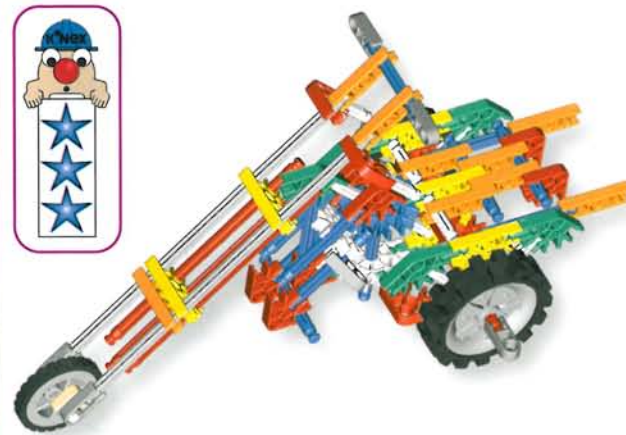
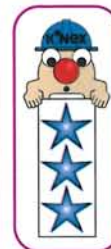

1 - 5



1

3

5

2

4

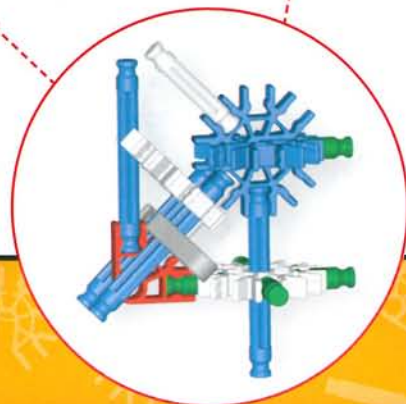

A = A

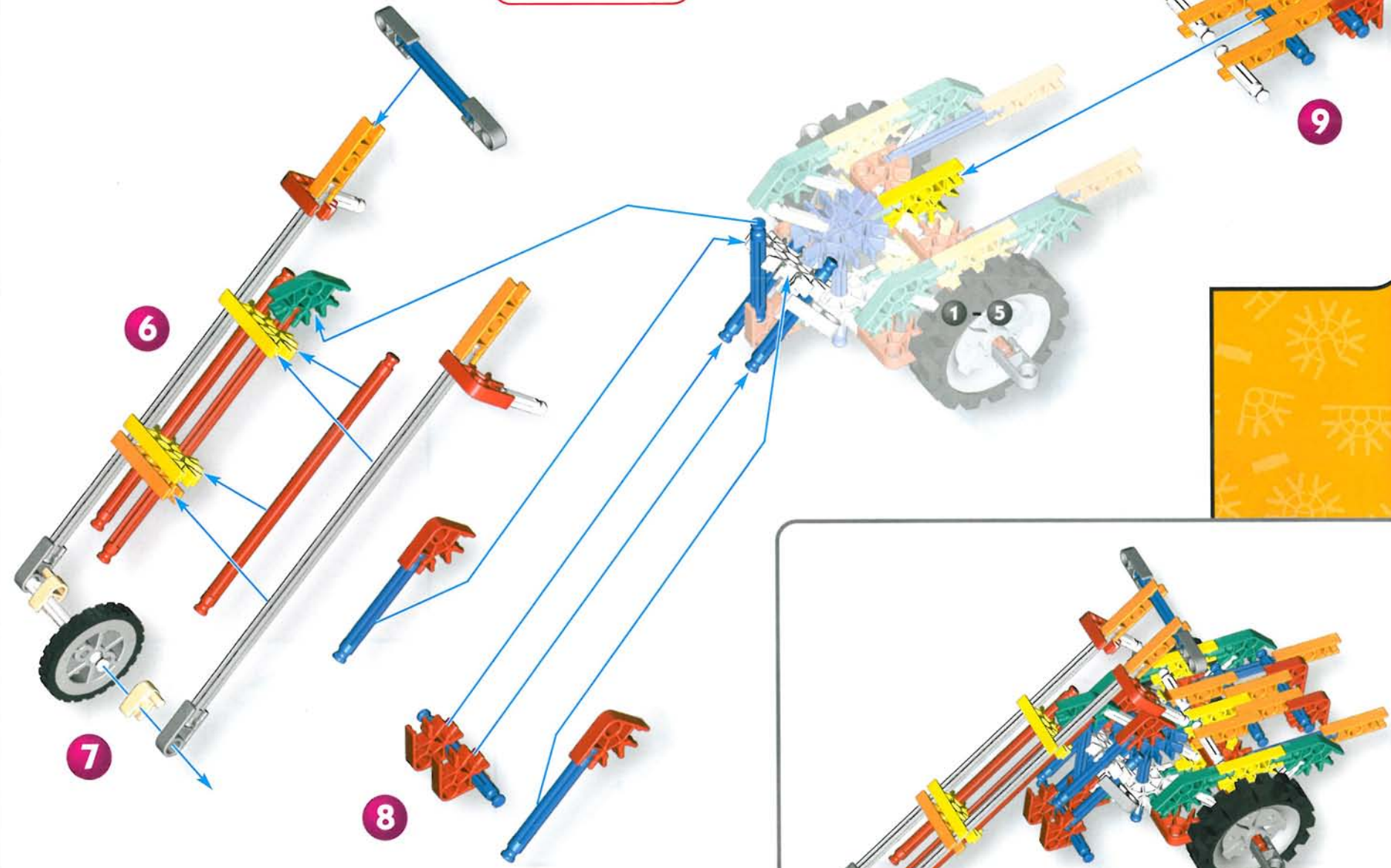

Galaxy Woman

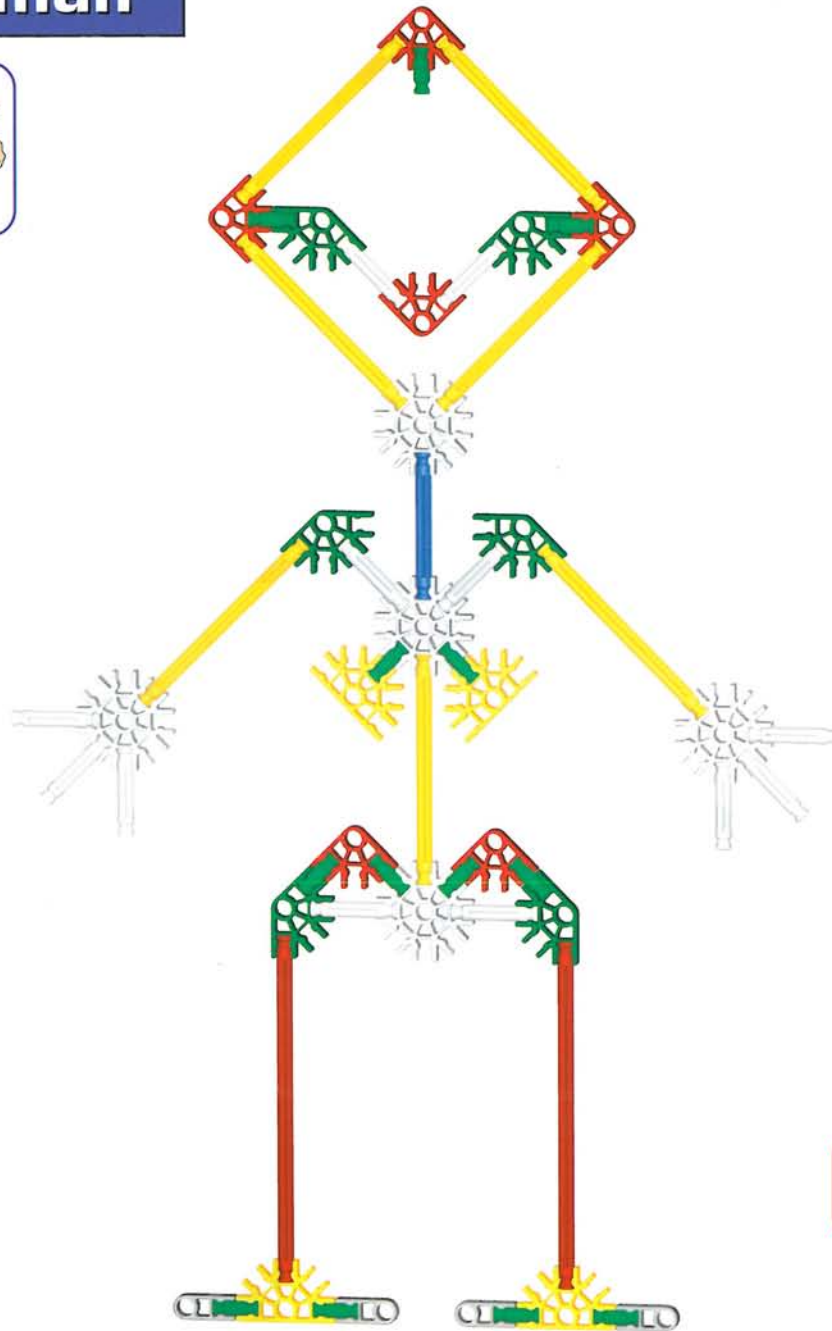

Road Grader

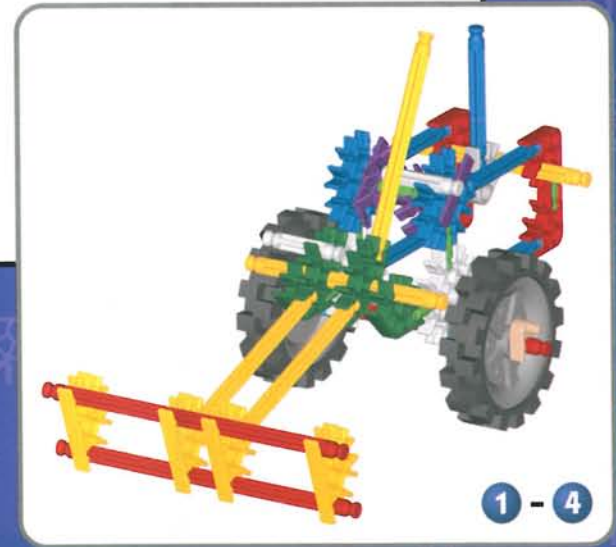
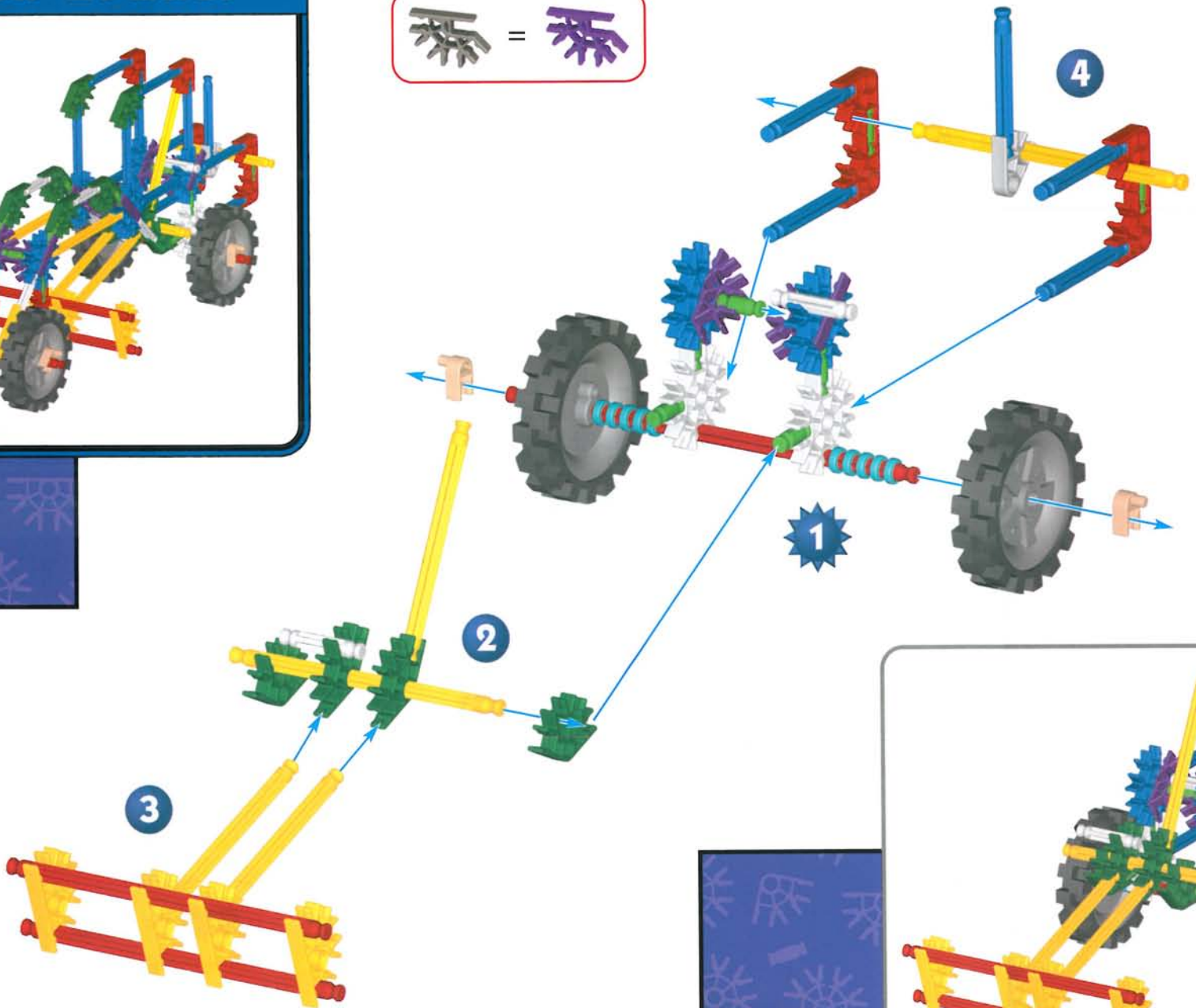

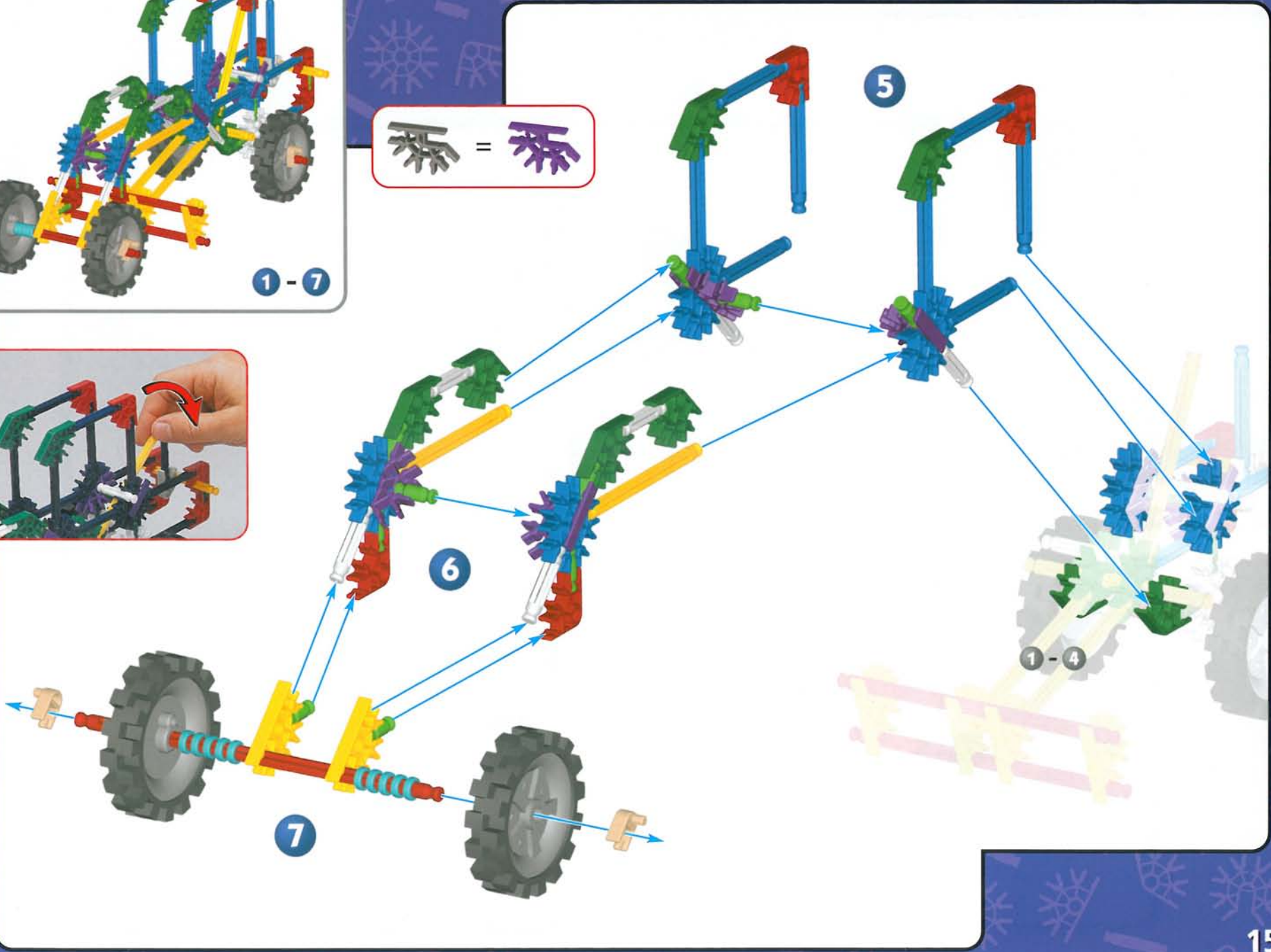
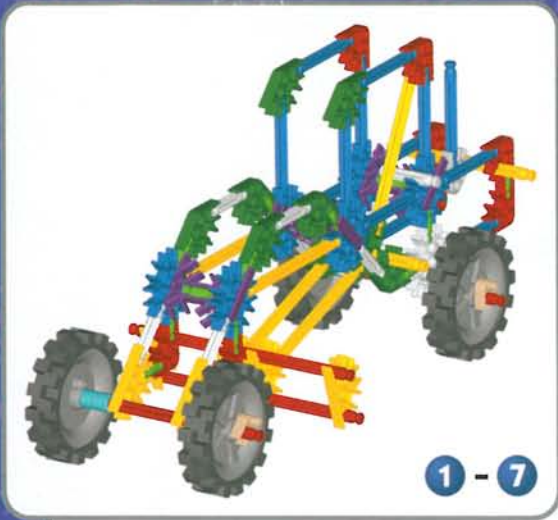

Spin-O-Matic

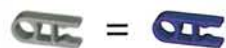

Suspension Car

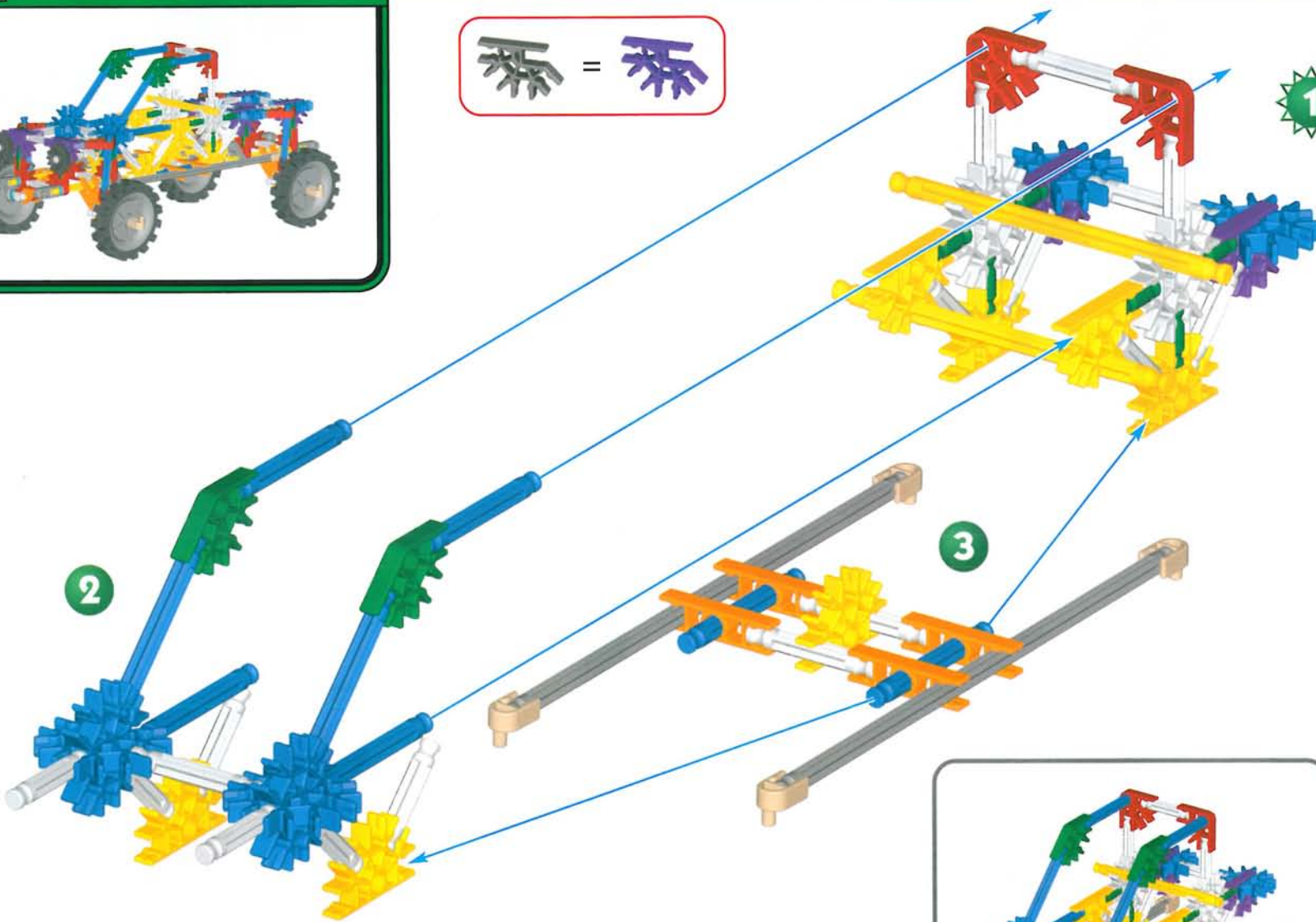
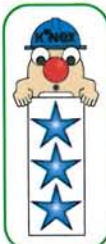

3



1 - 3

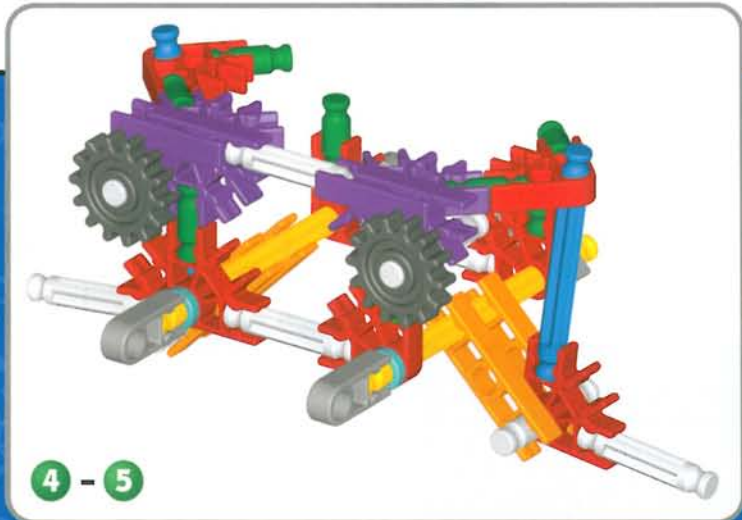
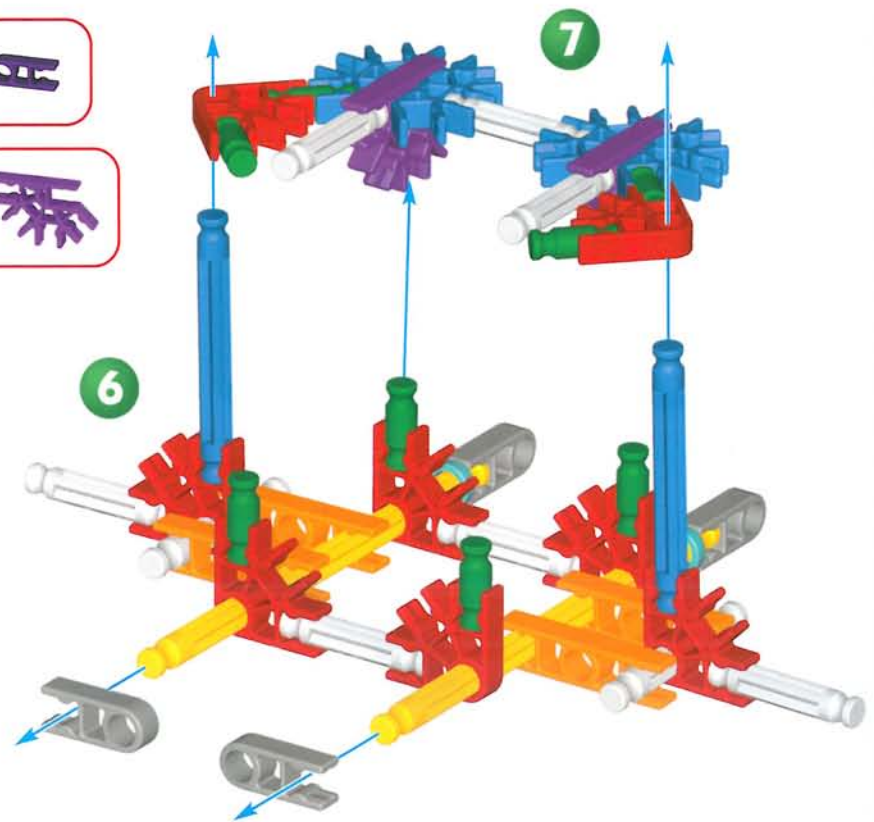
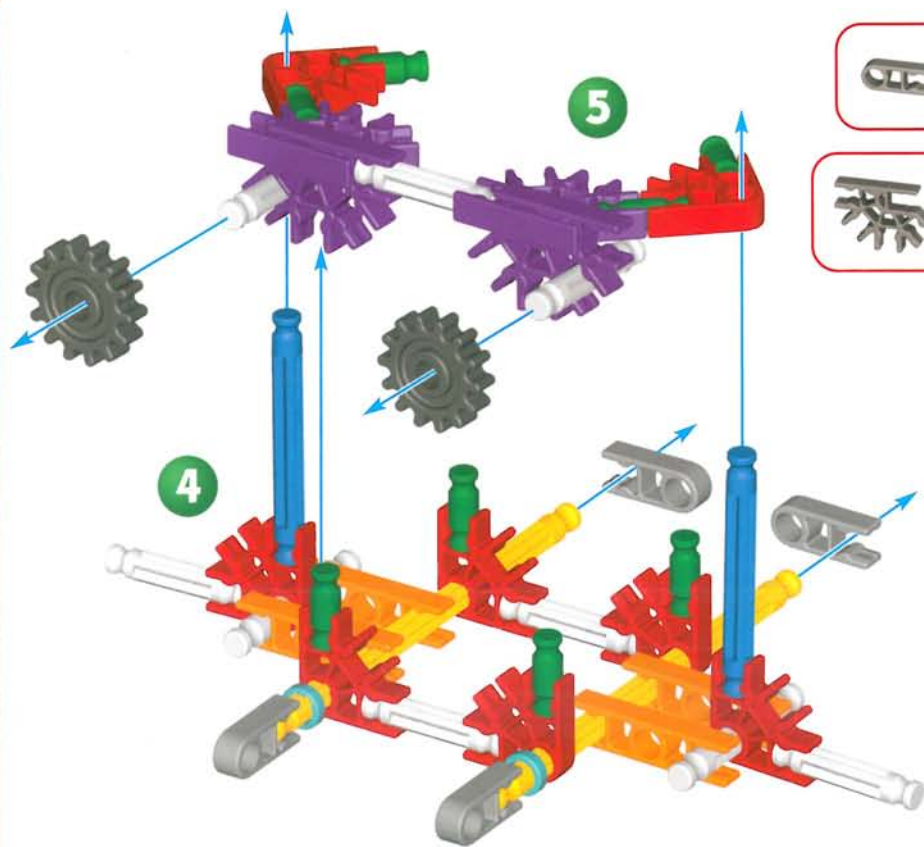

4 - 5

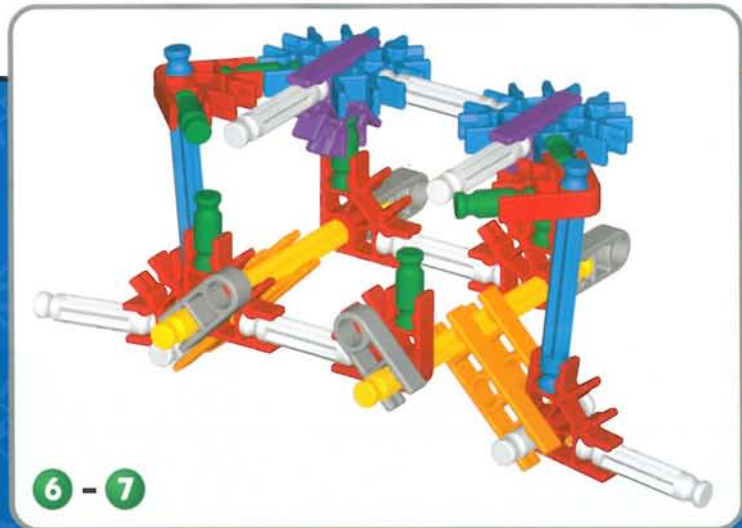

6 - 7

Castle

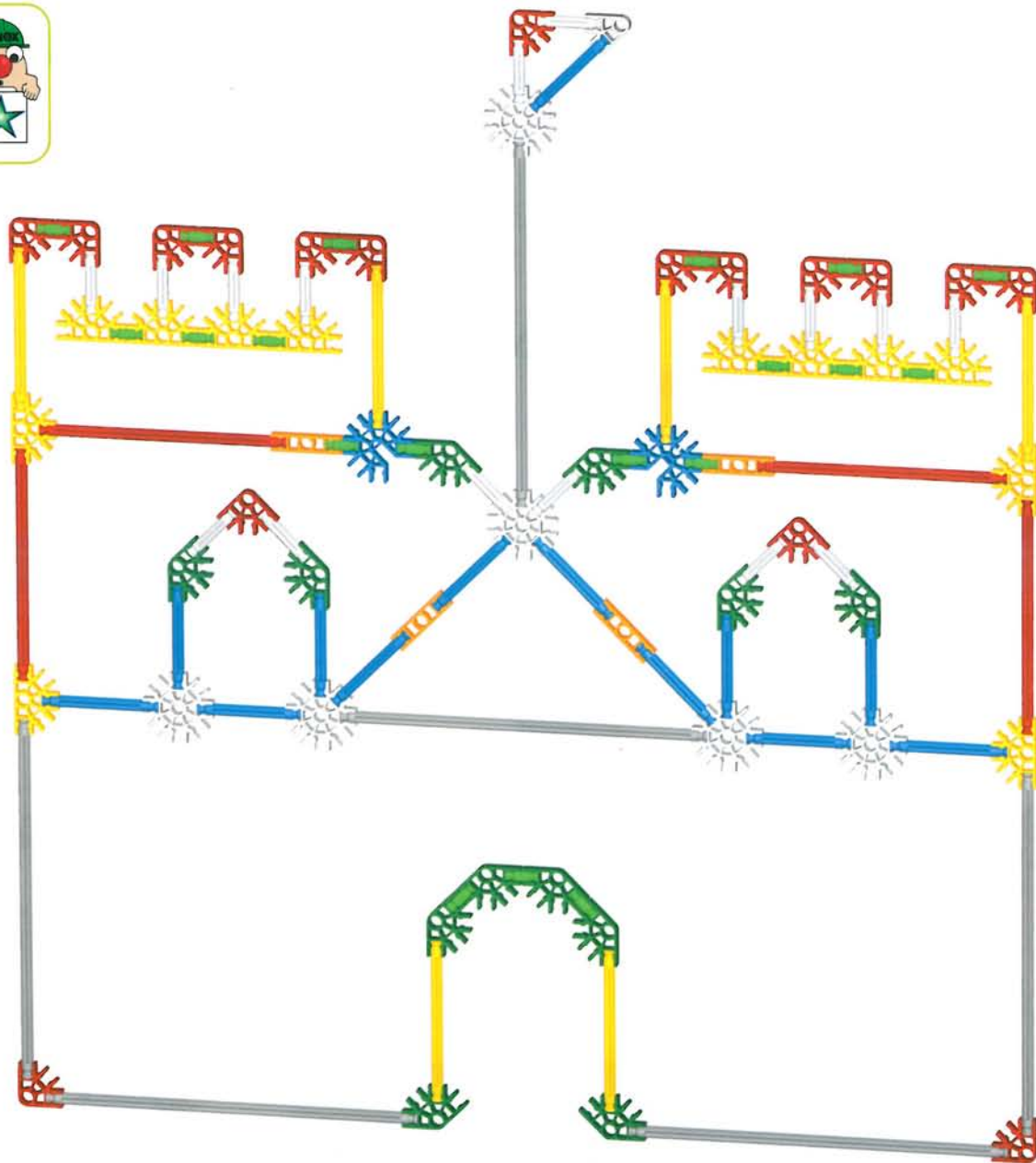

Picture Frame

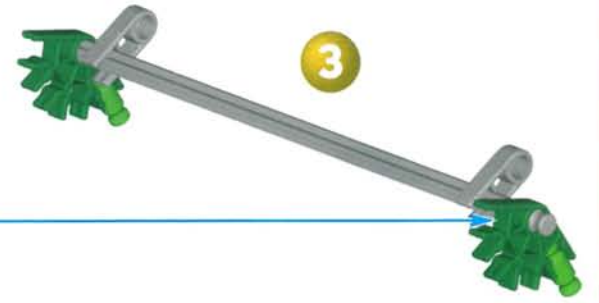
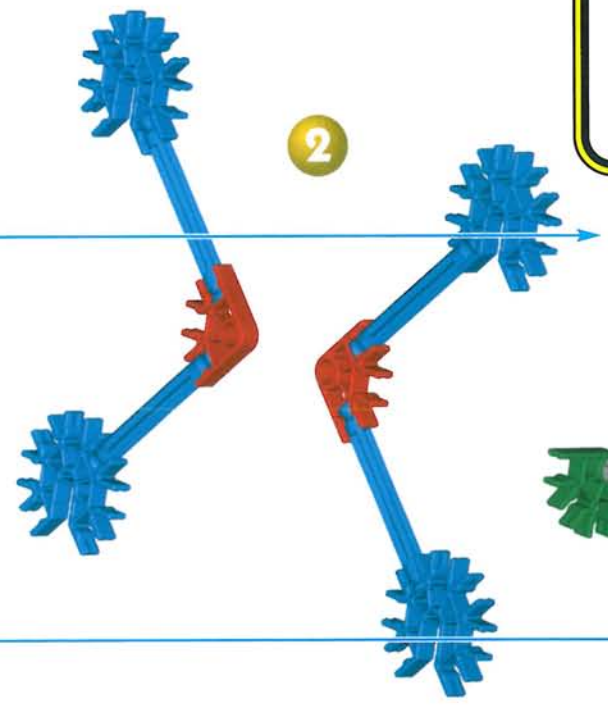
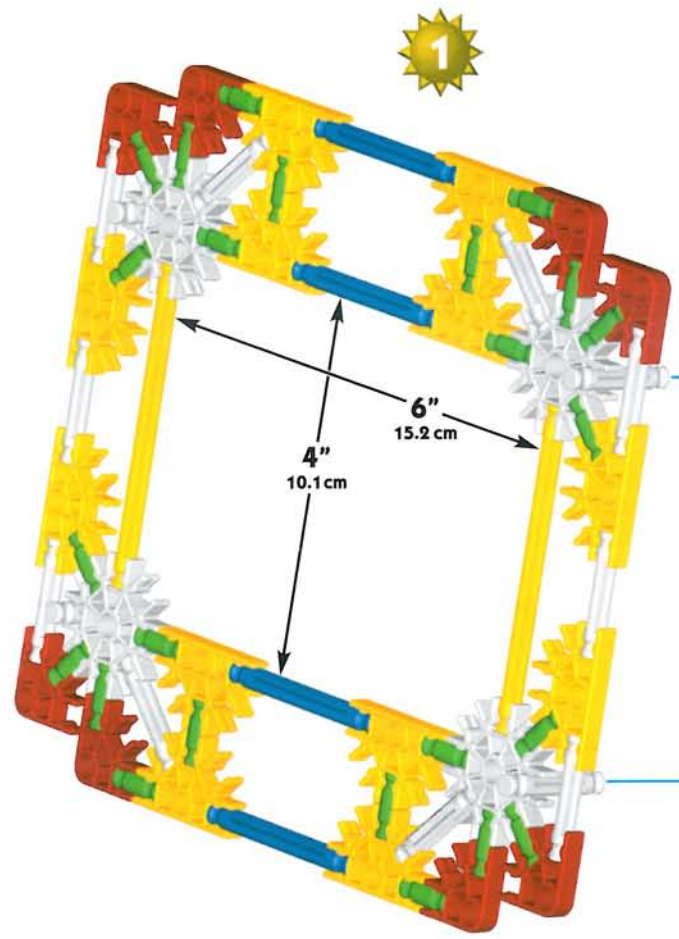
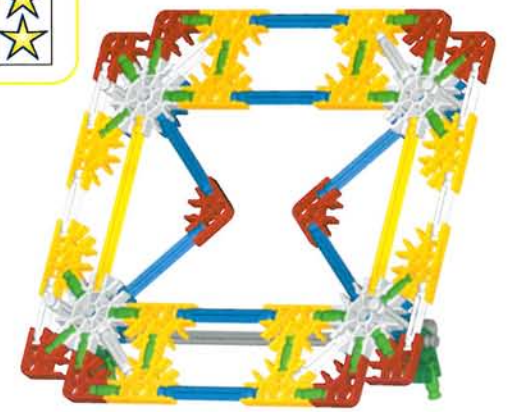

Helicopter

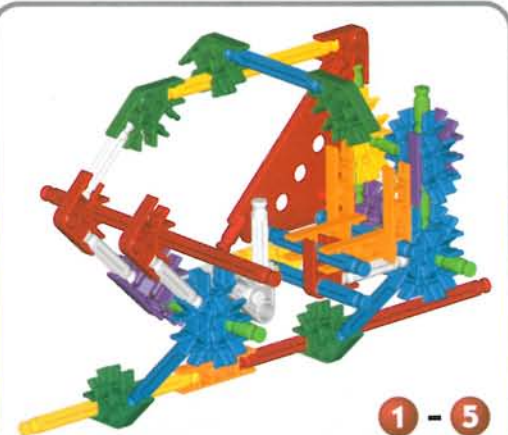
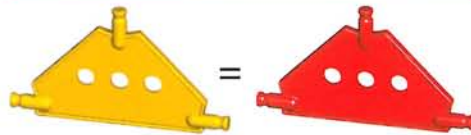
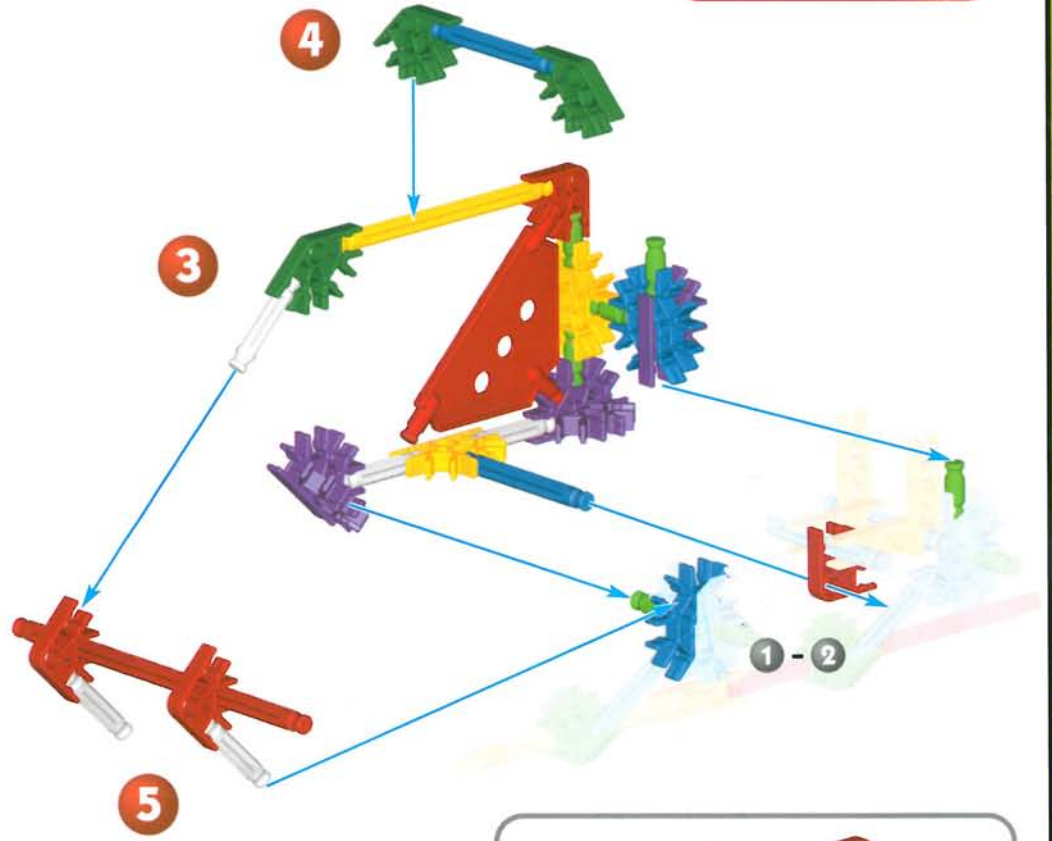
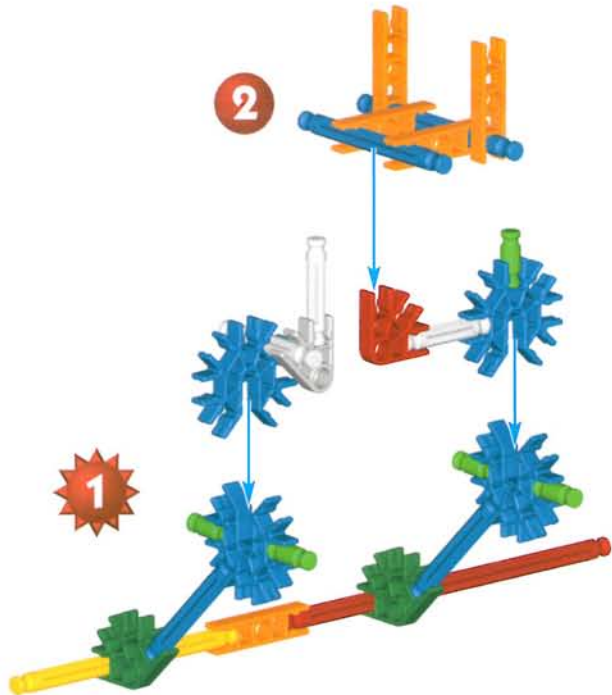

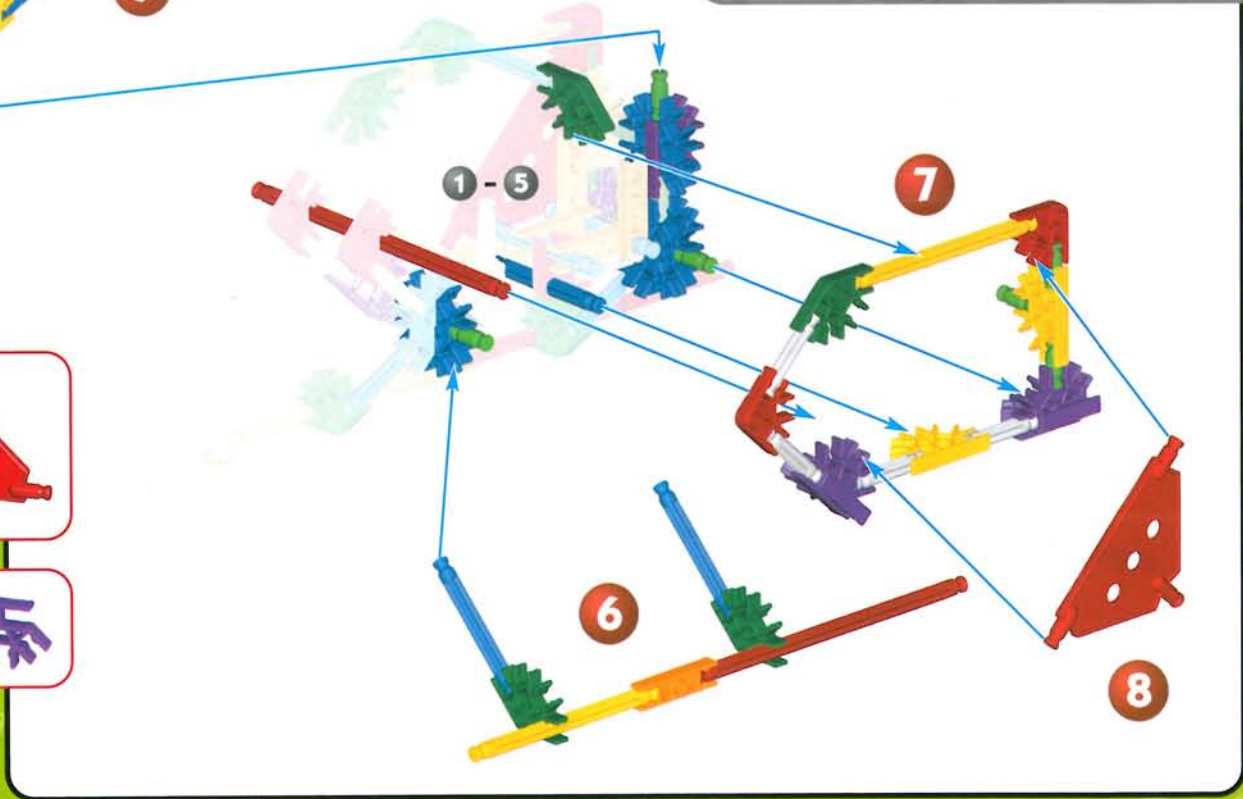
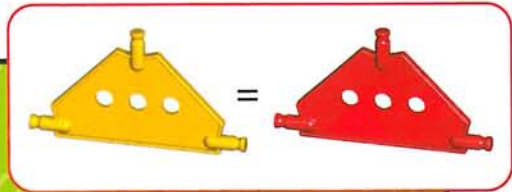

Mini Carousel

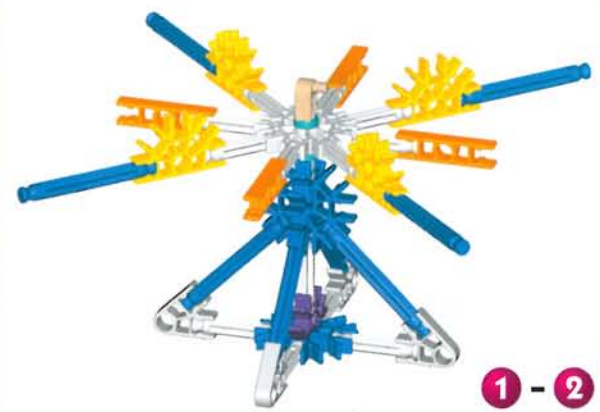
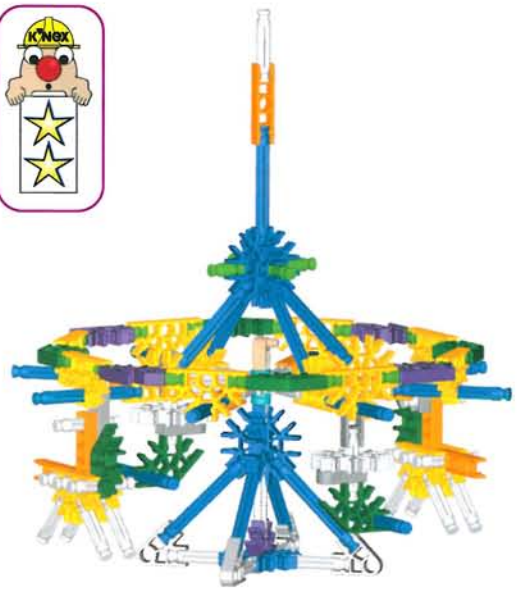

1 - 2



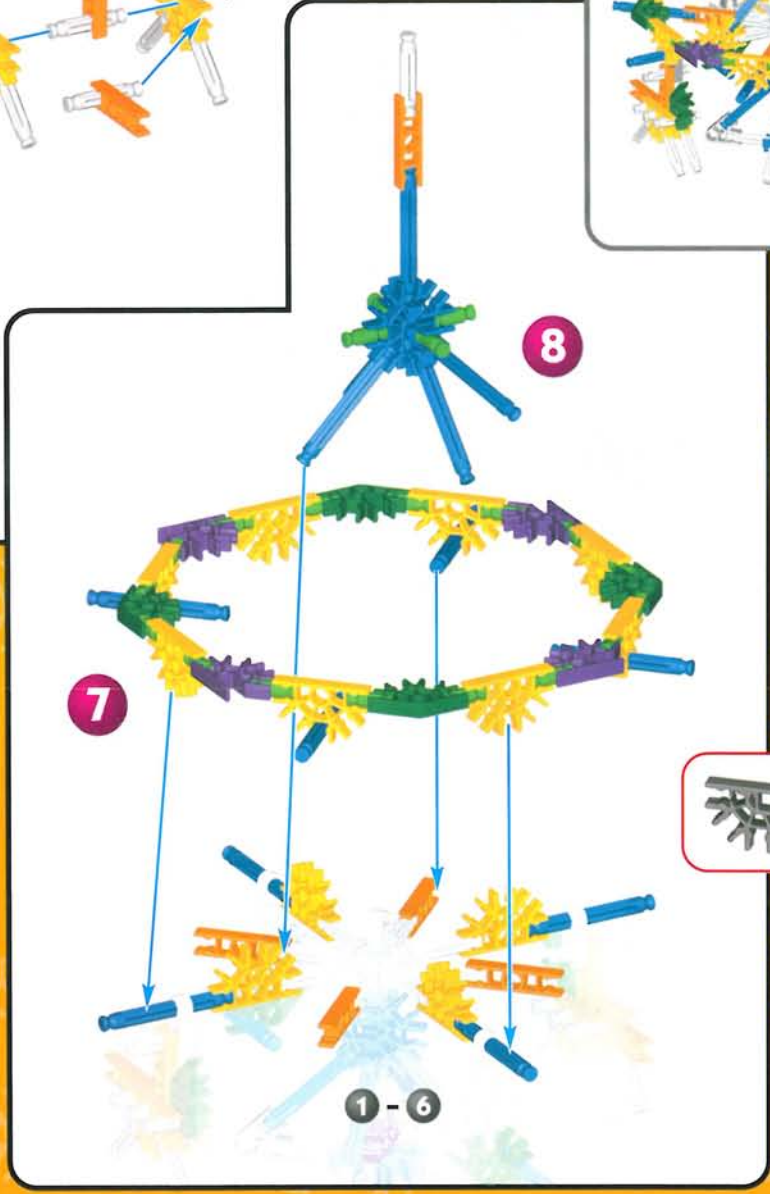
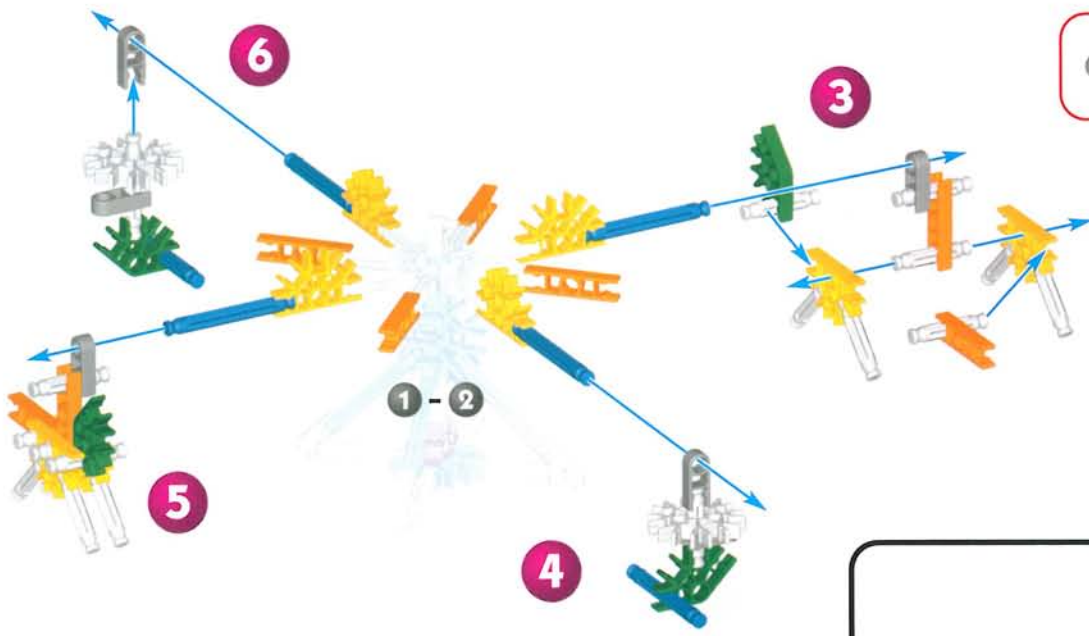

Flat Frog

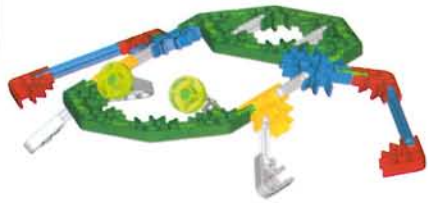

2

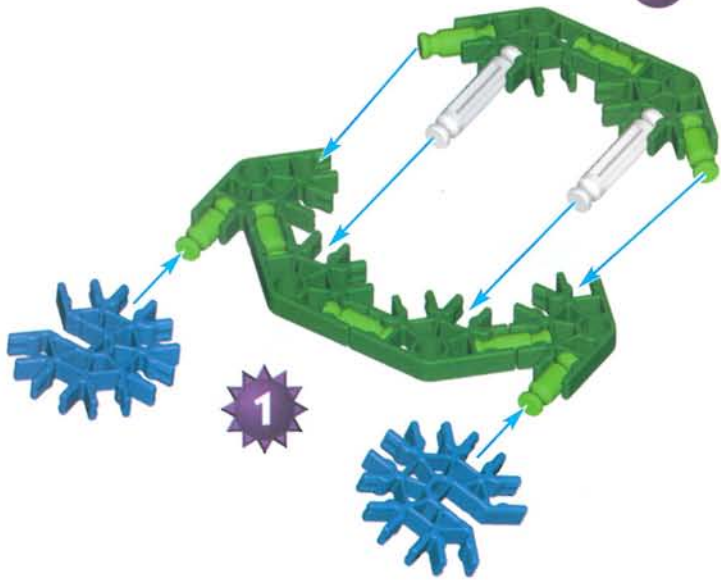

1 - 2

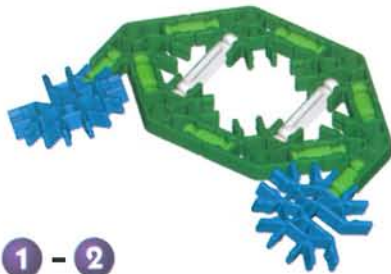

1 - 3

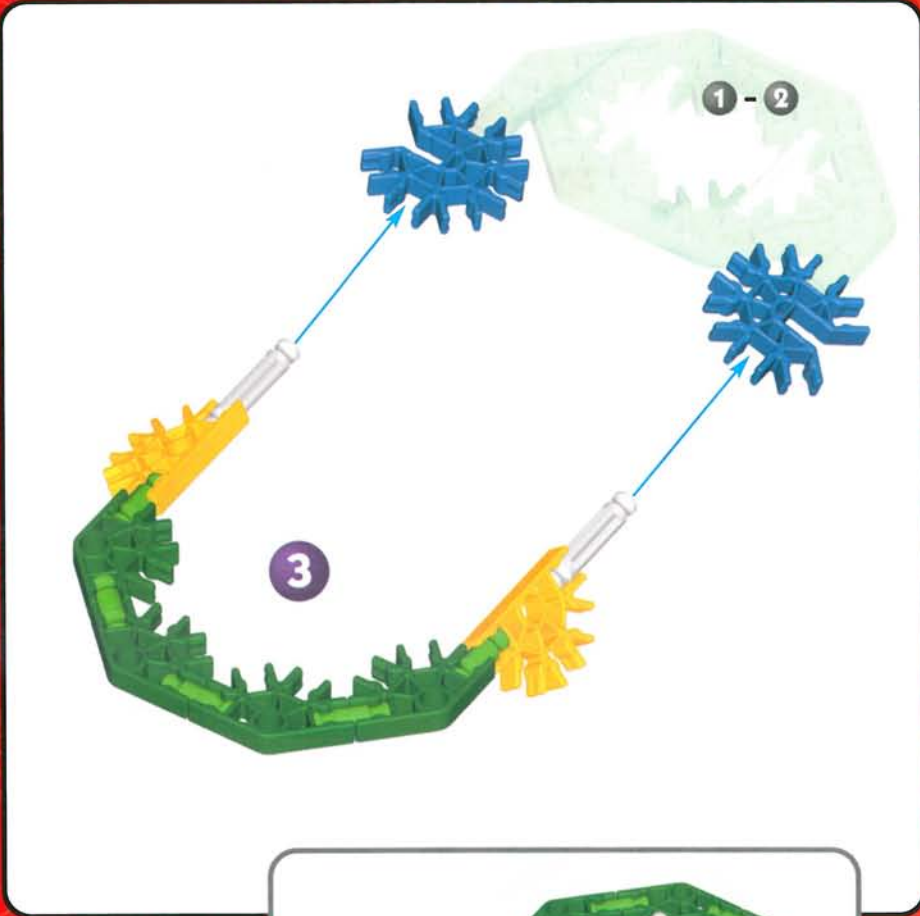
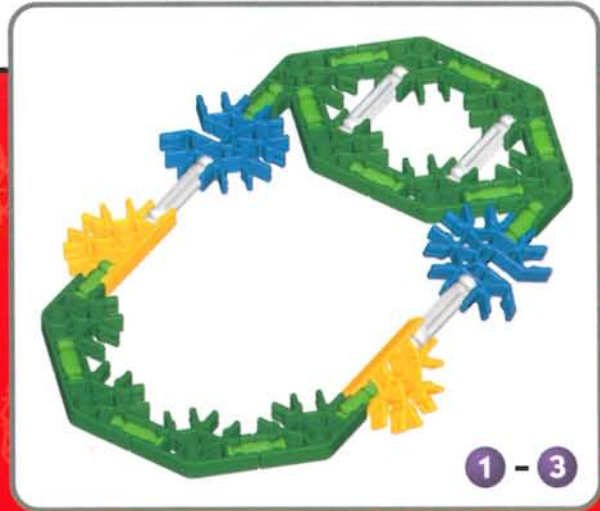

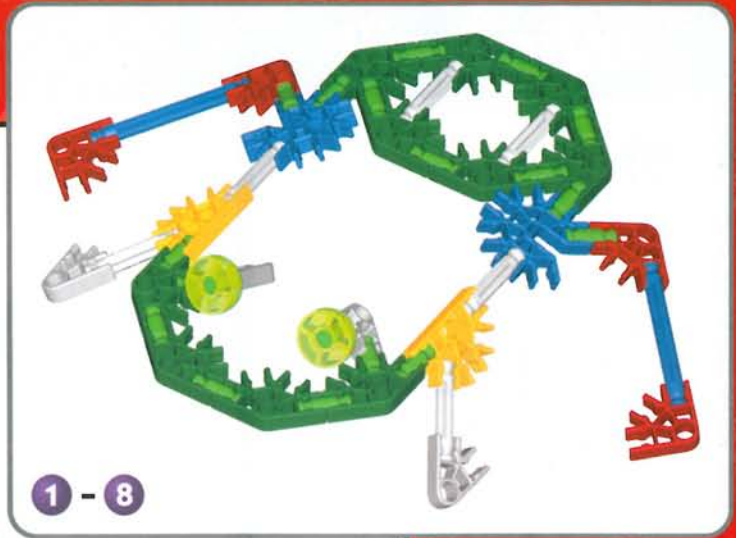
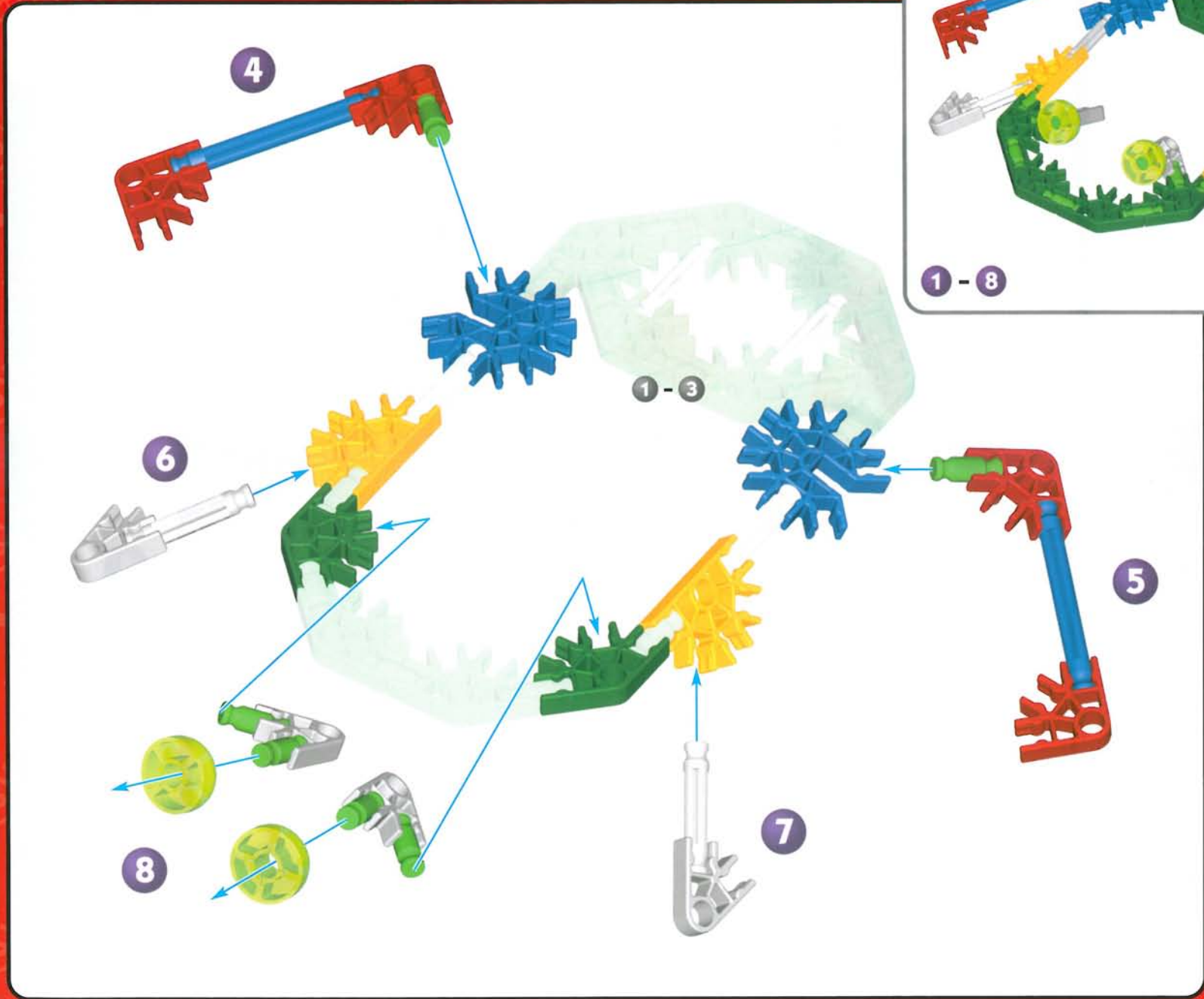

Windmill

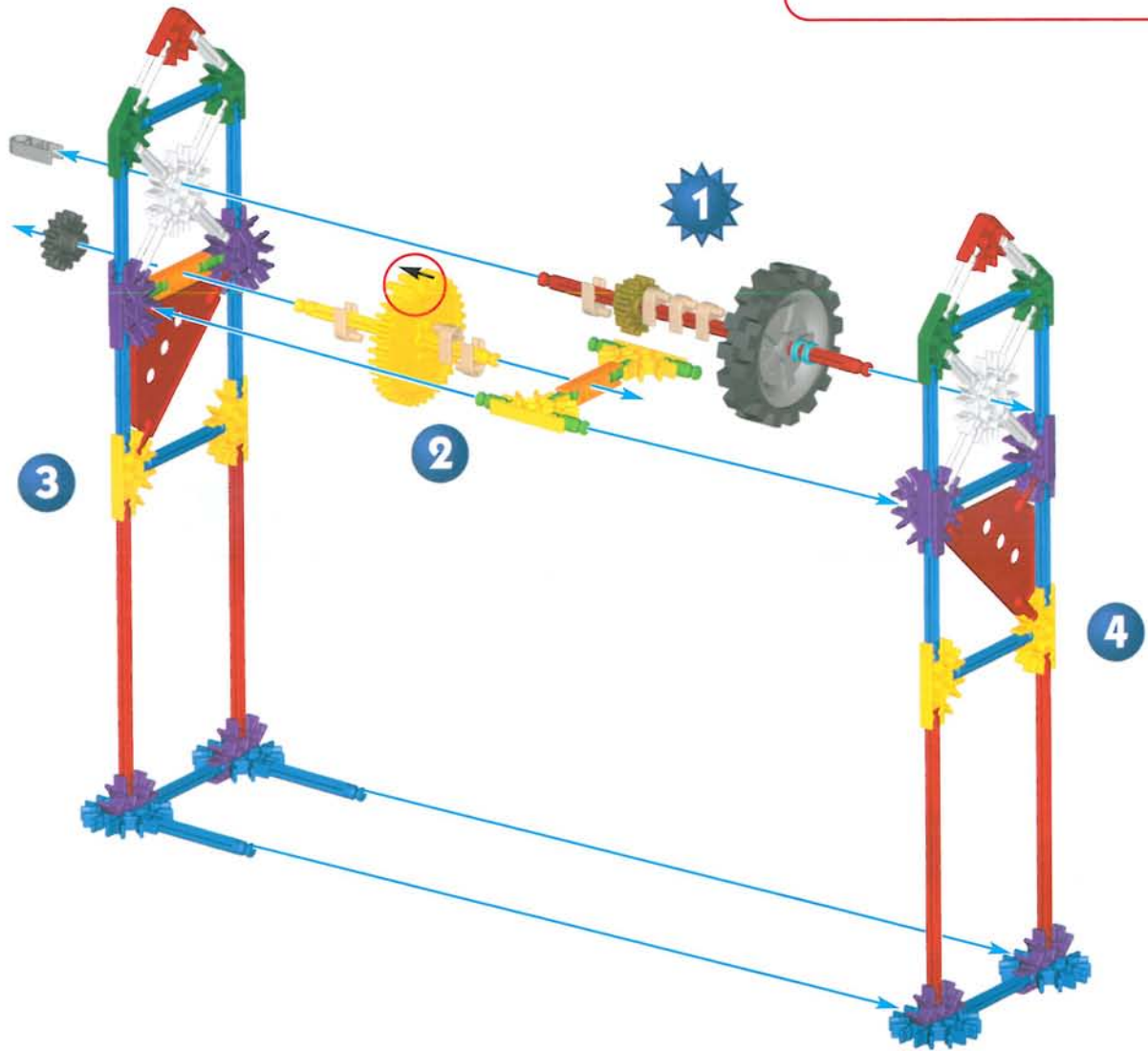
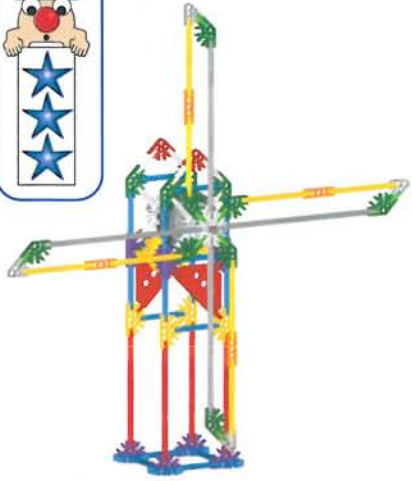
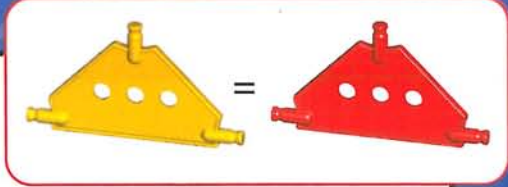

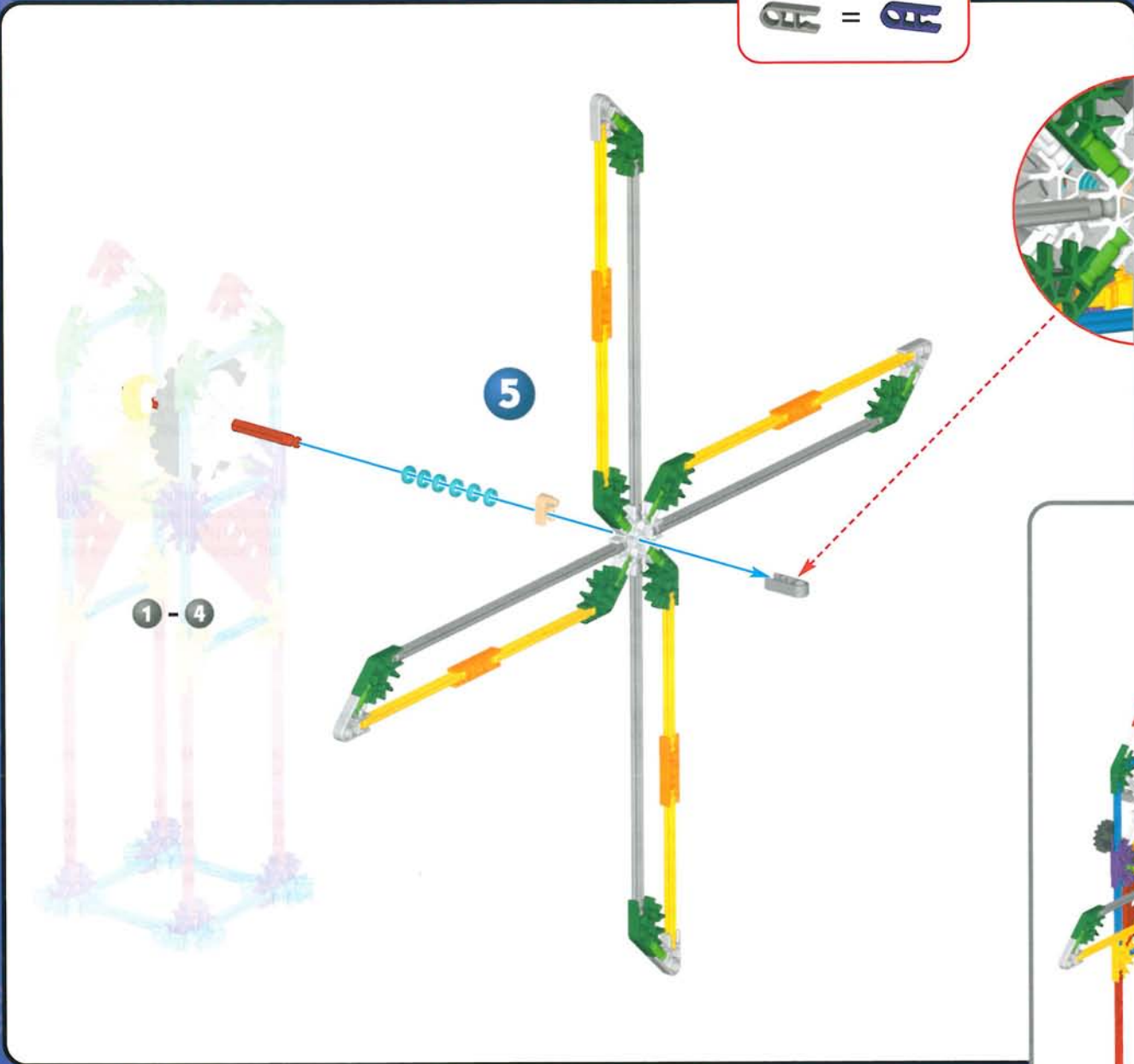

CONTINUANDO

As cores desbotadas indicam que esta secção já está montada. Passarás então a fazer a conexão da nova secção no local indicado pelas setas. Esta peça terá uma cor viva.

CONECTORES

É muito importante que posiciones os conectores azuis e cor de prateados numa direcção específica. Presta muita atenção às instruções e coloca estes conectores horizontal ou verticalmente, exactamente conforme se mostra nas ilustrações. Junta as partes simultaneamente e com firmeza até ouvires um "estalido." Assegura-te que as engrenagens ficam engrenadas.

ESPAÇADORES

Existirão certos pontos no teu modelo que necessitam a colocação de espaçadores azuis e prateados. Assegura-te que os contos cuidadosamente.

NL Nederlands

OPGEPAST: Hou het haar, de vingers, het gezicht en kledij verwijderd van alle bewegende onderdelen.

"HO! Ik ben je K'NEX bouwvriend. Heb je hulp nodig... Hier ben ik dan. Kijk naar me uit voor inlichtingen wanneer je modellen kiest met de gepaste moeilijkheidsgraad."

OUDEERS! Op deze manier kunt u uw kind helpen met K'NEX bouwen!

KLAAR OM TE BOUWEN

Om met je model te beginnen, vind eerst het nummer 1 en volg de nummers. Elk stuk heeft zijn eigen vorm en kleur. Kijk gewoonweg naar de afbeeldingen, vind de overeenstemmende stukken terug in je geheel en maak ze aan mekaar vast. Tracht je model in dezelfde richting te plaatsen als de aanwijzingen terwijl je bouwt en monteert.

VERDER NOG...

De vervaagde kleuren duiden aan dat dit deel reeds is opgebouwd. Gelieve het nieuwe deel vast te koppelen op de plaats aangeduid door de pijlen. De nieuwe delen die je toevoegt verschijnen in volle kleur.

KOPPELSTUKKEN

Er zijn blauwe en zilveren koppelstukken met speciale lange gleuven. Ze schuiven in mekaar zoals je kunt zien op de afbeeldingen. Duw deze onderdelen in mekaar tot je een "klik" hoort. Verzeker je ervan dat de tandwielen in mekaar passen.

TUSSENSTUKKEN

In je model zijn er plaatsen waar blauwe en zilveren tussenstukken moeten toegevoegd worden. Verzeker je ervan de juiste kleur te gebruiken en tel ze zorgvuldig.

SV Svenska

VARNING! Håll håret, fingrarna, ansiktet och kläderna borta från alla rörliga delar.

HEJ, jag är din K'NEX byggkompis. Behöver du hjälp... Jag finns här.

PLATSERNA, FÄRDIGA, BYGG

Hitta nummer 1 och följ numreringen. Varje del har sin egen form och färg. Titta på bilden, rikta upp motsvarande delar och tryck dem på plats.

FORTSÄTT

De bleka färgerna anger att denna sektion redan är byggd. Koppla den nya sektionen till stället som anges av pilarna. Dessa delar visas i klara färger.

KOPPLINGAR

Det finns blå och silverfärgade kopplingar med speciellt långa hål som skjuts samman. Tryck ihop delarna tills du hör ett klick-ljud. Kontrollera att kugghjulen är av rätt typ.

MELLANSTÄNGER

Det finns ställen i din modell där du måste placera mellanstänger. Använd rätt typ och räkna dem omsorgsfullt.

DA Dansk

FORSIGTIG: Hold hår, fingre, ansigt og påklædning på afstand af alle bevægelige dele.

HEJ, jeg er din K'NEX byggekammerat. Hvis du har brug for hjælp... så kom bare til mig.

PARAT, PÅ MÆRKERNE, BYG

Find nummer 1 og følg numrene. Hvert stykke har sin egen form og farve. Se på billedet, match stykkerne til hinanden og snap dem sammen.

SÅ FORTSÆTTER VI

De falmede farver betyder, at dette afsnit allerede er bygget. Sæt det nye afsnit sammen på det sted, som pilene peger mod. Disse dele vil

SAMLESTYKKER

Der er blå og sølvfarvede samlestykker med særlige lange slidser, som skydes sammen. Skub delene sammen, indtil du hører et "klik". Sørg for at gearene griber ind i hinanden.

AFSTANDSSTYKKER

Der er steder i modellen, hvor du får brug for at tilføje afstandsstykker. Sørg for at bruge de rette stykker og tæl den omhyggeligt.

NO Norsk

ADVARSEL: Hold hår, fingre, ansikt og klesplagg borte fra alle bevegelige deler.

HEI, jeg er din K'NEX byggekamerat. Trenger du hjelp... er jeg her.

KLAR, FERDIG, BYGG

Finn tallet 1 og følg numrene. Hver del har sin egen form og farge. Se på bildet, finn tilsvarende deler og smekk dem sammen.

FORTSETT

De bleke fargene viser deg at denne delen allerede er bygget. Fest den nye delen der pilen peker. Disse delene har sterke farger.

SKJØTEMUNNSTYKKER

Det er blå og sølvfargede skjøtemunnstykker med spesielt lange åpninger, som glir sammen. Skyv delene sammen inntil du hører et klink. Pass på at girene griper inn i hverandre.

MELLOMLEGG

Noen steder må du bruke mellomlegg i modellen din. Pass på å bruke de riktige mellomleggene og tell dem nøye.

FI Suomi

VAROITUS! Pidä hiukset, sormet, kasvot ja vaatteet loitolla kaikista liikkuvista osista.

HEI, olen K'NEX rakennuskaverisi. Tarvitsetko apua... olen paikalla.

PAIKOILLANNE, VALMIIT, RAKENTAKAA

Löydä numero 1 ja seuraa numerointia. Jokaisella osalla on oma muotonsa ja värinsä. Katso kuvaa, sovita osat ja paina ne yhteen.

JATKA

Himmeät värit osoittavat, että tämä kokonaisuus on jo rakennettu. Liitä uusi kokonaisuus nuolien osittamaan paikkaan. Nämä osat näkyvät kirkkain värein.

LIITTIMET

Sarjassa on sinisiä ja hopeanvärisiä liittimiä, joissa on erityisen pitkiä aukkoja, jotka työnnetään toisiinsa. Työnnä osat yhteen kunnes kuulet napsahduksen. Varmista, että hammaspyörät sopivat.

VÄLITANGOT

Mallissasi on paikkoja joihin sinun on lisättävä välitankoja. Varmista, että käytät oikeita ja laske ne huolellisesti.

FR Français

ATTENTION : Garde les cheveux, les doigts, la figure et les vêtements à l'écart de toutes les pièces mobiles.

"BONJOUR ! Je suis ton camarade de montage K'NEX. Si tu as besoin d'un coup de main... Je suis là ! Cherche-moi que je puisse te guider et t'aider à sélectionner les modèles correspondant à ton niveau."

PARENTS ! Voilà comment vous pouvez aider votre enfant à construire à l'aide de K'NEX !

PRÊT À MONTER

Pour commencer ton modèle, trouve le 1 et suis les chiffres. Chaque pièce a sa propre forme et sa propre couleur. Il suffit de regarder les illustrations pour retrouver les pièces correspondantes dans le jeu et de les connecter ensemble. Essaie de situer ton modèle dans le même sens que les instructions durant le montage.

SUITE...

Les couleurs dégradées indiquent que cette section est déjà montée. Tu dois connecter la section suivante à l'endroit indiqué par les flèches. Les nouvelles pièces ajoutées auront une couleur vive.

CONNECTEURS

Tu trouveras des connecteurs bleus et argentés comportant des fentes extra-longues. Ils se glissent l'un dans l'autre tel qu'illustré. Pousse les pièces ensemble jusqu'à ce que tu entendes un "clac". Vérifie que les engrenages s'enclenchent bien les uns dans les autres.

PIÈCES D'ÉCARTEMENT

Il y a des endroits dans ton modèle où tu dois ajouter des pièces d'écartement bleues et argentées. Assure-toi d'utiliser la couleur exacte et de compter les pièces avec soin.

ES Español

PRECAUCIÓN: Mantén el cabello, los dedos, la cara y la ropa alejada de las piezas móviles.

"¡HOLA! Soy tu compañero en la construcción. Si necesitas ayuda... ¡aquí estoy! Búscame para que te guíe mientras eliges modelos que corresponden al nivel de tus capacidades."

¡PADRES! ¡Aquí encontrarán cómo pueden ayudar a su niño para que construya con K'NEX!

TODO LISTO, COMIENZA A CONSTRUIR

Para comenzar tu modelo, busca el 1 y sigue los números. Cada pieza tiene su propia forma y color. Simplemente mira los dibujos, busca las piezas correspondientes en tu juego y después conéctalas. Mientras construyes, trata de colocar tu modelo en la misma dirección que se muestra en las instrucciones.

CONTINÚA

Los colores desteñidos muestran que esta sección ya está construida.

Conecta las nuevas secciones en los lugares señalados por las flechas. Las nuevas piezas que agregues estarán en colores vivos.

CONECTORES

Hay conectores azules y plateados con ranuras largas especiales. Se enganchan deslizándose como ves en los dibujos. Conecta estas piezas empujándolas hasta que oigas "clac". Asegúrate de que los engranajes concuerdan.

ESPACIADORES

Hay lugares en tu modelo donde tendrás que agregar Espaciadores azules y plateados. Cerciórate de usar el color correcto y cuéntalos con cuidado.

DE Deutsch

VORSICHT: Haare, Finger, Gesicht und Kleidungsstücke nicht mit beweglichen Teilen in Berührung kommen lassen.

"HALLO, ich bin dein K'NEX-Bauhelfer. Ich helfe dir jederzeit! Zum Beispiel bei der Auswahl der Modelle mit dem richtigen Schwierigkeitsgrad."

ELTERN! So können Sie ihrem Kind beim Bauen mit K'NEX helfen!

AUF DIE PLÄTZE, FERTIG, LOS! DAS BAUEN BEGINNT

Um mit dem Bauen deines Modells zu beginnen, suche die Nummer 1 und folge den laufenden Nummern. Jedes Teil hat seine eigene Form und Farbe. Schau dir einfach die Abbildungen an, such die Teile in deinem Bausatz, die so aussehen wie das, was du auf der Abbildung siehst und steck sie ineinander. Versuche, dein Modell beim Zusammenbauen so zu orientieren, dass es in die gleiche Richtung weist, wie es in den Anleitungen beschrieben und gezeigt wird.

UND WEITER GEHT'S

Blasse Farben weisen darauf hin, dass dieser Streckenabschnitt bereits zusammengebaut ist. Der neue Streckenabschnitt wird dort befestigt, worauf die Pfeile deuten. Die neuen Teile, die du anbaust, sind knallbunt angezeigt.

STECKANSCHLÜSSE

Blaue und silberfarbene Steckanschlüsse haben besonders lange Schlitze. Wie du auf der Abbildung sehen kannst, lassen sie sich ineinander schieben. Achte beim Aneinanderfügen dieser Teile darauf, dass du ein Klickgeräusch hörst. Erst dann sind die Teile fest miteinander verbunden. Vergewissere dich, dass die Zahnräder ineinander greifen.

ABSTANDSSTÜCKE

An bestimmten Stellen in deinem Modell musst du Abstandshalter, sogenannte Spacer, einbauen. Diese Abstandshalter sind blau und silberfarben. Achte darauf, dass du die richtige Farbe wählst und dass du die richtige Anzahl davon verwendest.

IT Italiano

ATTENZIONE: tenere i capelli, le dita, il viso e i vestiti lontano da tutte le parti in movimento.

"CIAO, sono il tuo amico costruttore K'NEX. Troverai modelli per tre livelli di costruzione. Cercami ogni volta che vuoi iniziare a costruire qualcosa e mi troverai con un segnale che mostra la difficoltà di ogni modello."

GENITORI! Ecco come potete aiutare i vostri figli a costruire con K'NEX!

PRONTI, PARTENZA, VIA ALLA COSTRUZIONE

Per iniziare il modello, cerca il numero 1 e segui i numeri. Ogni pezzo ha una sua forma e un suo colore. Guarda la figura, trova i pezzi corrispondenti nel set e mettili insieme. Cerca di tenere il modello nella stessa direzione della figura e in tal modo sarà più semplice attaccare i pezzi nei posti giusti.

ANDIAMO AVANTI

I colori spenti ti dicono che questa sezione è già stata costruita. Dovrai collegare la nuova sezione al punto indicato dalla punta della freccia. Questo pezzo avrà un colore brillante.

CONNETTORI

È molto importante posizionare i connettori blu e argento in una specifica direzione. Presta molta attenzione alle istruzioni e posiziona i connettori orizzontalmente o verticalmente proprio come illustrato. Spingi con forza fino ad udire un "clac". Accertati che le marce ingranano.

SPAZIATORI

Ci sono punti nel tuo modello a cui dovrai aggiungere spaziatori blu e argento. Accertati di contarli attentamente.

PT Português

CUIDADO: Mantém o cabelo, os dedos, a cara e a roupa afastados de todas as peças móveis.

"OLÁ! Eu sou o teu companheiro que te vai ajudar a montar o teu K'NEX. Encontrarás modelos destinados a três diferentes níveis de dificuldade de construção. Procura-me antes de começares a montar cada construção; eu estarei segurando num letreiro para te mostrar qual o grau de dificuldade que apresenta cada modelo."

PAIS! Eis como os pais podem ajudar os filhos a fazer as suas construções com K'NEX!

ESTÁS PRONTO? COMEÇA POIS A CONSTRUIR

Para começar o teu modelo, procura o 1 e segue os números. Cada peça tem a sua própria forma definida e cor. Basta simplesmente olhares para a ilustração, procurar as peças do teu jogo correspondentes às que estás a ver e, em seguida, conectar umas nas outras. Enquanto estás a montar as peças, tenta manter o teu modelo na mesma direção, conforme mostrado na ilustração, para assim ligares as peças correctamente.

KNEX.COM

Sold separately.
Vendus séparément.
Se venden por separado.
Separat erhältlich.
Venduti separatamente.
Vendidos separadamente.
Afzonderlijk verkocht.
Säljes separat.
Sølges separat.
Seiges separat.
Myydään erikseen.



Product and colors may vary. Models can be built one at a time.
K'NEX is a registered trademark of K'NEX Limited Partnership Group.
Le produit et les couleurs peuvent varier.
La plupart des modèles ne peuvent être construits que un à un.
K'NEX est une marque déposée de K'NEX Limited Partnership Group.
El producto y los colores podrán variar.
La mayoría de los modelos se puede construir uno a la vez.
K'NEX es una marca registrada de K'NEX Limited Partnership Group.

Manufactured under U.S. Patents/Fabriqu e sous brevets
am ricains/Fabricado bajo patentes de EE.UU. 5,061,219; 5,199,919;
5,350,331; 5,137,486; D394,286.

Other U.S. and foreign patents pending. Conforms to ASTM F963-03.
Autres brevets am ricains et  trangers en instance. Conforme aux
ASTM F963-03. Otras patentes de EE.UU. y pa ses extranjeros
pendientes. Cumple con F963-03 de la ASTM.



US 1-800-KID-KNEX USA/Canada only (English only)

GB 00800-22427276 UK/Ireland only
Customer Service outside the USA, CAN, GBR
please contact local distributor.
Distributor information can be found at:
<http://www.knex.com/contact/international.php>



US Consumer Services
K'NEX
P.O. Box 700
Hatfield, PA 19440-0700

GB K'NEX
Newport Consumer Services
Hasbro UK Ltd., Caswell Way
Newport, Gwent NP9 0YH



email@knex.com



 2007 K'NEX
Limited Partnership Group
P.O. Box 700
Hatfield, PA 19440-0700
93233/407425.11-V1-04/07