

**Picture
Frame**

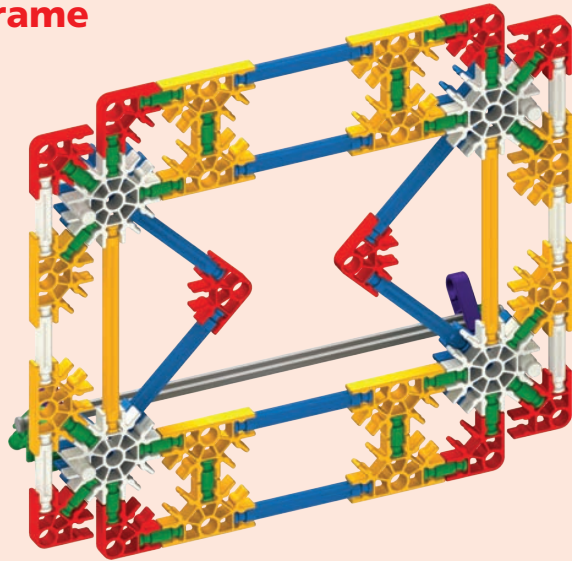

Air Ride

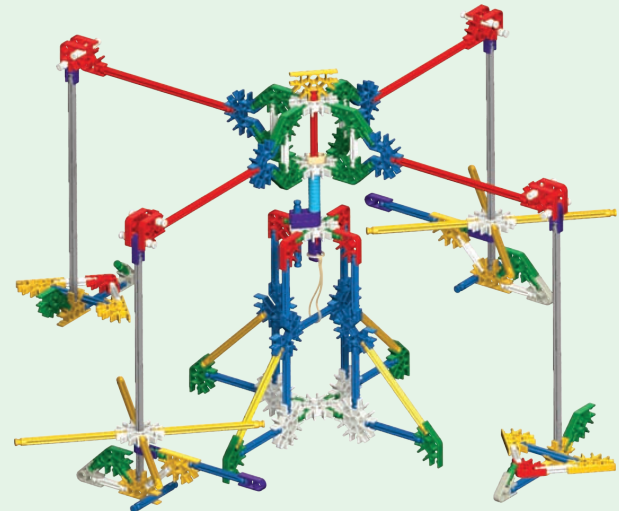

**Antique
Car**

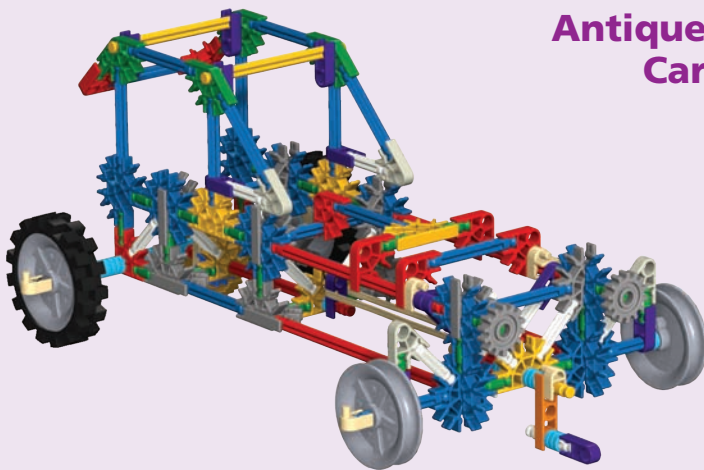

Cycle



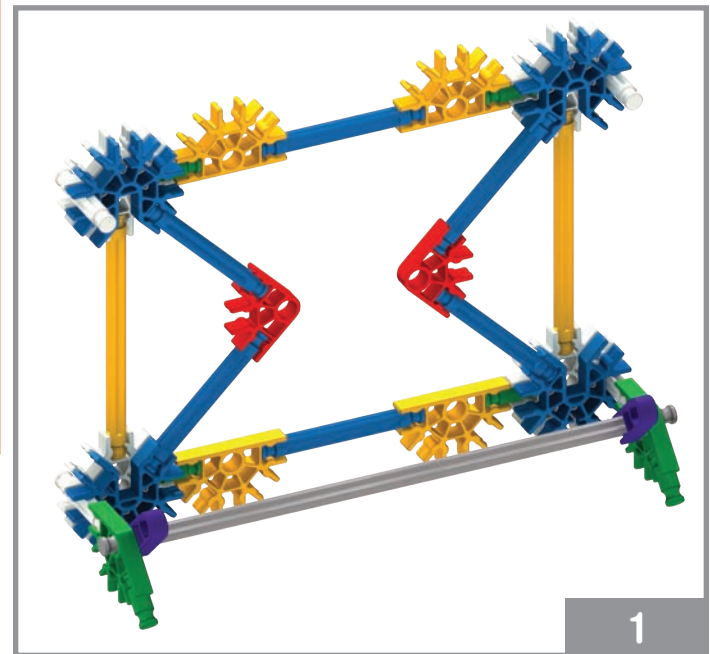
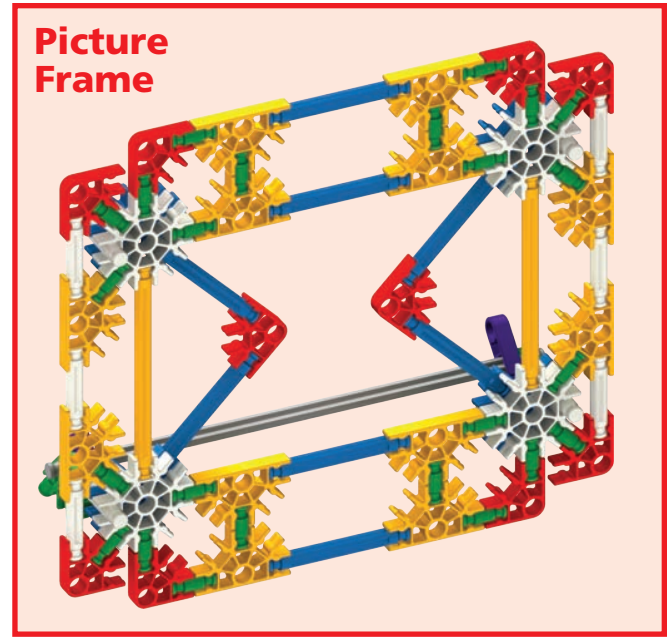
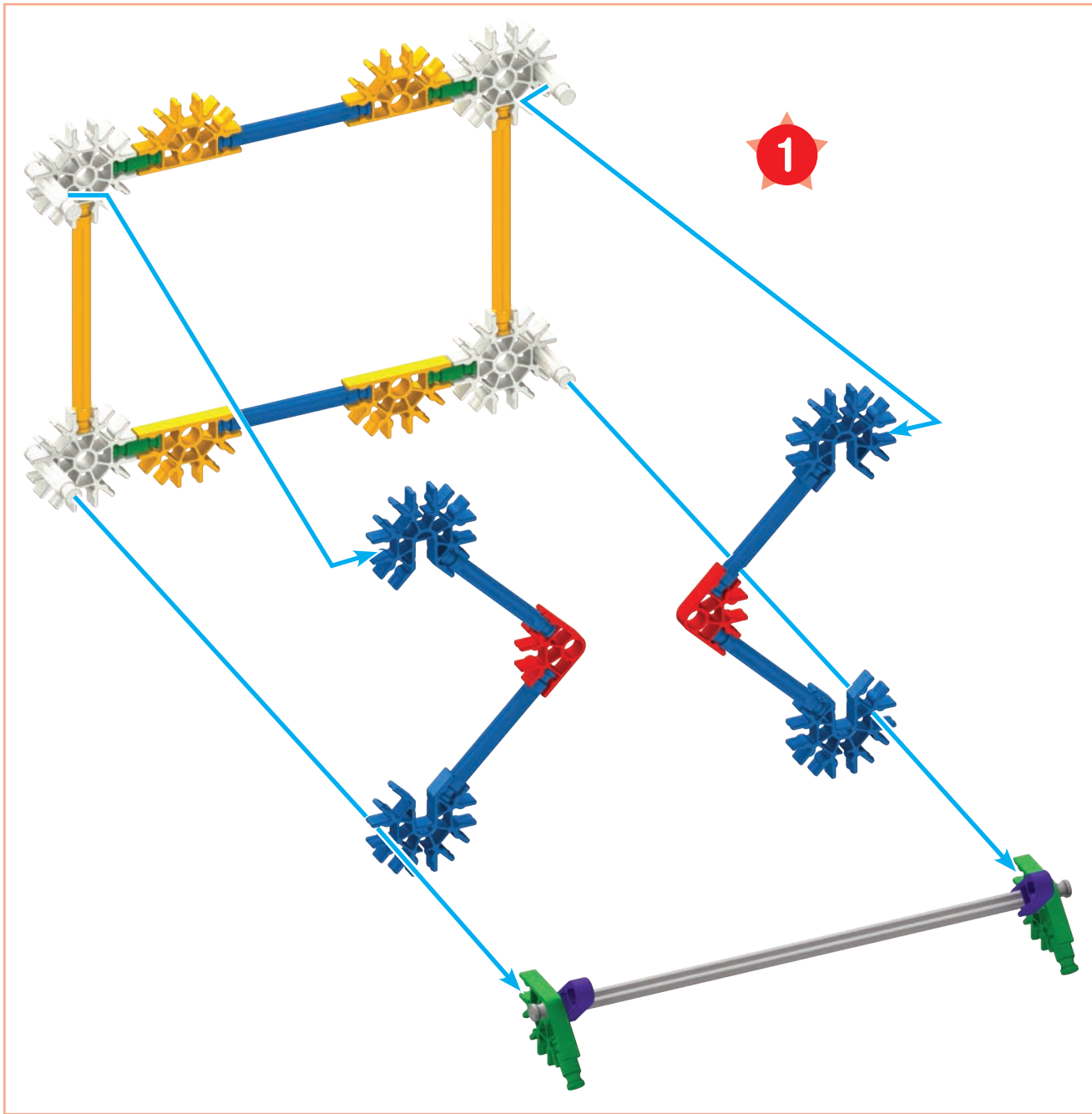

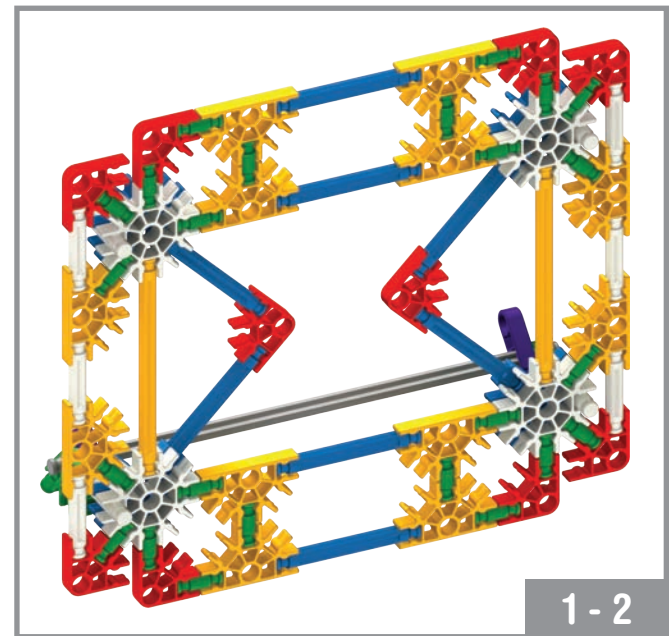
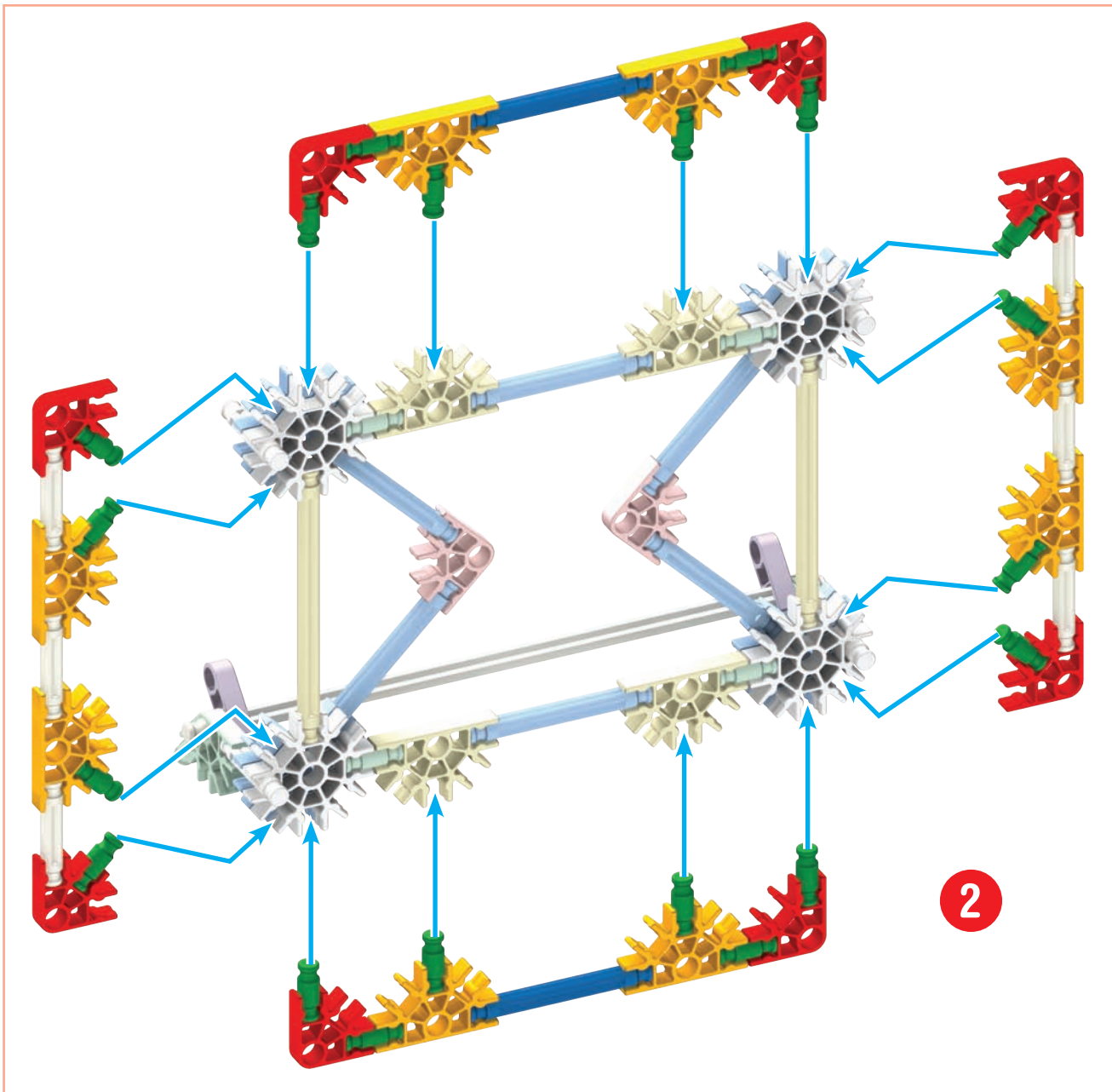

Air Ride

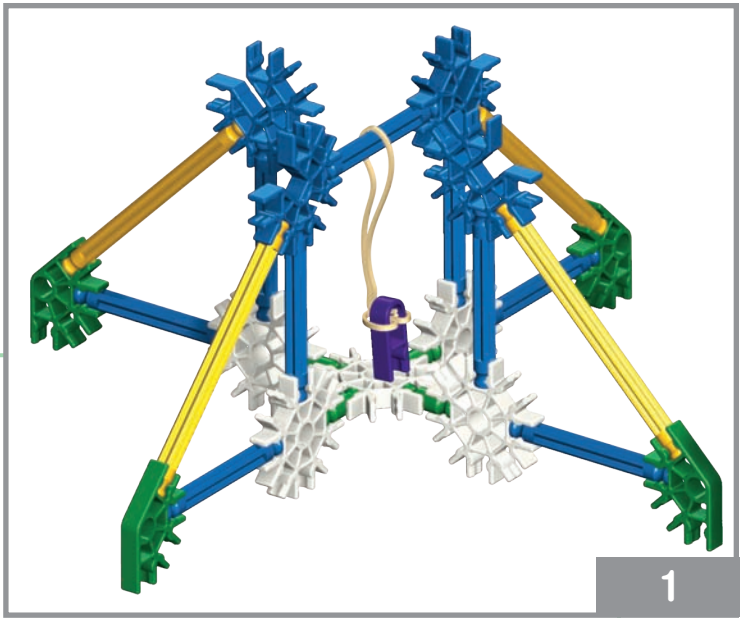
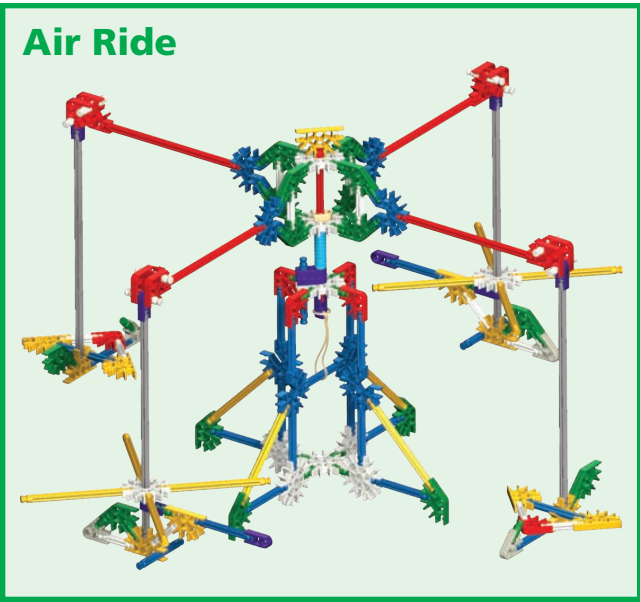

1

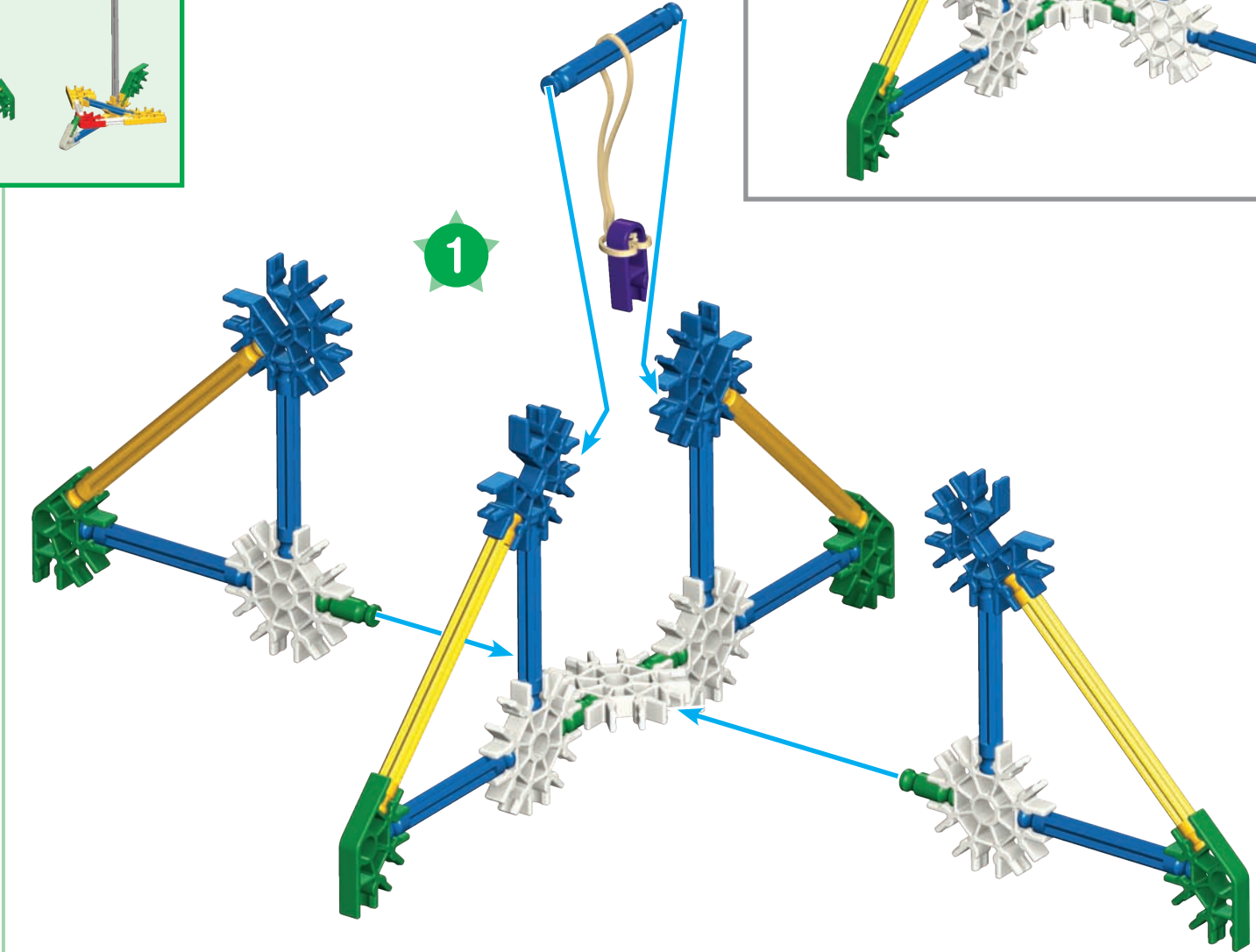
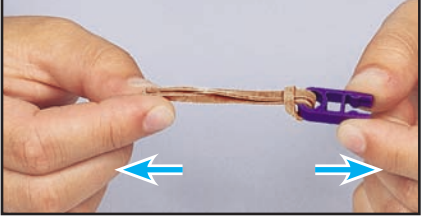

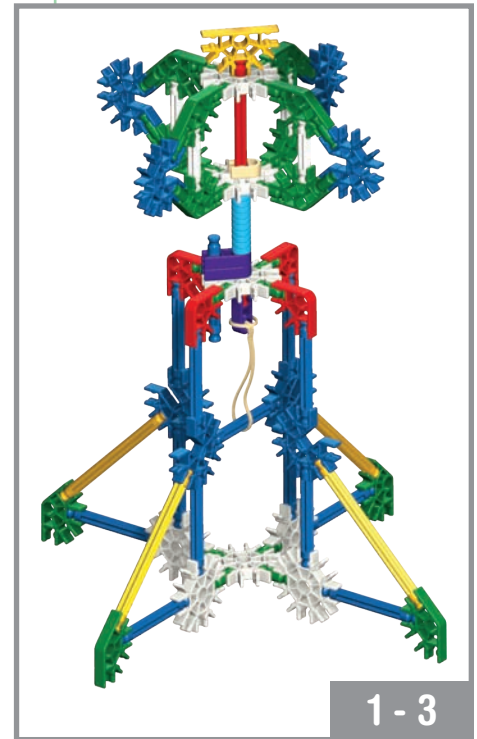
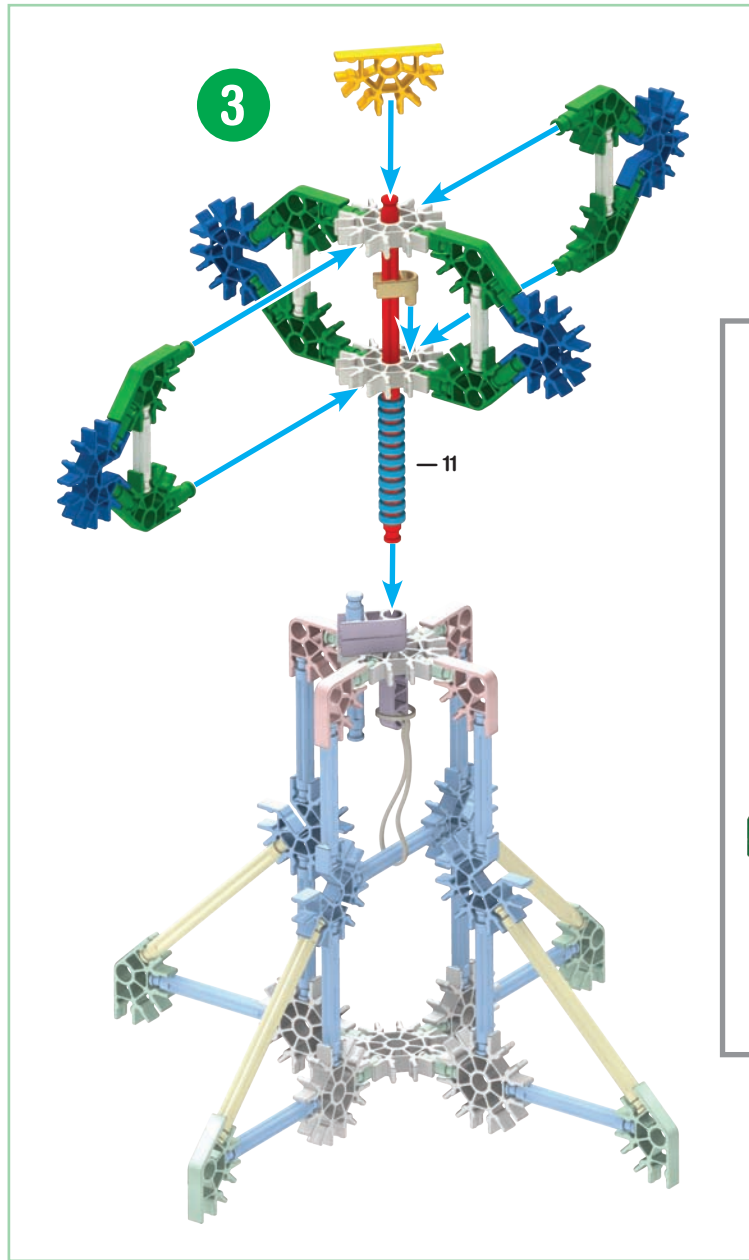
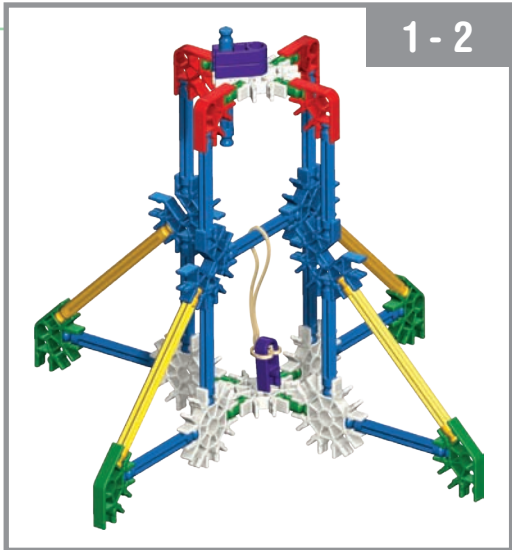
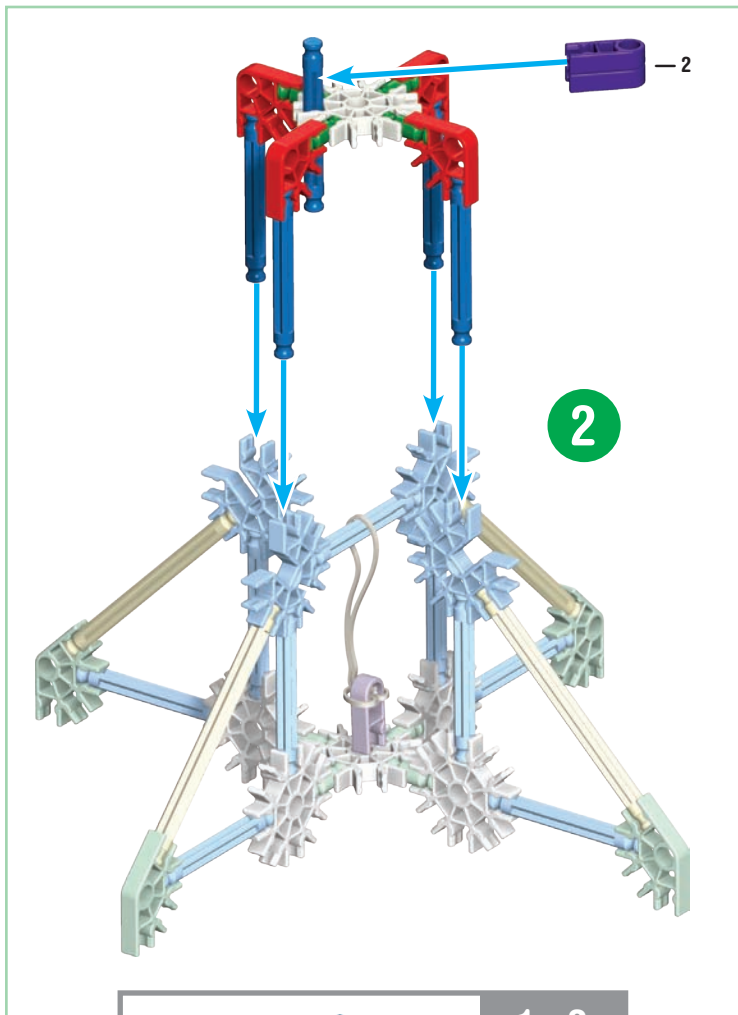

4

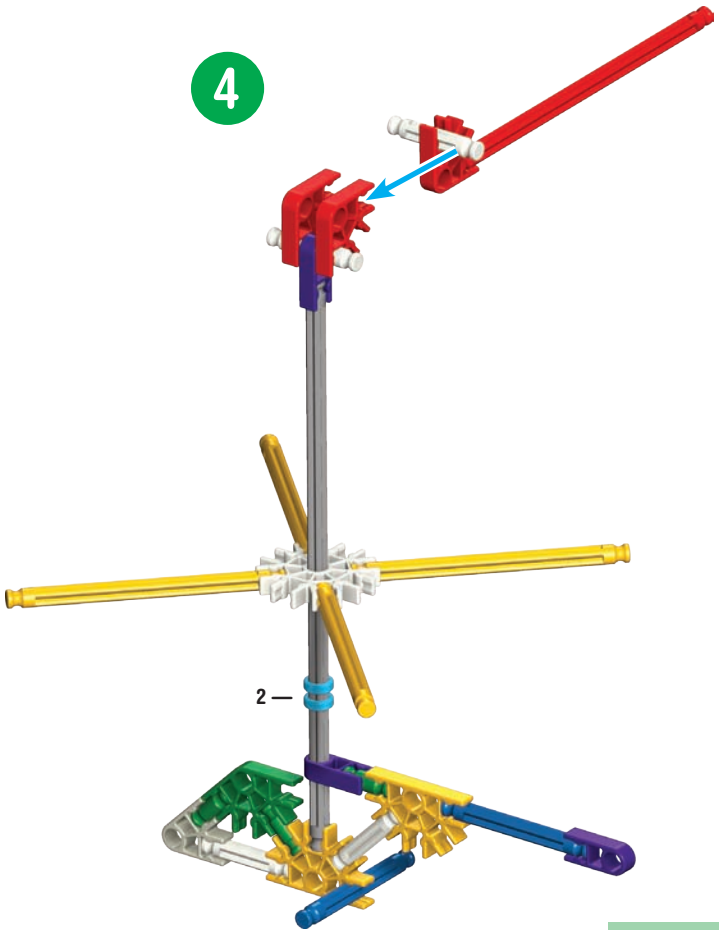

2

x2



5

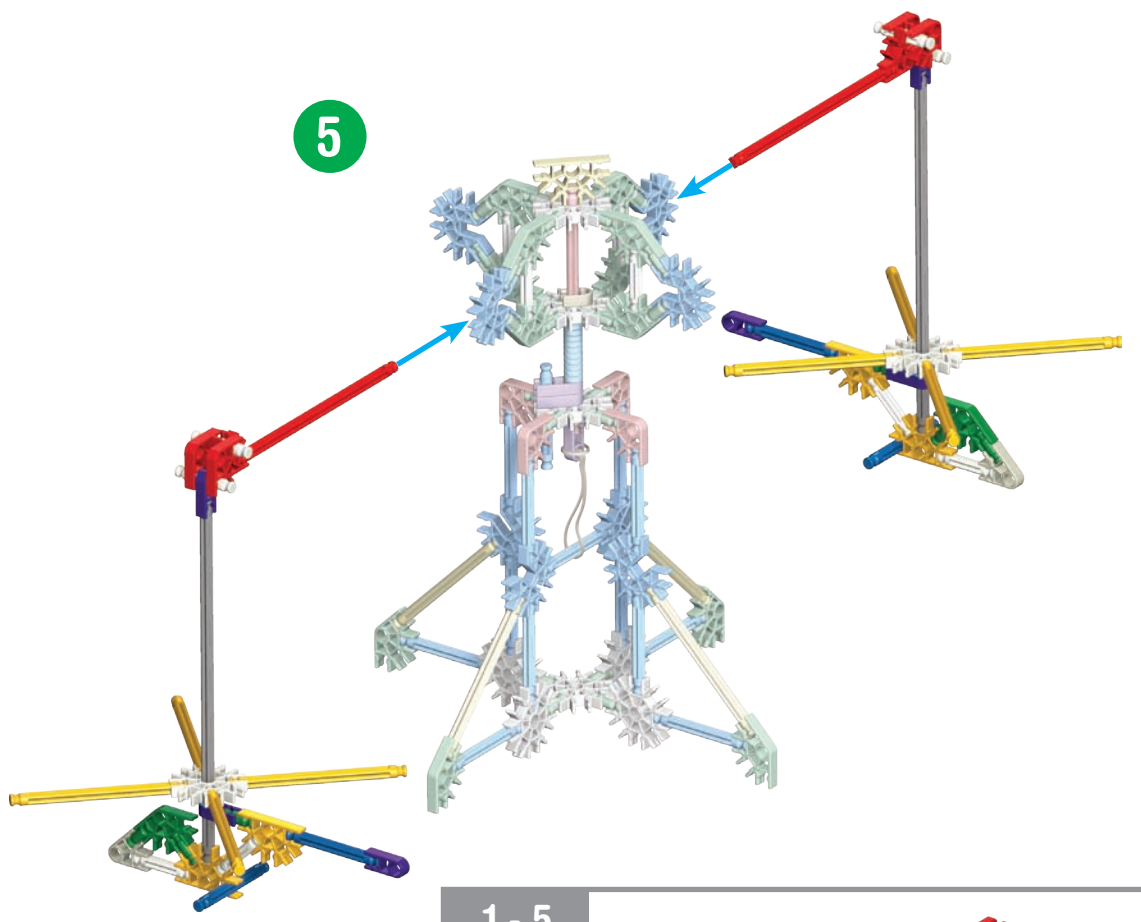

1-5

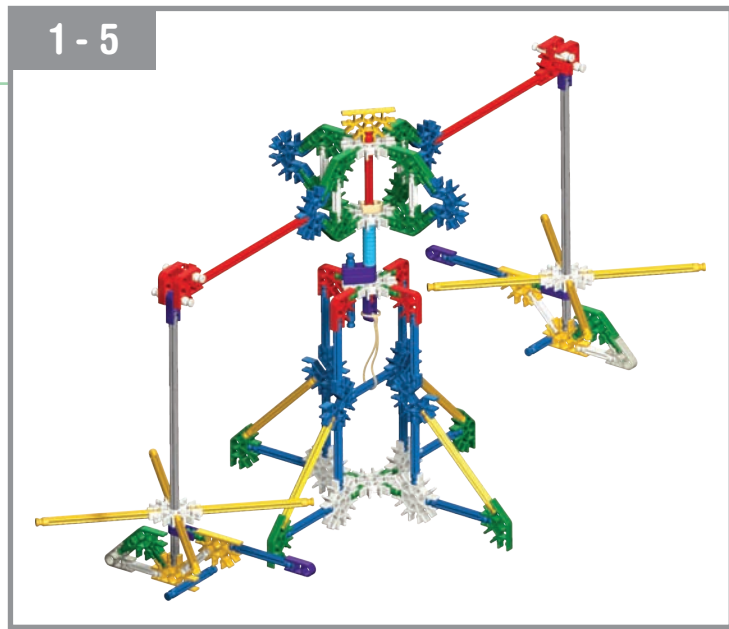

6



6

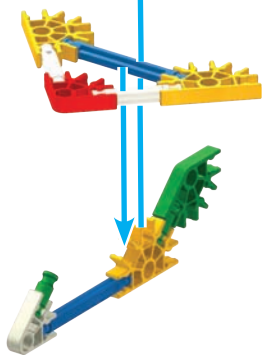

x2

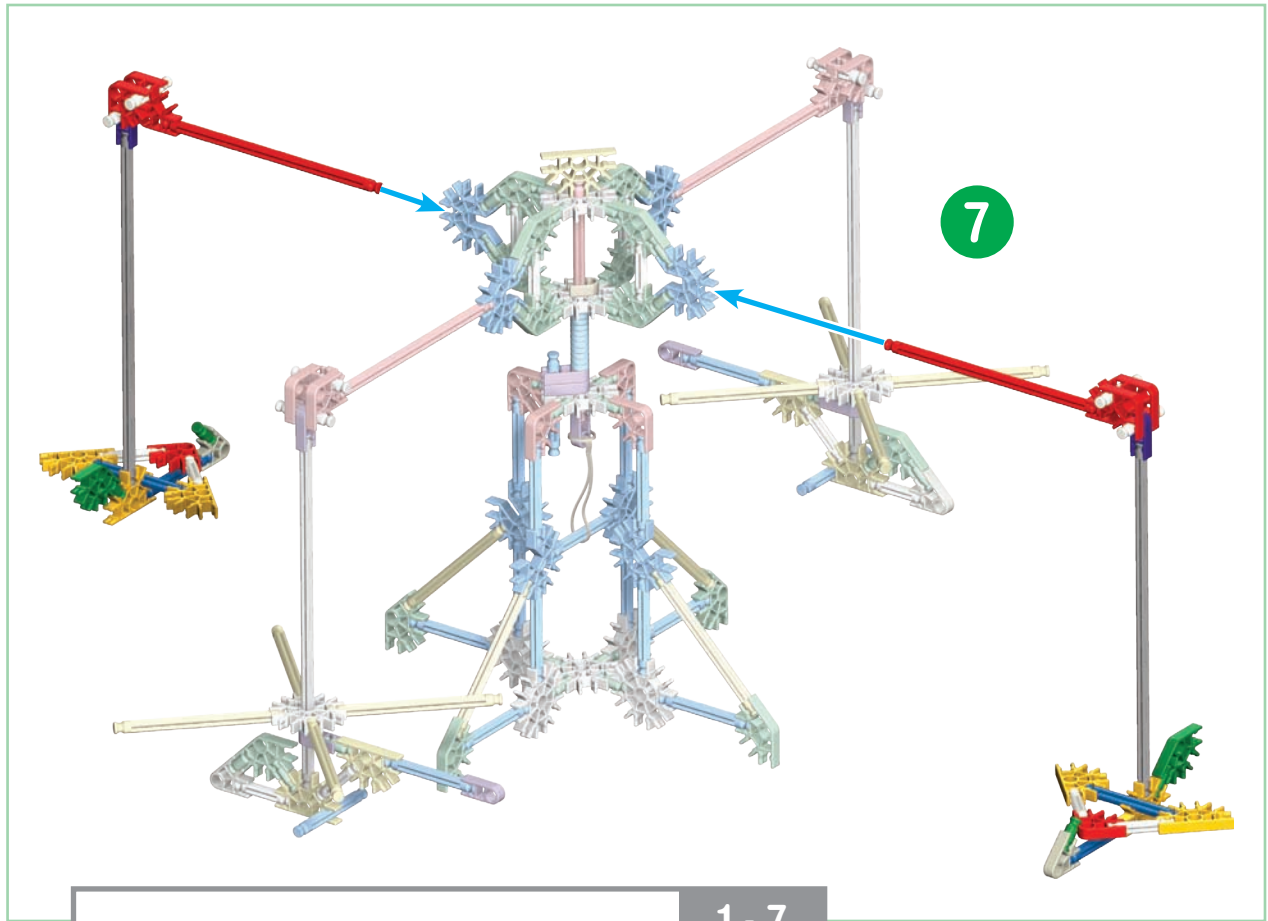

7

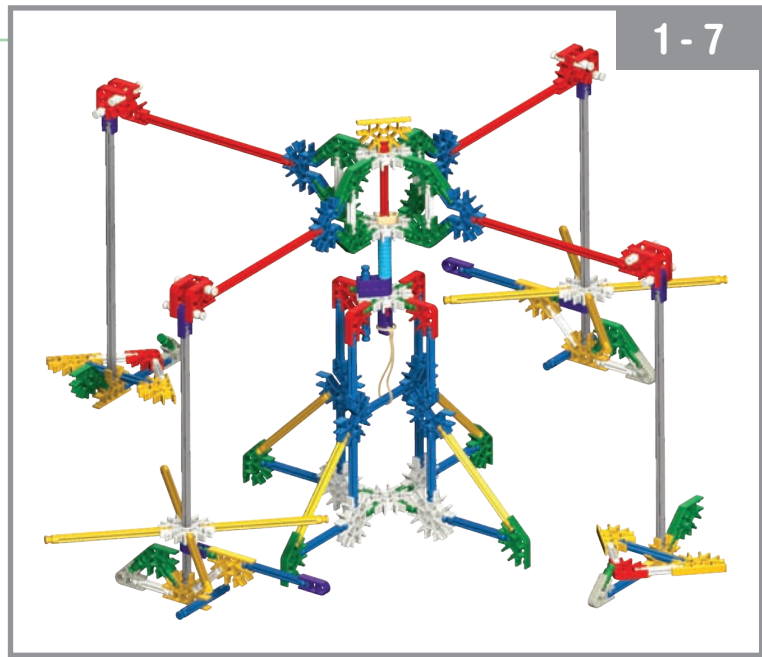

1-7

Antique Car

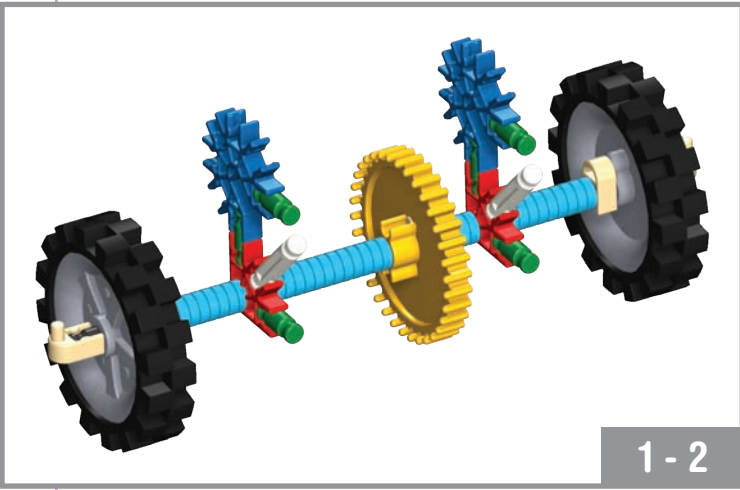
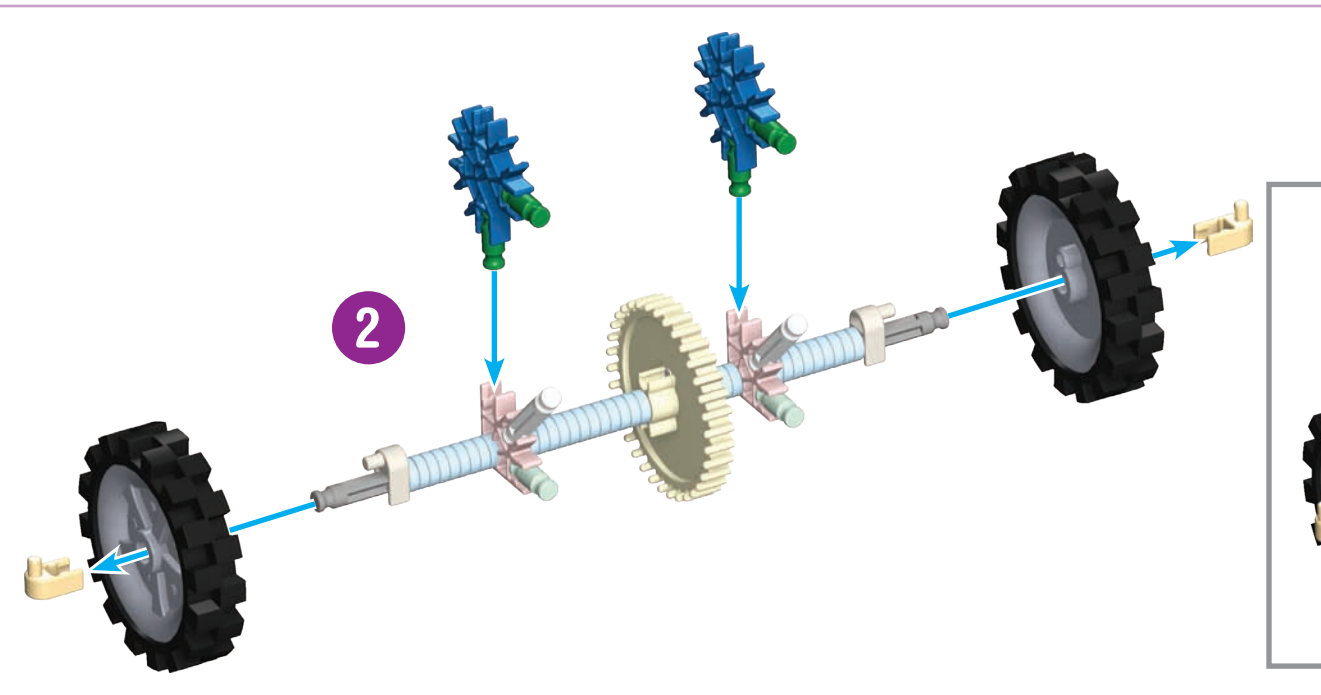
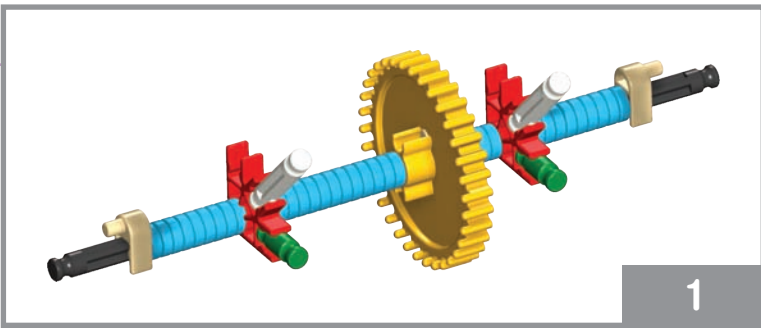
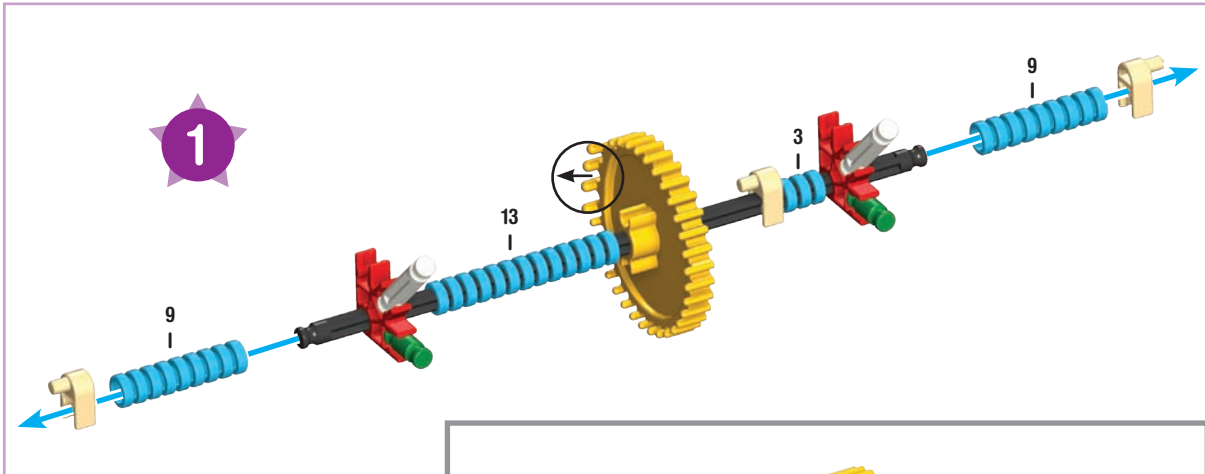

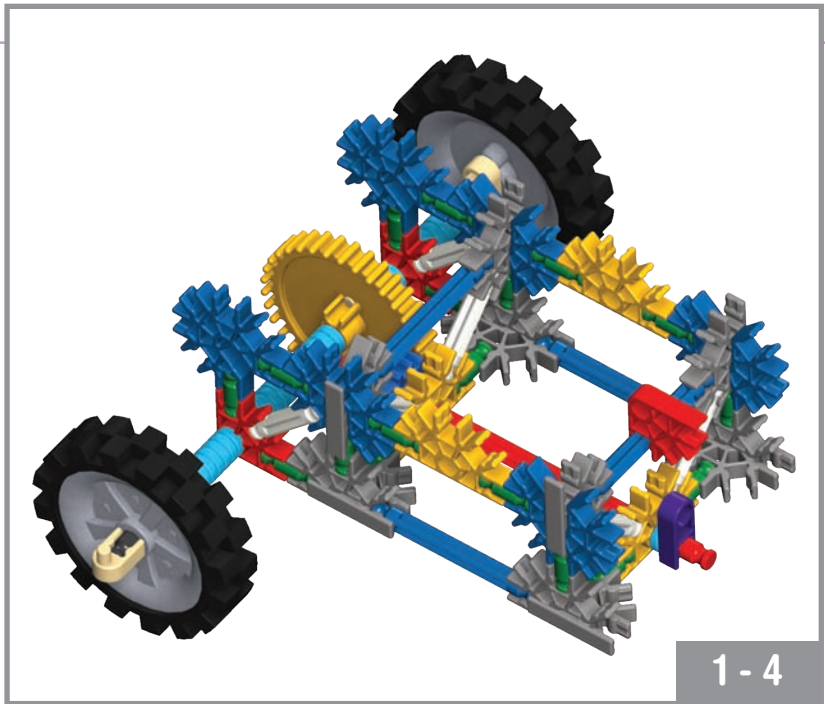
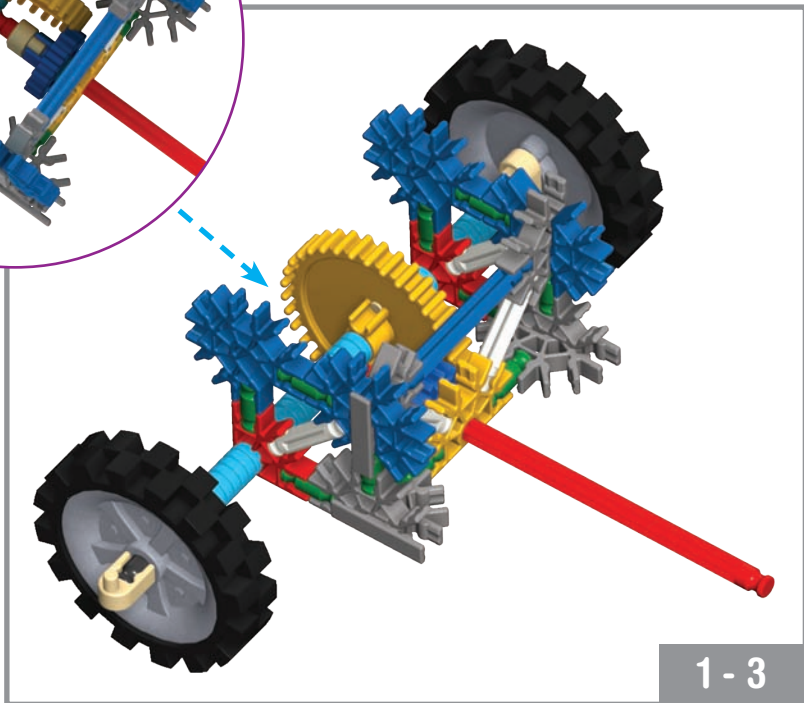
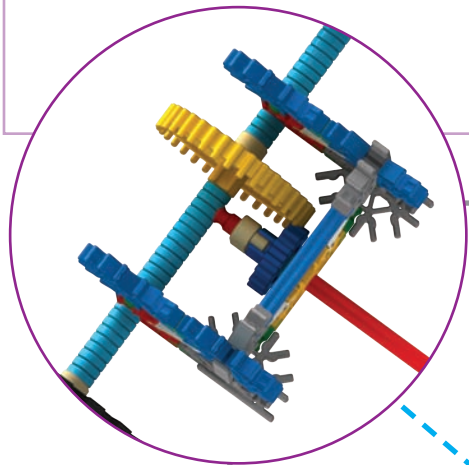
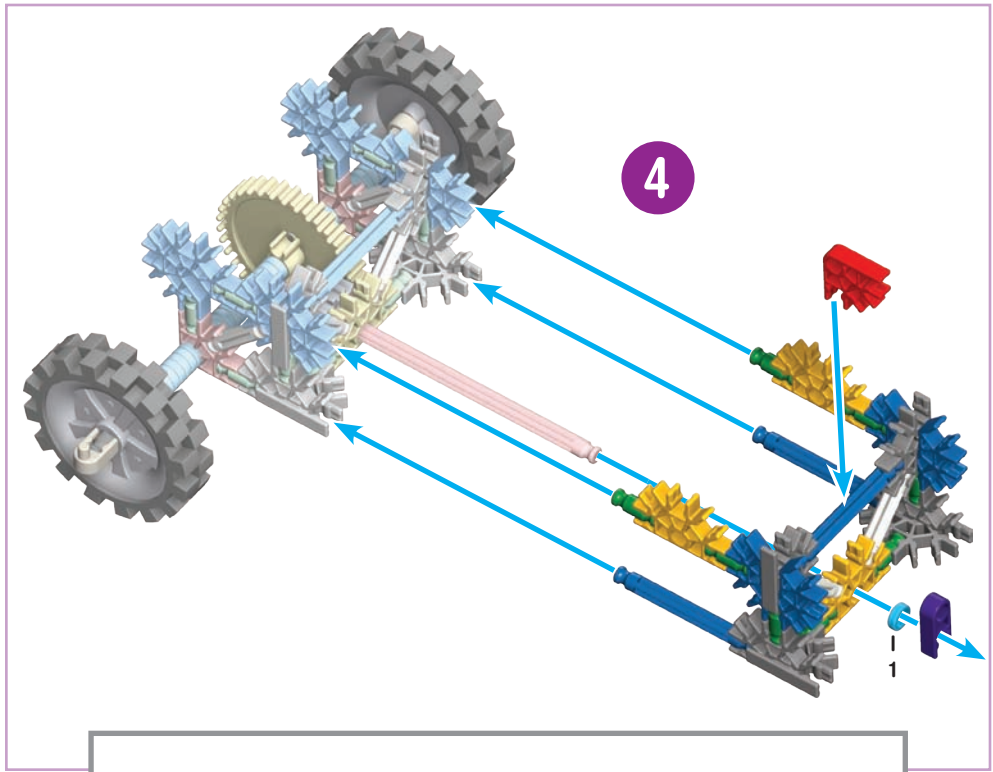
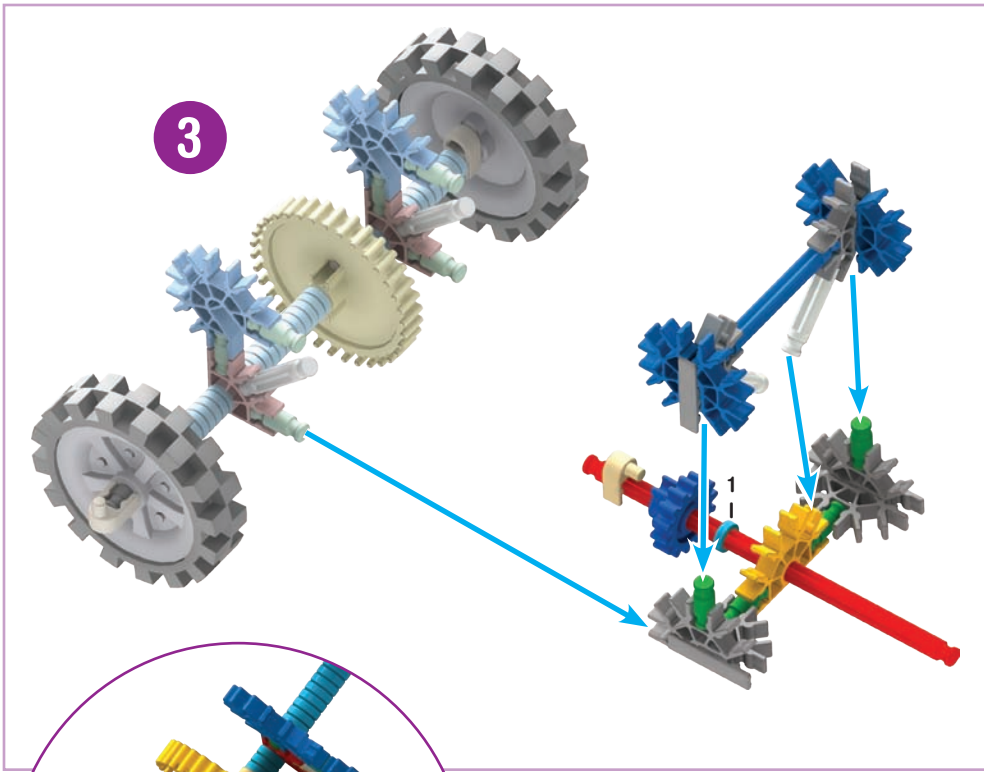

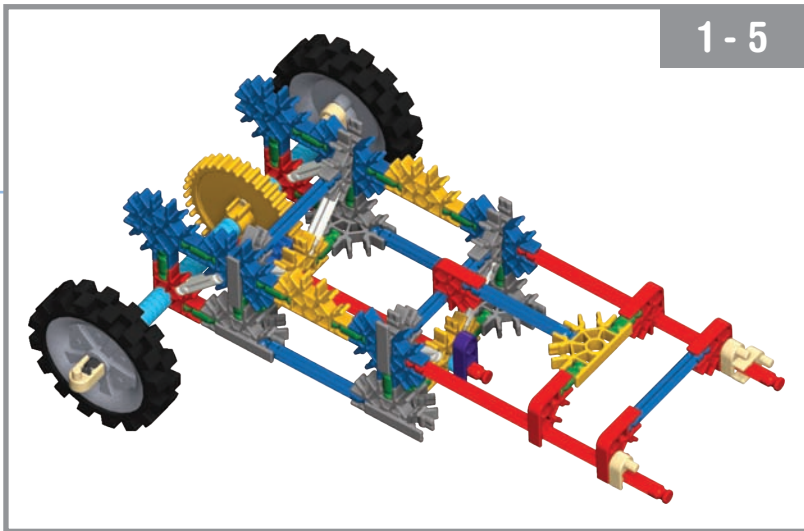
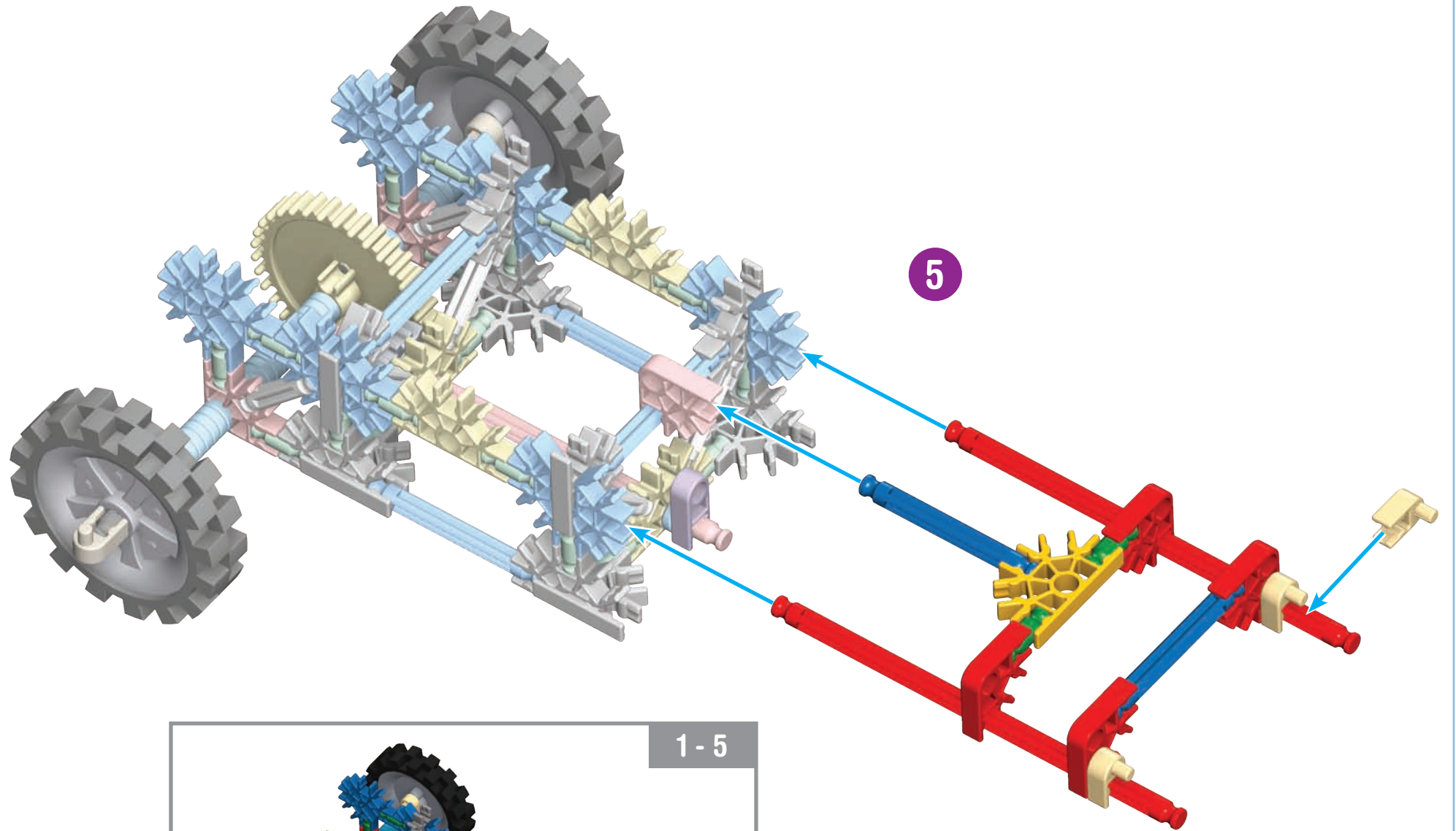

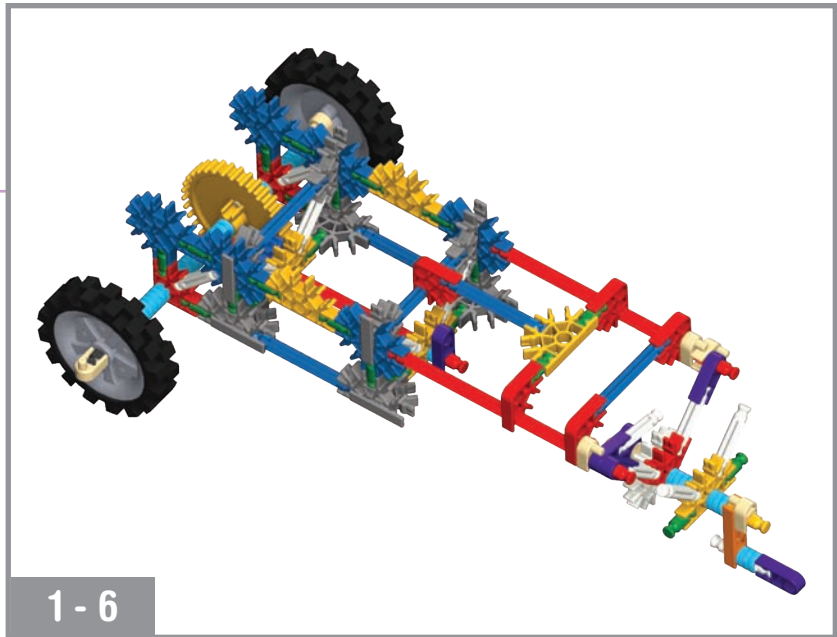
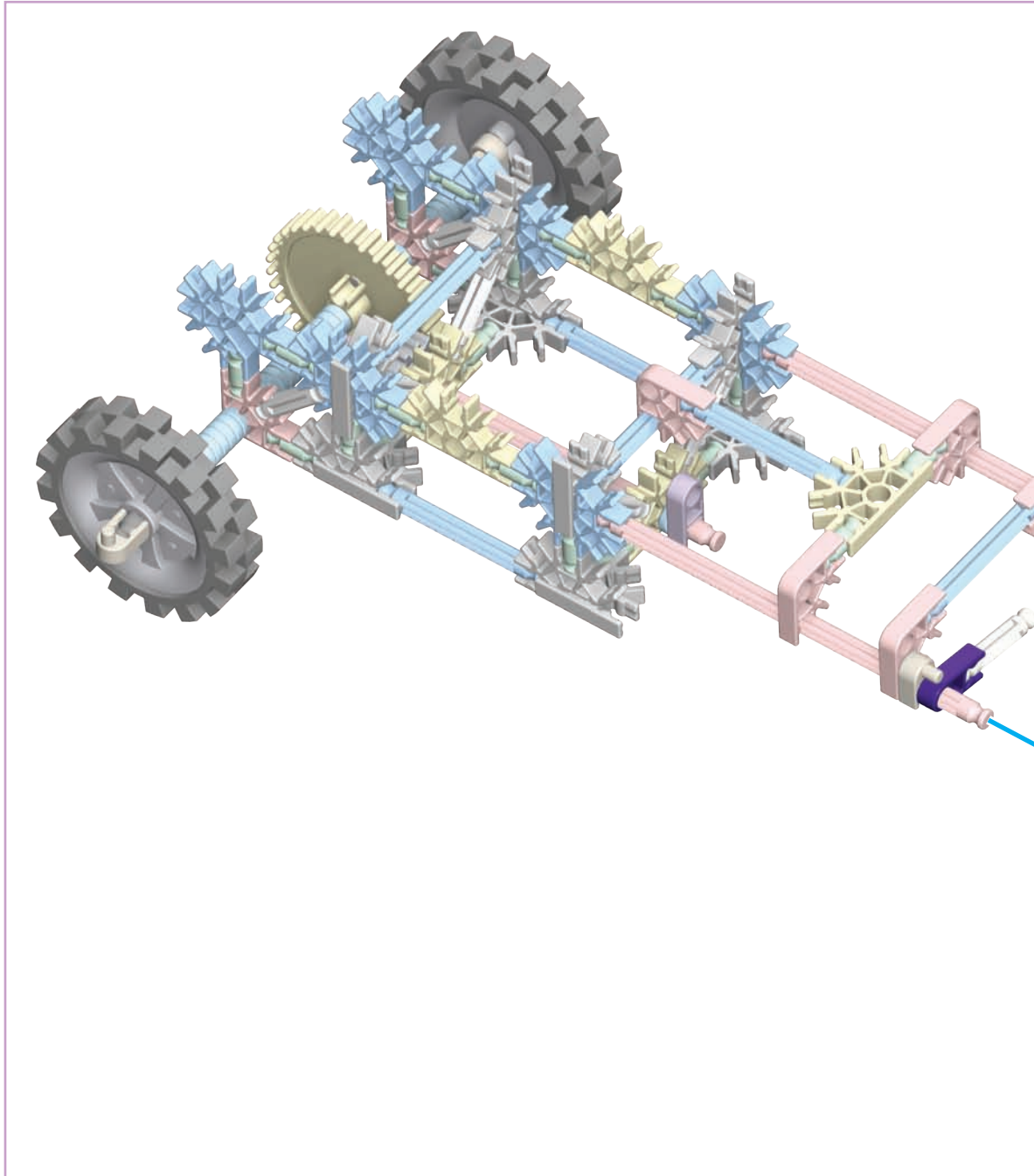

1 - 6

6

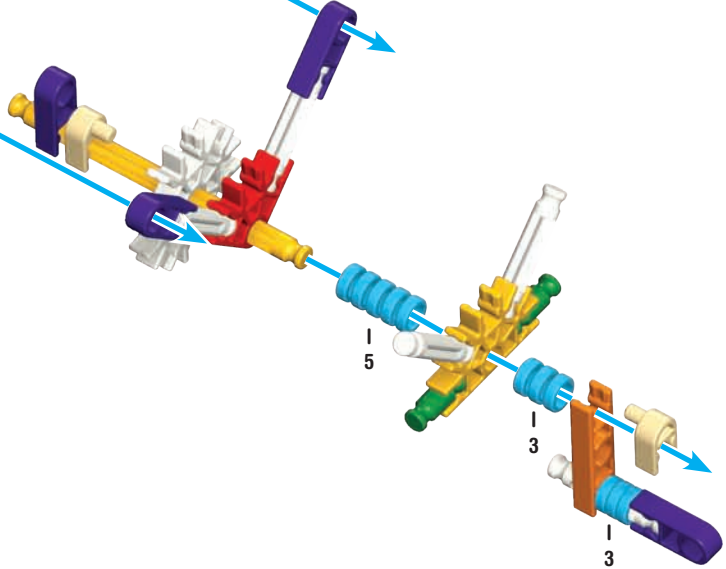

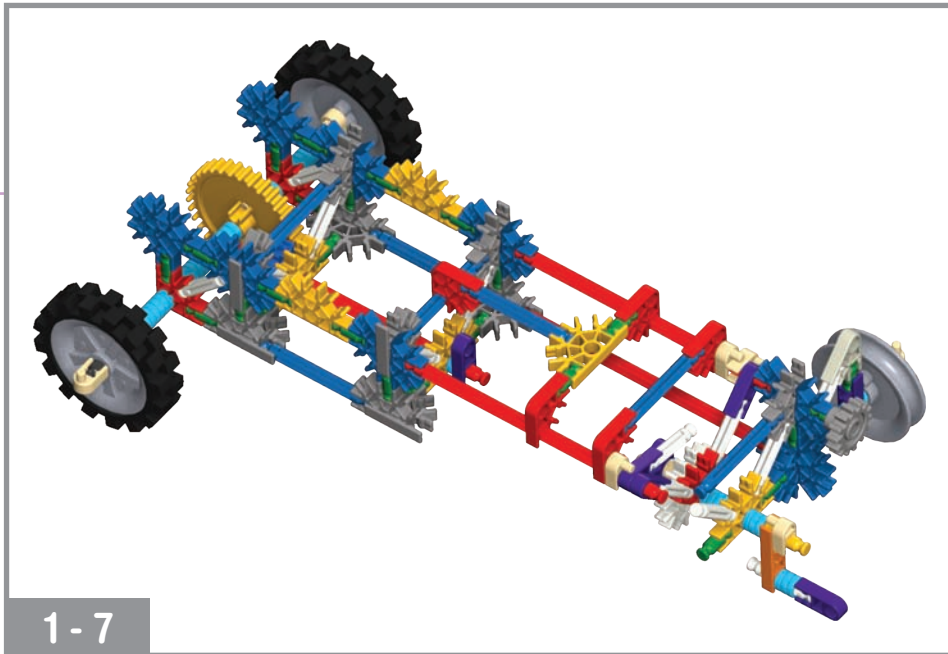
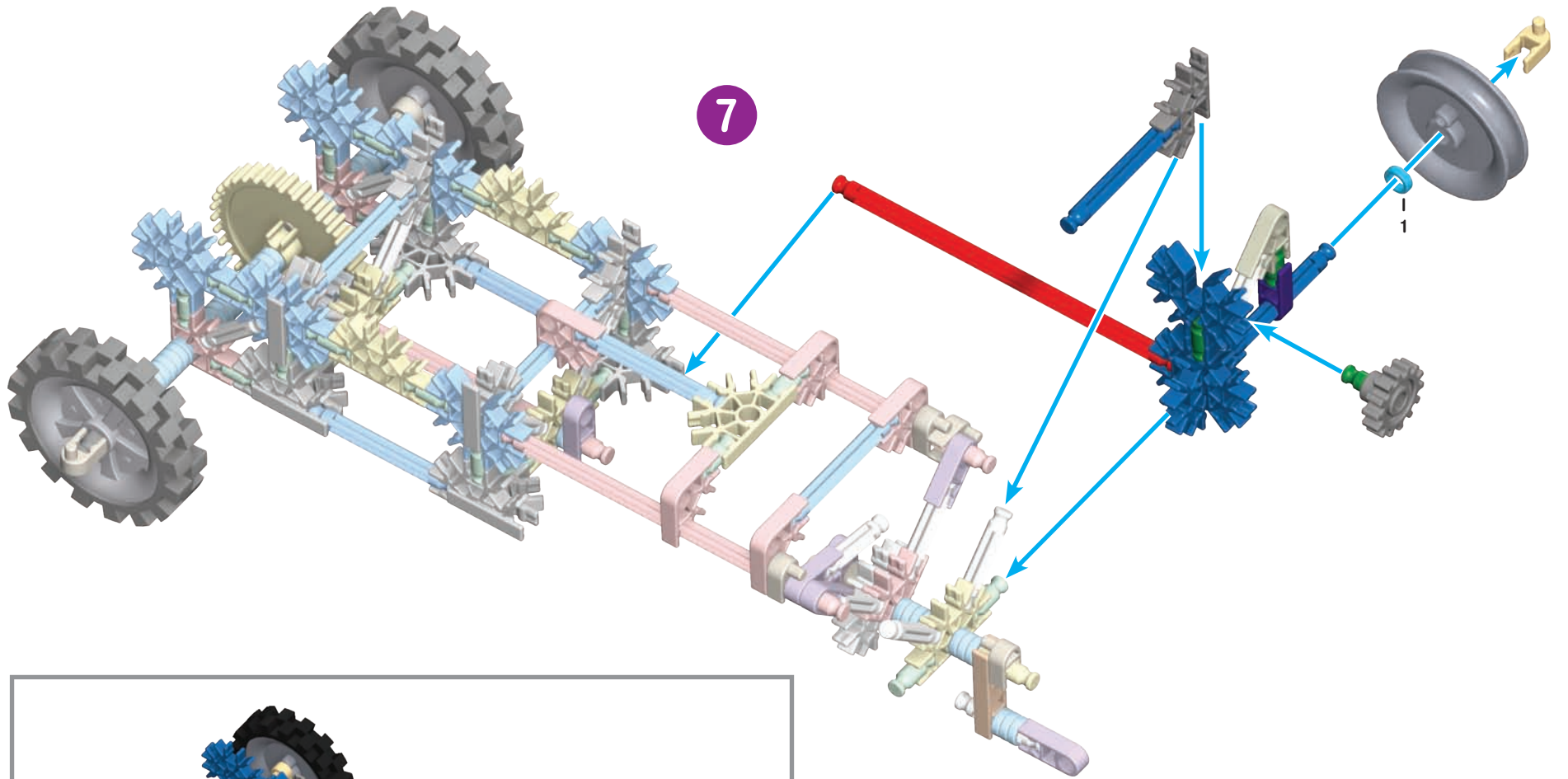

1-7

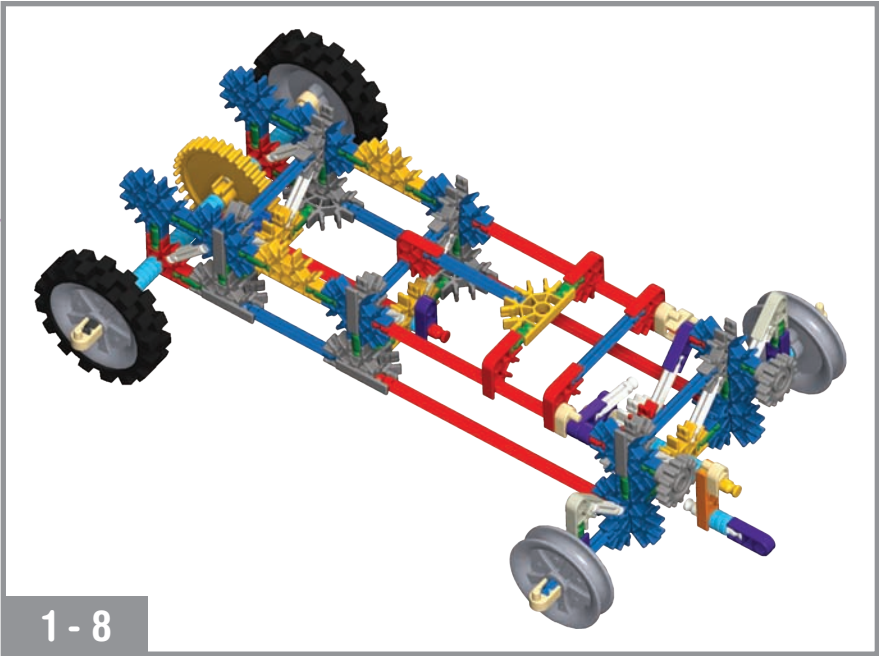
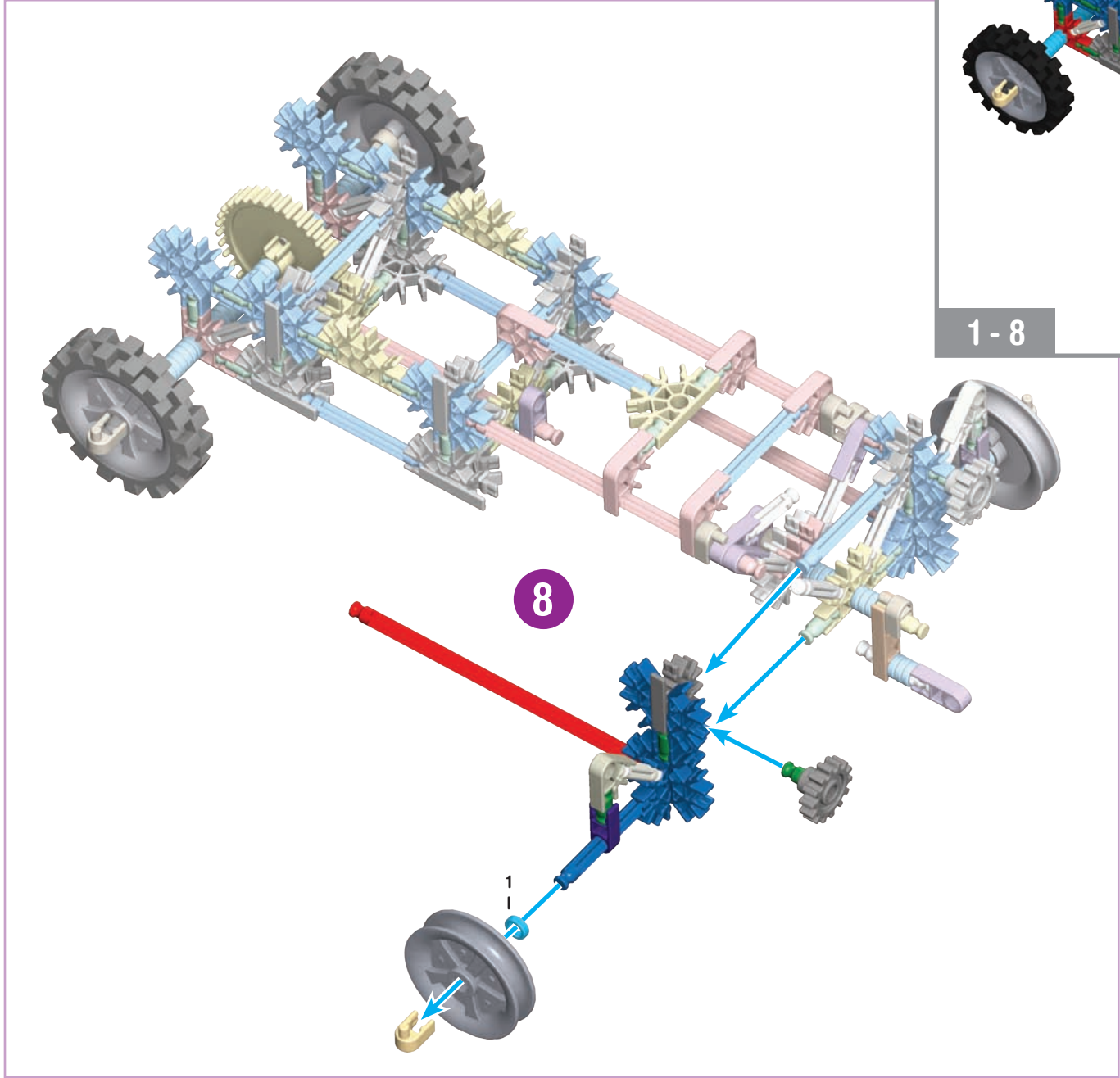

1-8

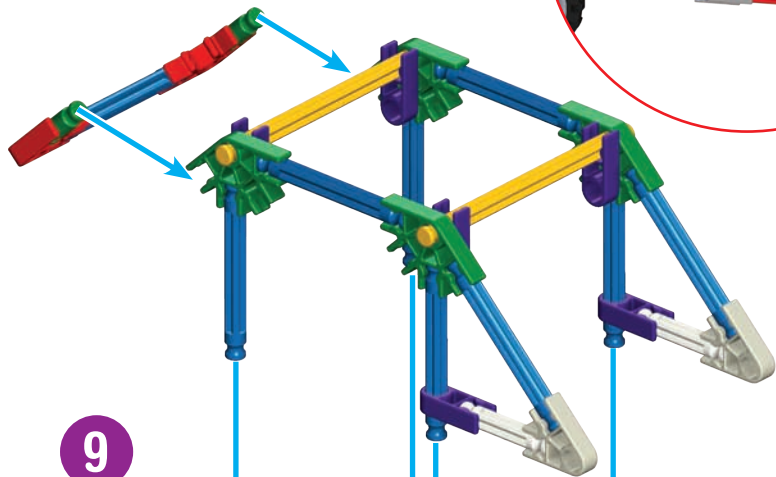

9

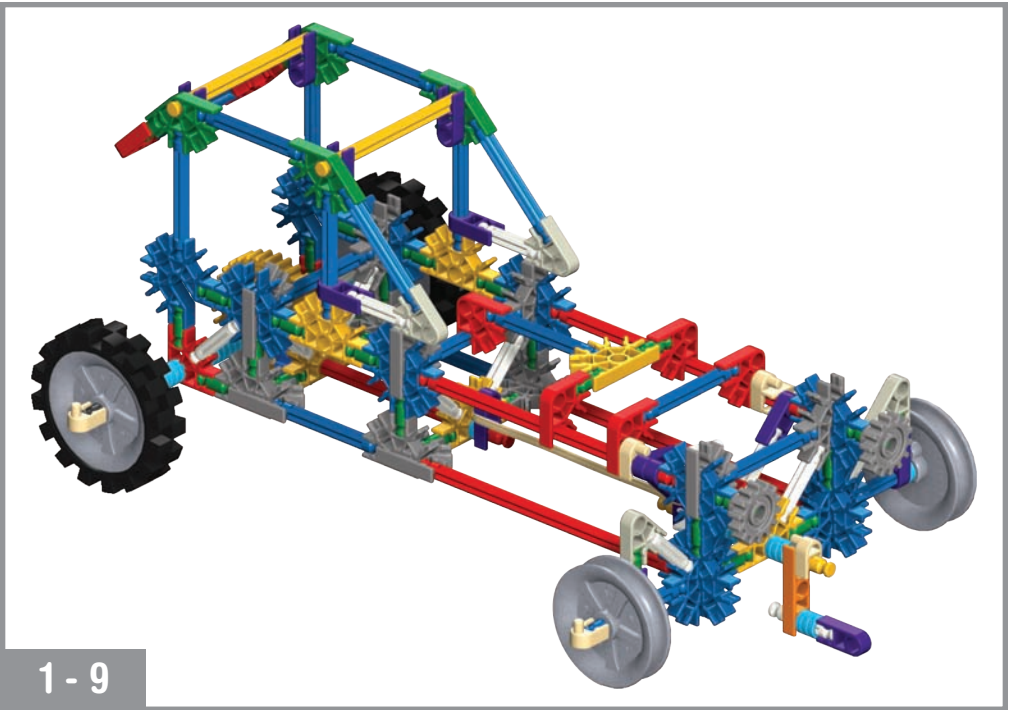
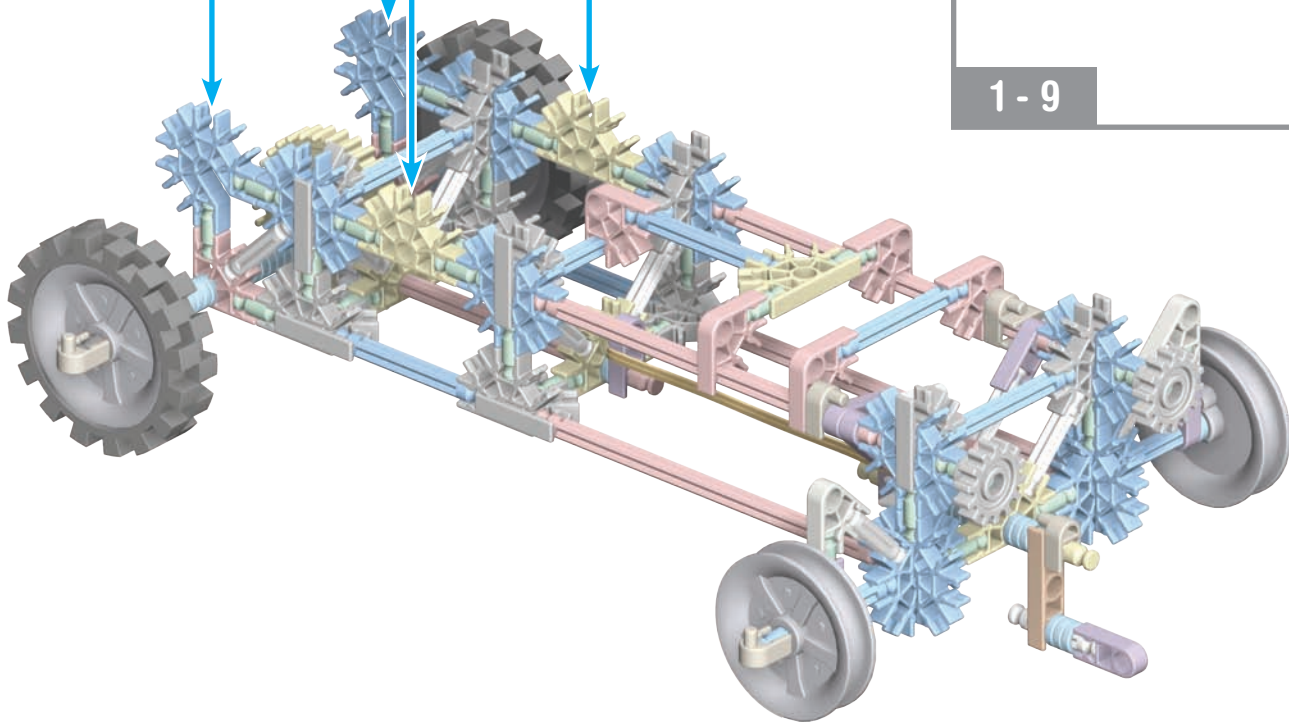

1-9

Cycle

