

Make sure the Gears mesh.

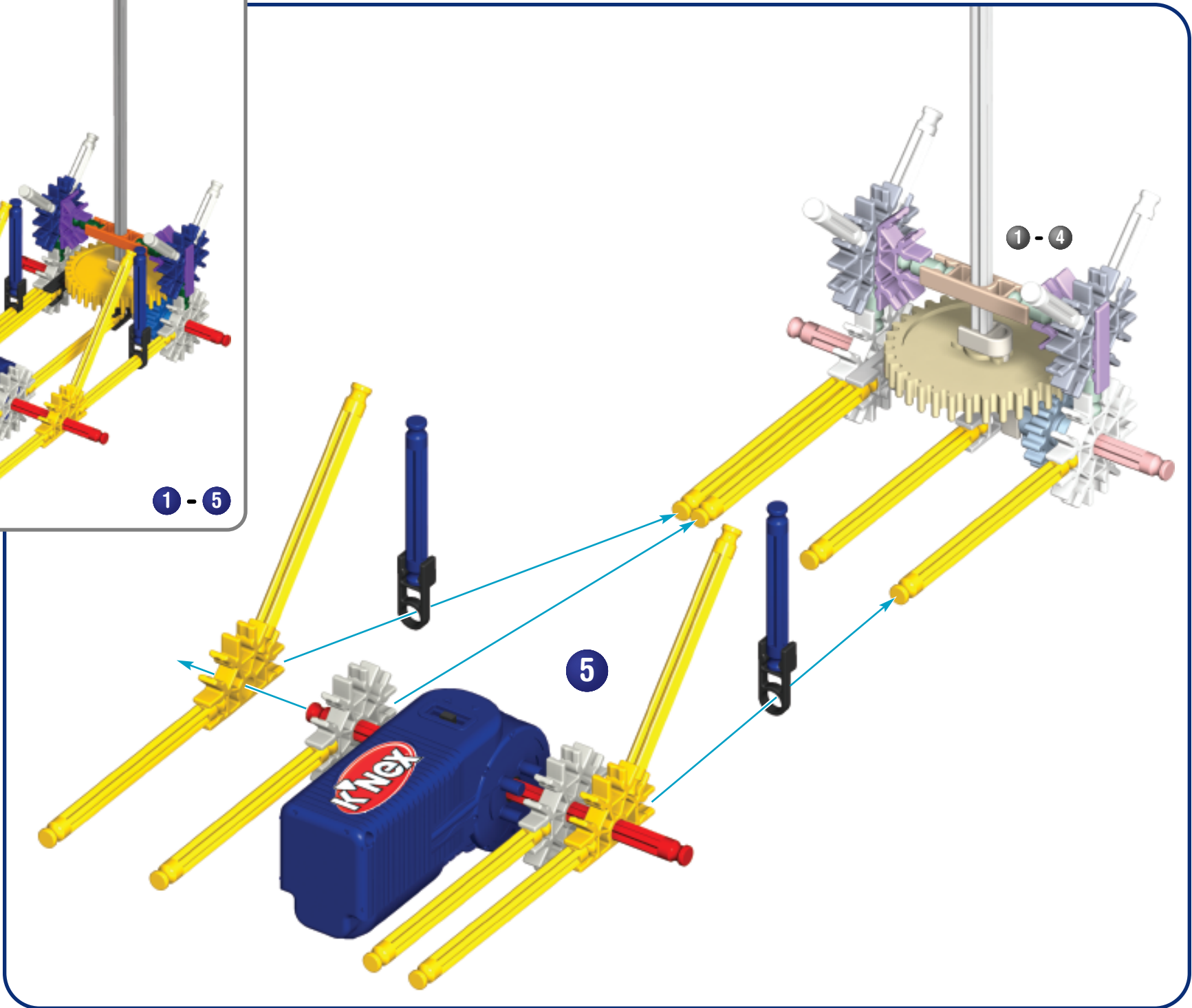

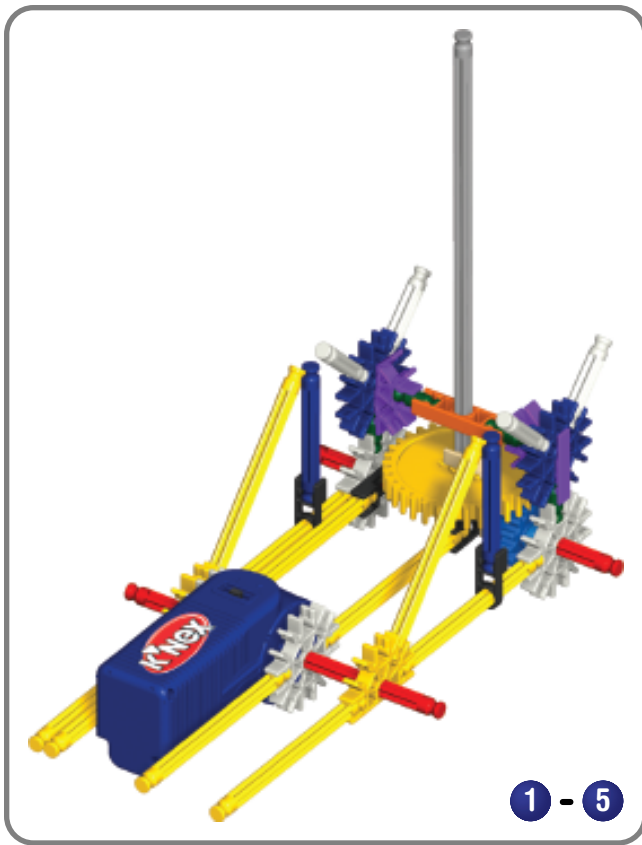

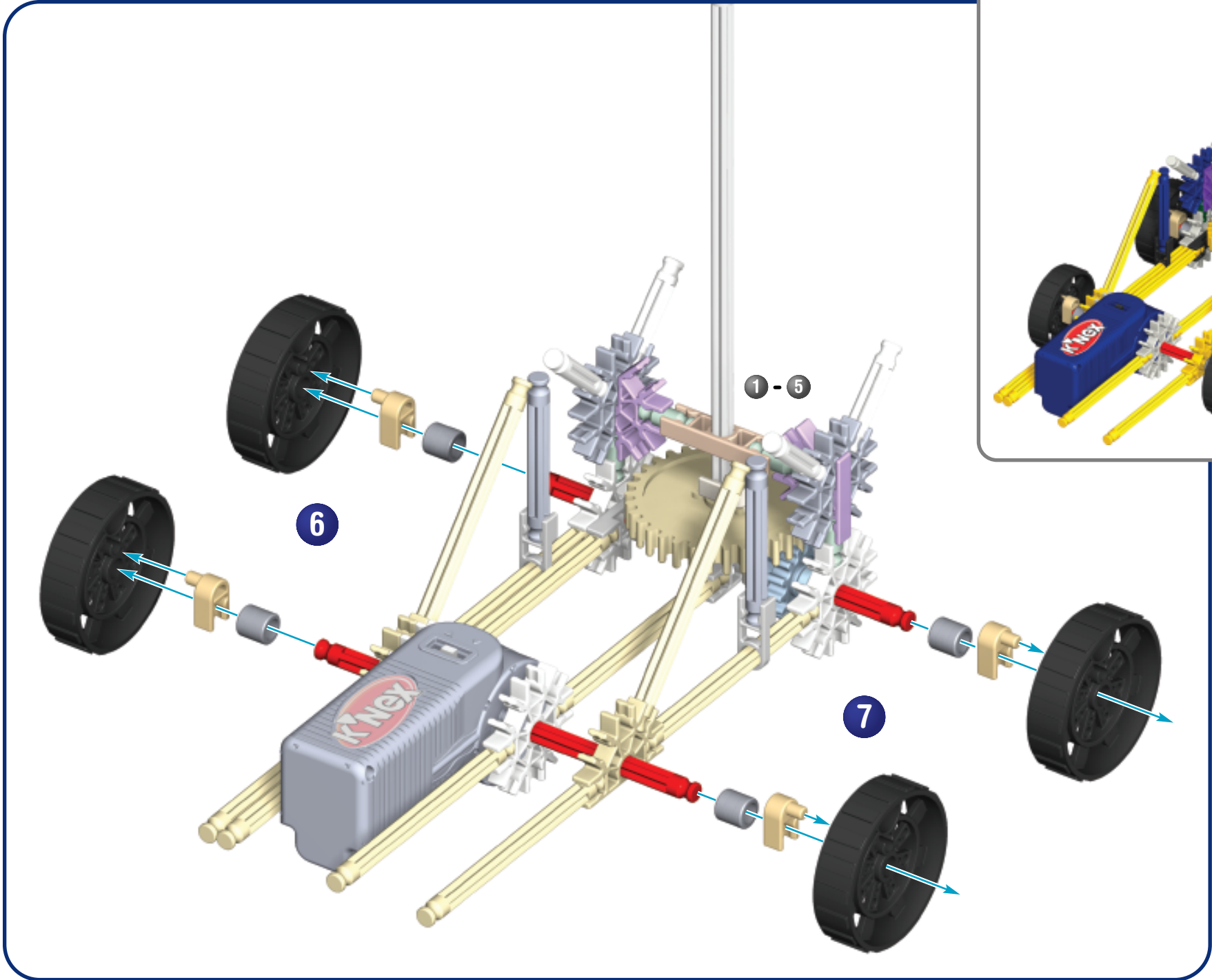

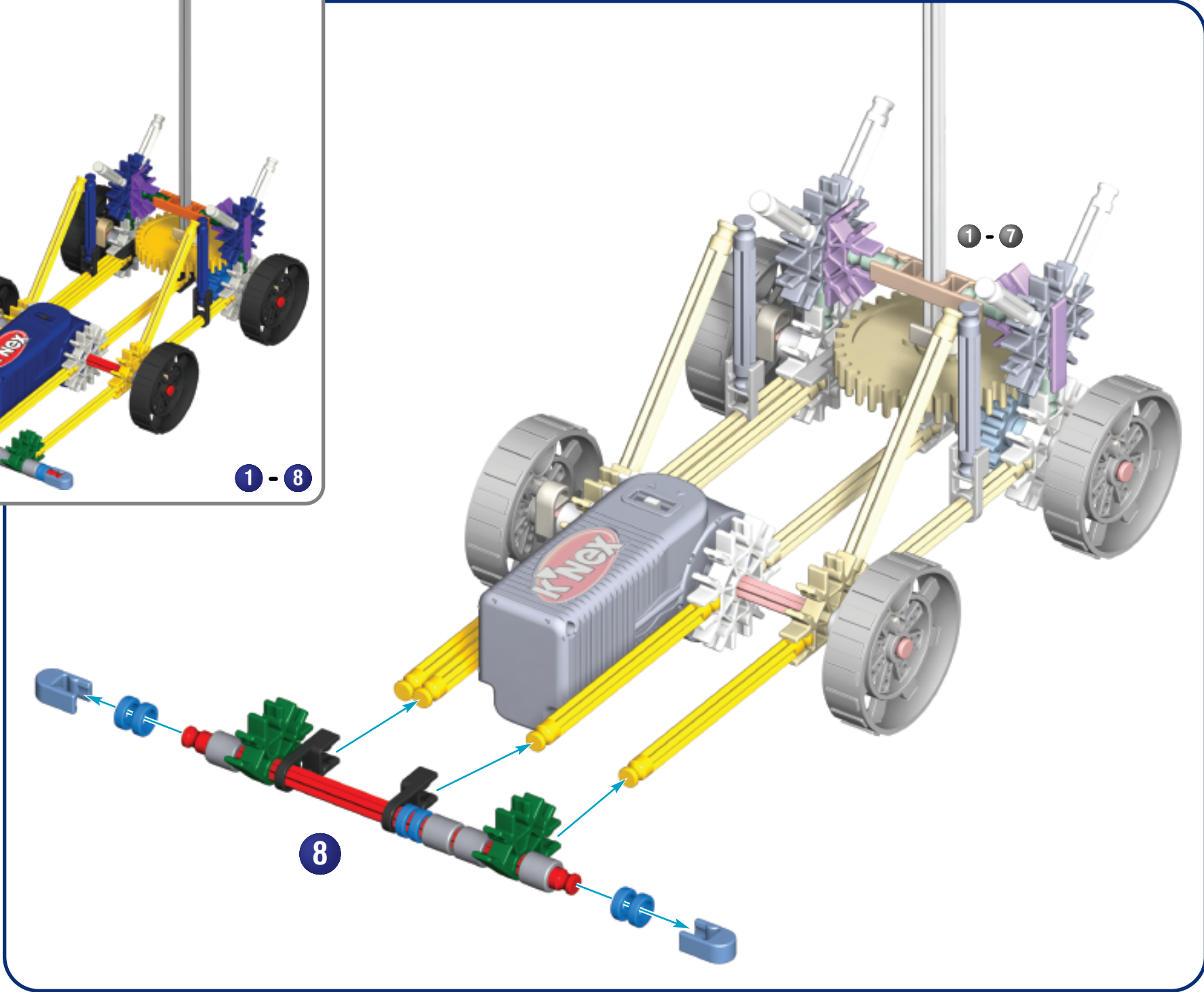

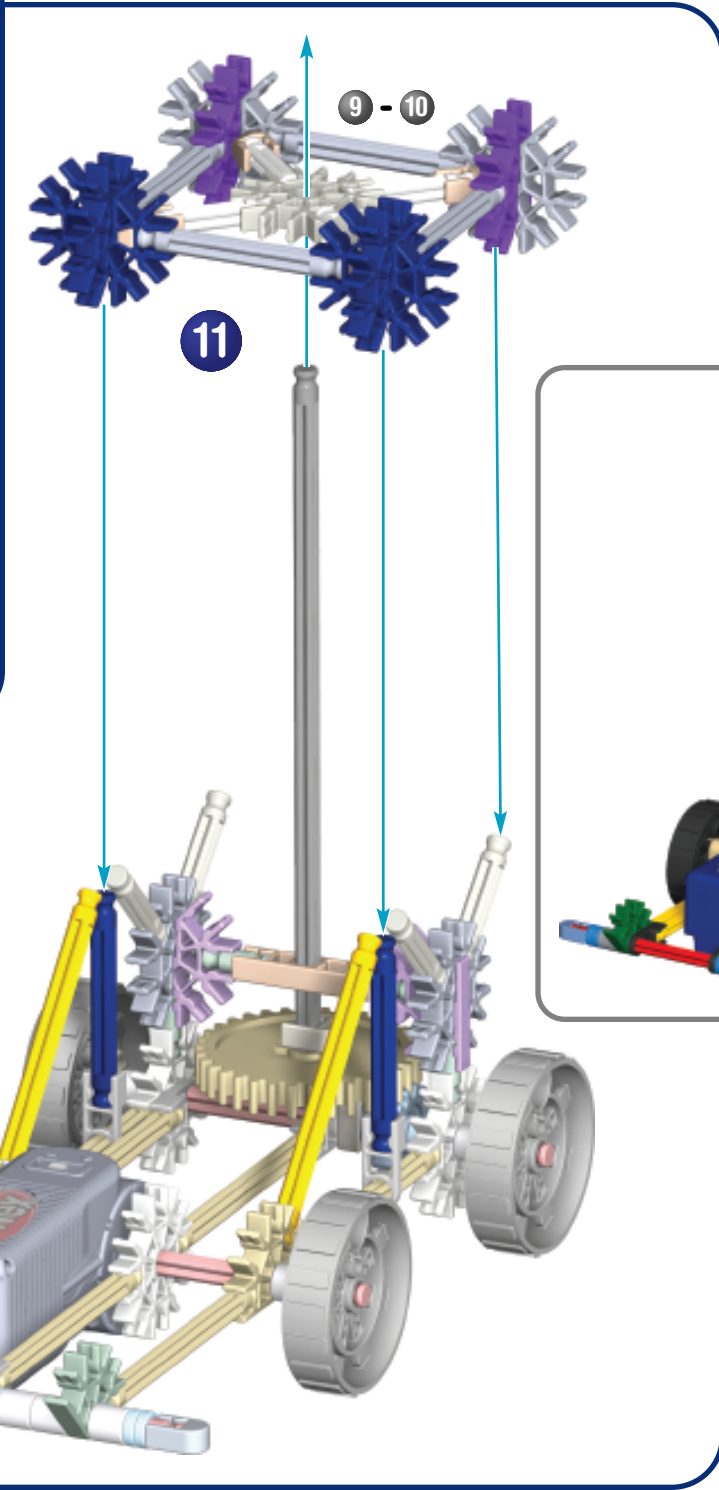
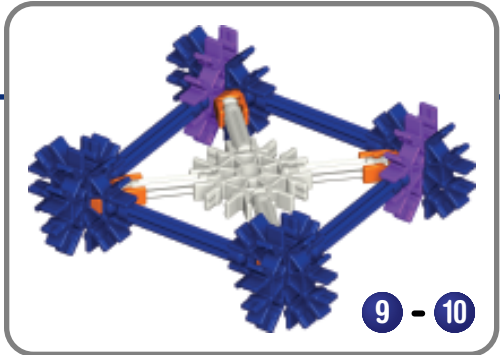
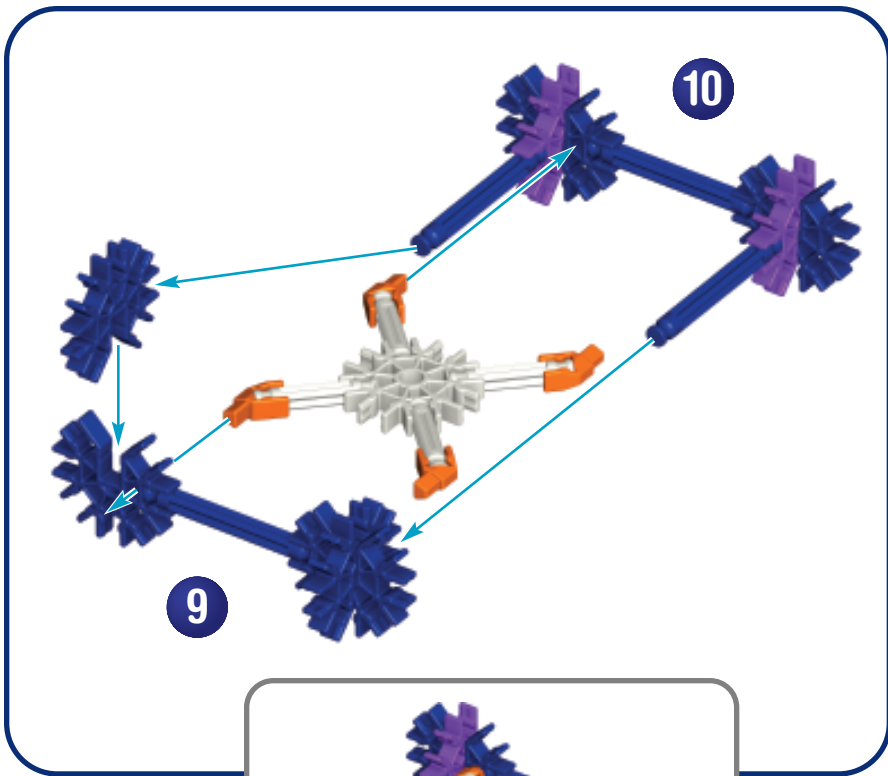

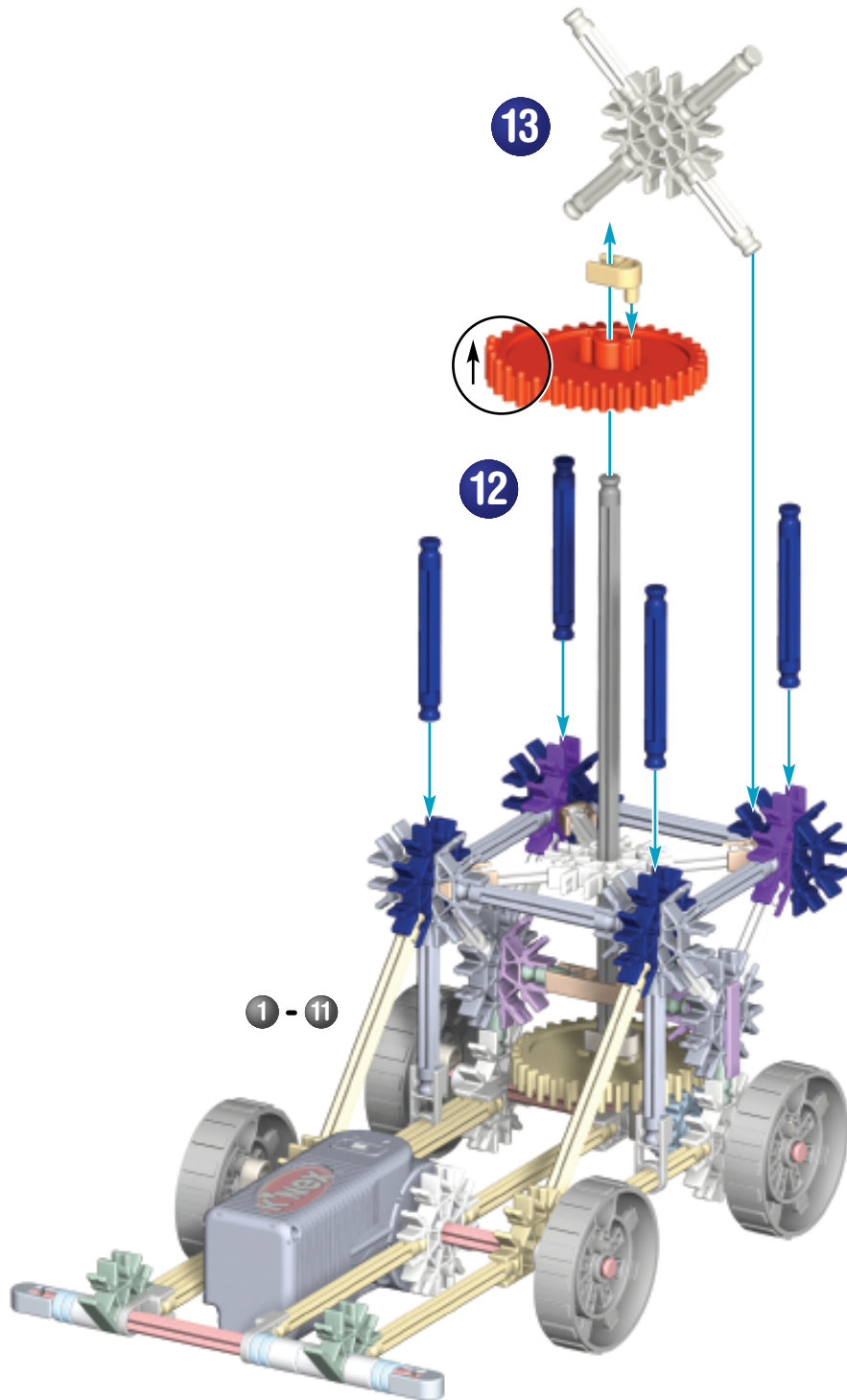

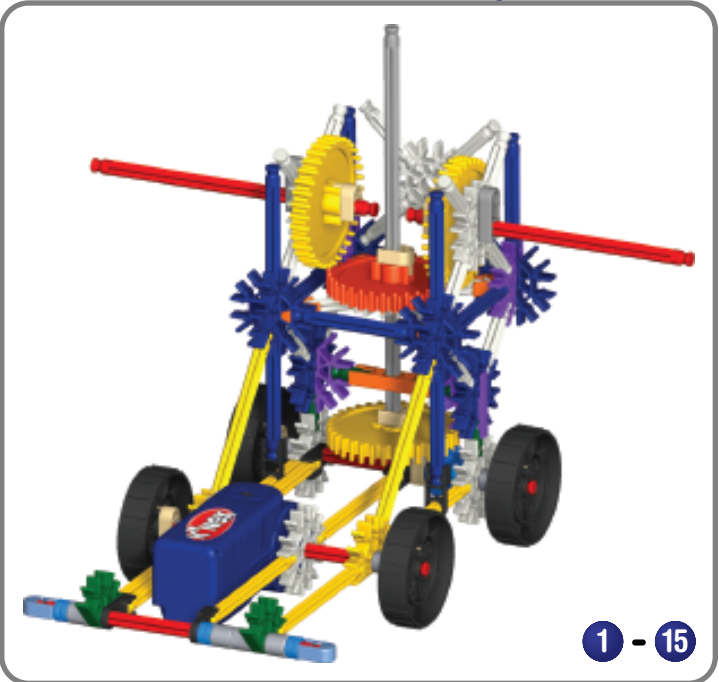
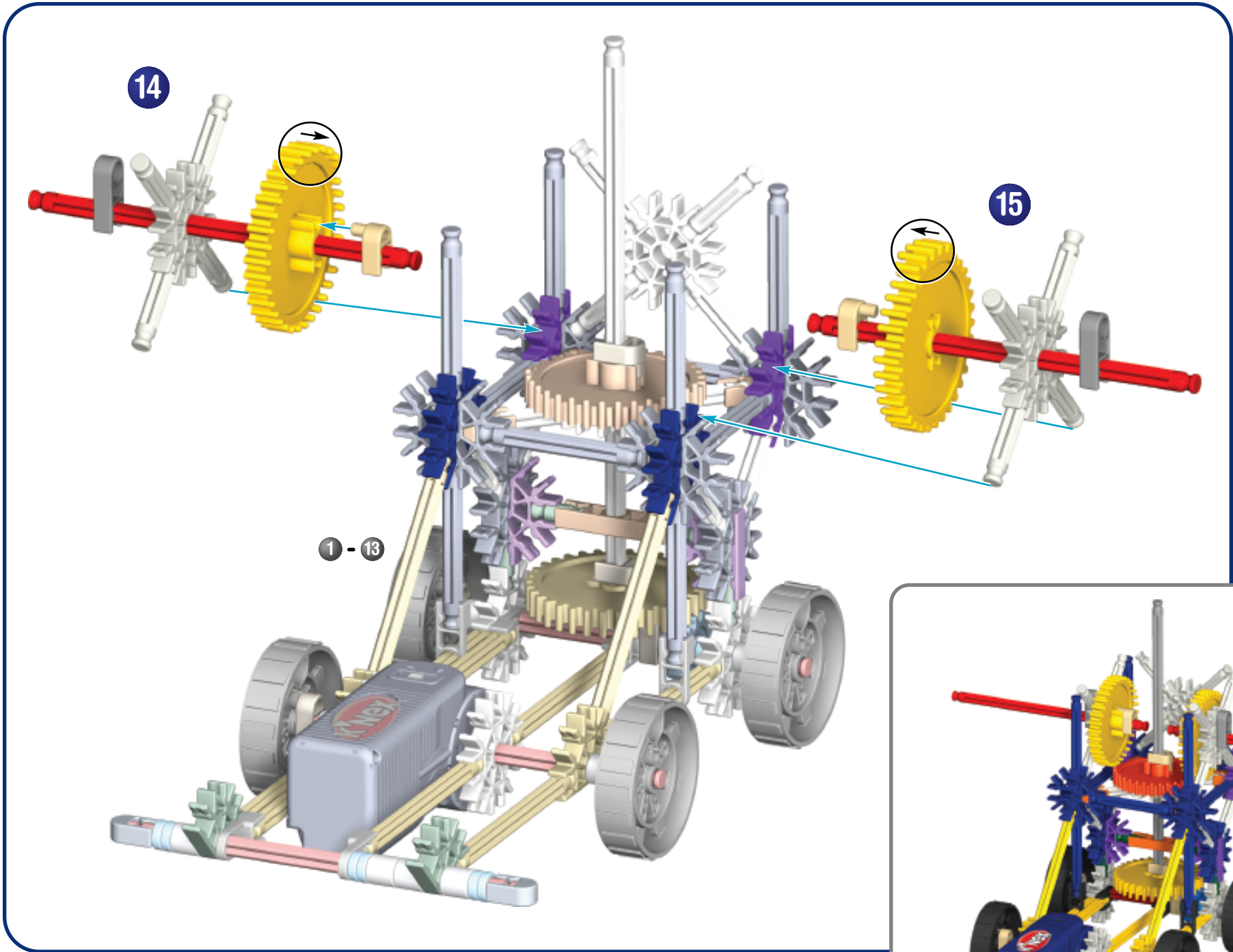



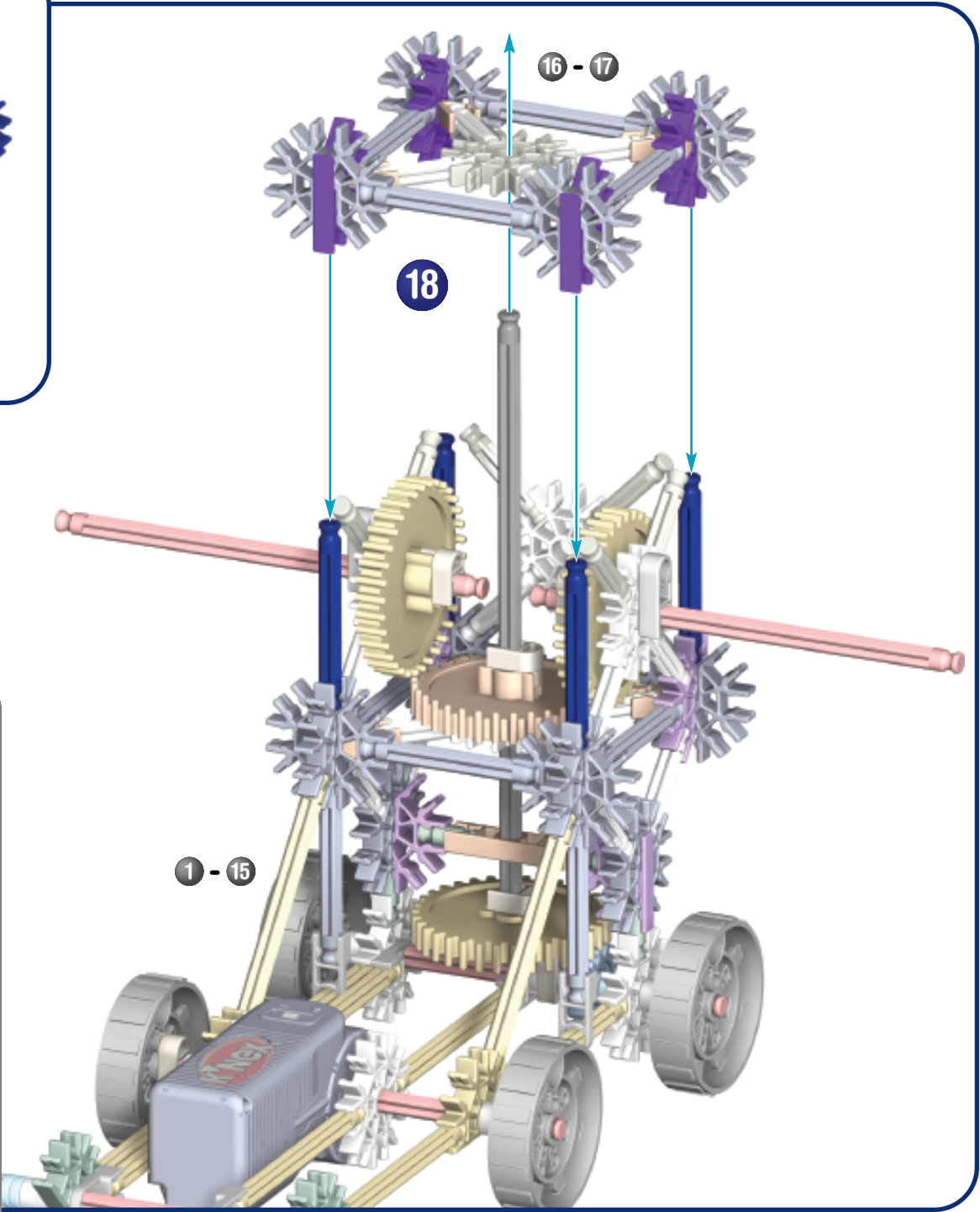
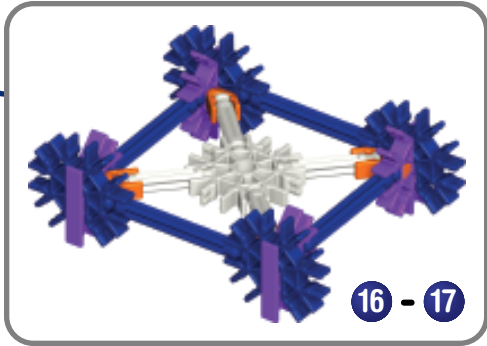
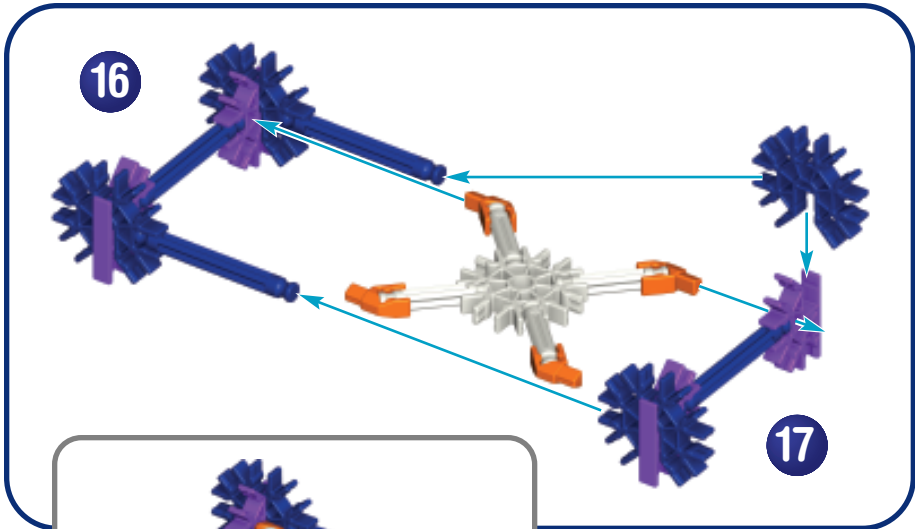

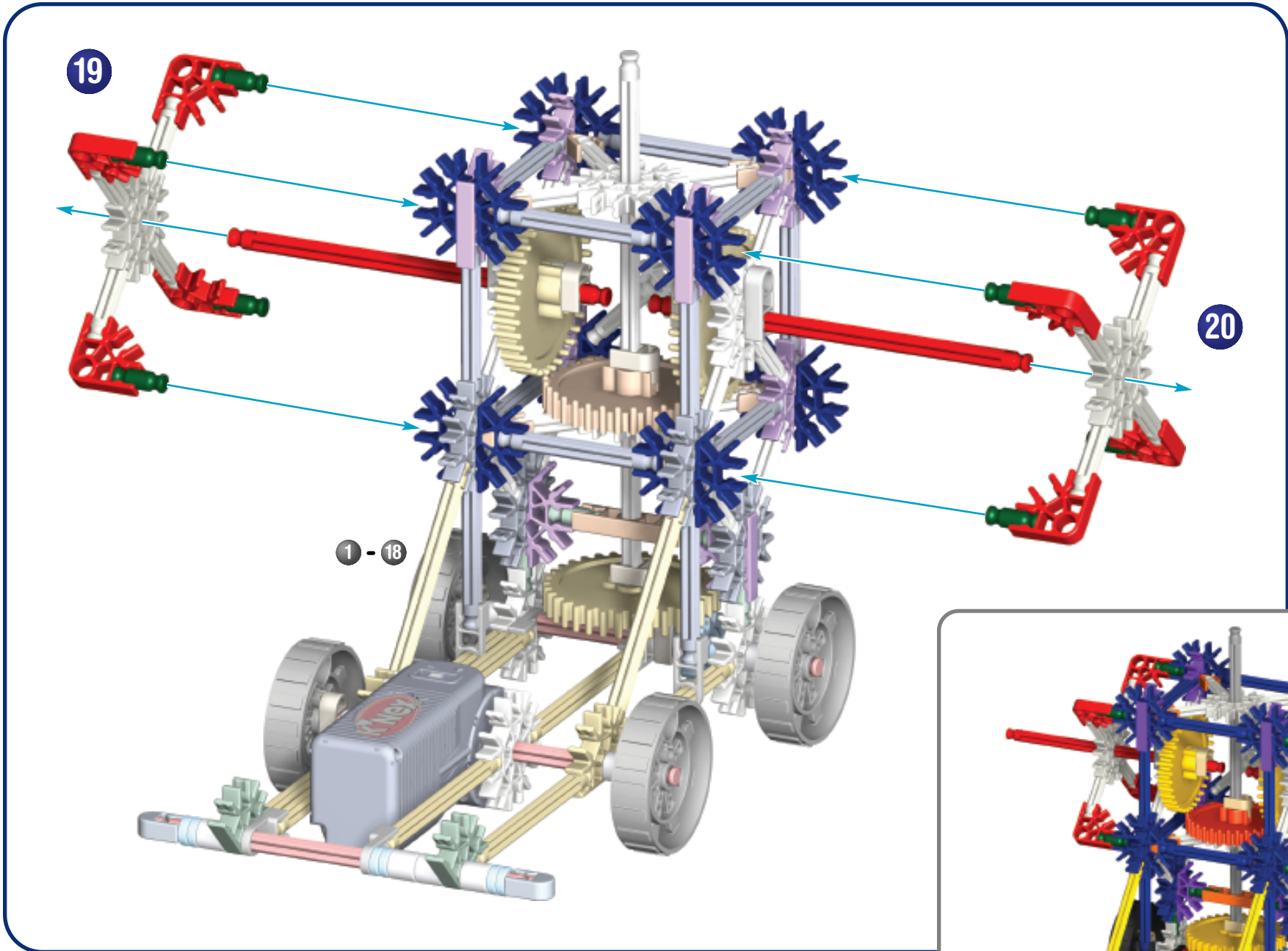

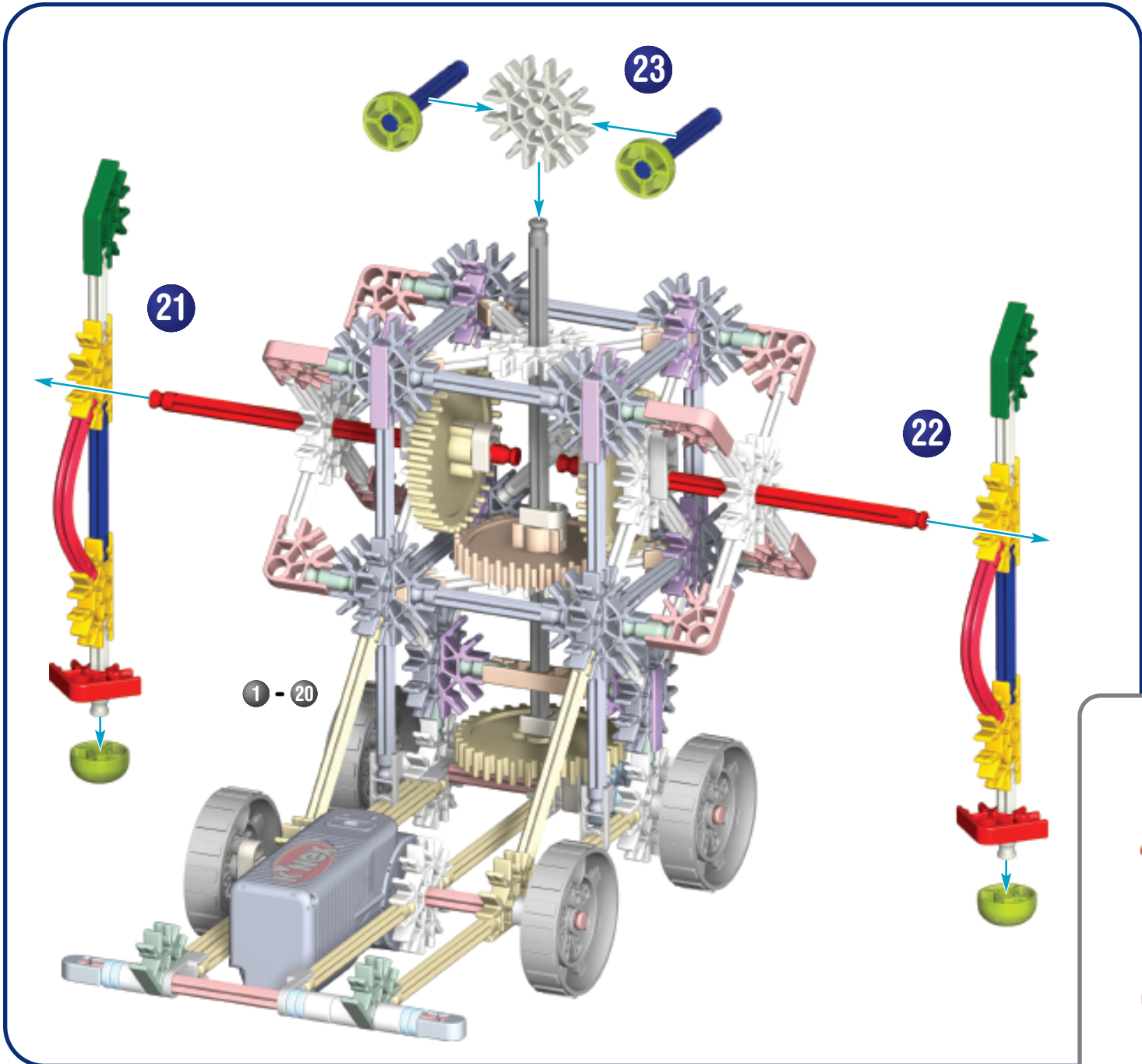



4x

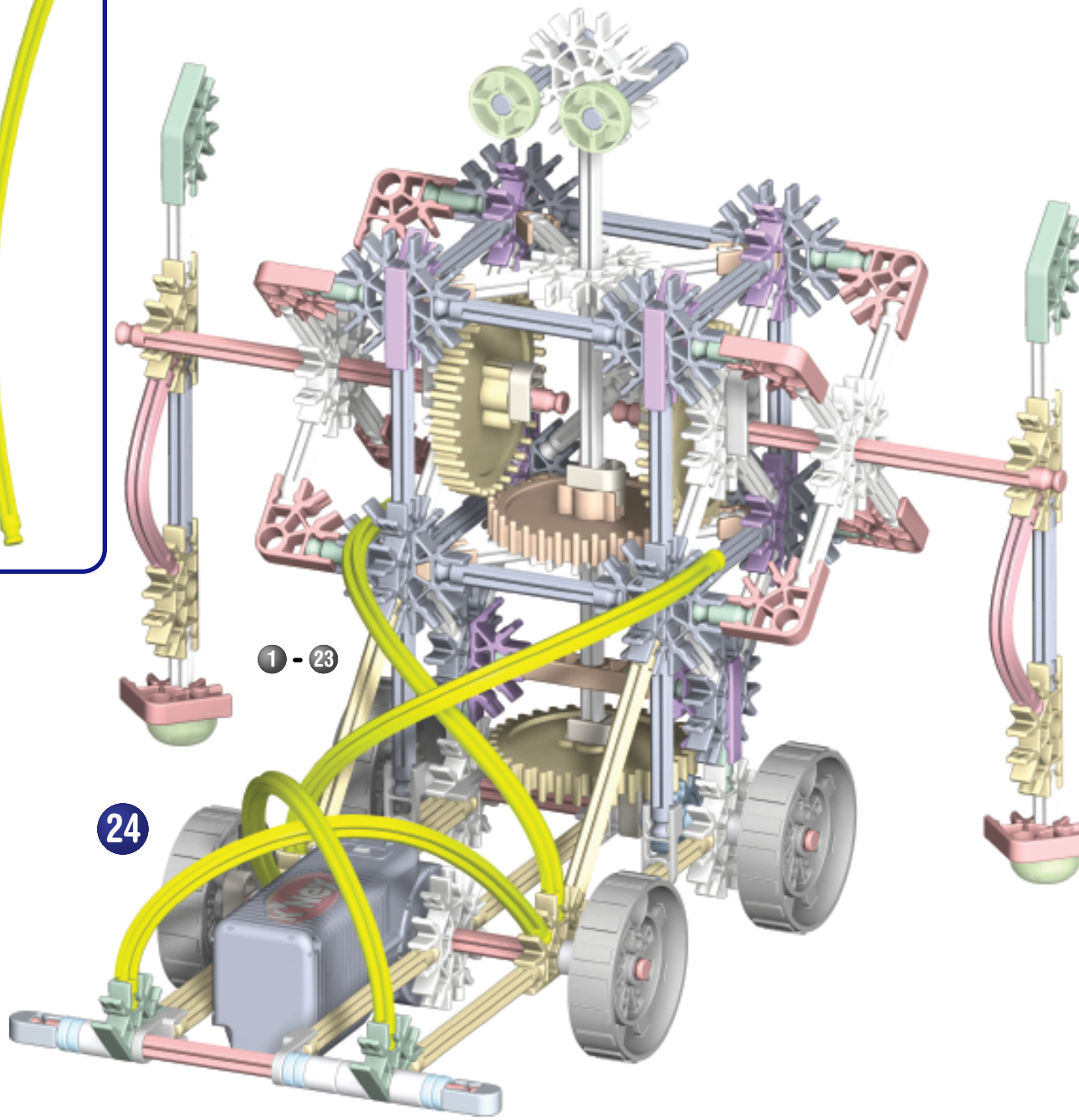



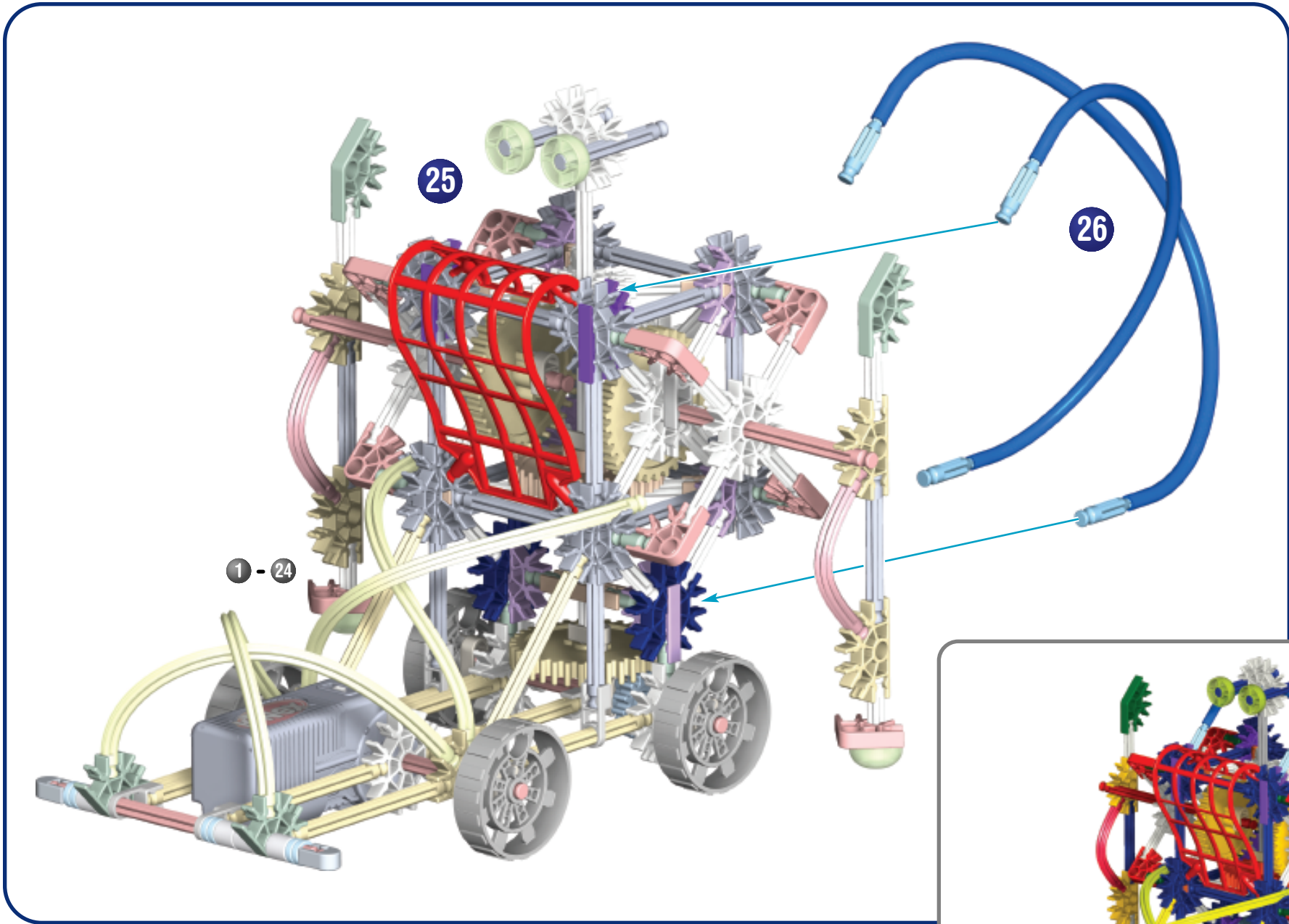

2x

