

# K'NEX®

Building Worlds Kids Love®

## ALL-AMERICAN ROLLER COASTER BUILDING SET



9+

55400

2 x



Not included



MOTOR

# CONTENTS

K'NEX Building Basics .....	3
Parts List.....	4
All-American Roller Coaster .....	5
Tips and Troubleshooting.....	38
Freedom Roller Coaster .....	39

**Keep this important information for future reference**

## Important Stuff for Parents and Kids

**⚠ WARNING:** CHOKING HAZARD - Small parts. Not for children under 3 years.

**CAUTION:** Keep hands, face, hair and clothing away from all moving parts.

**CAUTION:** Be careful not to tip the model over. Model should be placed on a flat and hard surface.

- Do not obstruct track with objects or any part of your body.
- Share the K'NEX experience with your child and make building with K'NEX a family fun adventure.
- Take your time to enjoy the building process. Don't rush!
- While you're building make sure you face your model in the same direction as the pictures show in the instructions.
- Product and colors may vary.

## Battery Information

### How to Insert and Remove Batteries

Use a small Phillips head screwdriver to loosen the screw. Insert 2 fresh AA batteries\* (LR6) into the compartment with the correct polarity (+/-) as shown here.

Install batteries before building models.

\* Not included

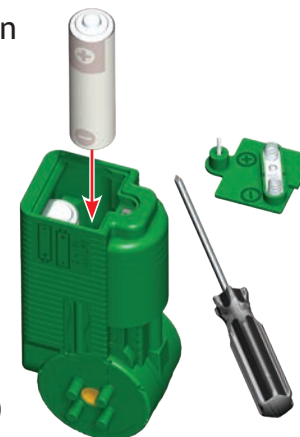

### CAUTION: To Avoid Battery Leakage

- Insert batteries with correct polarity (+/-) as shown.
- Do not mix different types of batteries.
- Do not mix alkaline, standard (carbon-zinc) or rechargeable (nickel-cadmium) batteries.
- Do not mix new and used batteries. Only batteries of the same or equivalent type recommended should be used.
- Remove exhausted batteries from the toy; do not short-circuit supply terminals.
- Remove all batteries if the toy will not be used for a long period of time.

### Important Tips

- Alkaline batteries are recommended.
- Rechargeable batteries are not recommended.
- Remove rechargeable batteries before recharging; they must be charged only under adult supervision.
- Non-rechargeable batteries must not be recharged.
- Keep components free of dust; do not immerse or use in water.
- Do not dispose of batteries in a fire; they could leak or explode and cause injury.
- Do not put rods smaller than 2 inches in any openings of the motor; they will damage the motor and cannot be removed.

**Go to [KNEX.COM](http://KNEX.COM) for instruction updates**

## Start Building

To begin your model, find the **1** and follow the numbers. Each piece has its own shape and color. Just look at the pictures, find the pieces in your set that match and then connect them together. Try to face your model in the same direction as the instructions while you build. The arrows show you where the parts connect, but not all connections points have arrows. Faded colors show you this section is already built.

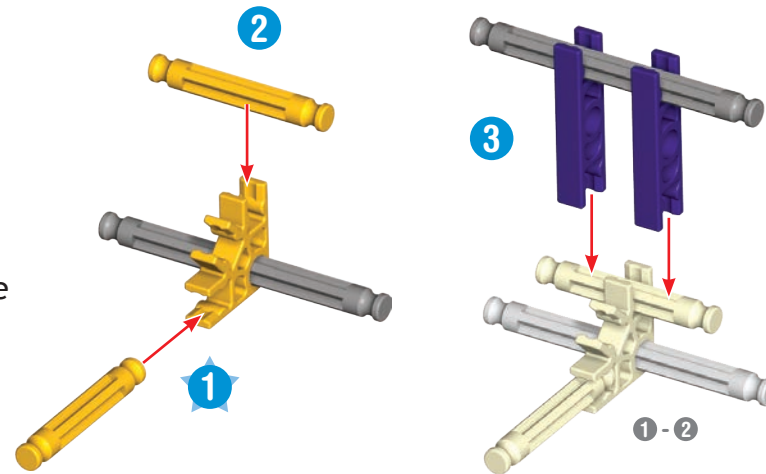

## Connectors

You can slide these special connectors together. Push tightly until you hear a “click”. Pay close attention to the instructions and position them horizontally or vertically exactly as they are shown.

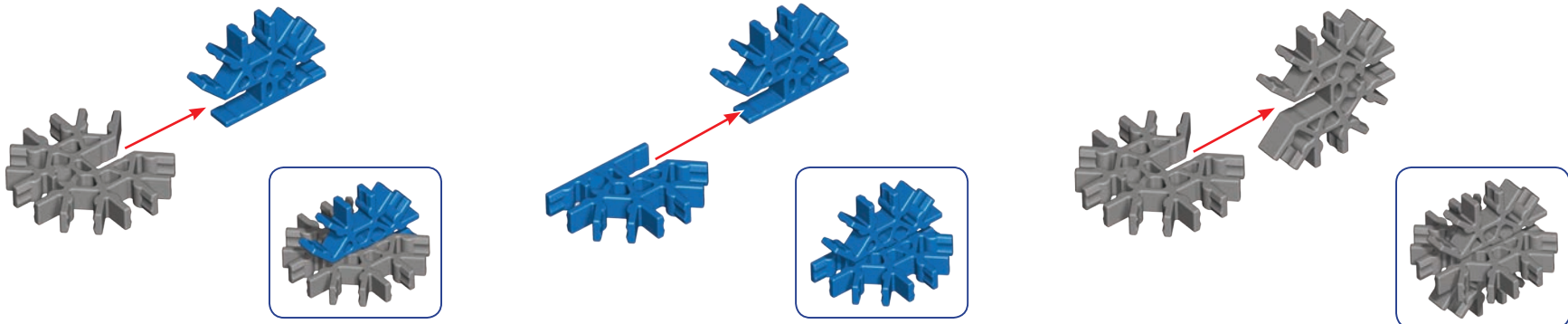

## Spacers

There are places in your model where you need to add blue and silver spacers. Be sure to use the correct number of spacers shown in the instructions.



## Chain

Be sure to attach all the chain links in the same direction.



## Parts List

Before you start building, be sure to compare the parts in your set with the parts list here.

If anything is missing, call or write to us using the information on the back cover.

We are here to help you!

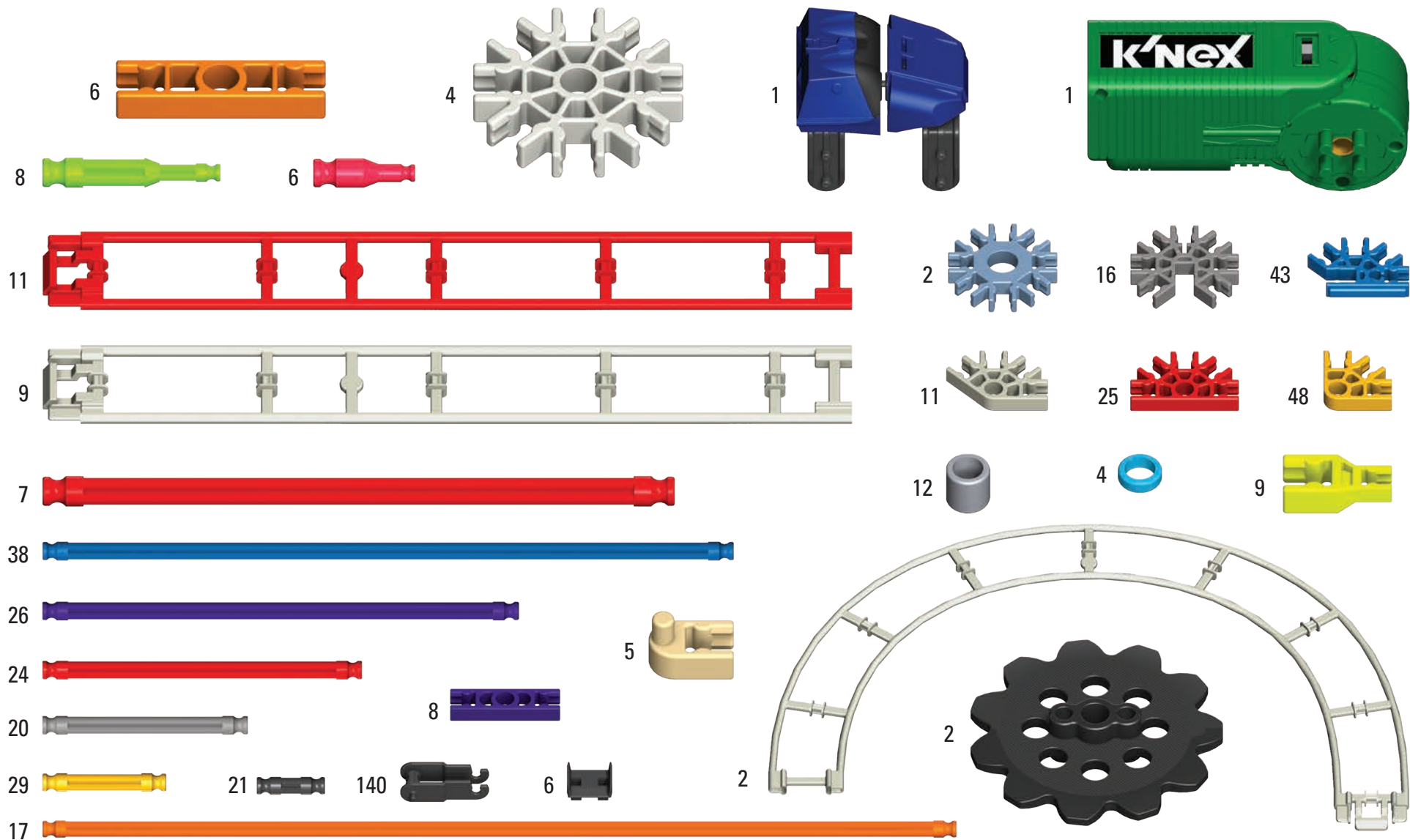

# K'NEX

## ALL-AMERICAN ROLLER COASTER



1 - 2

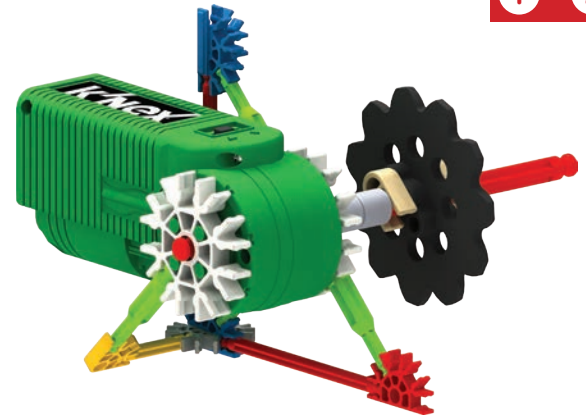

1

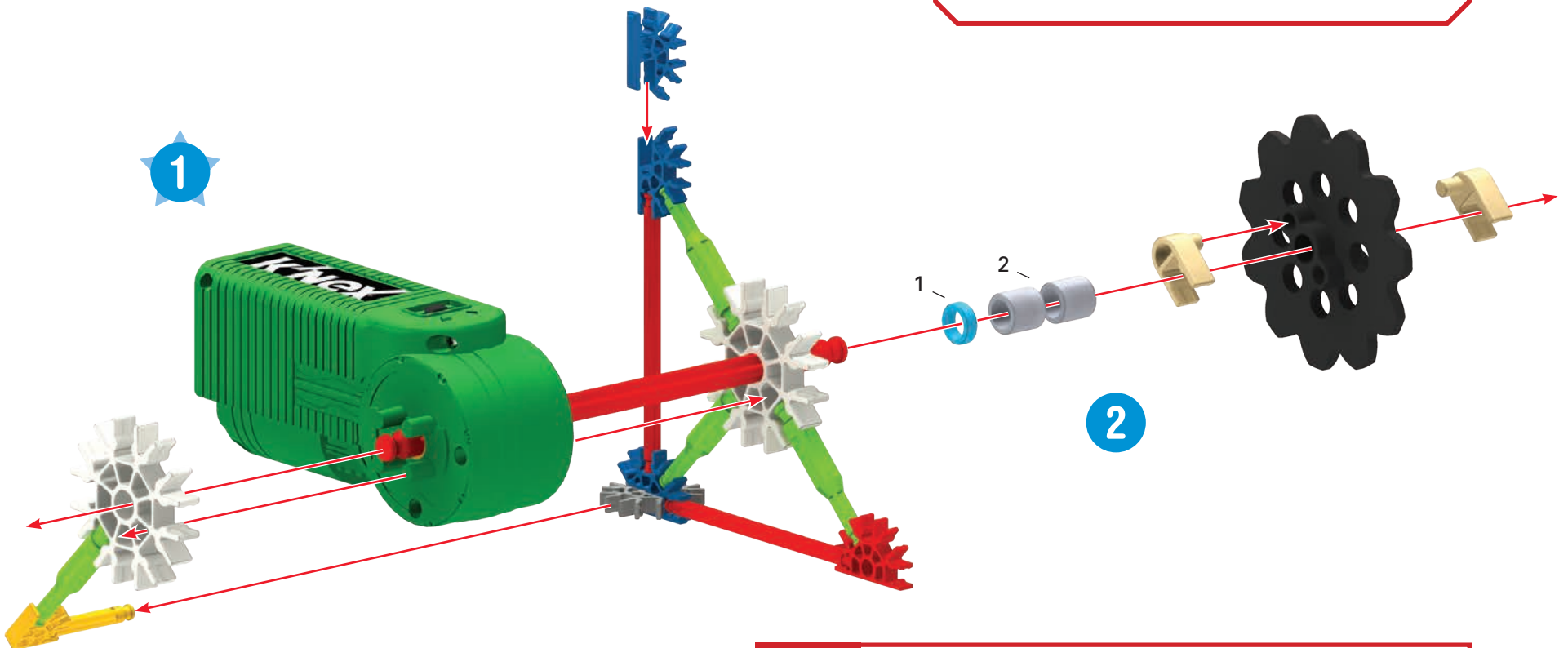



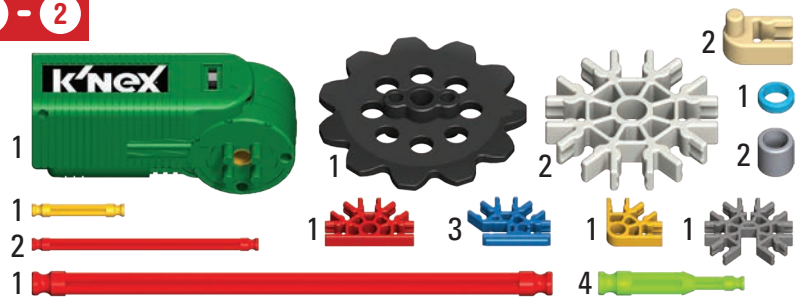

Did you install 2 AA (or LR6) batteries in the motor?

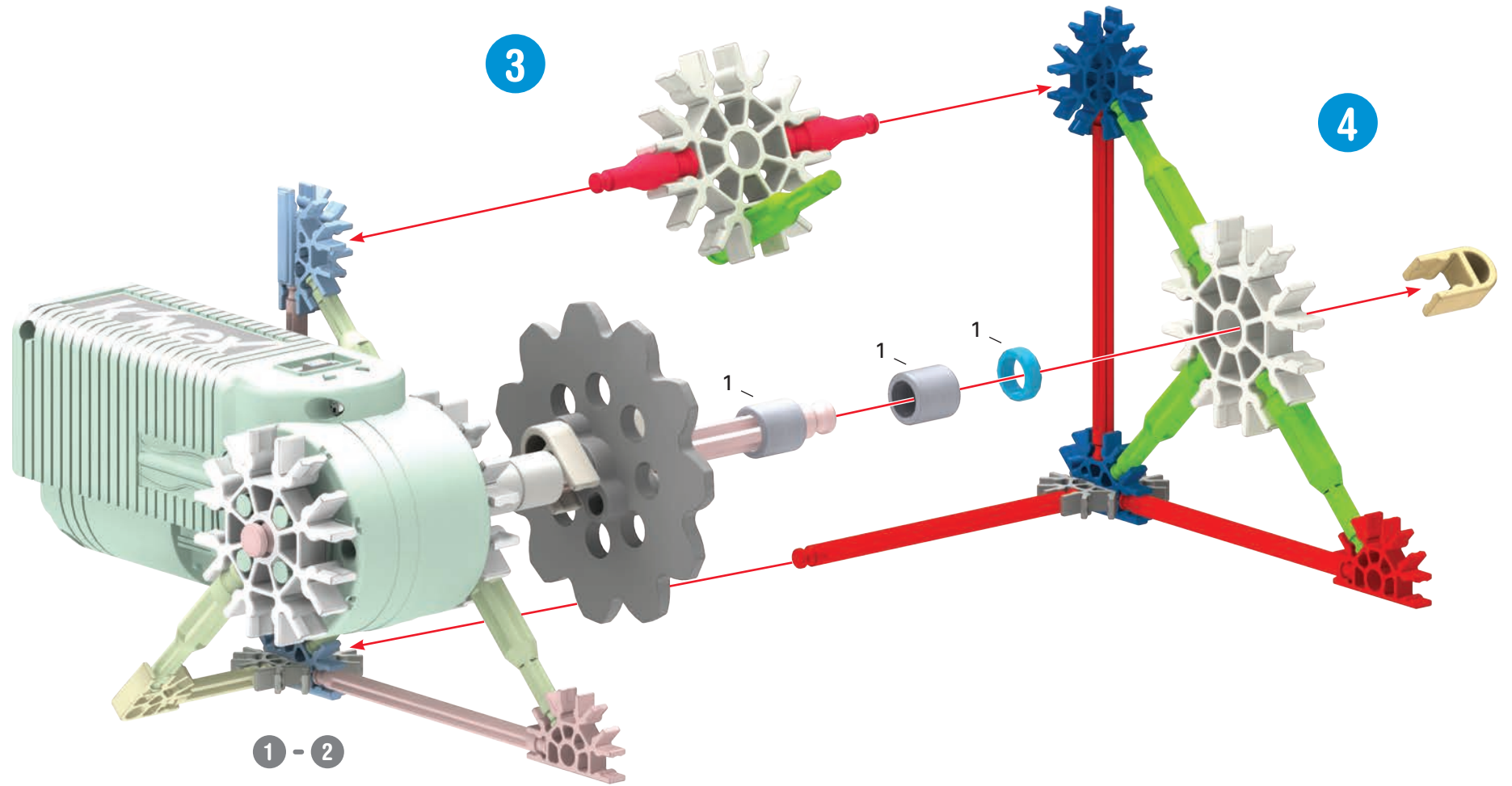

1 - 2





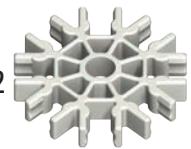

**3 - 4**

1  2  1  1  2 





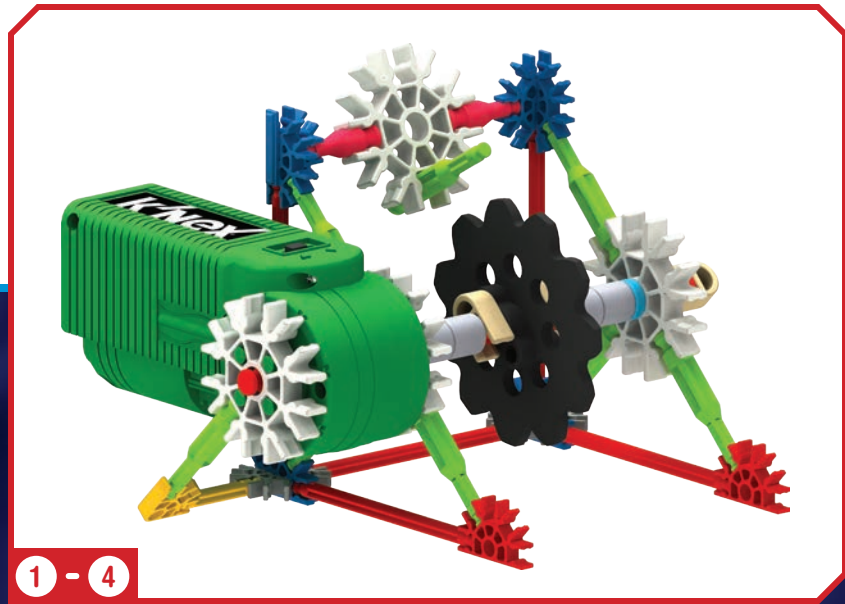





3  1  3 

4  2 



**1 - 4**

5 - 7

- 8 
- 2 
- 3 
- 4 
- 2 
- 1 
- 5 
- 3 
- 1 
- 4 

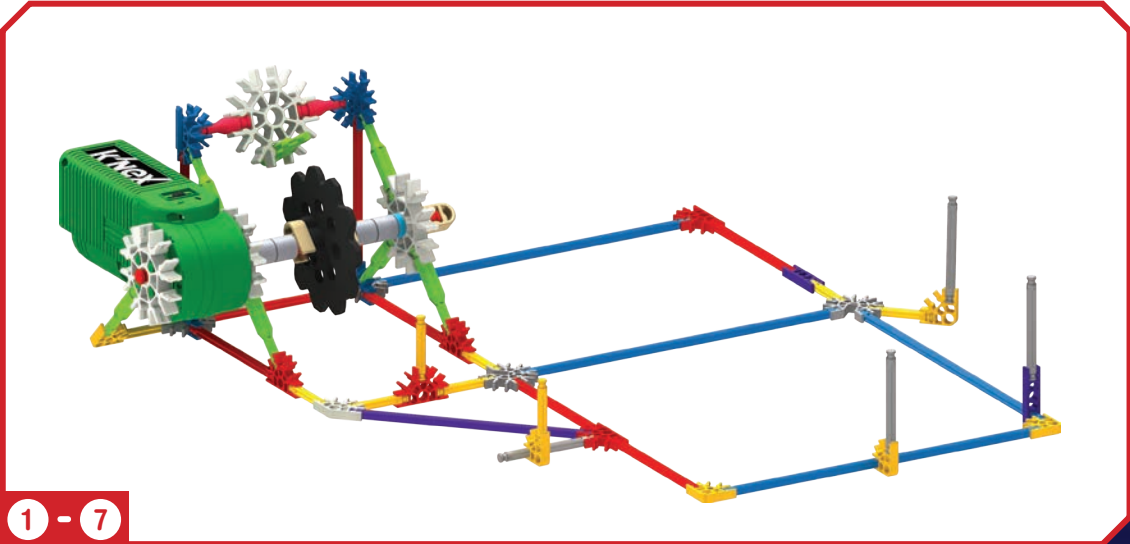
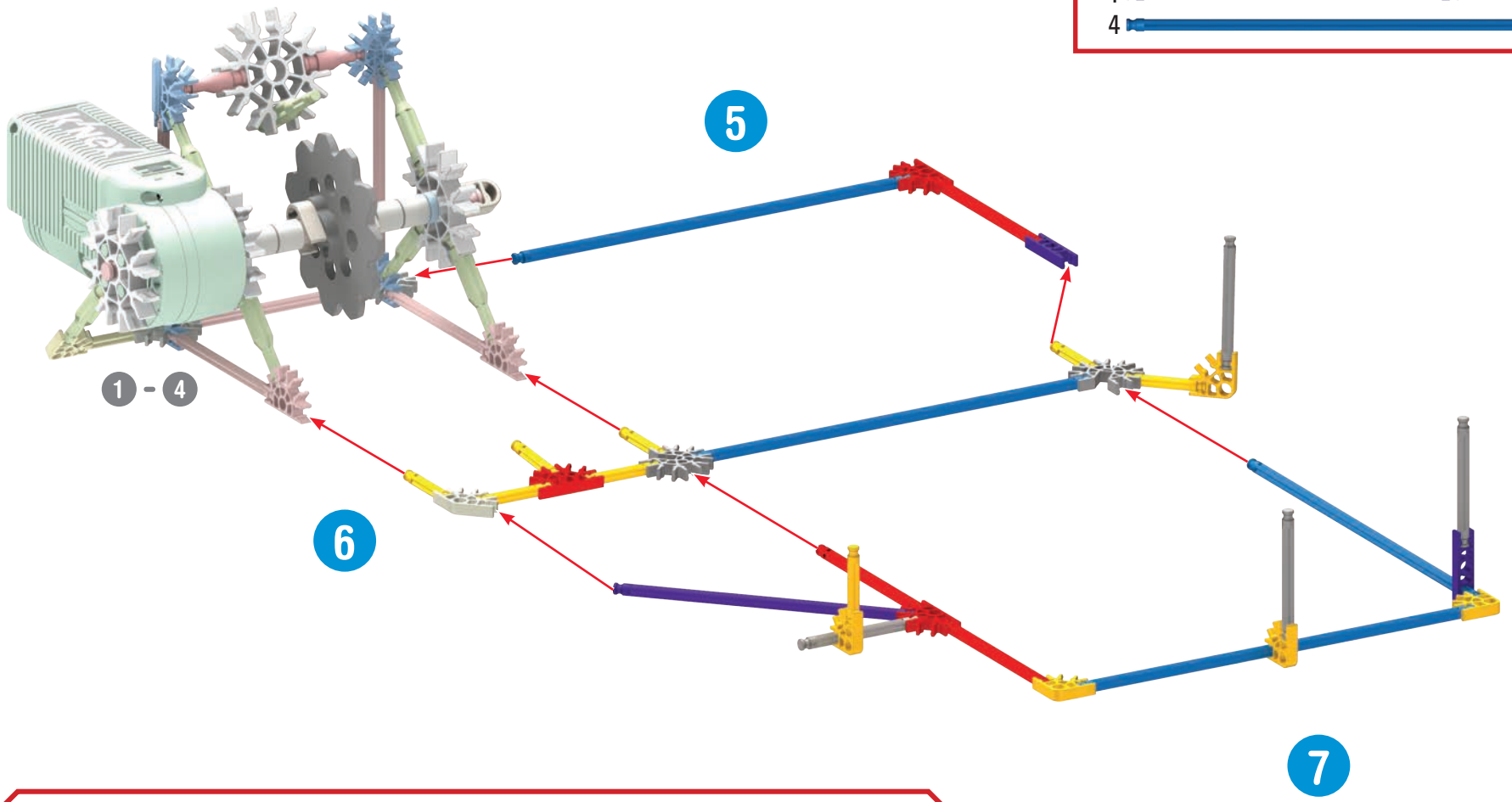

1 - 7

8 - 9

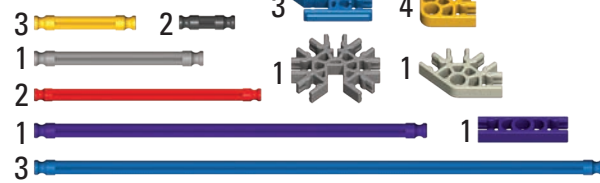

8

9

8 - 9

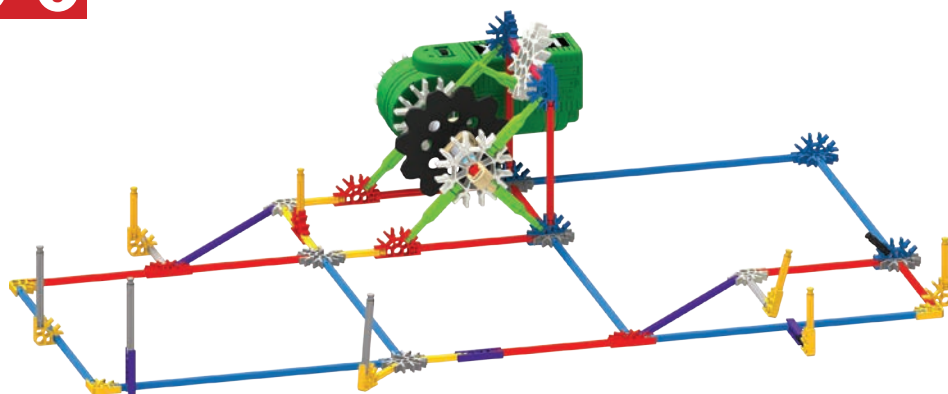



10 - 11

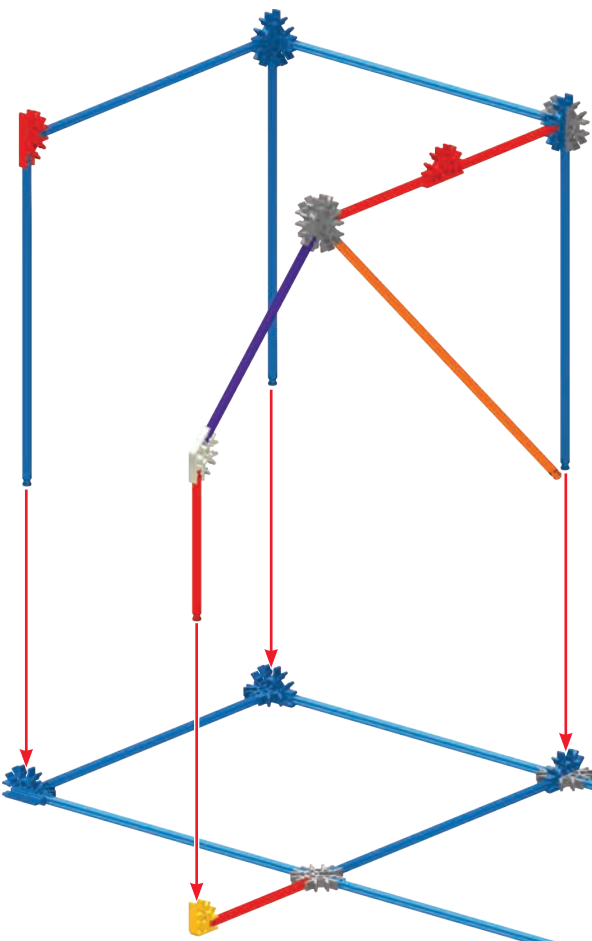
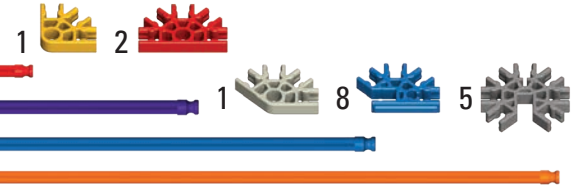

11

10

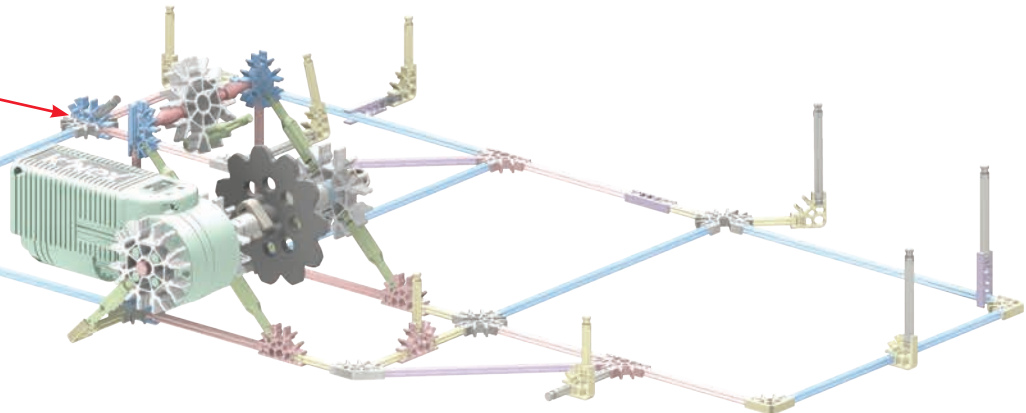

1 - 9

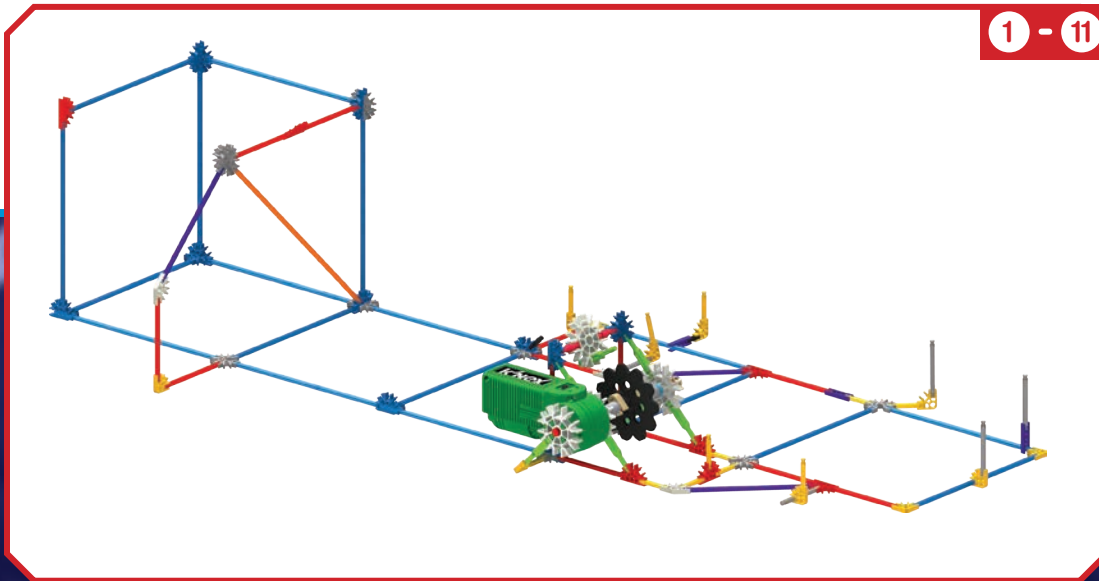

1 - 11

12

4

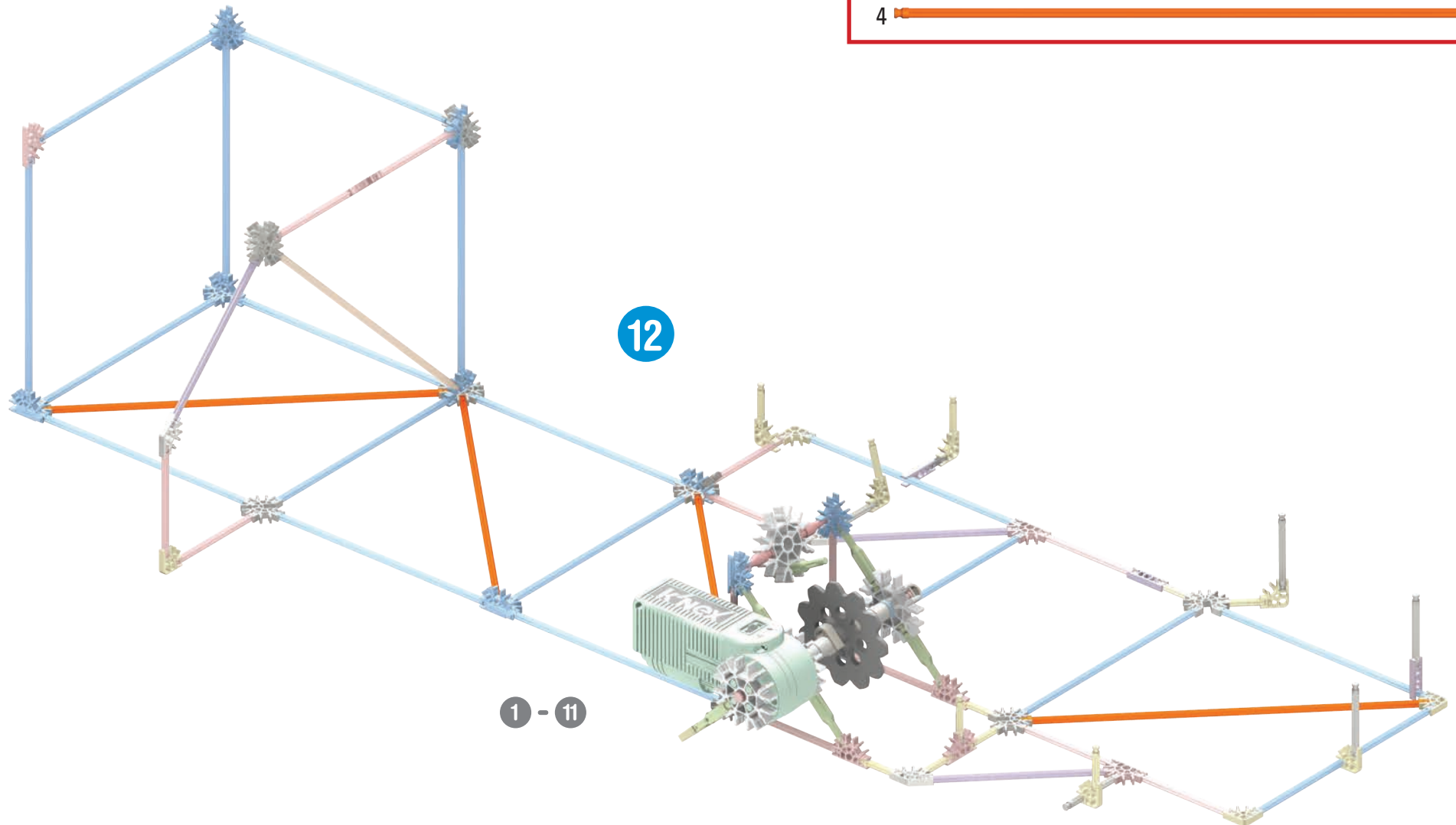

1 - 12

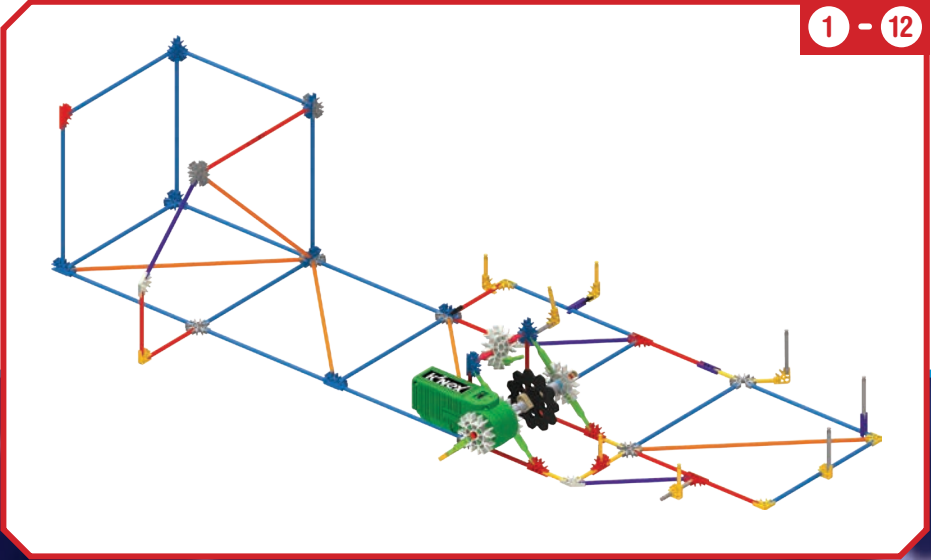

13

- 2 
- 3 
- 1 

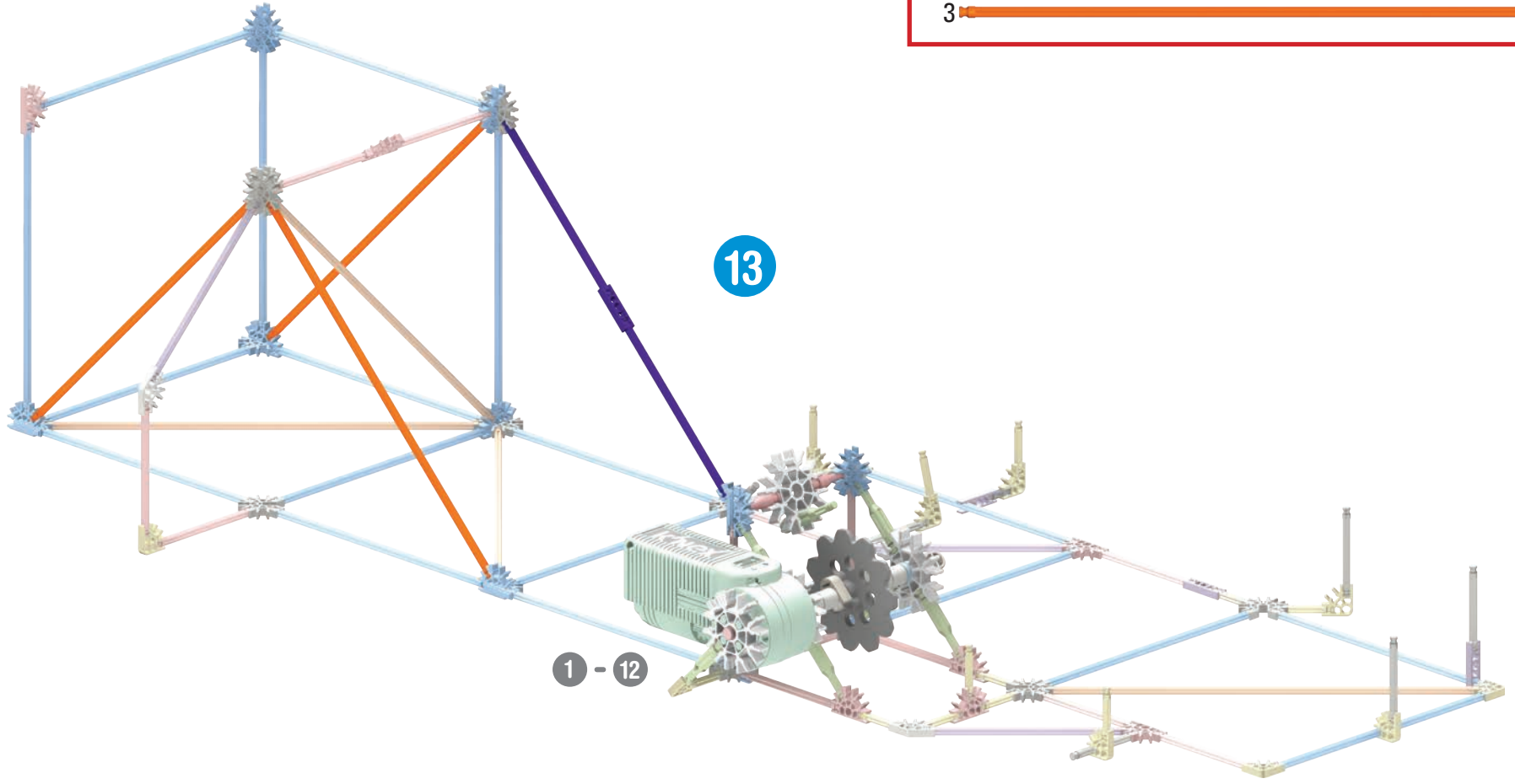

13

1 - 12

1 - 13

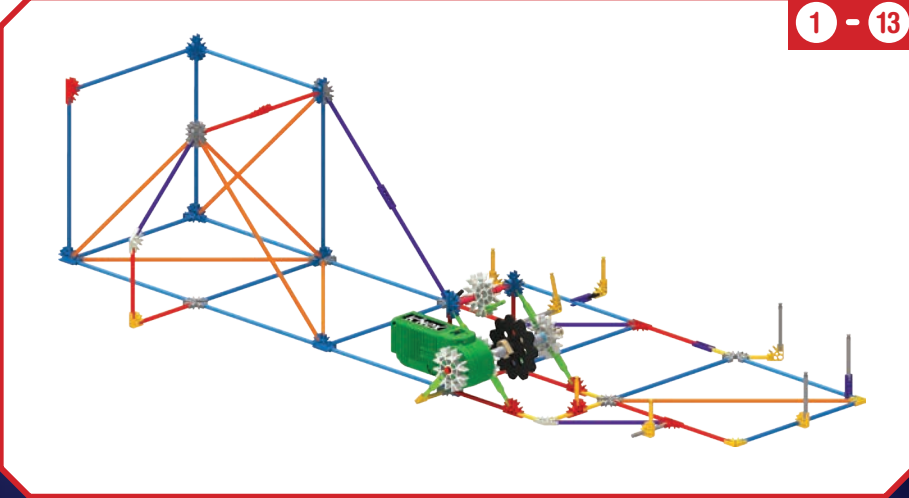







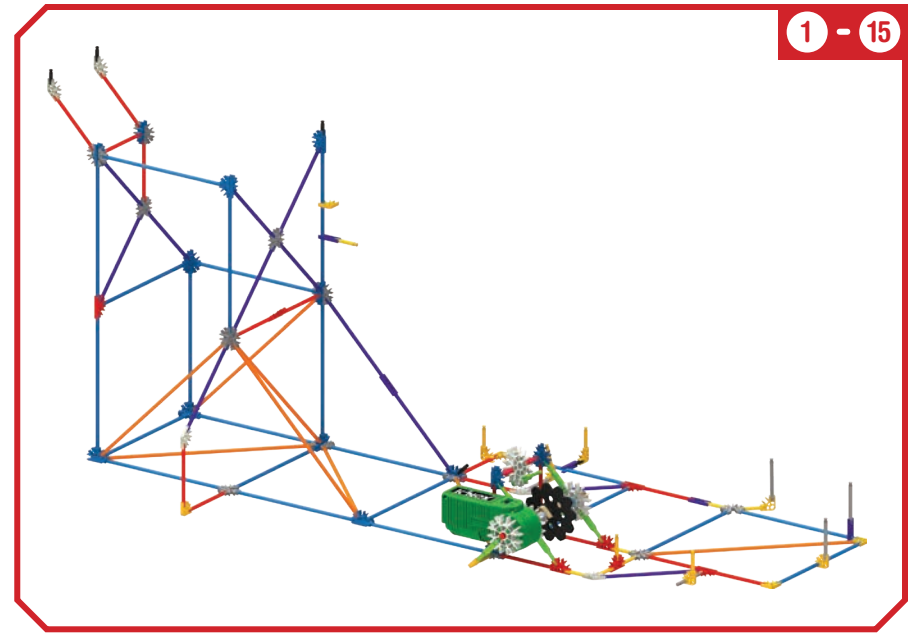
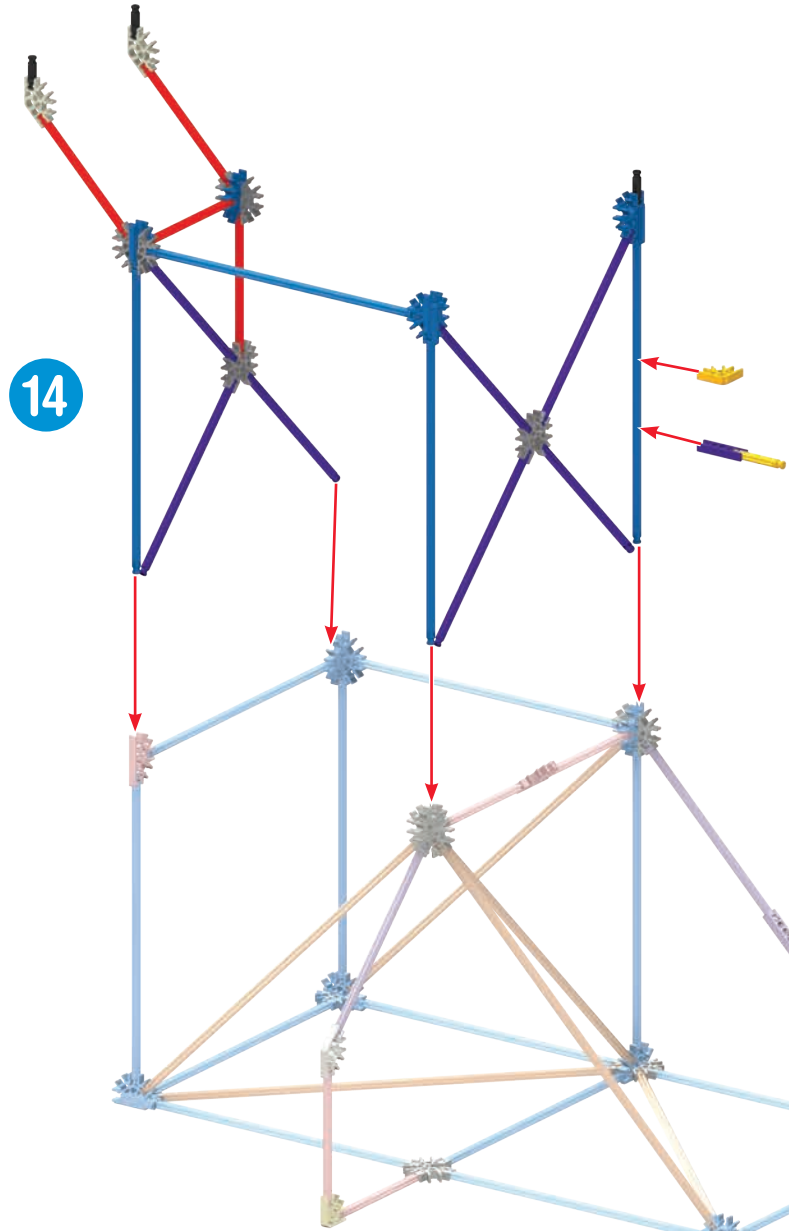



14

15

1 - 15



14 - 15

- 1  3  1  1 
- 4  1  2  6  4 
- 7 
- 4 

1 - 13

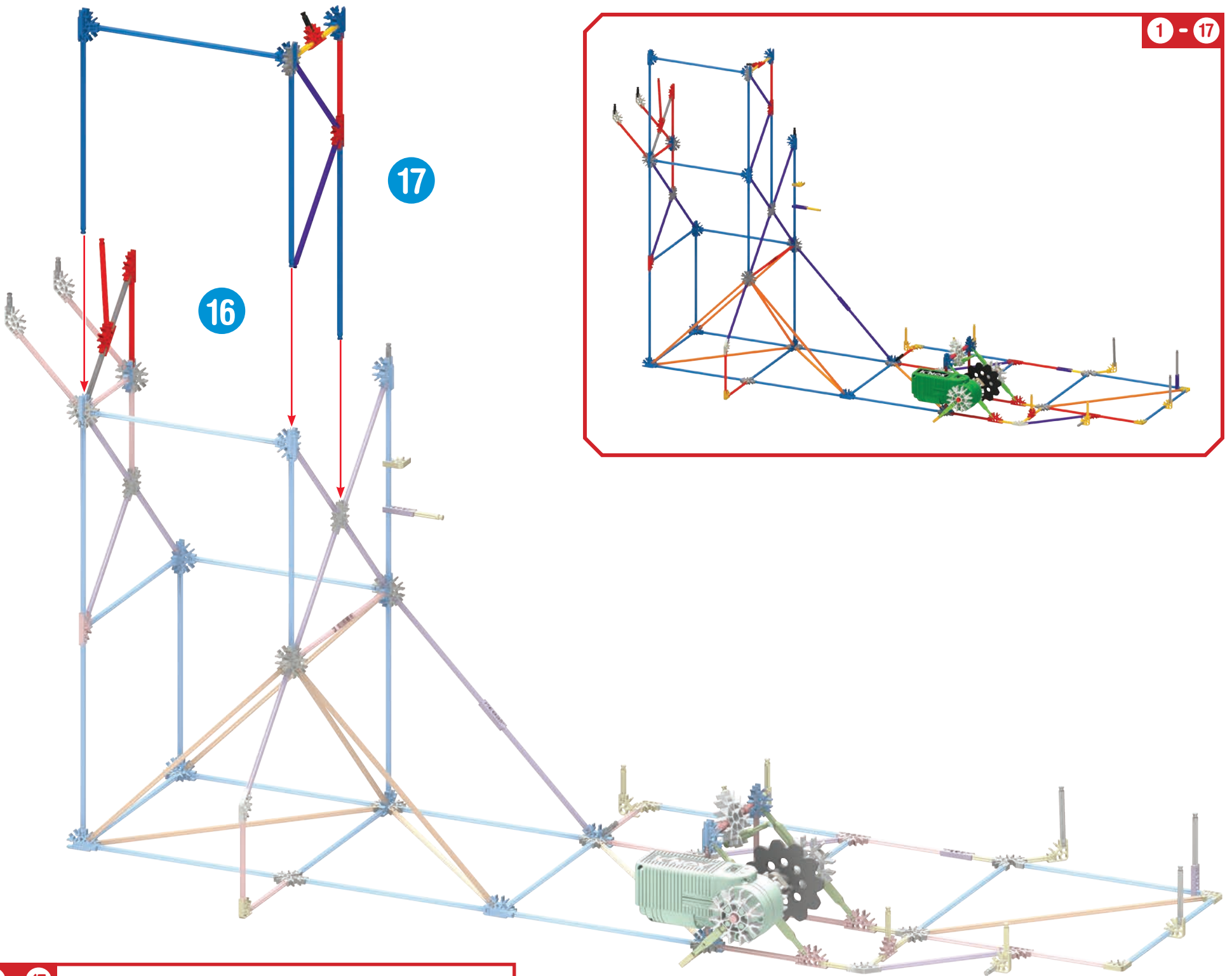

16 - 17

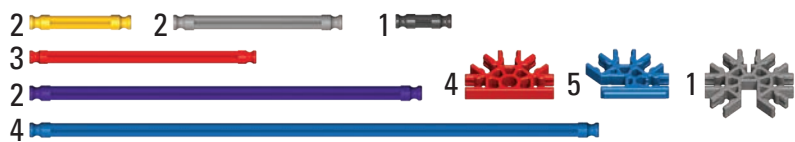

18

- 4 yellow pins
- 1 red pin
- 4 purple pins
- 6 blue pins
- 1 grey gear
- 3 red gears
- 5 blue gears
- 1 grey gear

18

1 - 18

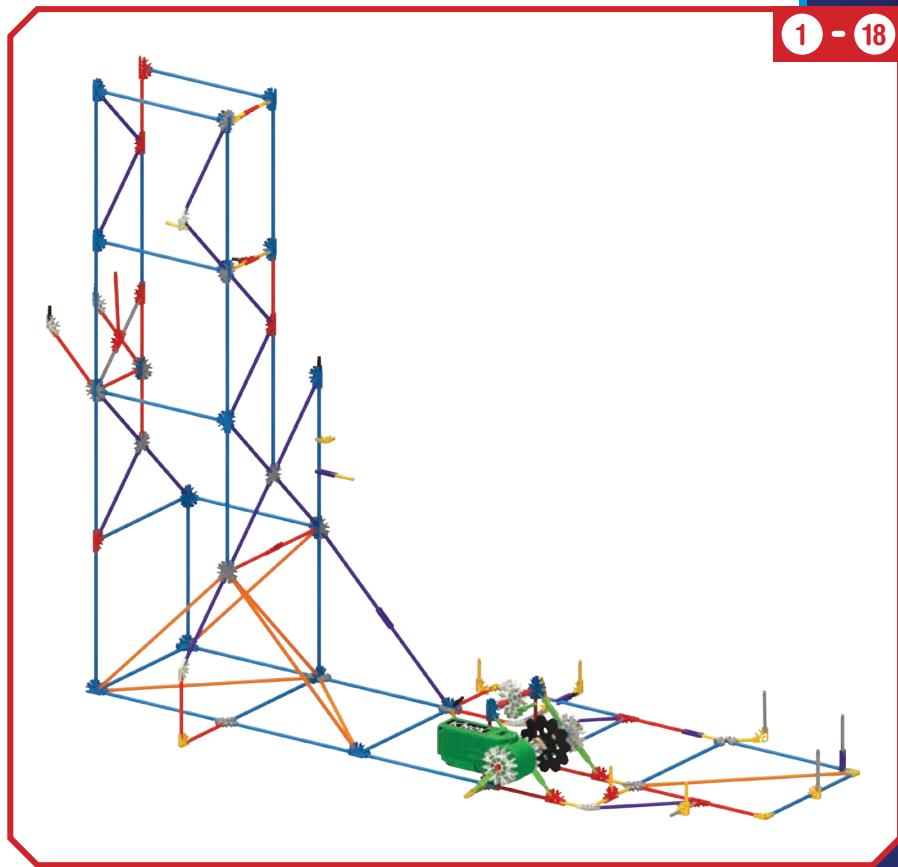

1 - 17

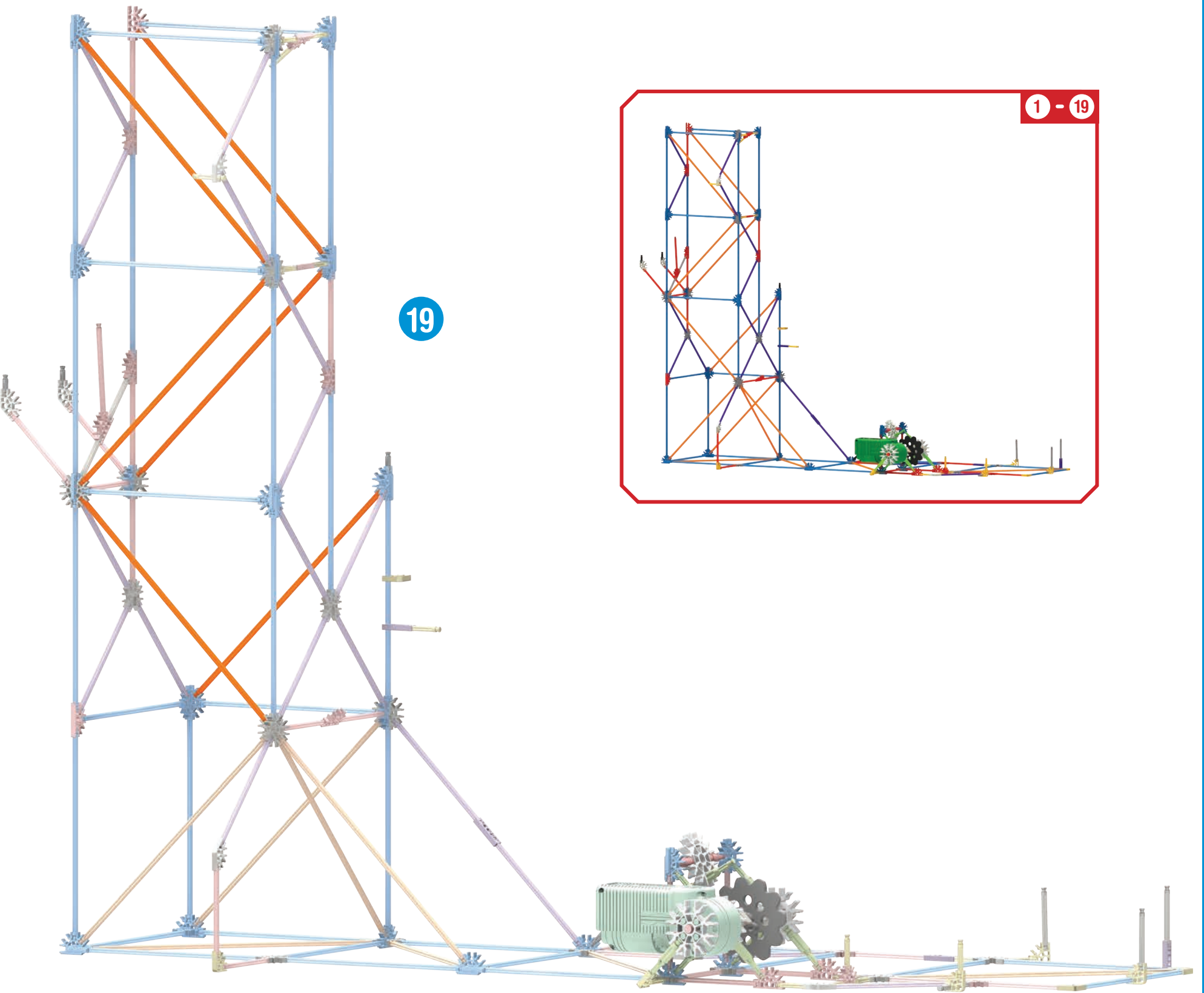

19

1 - 19

19



6

1 - 18

20 - 21

- 8  3 
- 4  5  8  2 
- 6 

20

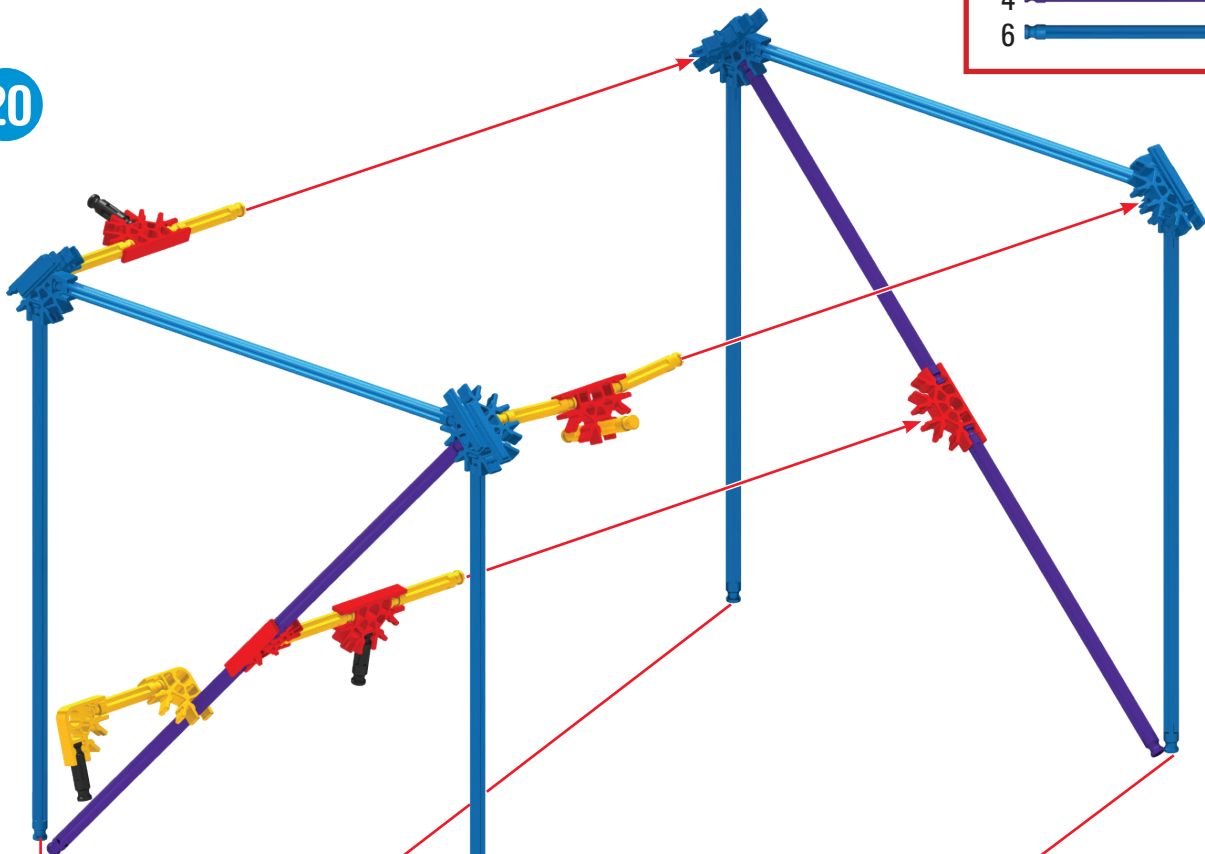

21

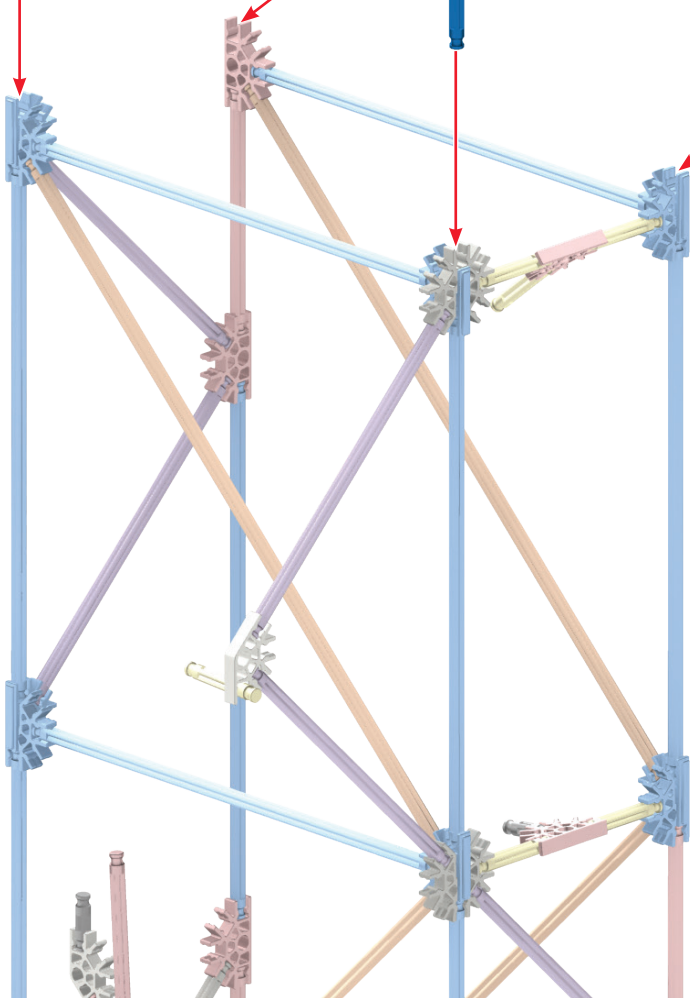

1 - 19

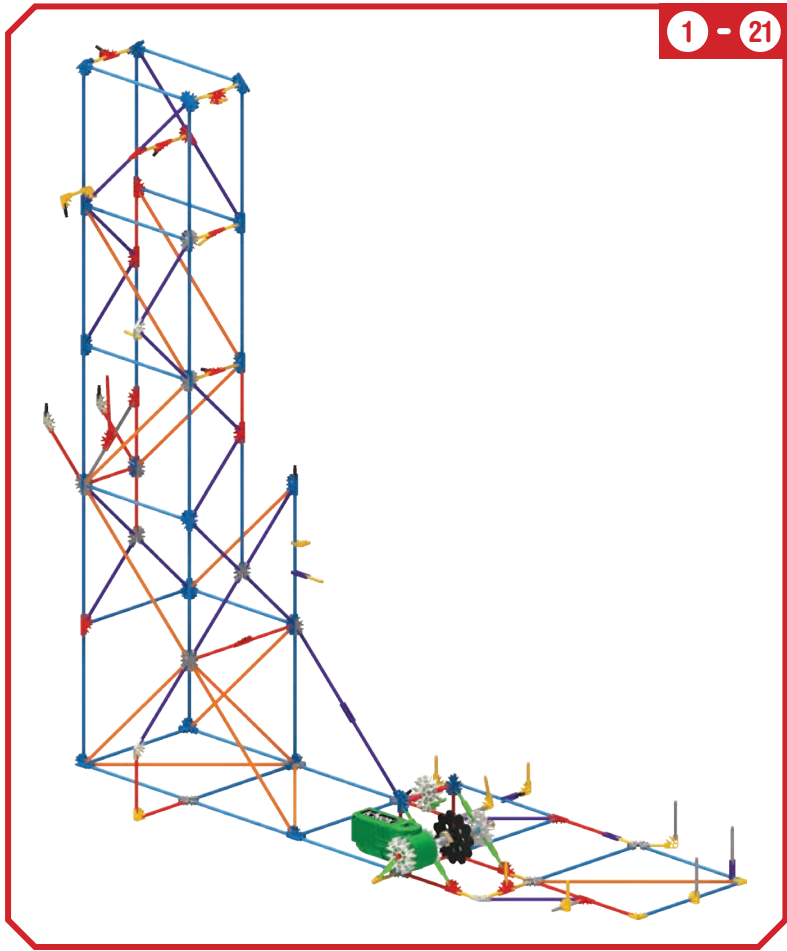

1 - 21



22 - 23



7



22

23

22 - 23

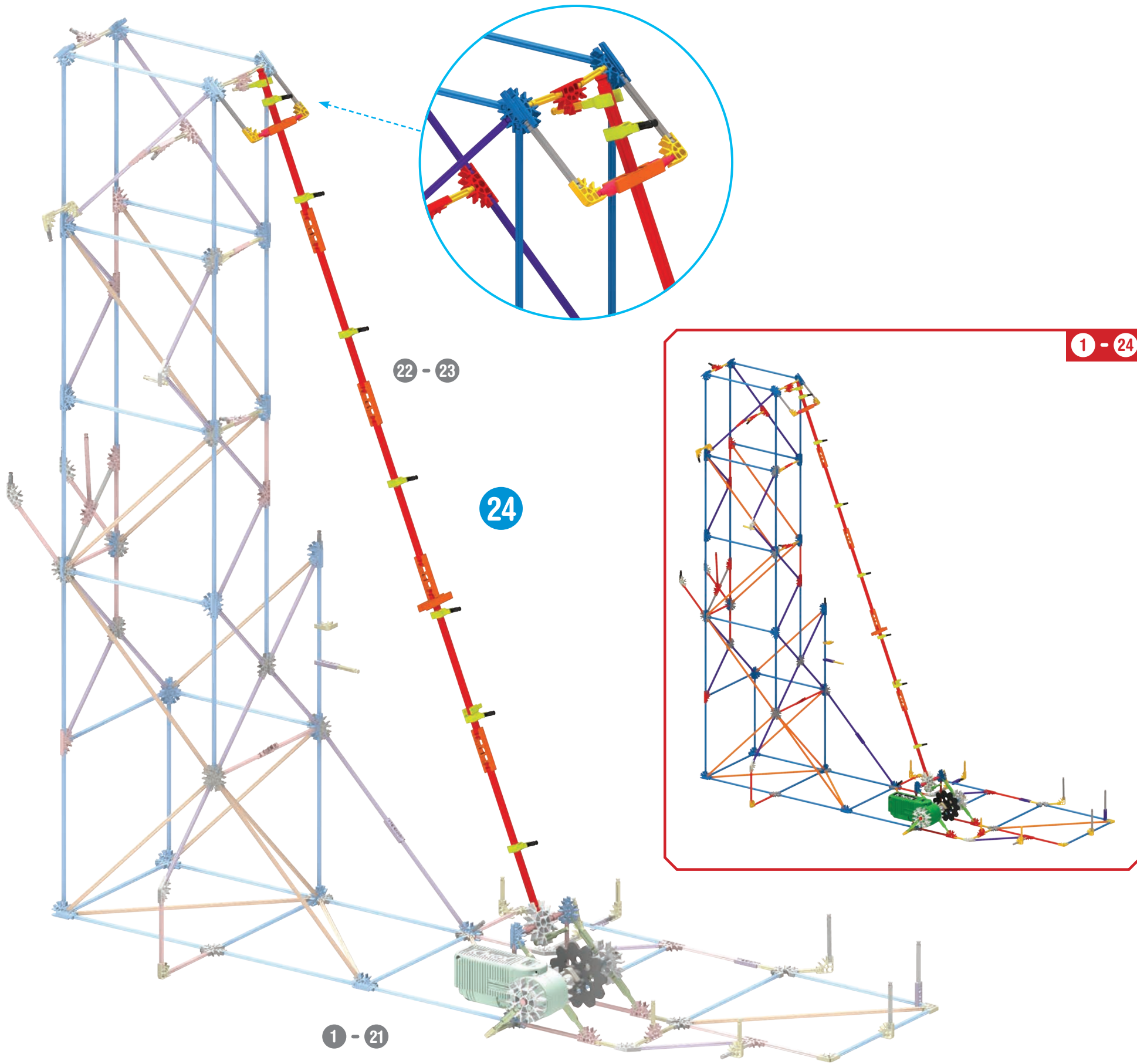

x2

25

25



27



27

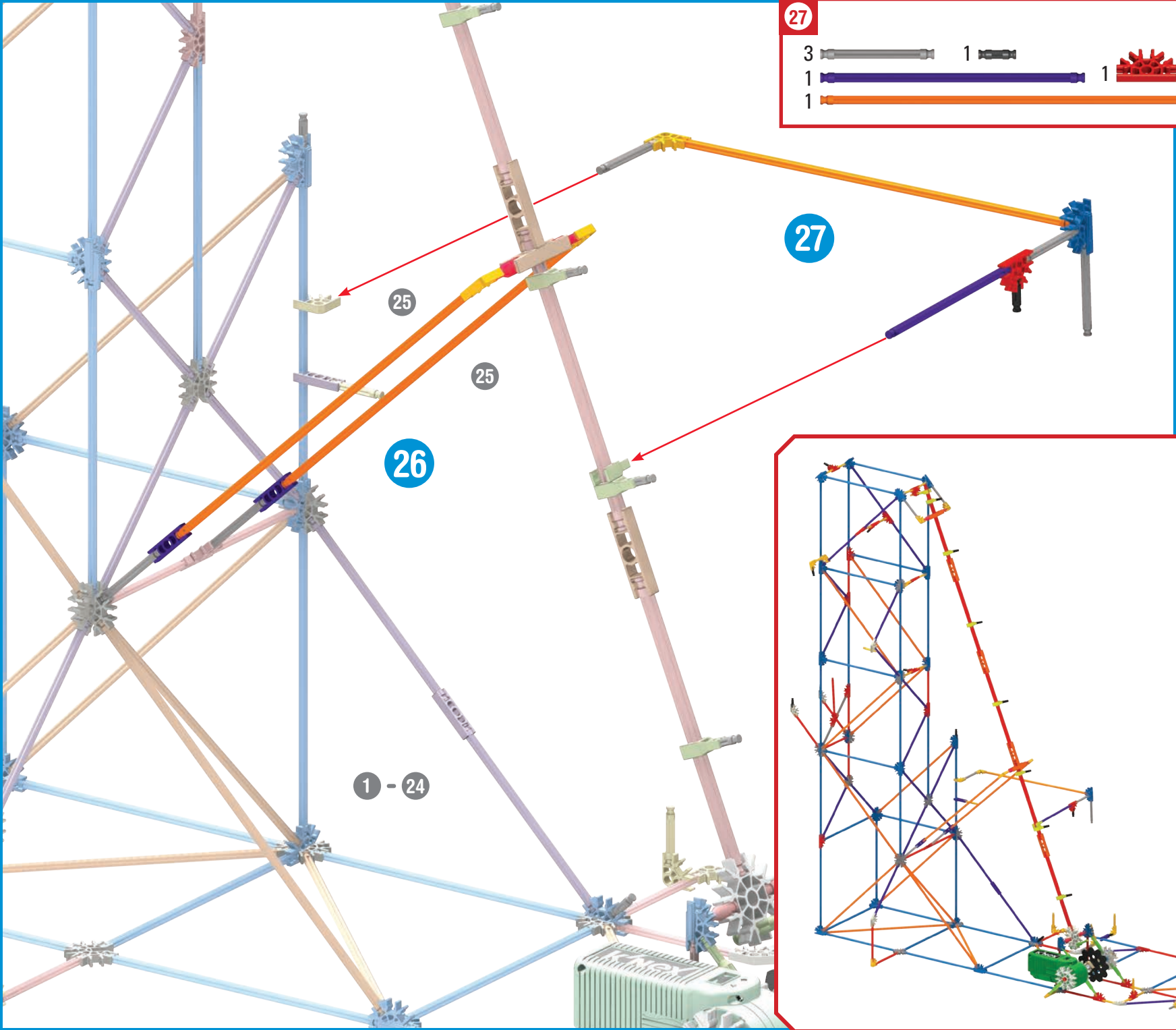

26

25

25

1 - 24

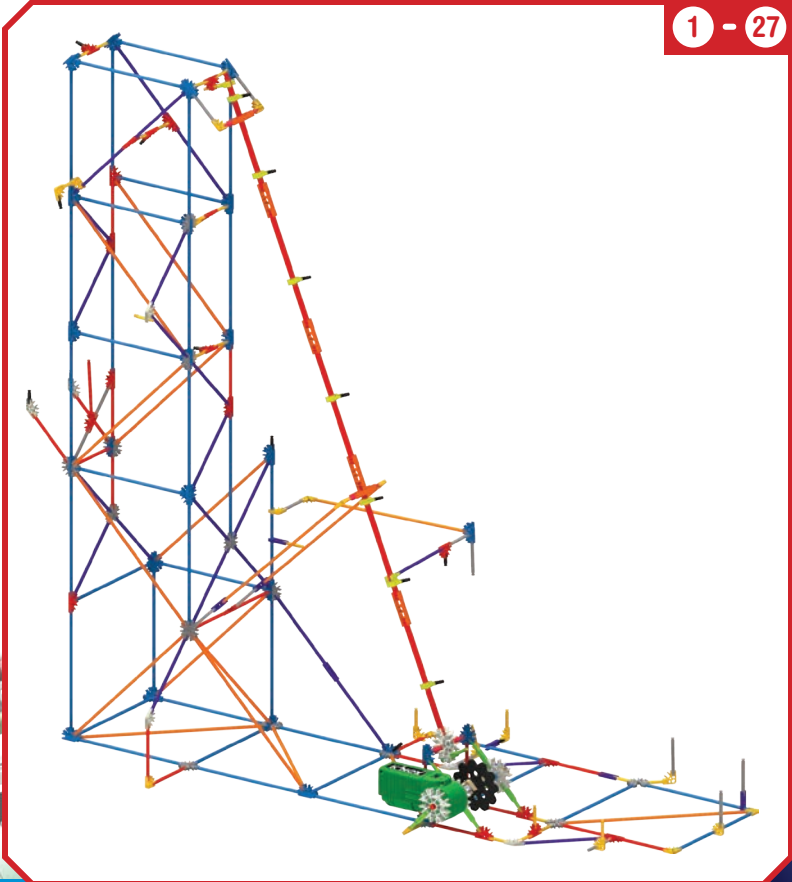

1 - 27



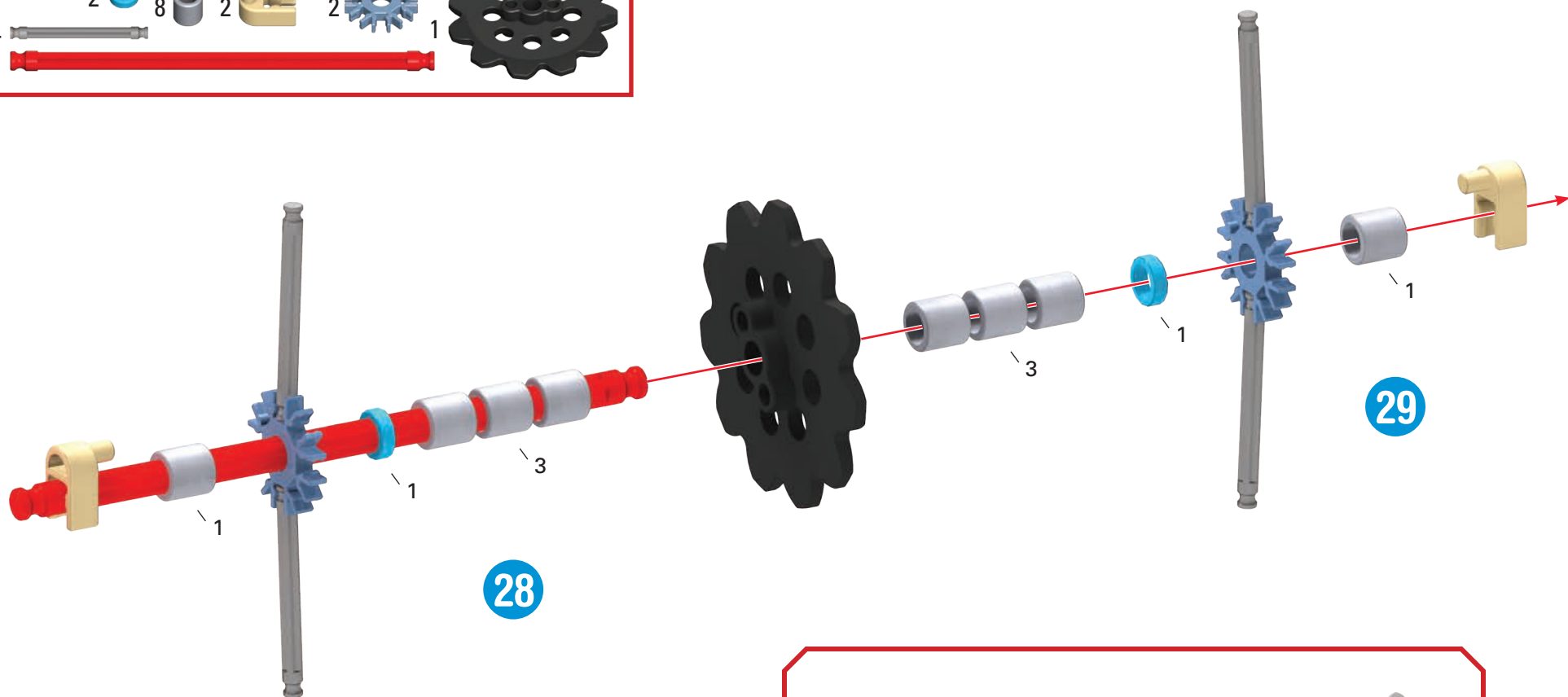
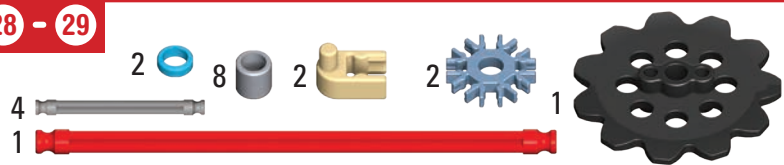

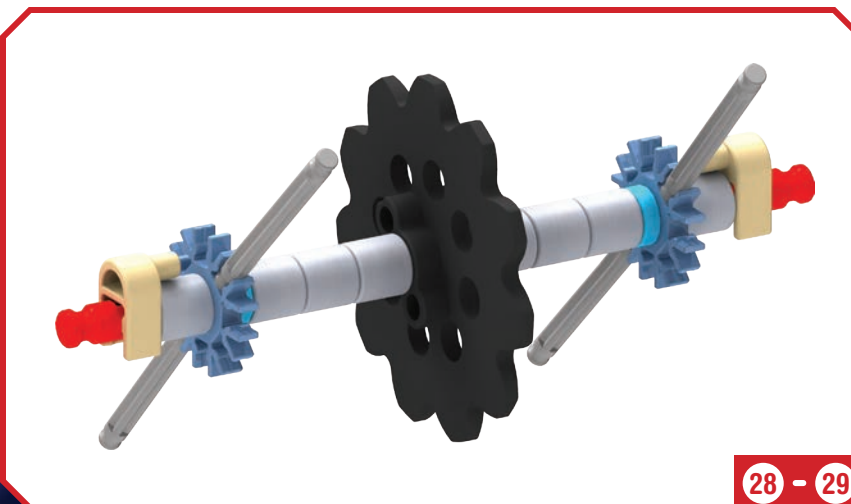

28 - 29



29



30 - 31

- 2  2 
  - 2  3 
  - 3 
- 2  5 

30

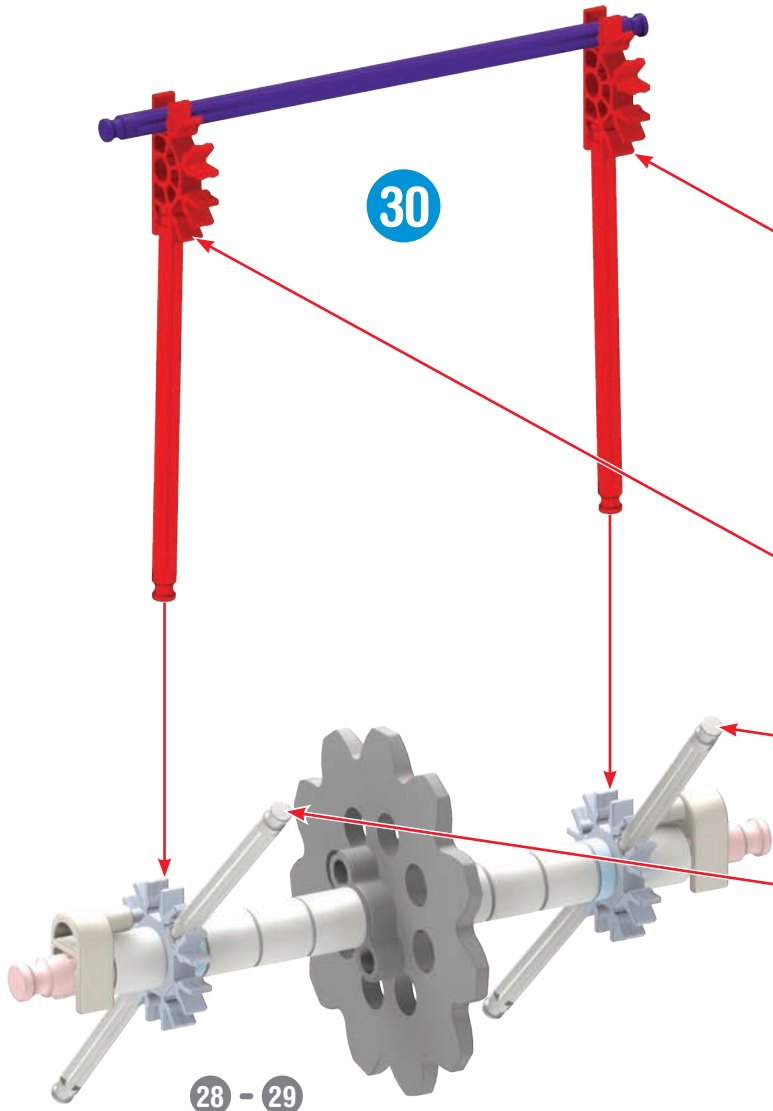

28 - 29

31

28 - 31



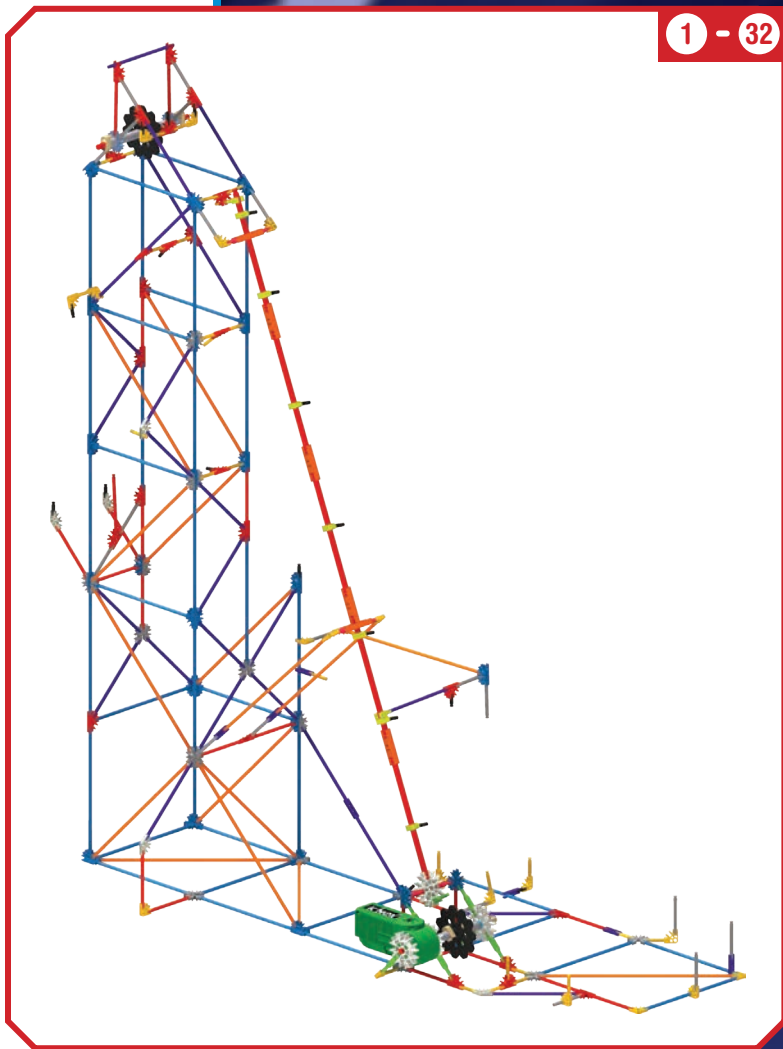
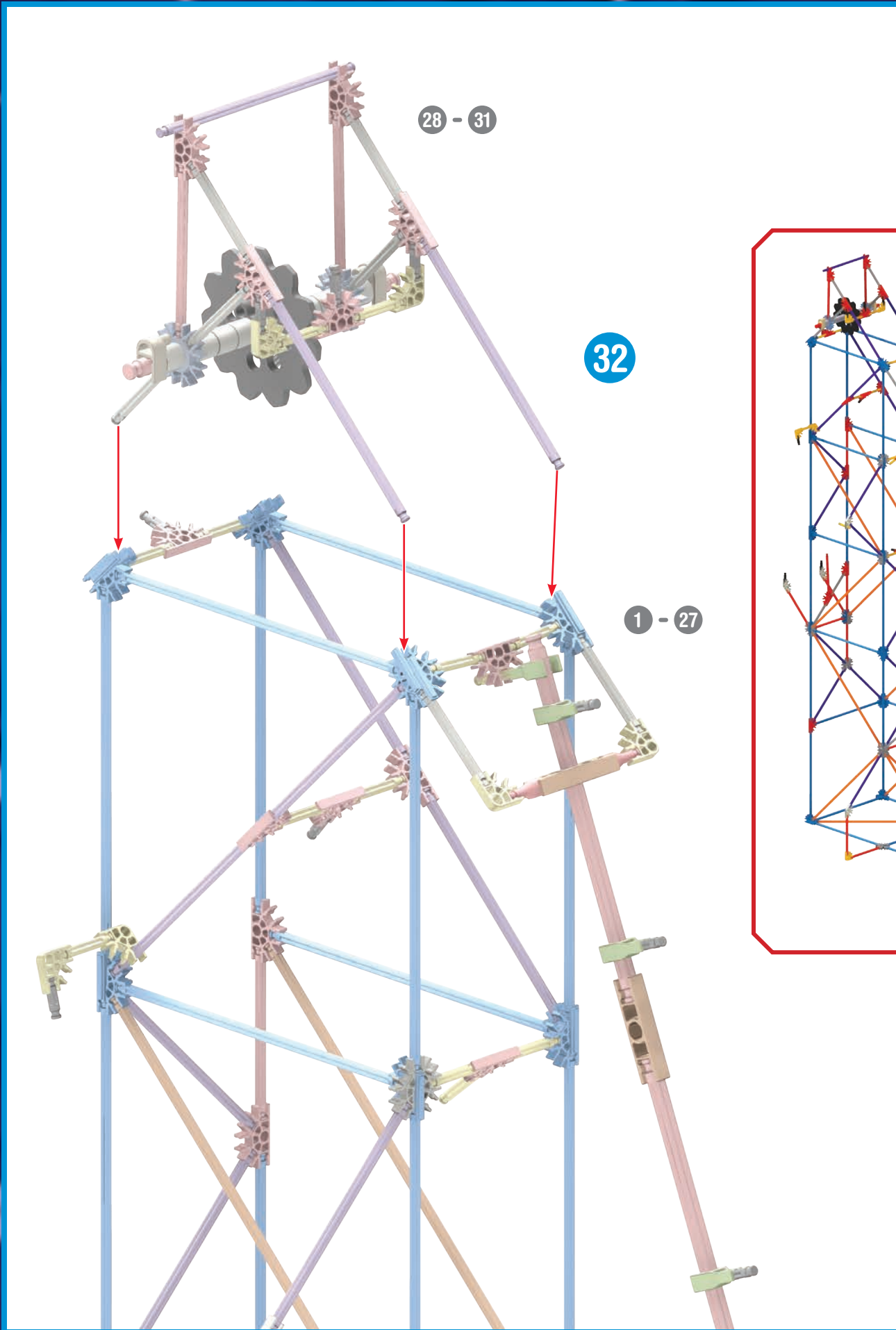

33

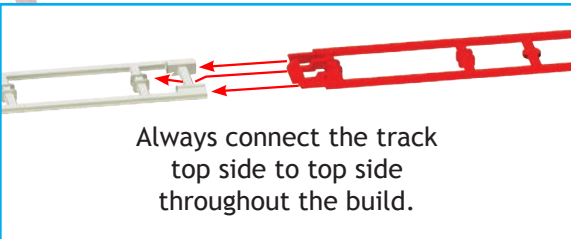
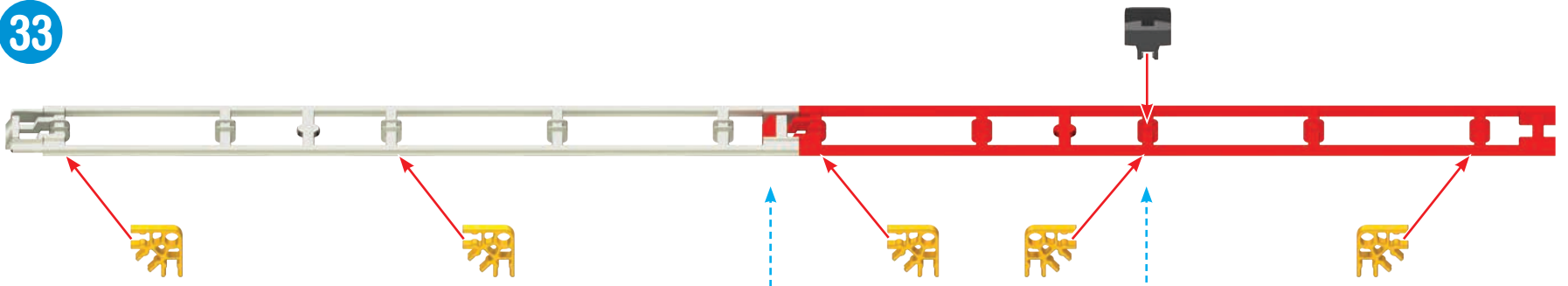

Always connect the track top side to top side throughout the build.

Attach the black chain guides to the top of the track and attach the connectors to the bottom of the track exactly as shown.  
Be sure to push the connectors on firmly until they "click".

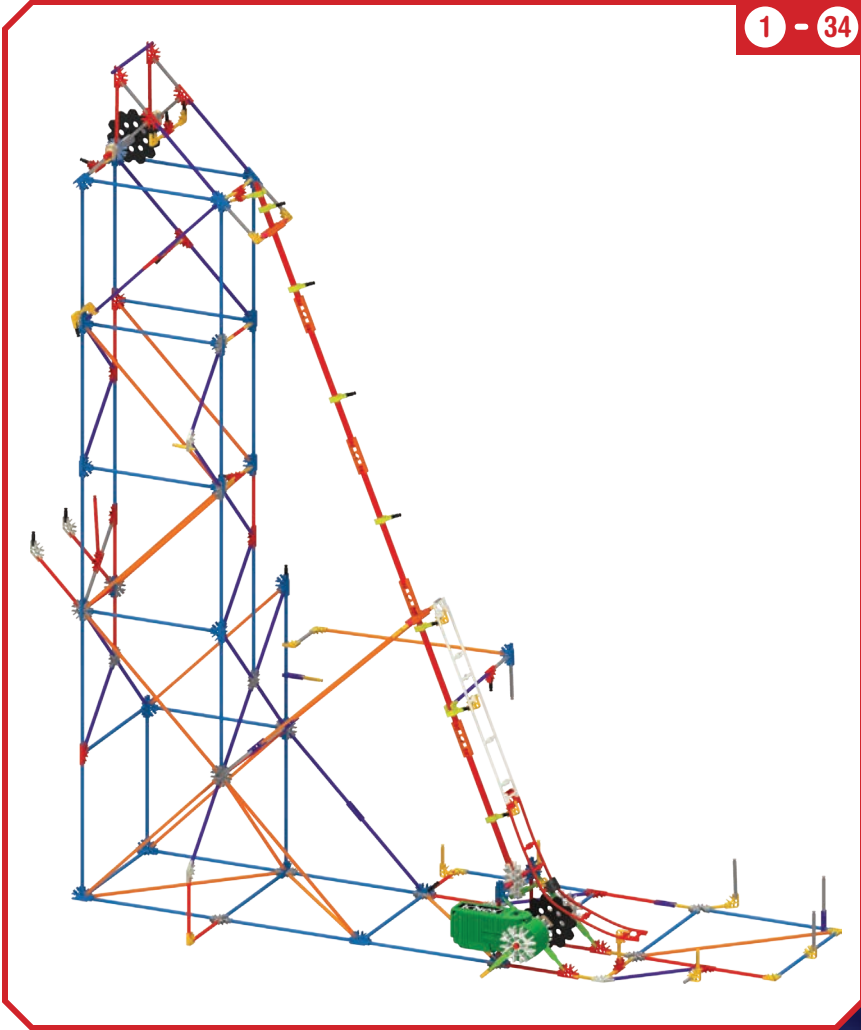

1 - 34

34

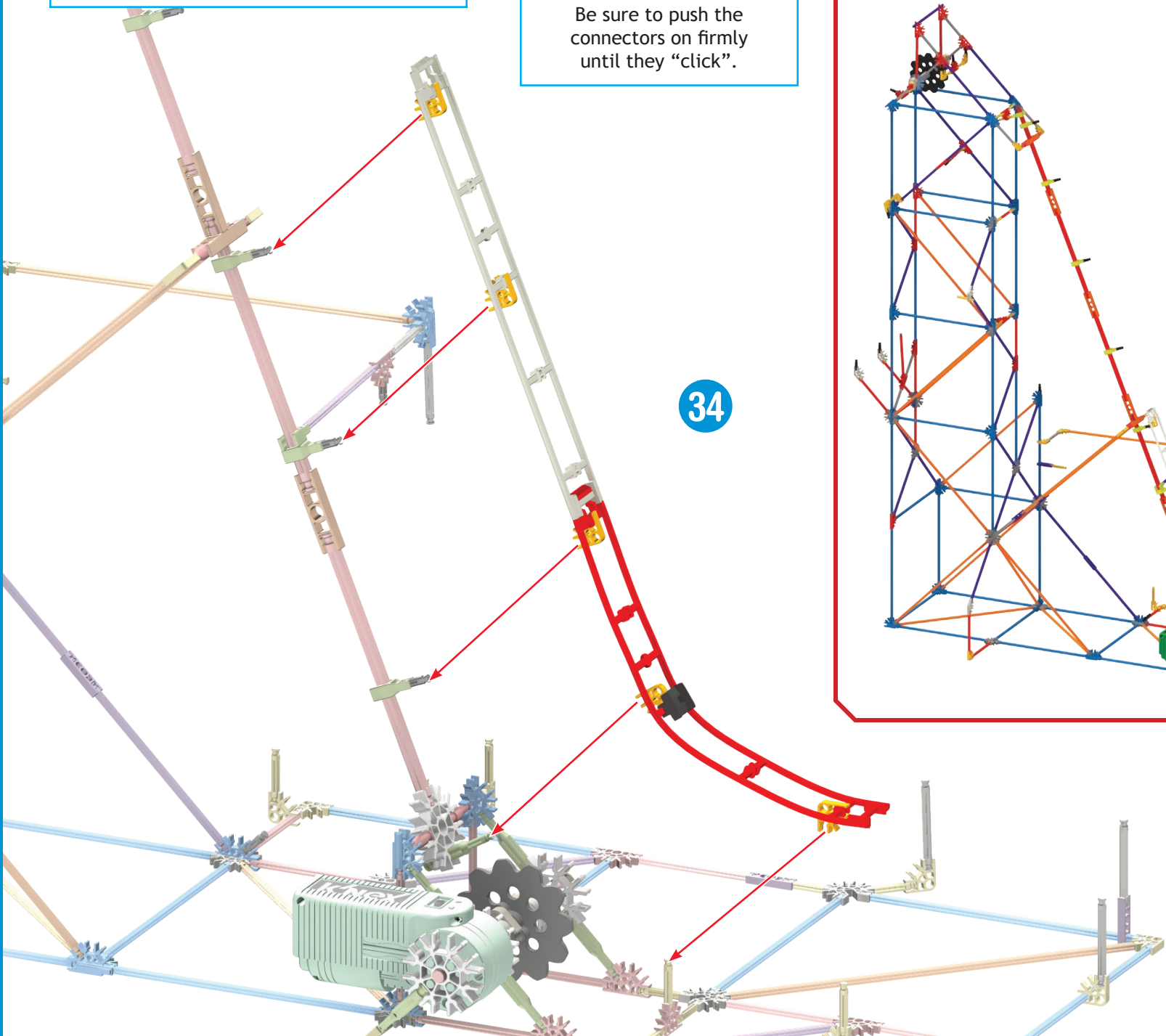

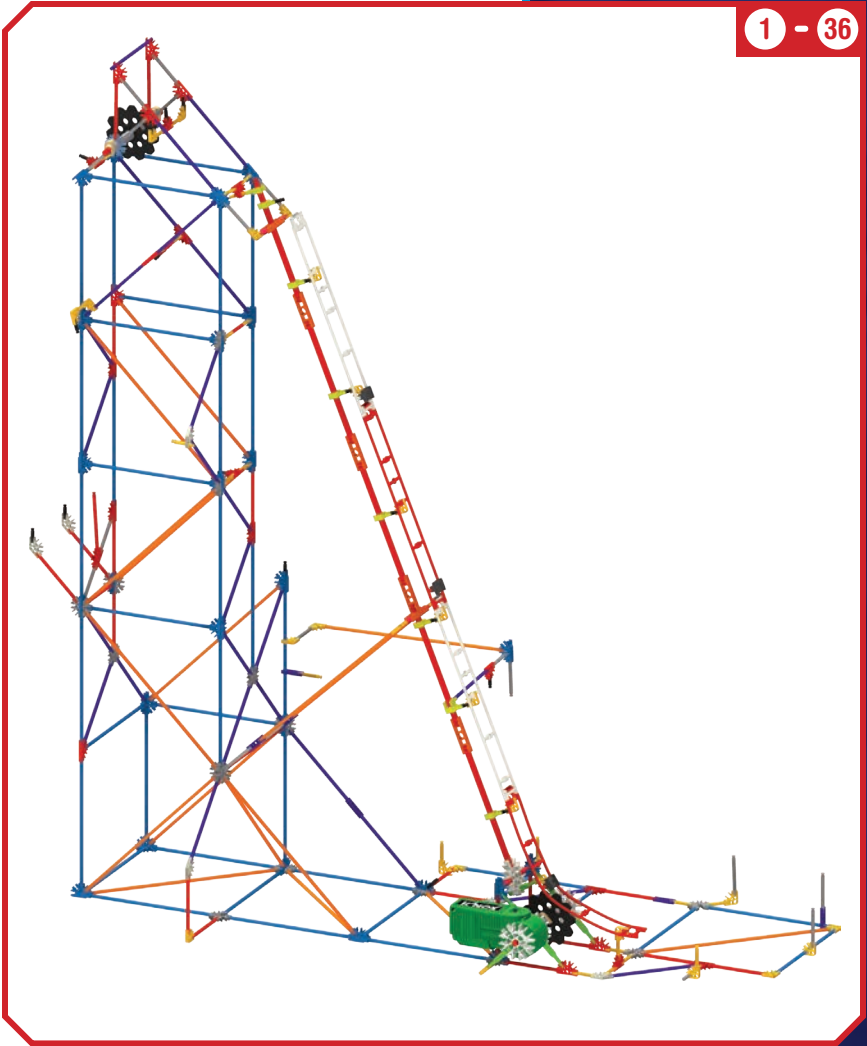
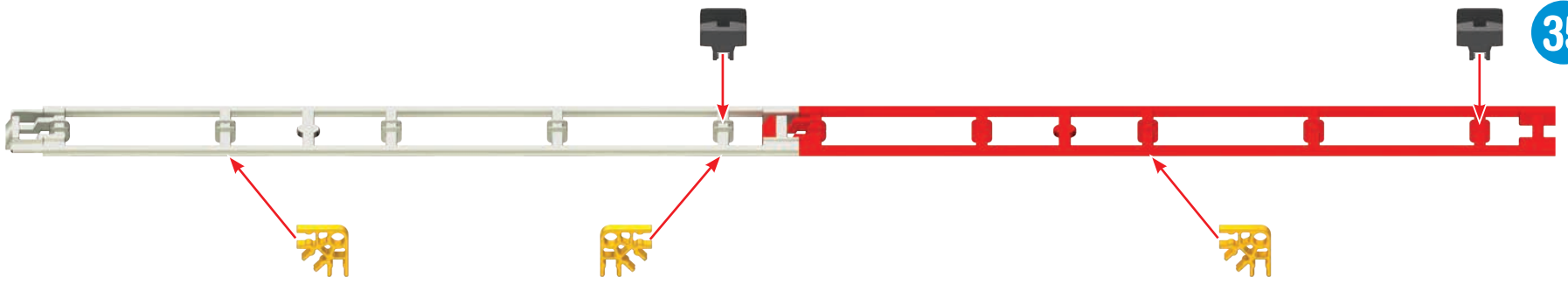

Always join this end of the track to the previous track piece first, then connect the rest of the track to the tower.



37

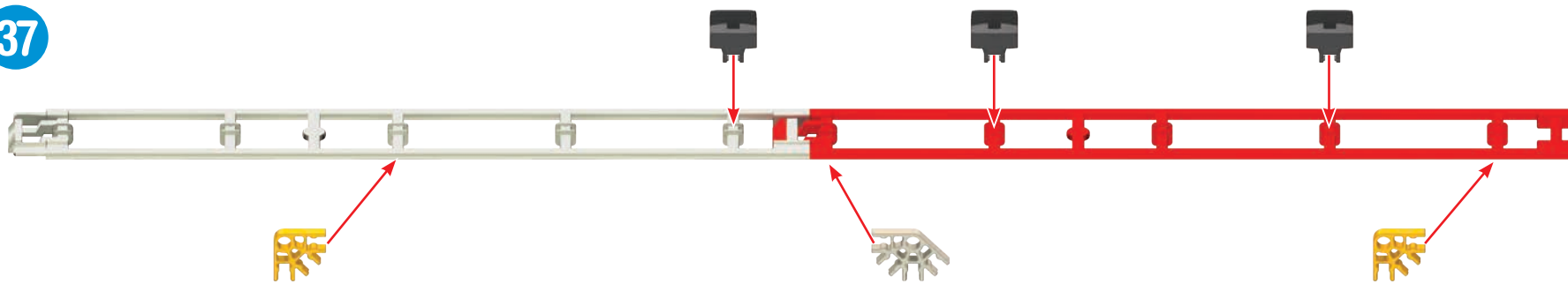

38

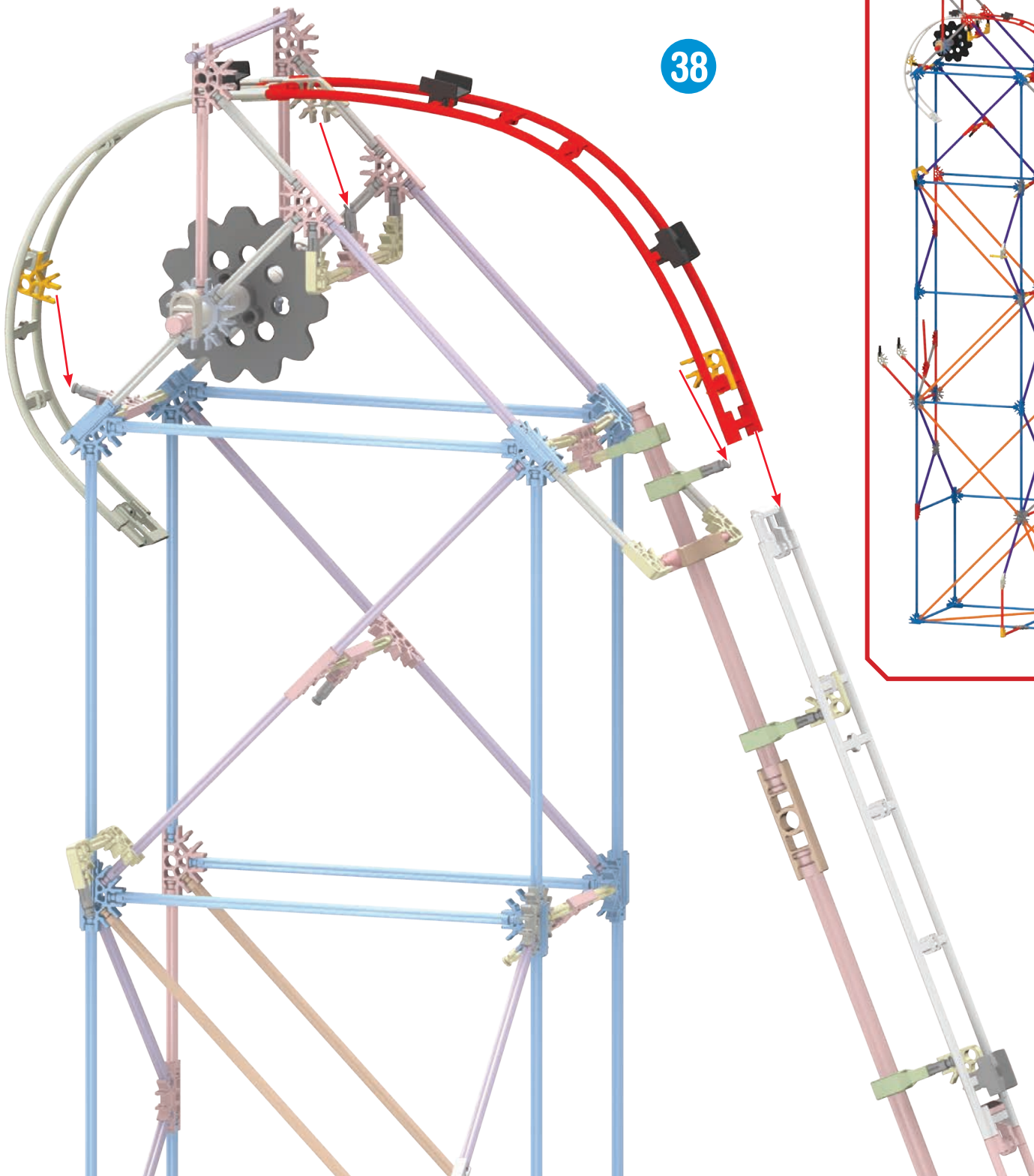

1 - 38



39

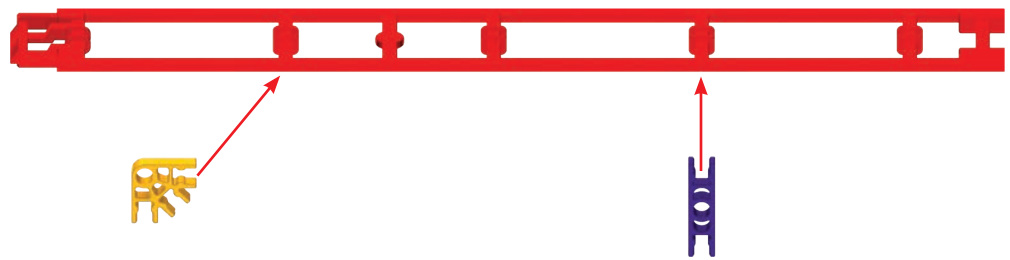

40



1 - 40

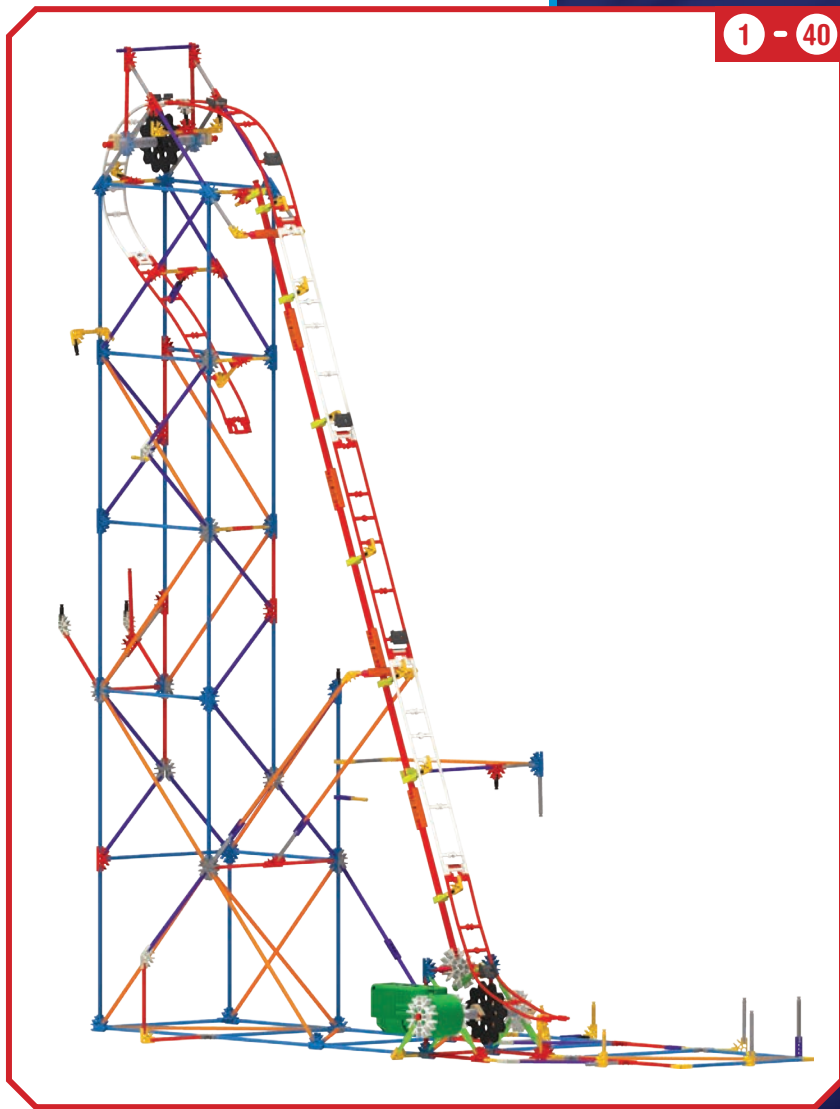

41

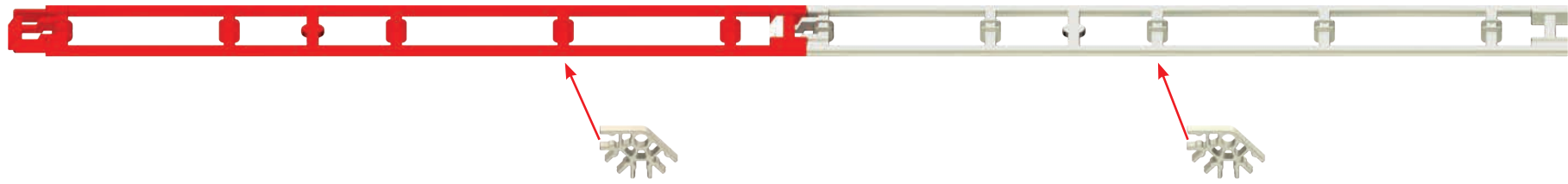

42

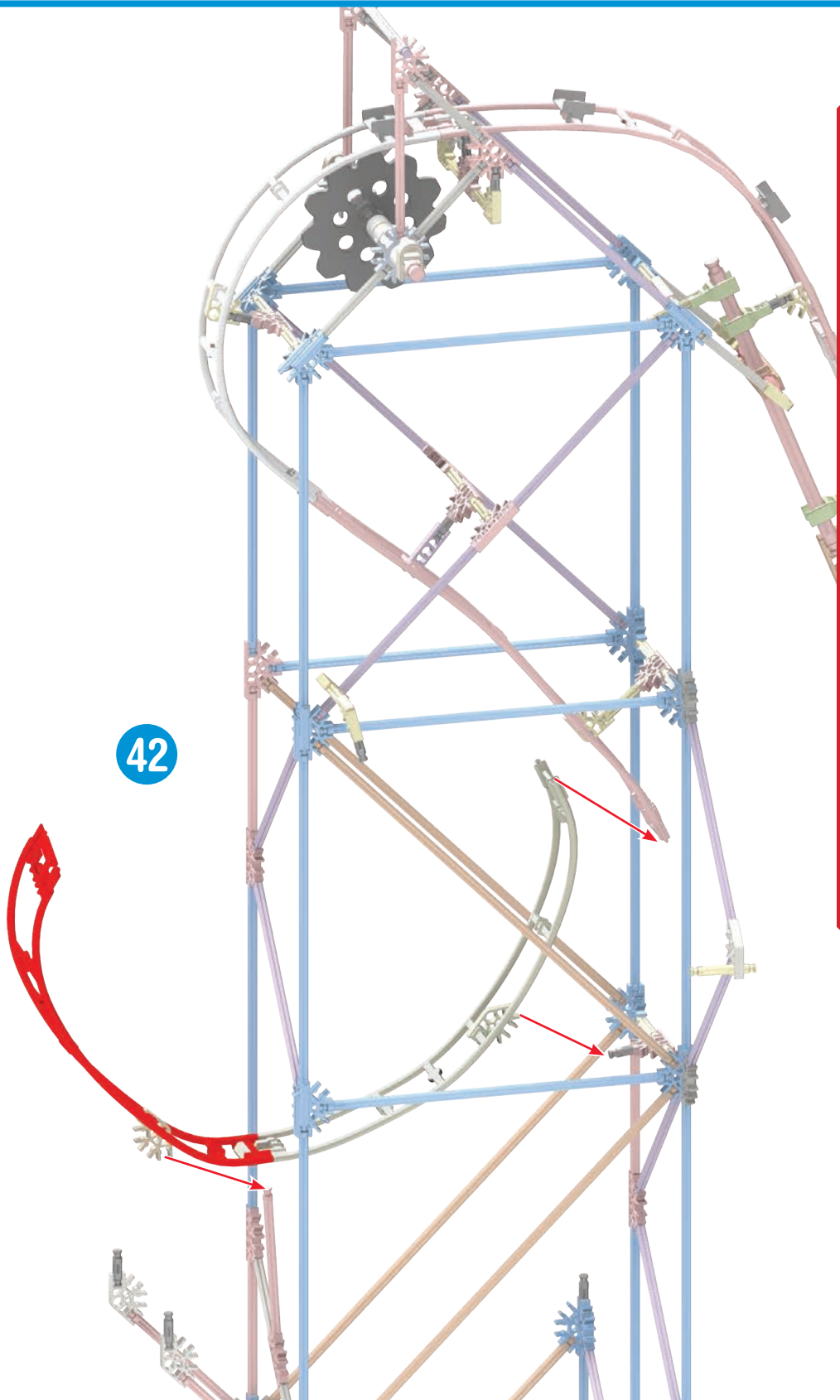

1 - 42

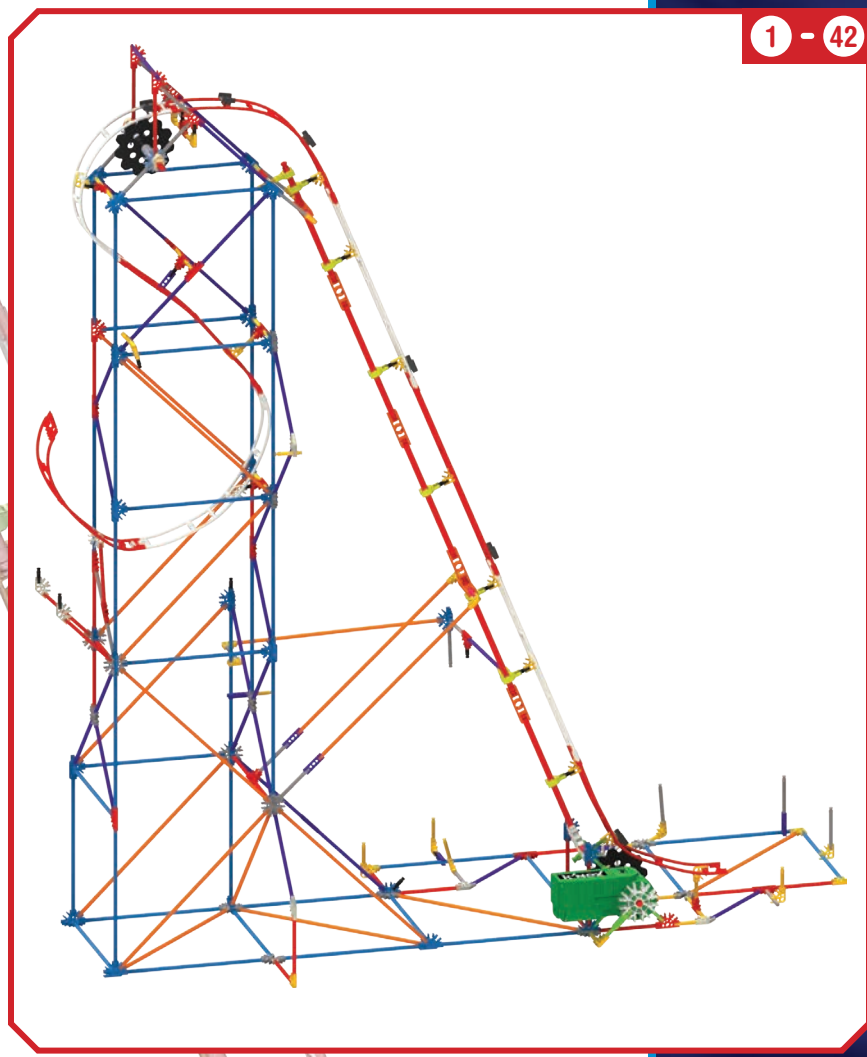

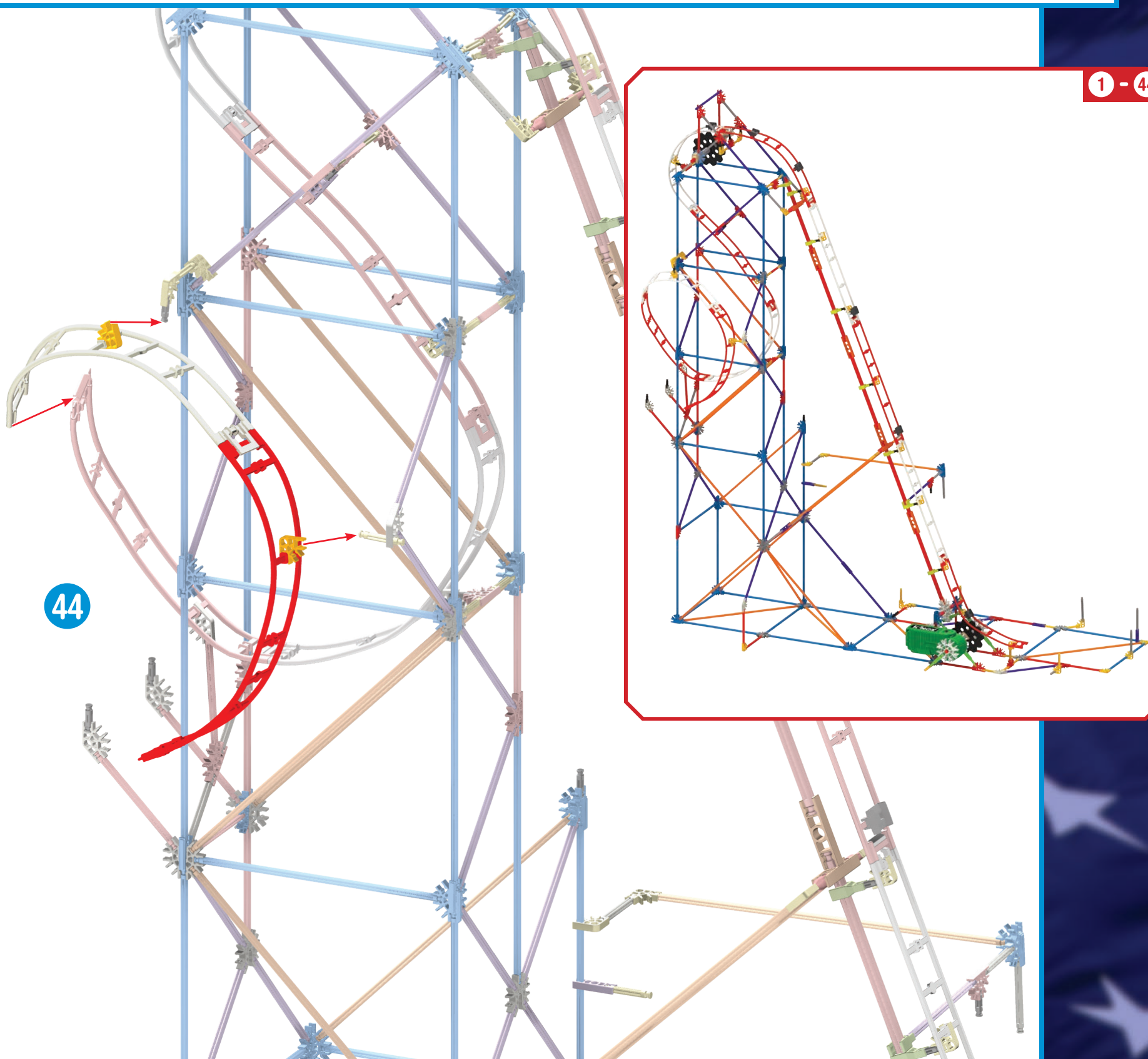
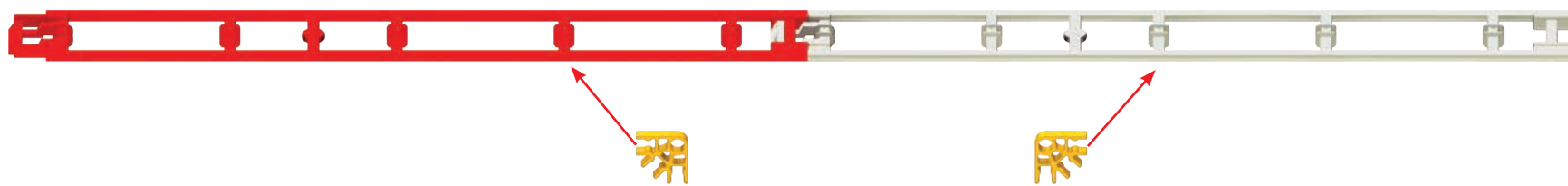

45

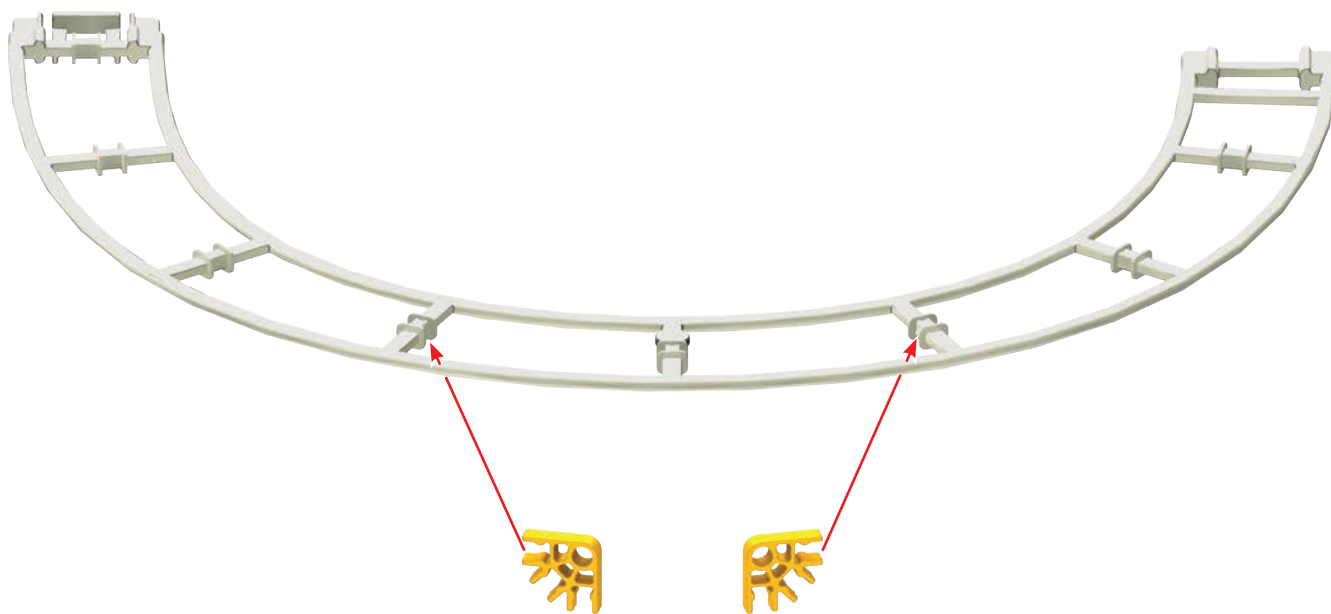

46

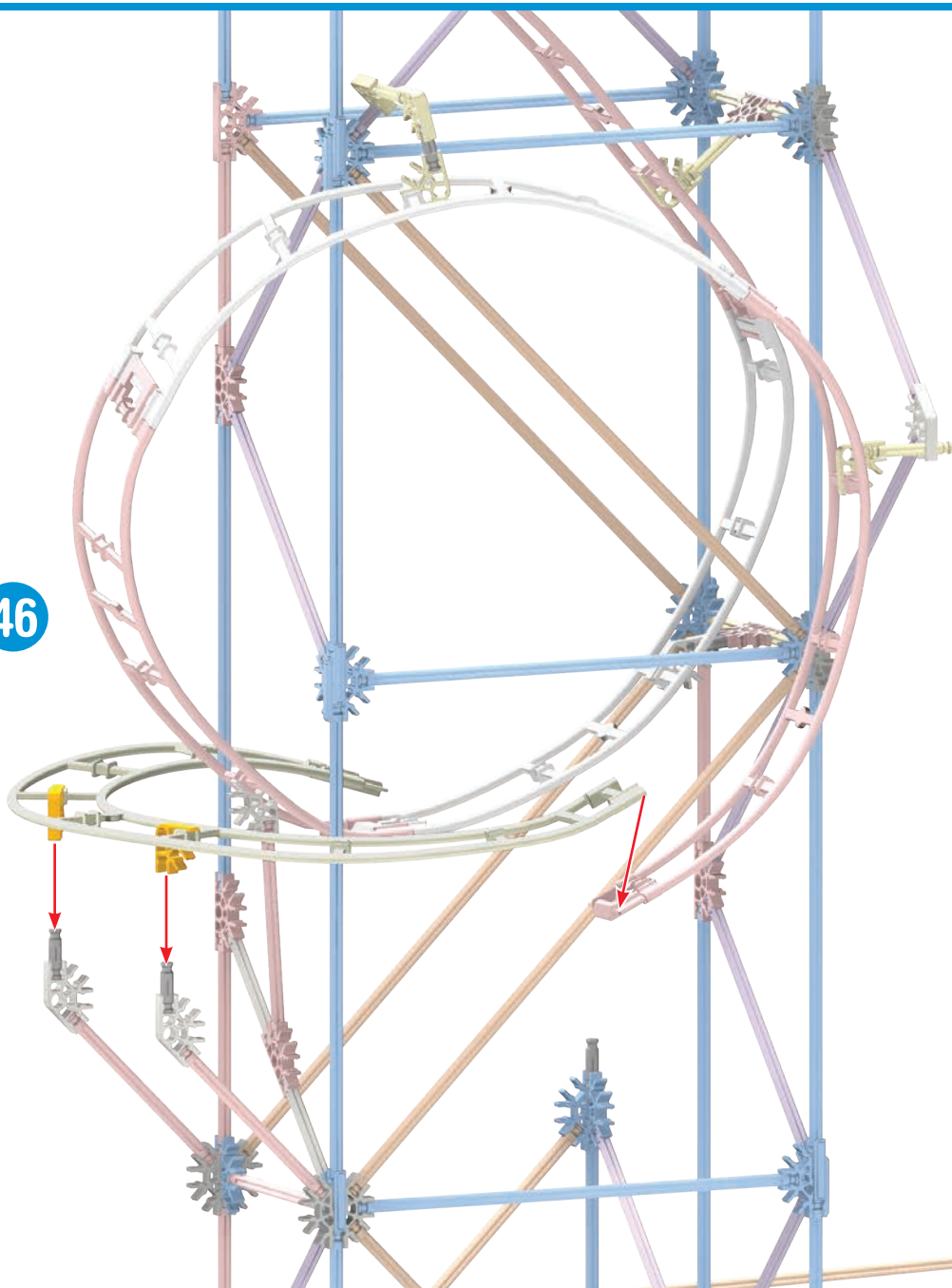

1 - 46

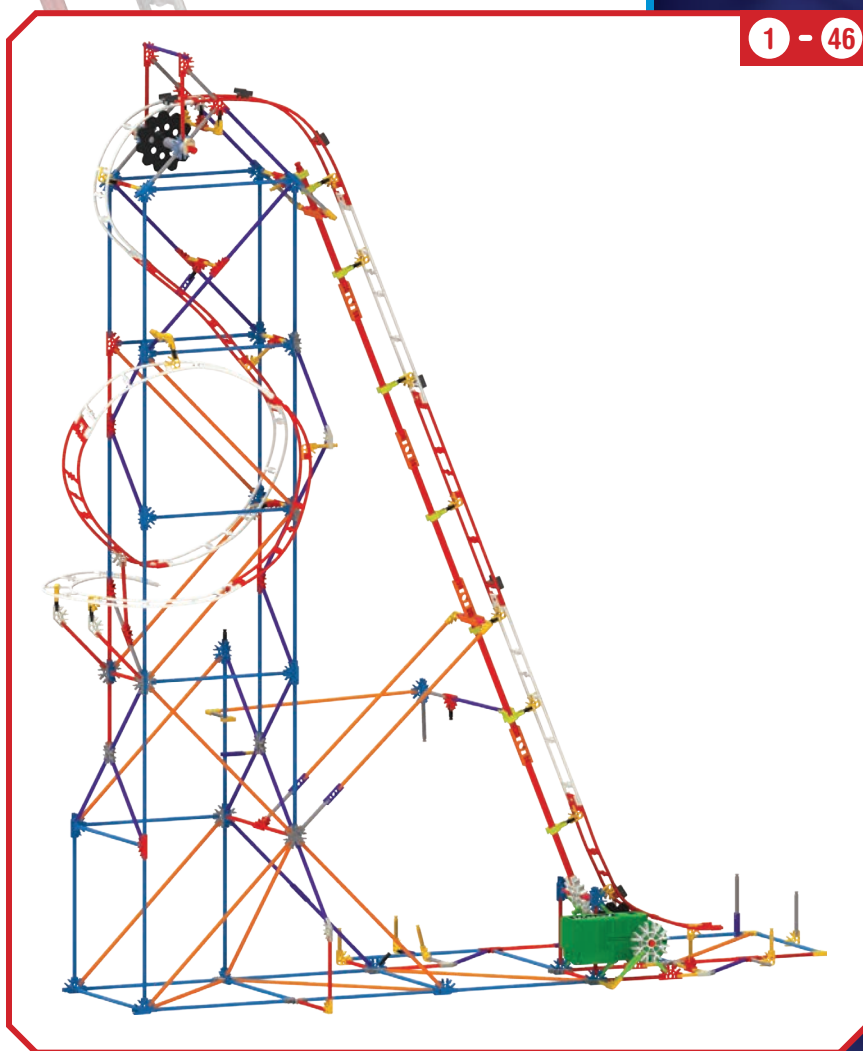

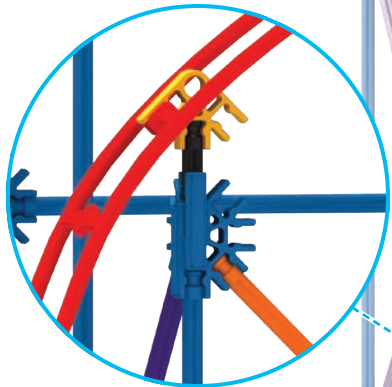
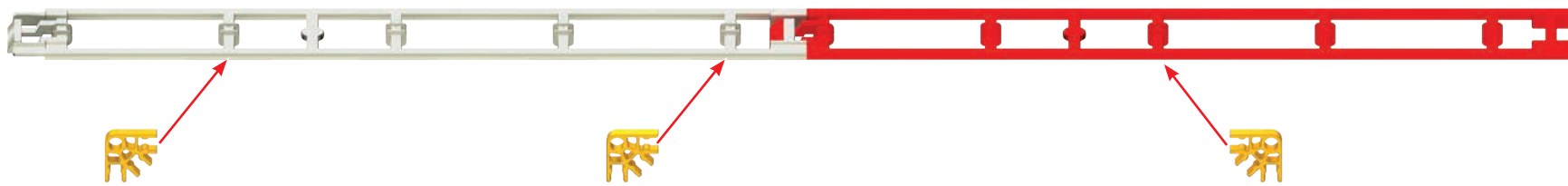

48

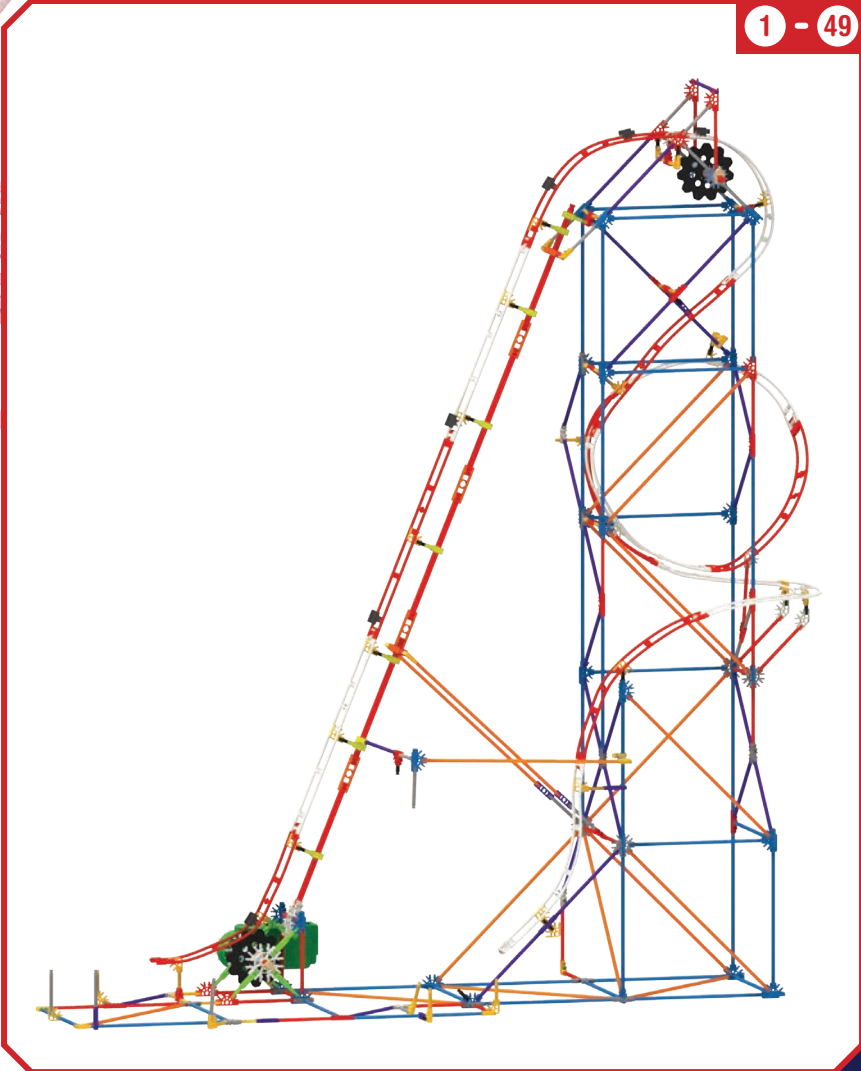

49  
1  1

49

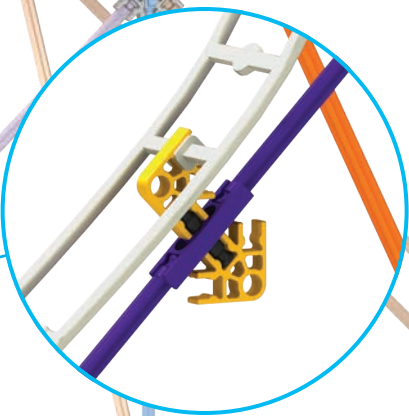

50

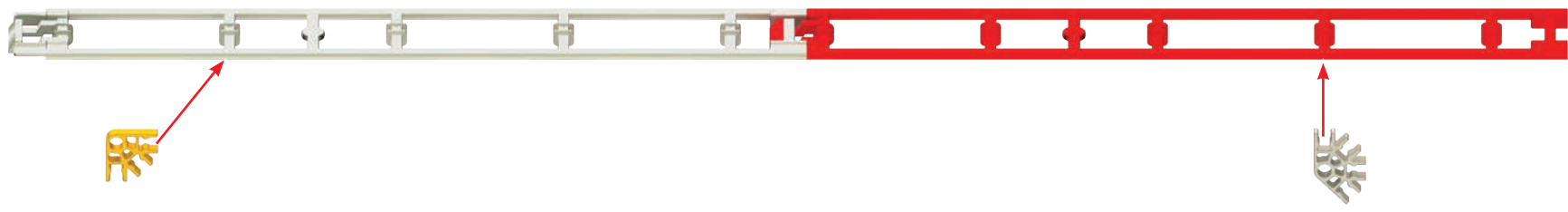

1 - 51

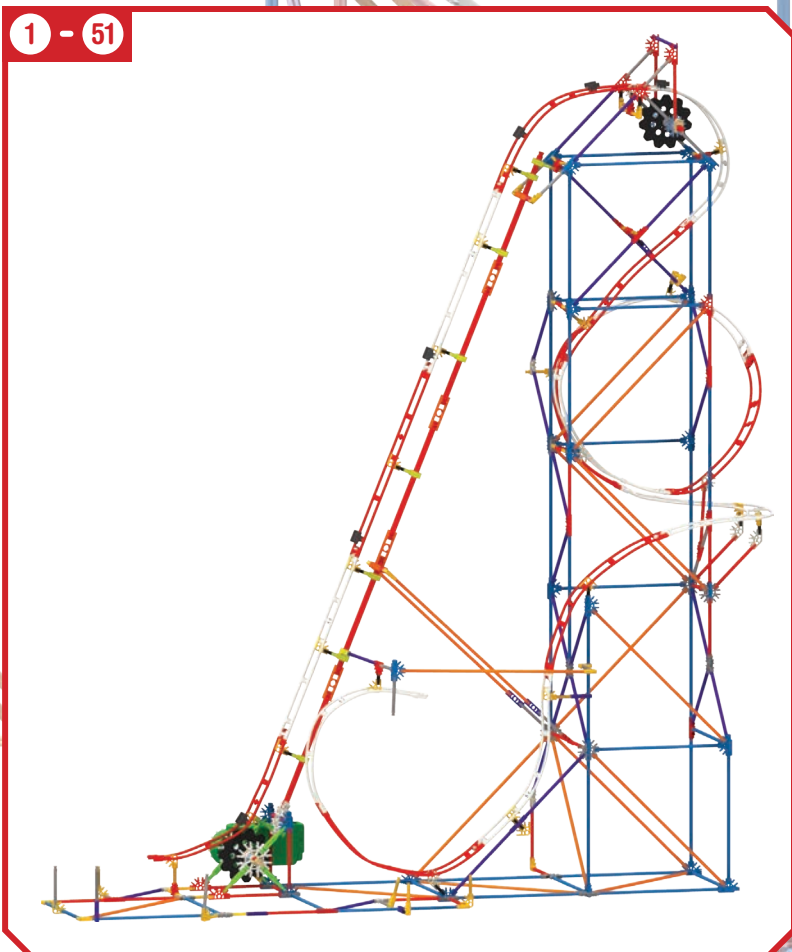

51

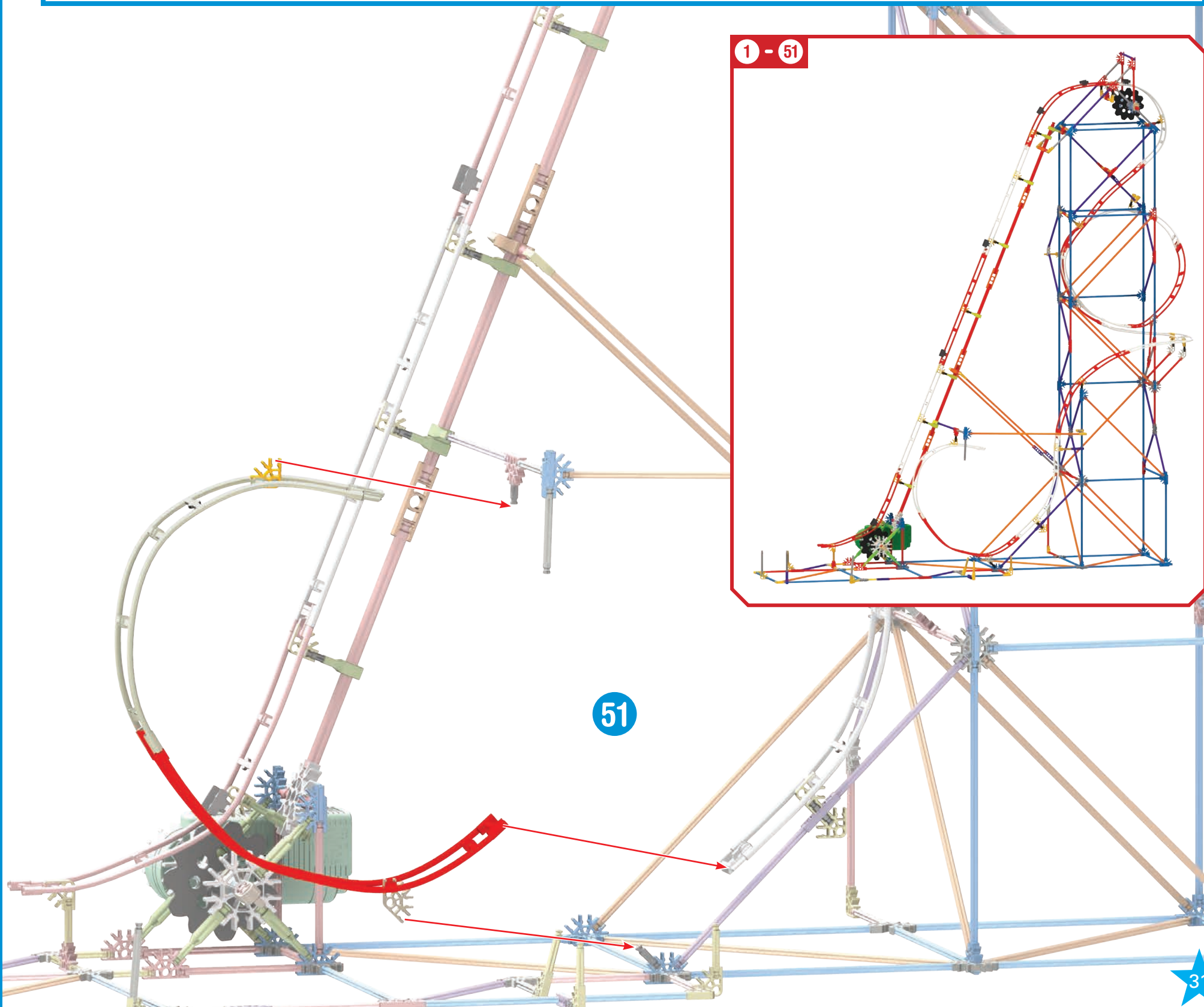

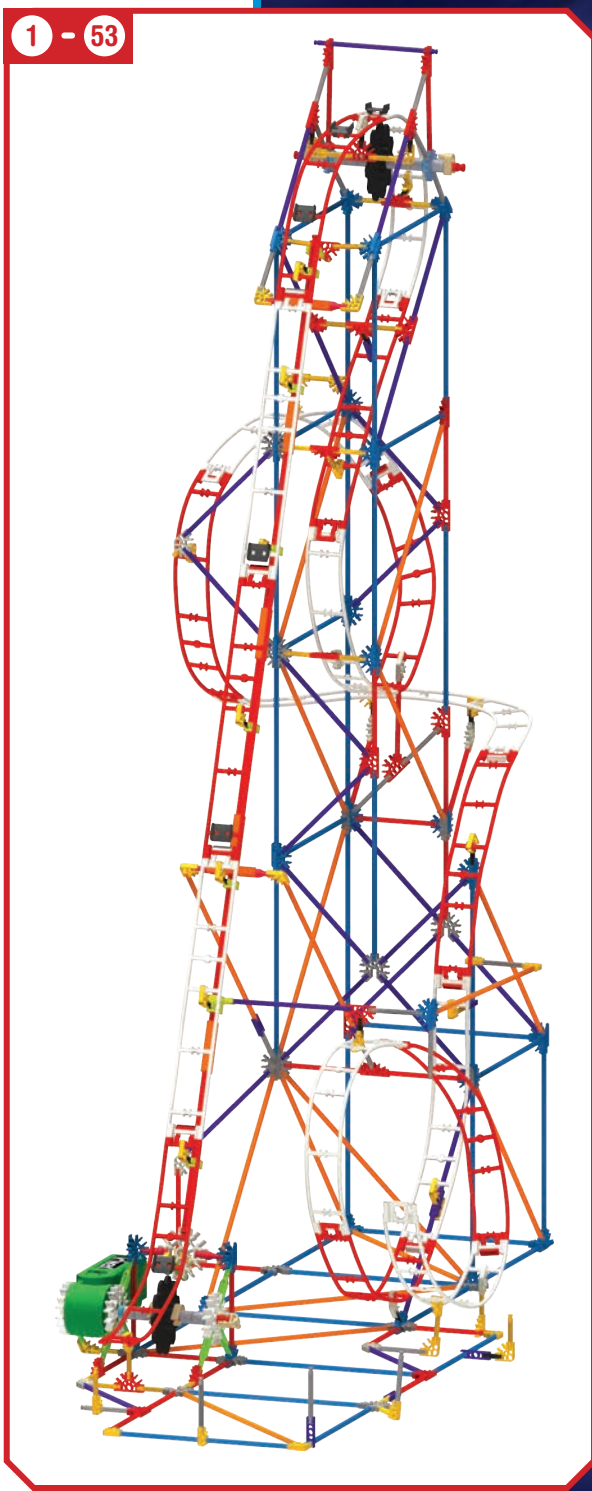
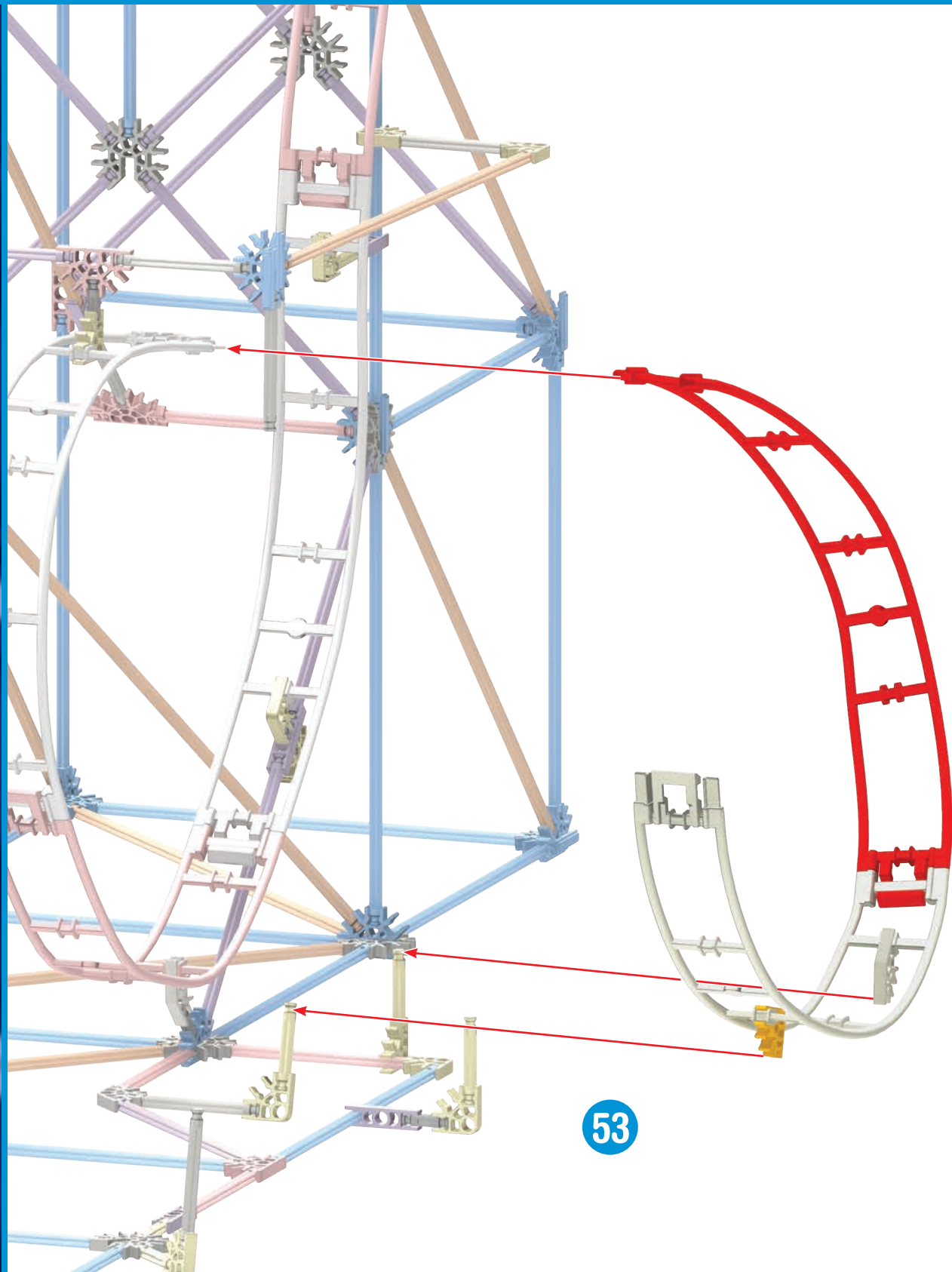
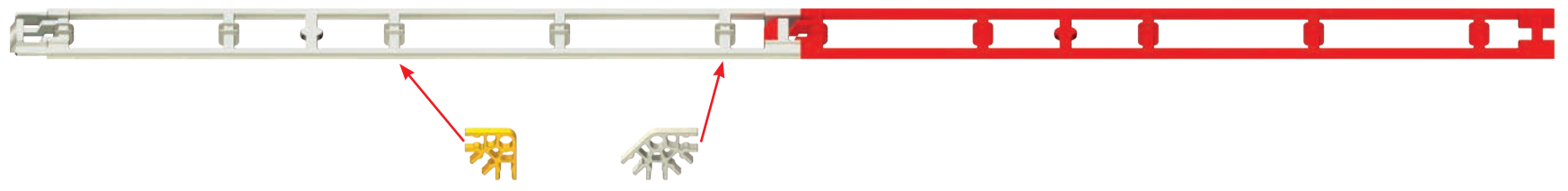



54



54

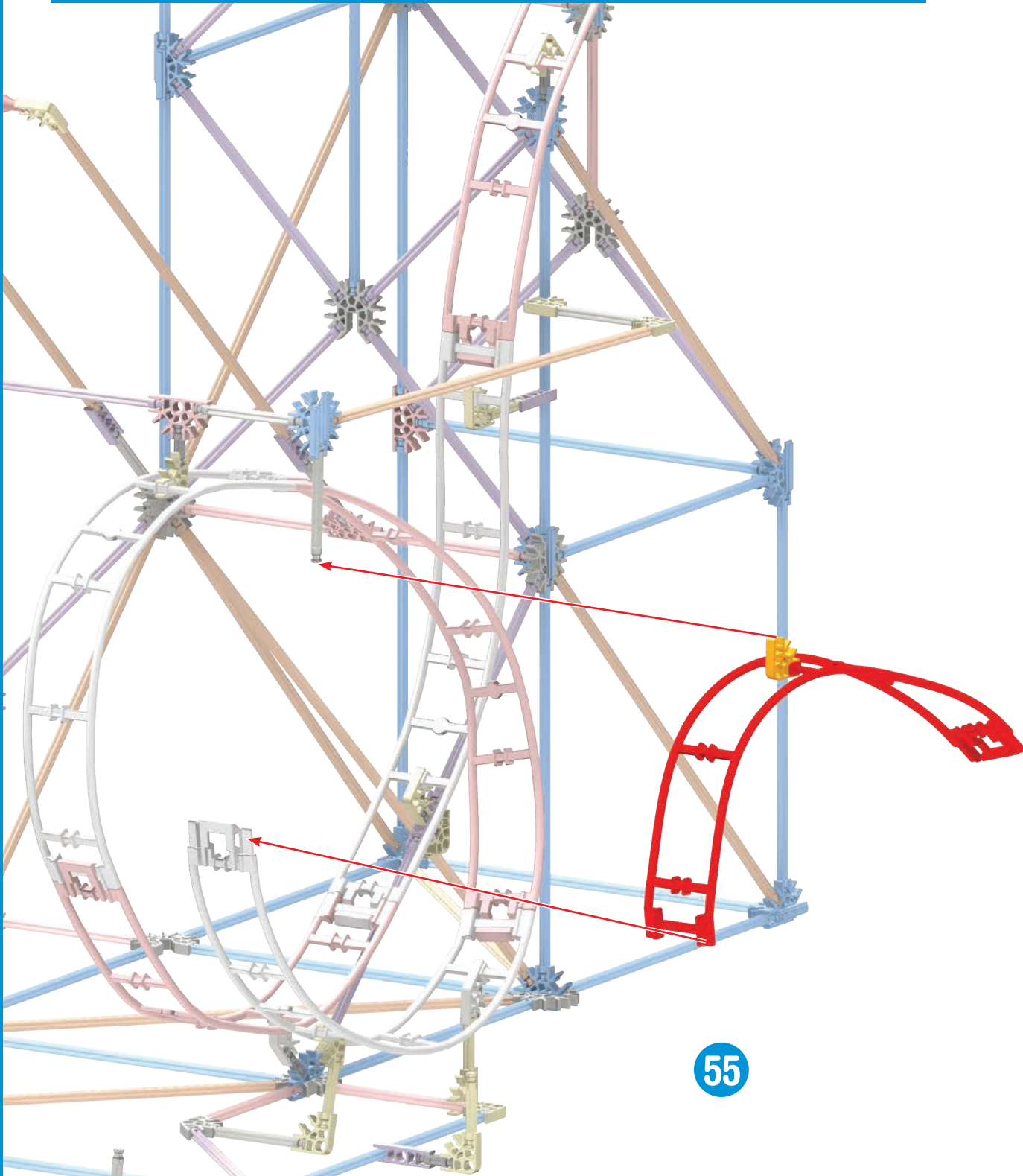

55

1 - 55

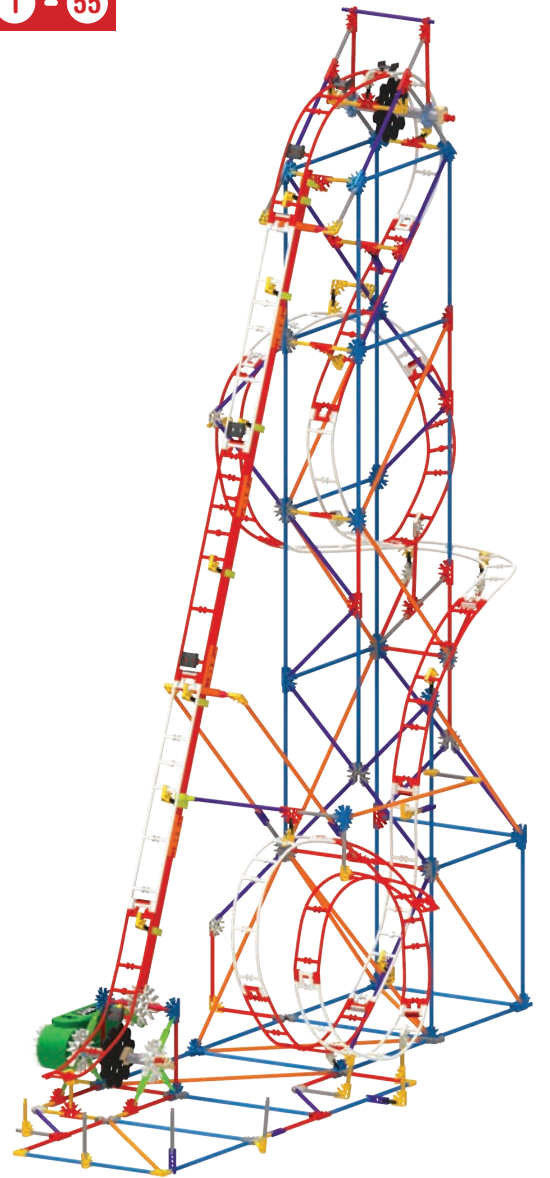

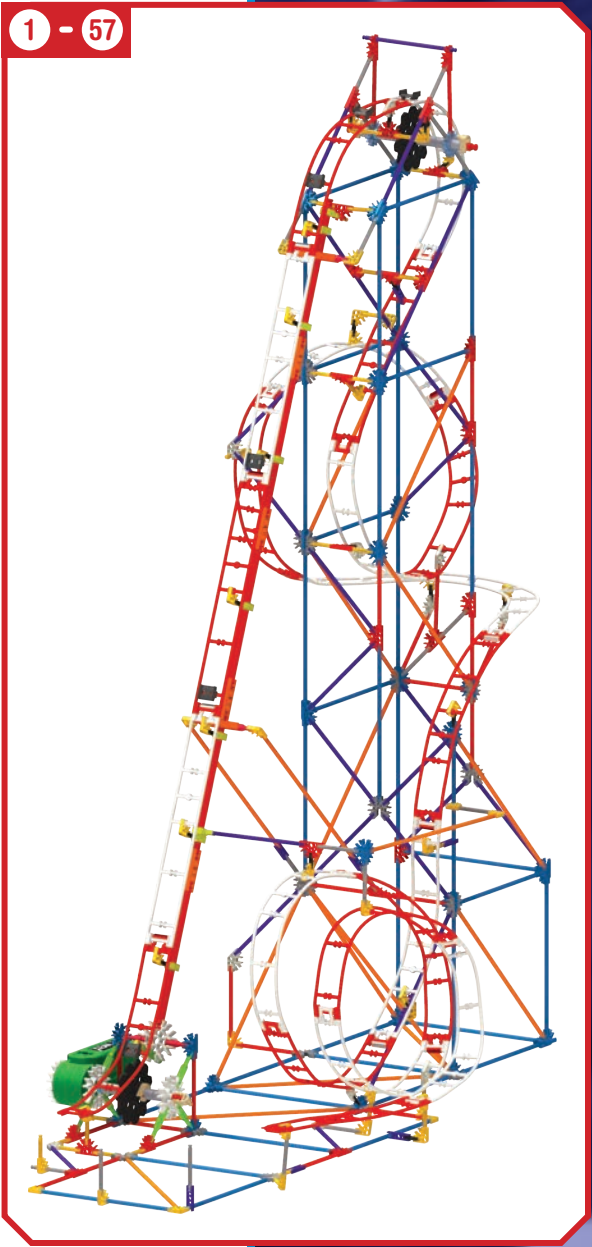
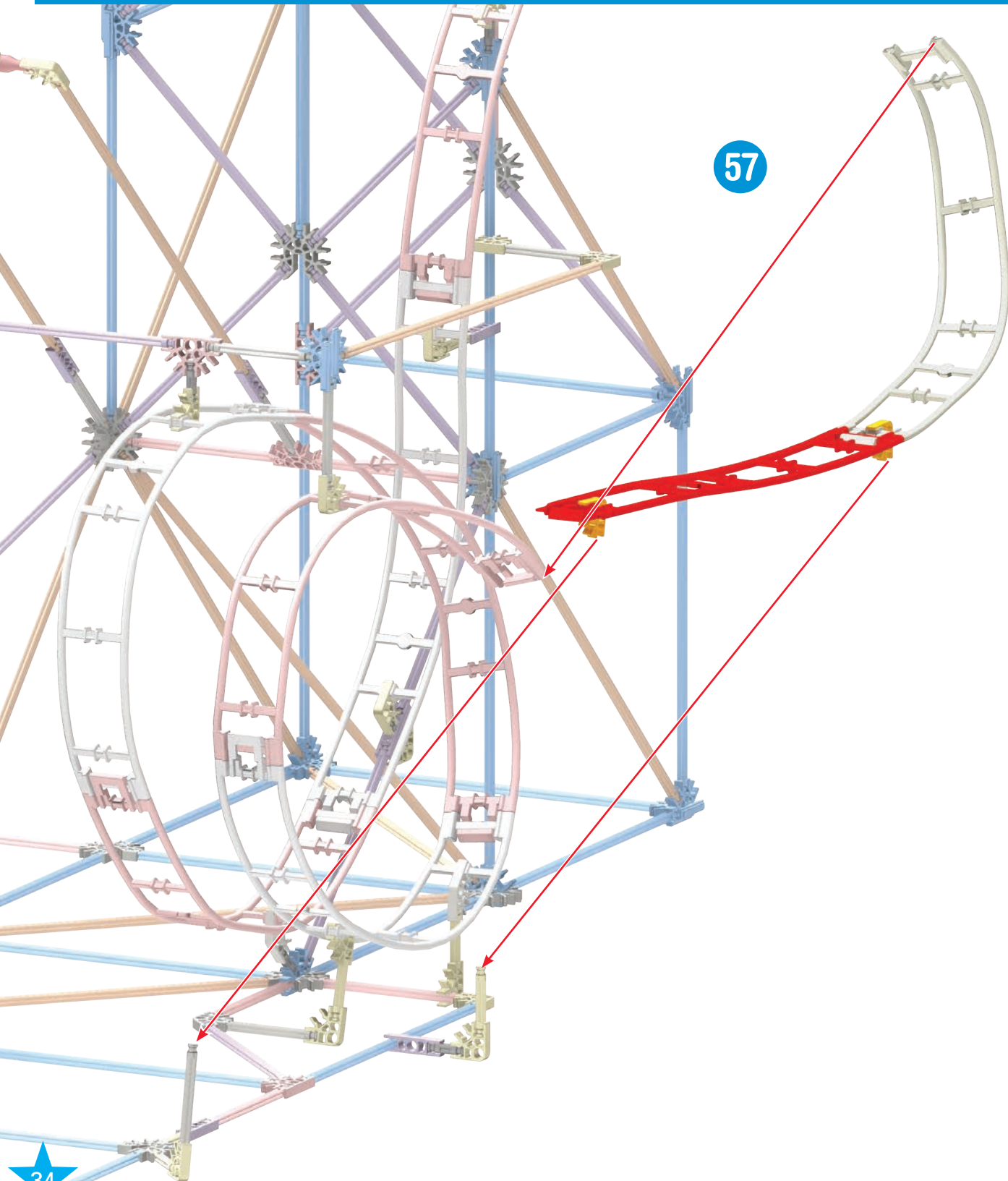
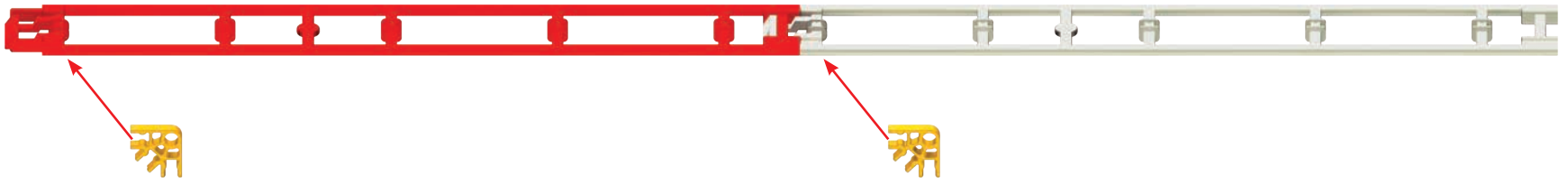

58



59

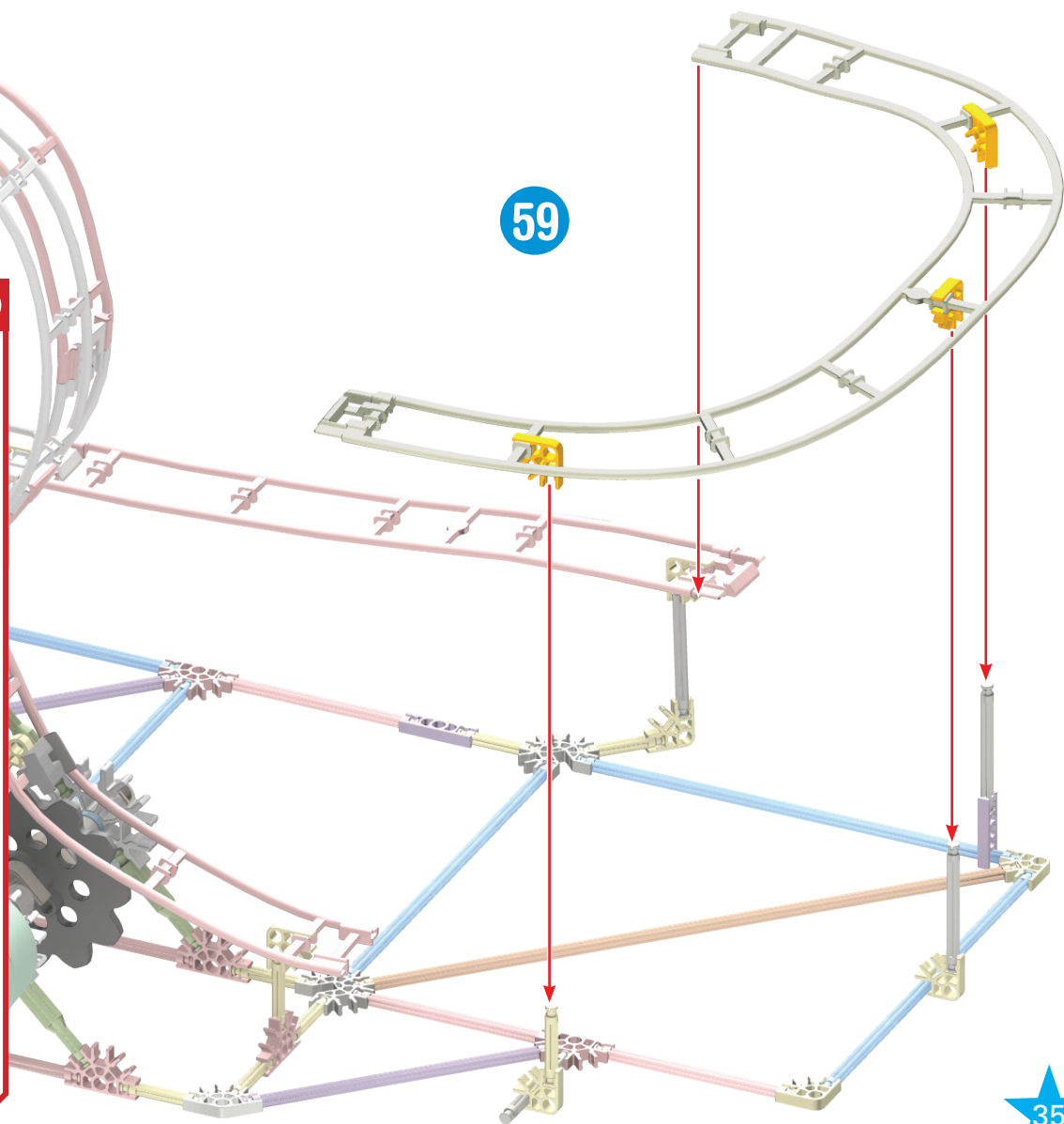

1 - 59

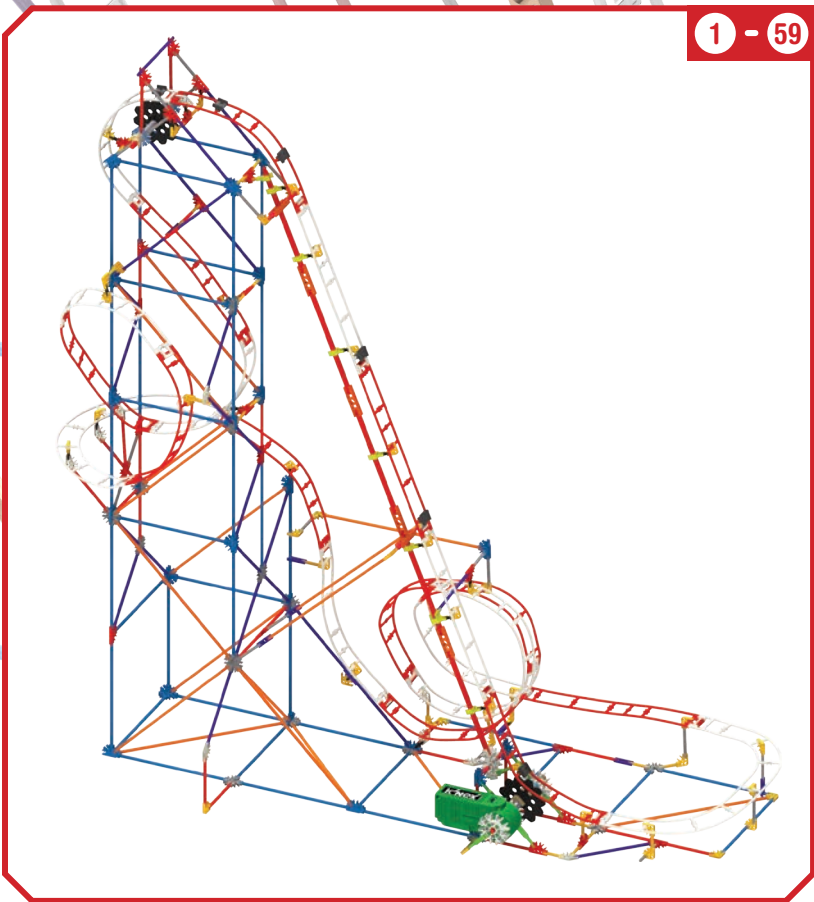



**IMPORTANT:** Attach all the chain links in the same direction.



**x10**

**60**



**x14**

**61**

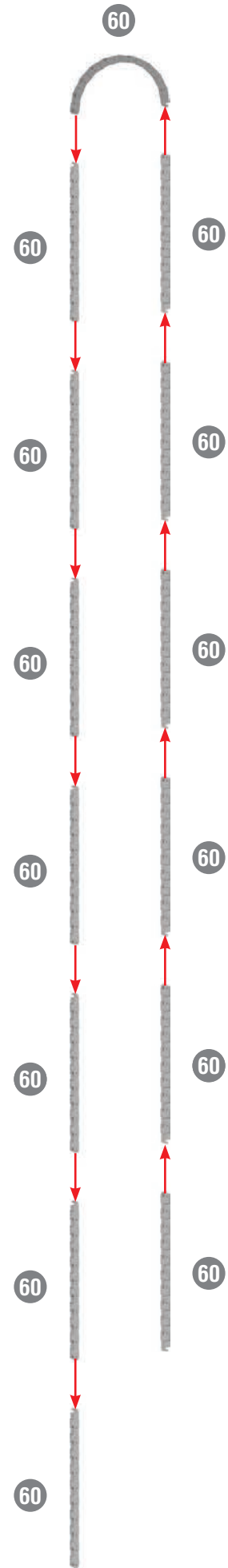

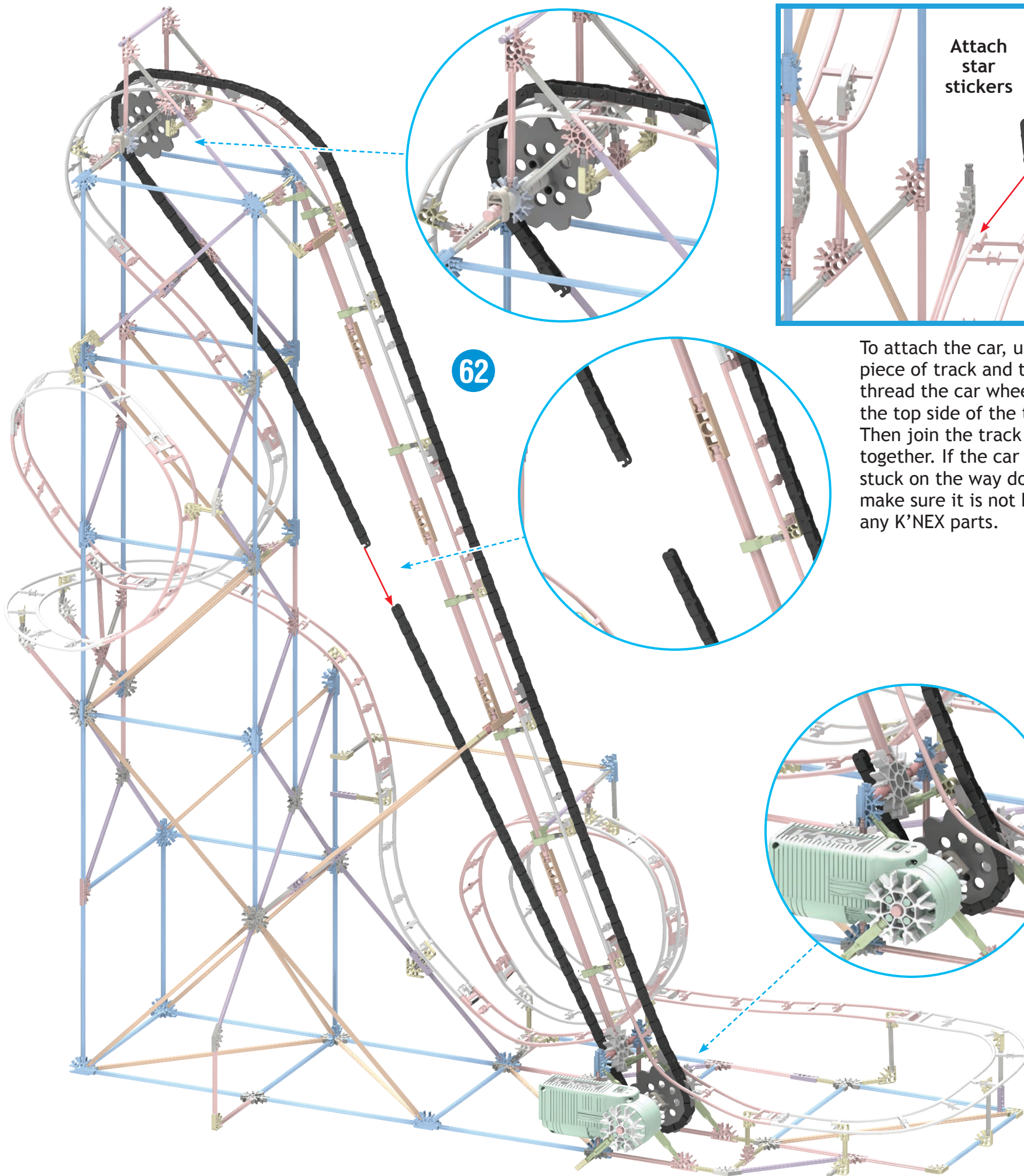

62

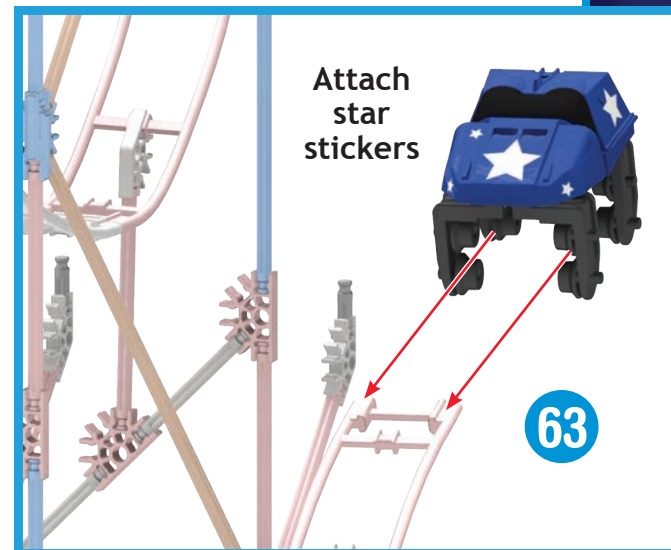
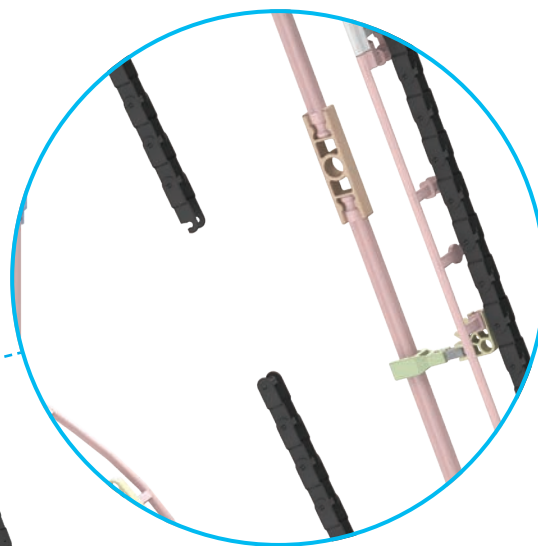

Attach  
star  
stickers

63

To attach the car, undo a piece of track and then thread the car wheels over the top side of the track. Then join the track pieces together. If the car gets stuck on the way down, make sure it is not hitting any K'NEX parts.

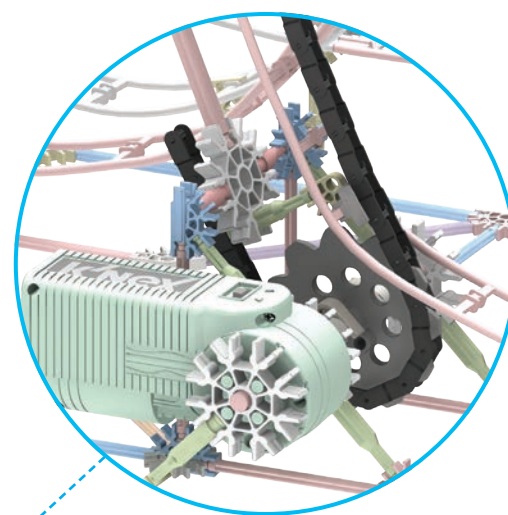

# ALL-AMERICAN ROLLER COASTER

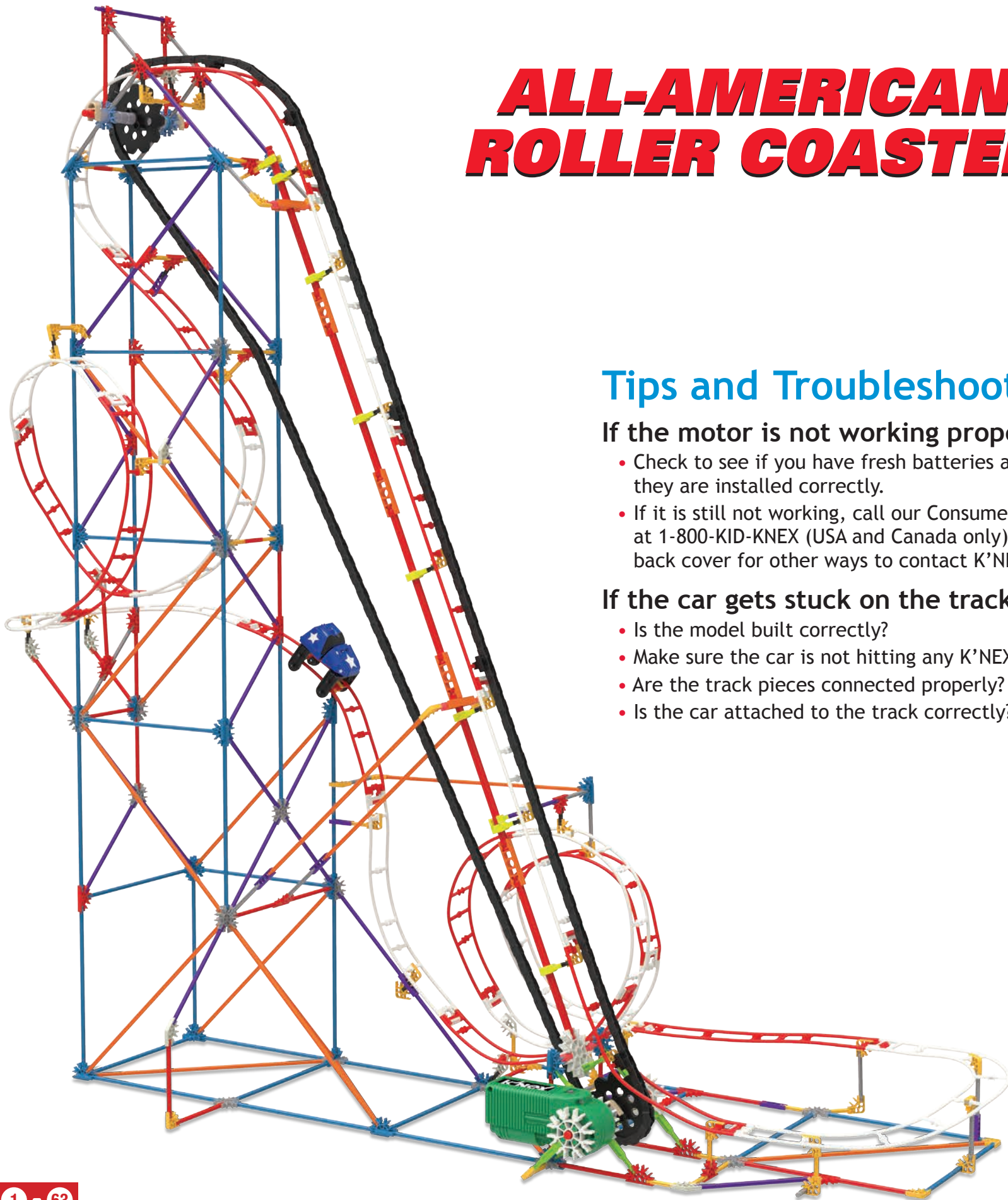

## Tips and Troubleshooting

### If the motor is not working properly:

- Check to see if you have fresh batteries and that they are installed correctly.
- If it is still not working, call our Consumer Hotline at 1-800-KID-KNEX (USA and Canada only). See the back cover for other ways to contact K'NEX.

### If the car gets stuck on the track:

- Is the model built correctly?
- Make sure the car is not hitting any K'NEX parts.
- Are the track pieces connected properly?
- Is the car attached to the track correctly?

# ***FREEDOM ROLLER COASTER***

Bonus instructions at [www.knex.com/thrill-rides](http://www.knex.com/thrill-rides)



# KNEX.COM

## ALL-AMERICAN ROLLER COASTER BUILDING SET



**SUPERSONIC  
SWIRL  
BUILDING SET**



**STAR  
SHOOTER  
ROLLER  
COASTER  
BUILDING SET**

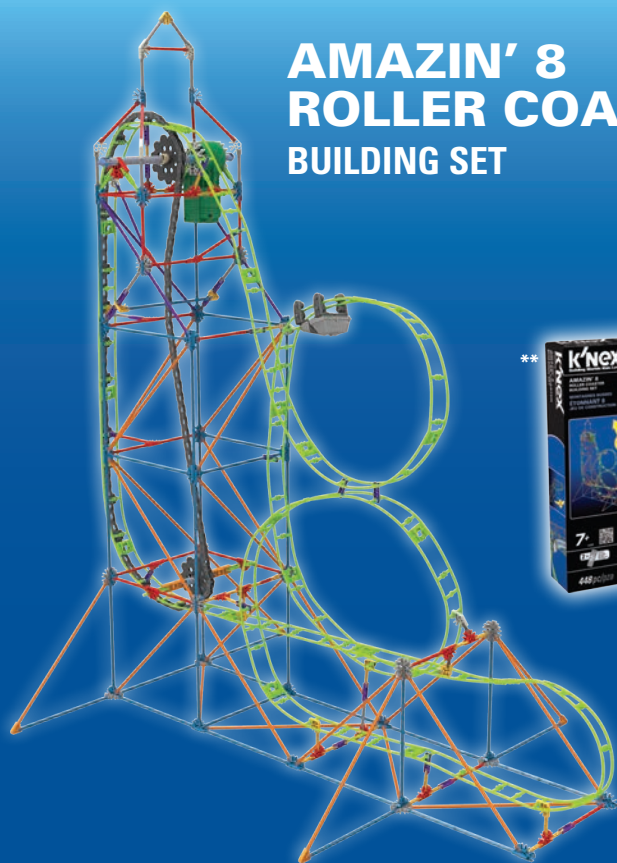

**AMAZIN' 8  
ROLLER COASTER  
BUILDING SET**



\*\* Sold separately. Some products may not be available in all markets.

**AMERICA'S  
Building Toy**

K'NEX, Building Worlds Kids Love and America's Building Toy are registered trademarks of K'NEX Limited Partnership Group.

Product & colors may vary. Most models can be built one at a time.

©2015 K'NEX Limited Partnership Group

P.O. Box 700, Hatfield, PA 19440-0700

1-800-KID-KNEX (USA/Canada)

email@knex.com www.knex.com

Customer outside the USA/Canada contact your local distributor at [www.knex.com/distributors](http://www.knex.com/distributors)

 [knex.com/knexpert](http://knex.com/knexpert) 

 [facebook.com/knex](https://facebook.com/knex)

155400-V1-04/15