

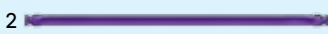



- 2 
- 6 
- 1     9     3 







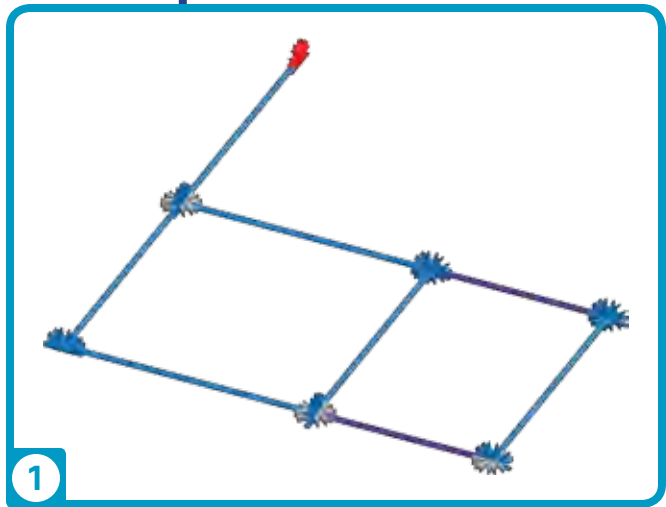
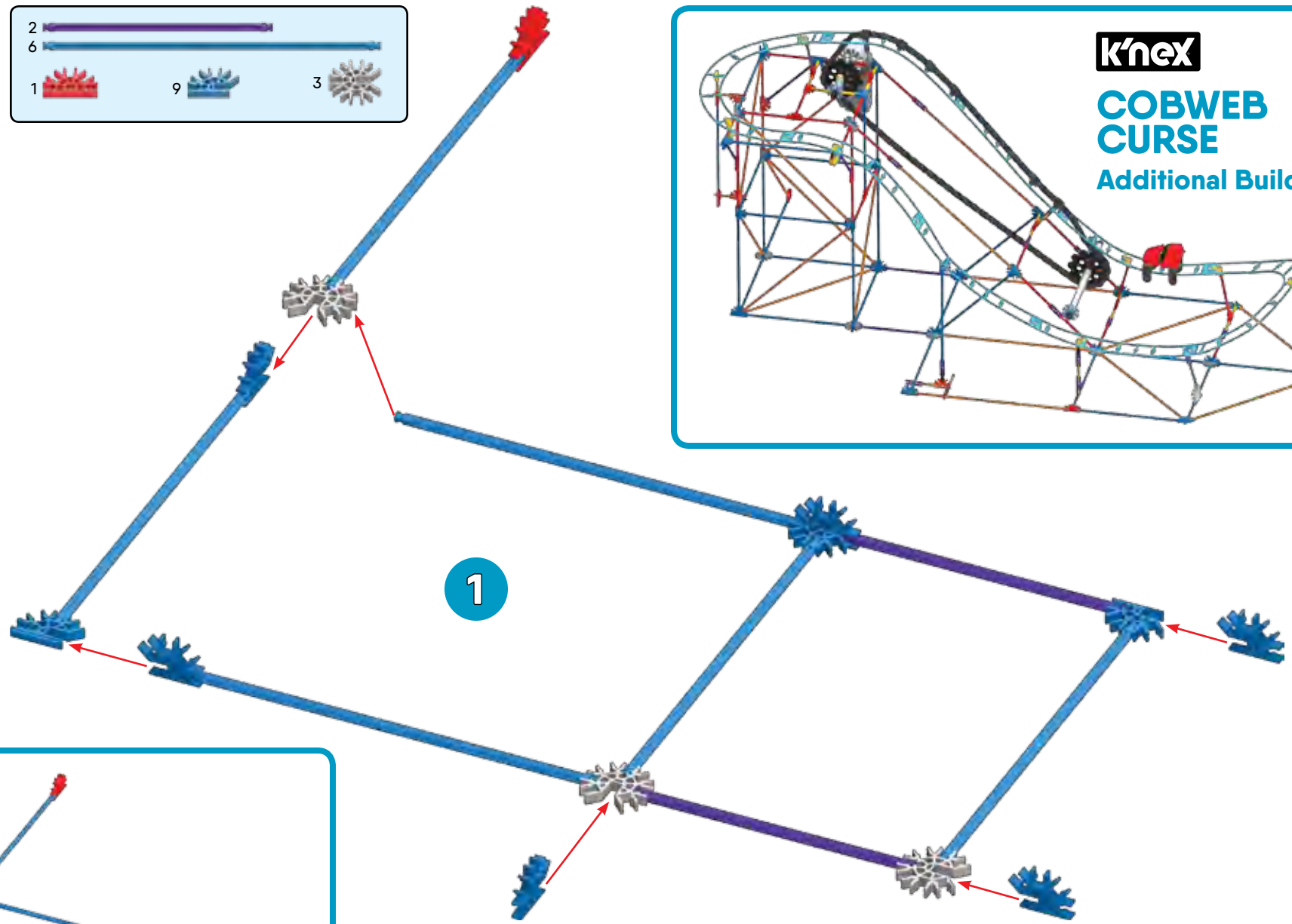
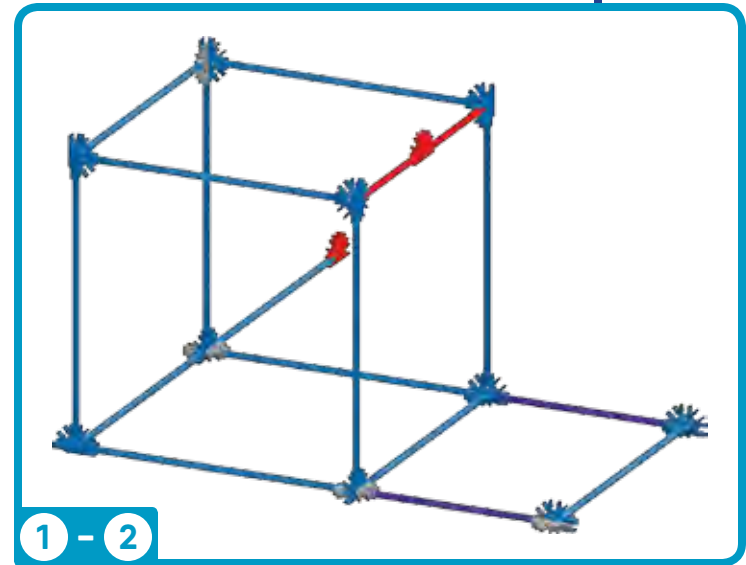
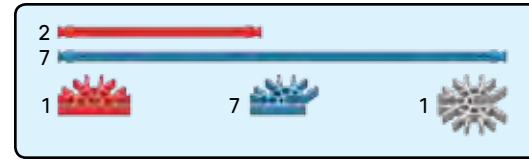
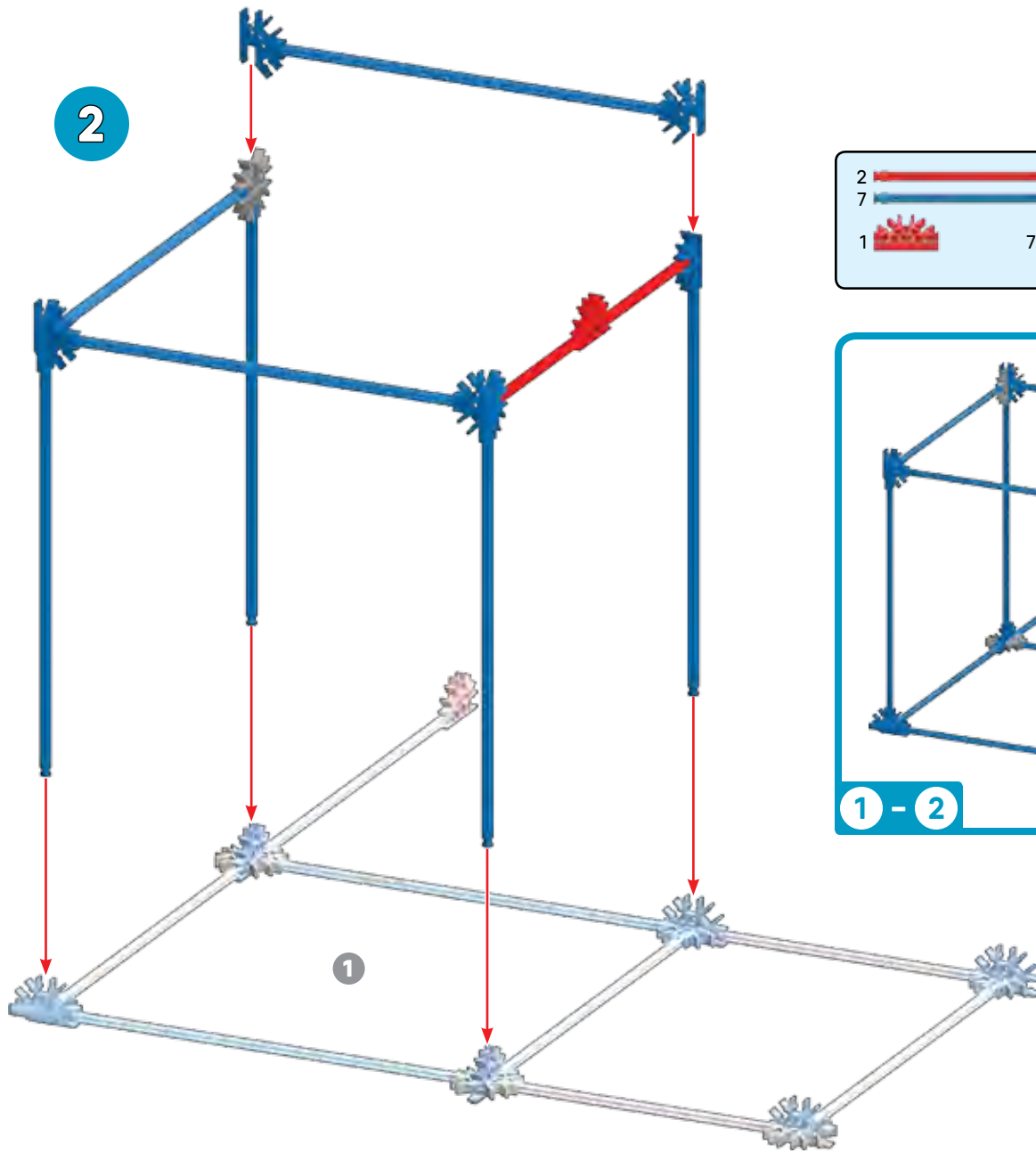
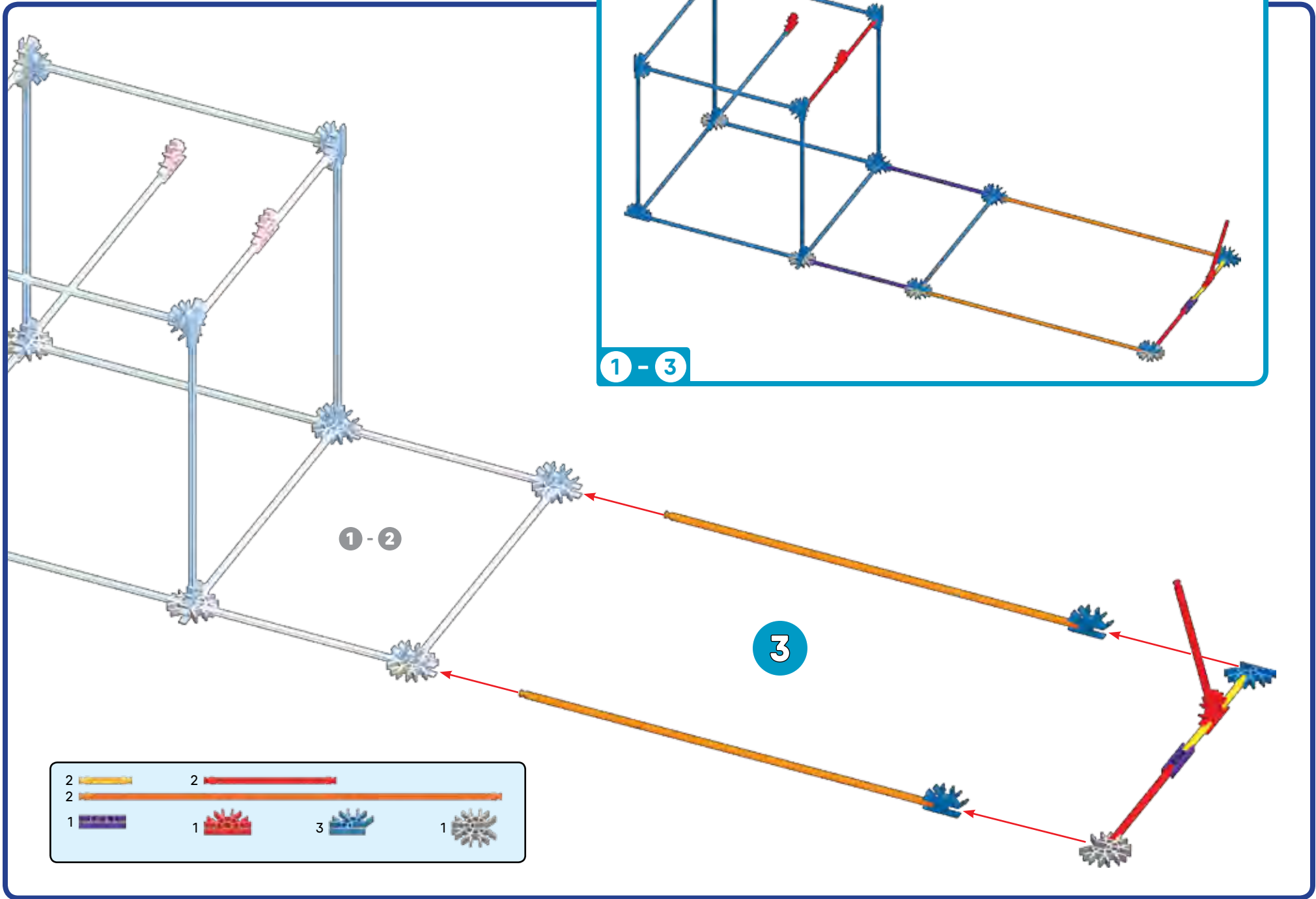
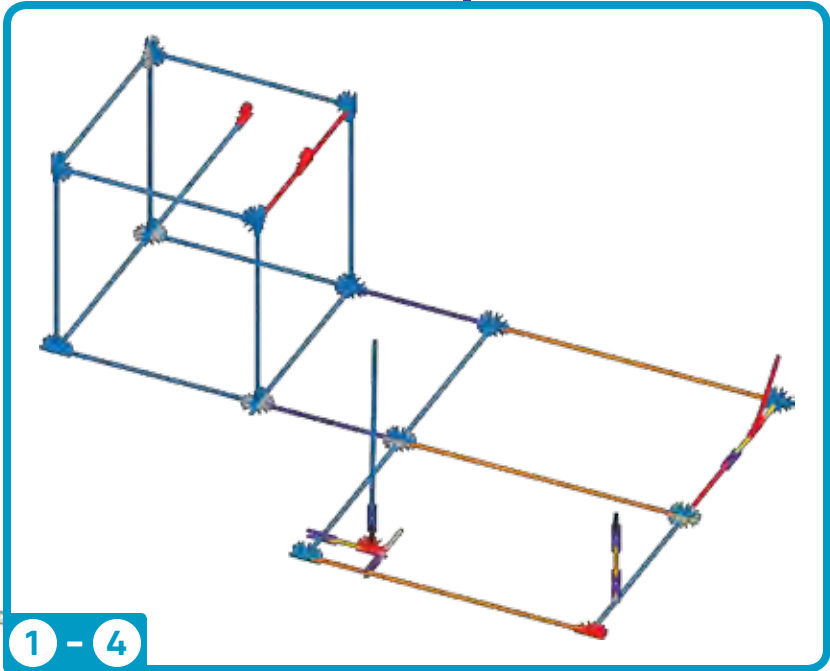
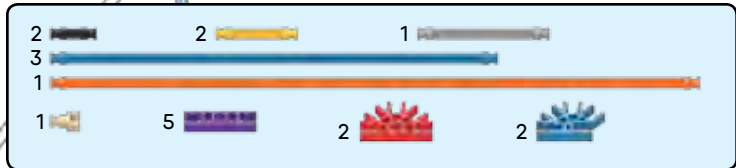

1 - 3

4

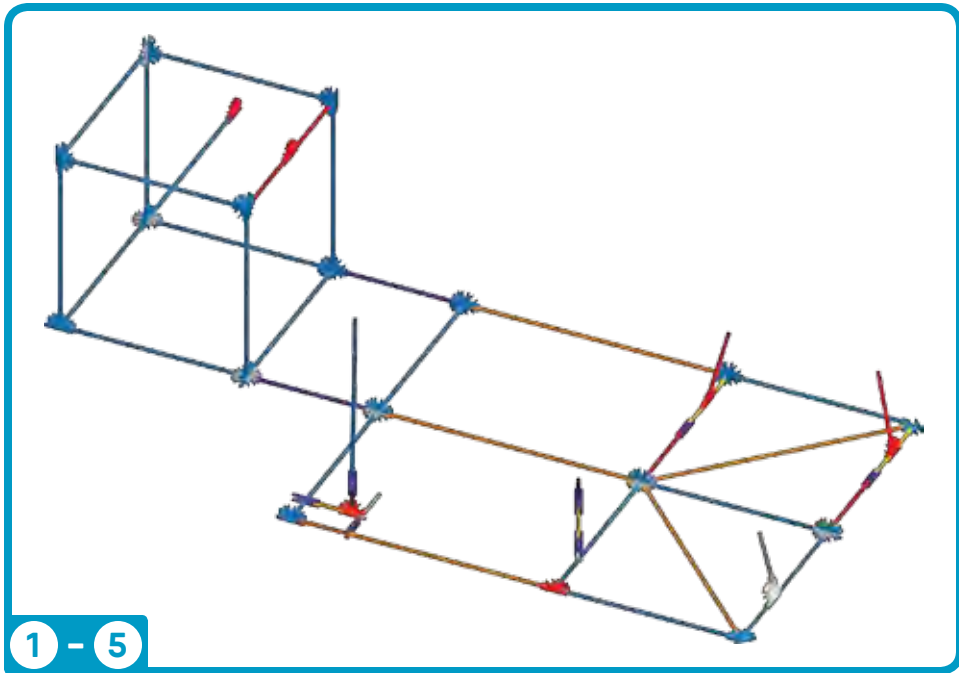

1 - 5

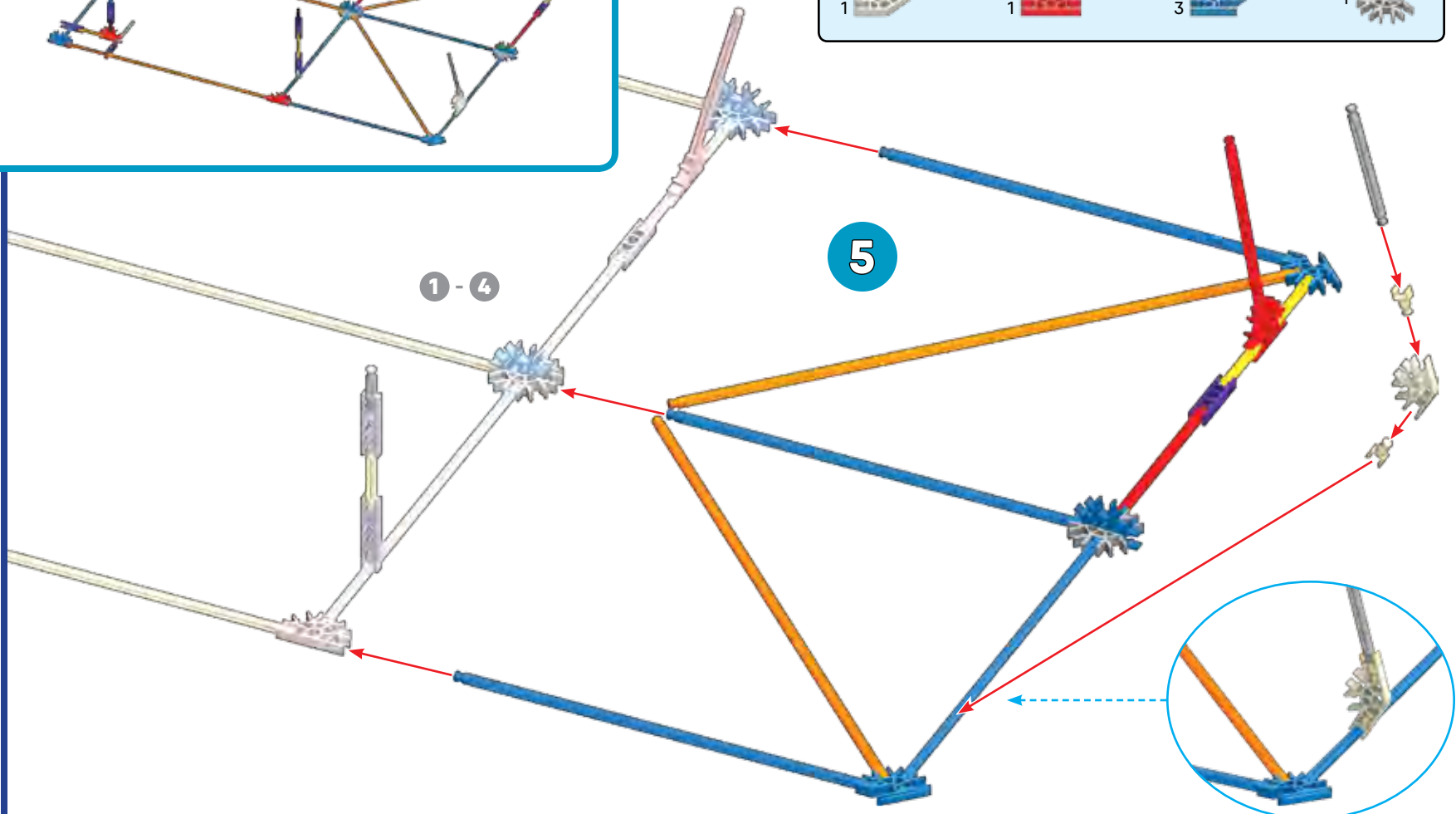
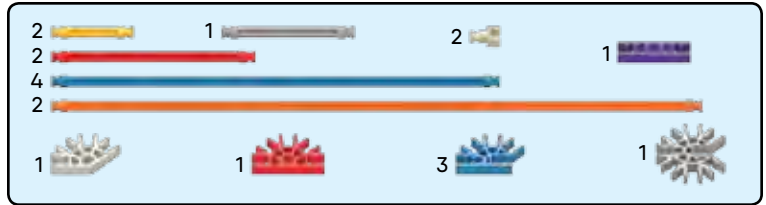

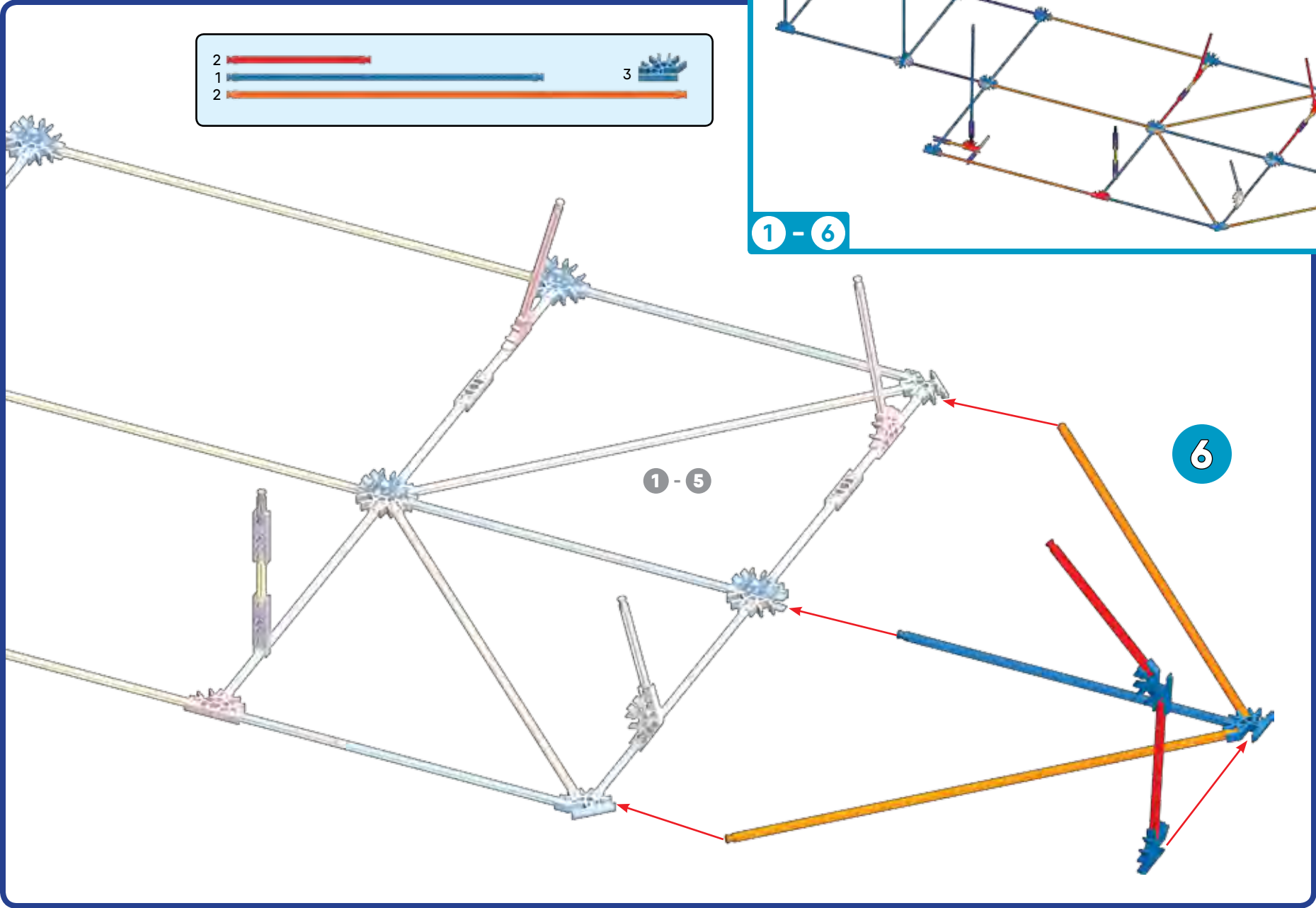
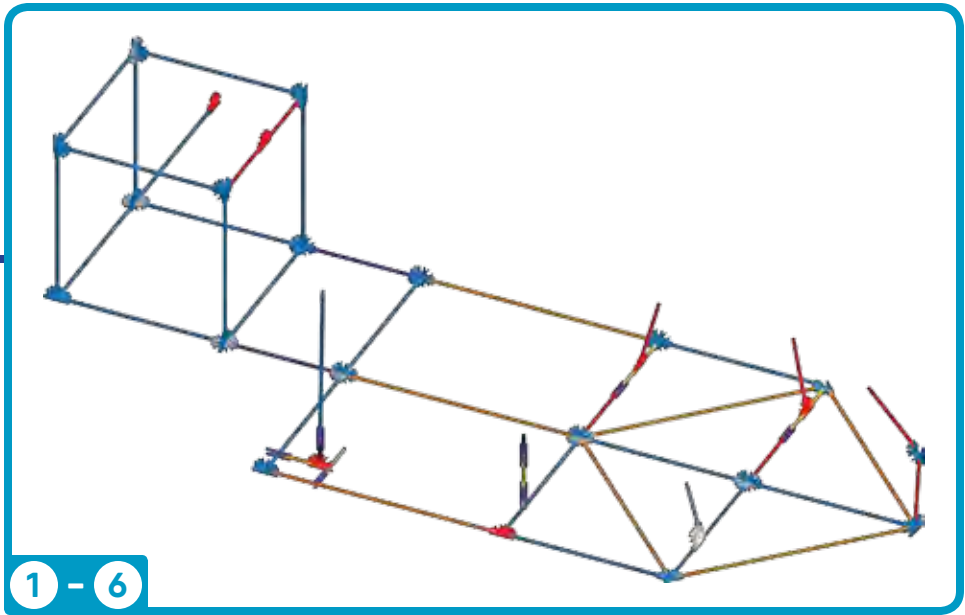
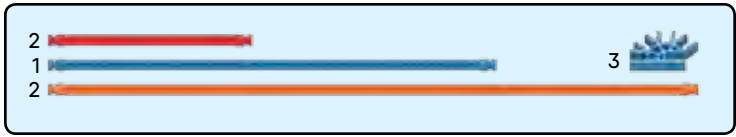



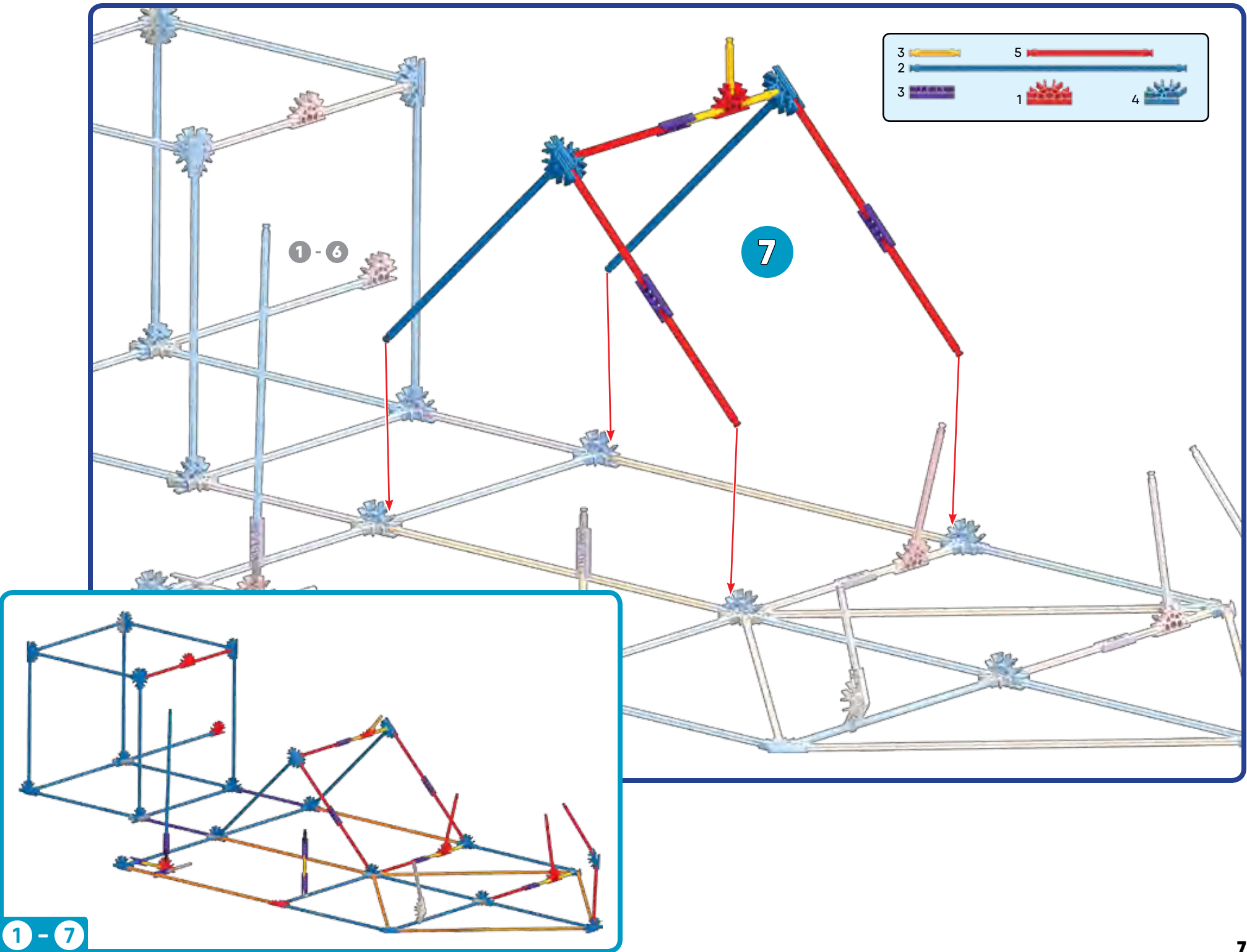

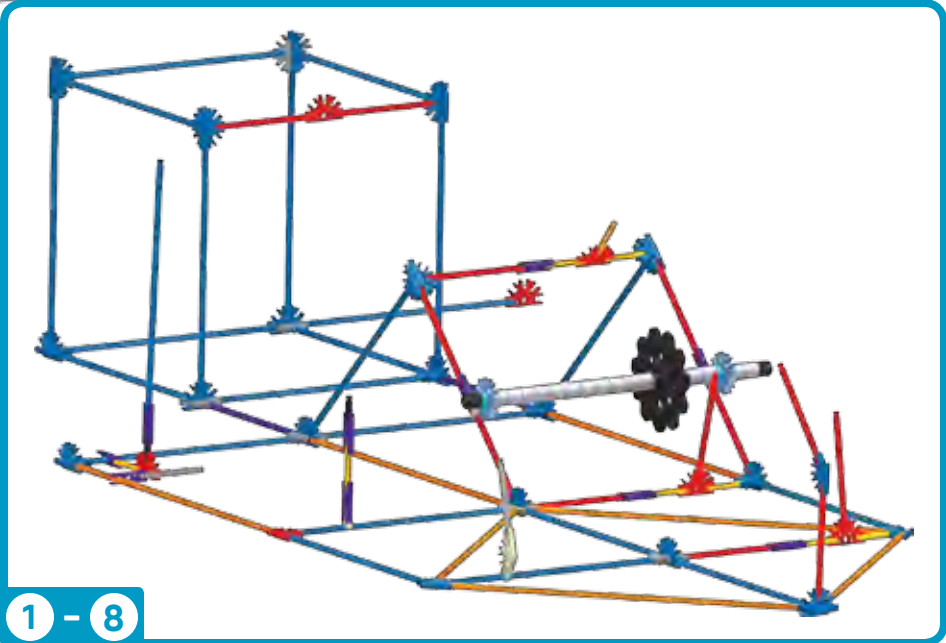
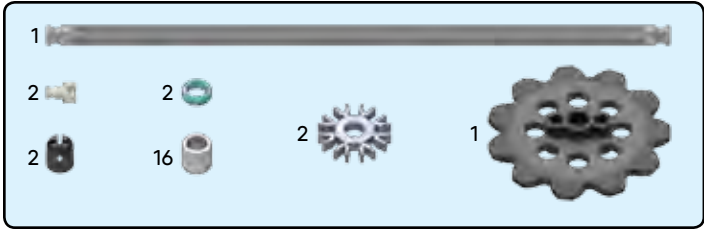
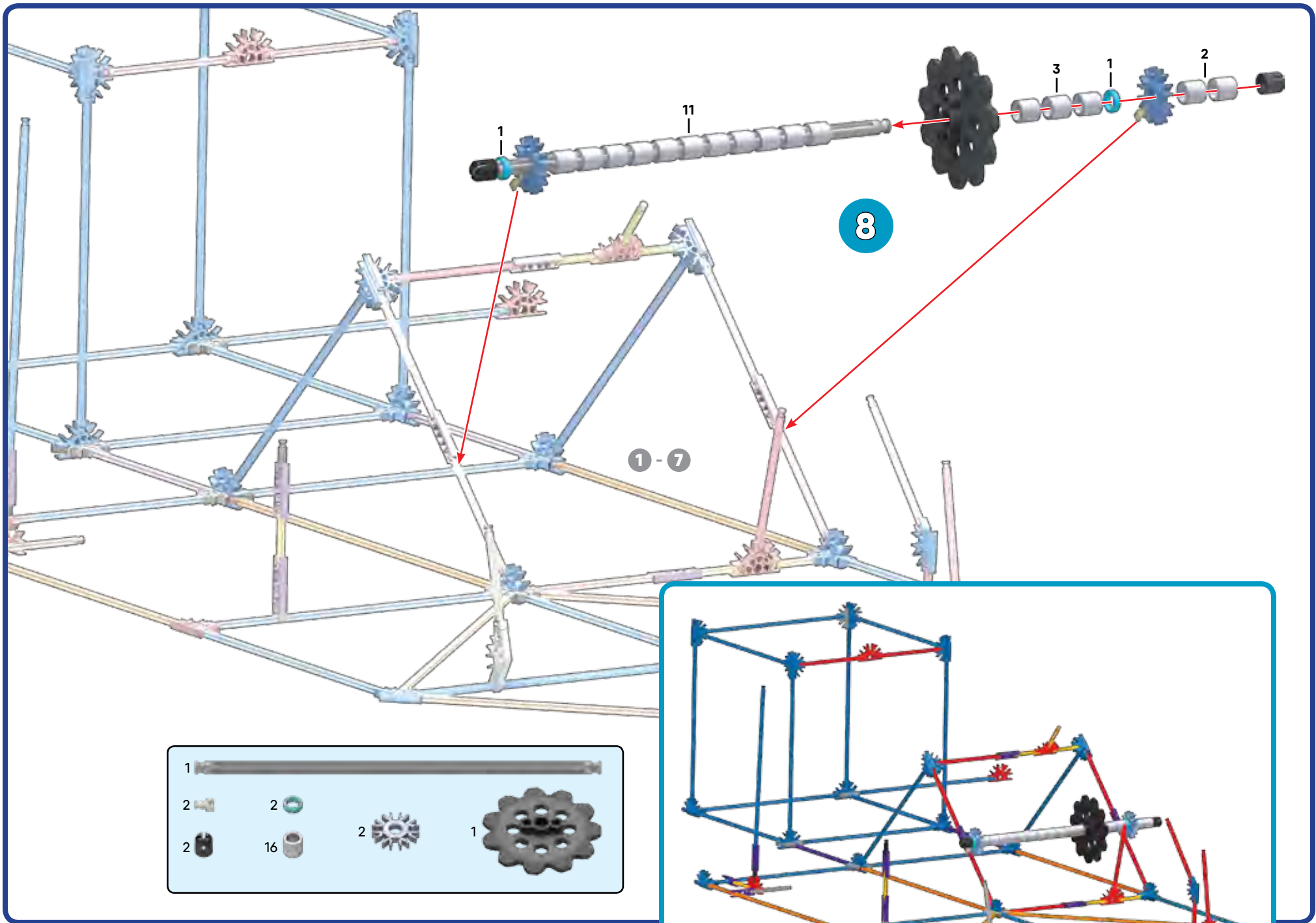



9

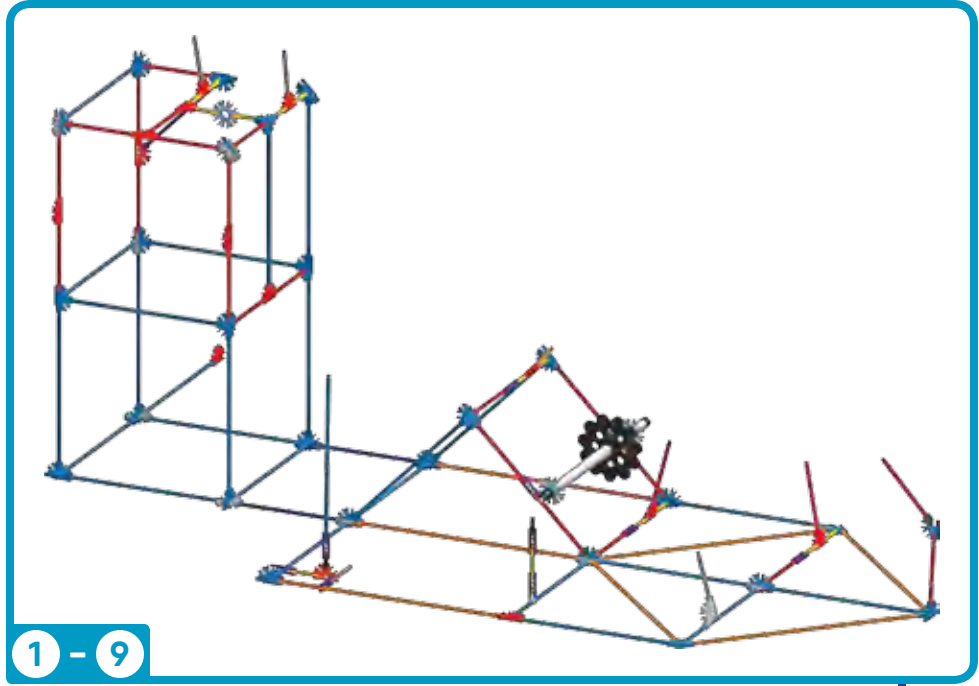
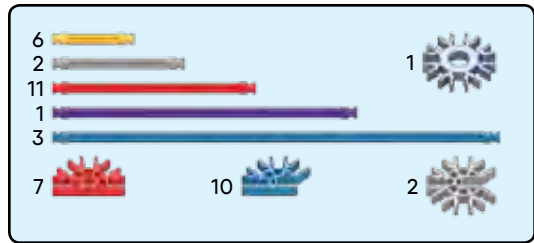
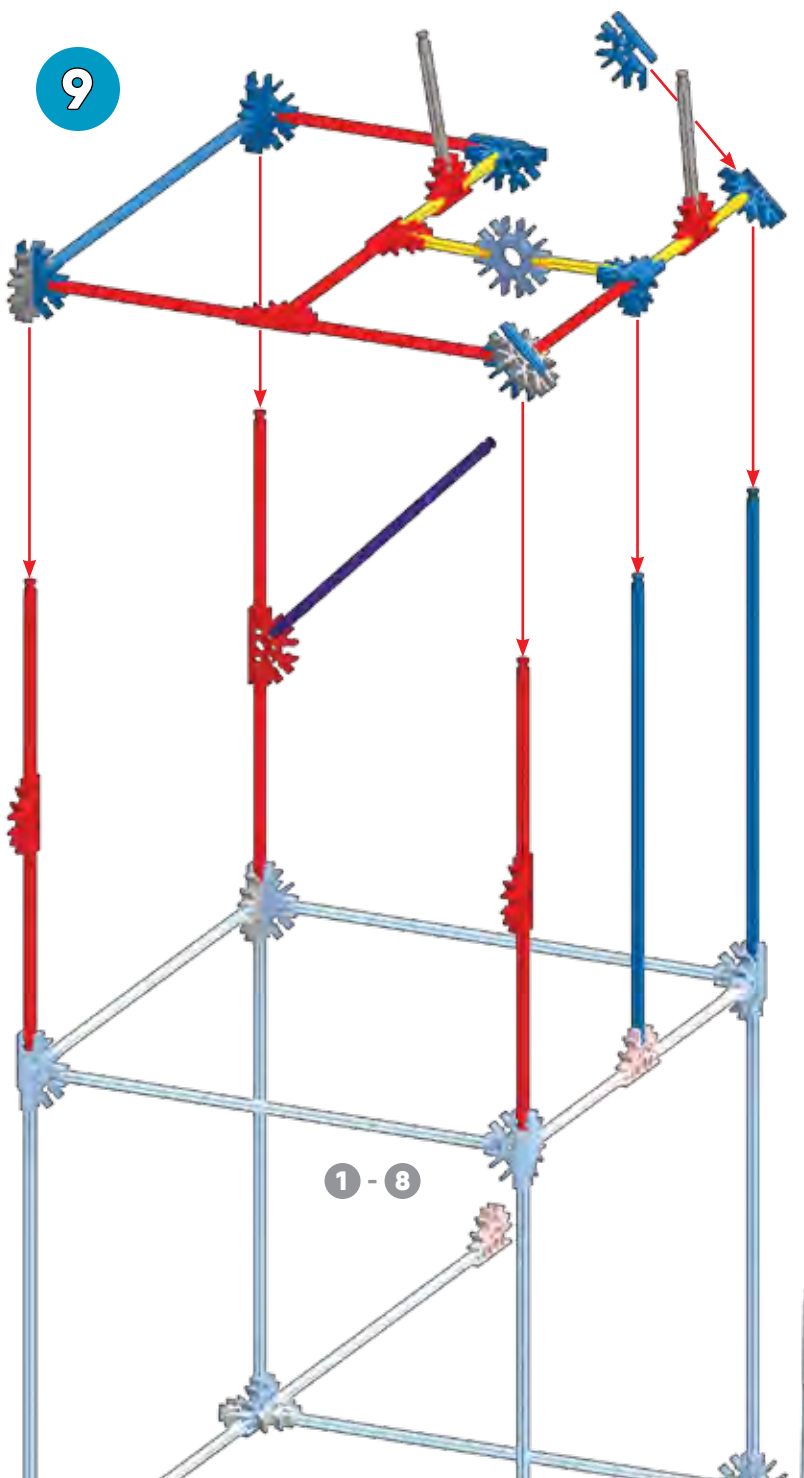

1 - 8

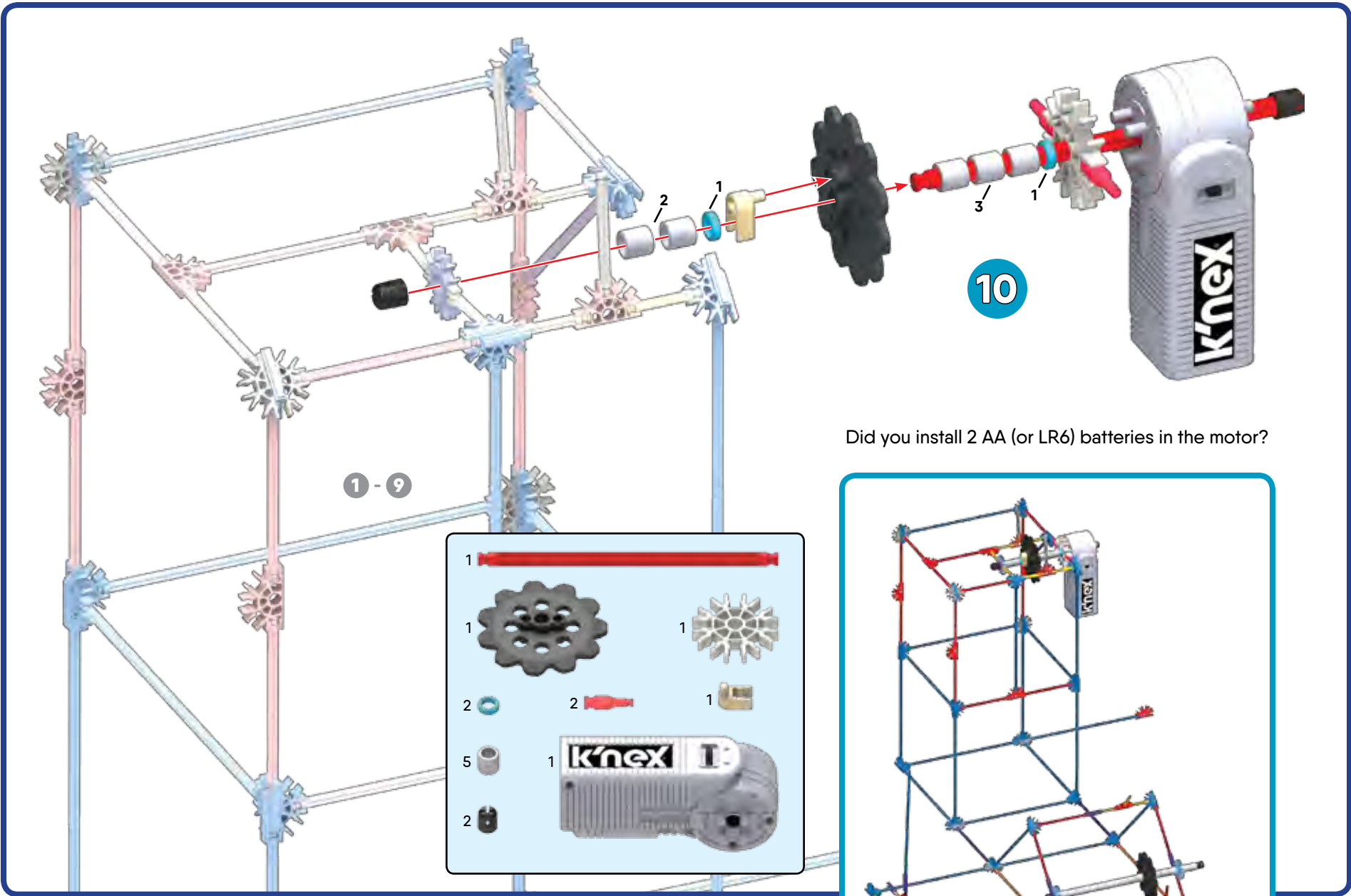

10

Did you install 2 AA (or LR6) batteries in the motor?

- 1
- 1
- 1
- 2
- 2
- 1
- 5
- 1
- 2

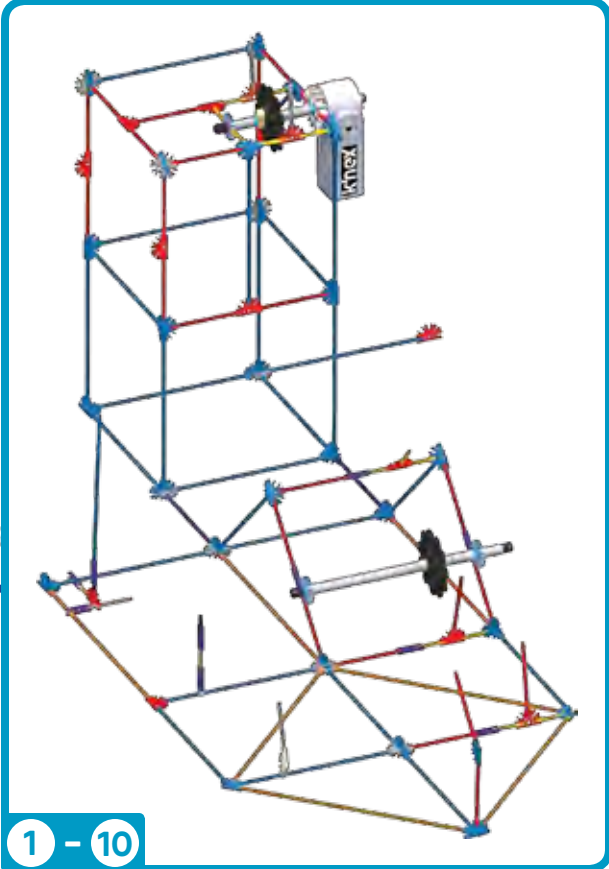

1 - 10

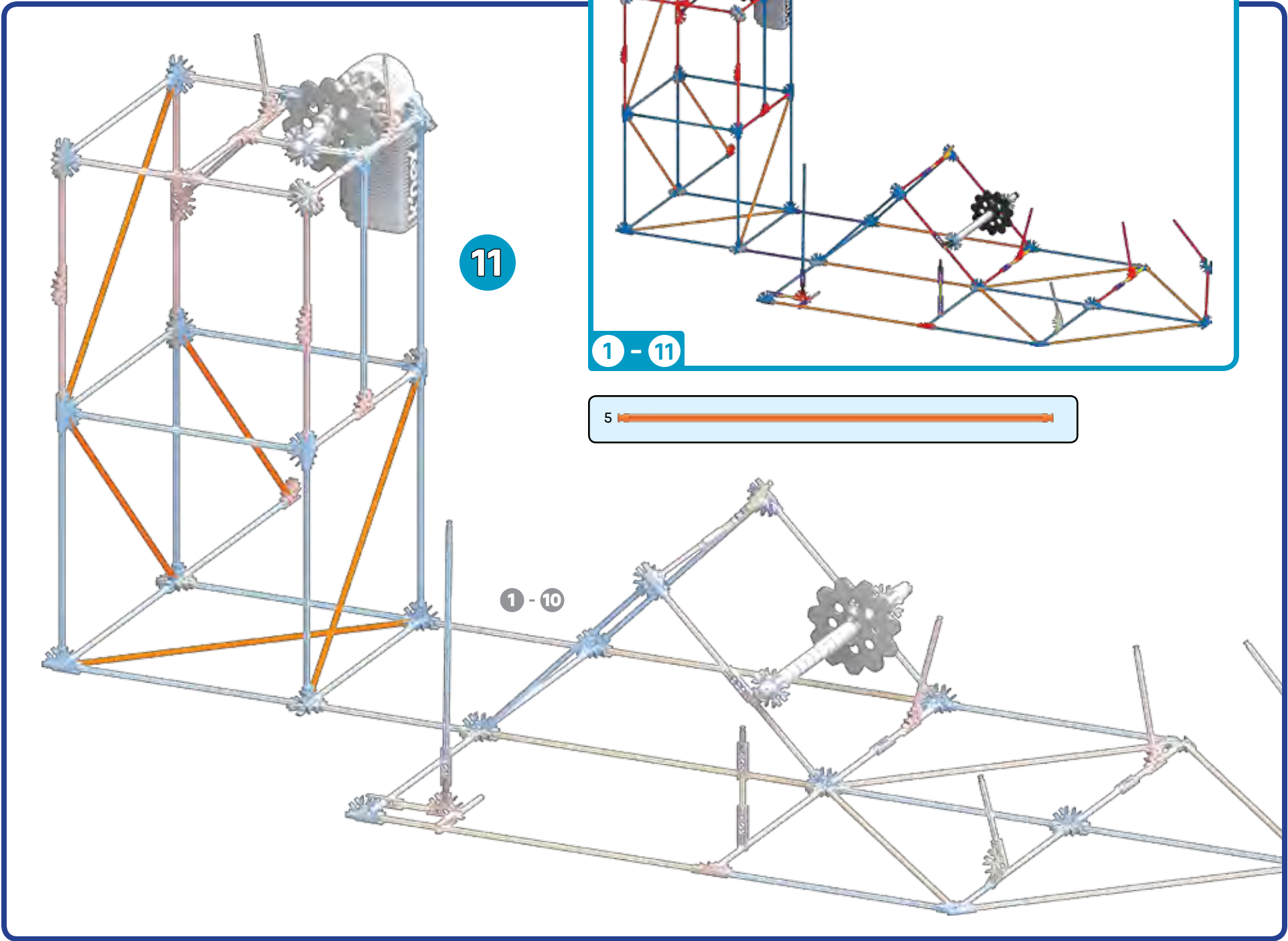

11

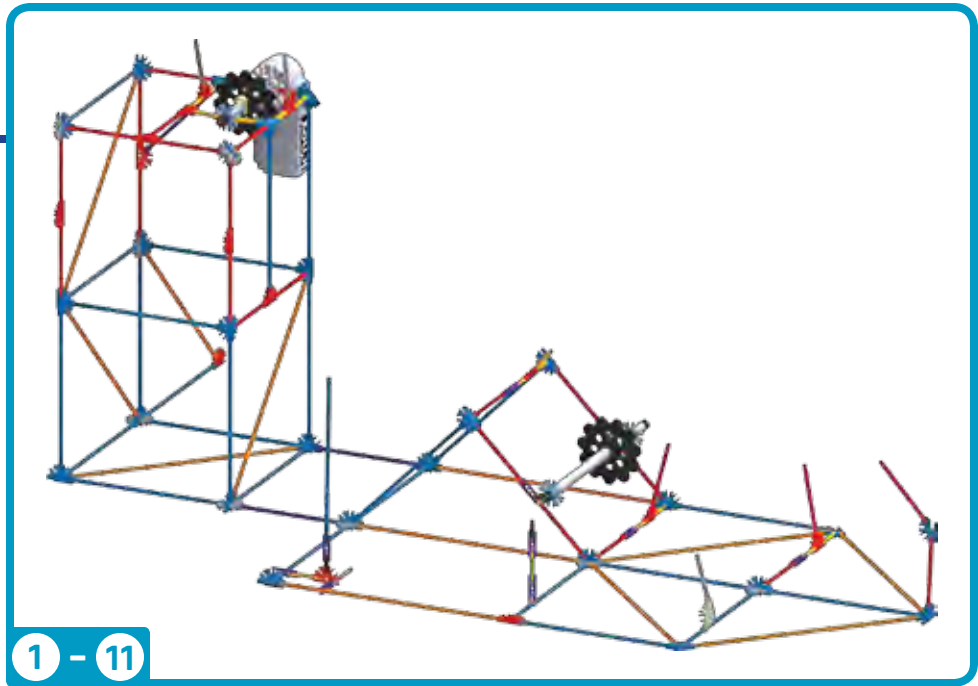

1 - 11



5

1 - 10

2  2   
6 

1 - 12

12

1 - 11

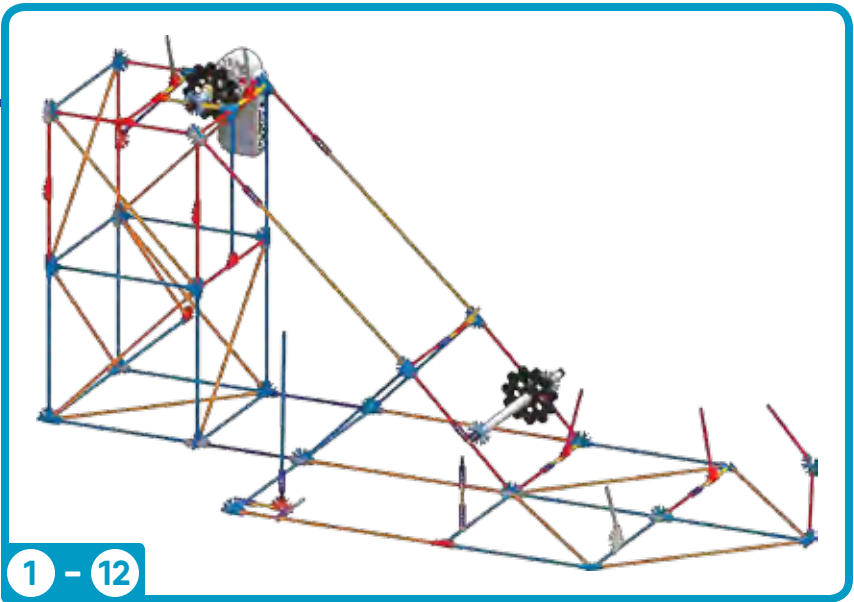



13

3  4   
2 

1 - 12

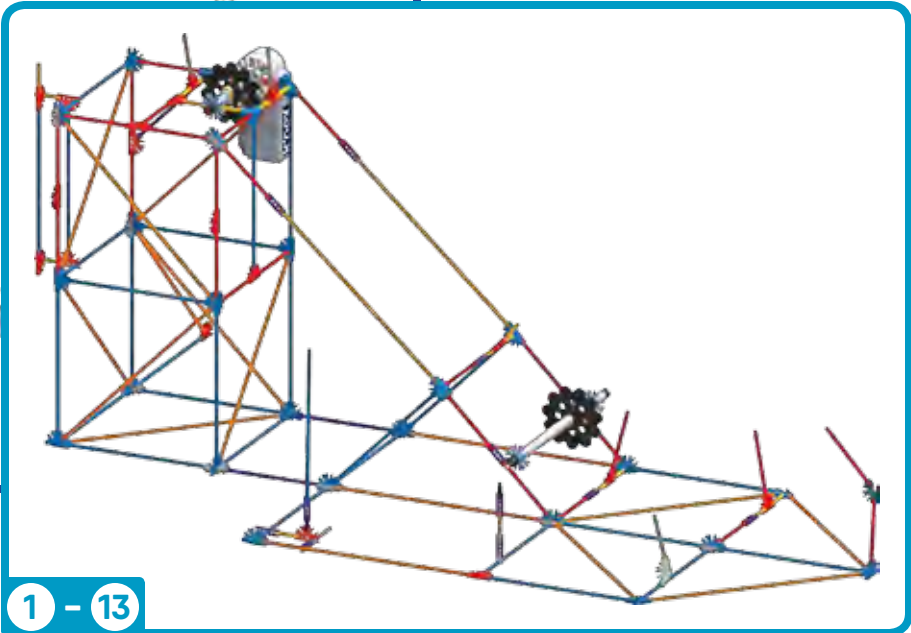

1 - 13

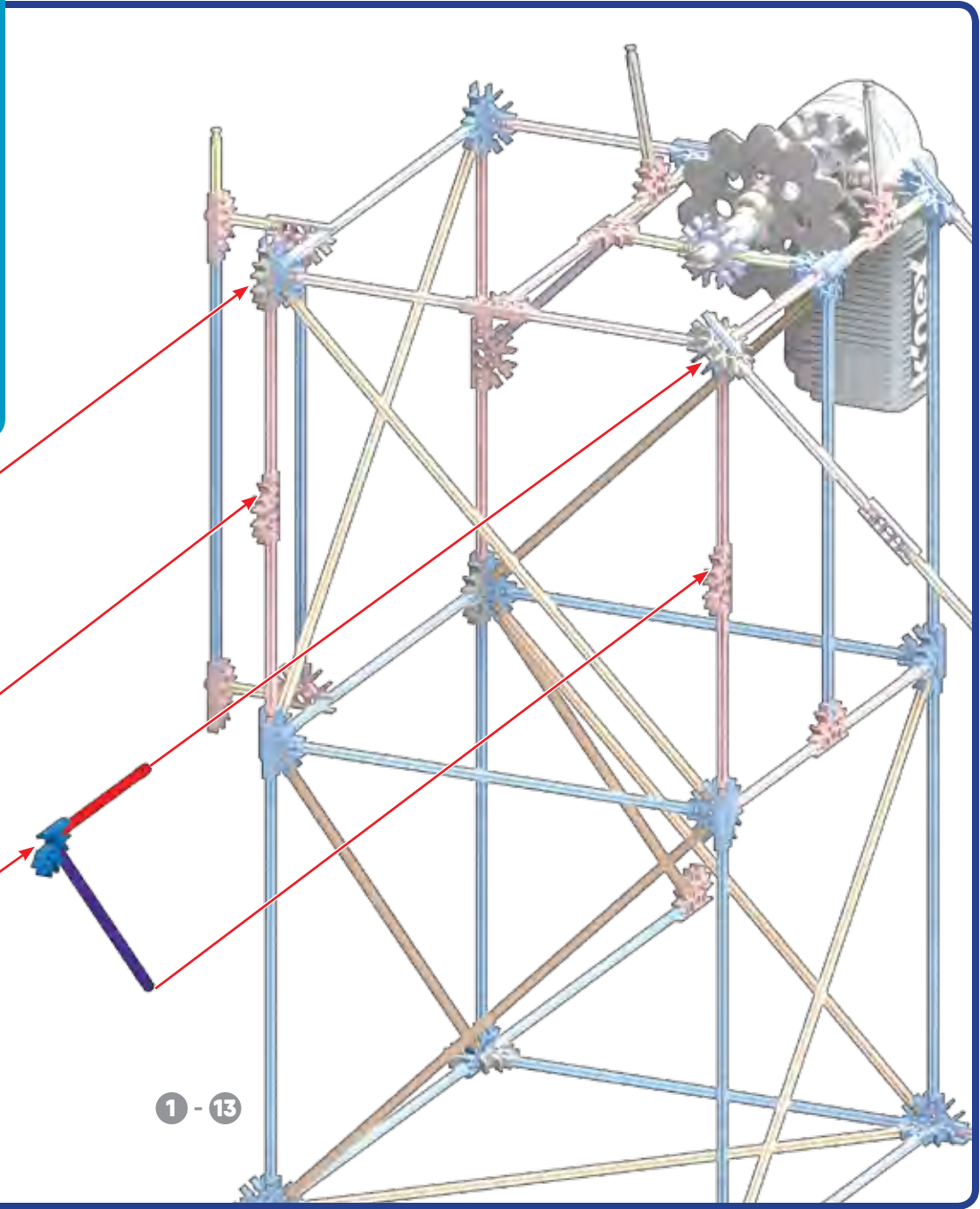
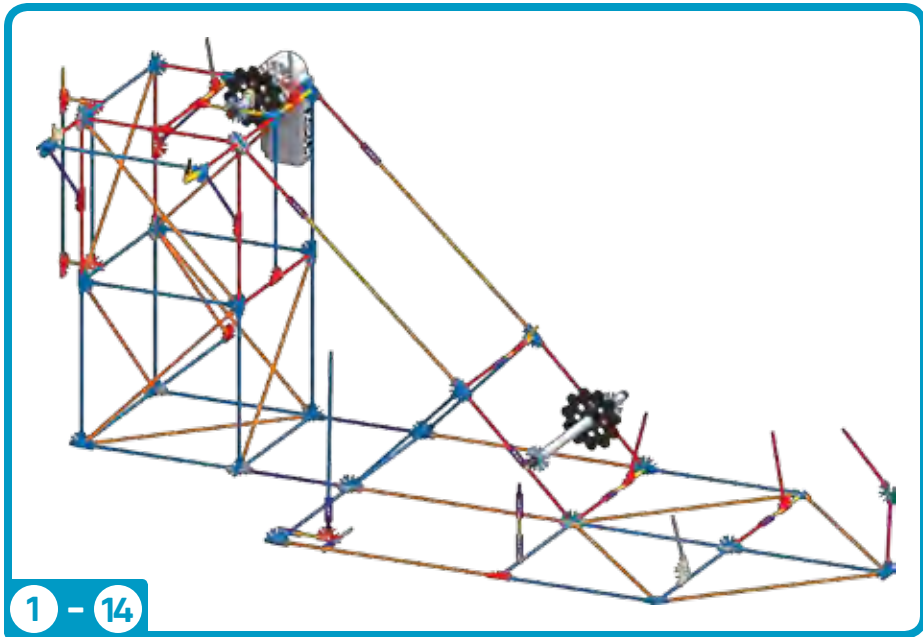

14

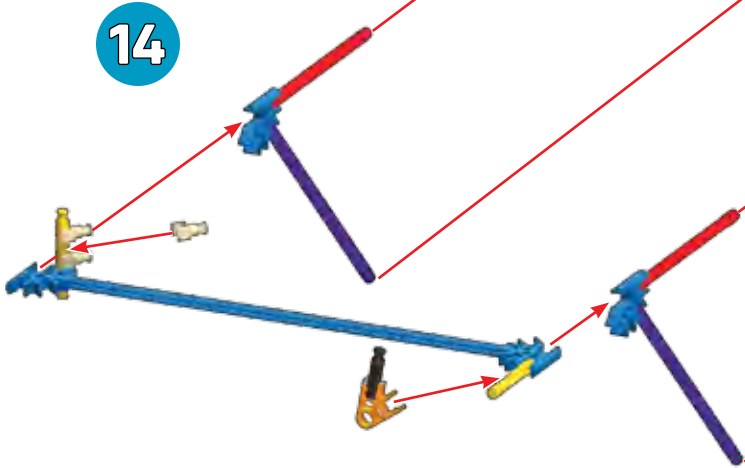

- |   |  |   |  |   |  |
|---|--|---|--|---|--|
| 1 |  | 3 |  | 1 |  |
| 2 |  |   |  | 4 |  |
| 2 |  |   |  |   |  |
| 2 |  |   |  |   |  |
| 1 |  |   |  |   |  |





15



Attach the black chain guides and the connectors to the track exactly as shown.

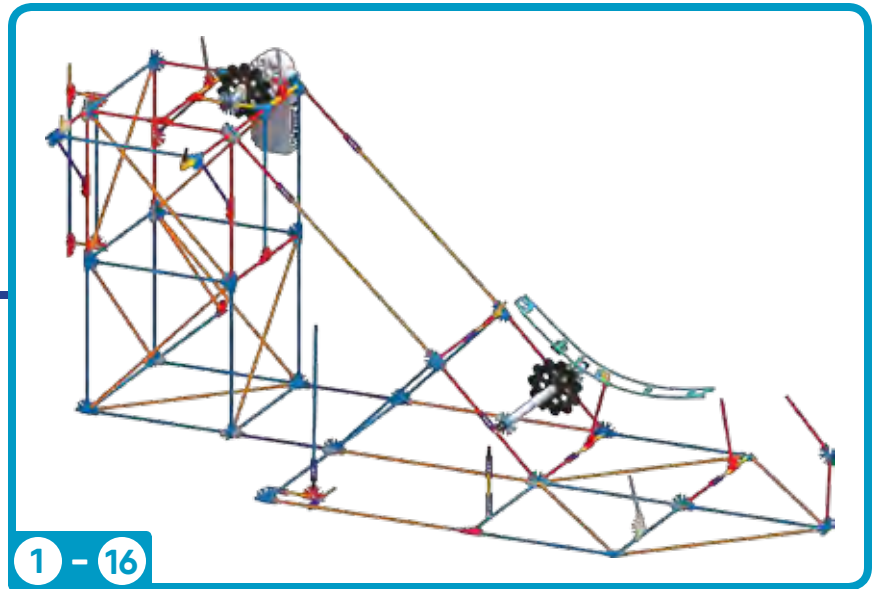

1 - 16

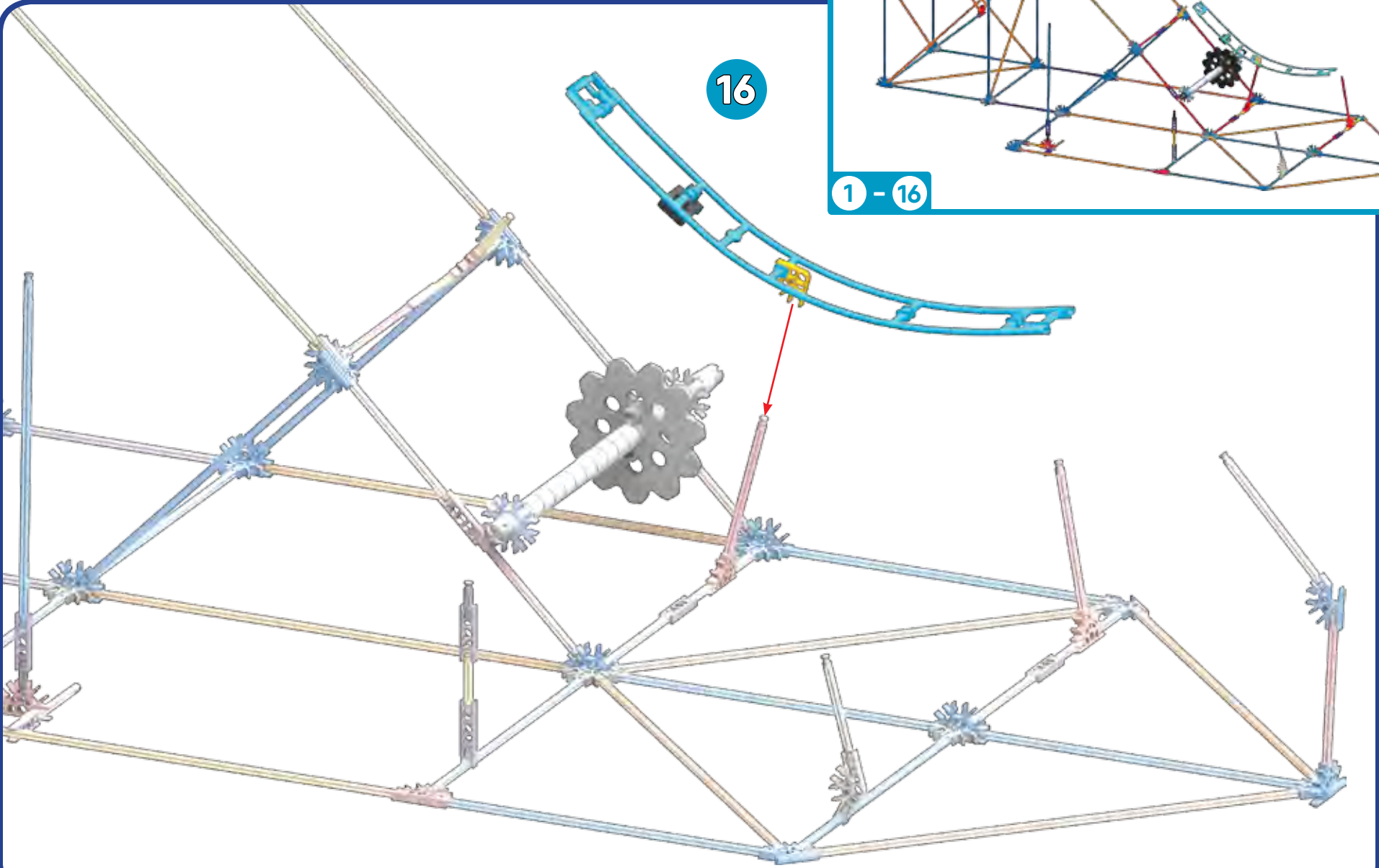

16

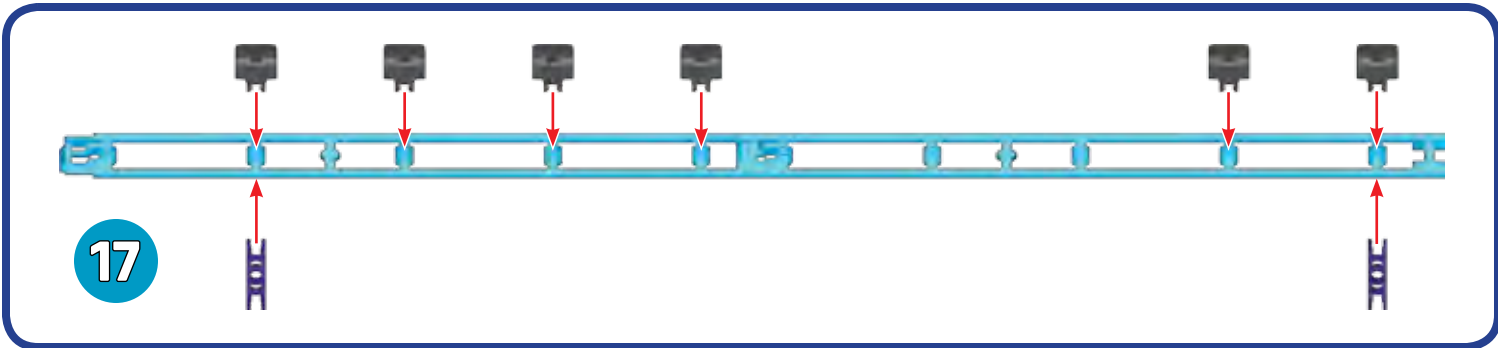

17

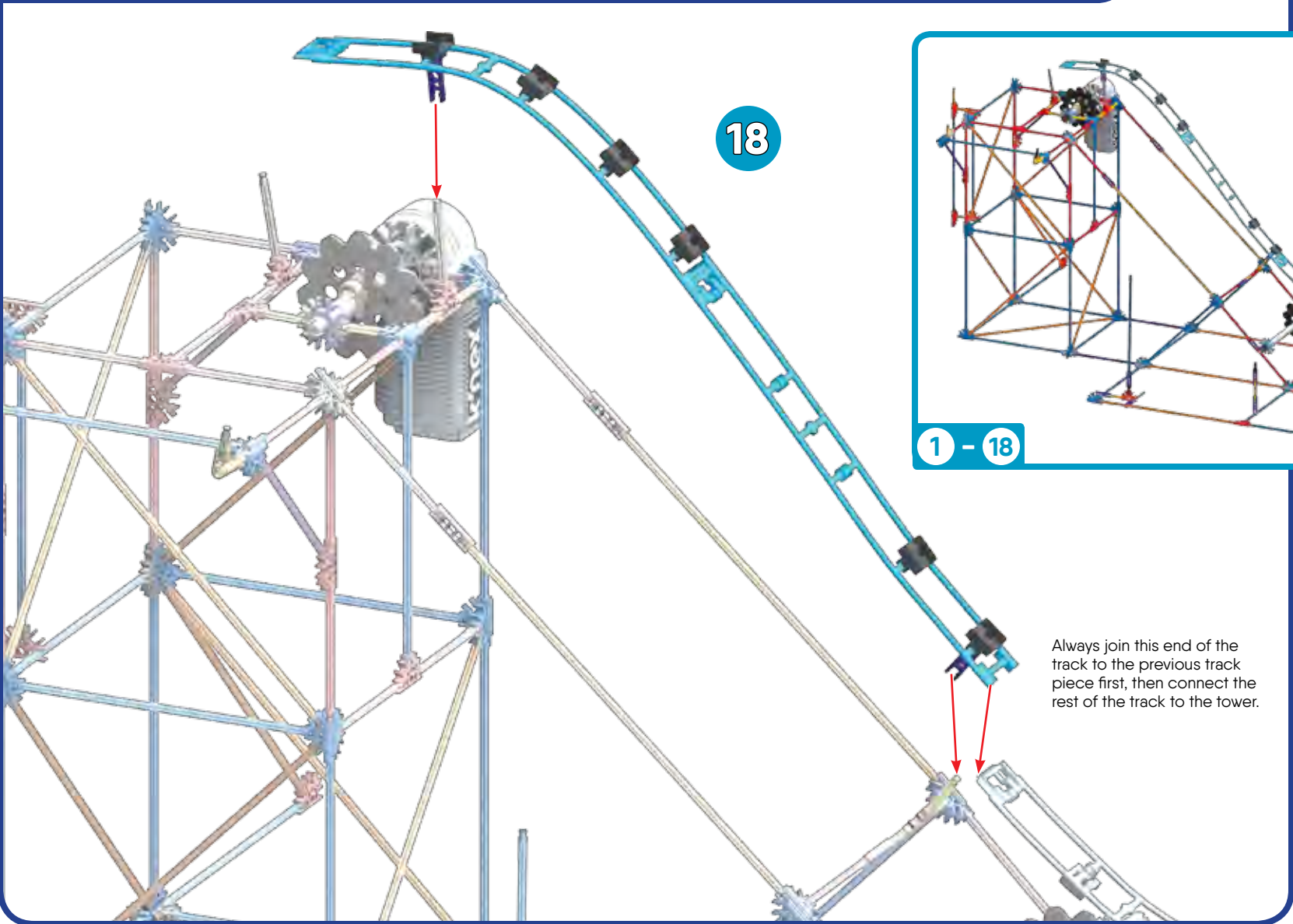

18



1 - 18

Always join this end of the track to the previous track piece first, then connect the rest of the track to the tower.

19

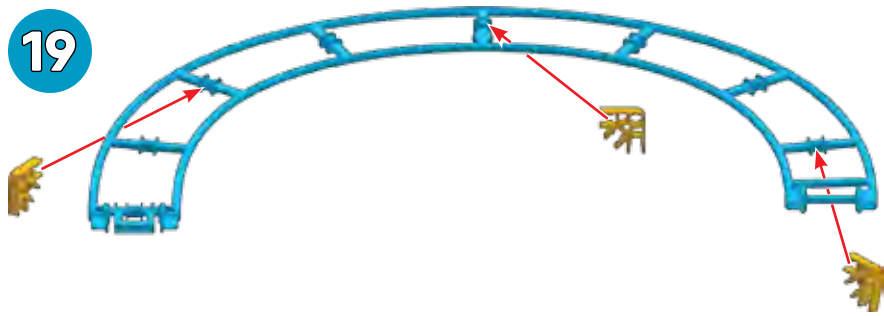

20

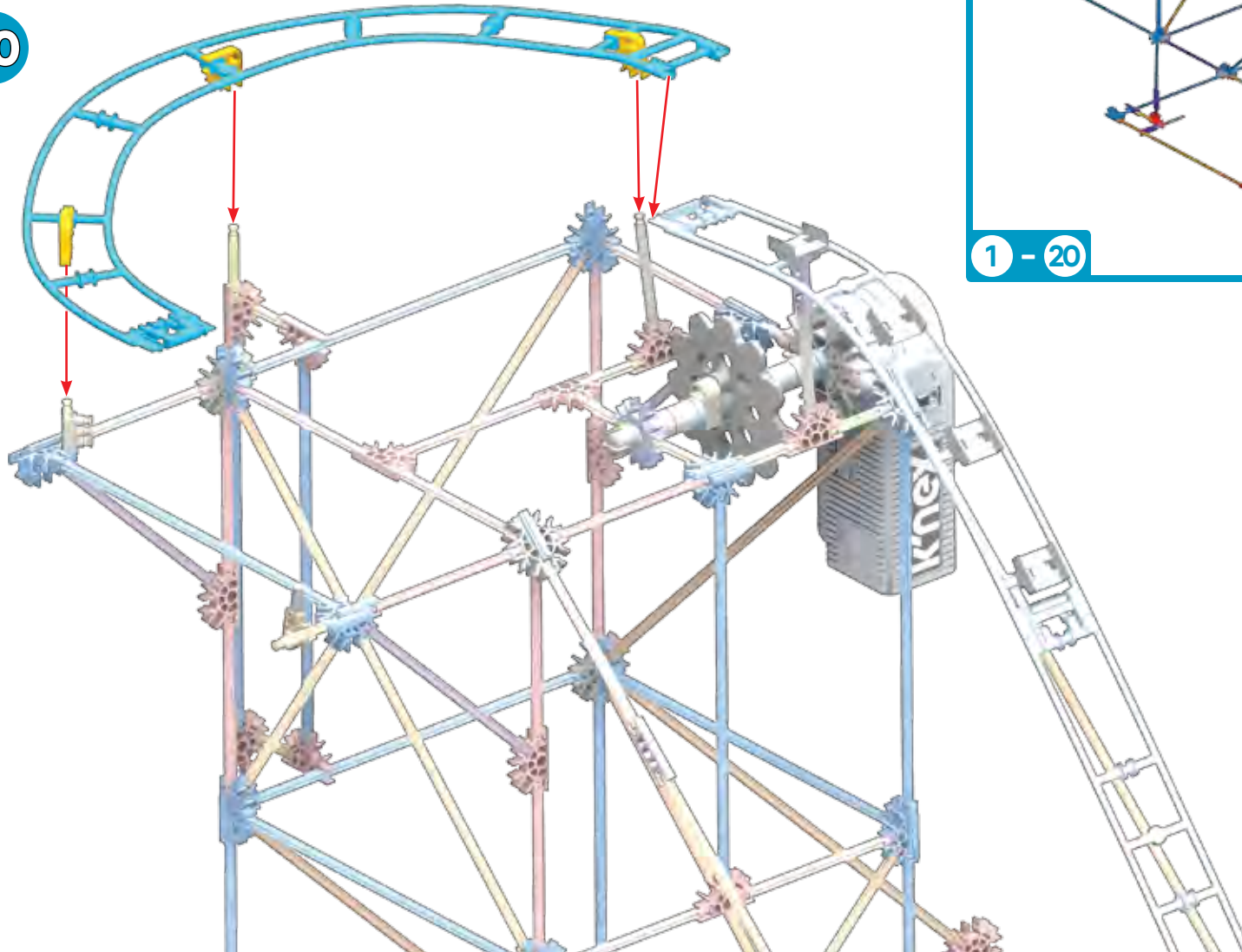

1 - 20

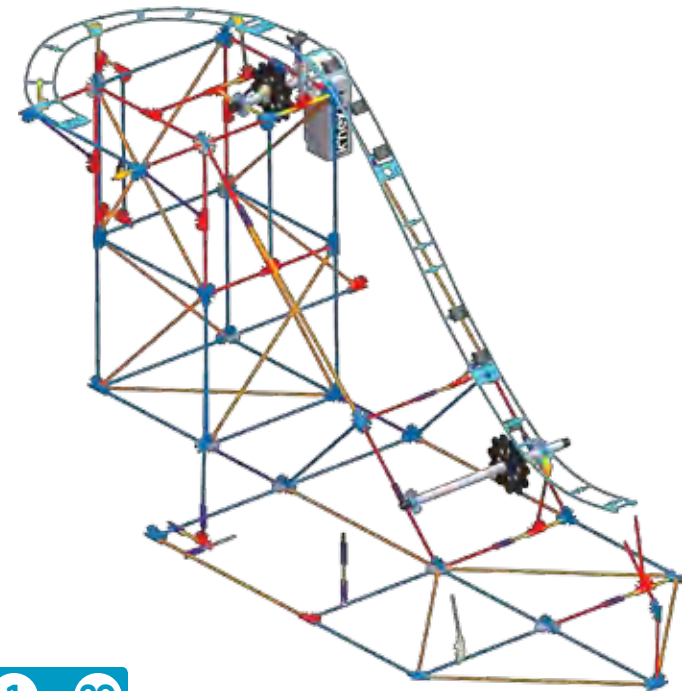



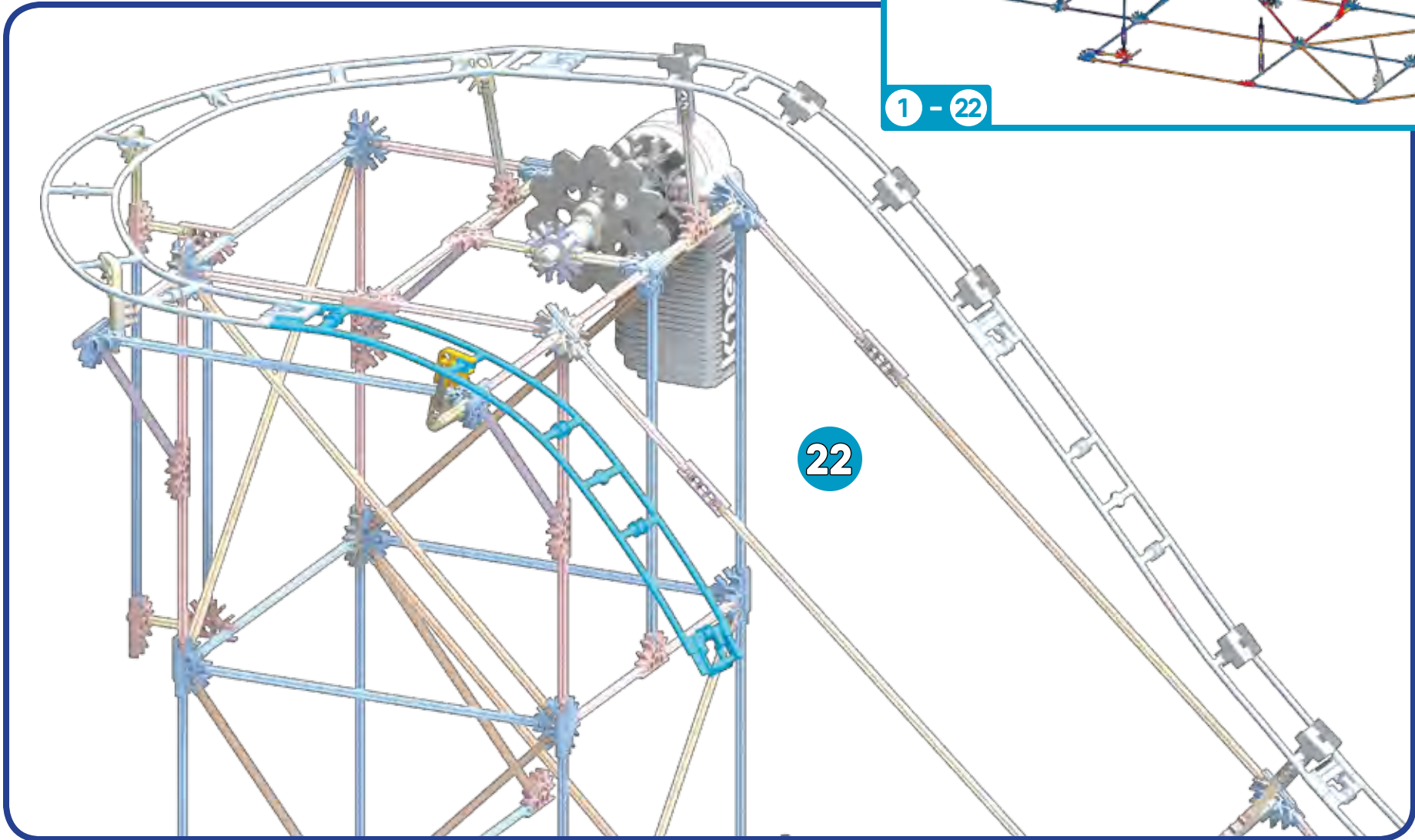
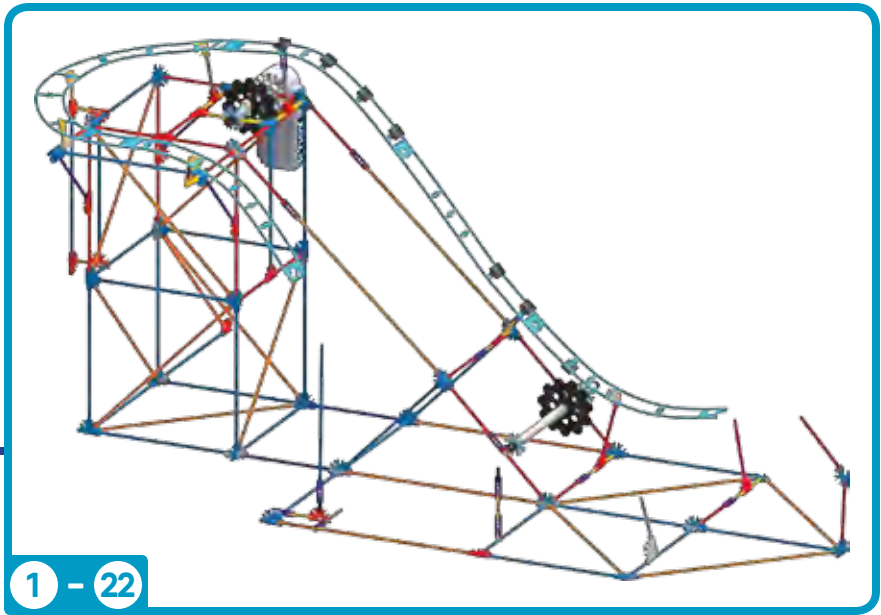
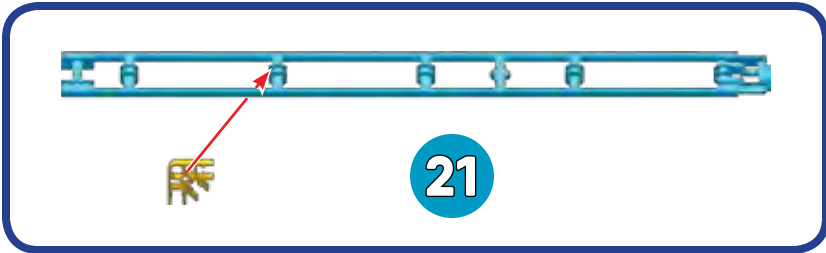

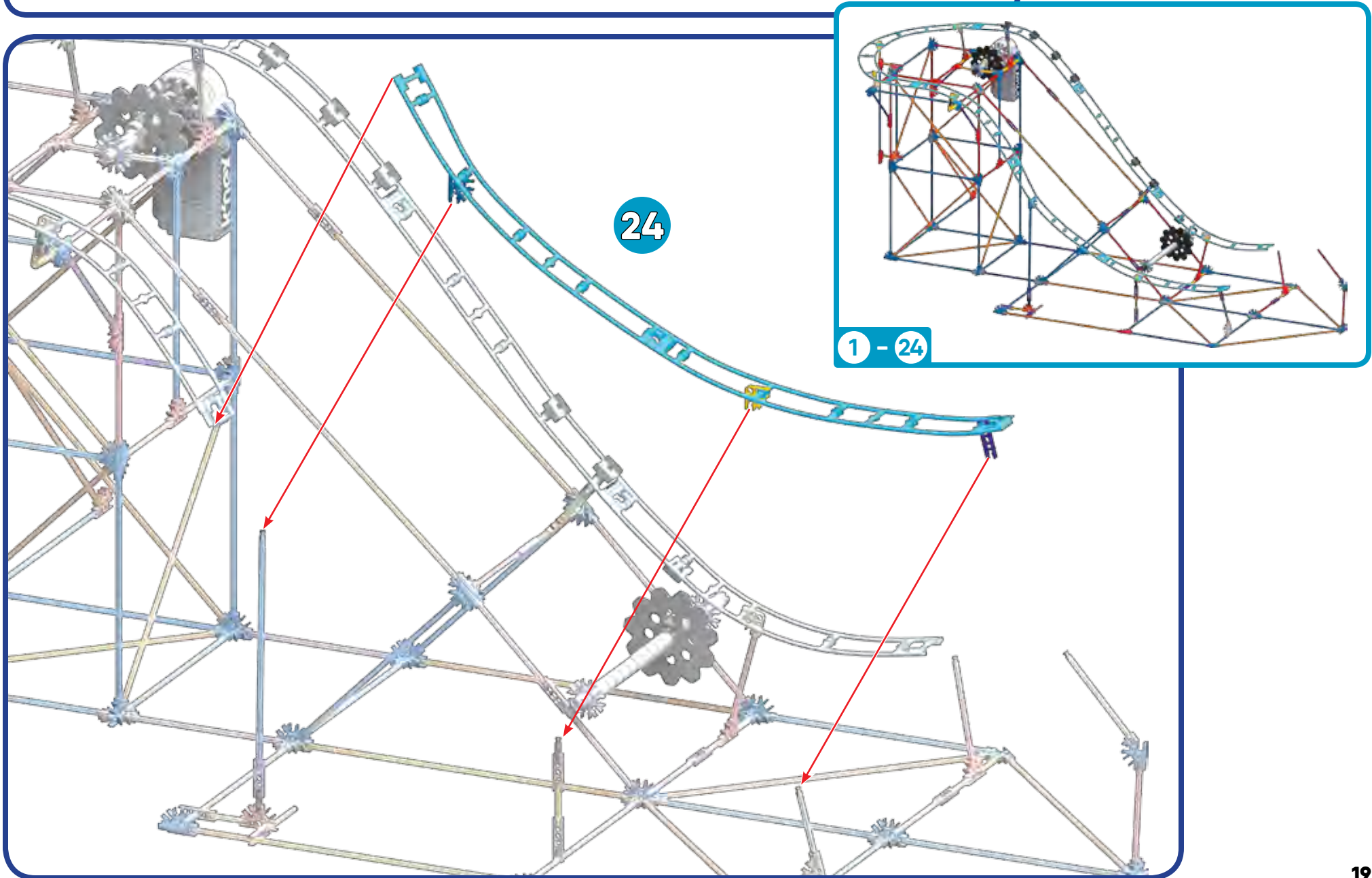
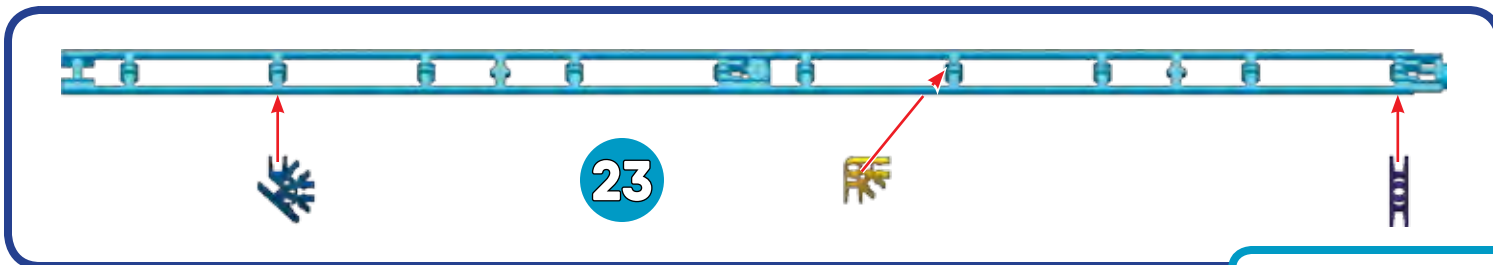

25

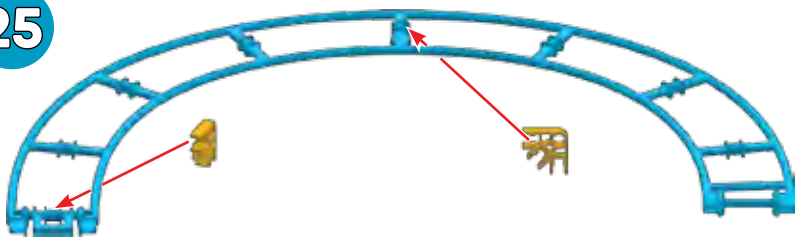

1 - 26

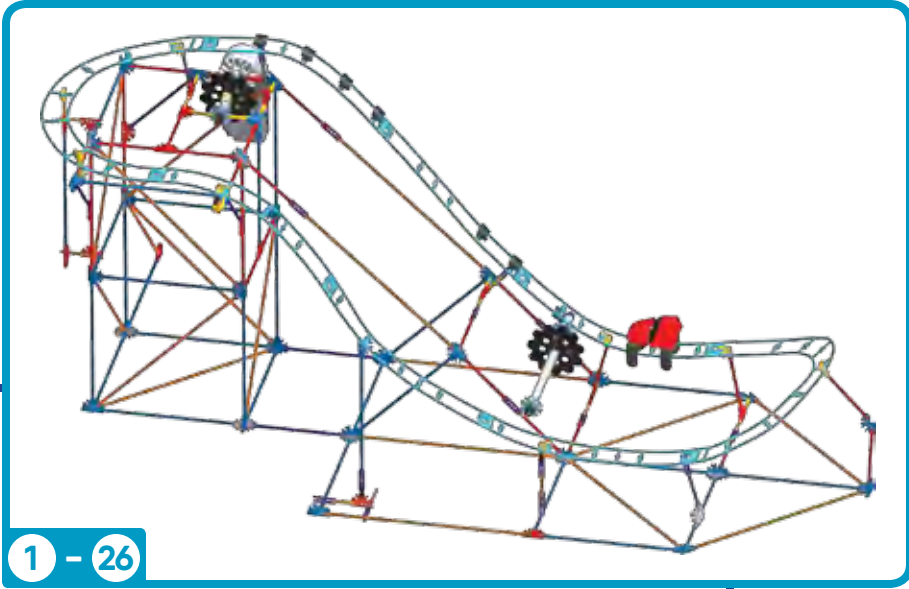

26

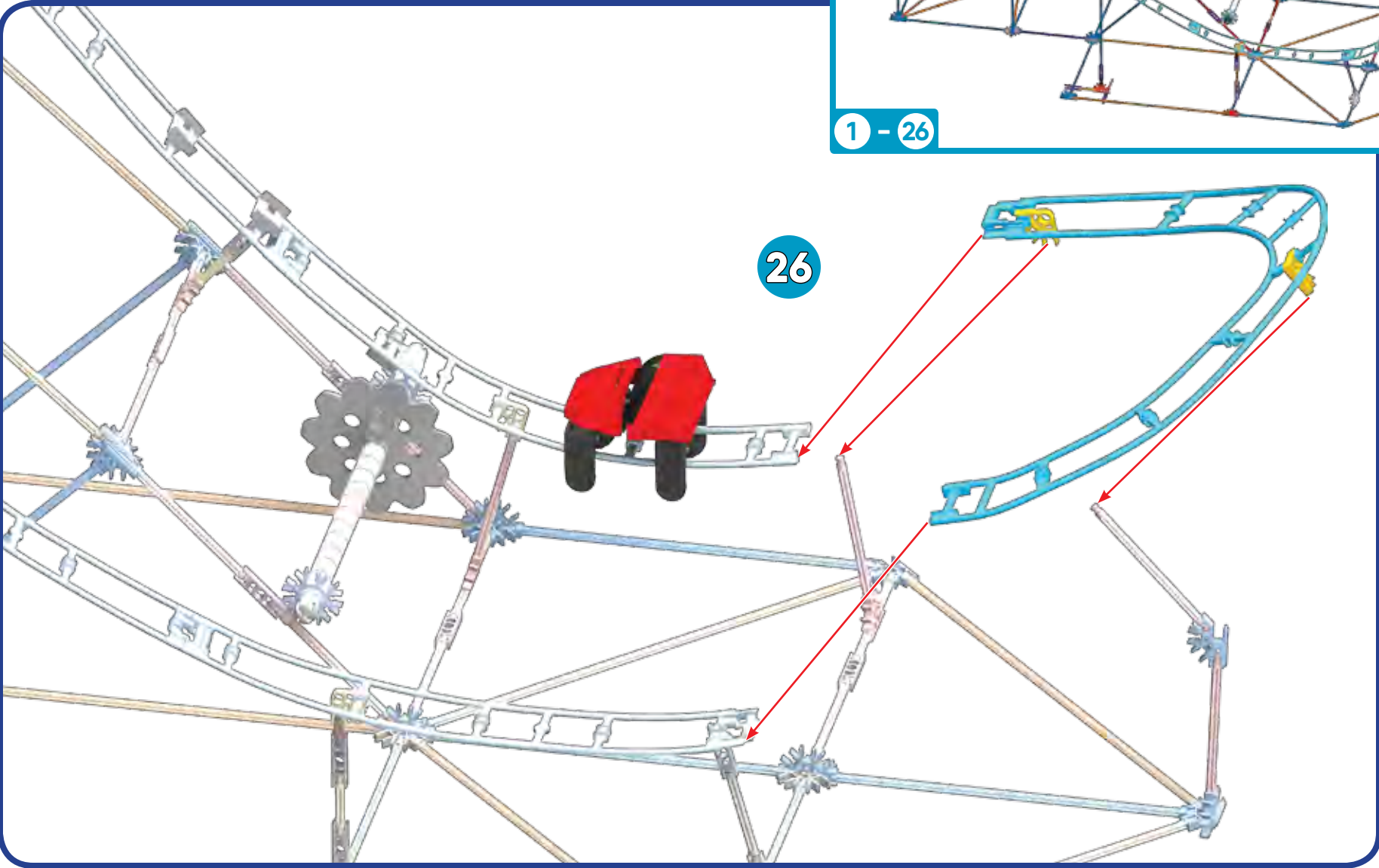





**IMPORTANT:** Attach all the chain links in the same direction.

27



x1

28



x7

29

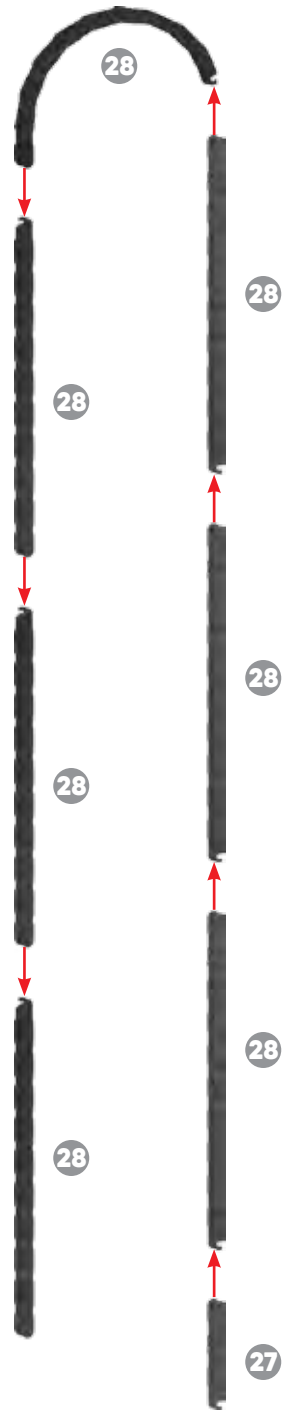

**k'nex**

# COBWEB CURSE

Additional Build

1 - 30

30

