

Disney
BUILD-IT!

Disney Parks

AGES
7+



- Motorized!
- 2+ Feet Long!
- 4 Figures!



WARNING:

CHOKING HAZARD - Small parts.
Not for children under 3 years.



Dumbo
Building Set



60056

K'NEX®



Dumbo Building Set



IMPORTANT STUFF FOR PARENTS & KIDS

Keep these instructions in a handy location.
They contain important safety information.

Read all warnings and instructions before you start
to build and operate the model.

⚠ WARNING: CHOKING HAZARD - Small parts. Not for children under 3 years.

CAUTION: Keep hands, face, hair and clothing away from all moving parts.

CAUTION: Be careful not to tip the model over. Model should be placed on a flat and hard surface.

- Share the K'NEX experience with your child and make building with K'NEX a family fun adventure.
- Take your time to enjoy the building process. Don't rush!
- While you're building make sure you face your model in the same direction as the pictures show in the instructions.
- Product and colors may vary.

BATTERY INFORMATION

Caution: To Avoid Battery Leakage

- Be sure to insert the batteries correctly and always follow the toy and battery manufacturers' instructions.
- Do not mix old and new batteries or alkaline, standard (carbon-zinc) or rechargeable (nickel-cadmium) batteries. Only batteries of the same or equivalent type recommended should be used.
- Always remove weak or dead batteries from the product; do not short-circuit supply terminals.
- Insert batteries with correct polarity (+/-) as shown.

Important Tips

- Alkaline batteries AA (LR6) are recommended.
- Rechargeable batteries are not recommended.
- Remove rechargeable batteries from toy before charging; they must be charged only under adult supervision.
- Non-rechargeable batteries must not be recharged.
- Keep components free of dust; do not immerse or use in water.
- Do not dispose of batteries in a fire; they could leak or explode and cause injury.
- Remove all batteries if the toy will not be used for a long period of time.
- Do not put rods smaller than 2 inches in any openings of the motor; they will damage the motor, and cannot be removed.
- Help the environment by disposing of your product and packaging responsibly. The wheelie bin symbol indicates that the product and batteries must not be disposed of in the domestic waste as they contain substances which can be damaging to the environment and health. Please use designated collection points or recycling facilities when disposing of the item or batteries.

How to Insert and Remove Batteries

- Use a small Phillips head screwdriver to loosen the screw. Insert 2 fresh AA batteries (LR6) into the compartment with the correct polarity (+/-) as shown here.

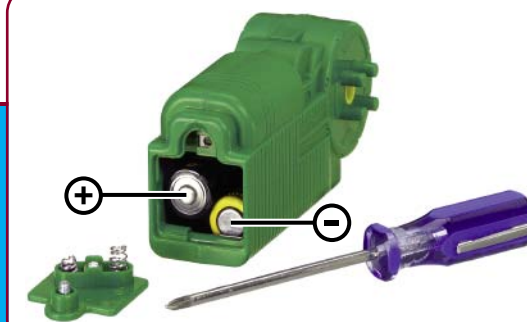

Disney.com
Disney Theme Park Merchandise
Lake Buena Vista, FL 32830
©DISNEY

Go to **K'NEX.COM** for Instruction Updates

K'NEX BUILDING BASICS

Start Building

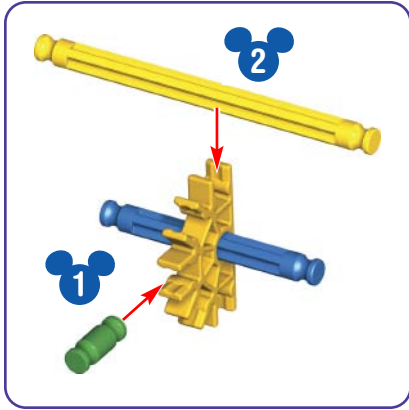

To begin your model, find the **1** and follow the numbers. Each piece has its own shape and color. Just look at the pictures, find the pieces in your set that match and then connect them together. Try to face your model in the same direction as the instructions while you build. The arrows show you where the parts connect, but not all connections points have arrows.

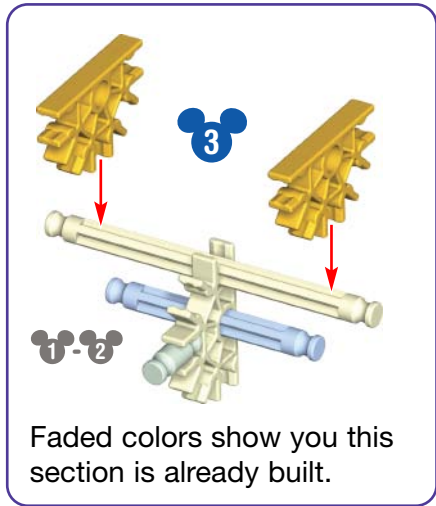

Faded colors show you this section is already built.

Parts List

Before you start building, be sure to compare the parts in your set with the parts list here. If anything is missing, call or write to us using the information on the back cover.

We are here to help you!

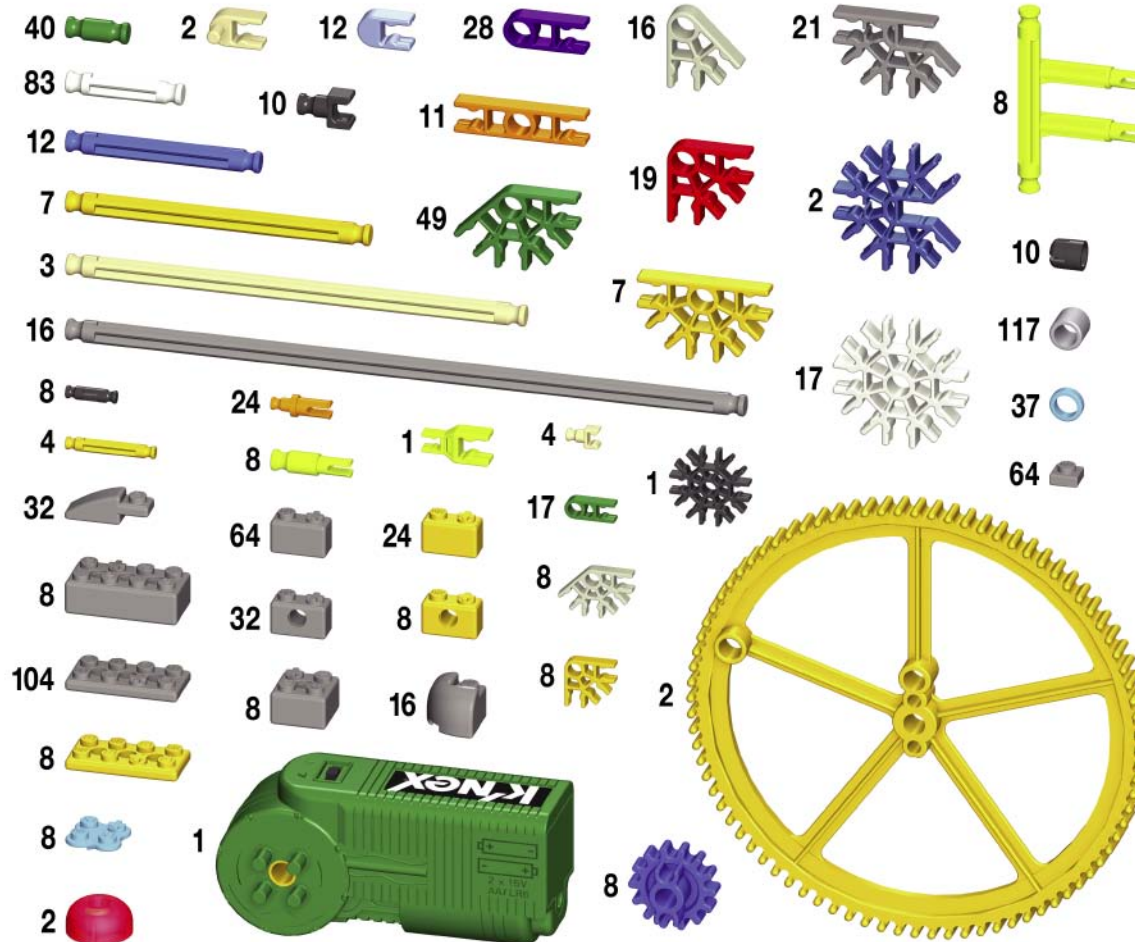

Spacers



There are places in your model where you need to add blue and silver spacers. Be sure to use the right color and count them carefully.

Panels/Stickers

See pages 20, 24, 25, 26 for attaching to model.

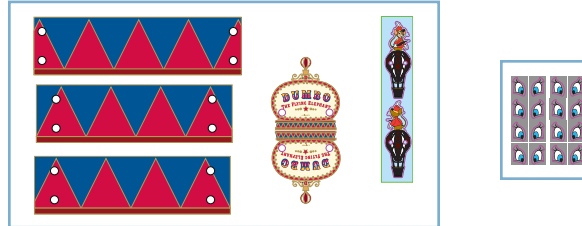

Connectors

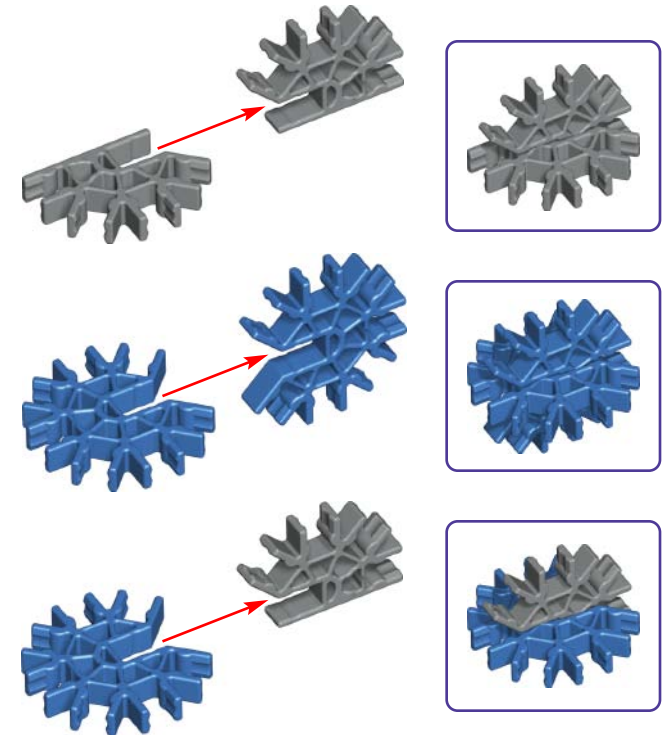

There are blue and gray connectors with special long slots. They slide together as you see in the pictures. Push these parts together until you hear a "click."

Figure Assembly

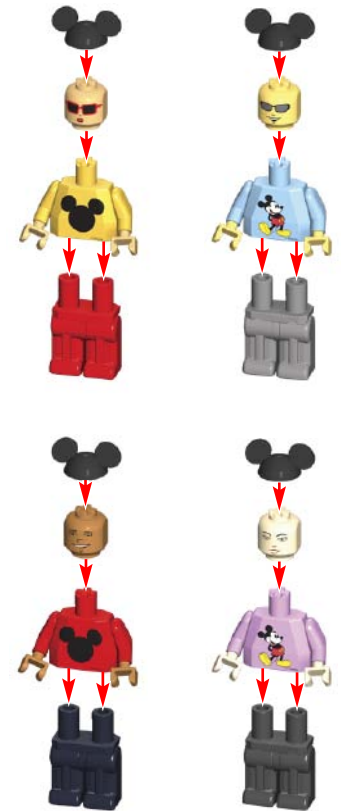



Dumbo
Building Set

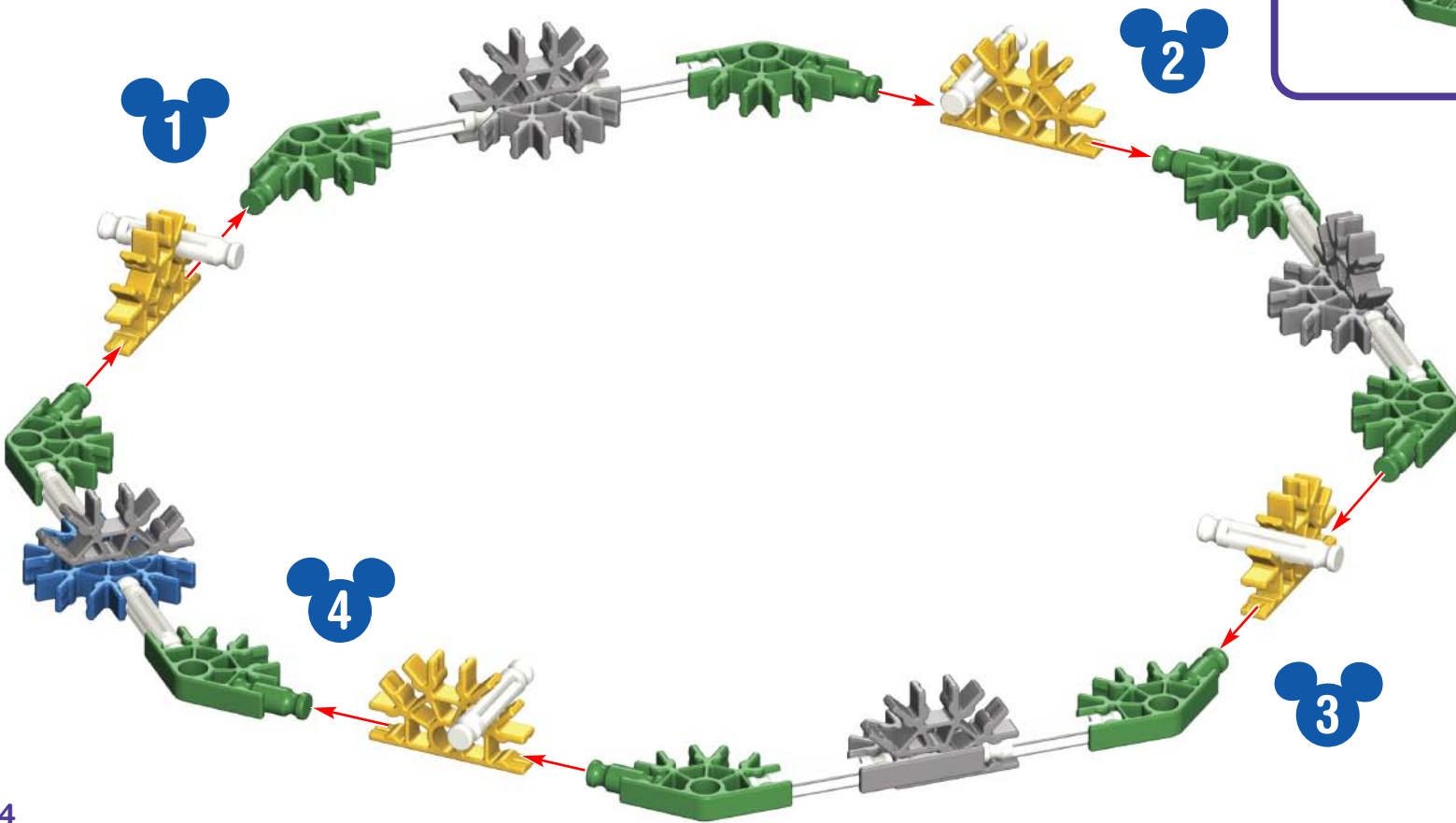
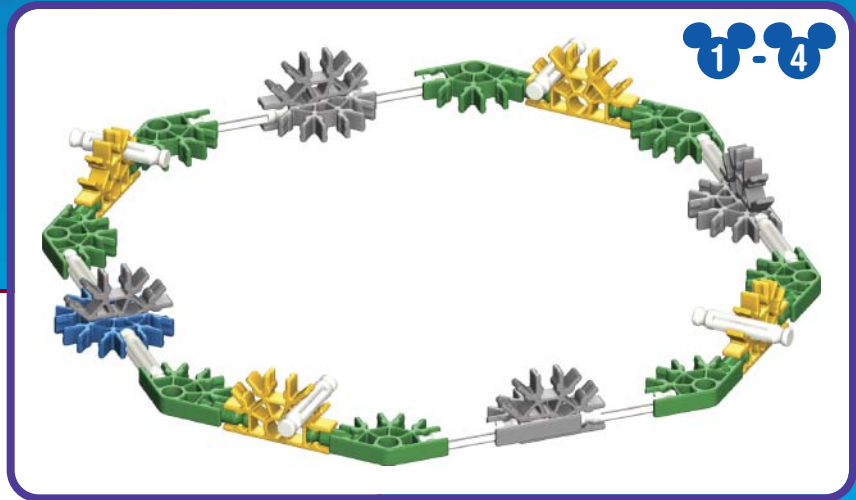
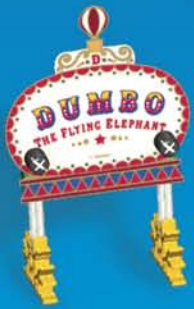

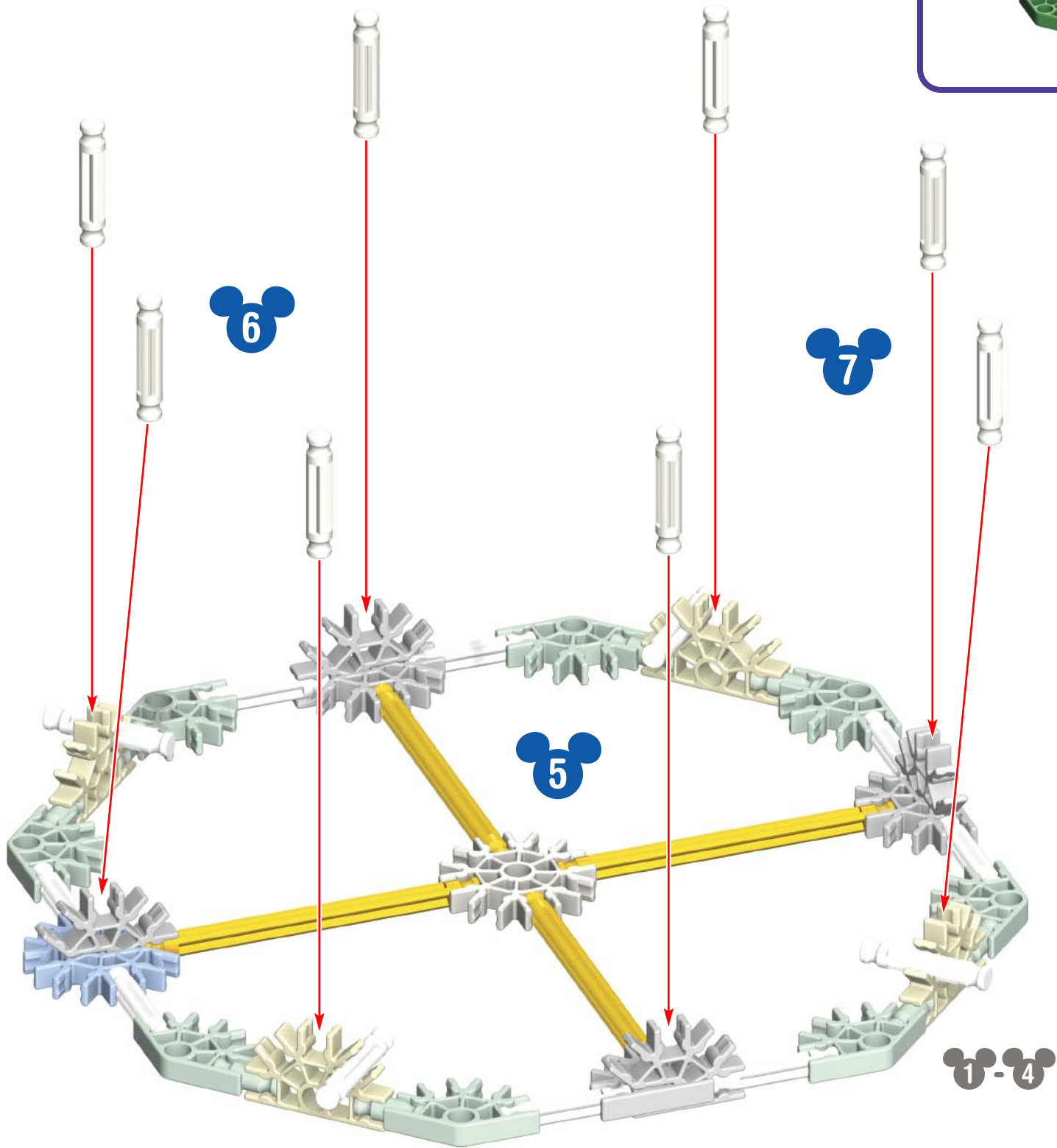
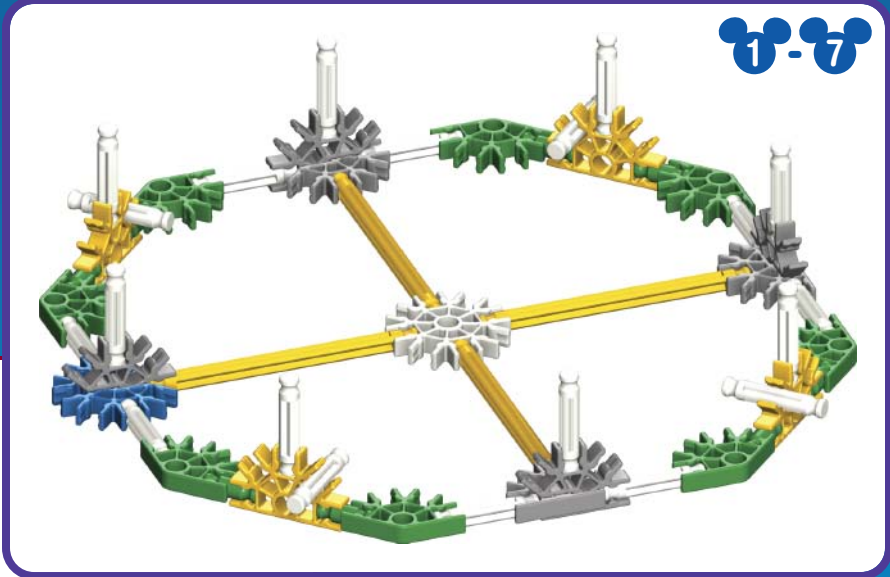

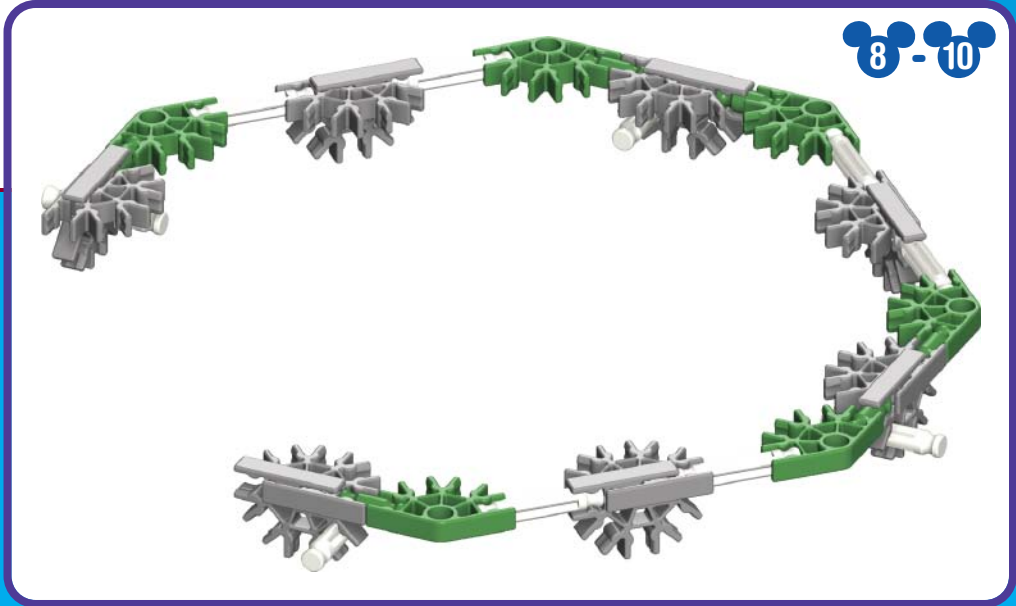
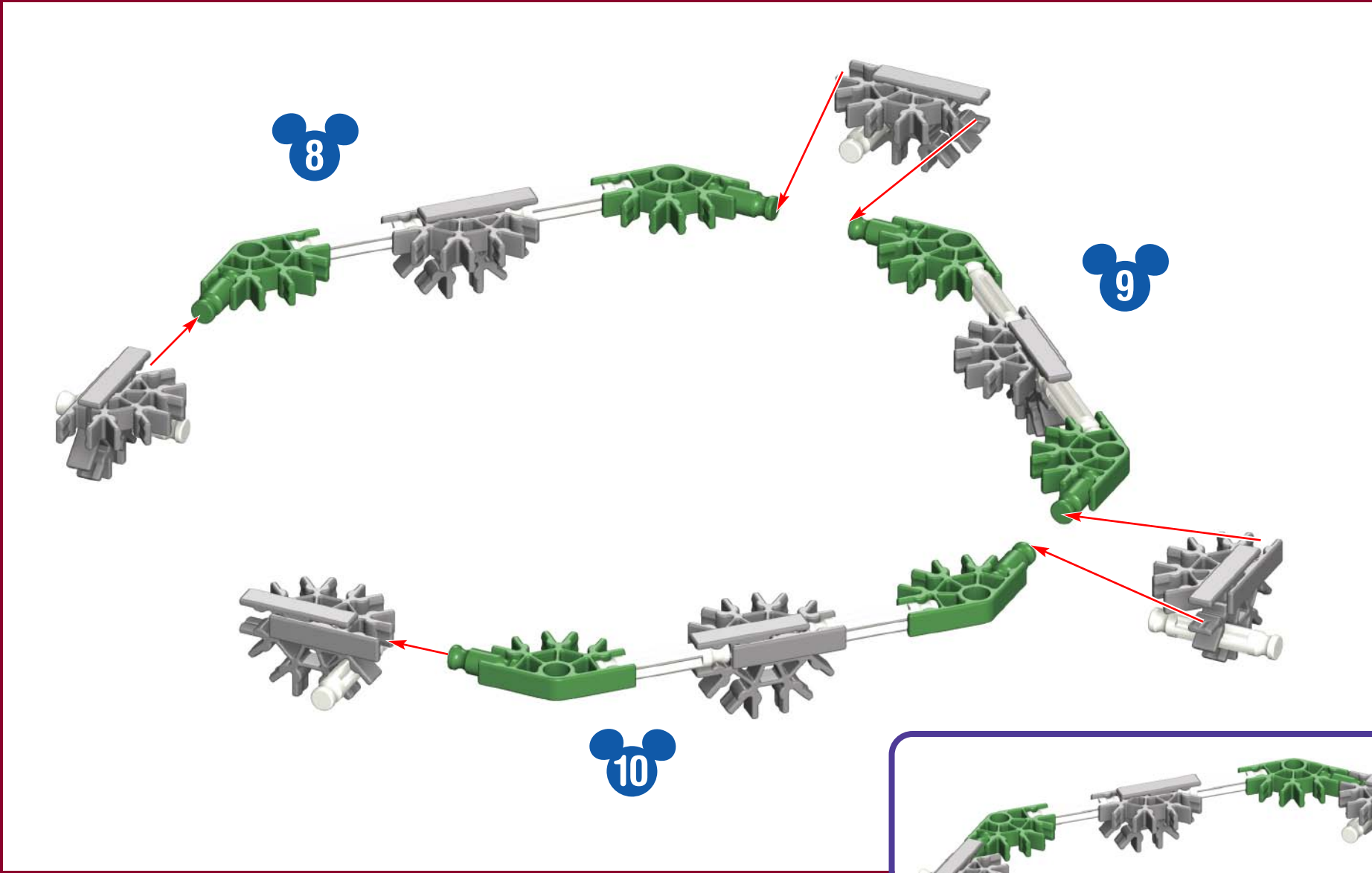

8-10

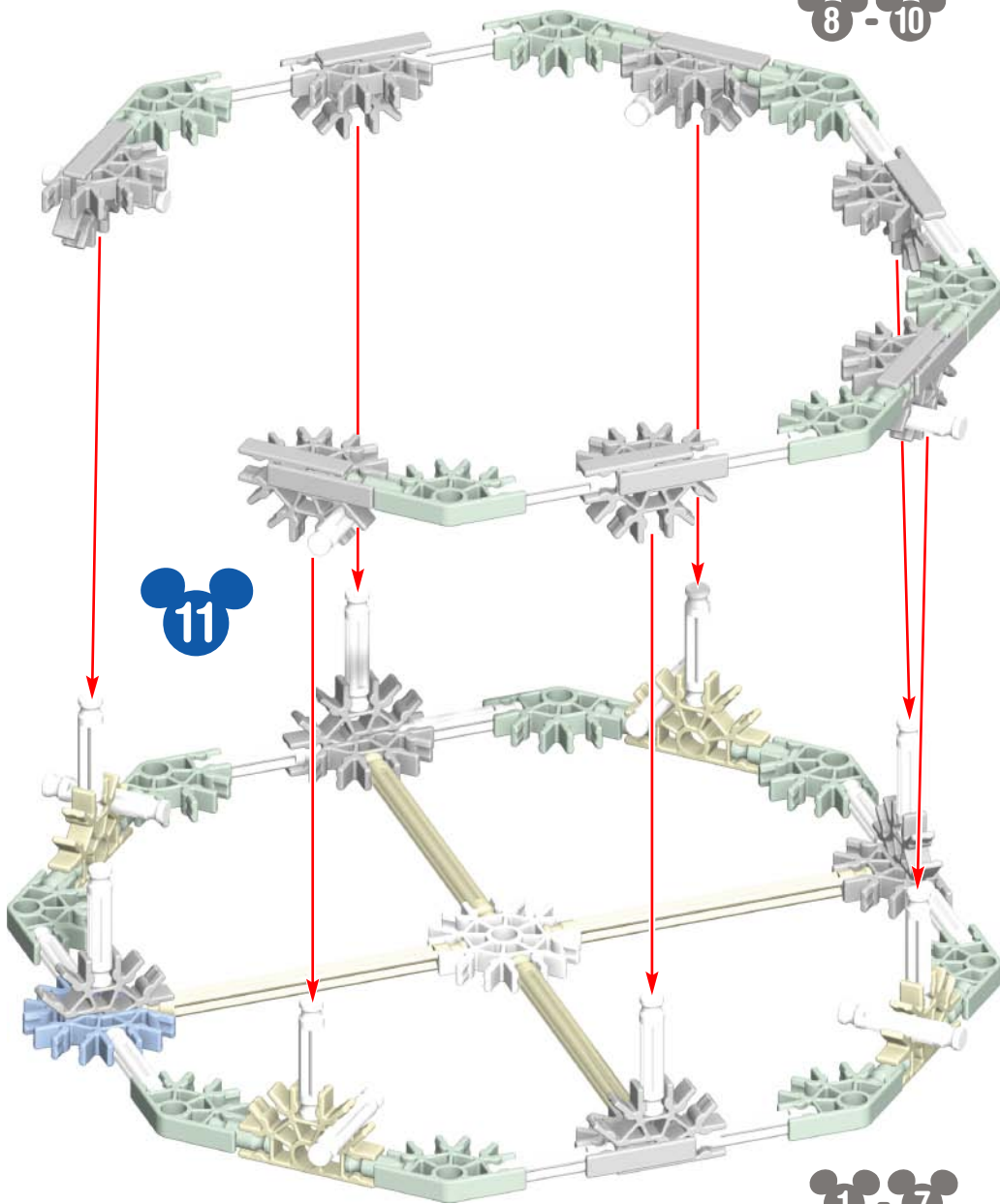

11

7

9-11

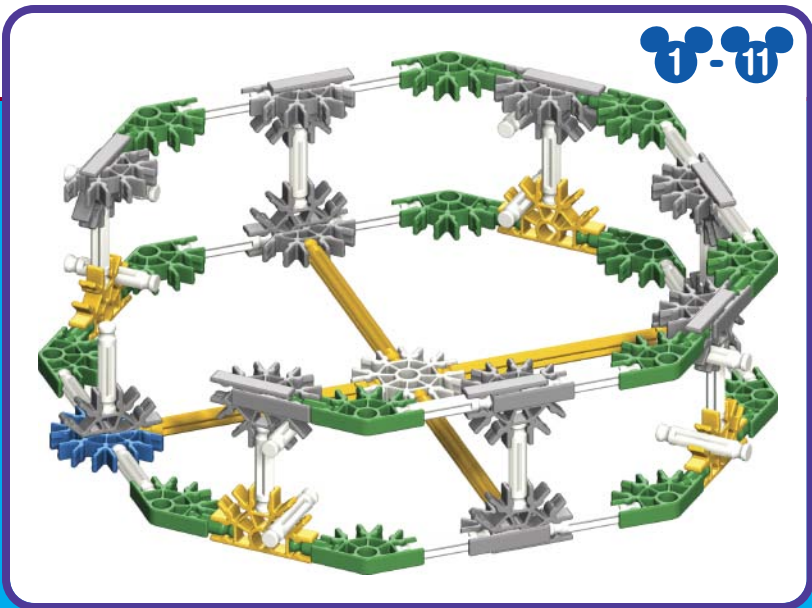

1-12



12

9-11

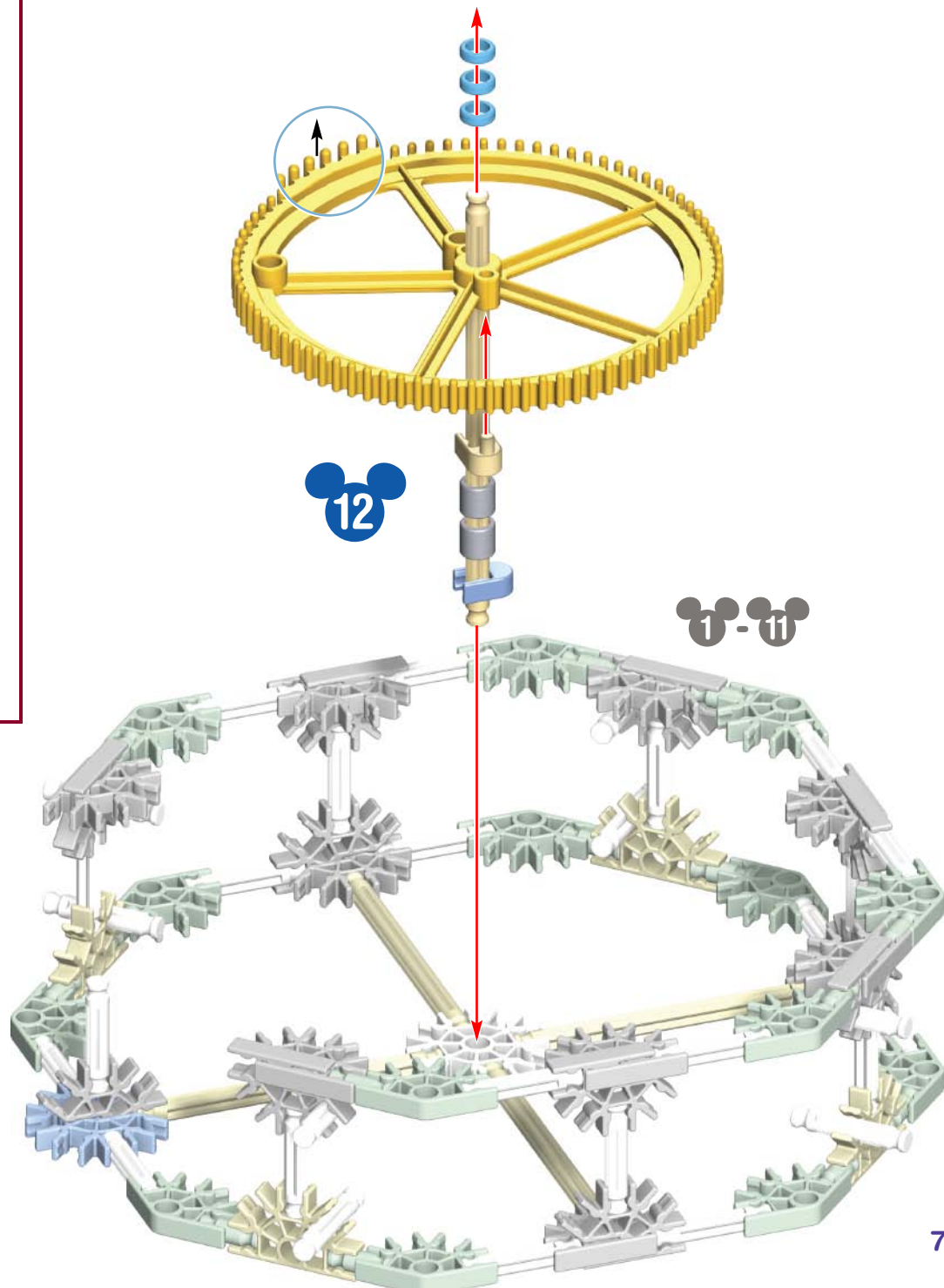

Did you install 2 AA (or LR6) batteries in the motor?

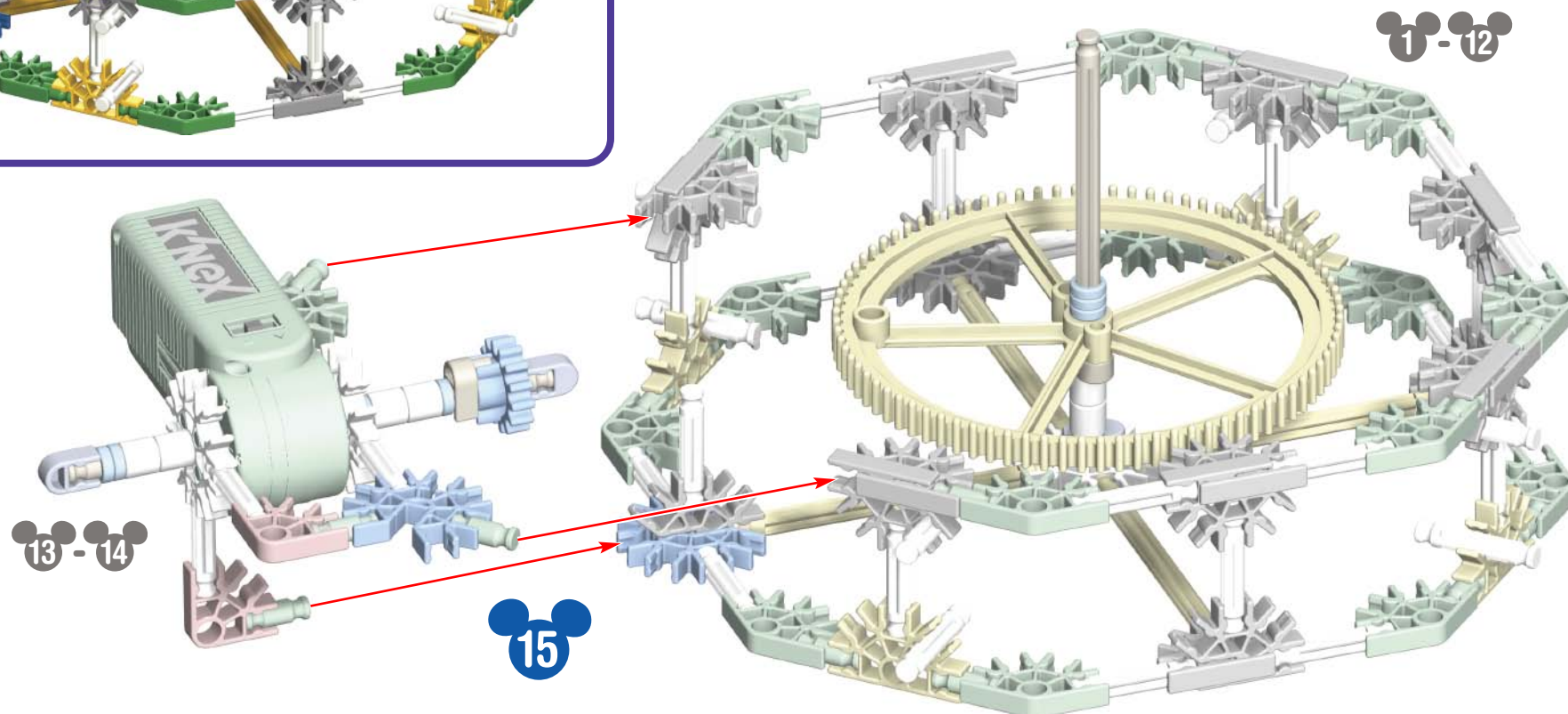
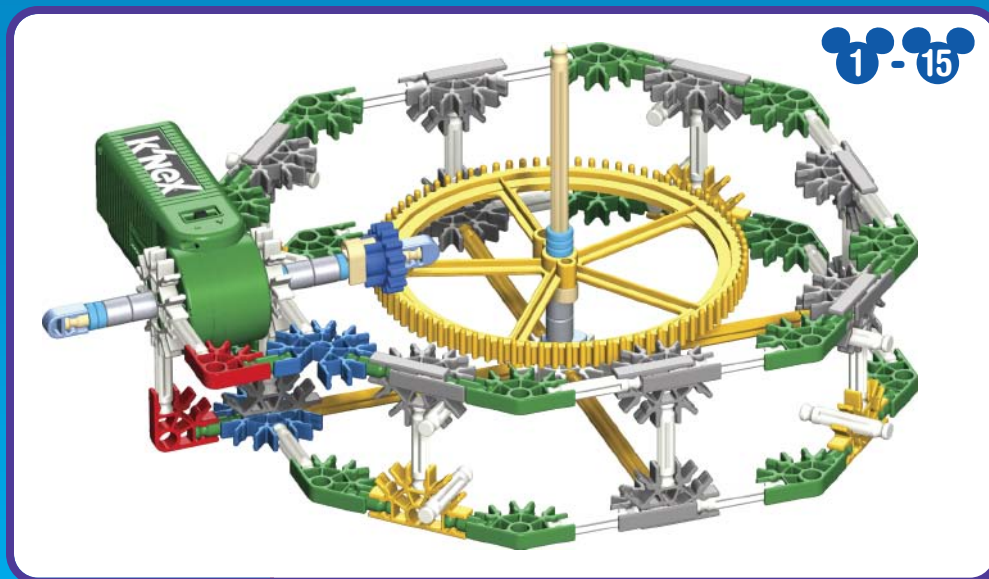
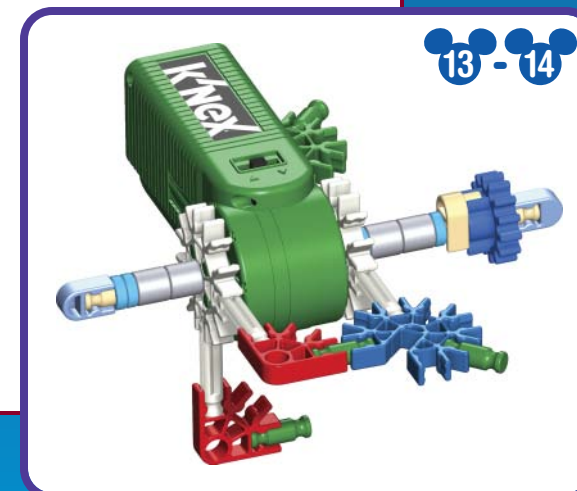
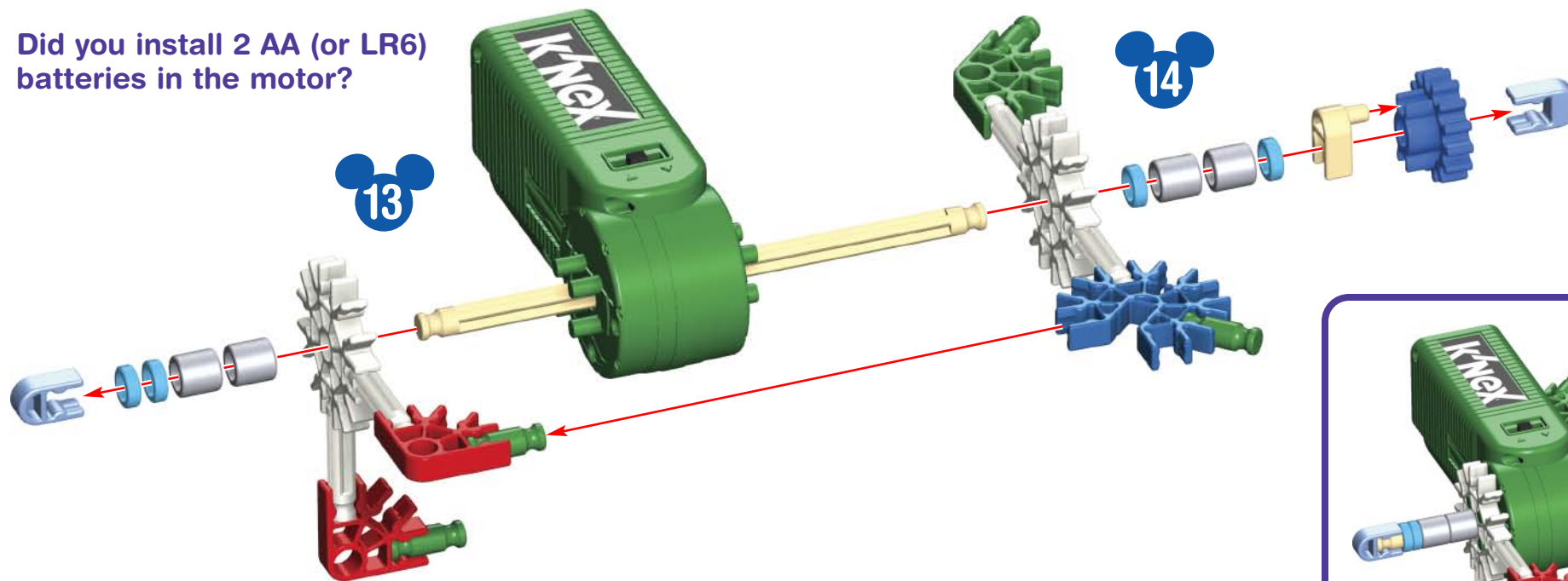

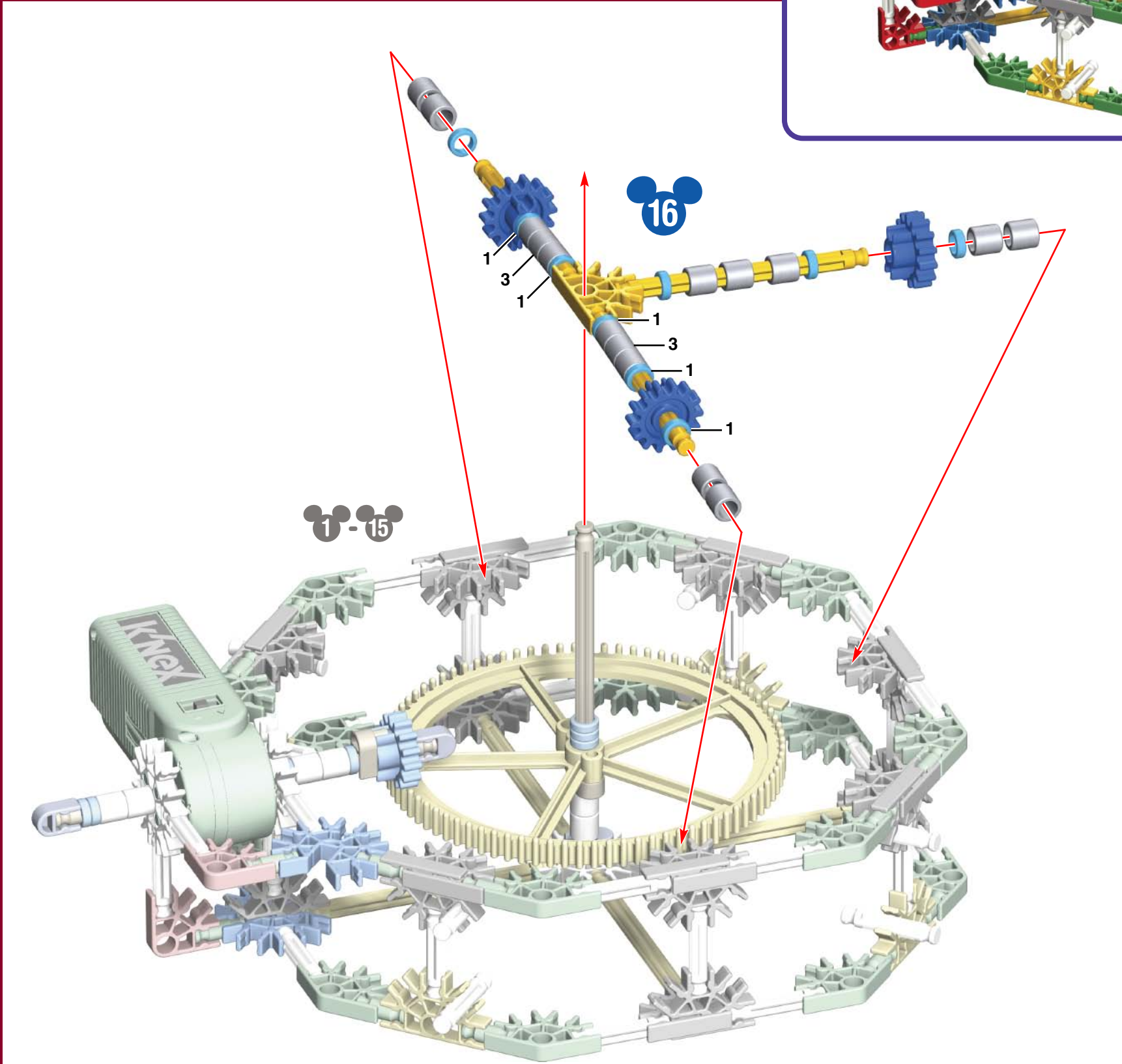
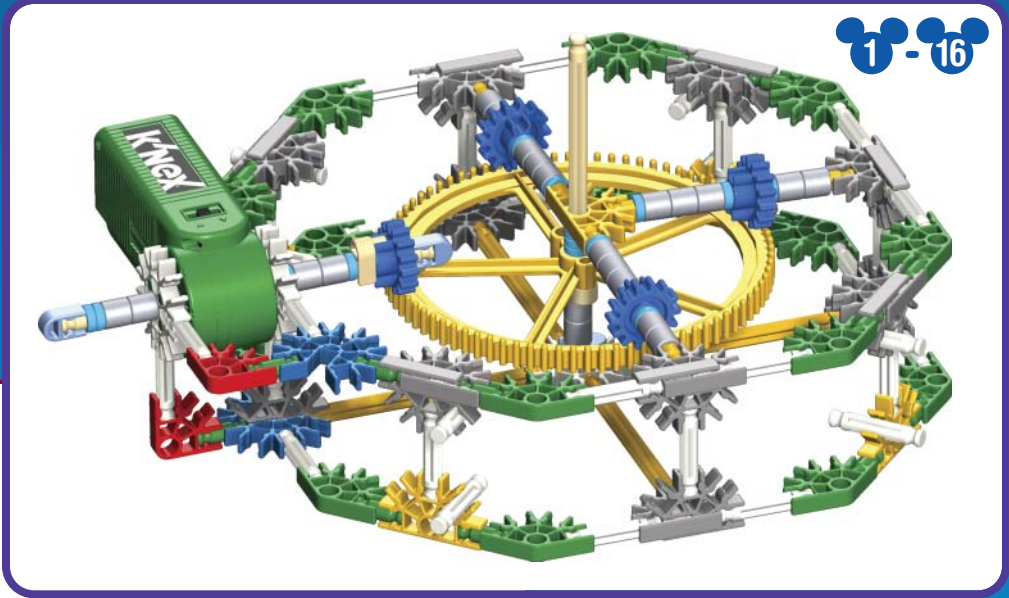

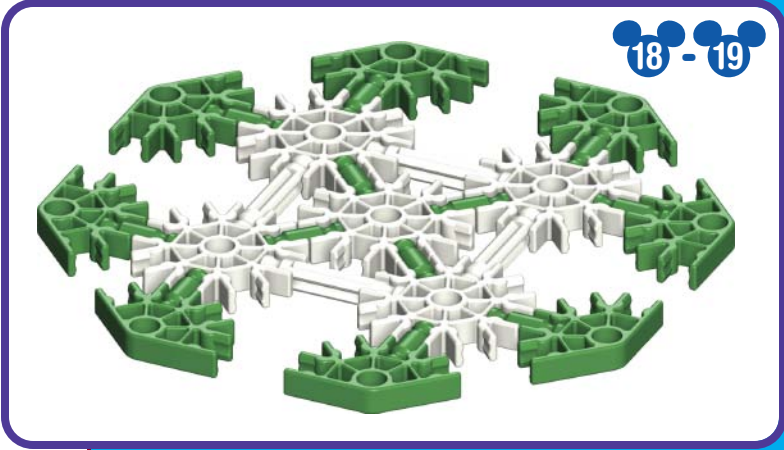
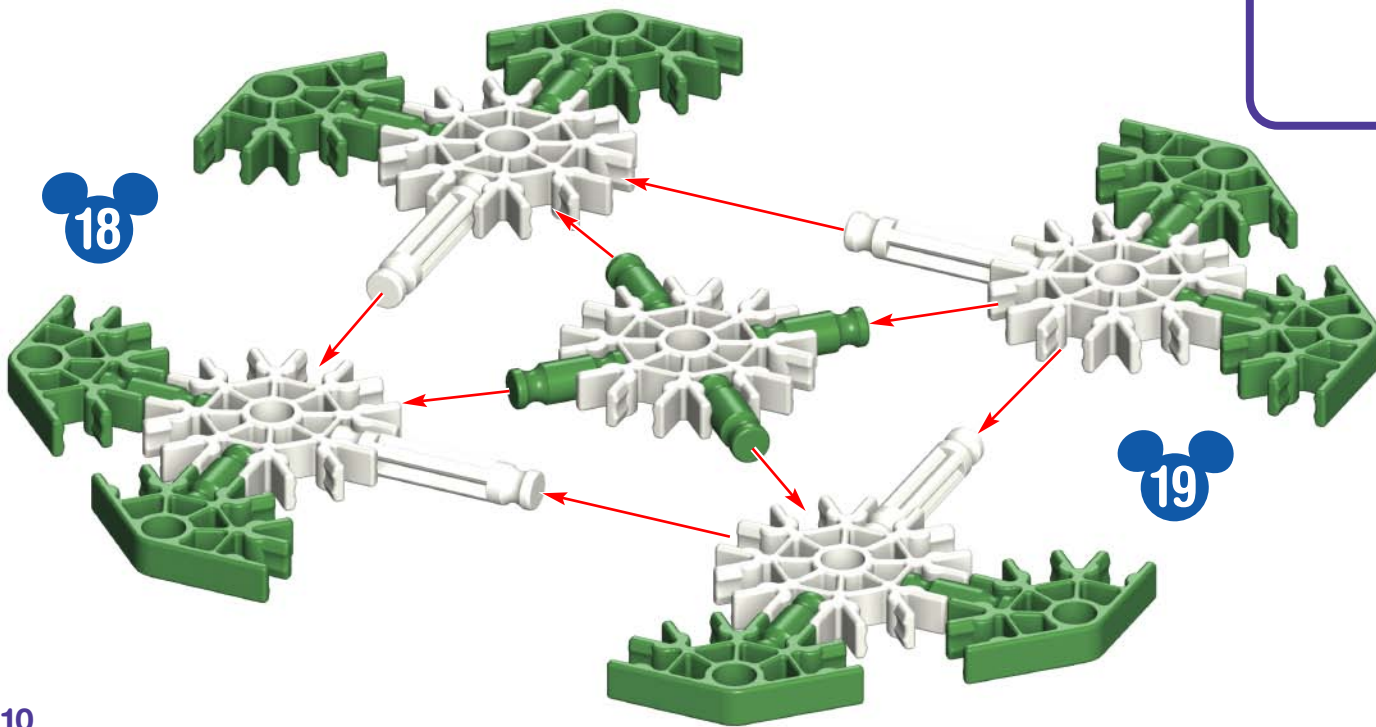
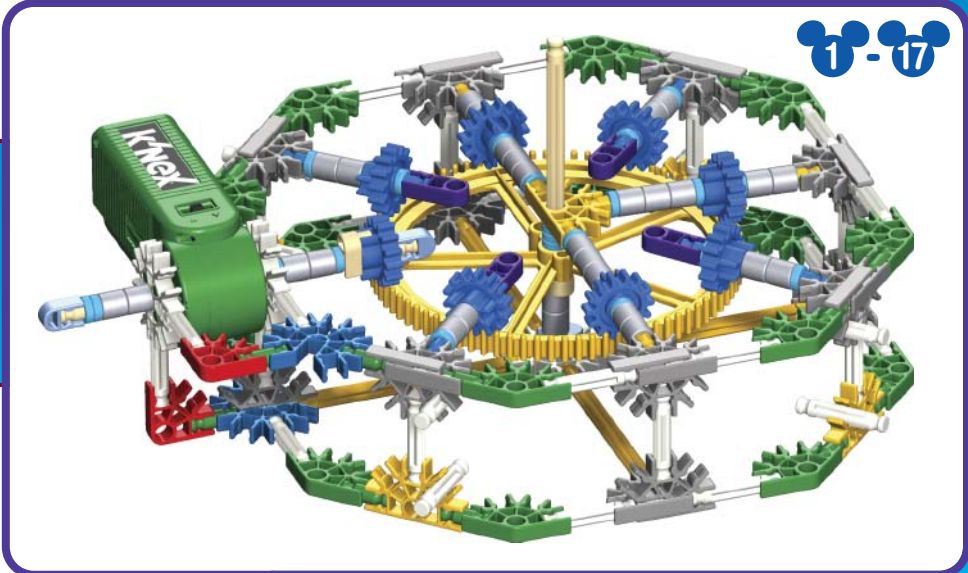
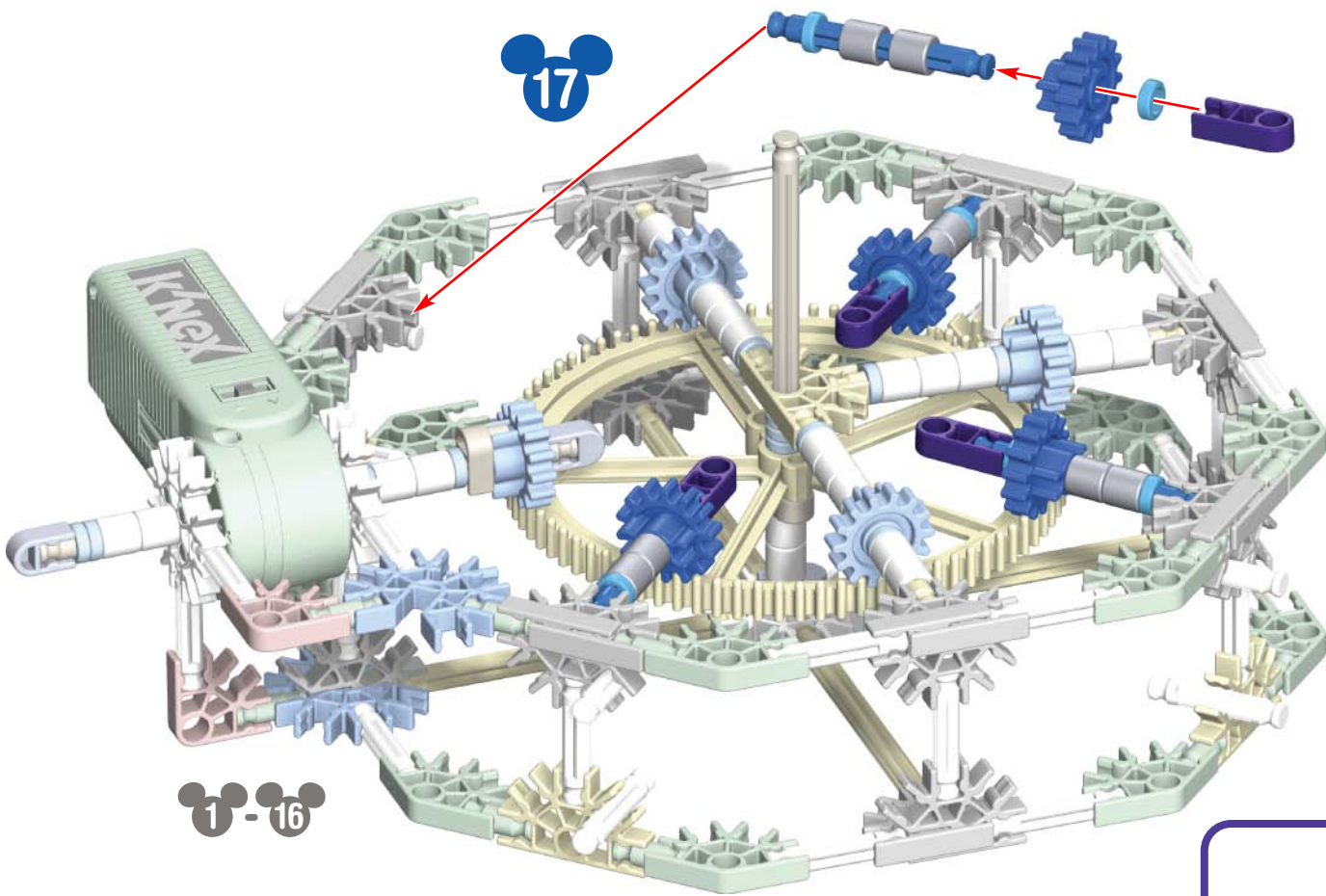

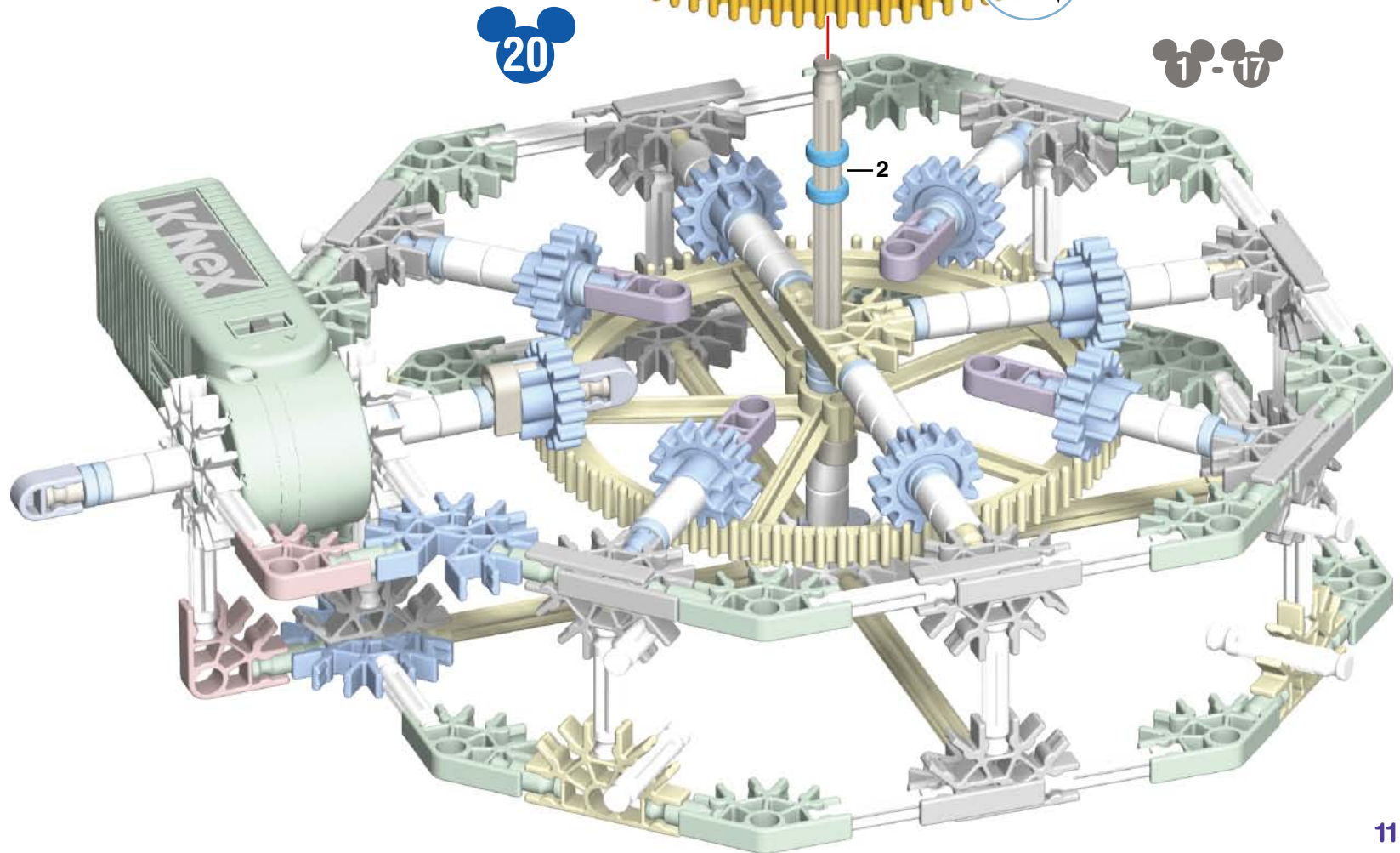
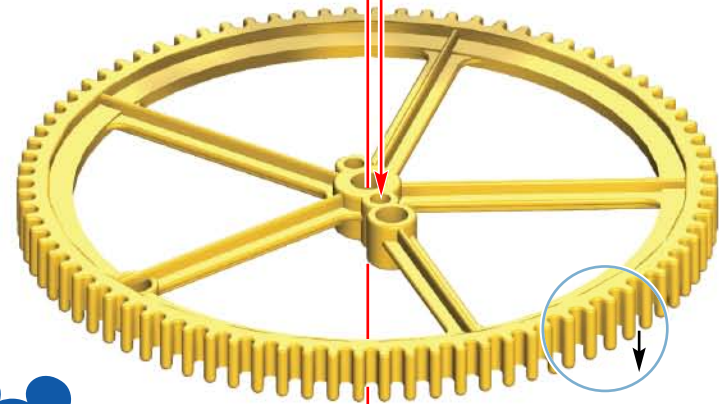
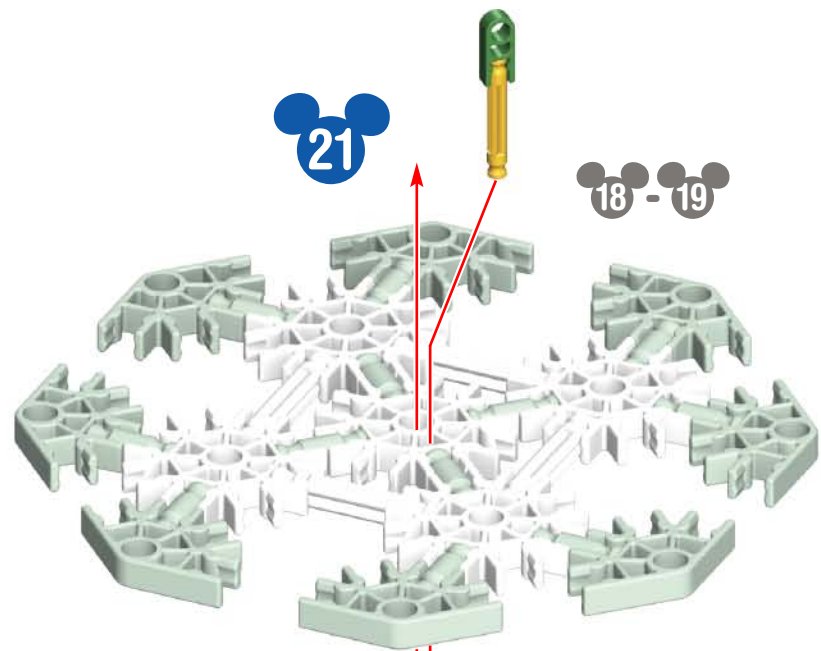

1-22



22

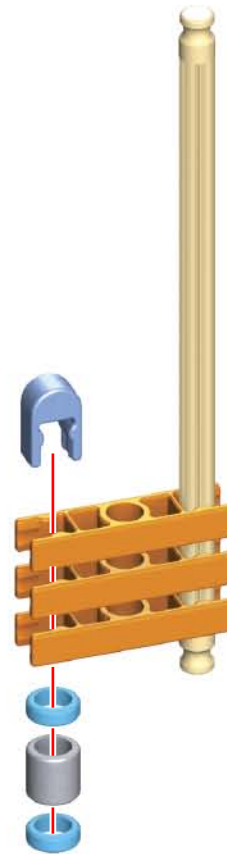

1-21

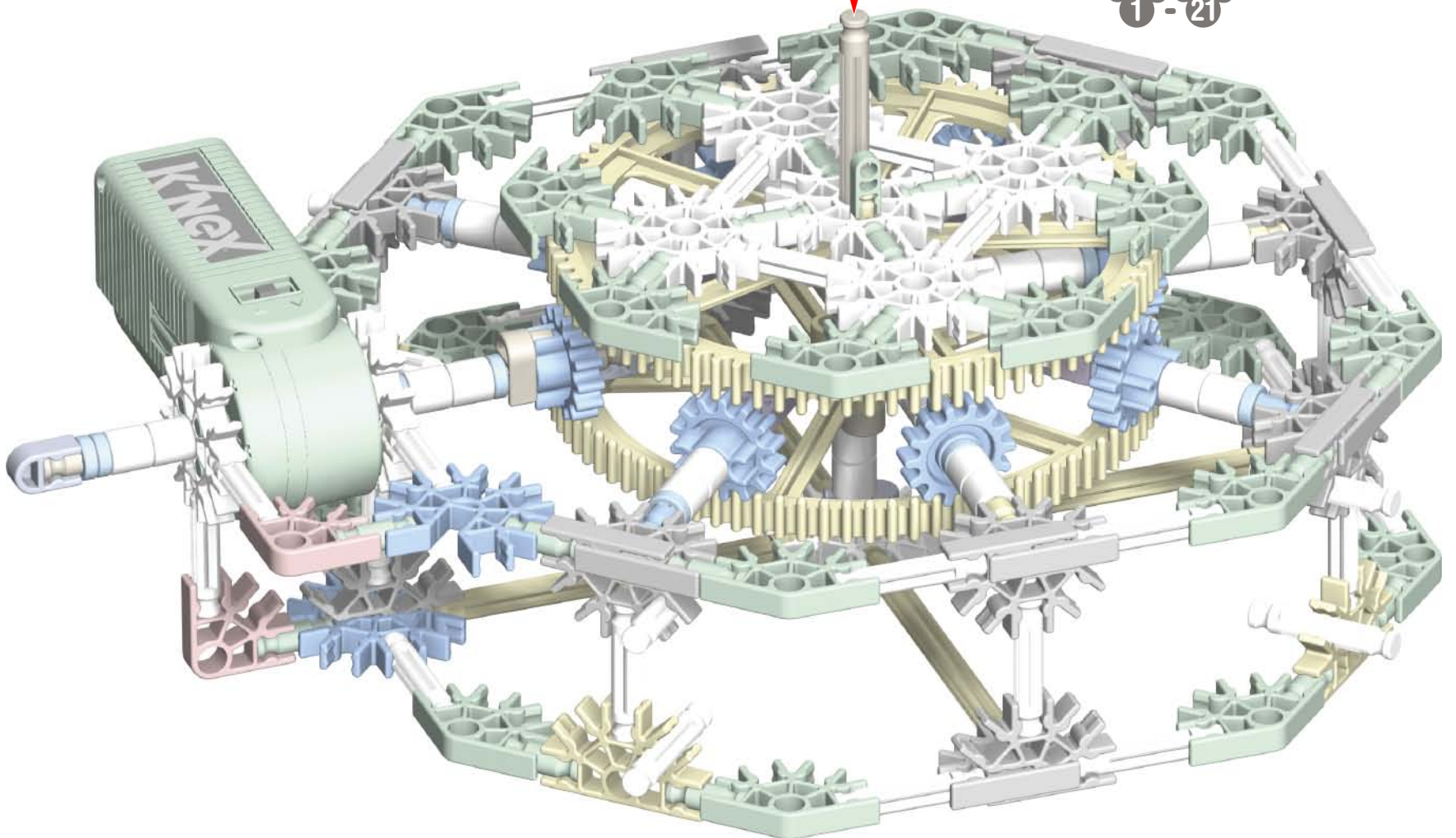

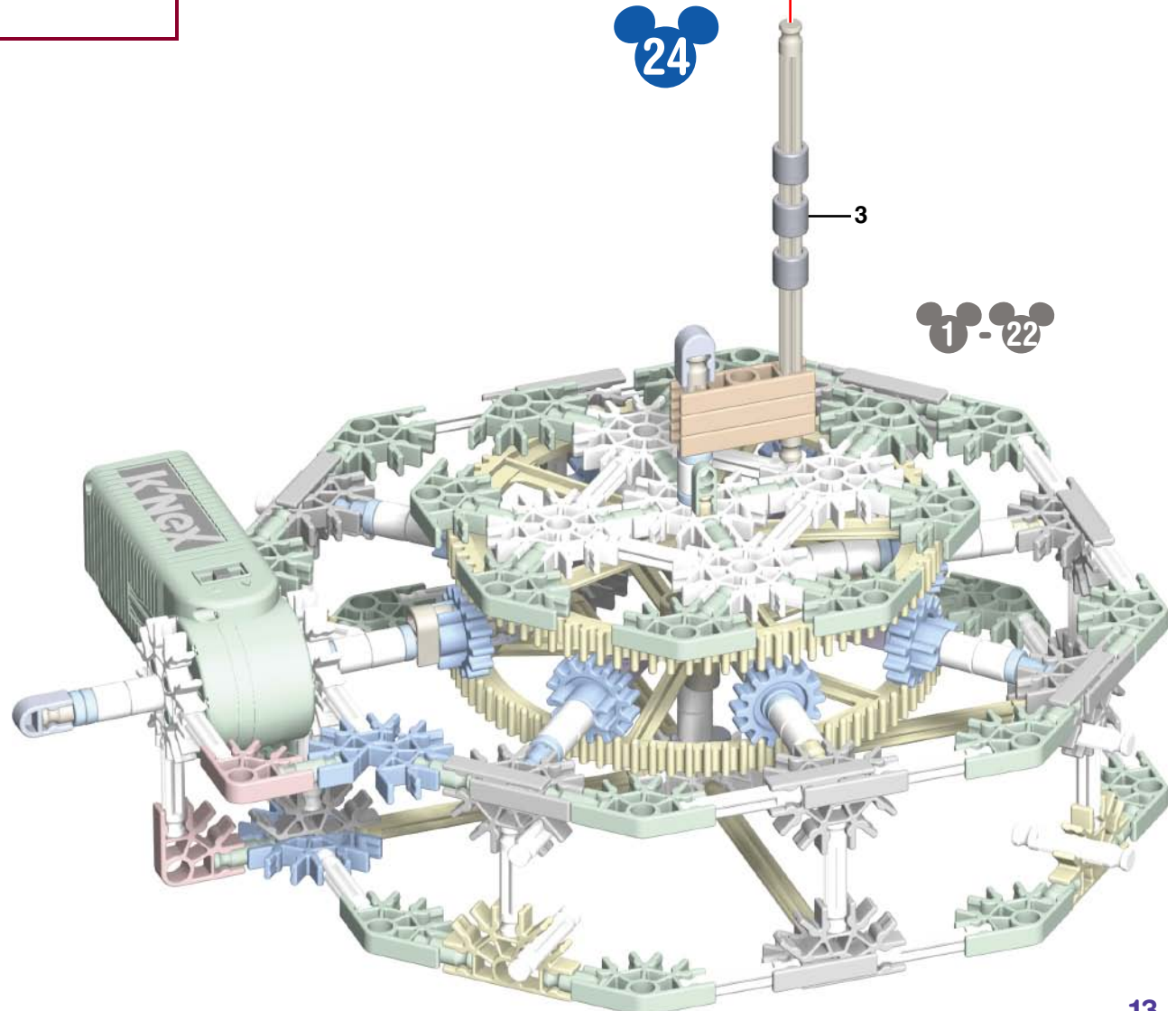
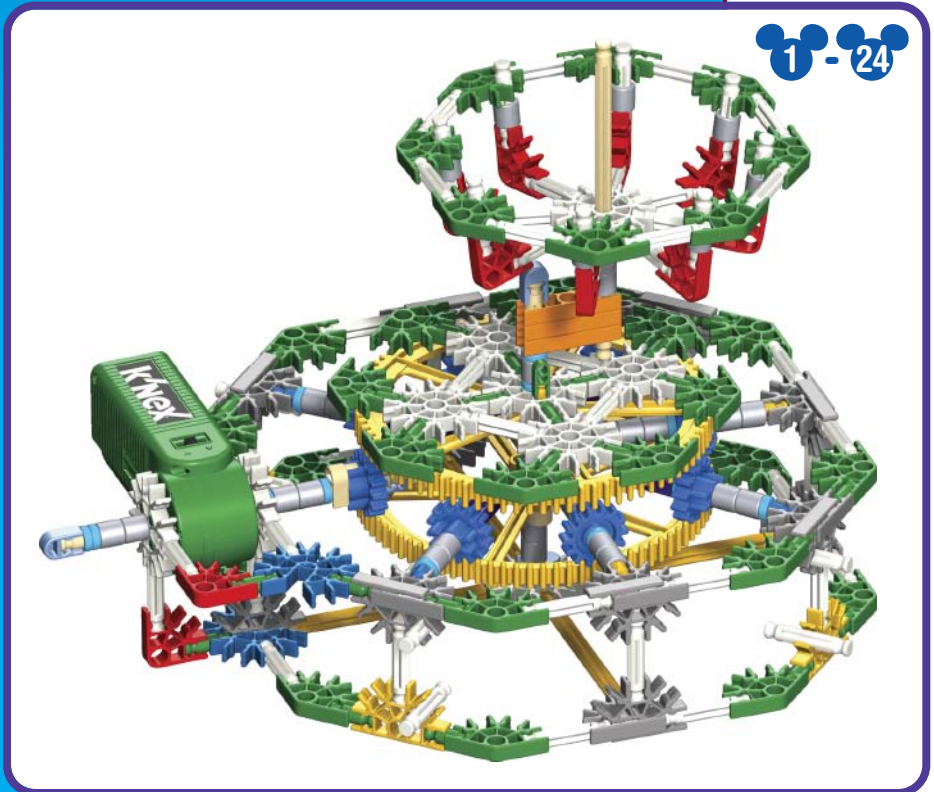
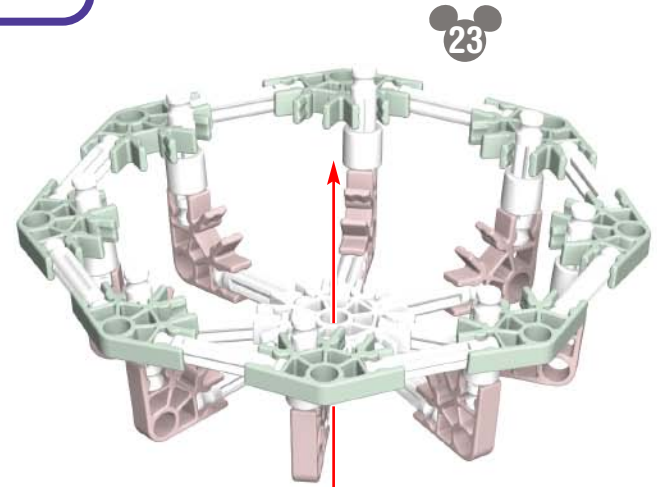
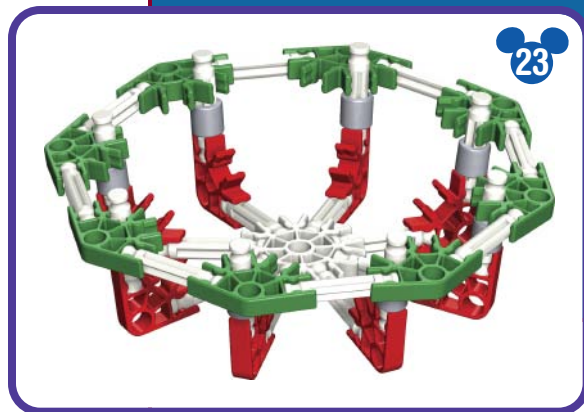
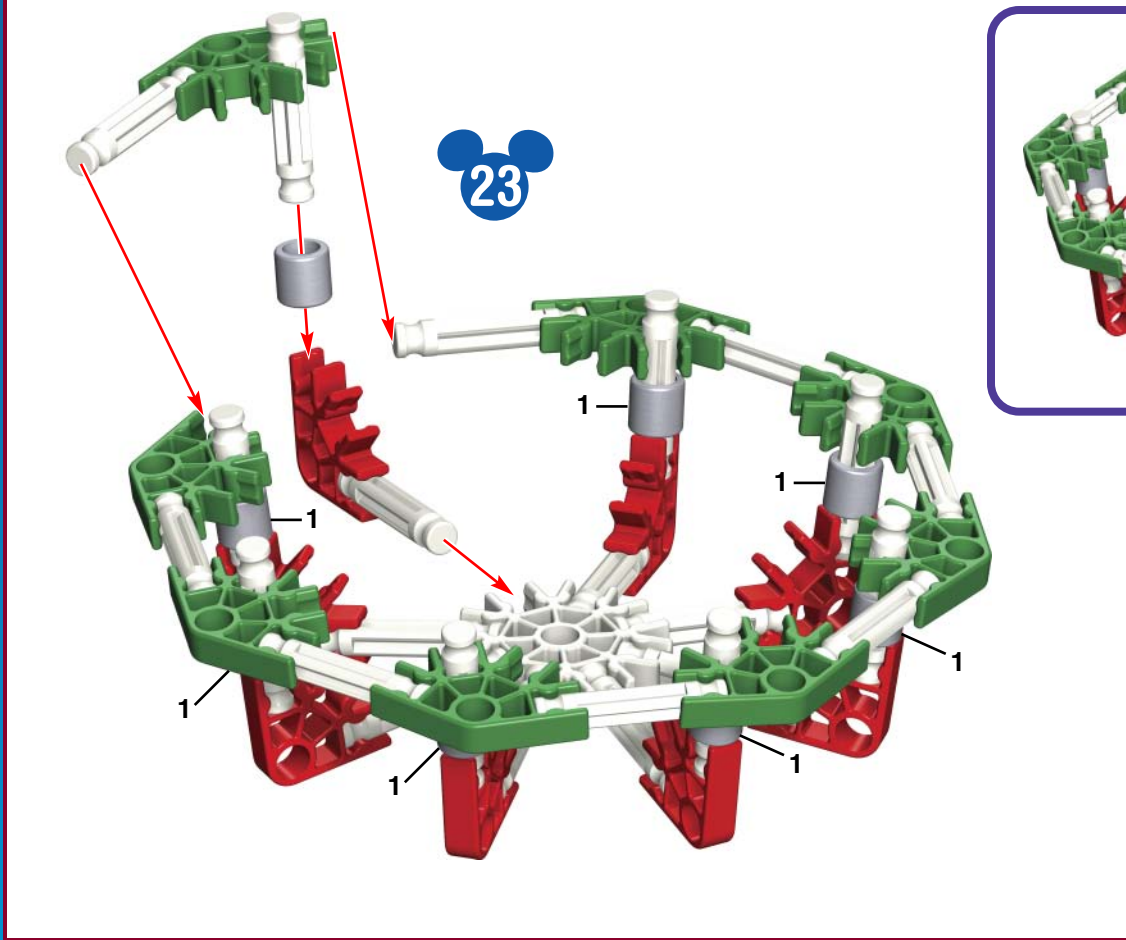

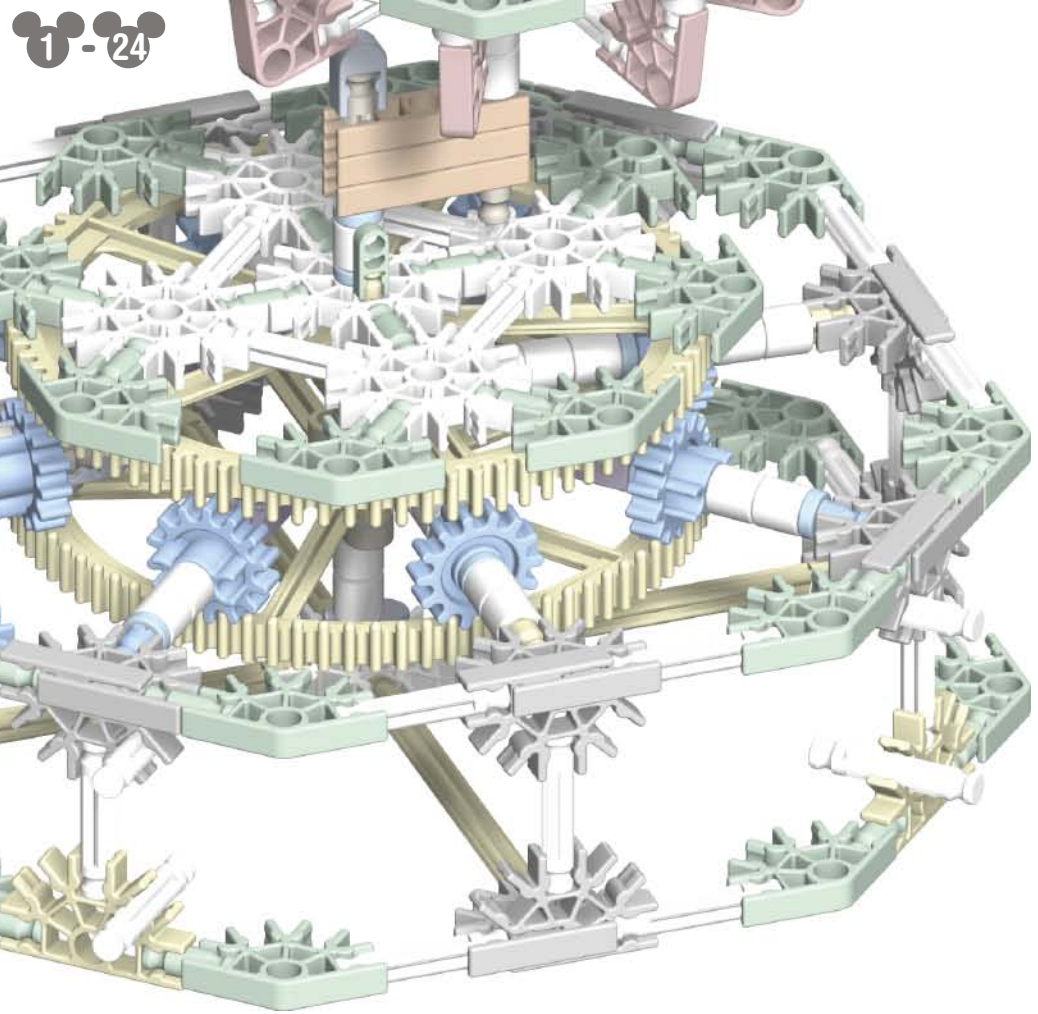
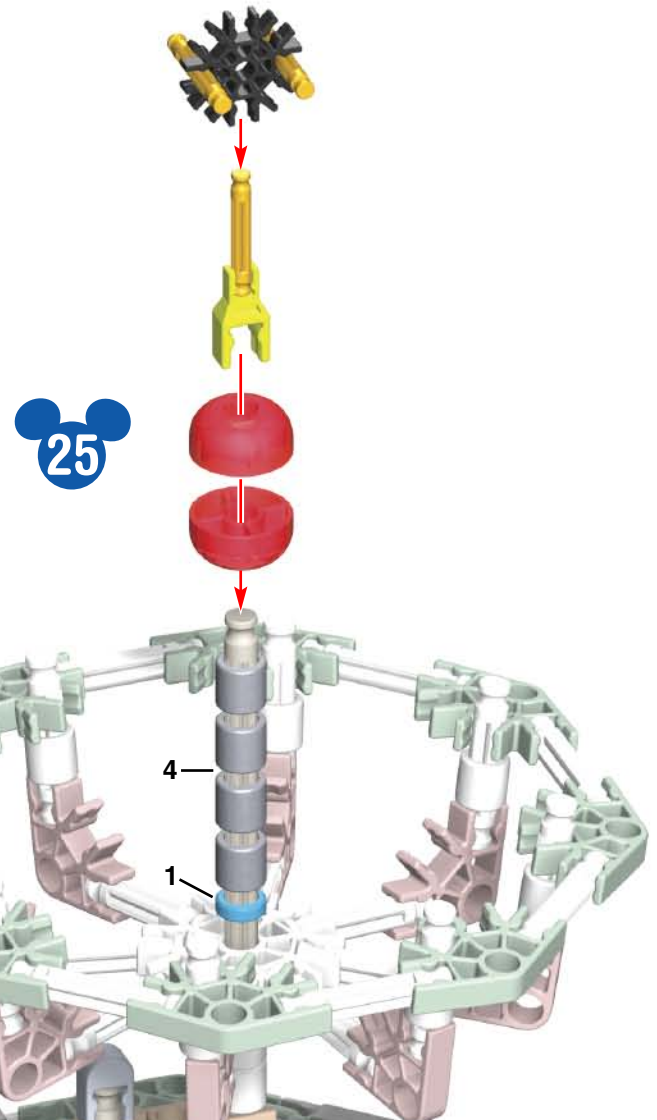

x8

x8

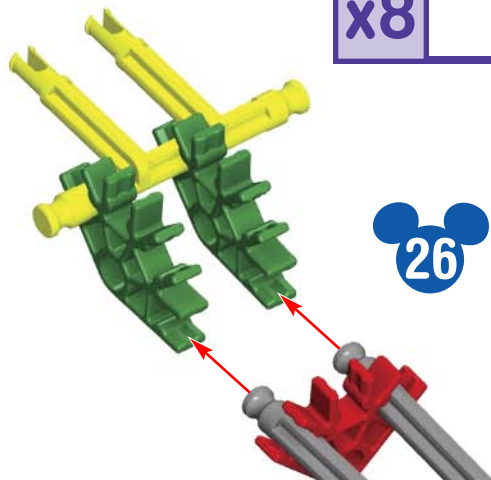

26

26 - 27



x8

27

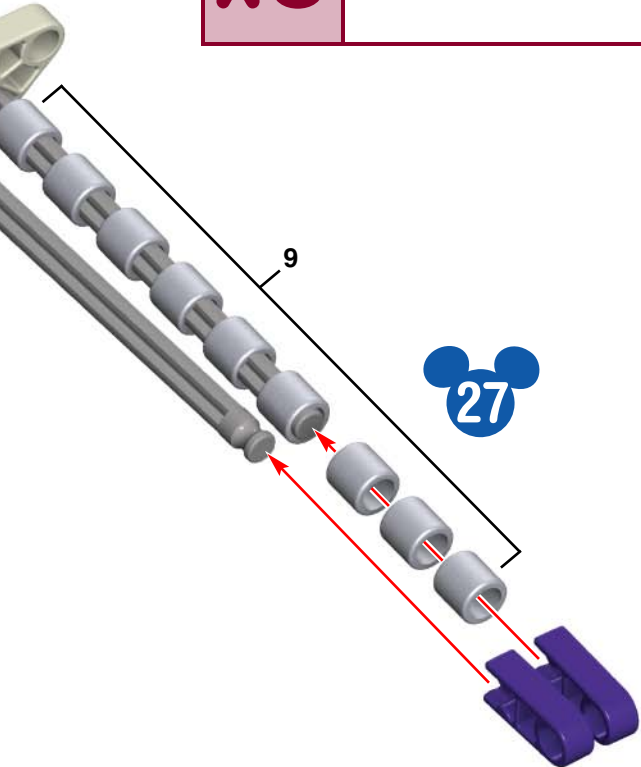

9

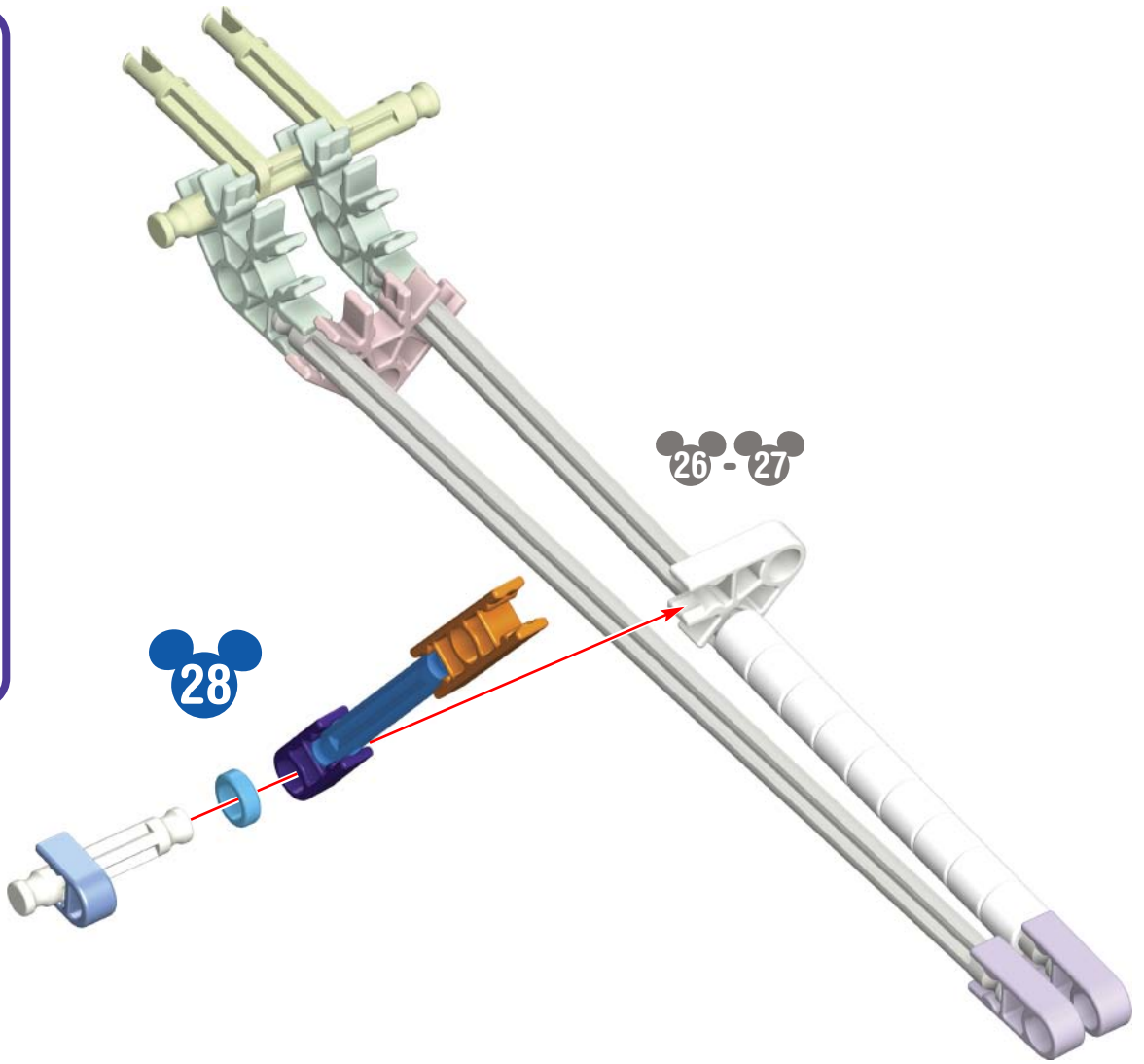

26 - 27

28

x8



26 - 28

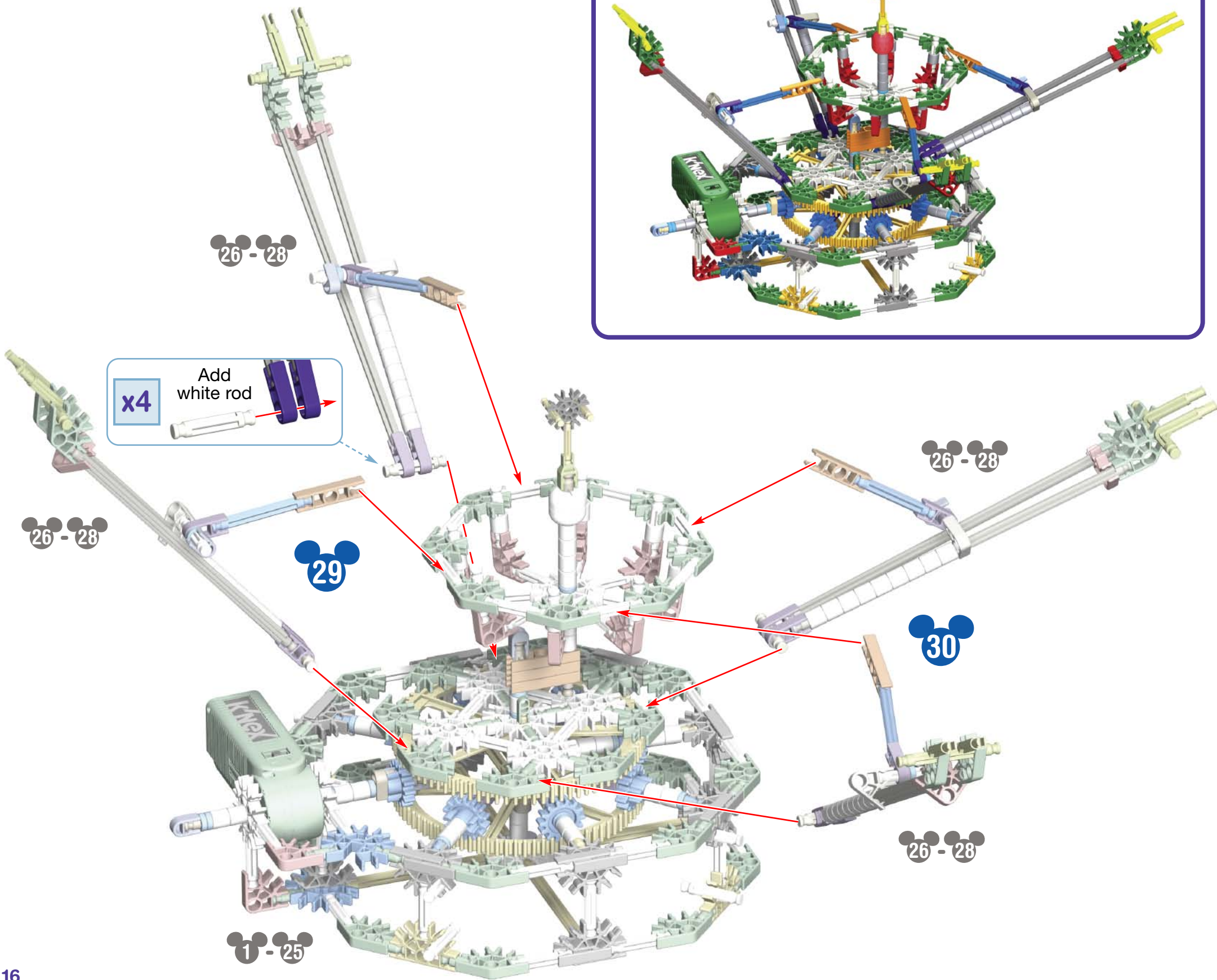

1-34

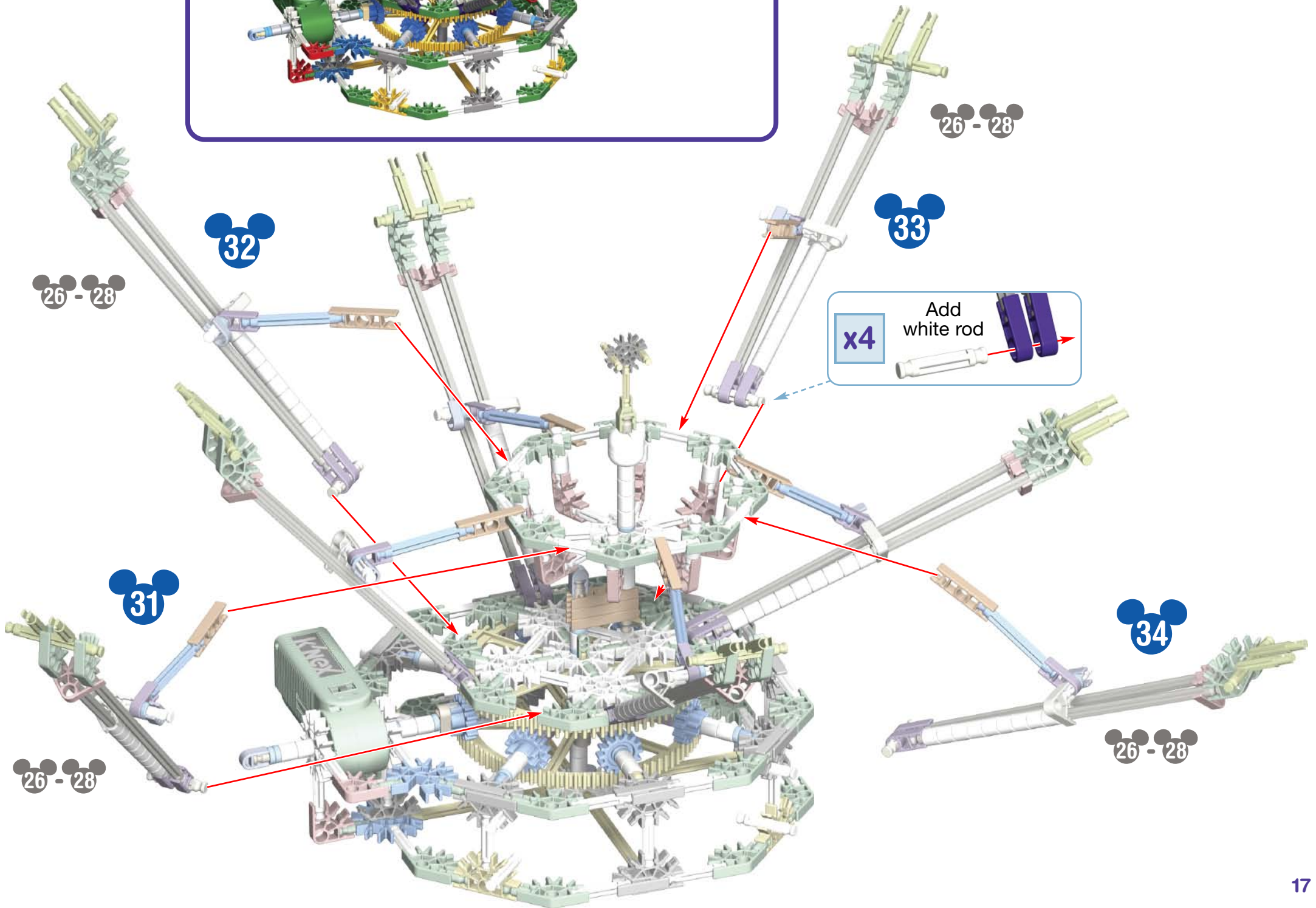
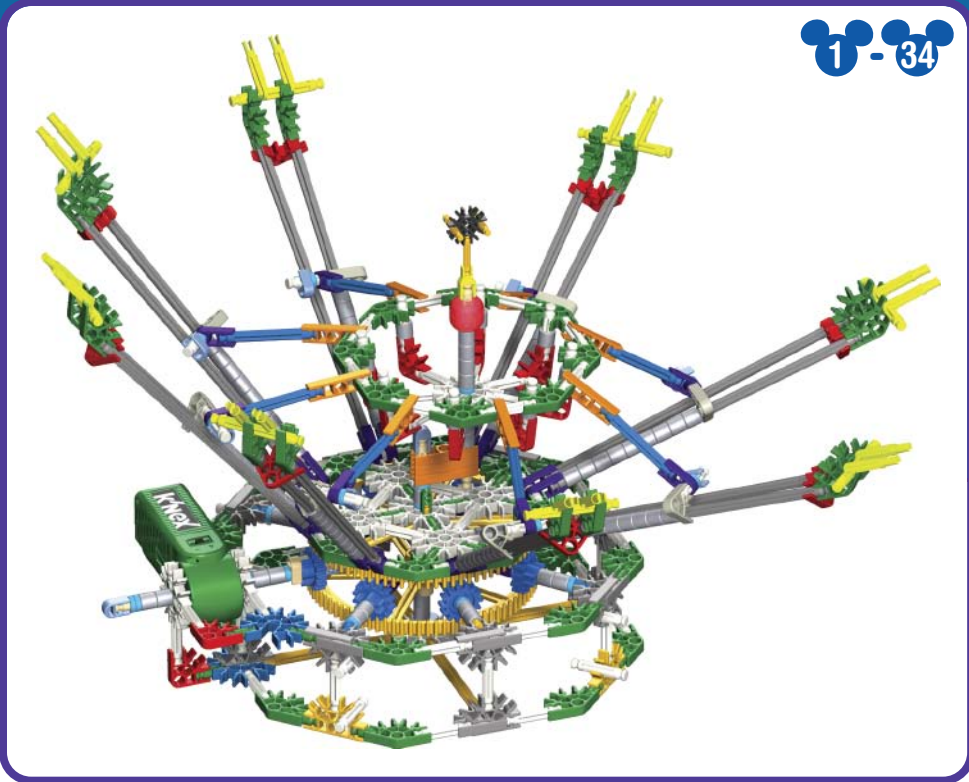

26-28

32

33

26-28

x4 Add white rod

31

34

26-28

26-28

x8

x8

x8

35 - 38

36

38

35 - 36

35

37

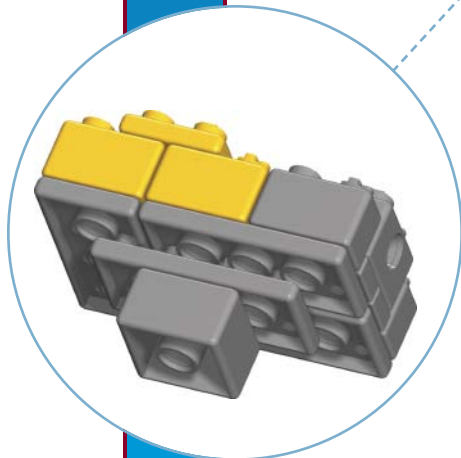

x8

35 - 38

x8

35 - 36

x8

35 - 39

39

35 - 39

x8

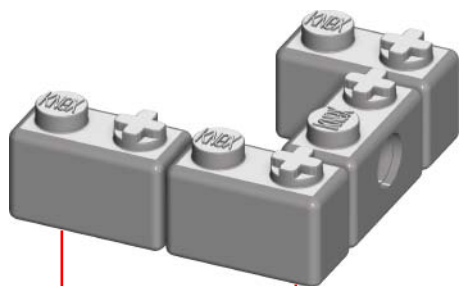

40

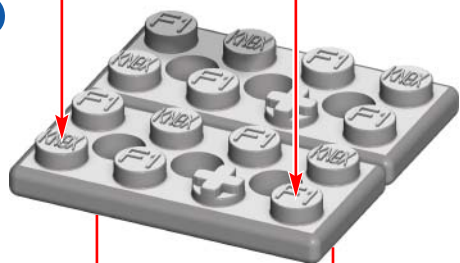

x8

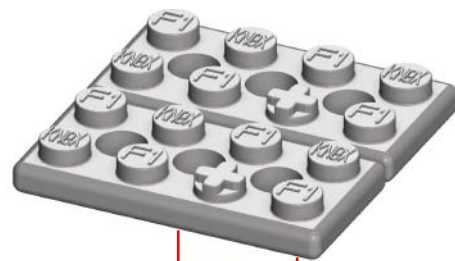

41

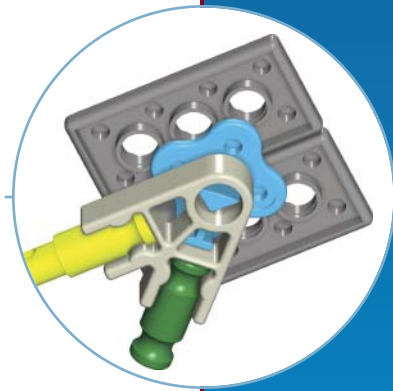
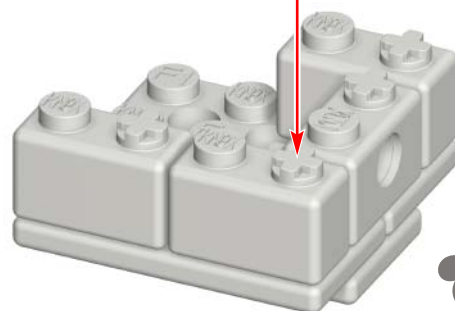
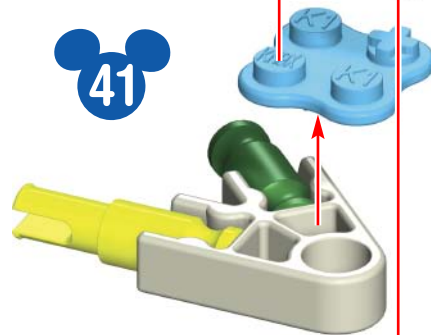

x8



40

x8



40-41

x8

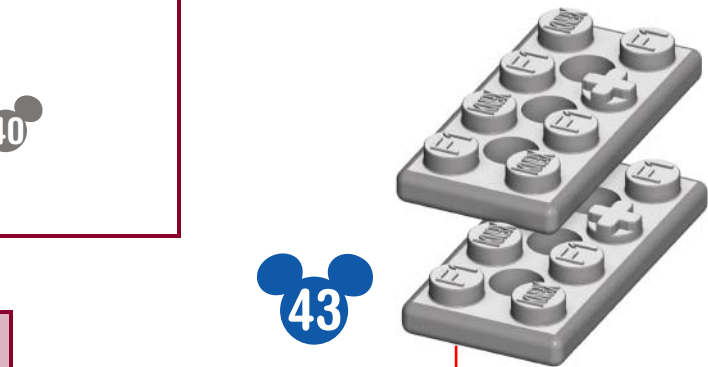

43

x8

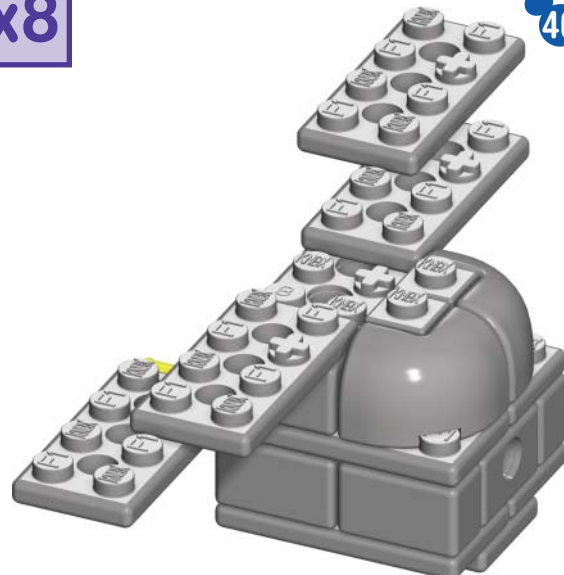

40-43

42

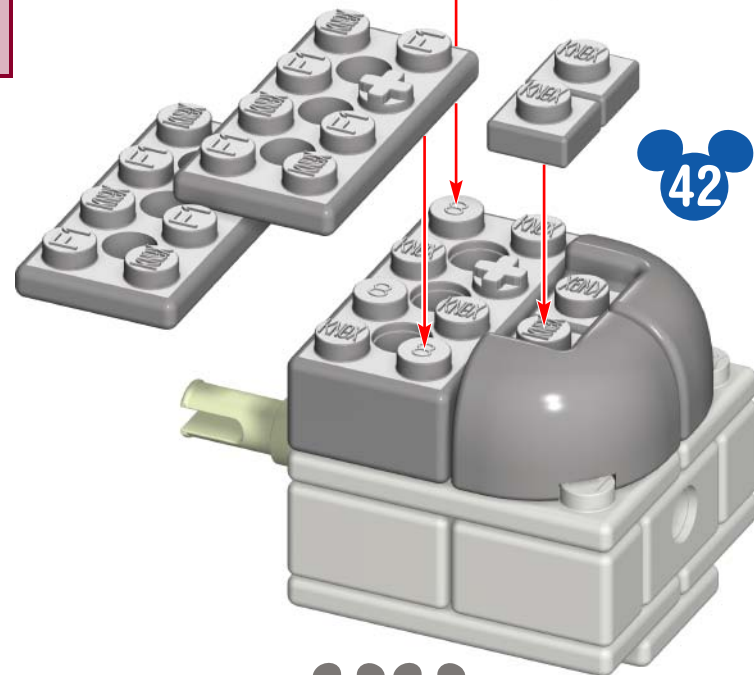

40-41

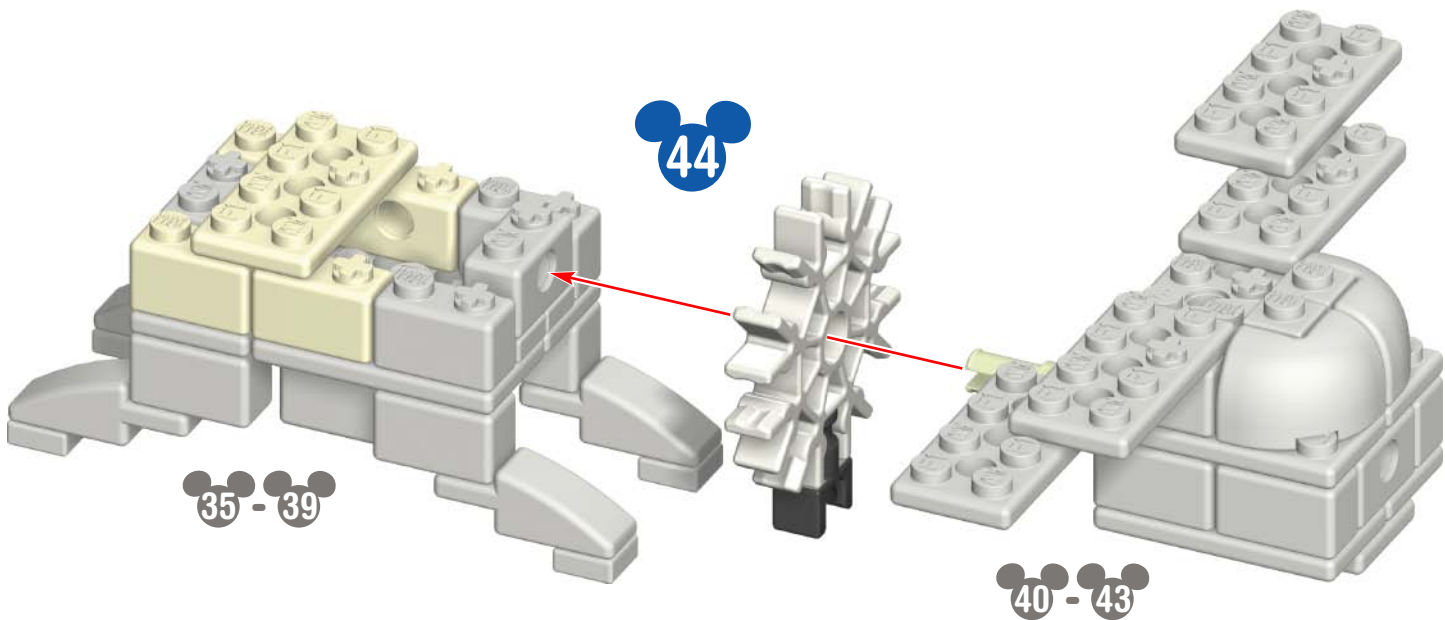

x8

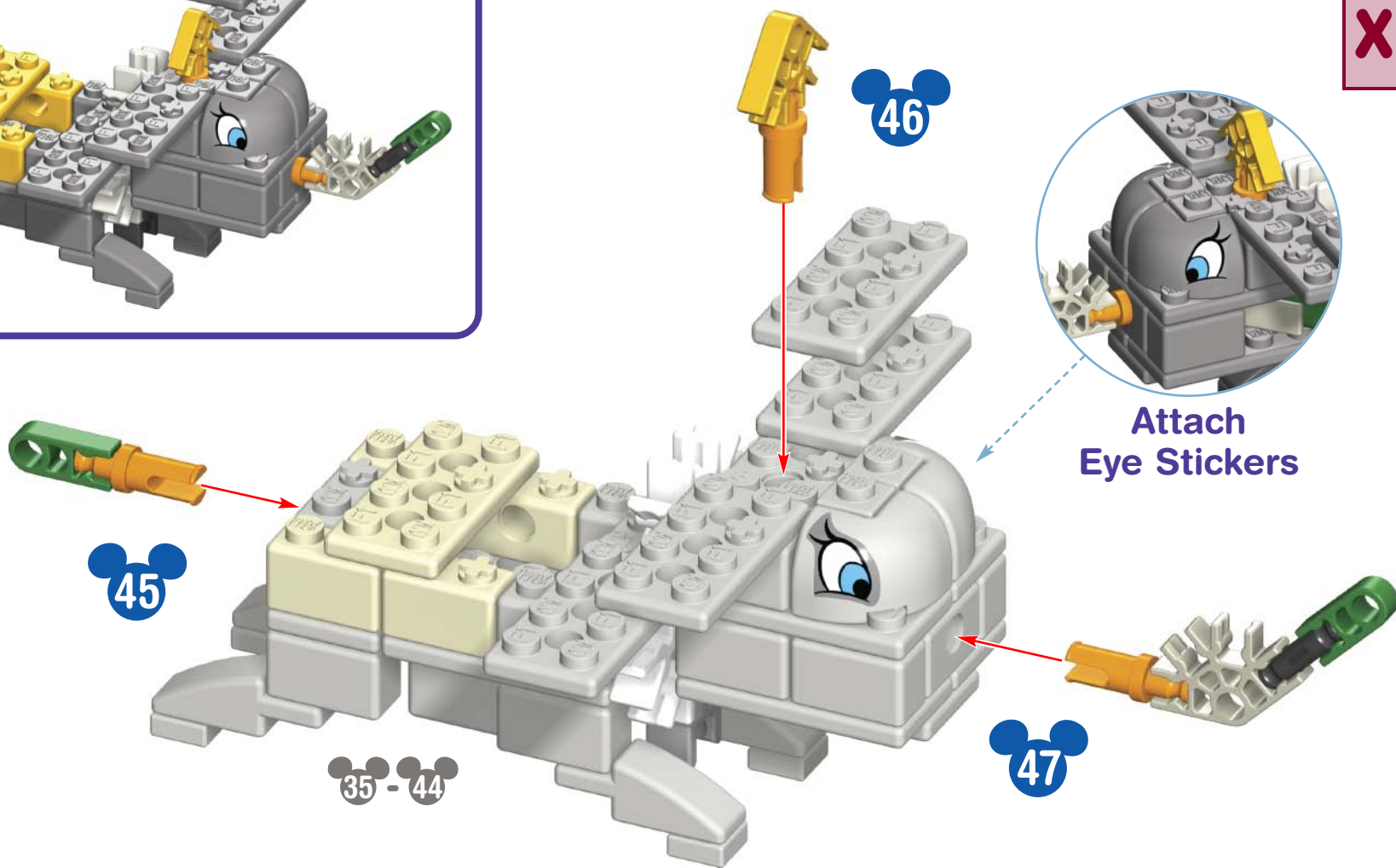

x8

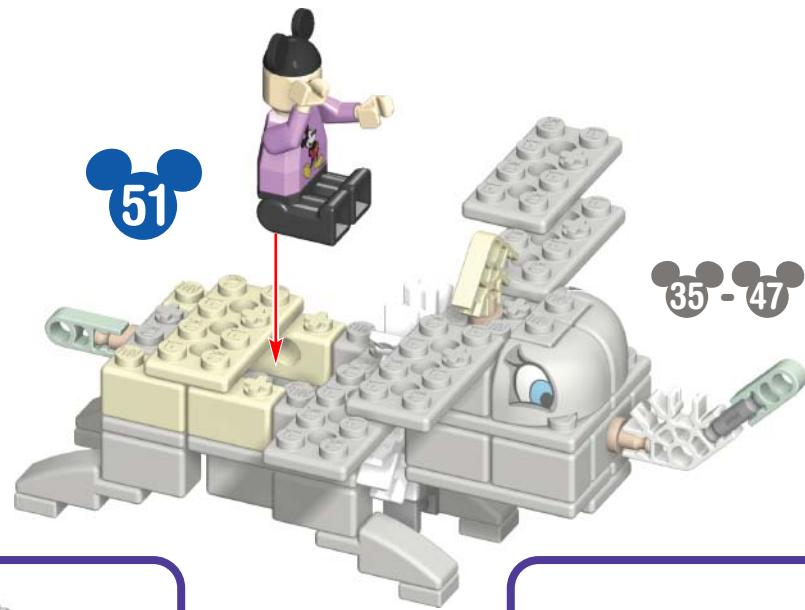
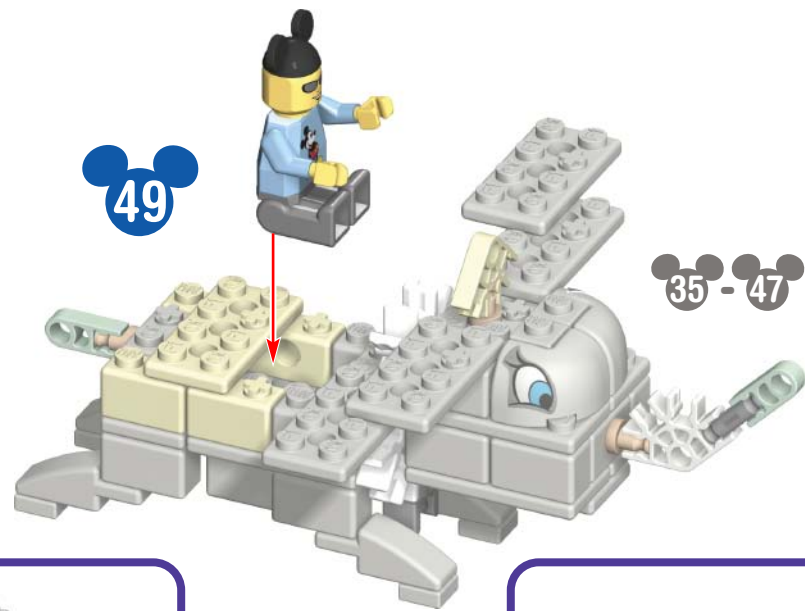

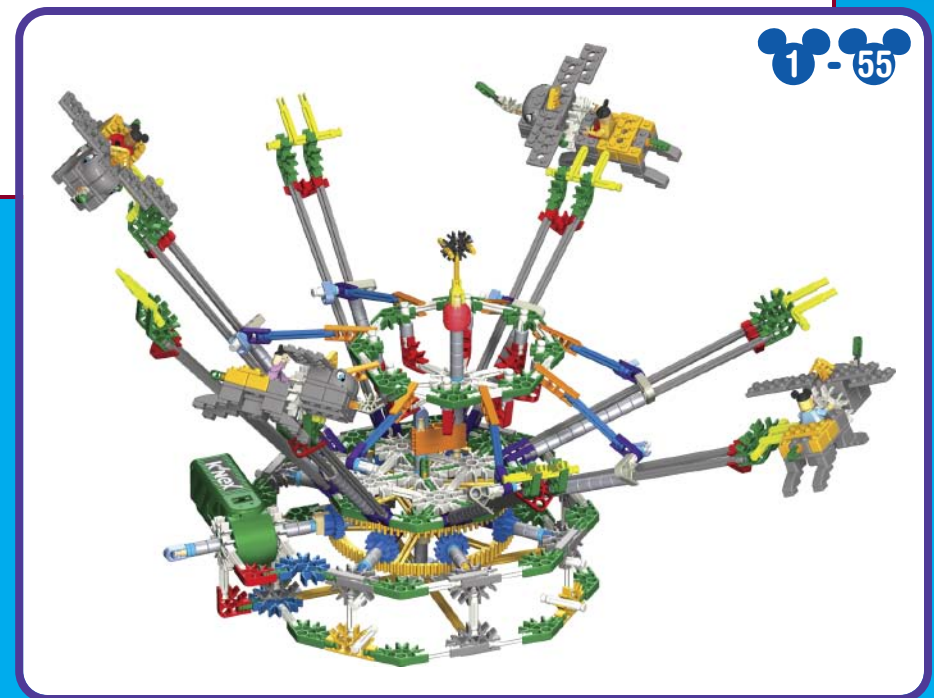
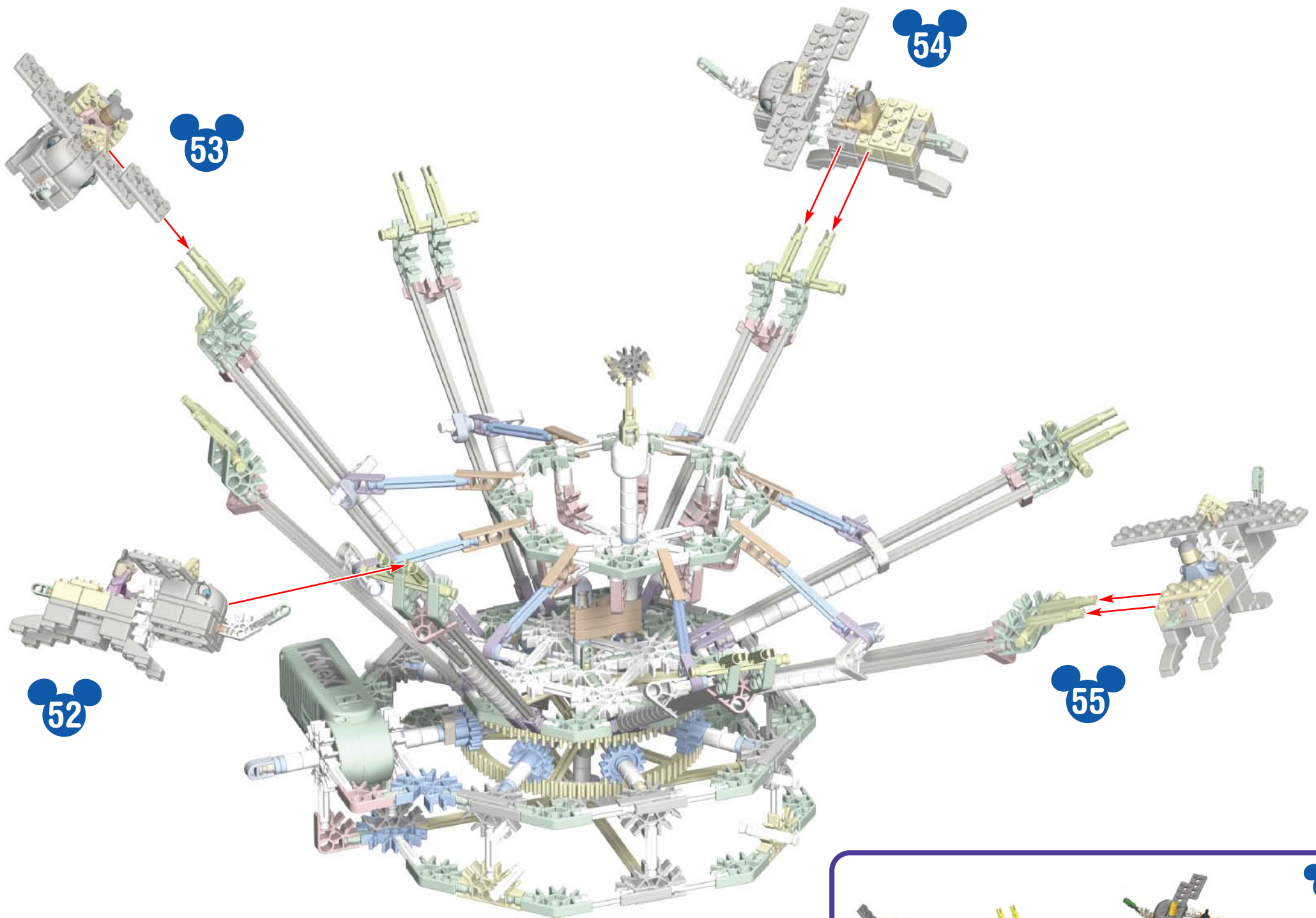

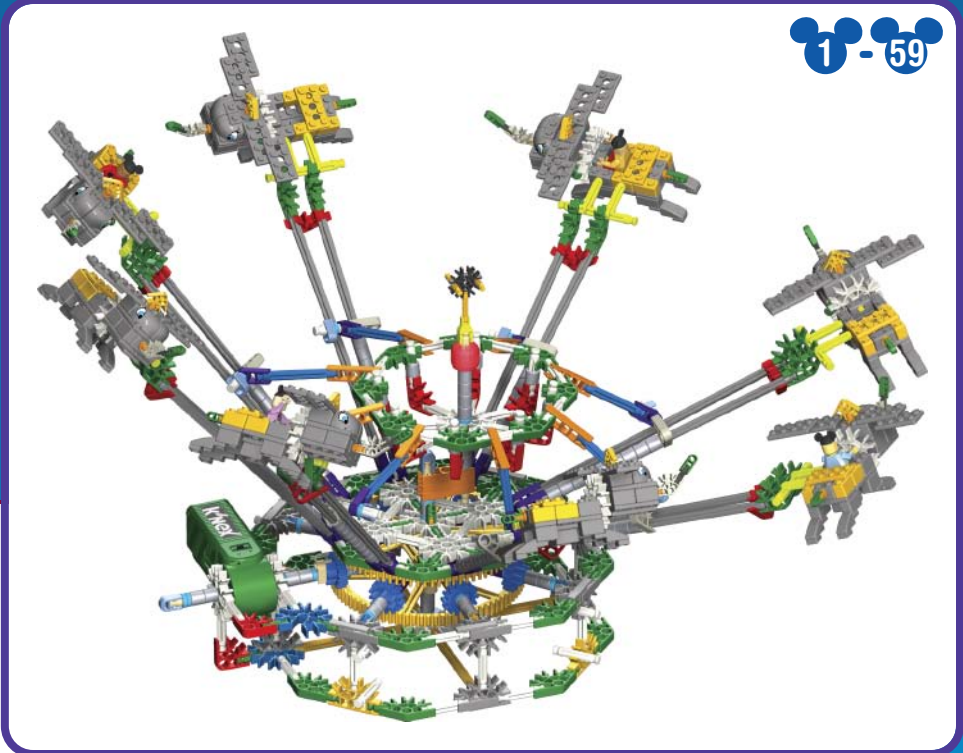

57

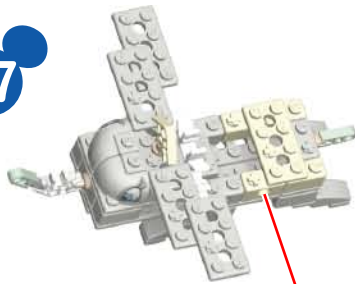

58

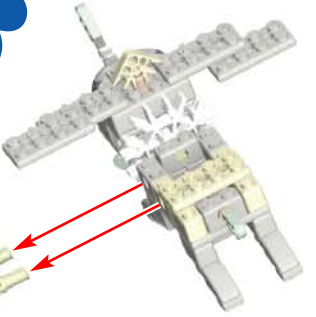

56

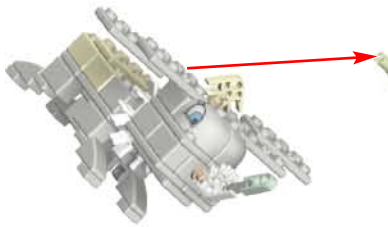

59

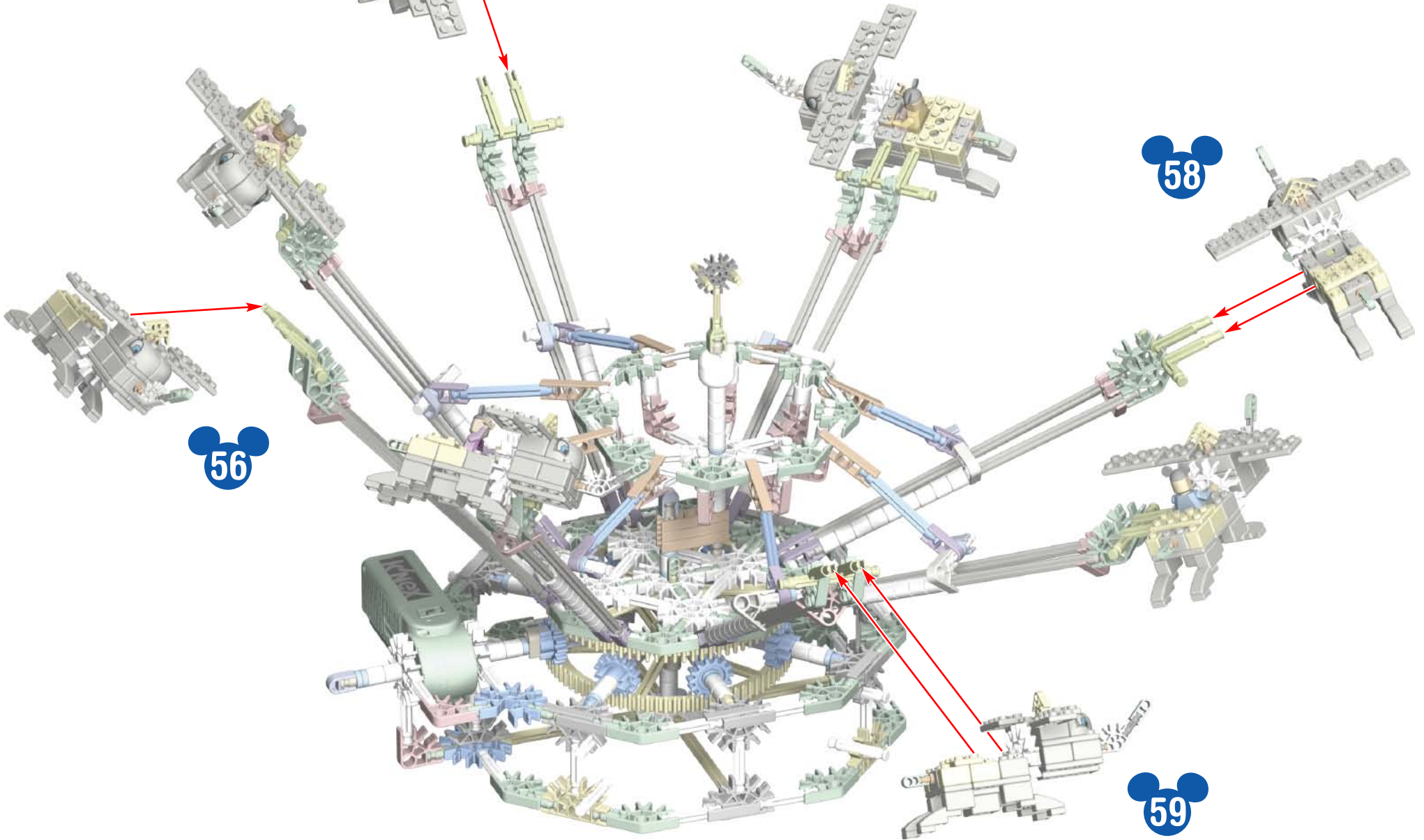
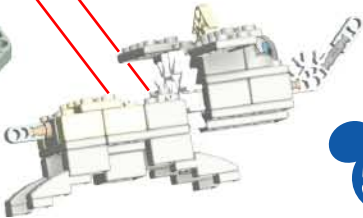



Rotate model

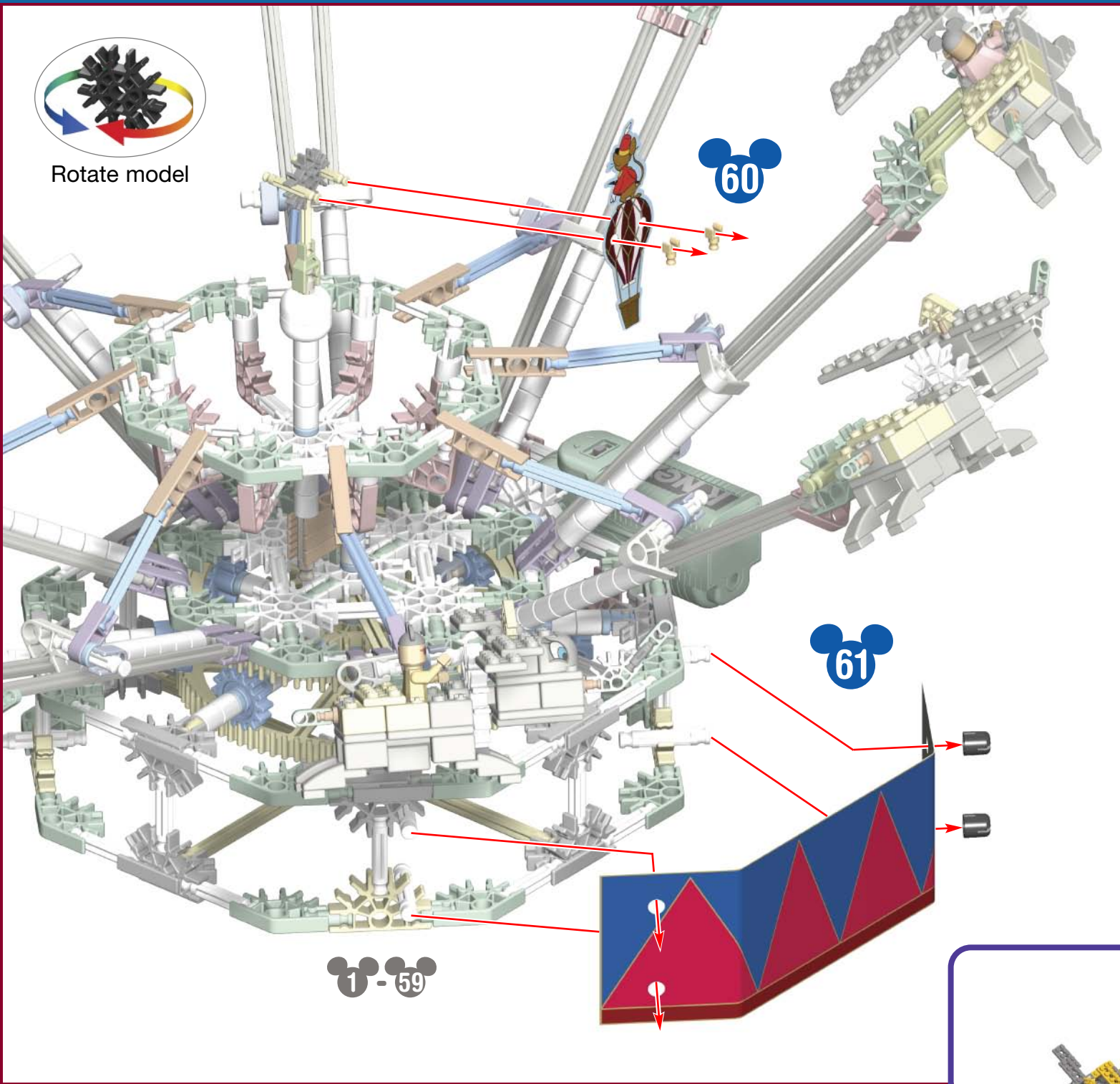

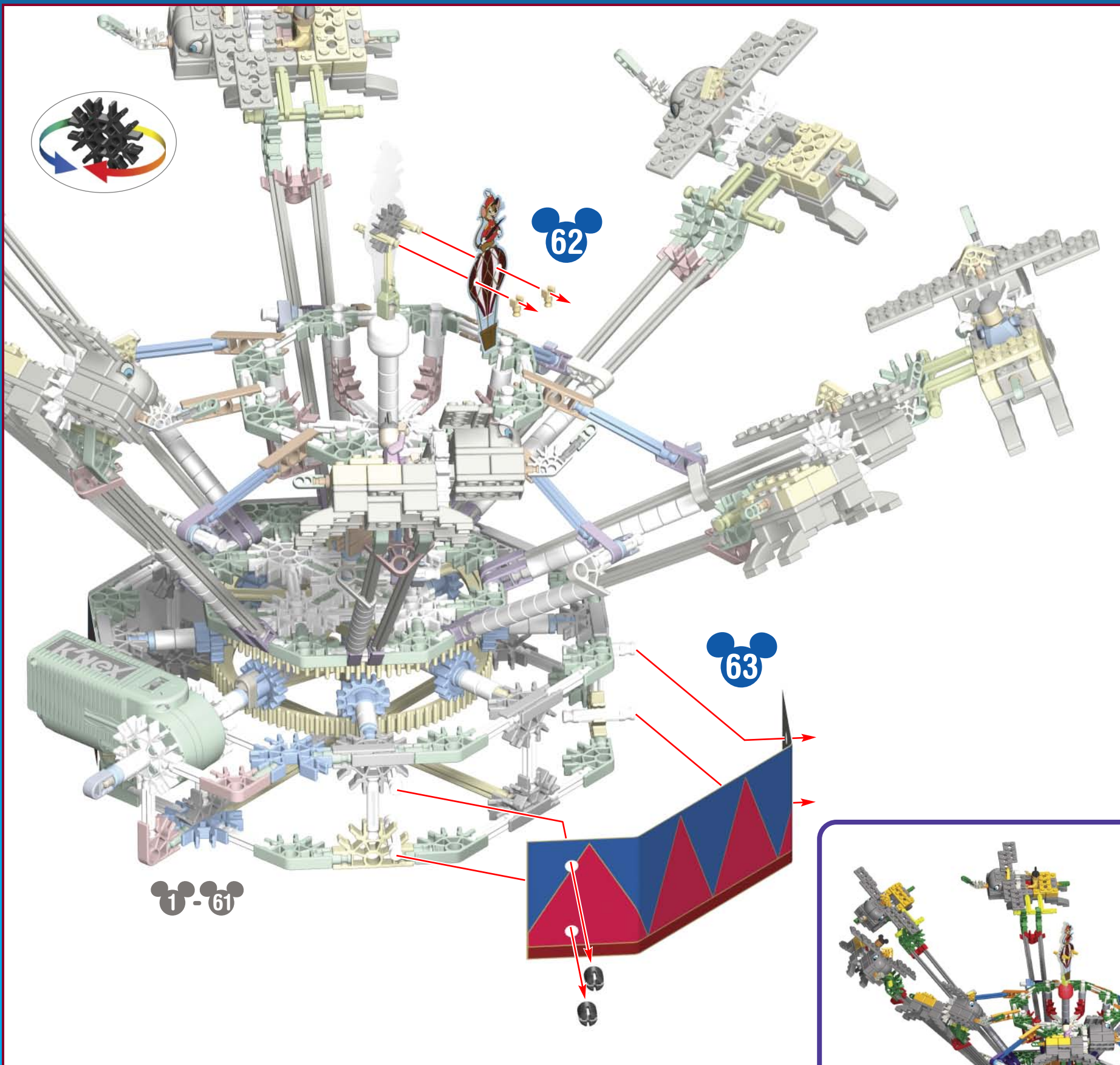

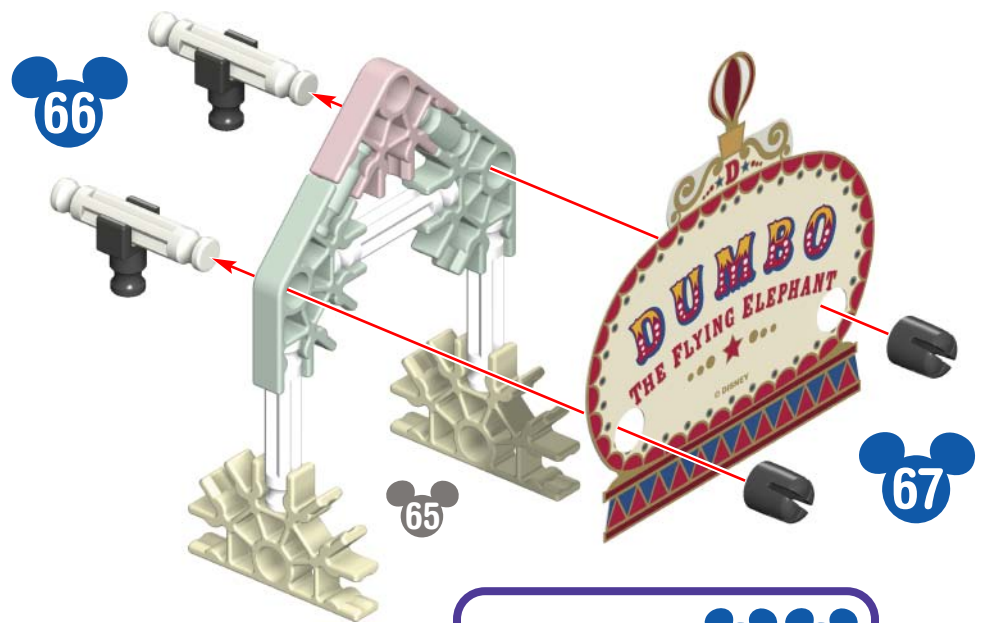
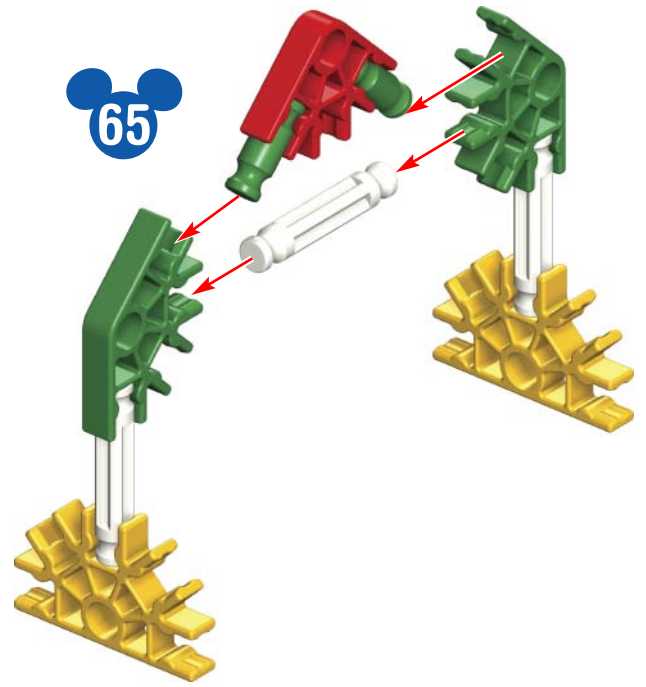
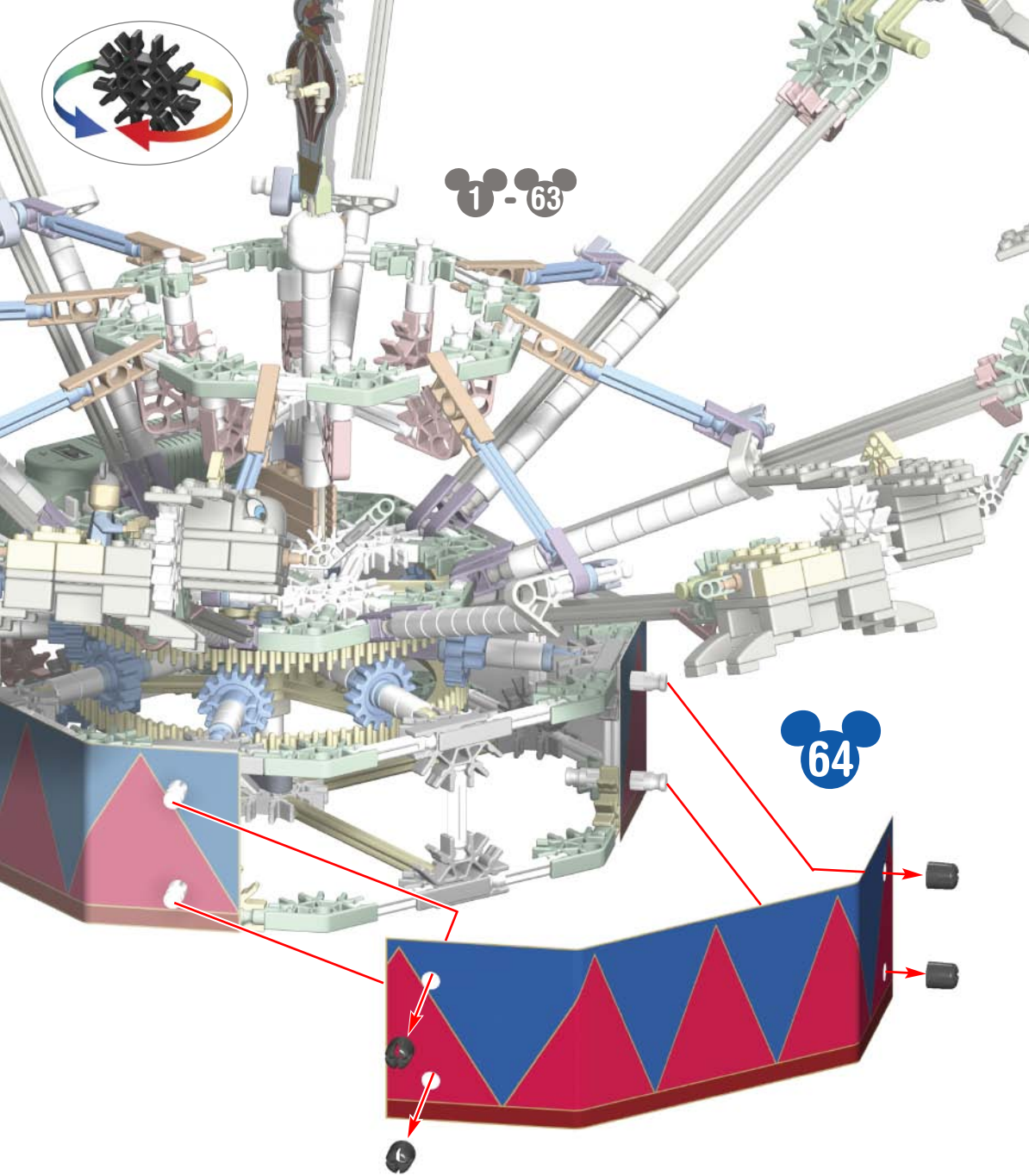



DISNEY
BUILD-IT!

Disney Parks



Space Mountain[®] Building Set



- 4+ Feet Long!
- 2 Coaster Cars!
- 25+ Feet of Track!

Glow-In-The-Dark Track!

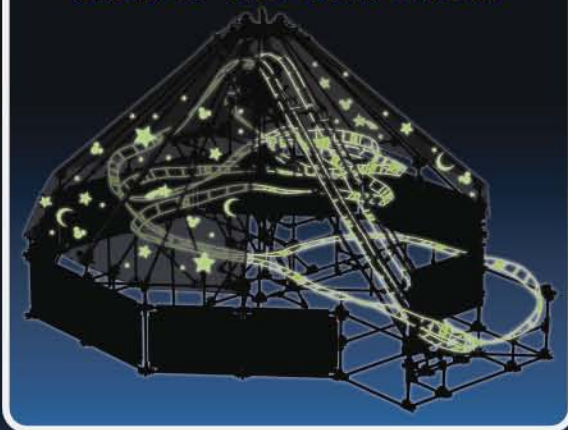

Motorized Performance!



**Also Available
from Disney Parks & K'NEX.
Set Sold Separately.**

Disney.com
Disney Theme Park Merchandise
Lake Buena Vista, FL 32830
©DISNEY

Product & colors may vary. Most models can be built one at a time.
K'NEX is a registered trademark of K'NEX Limited Partnership Group.
Manufactured under U.S. Patents 5,061,219; 5,199,919; 5,350,331;
5,137,486; D393,417; 5,346,420; 7,267,598; D550,782; D553,201; D553,203;
D553,204; 000645538-001-0002. Other U.S. and foreign patents pending.

K'NEX Customer Service
Call: 1-800-KID-KNEX (USA/CAN only)
Email: email@knex.com
Online: www.knex.com

©2010 K'NEX Limited
Partnership Group
P.O. Box 700
Hatfield, PA 19440-0700



410456.11-V1-12/09