

# K'NEX

## WILD WARP ROLLER COASTER

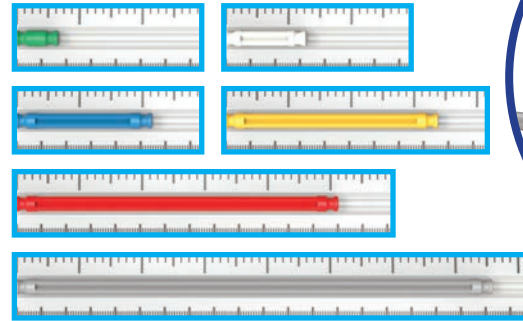

These ruler images will show you the approximate placement of parts. When you see this callout, use the rod shown on the ruler as a measurement guide for proper placement.



(example)

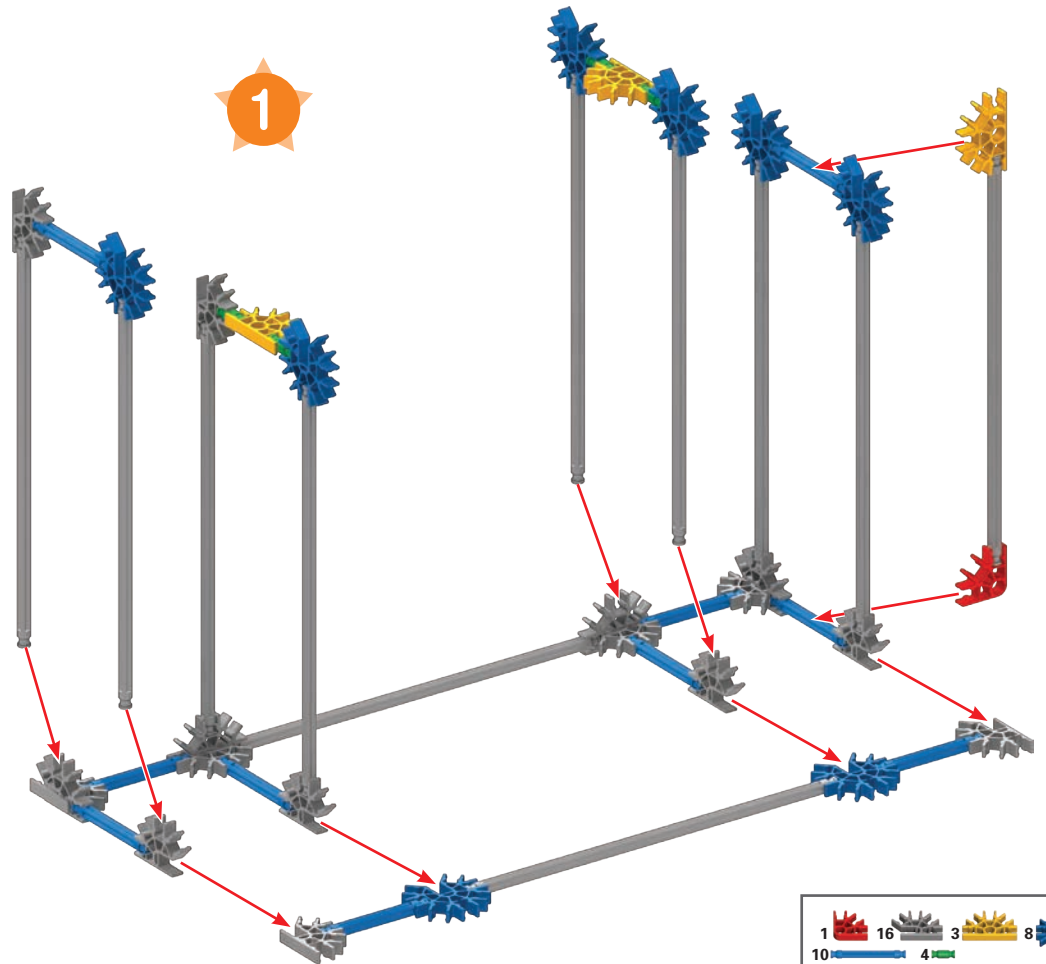
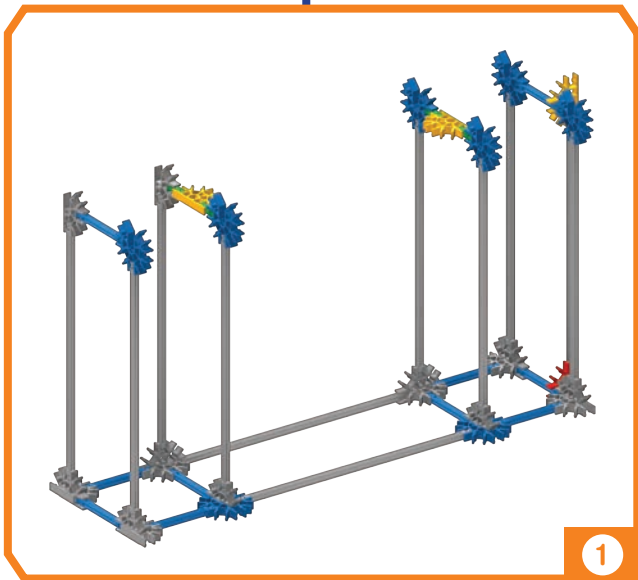

1	16	3	8
10	4		
11			

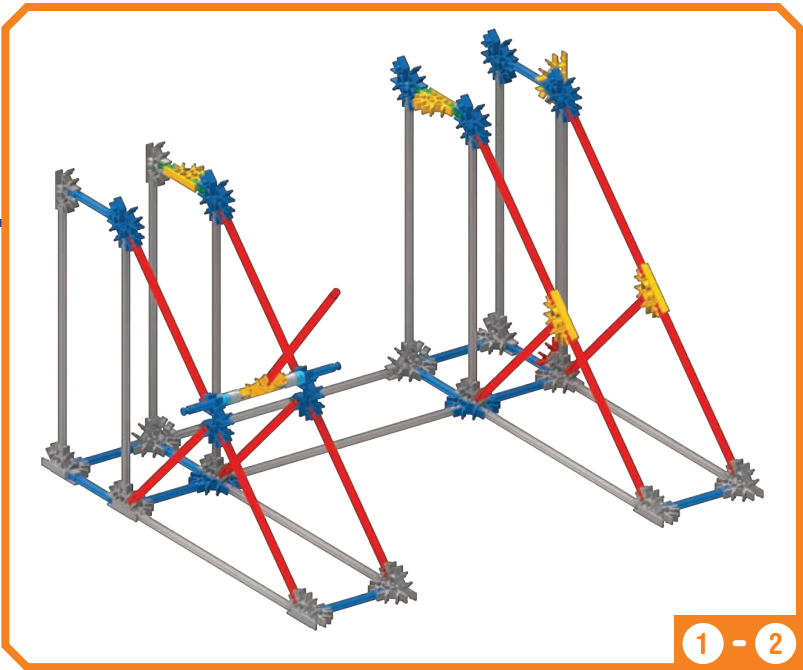
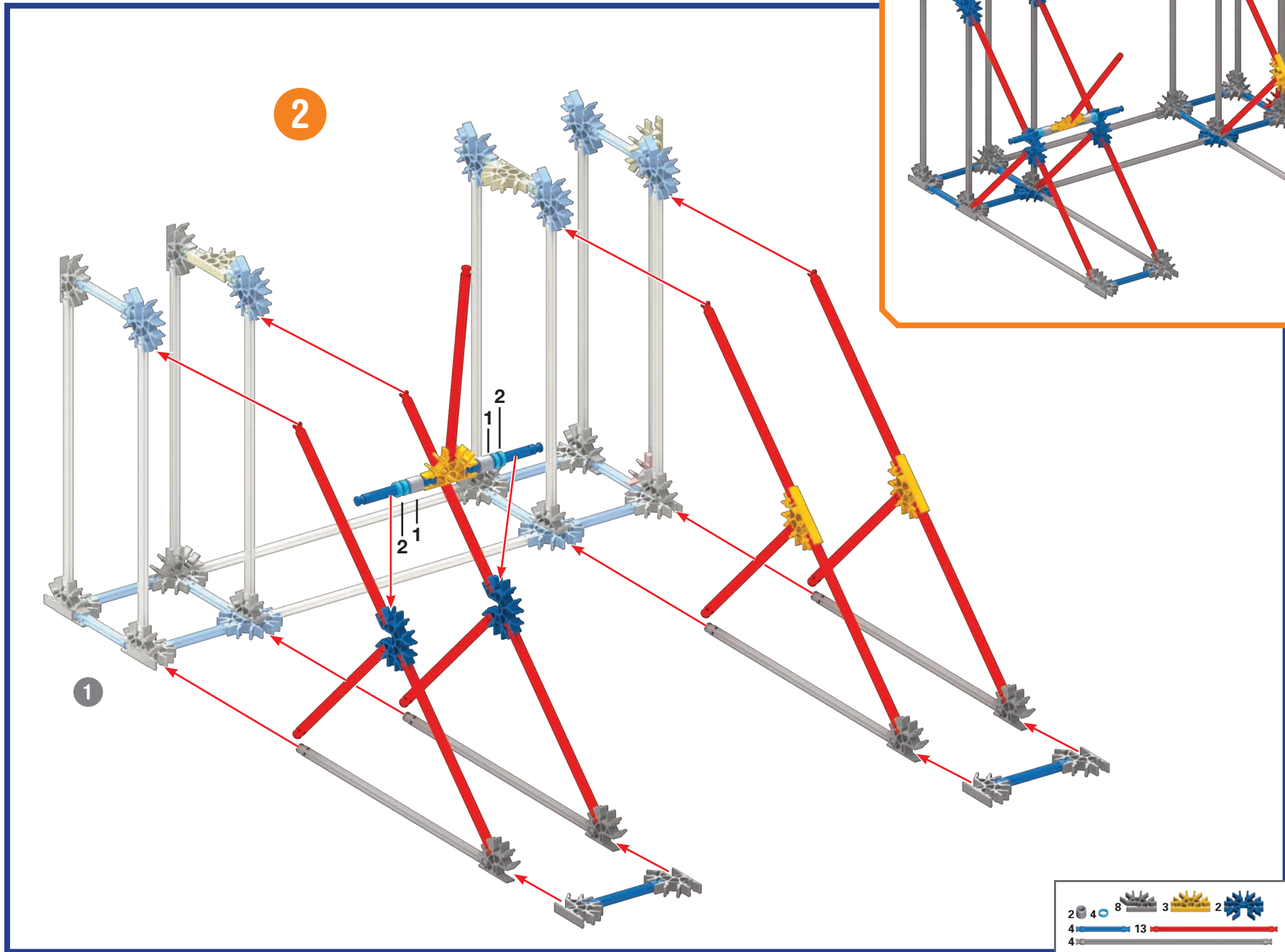

2	4	8	3	2
4	13			
4				

3

4

1 - 2

1 - 3

2		4	
2		14	
1		1	
9		4	
4			

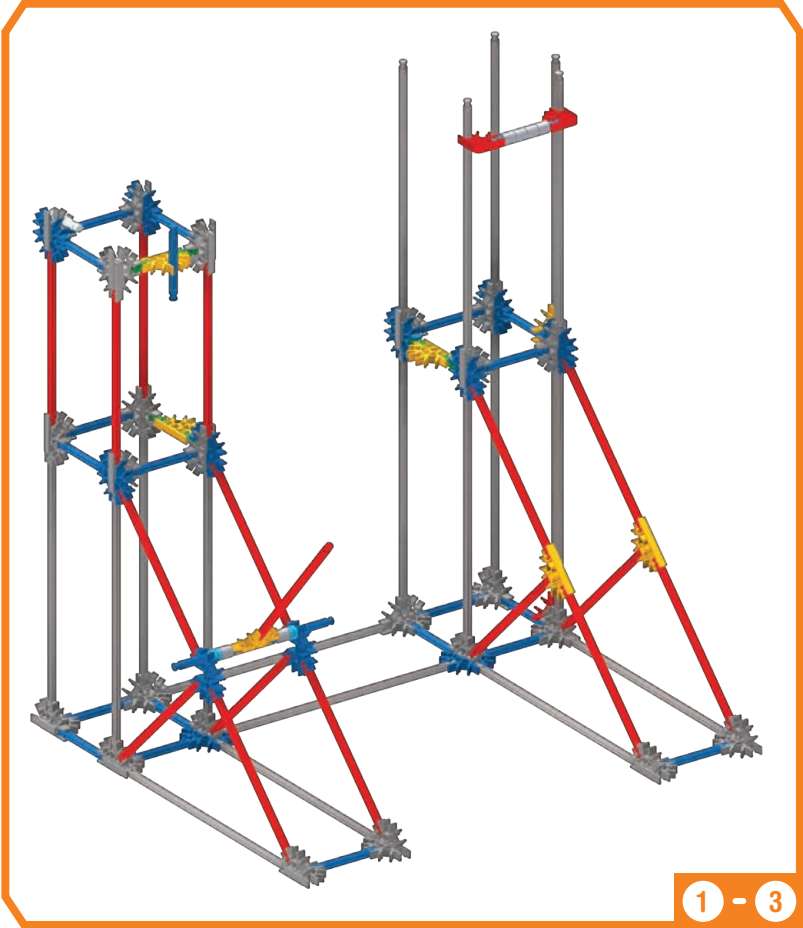
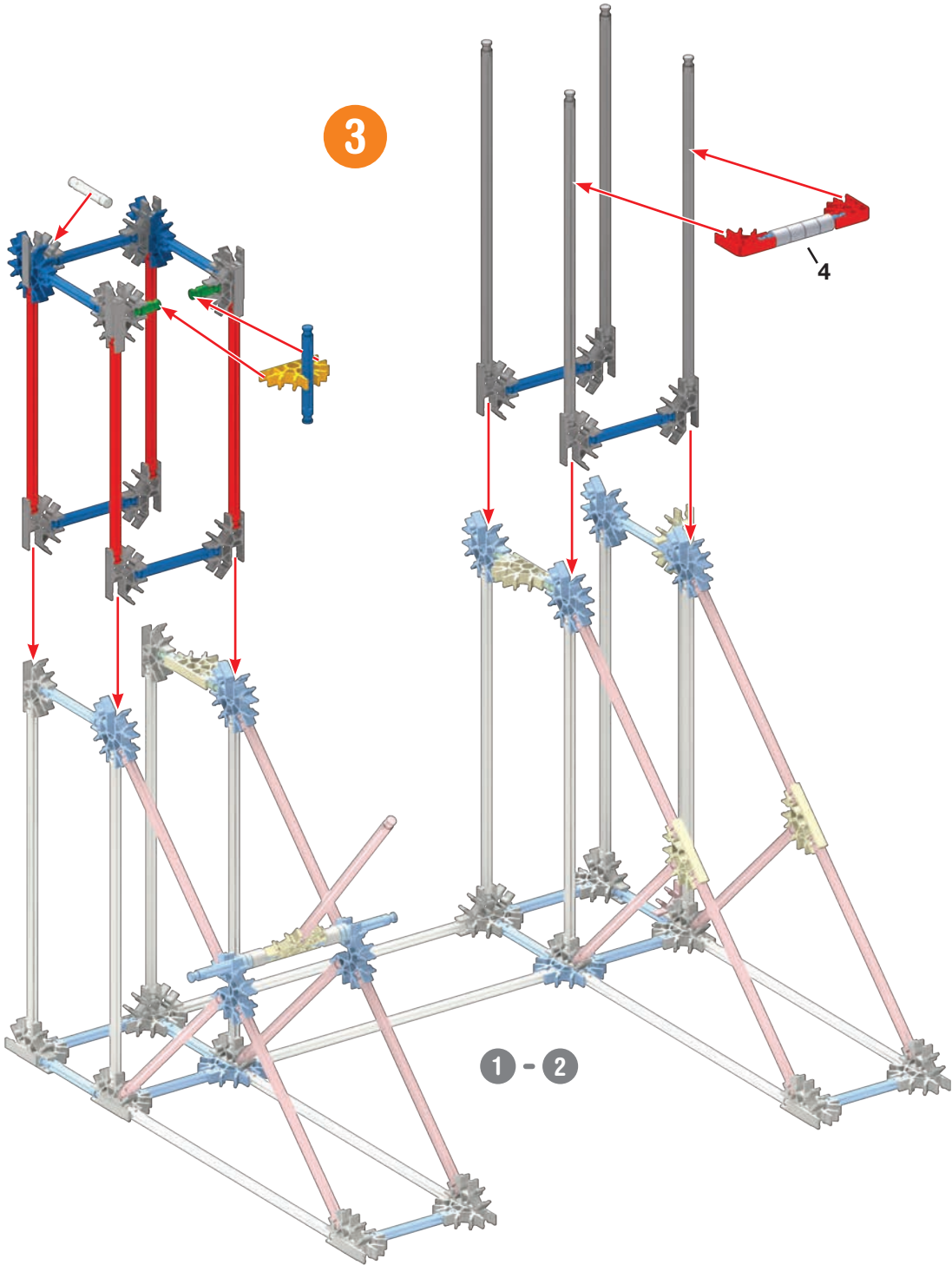





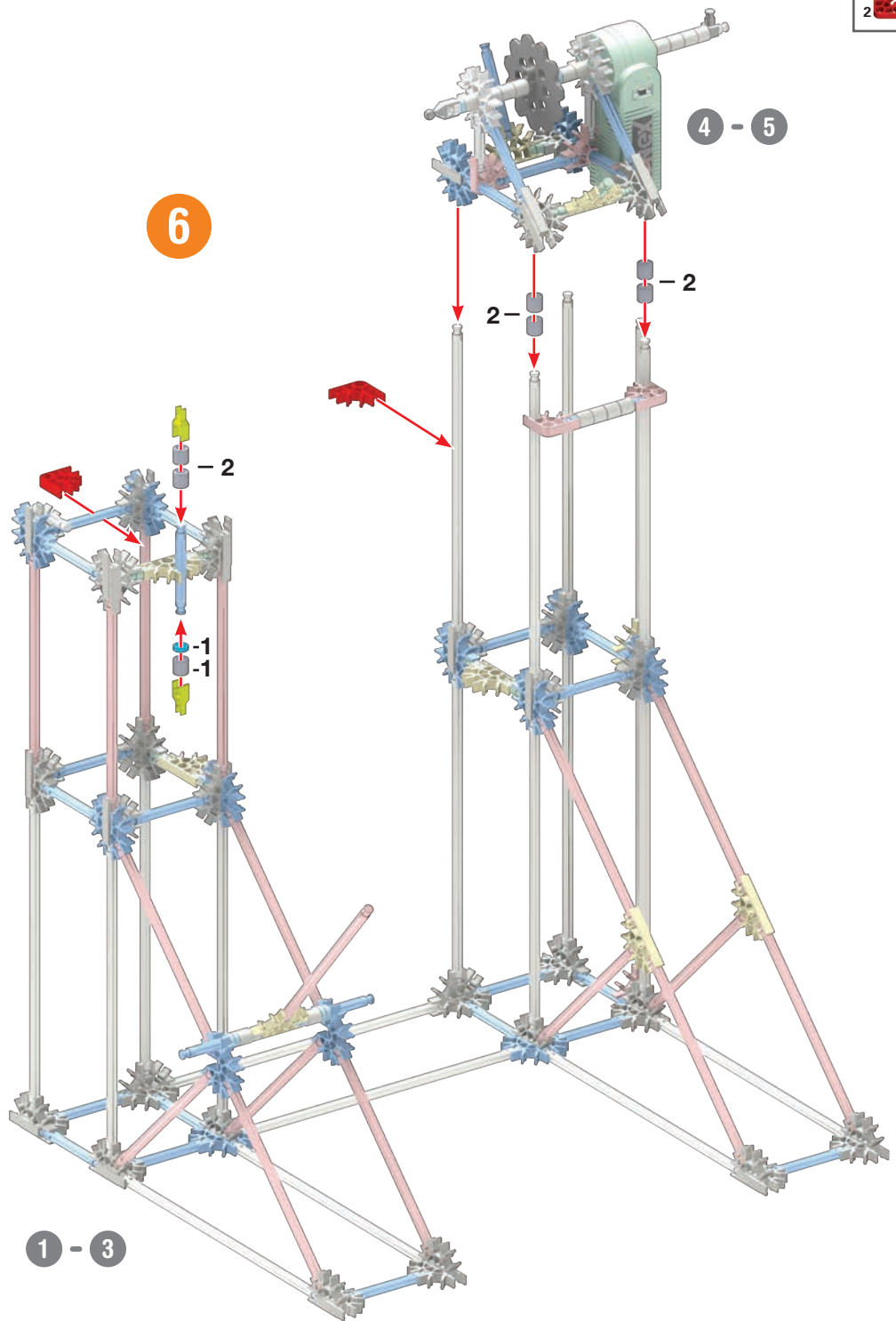
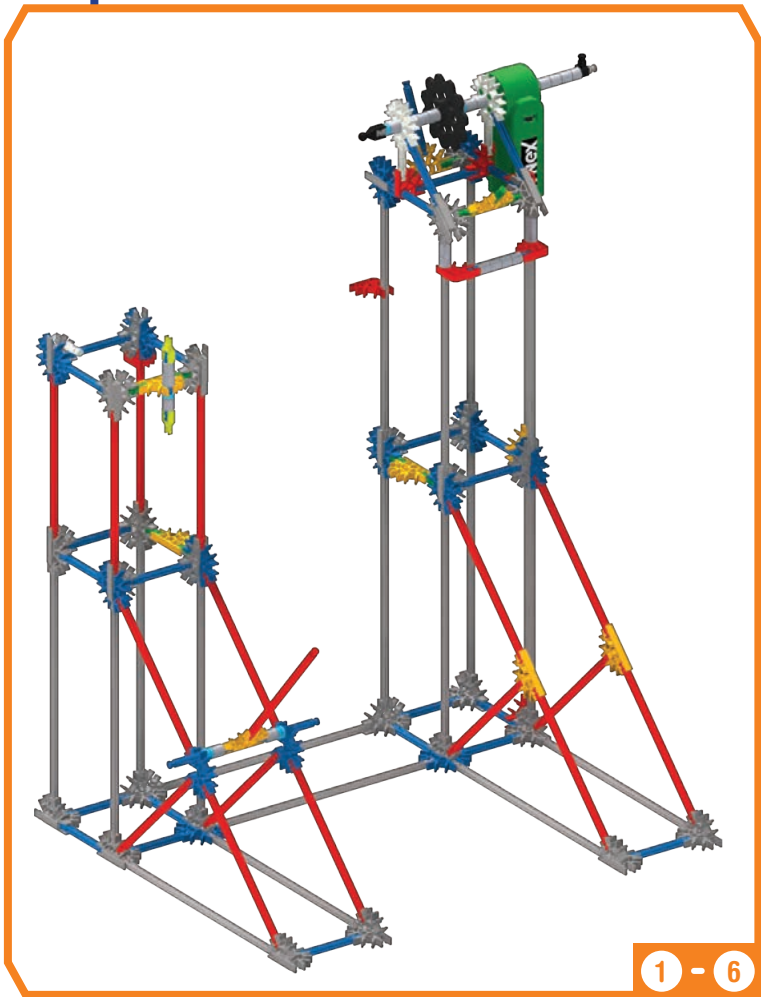

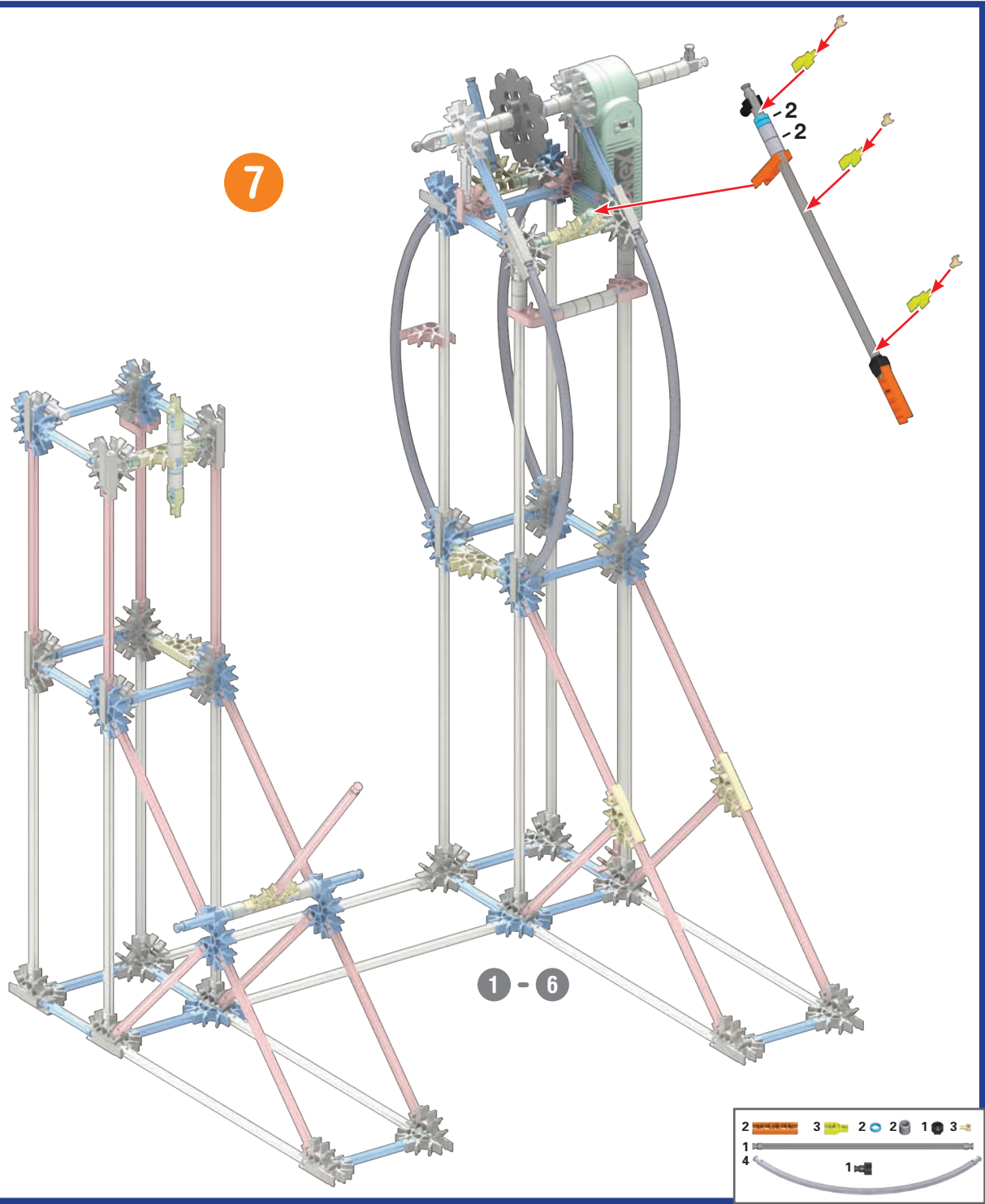

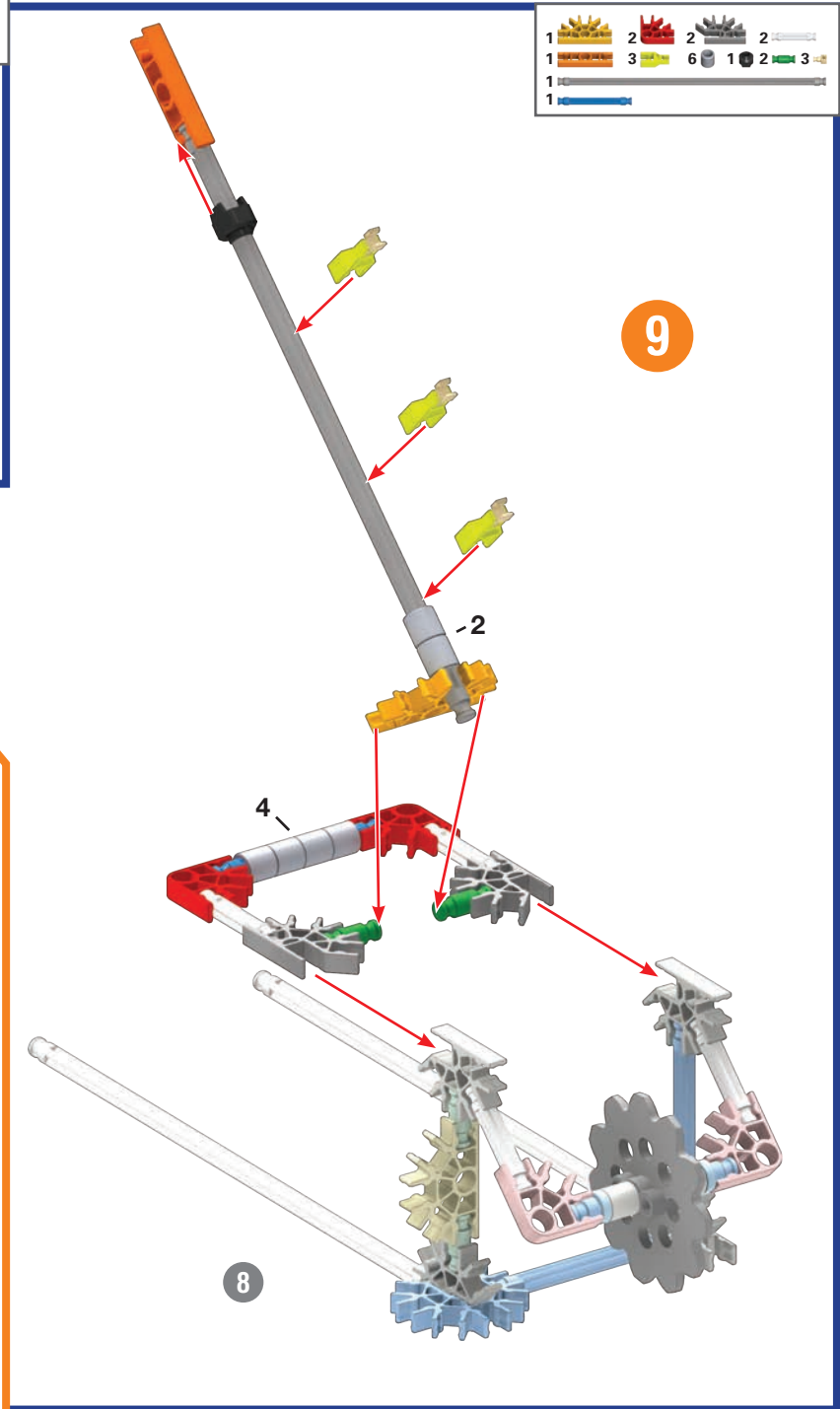
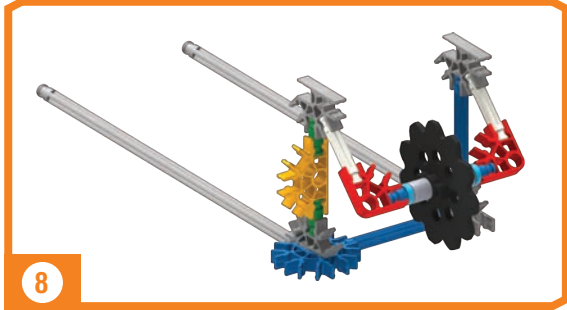
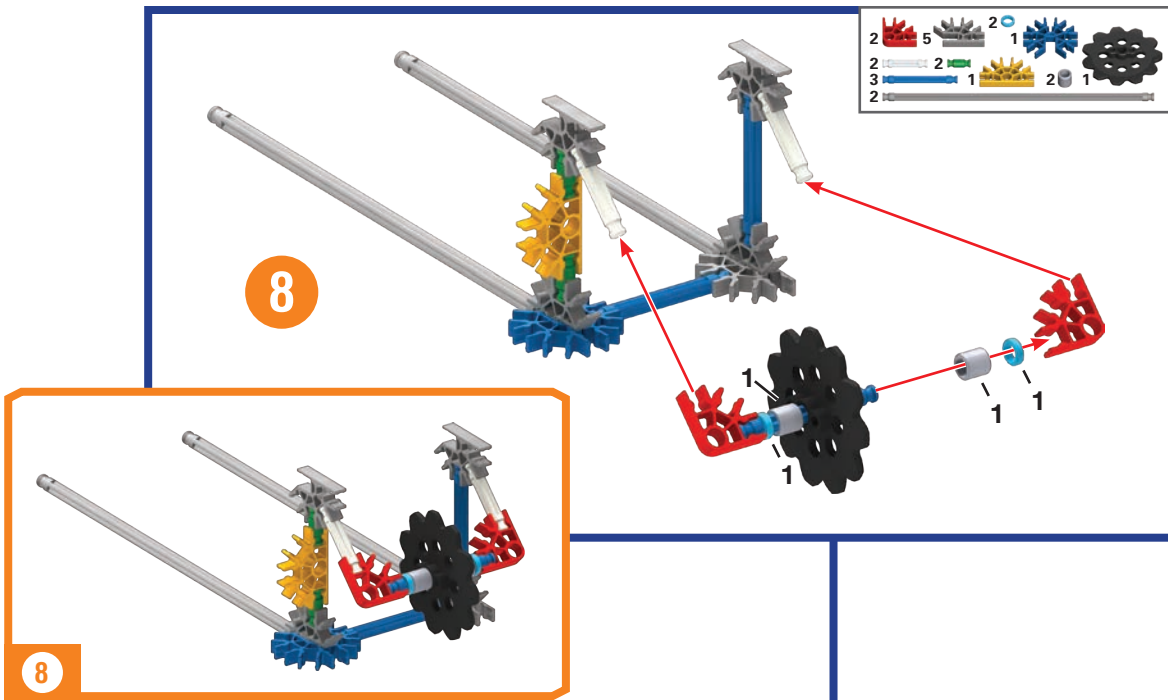











- 2  4  1 
- 1  7  3  4 
- 4  4 
- 4 

10

8 - 9

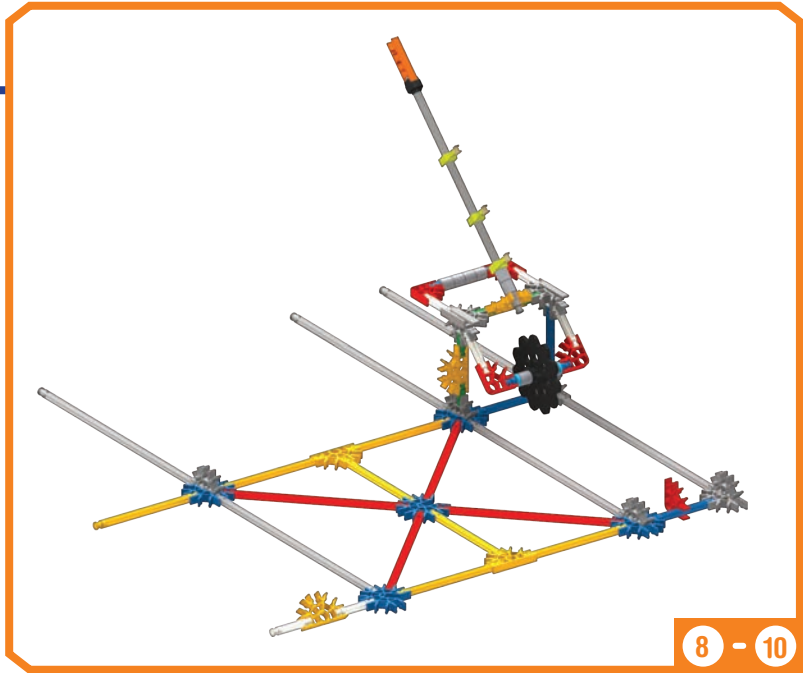
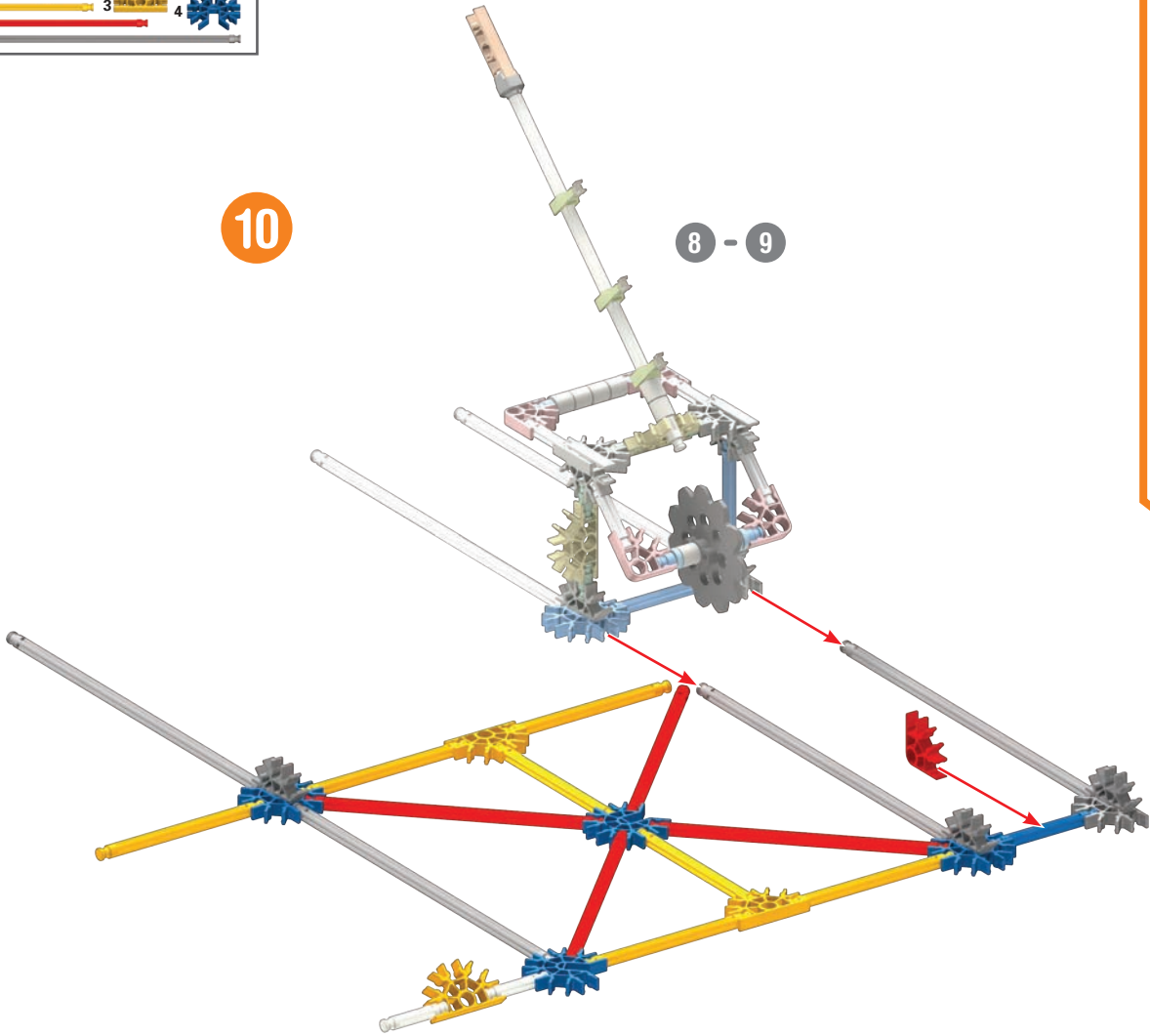

8 - 10



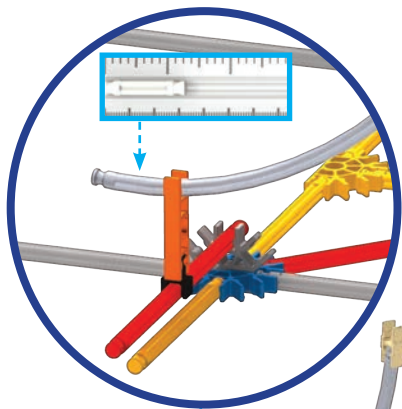

11

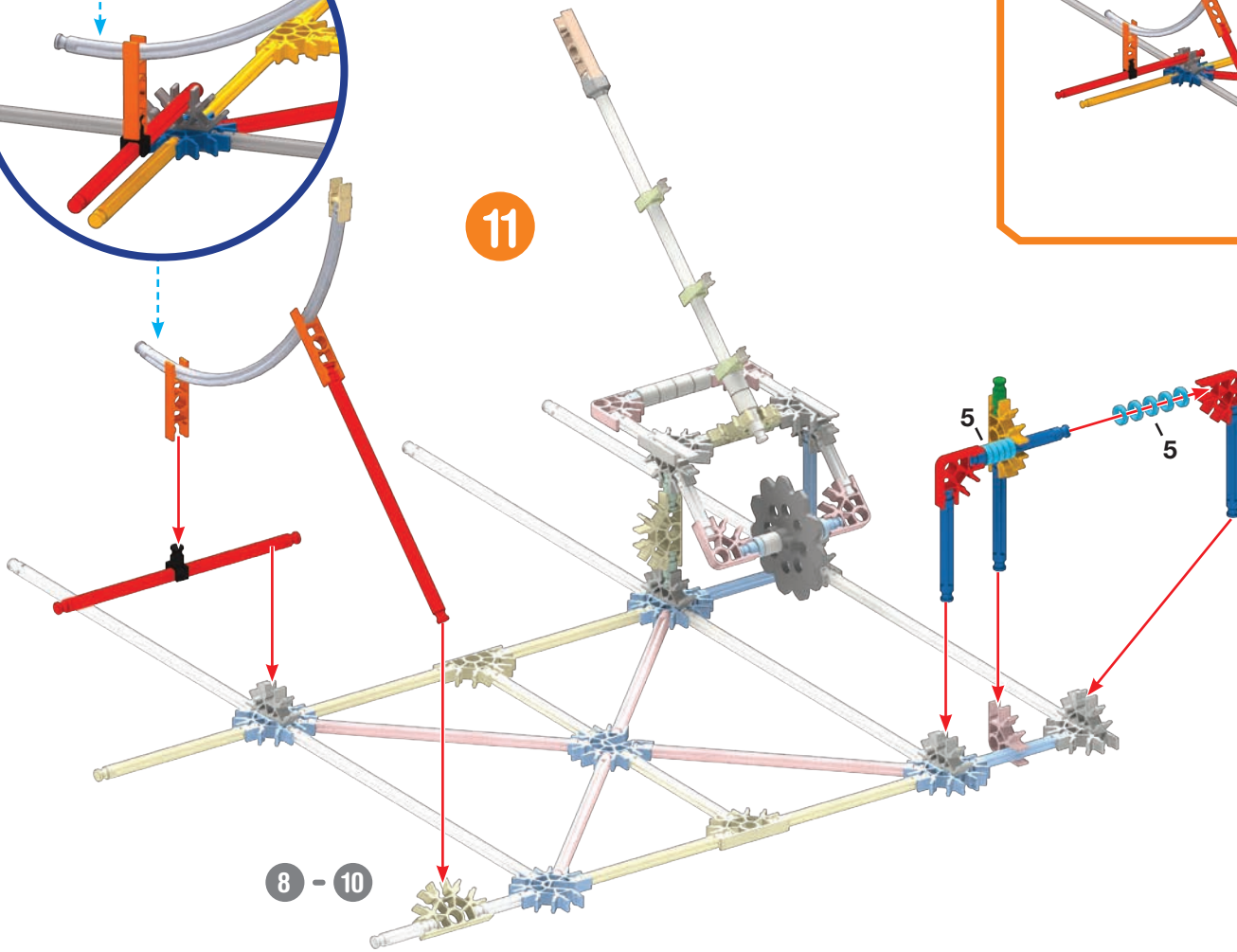

8 - 10



8 - 11

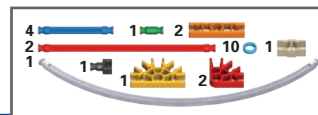

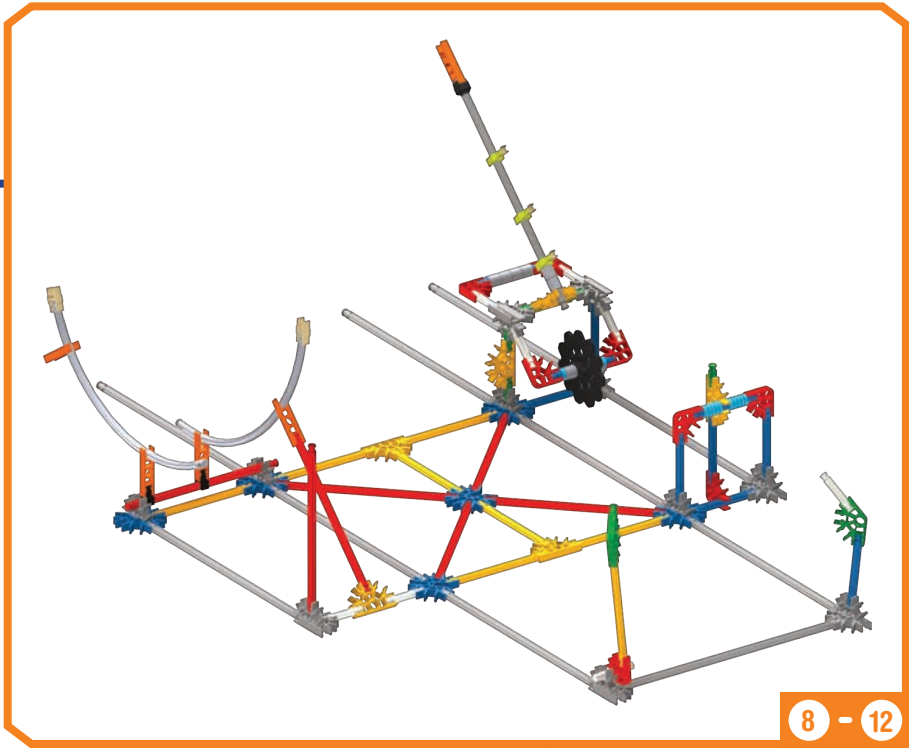
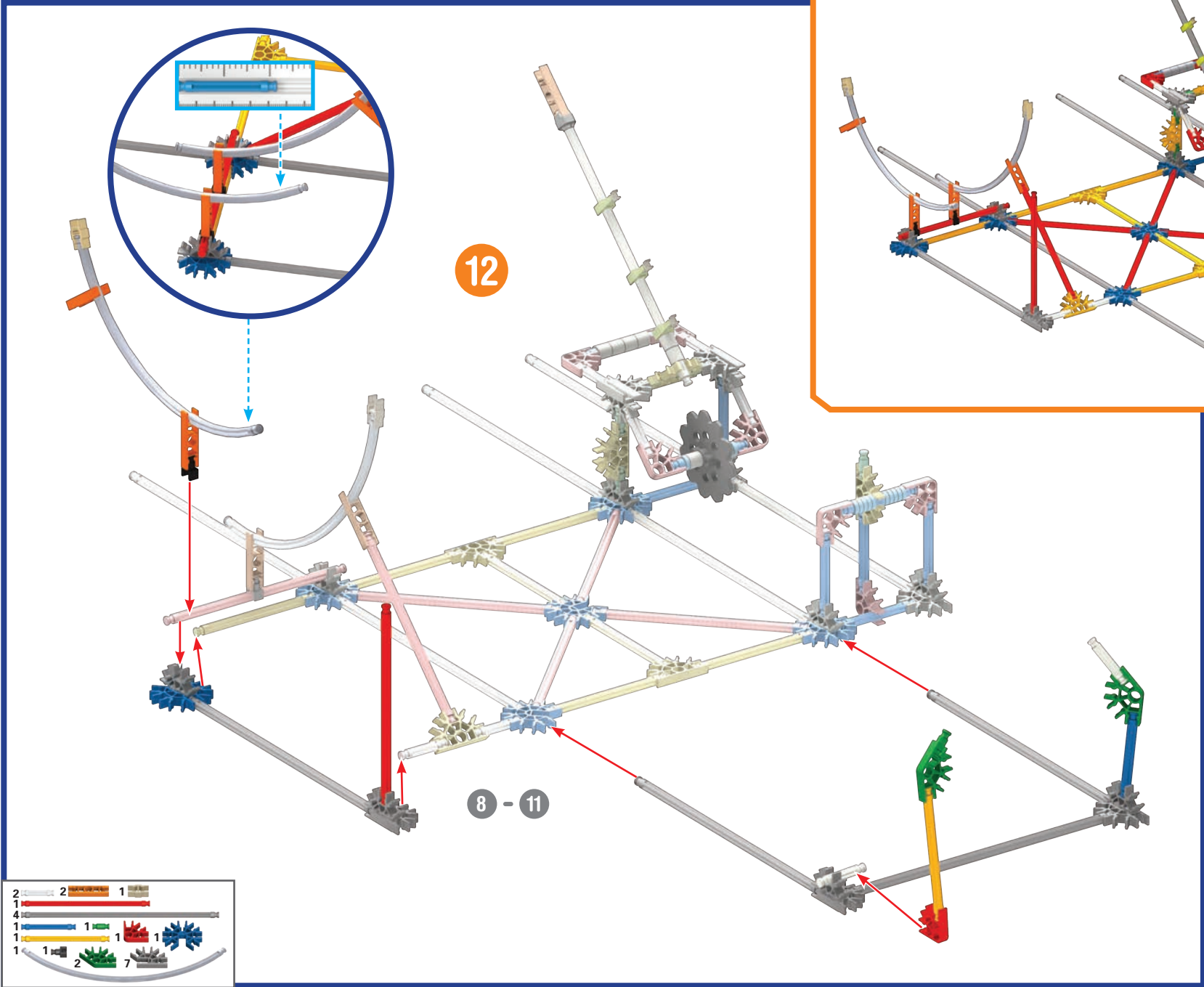

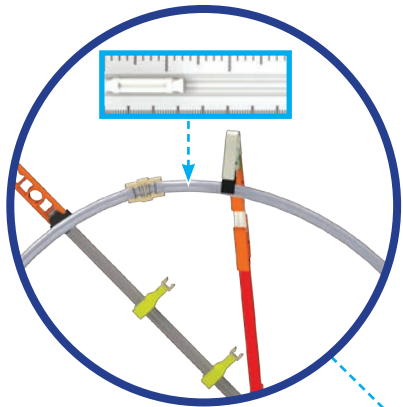

13

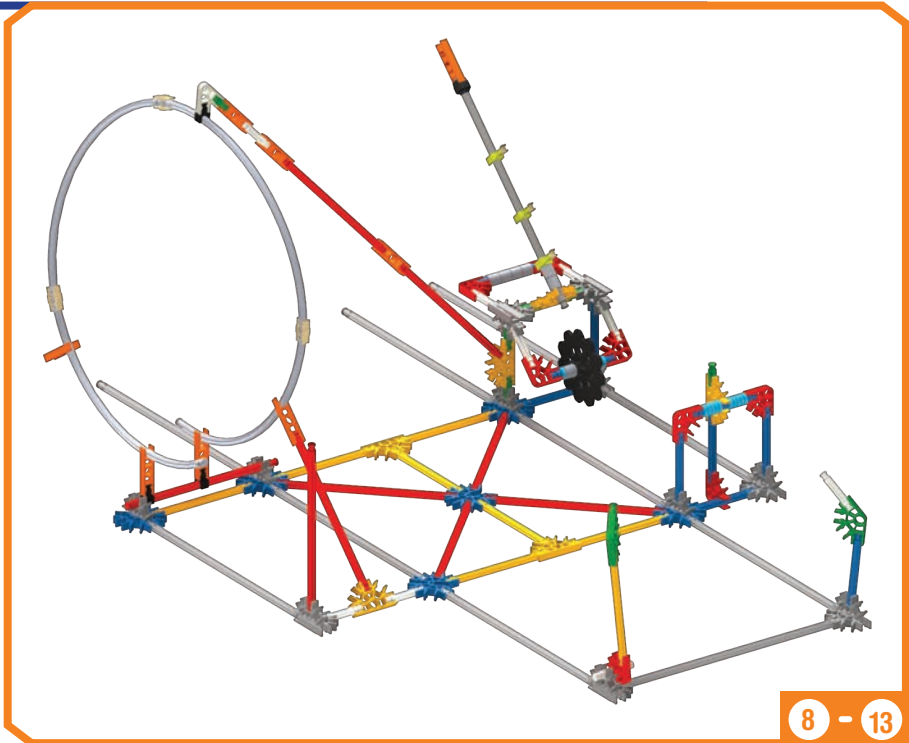

8 - 13

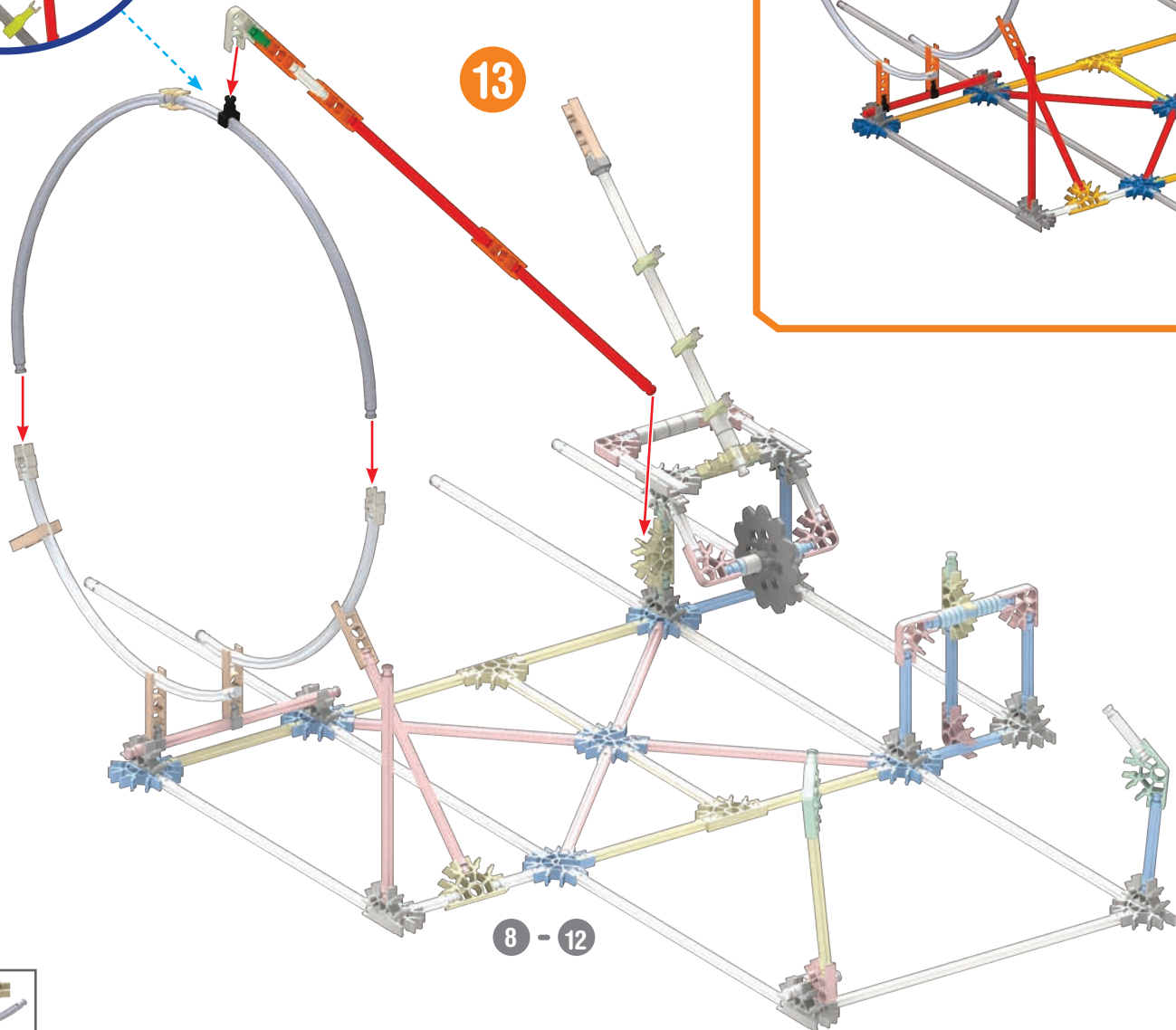

8 - 12

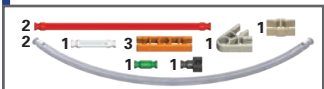

14

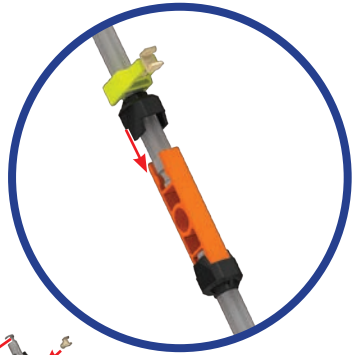

1 - 7

8 - 13



1 - 14





6	1	1	1
4	1	1	1
2	1	1	1
2			

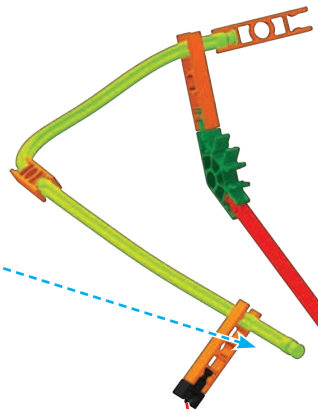
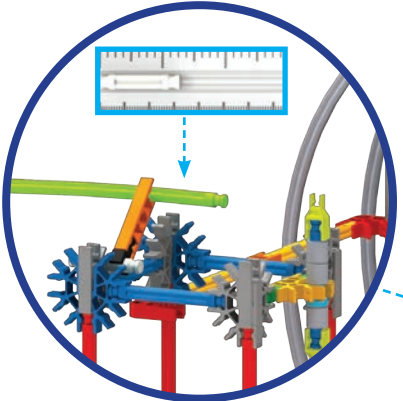

15

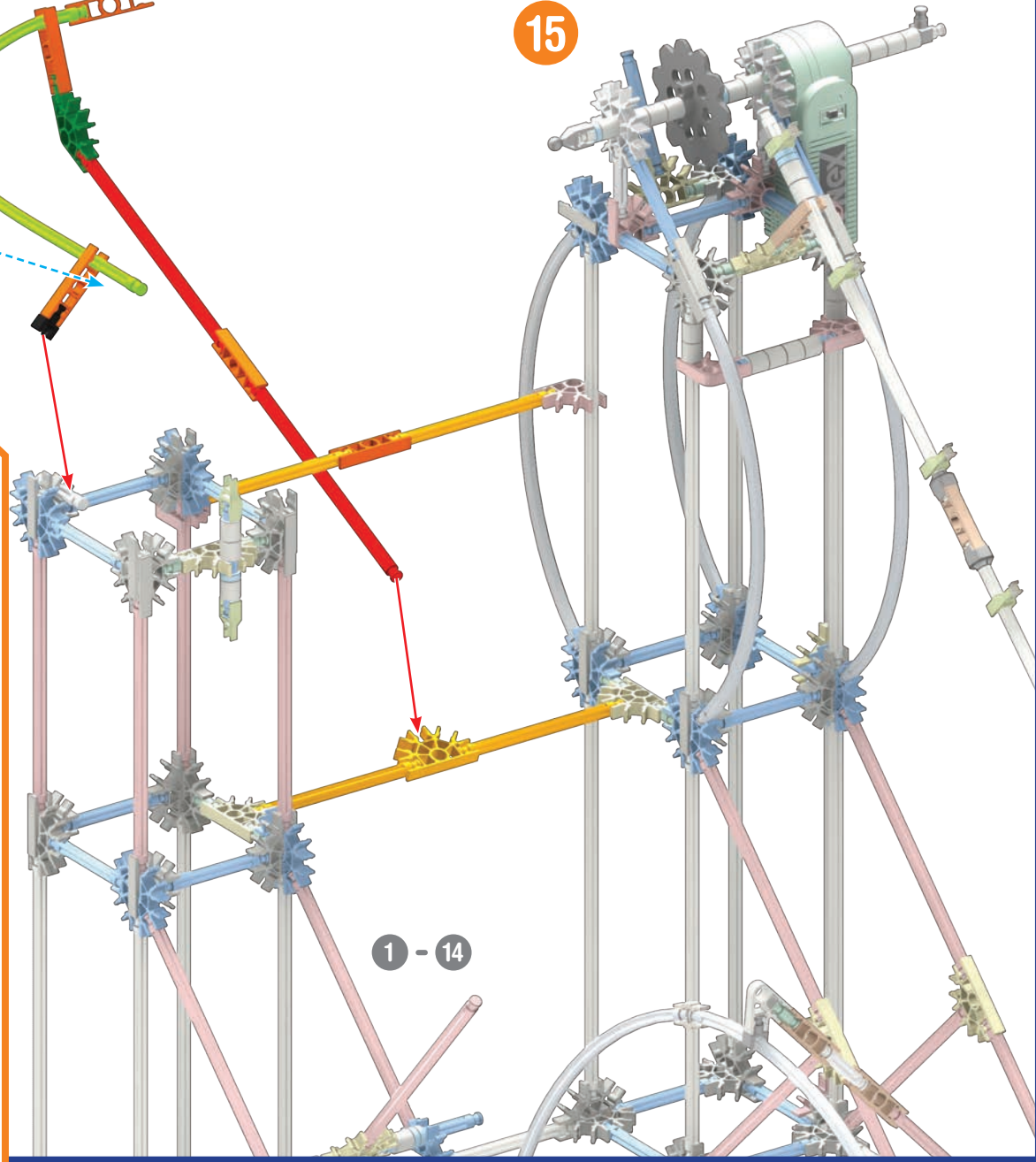

1 - 15

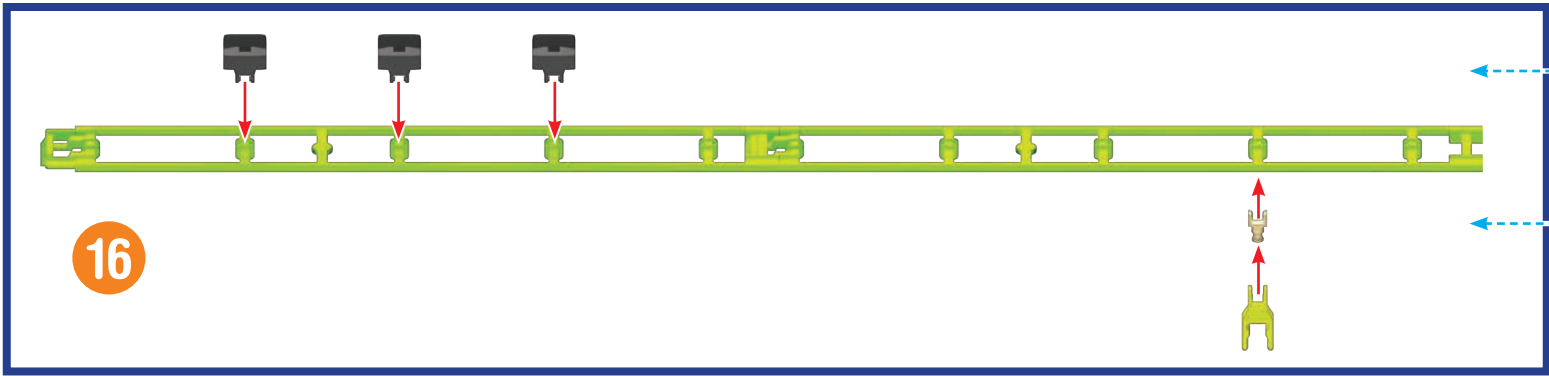

16

Attach the black chain guides to the top of the track and attach the connectors to the bottom of the track exactly as shown.  
Be sure to push the connectors on firmly until they "click".

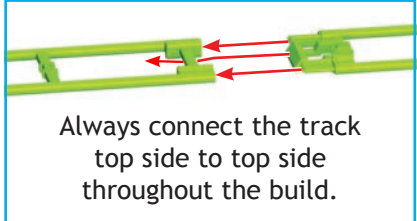

Always connect the track top side to top side throughout the build.



1 - 17

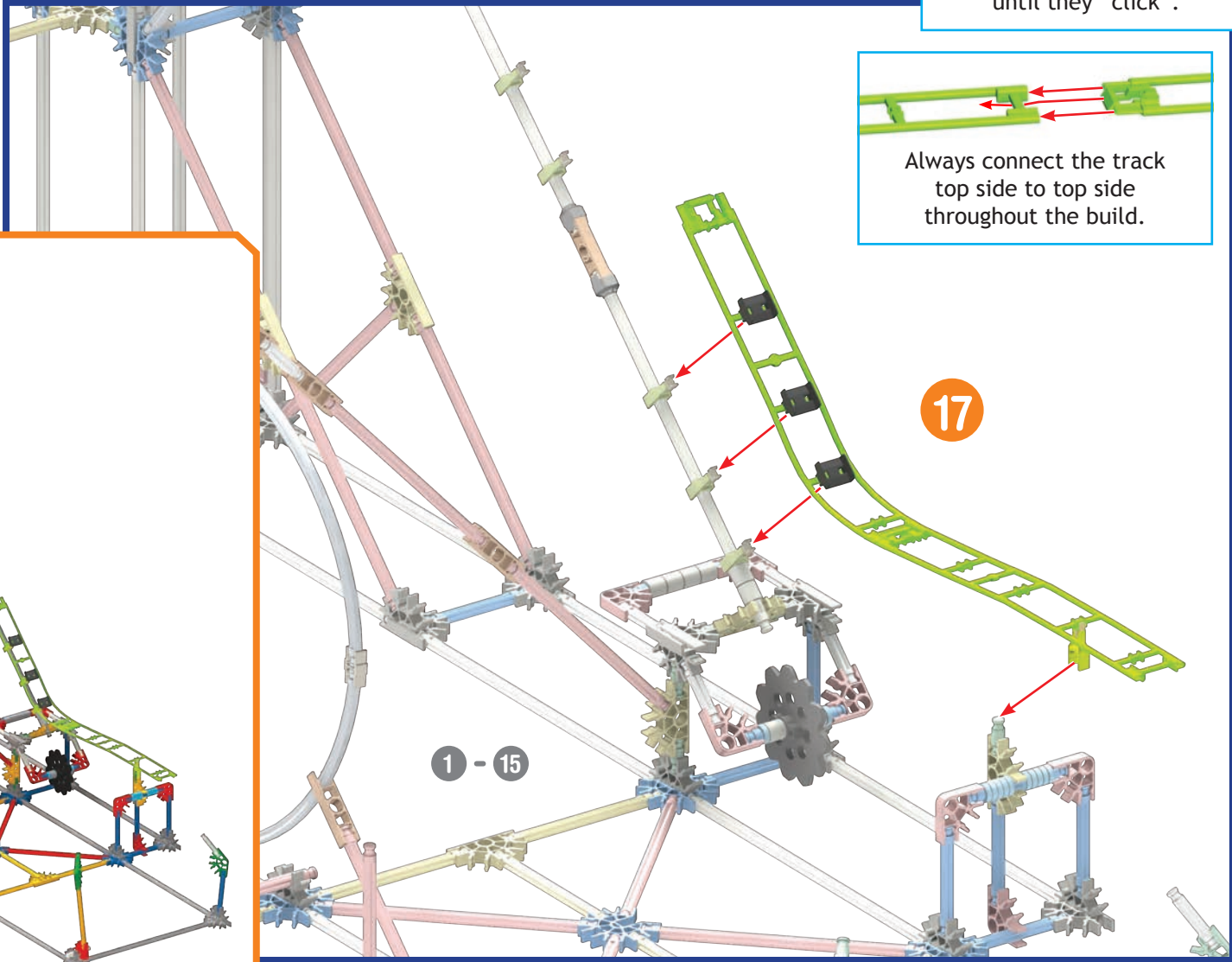

17

18



19

Always join this end of the track to the previous track piece first, then connect the rest of the track to the tower.

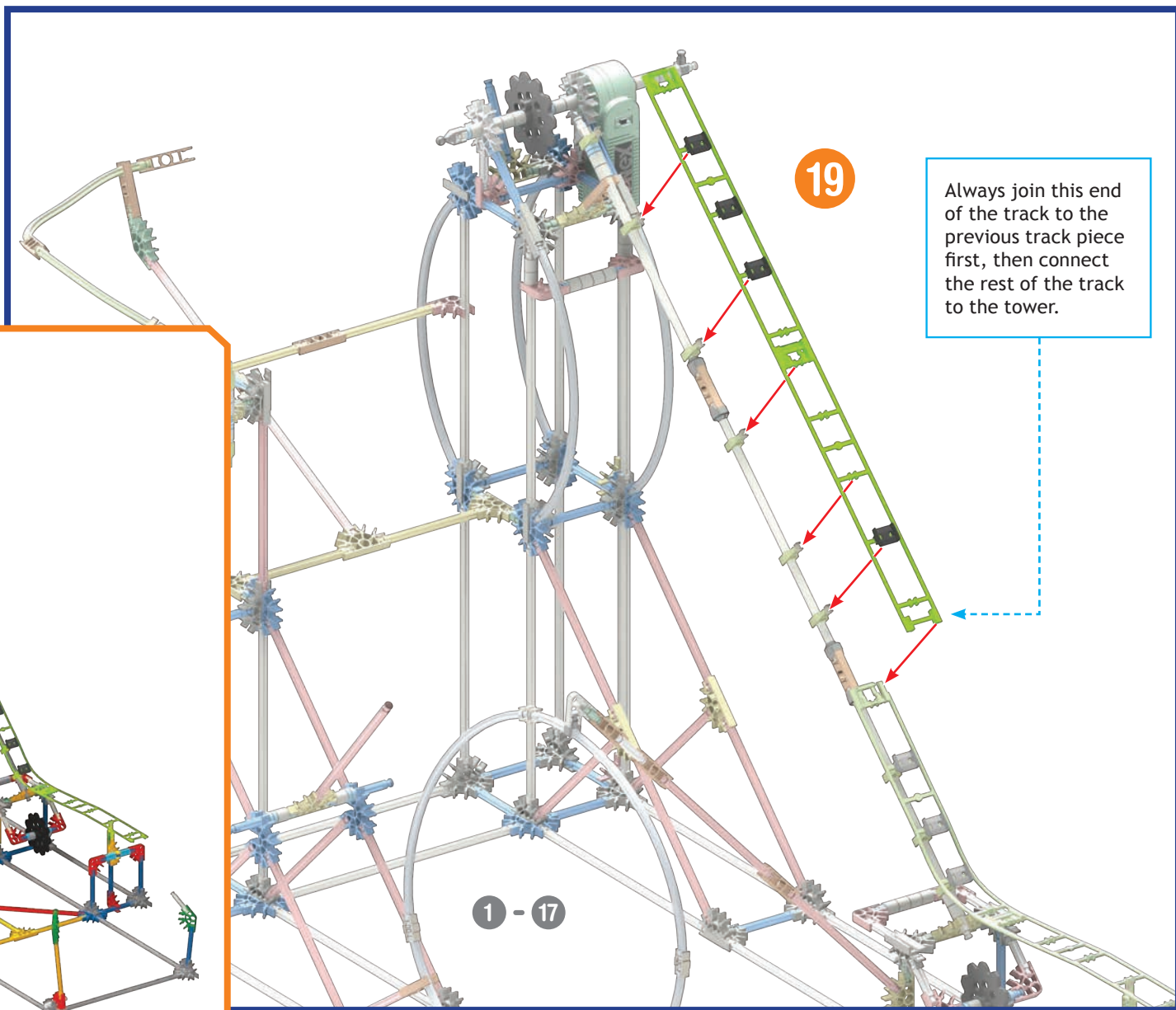

1 - 17



1 - 19



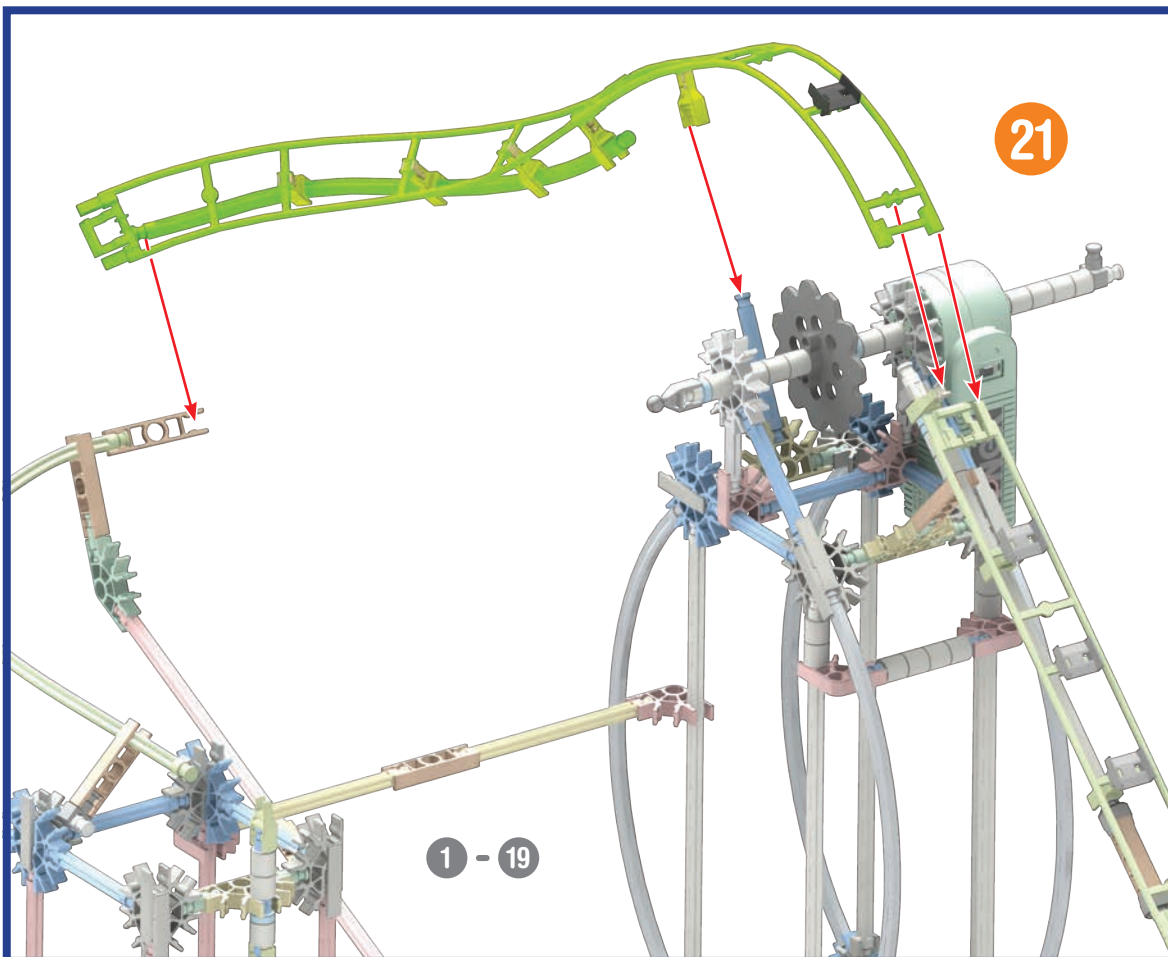
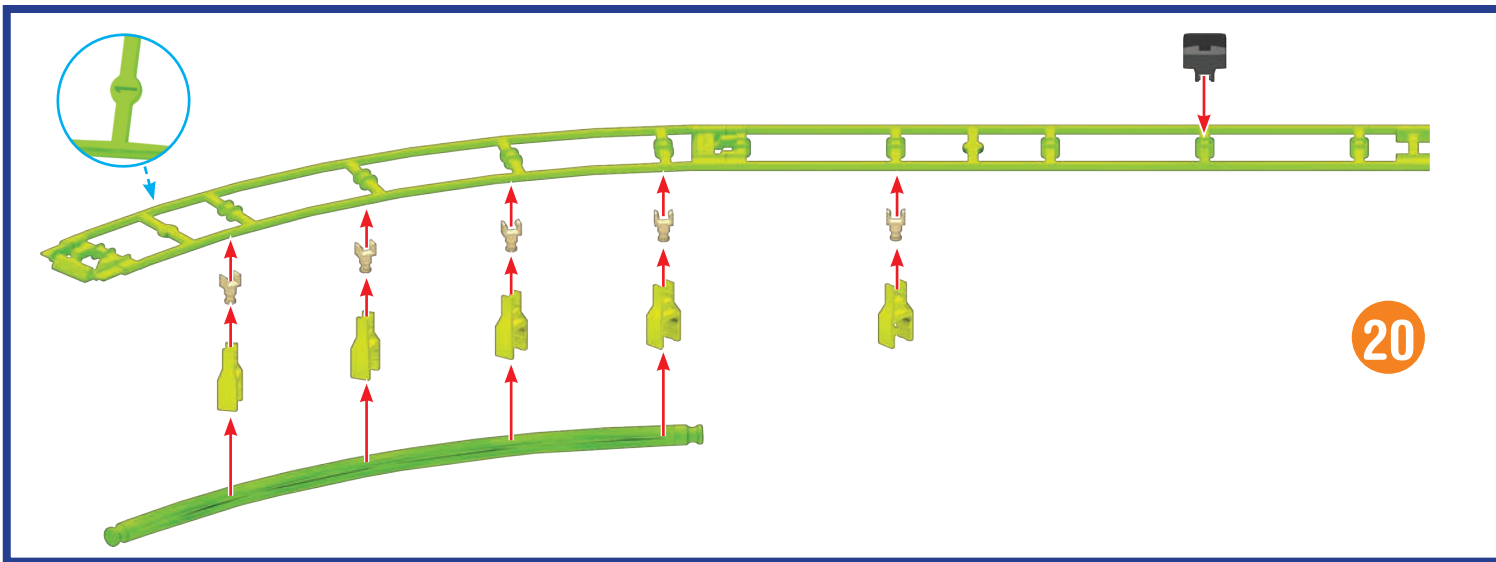



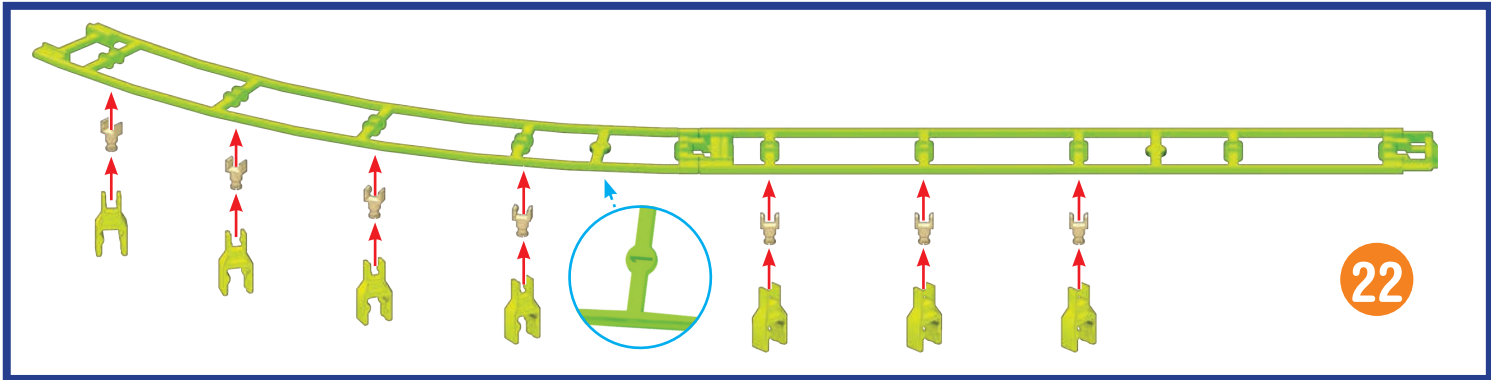

22

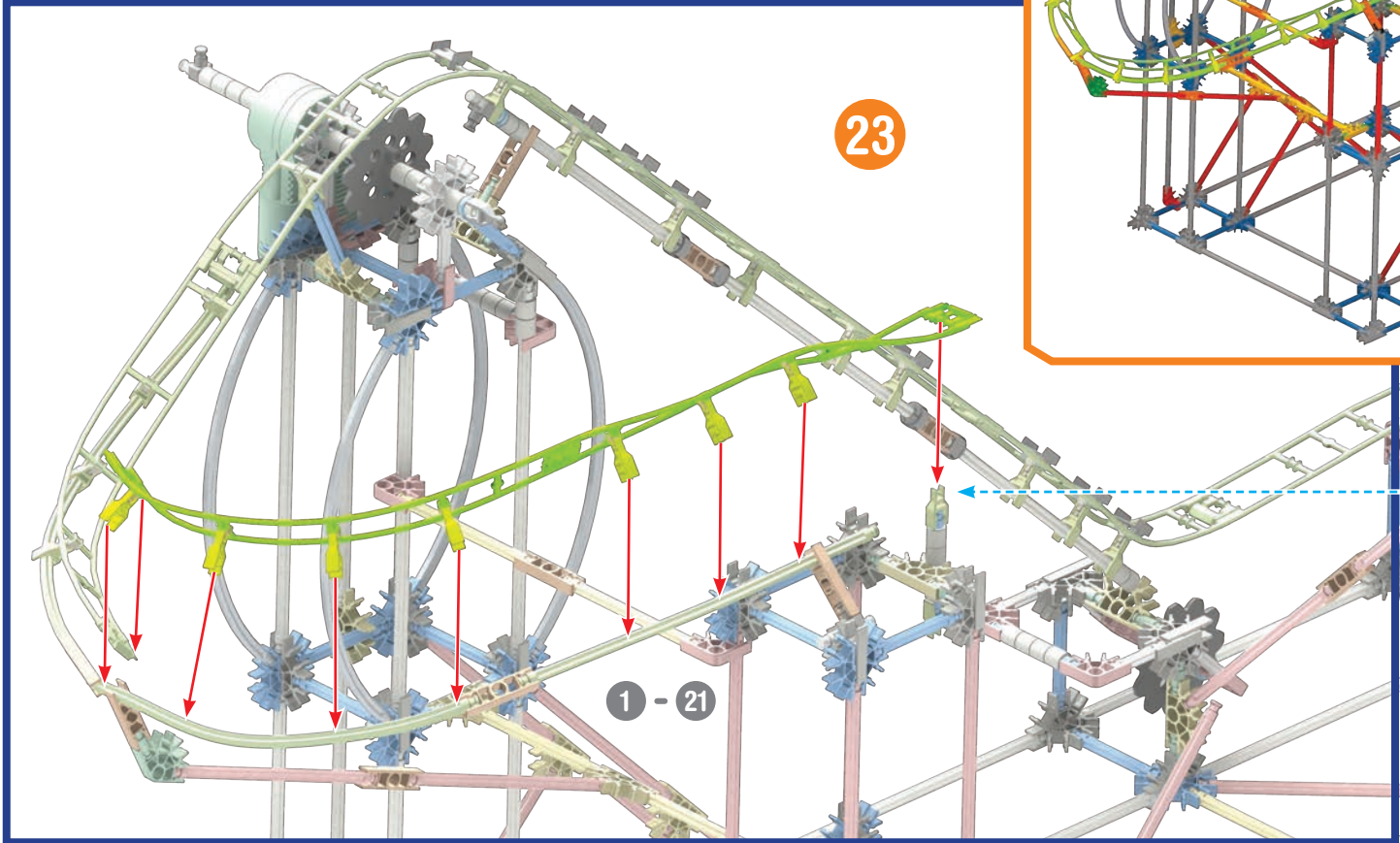

23

1 - 21

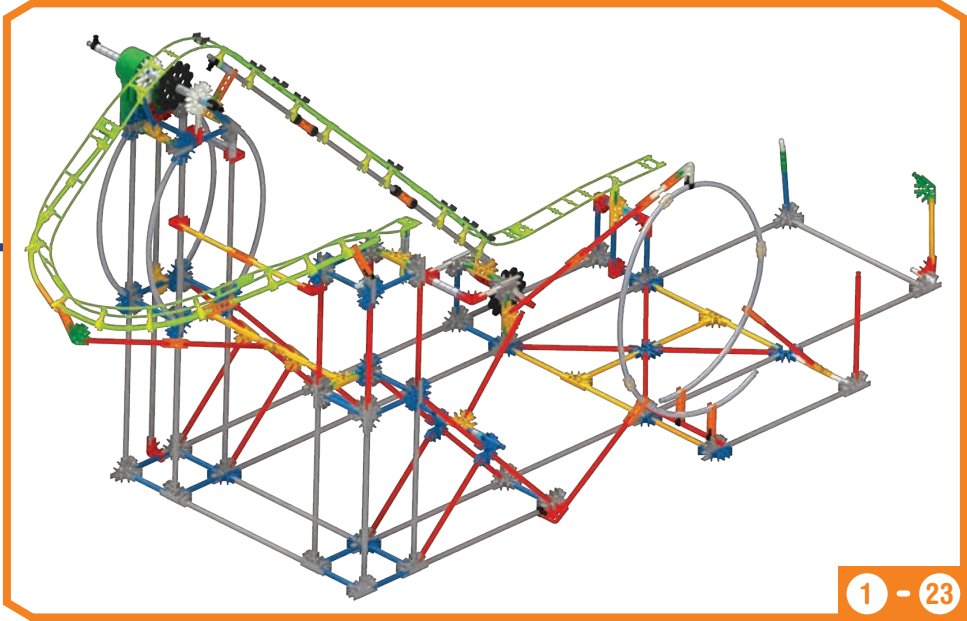

1 - 23

Connect this end first.  
Adjust the spacing  
of the connectors on  
the lime green rod as  
needed.

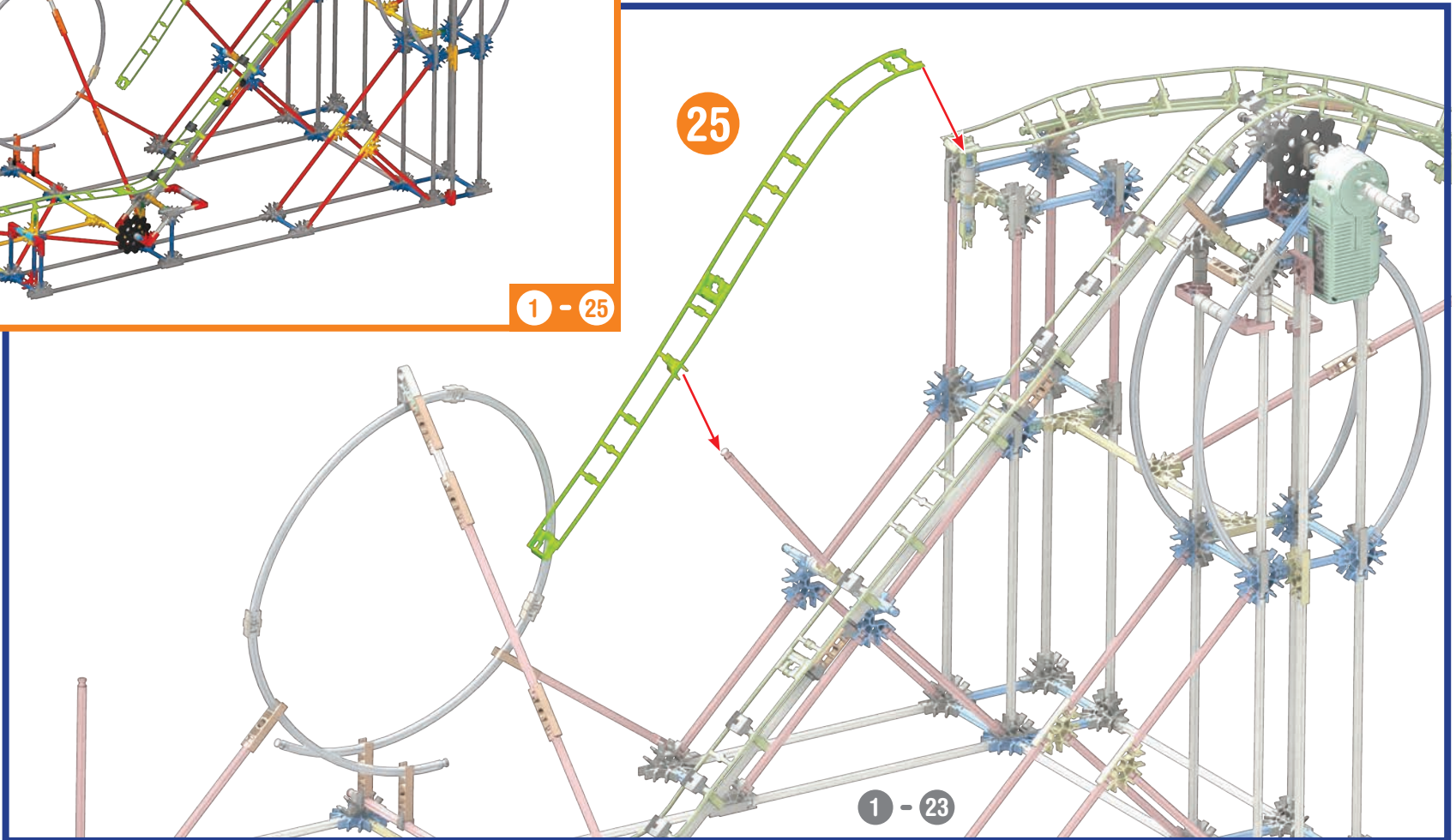
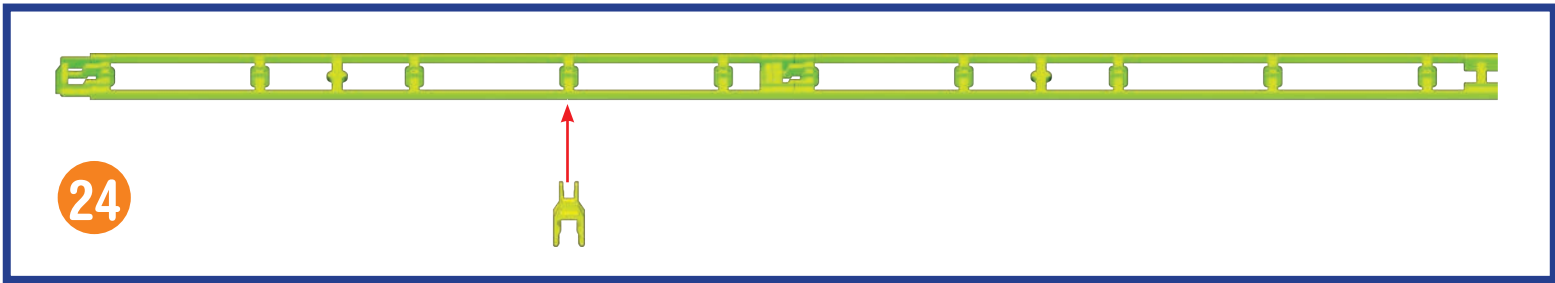

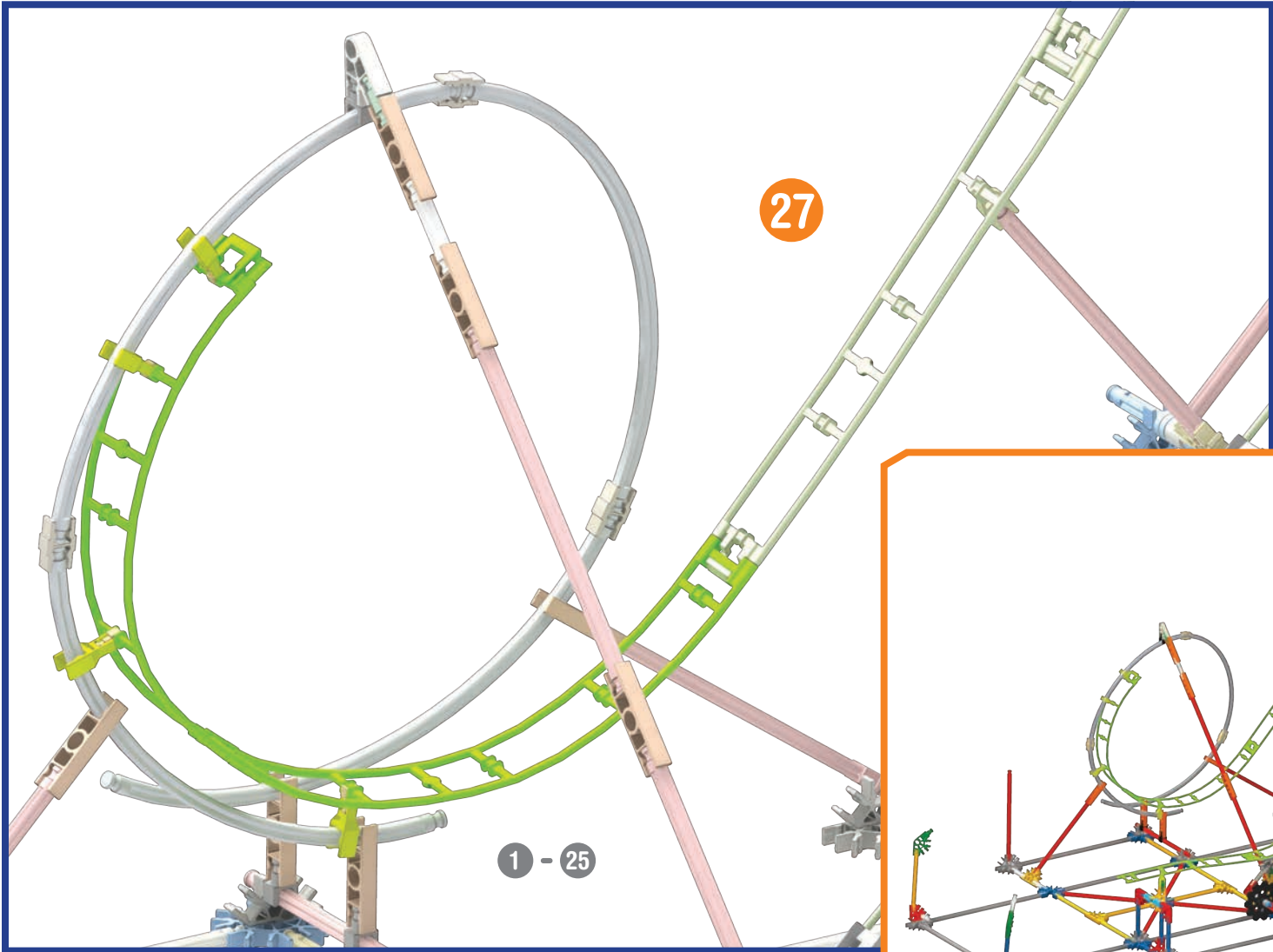
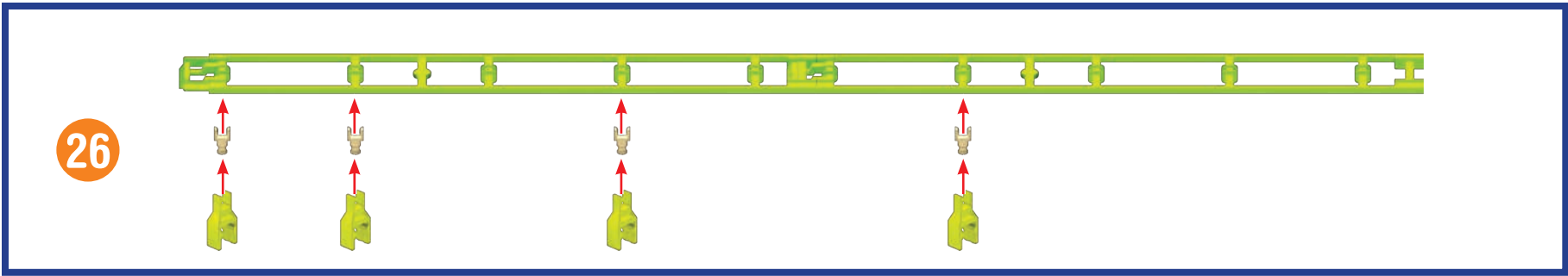



28

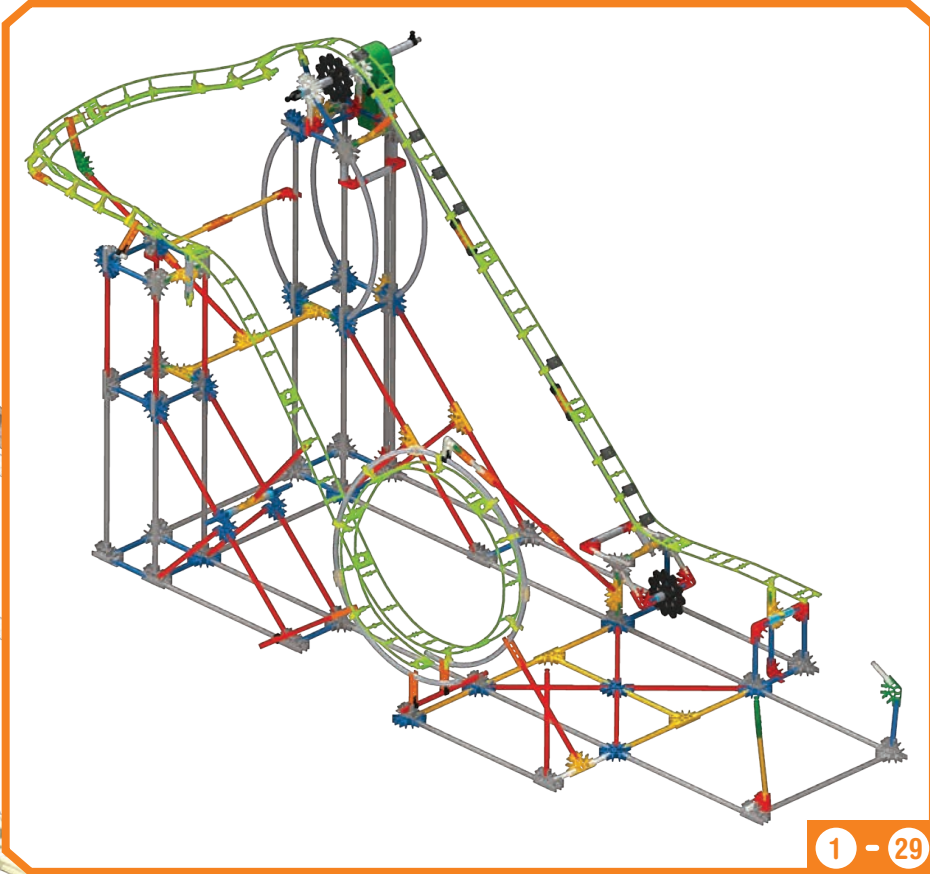
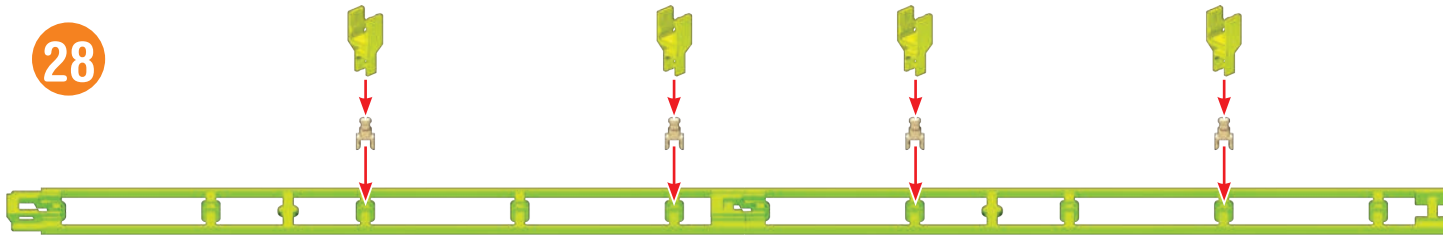

1 - 27



30

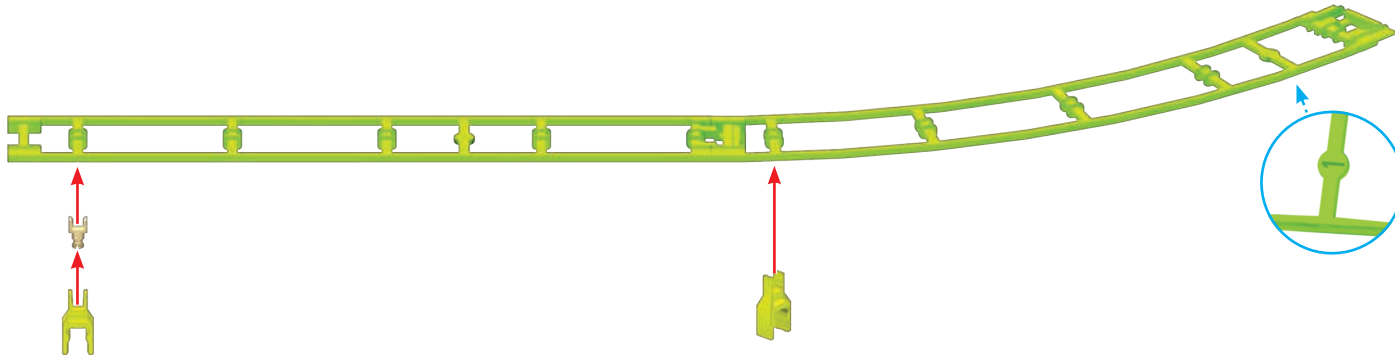

31

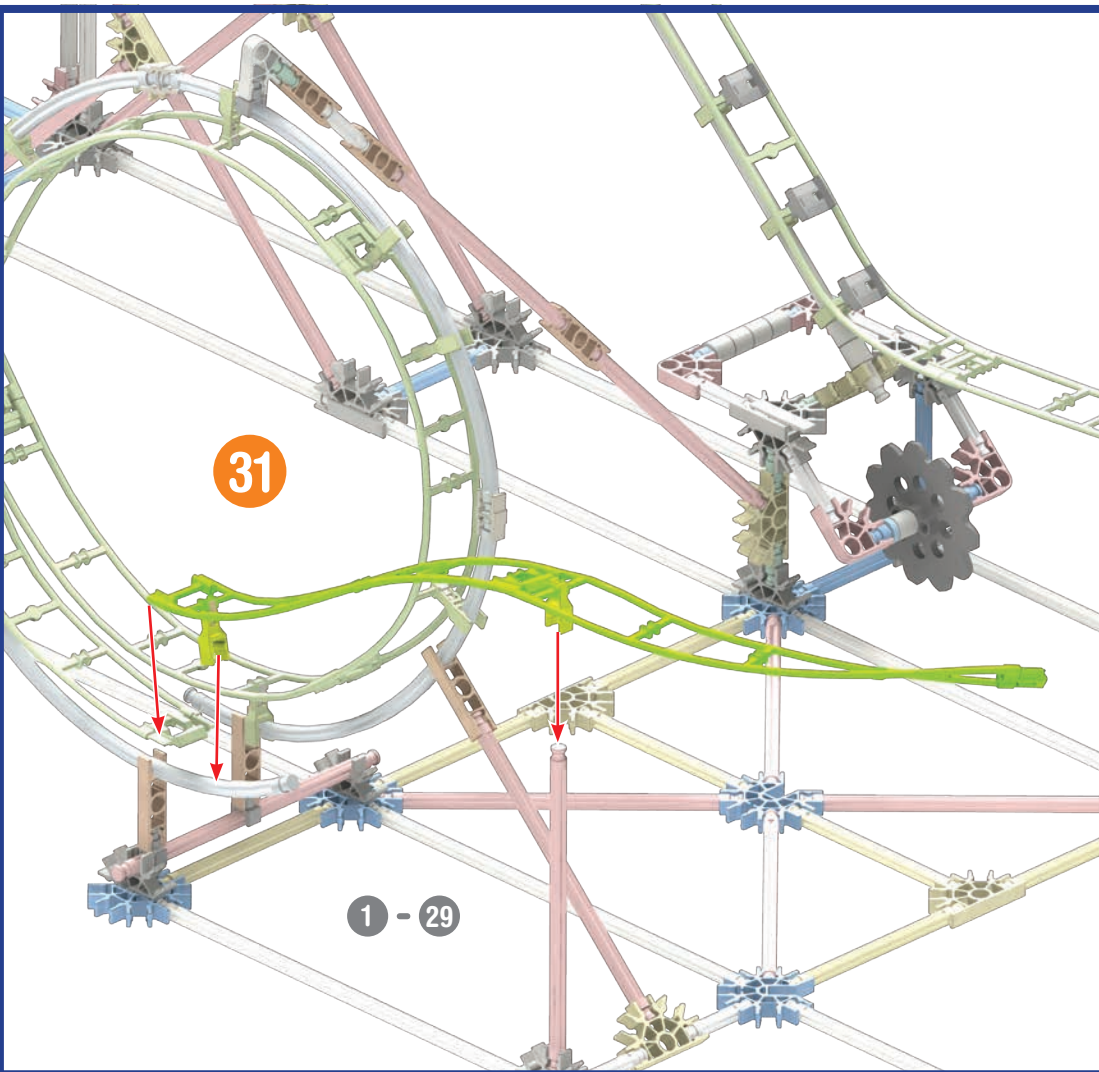

1 - 29

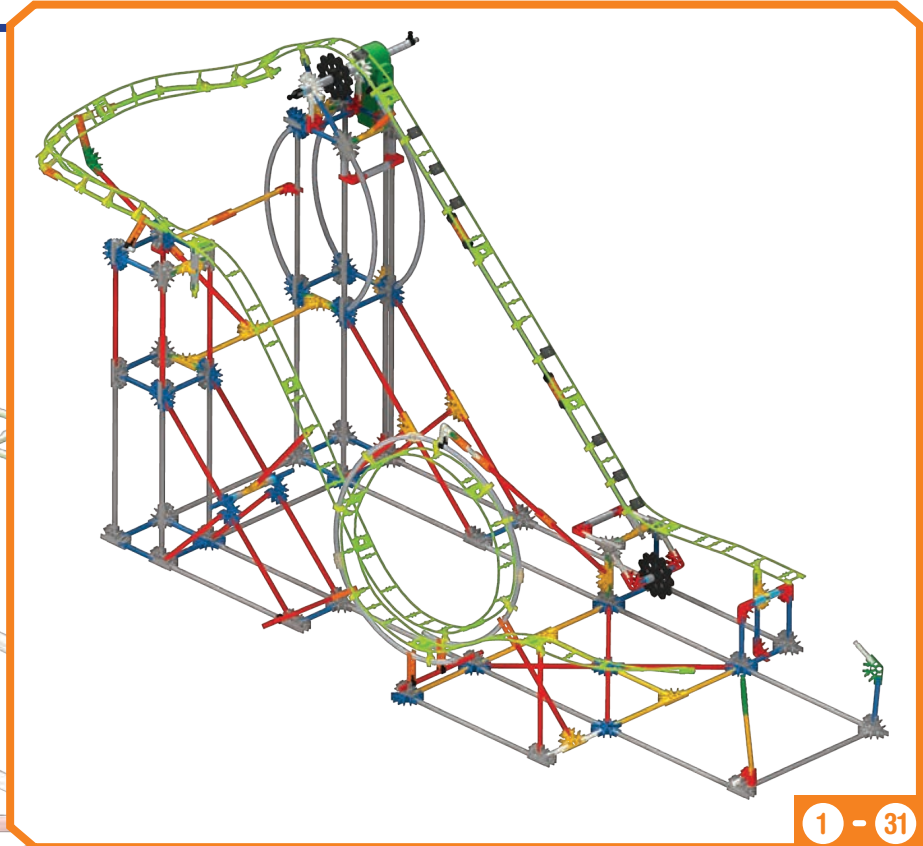

1 - 31

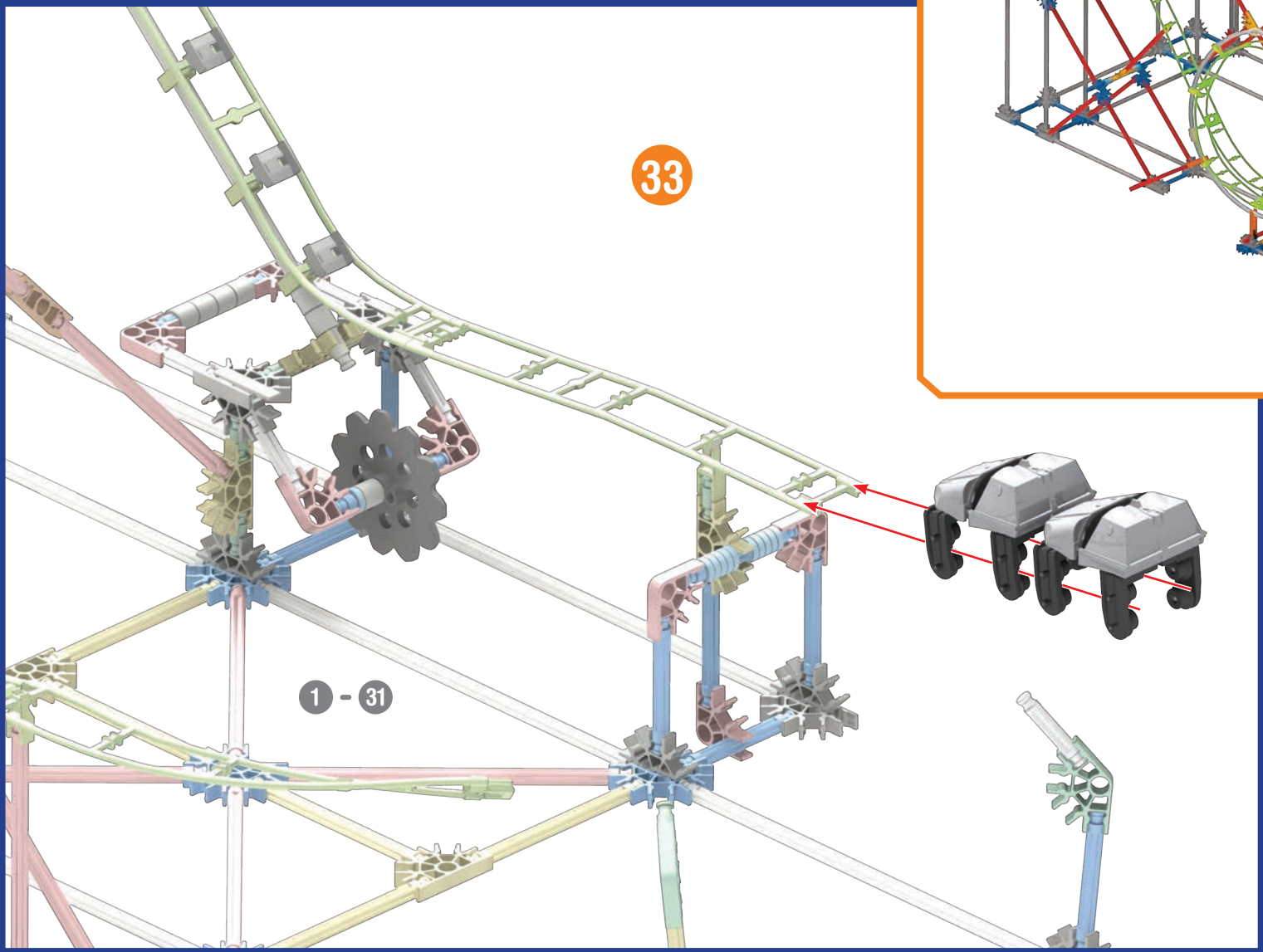
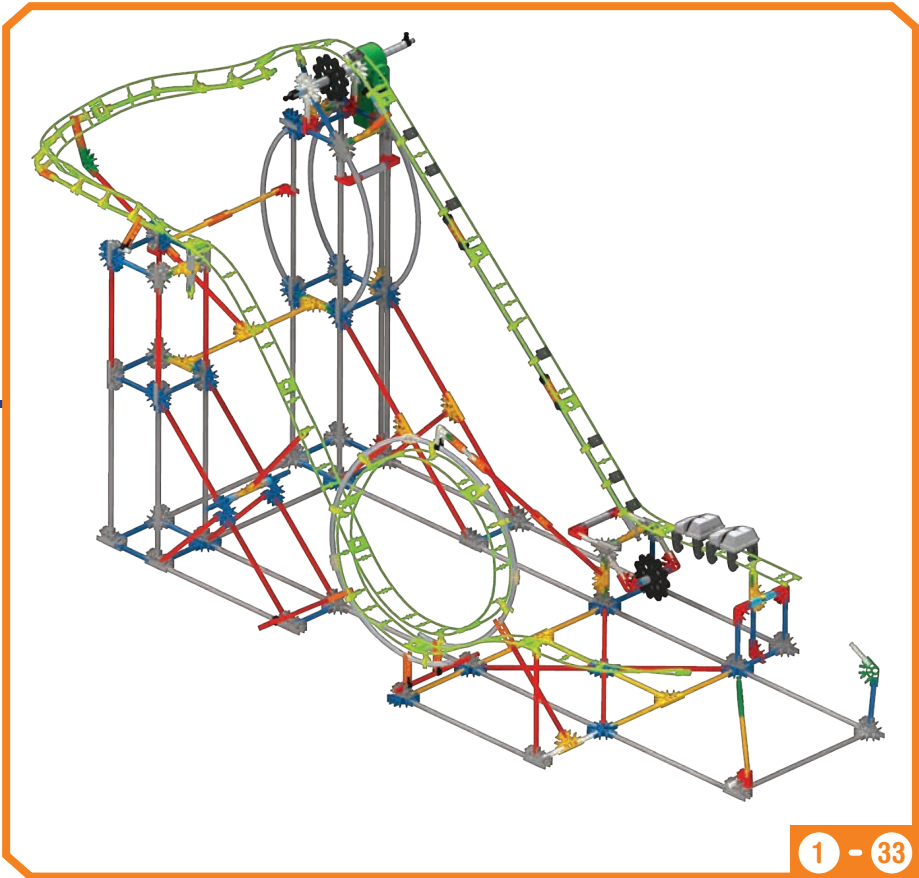
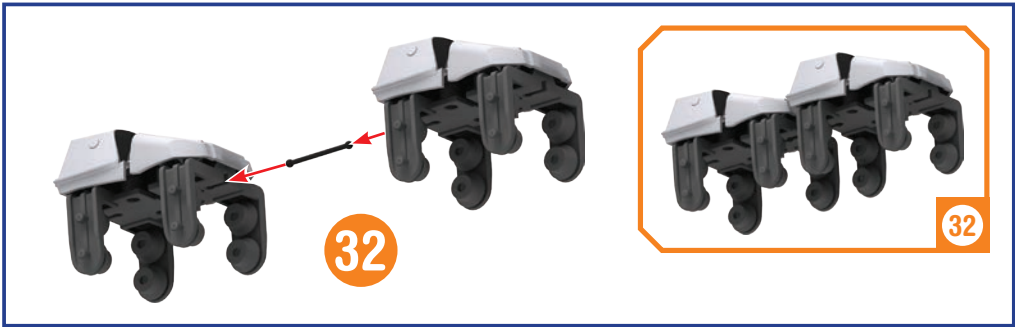

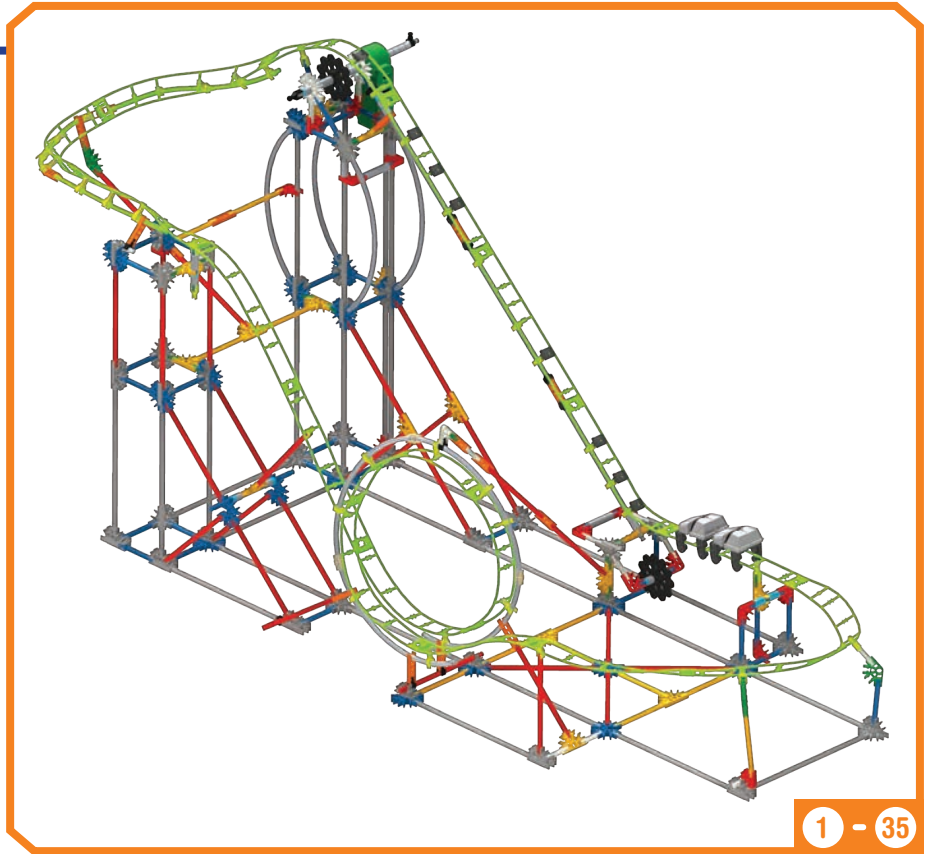
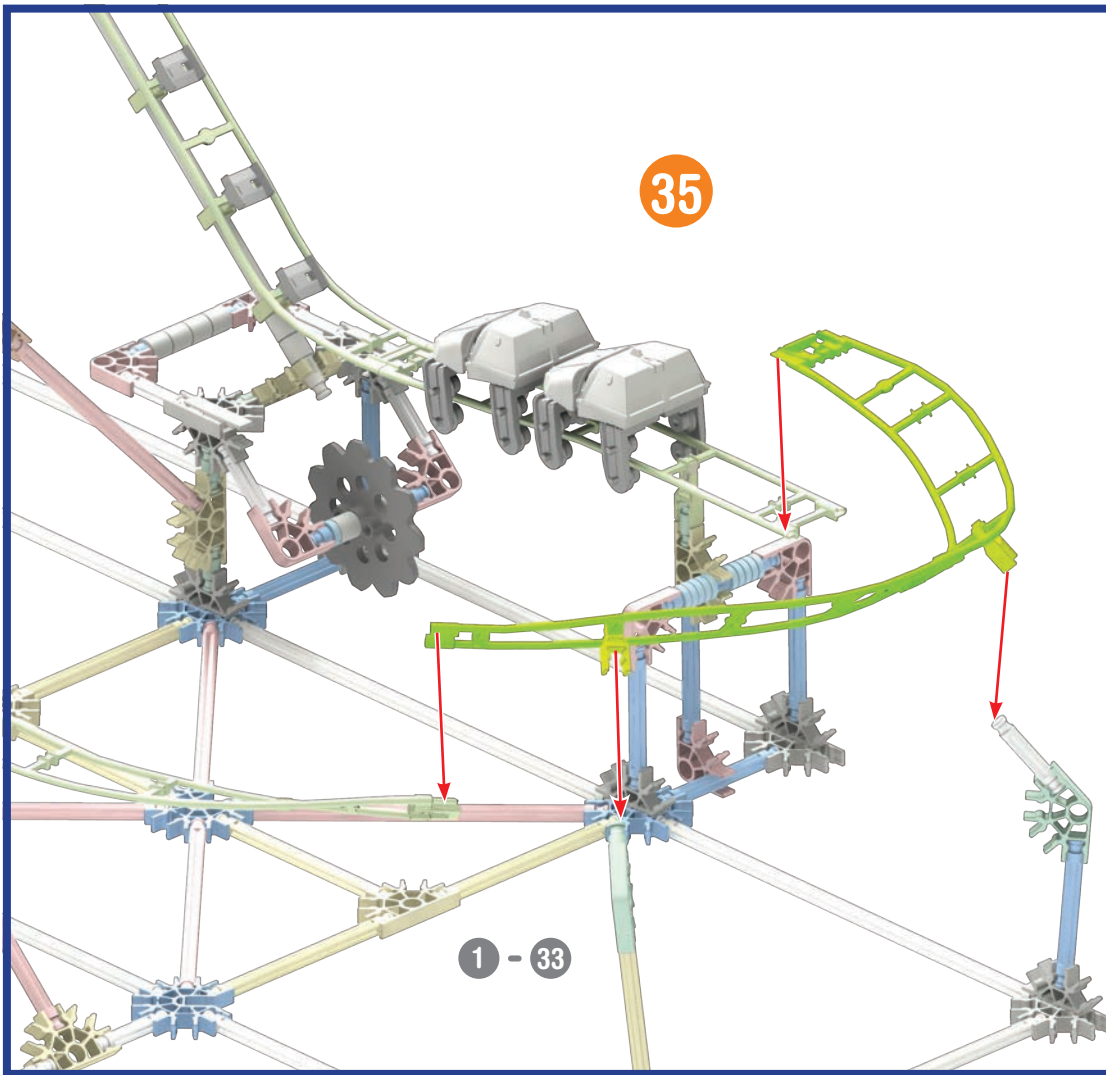
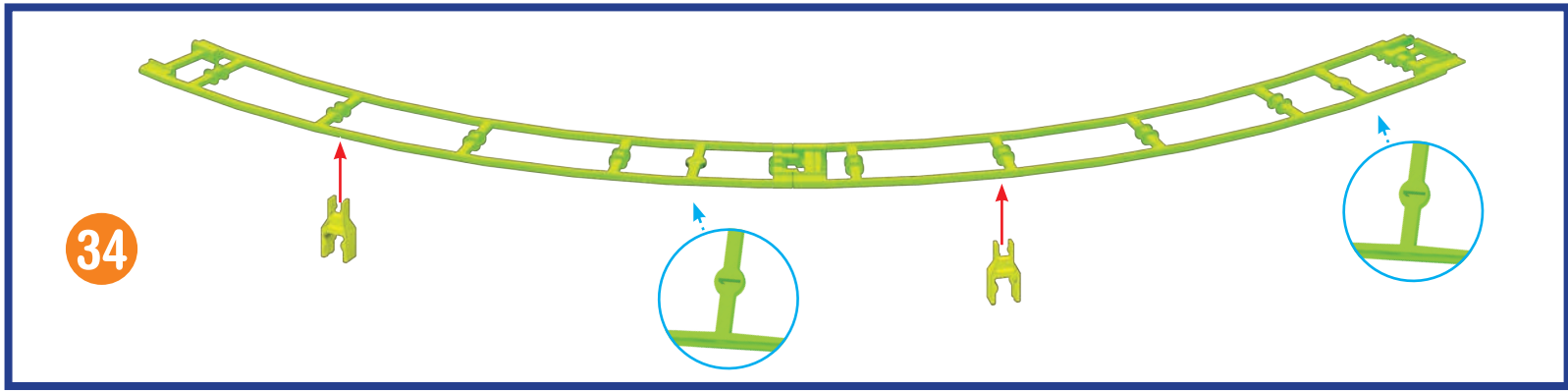

**IMPORTANT:**  
Attach all the chain links  
in the same direction.

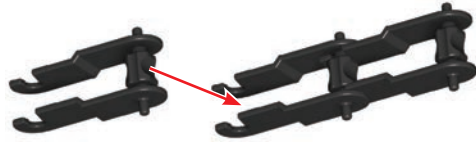

9 

36

  
x9



100 

37

  
x10

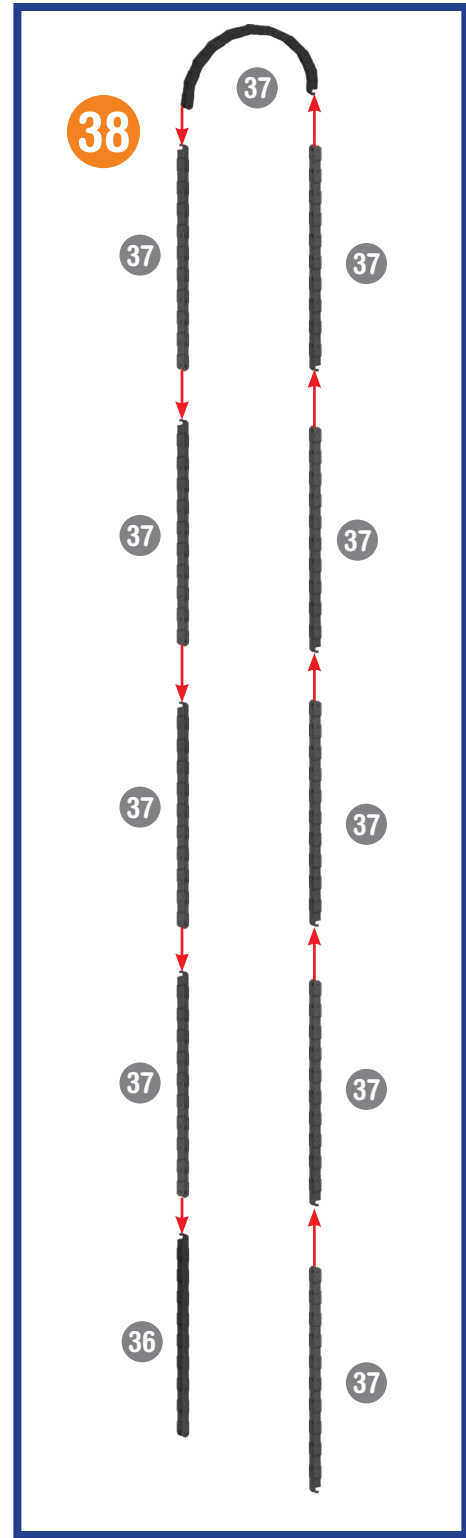
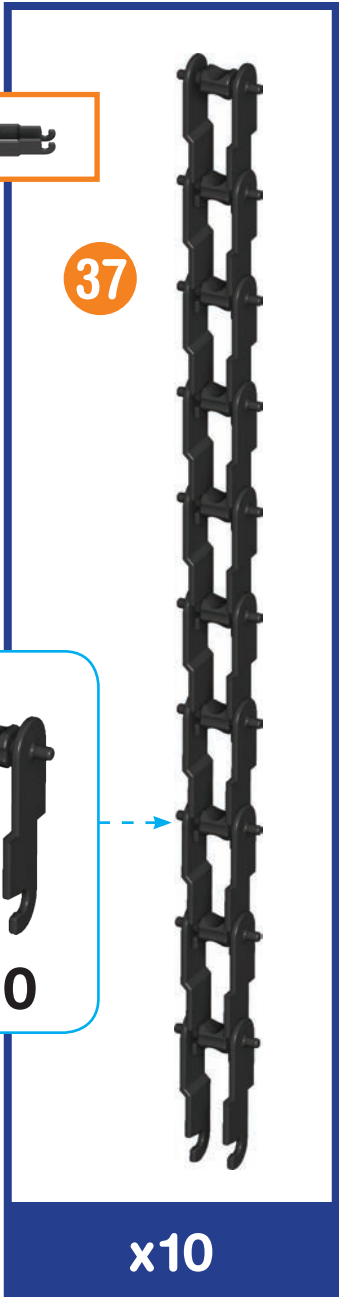



# WILD WARP ROLLER COASTER

39

1 - 39

1 - 38

