

Boom Ride

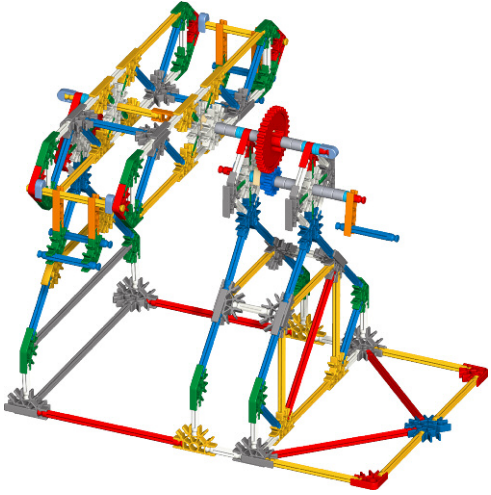

Le « Boom »

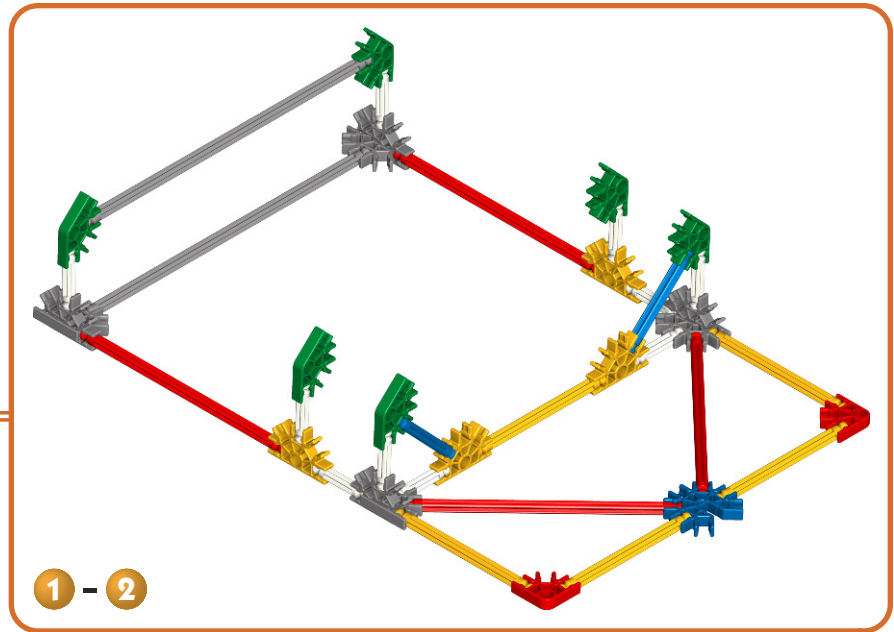

1 - 2

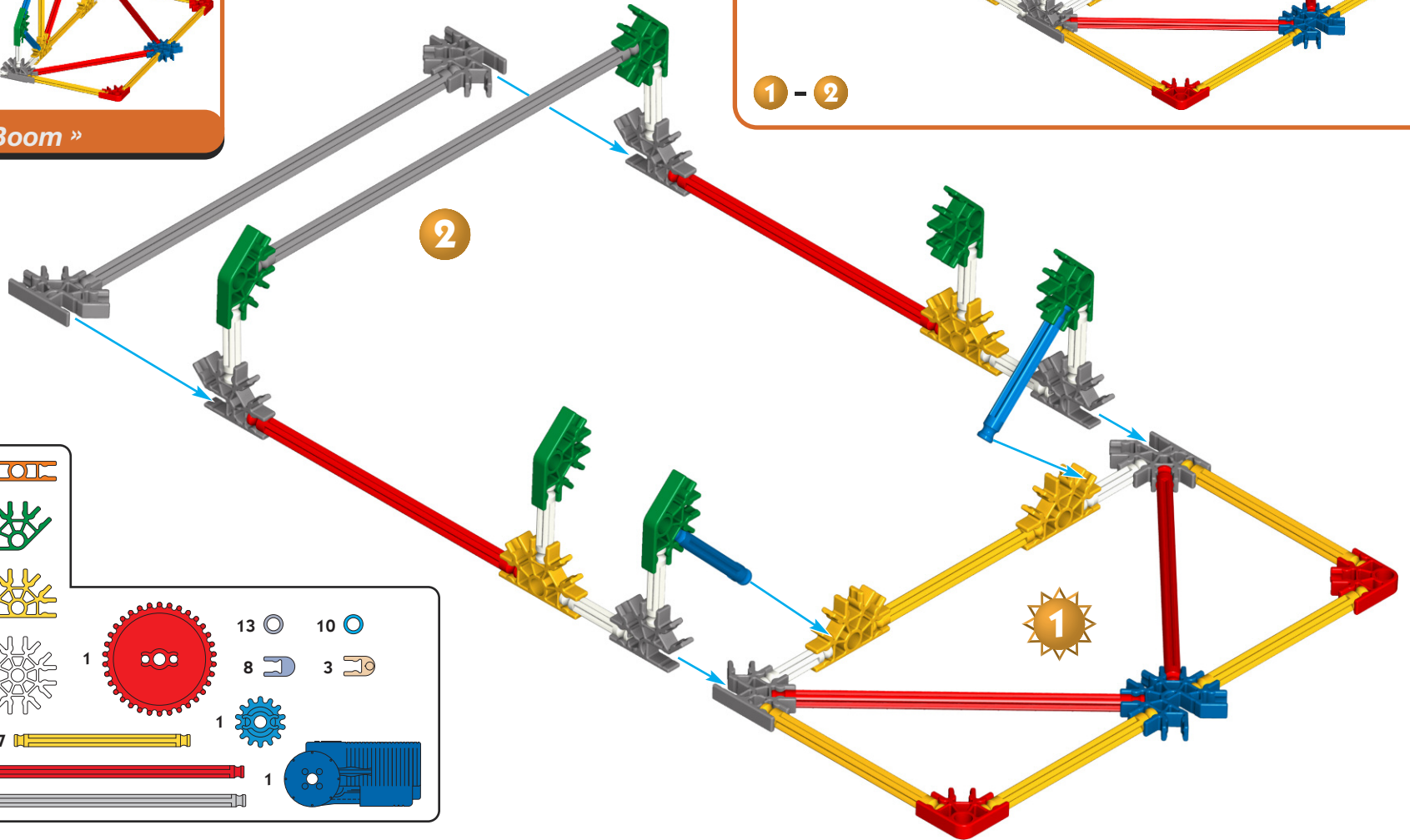

- | | | | |
|----|--|----|--|
| 11 | | 6 | |
| 28 | | 18 | |
| 4 | | 14 | |
| 32 | | 6 | |
| 29 | | 1 | |
| 40 | | 13 | |
| 2 | | 8 | |
| | | 10 | |
| | | 3 | |
| | | 1 | |
| | | 1 | |
| | | 17 | |
| | | 7 | |
| | | 1 | |

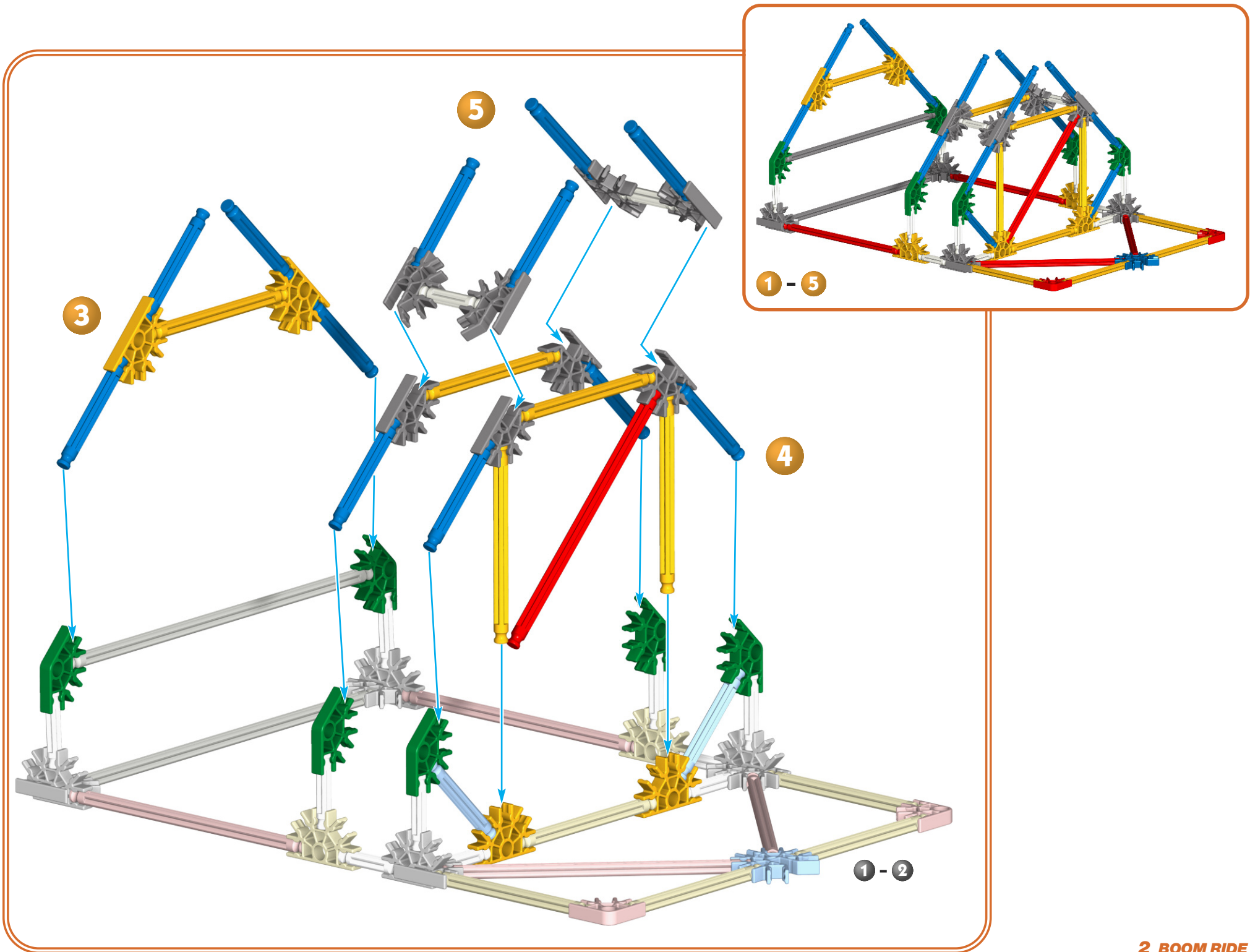

3 BOOM RIDE

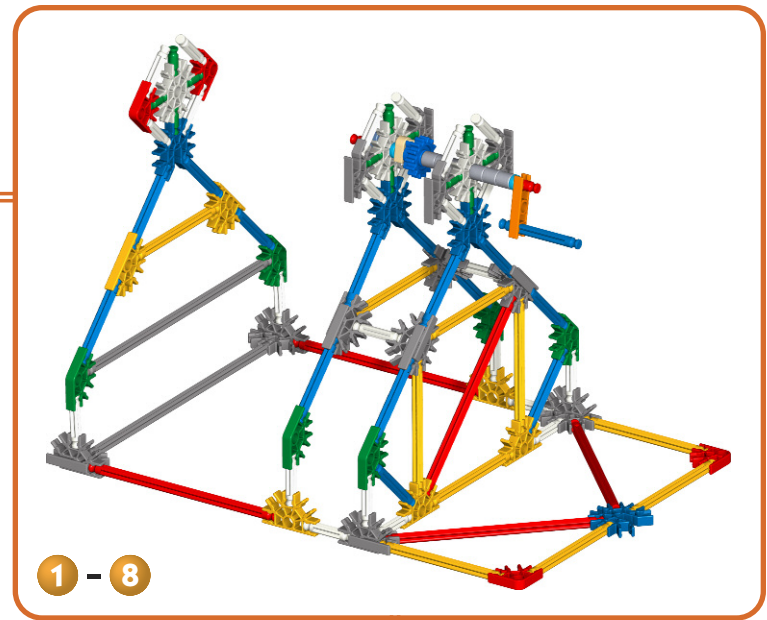
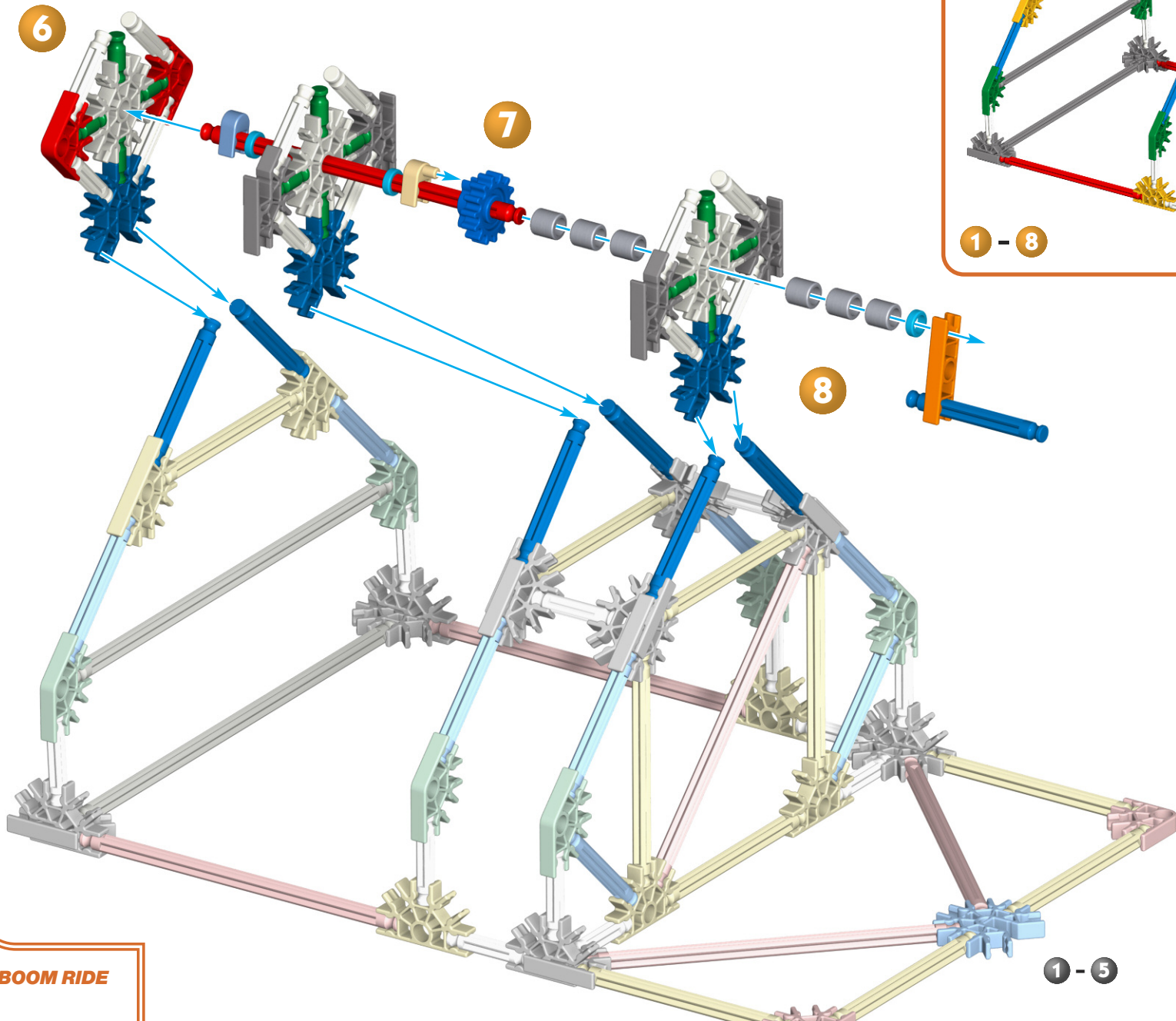

1 - 5

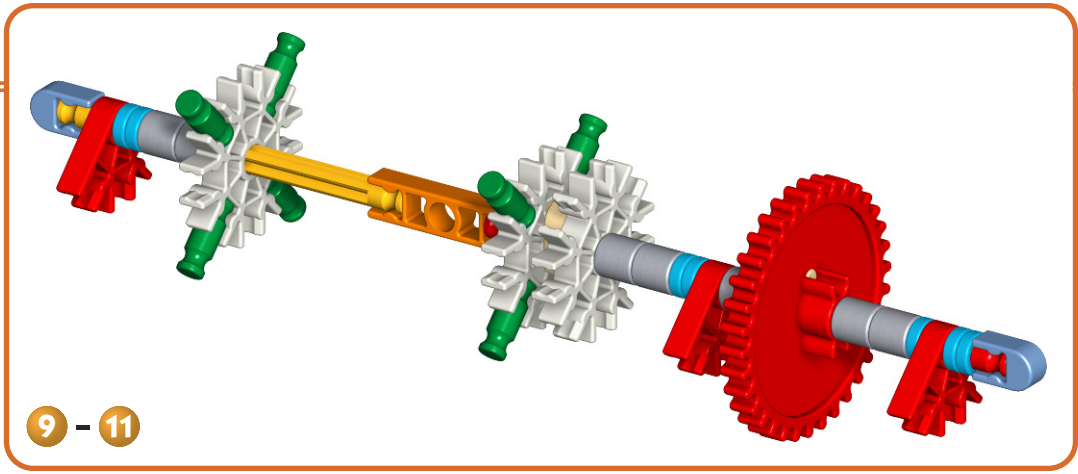
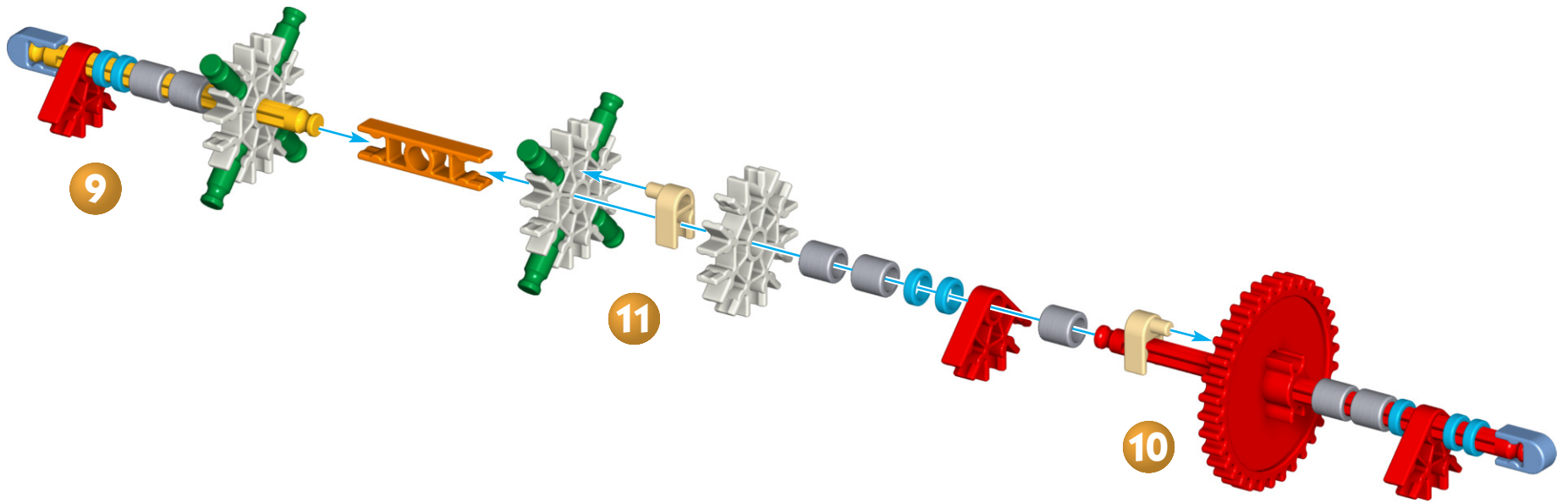

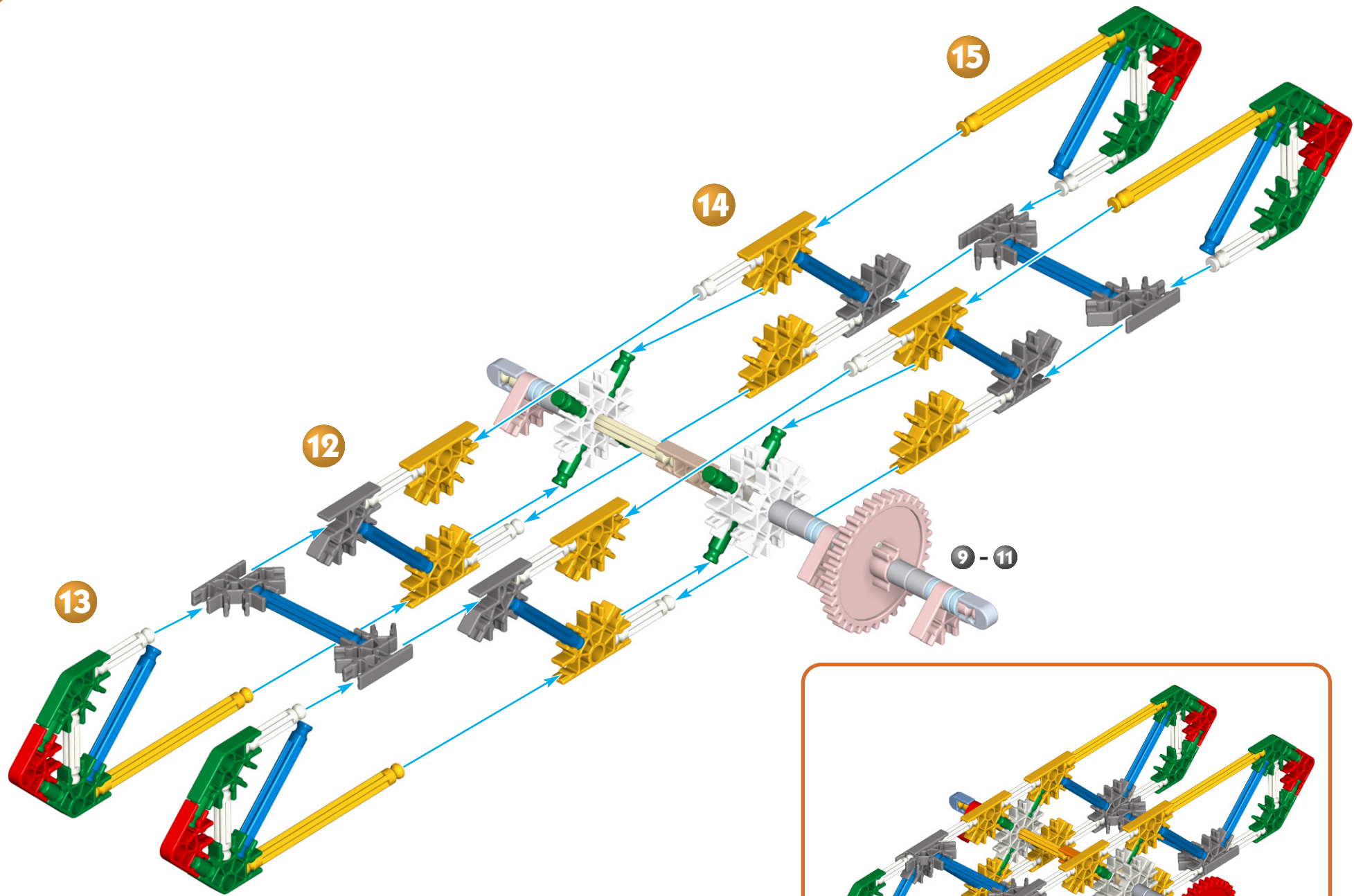

9 - 11

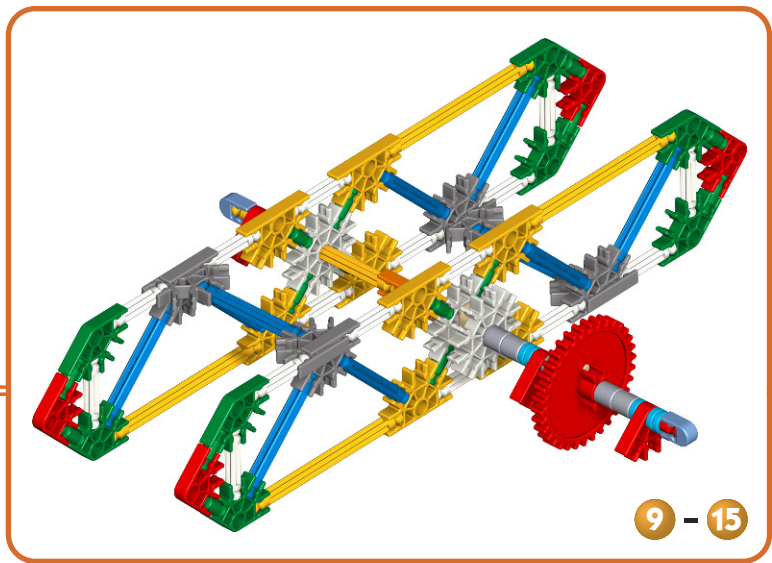

9 - 15

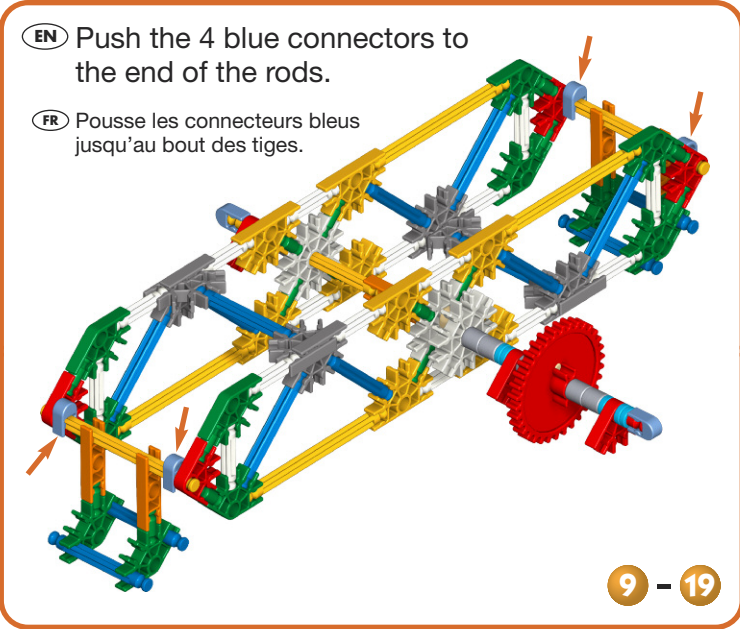
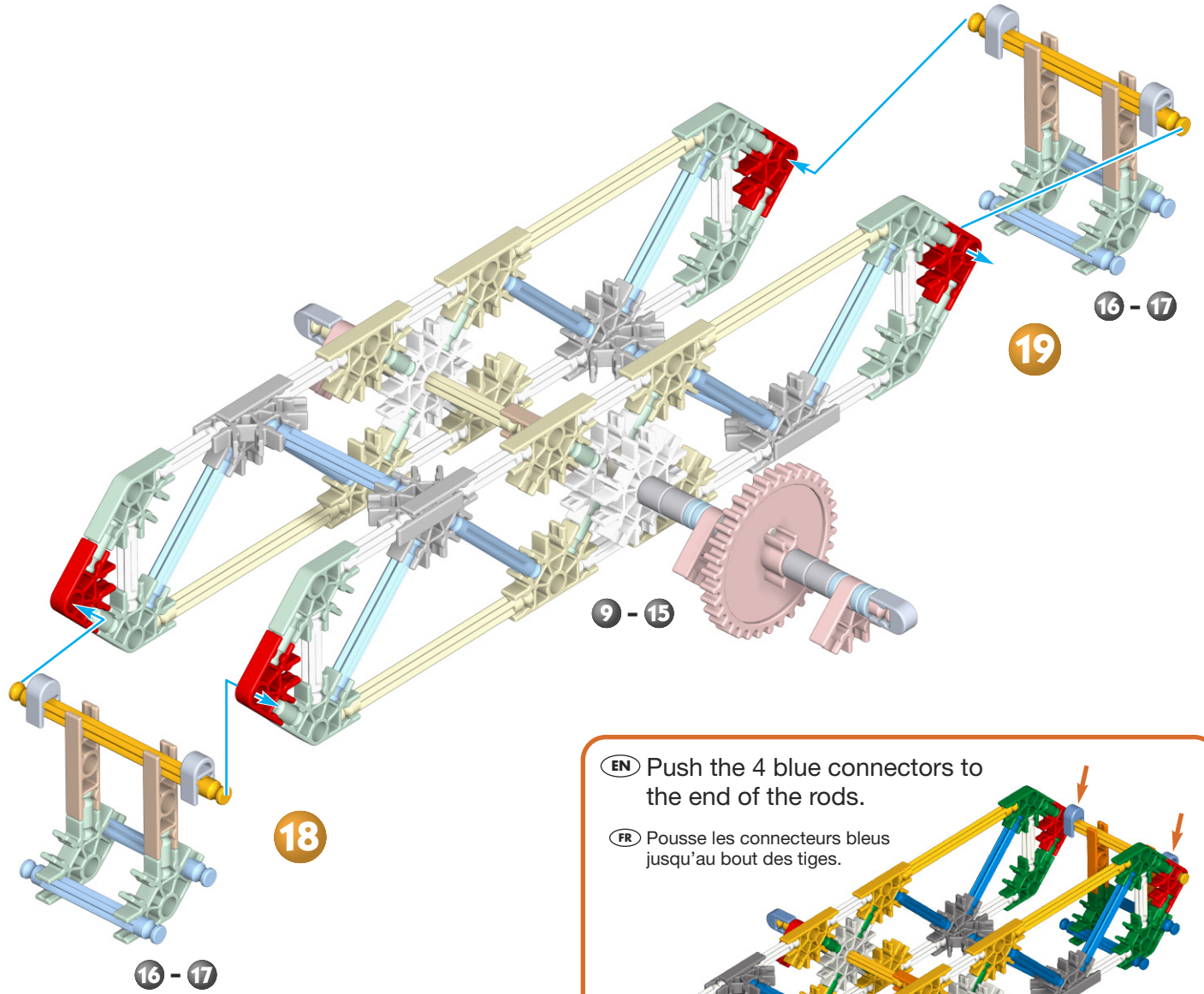
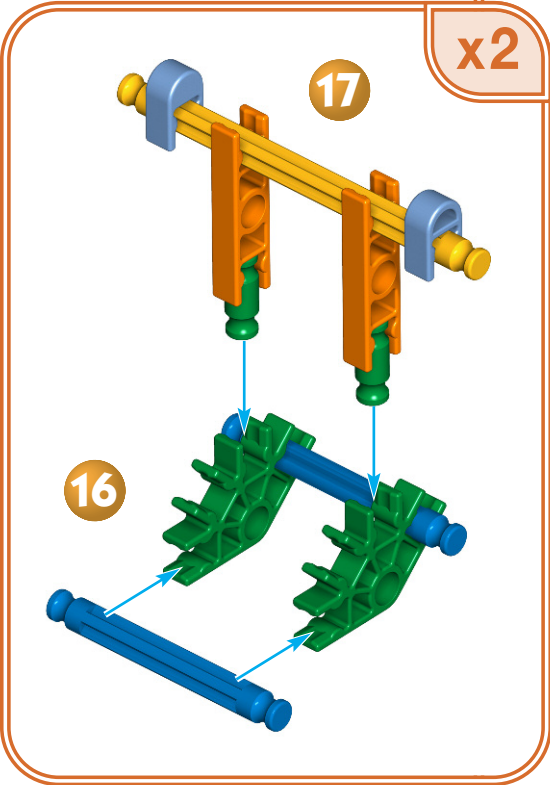

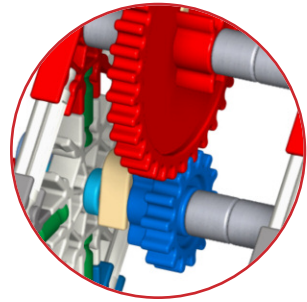
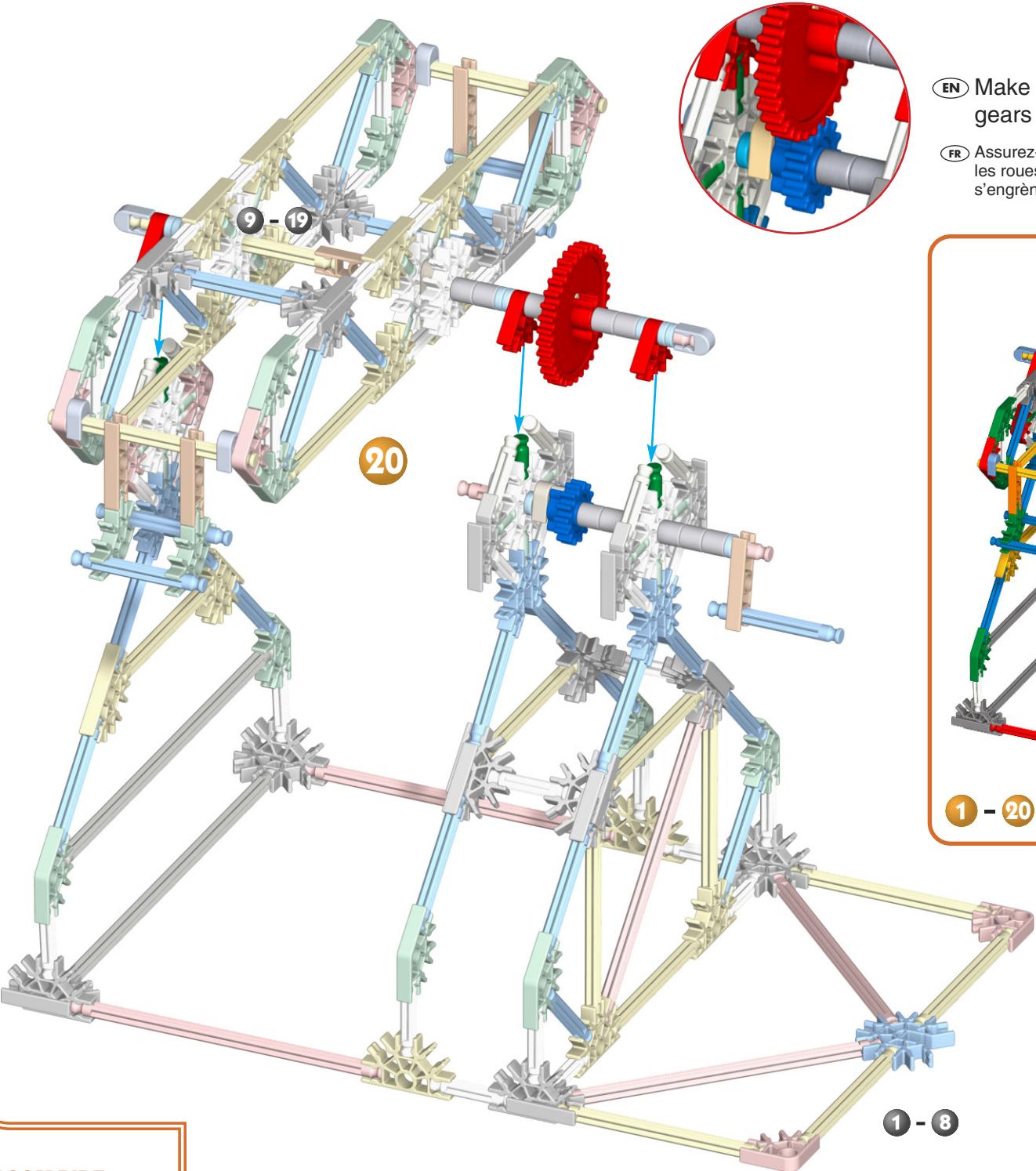

EN Make sure the gears mesh.
FR Assurez-vous que les roues dentées s'engrènent.

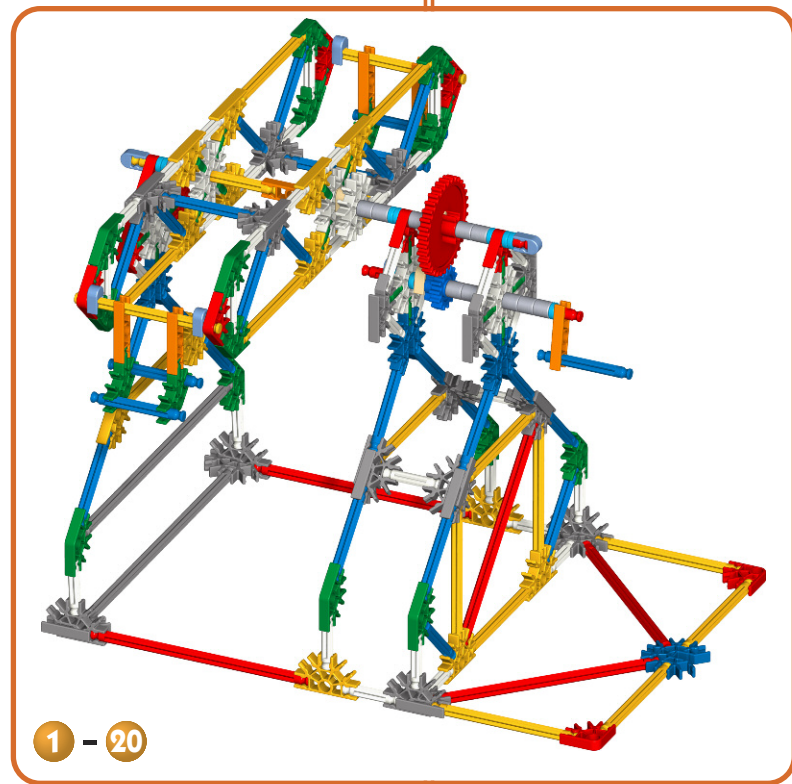

1 - 8

EN **Alternate Builds**

FR **Autres manières de construire**

VERSION 2

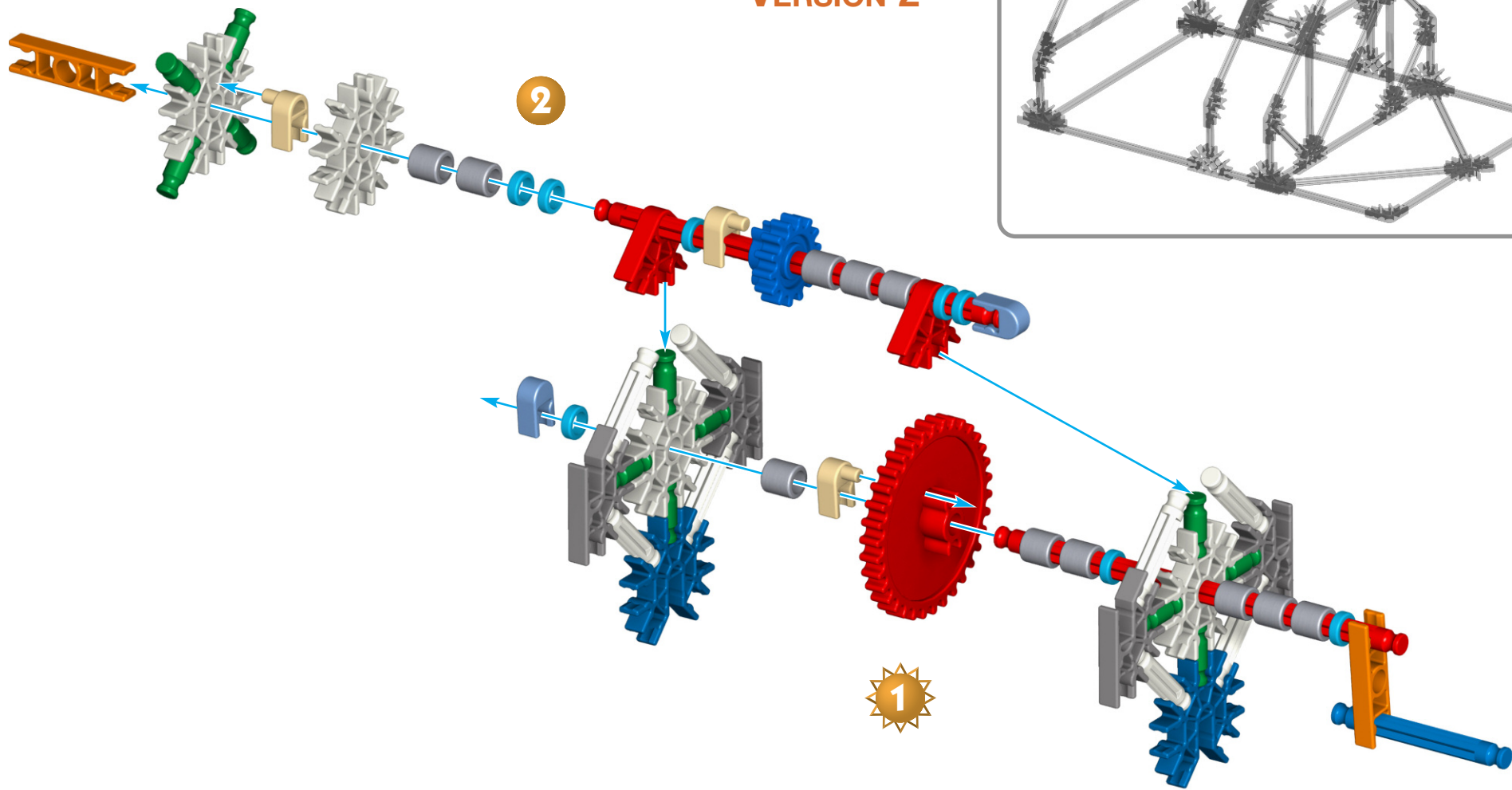

VERSION 3

EN Motorized

FR Motorisé

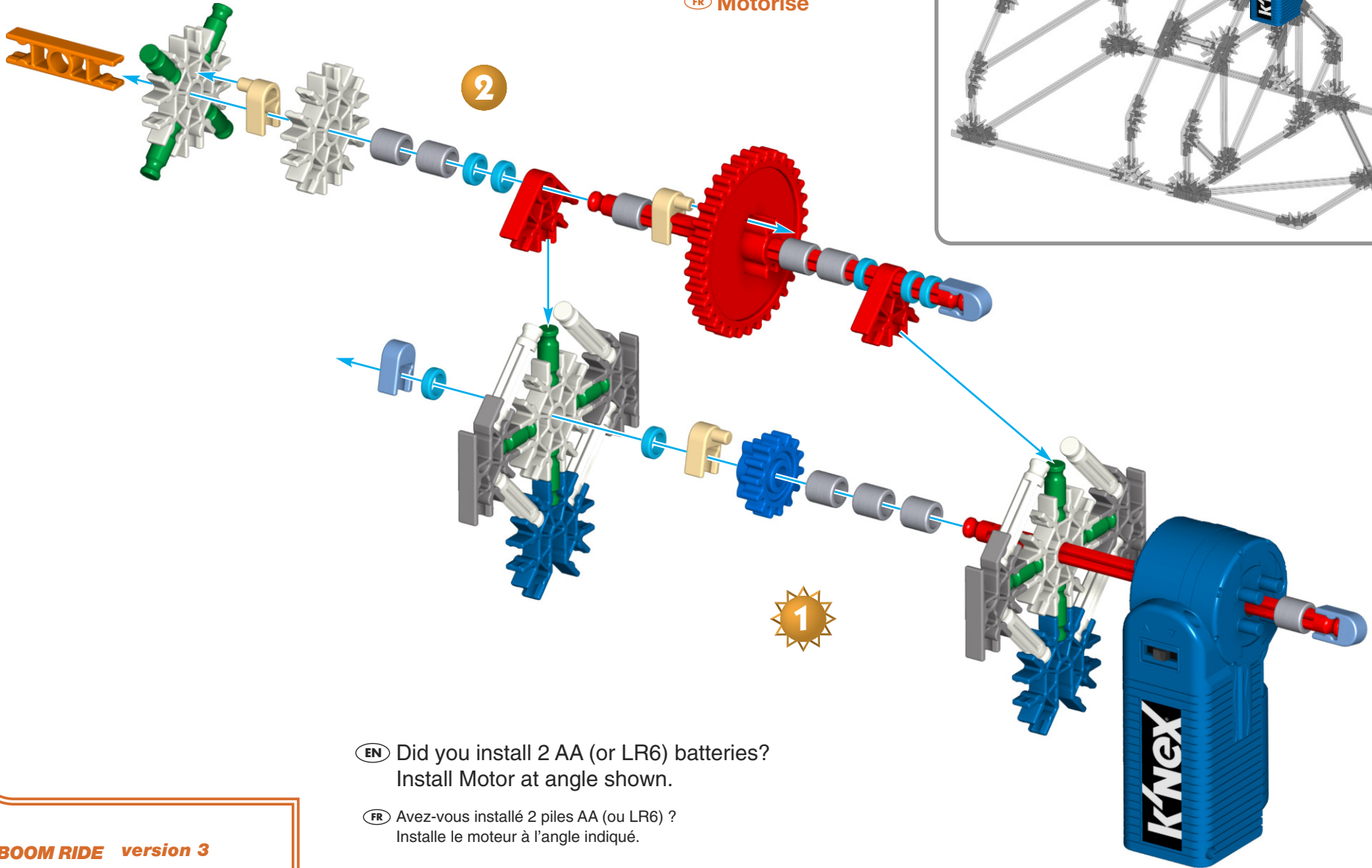

EN Did you install 2 AA (or LR6) batteries?
Install Motor at angle shown.

FR Avez-vous installé 2 piles AA (ou LR6) ?
Installe le moteur à l'angle indiqué.

VERSION 4

EN Motorized

FR Motorisé

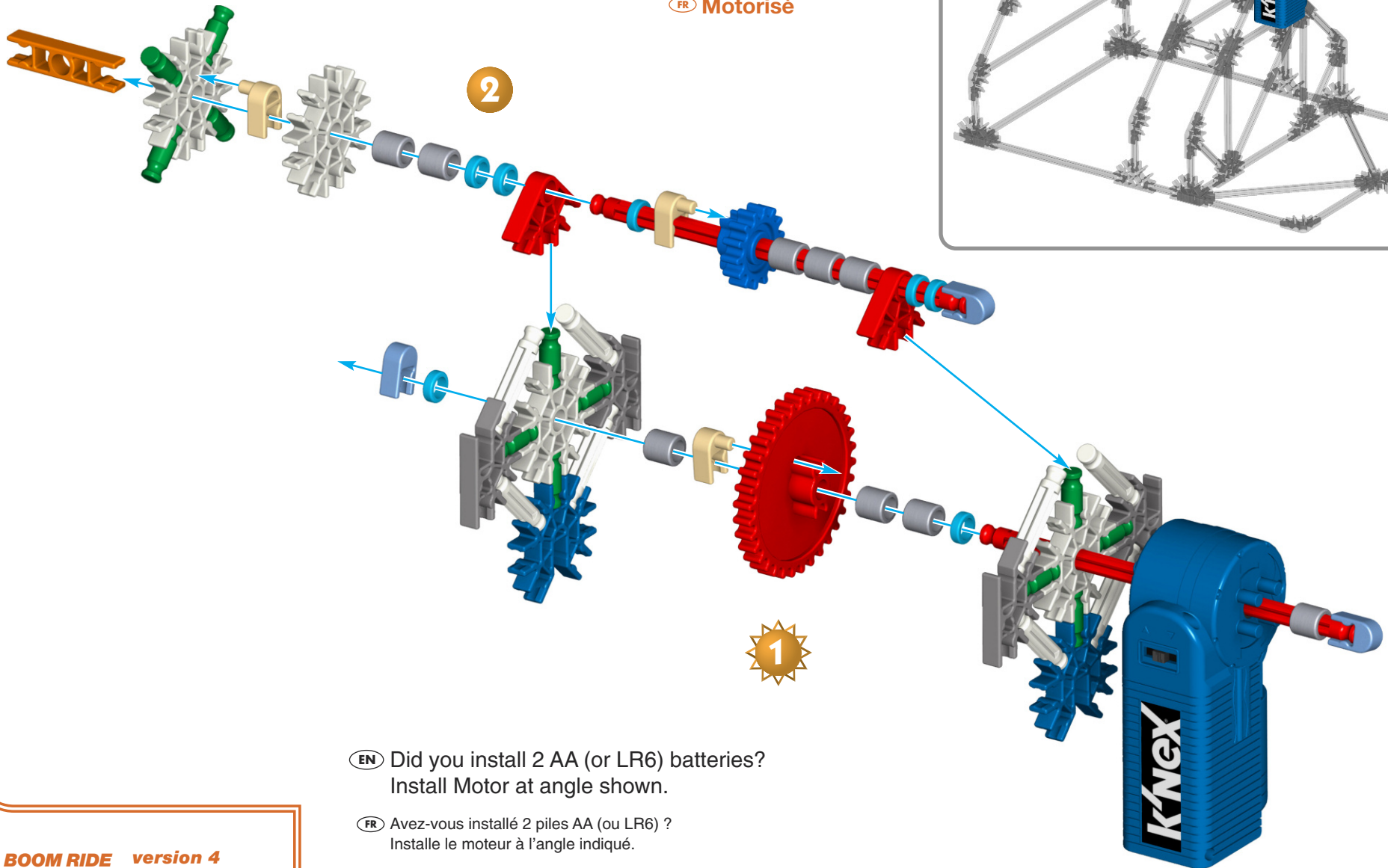

EN Did you install 2 AA (or LR6) batteries?
Install Motor at angle shown.

FR Avez-vous installé 2 piles AA (ou LR6) ?
Installe le moteur à l'angle indiqué.