

Swing Ride II

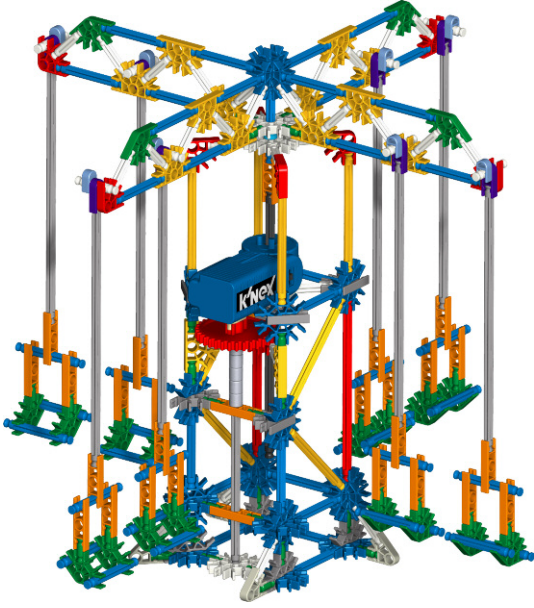

La Balançoire 2

(EN) Did you install 2 AA (or LR6) batteries? Install the motor at same angle shown.

(FR) Avez-vous installé 2 piles AA (ou LR6) ? Installe le moteur à l'angle indiqué.

8		2		8		28	
4		9		20		14	
10		20		4			
4		6					
52		8					
42		2					
9							
1							
40							
1		1		1			

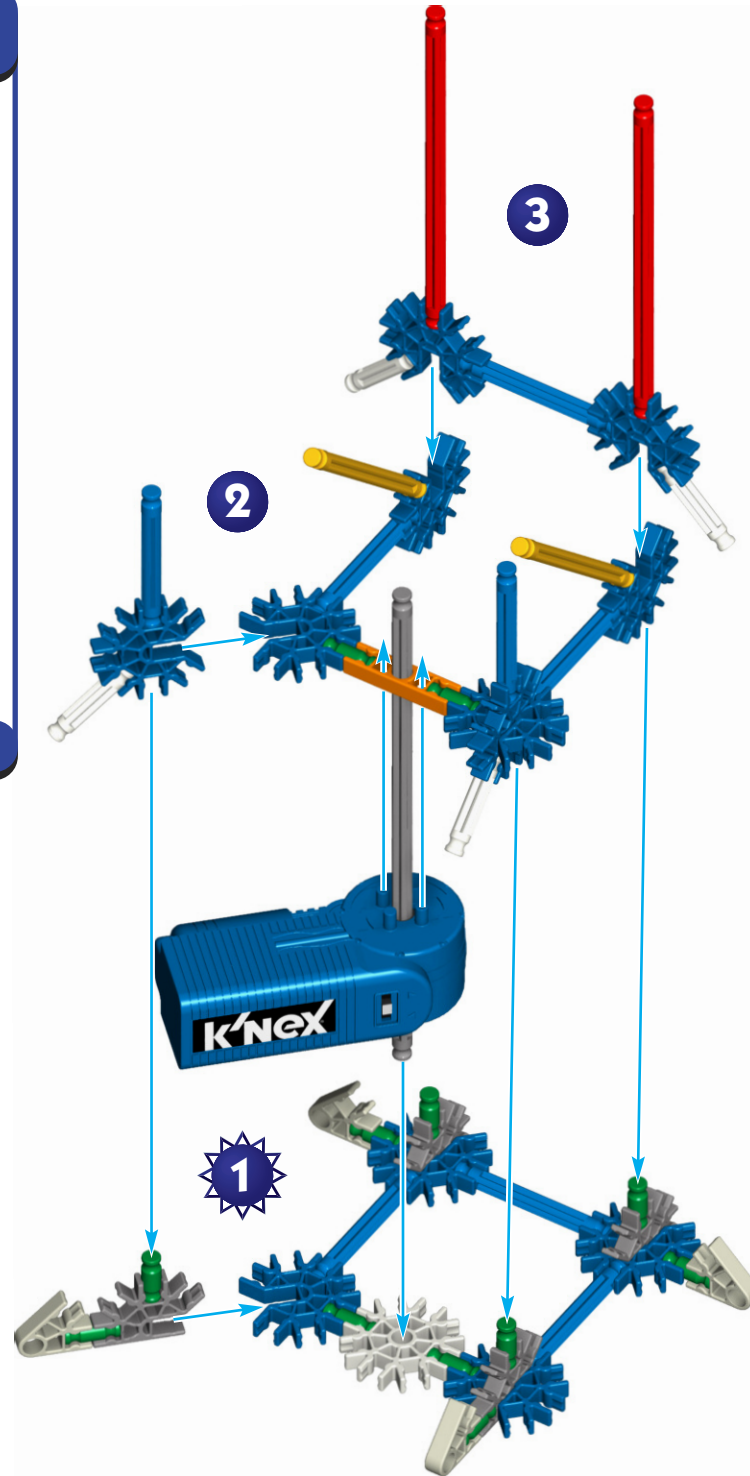

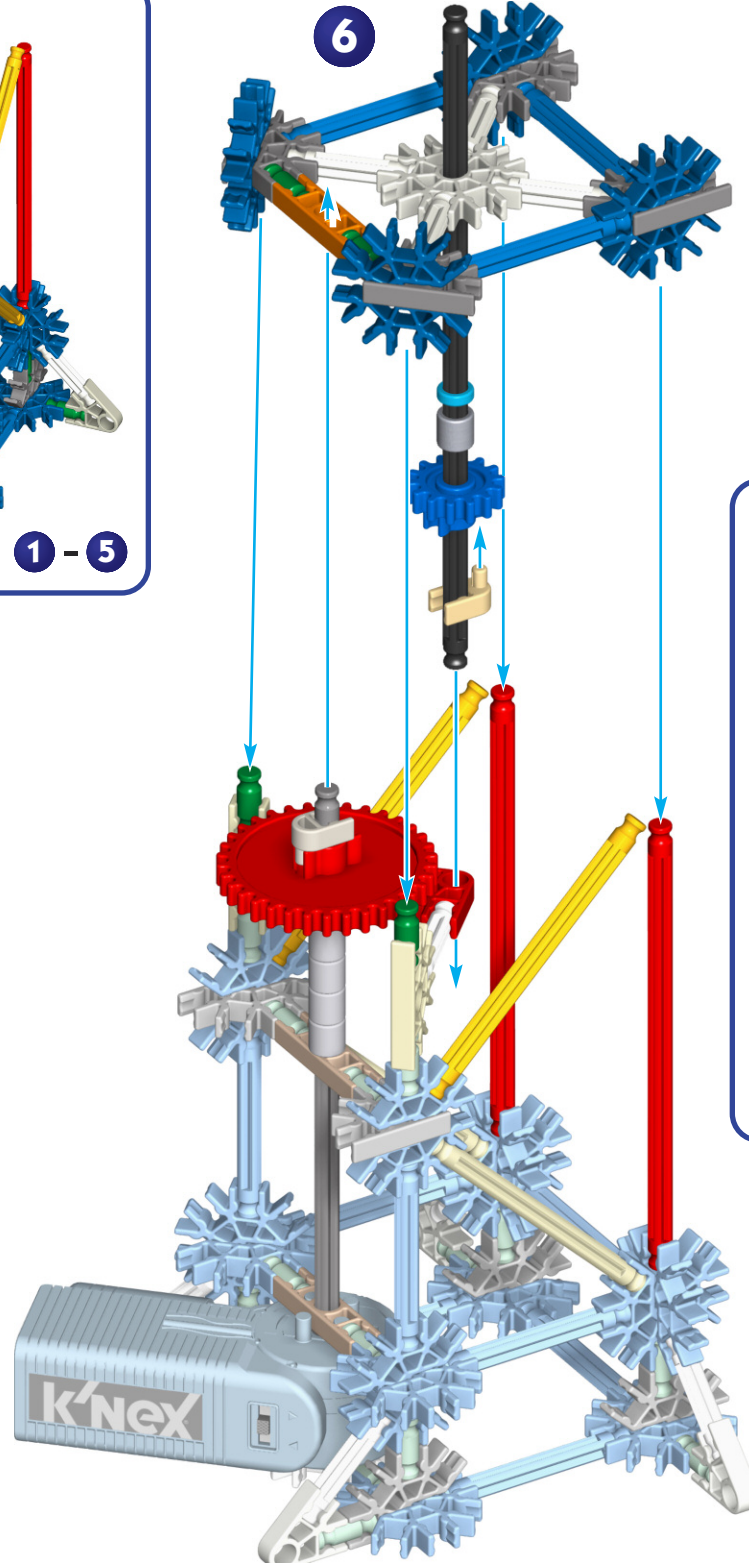
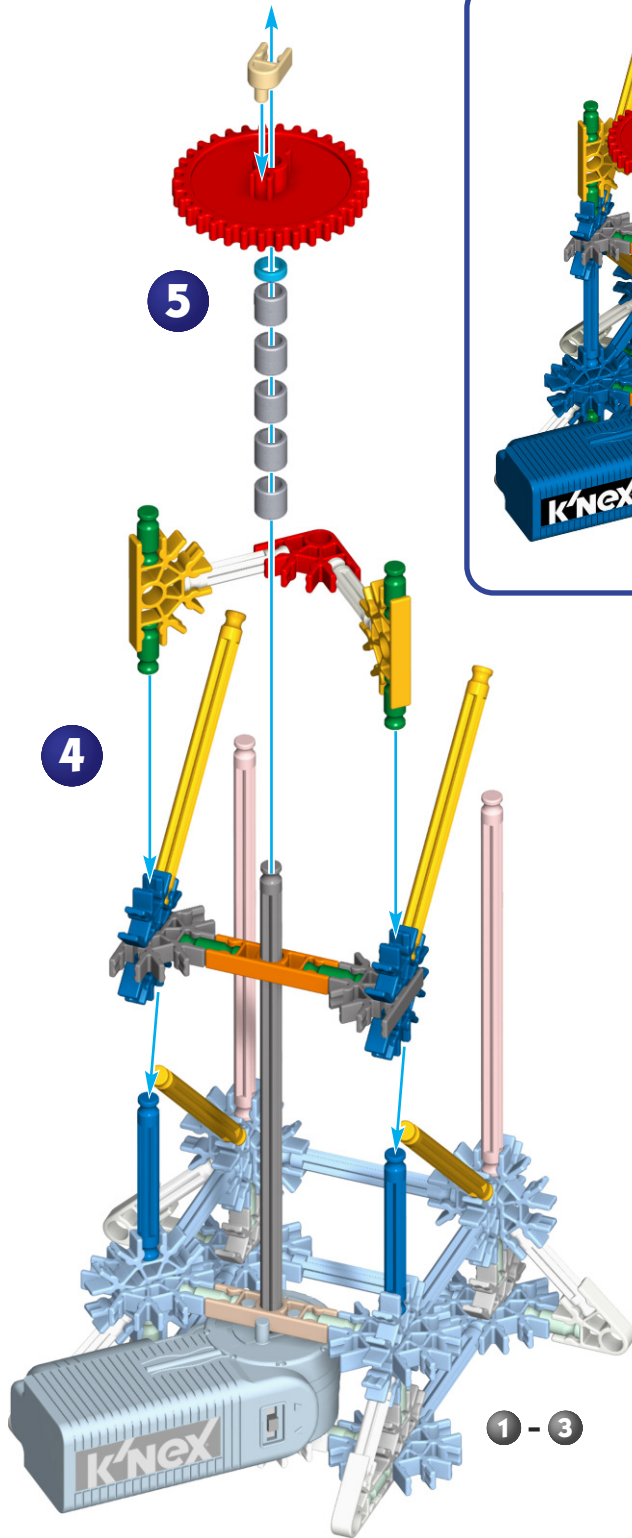

EN Make sure the gears mesh.

FR Assurez-vous que les roues dentées s'engrènent.

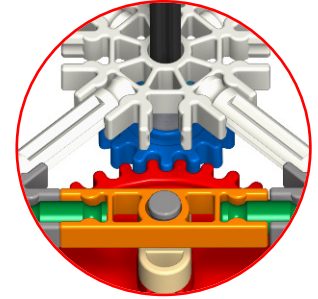

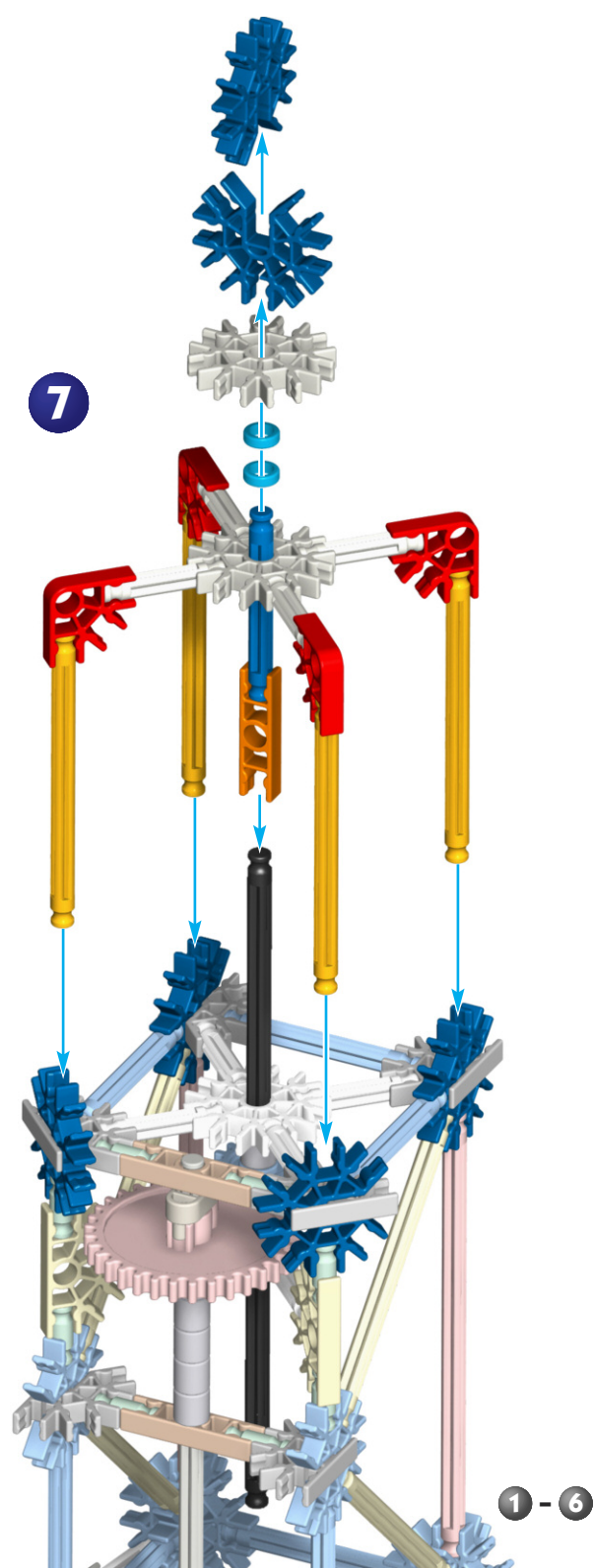

1 - 6

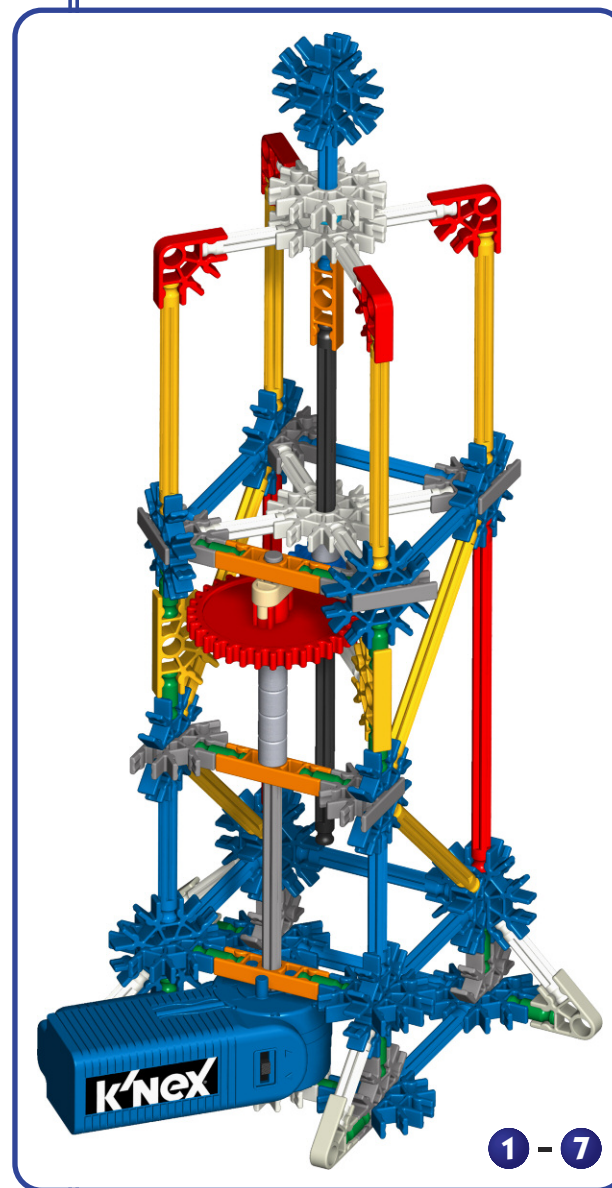

1 - 7

x4

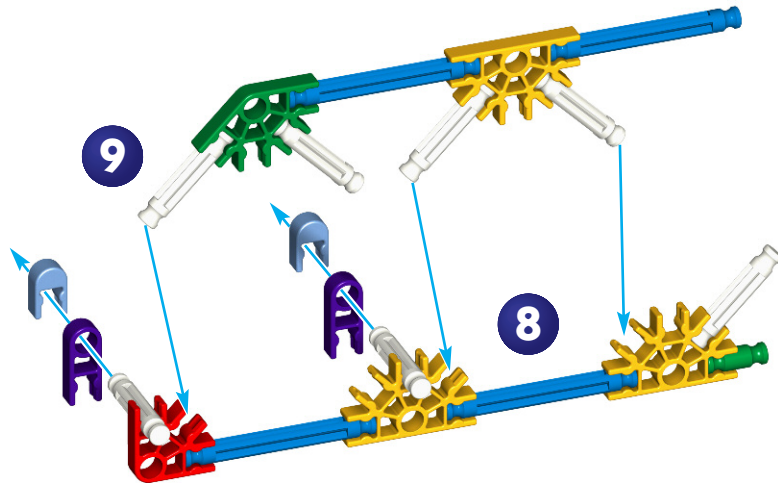

x4

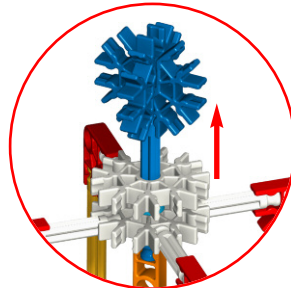
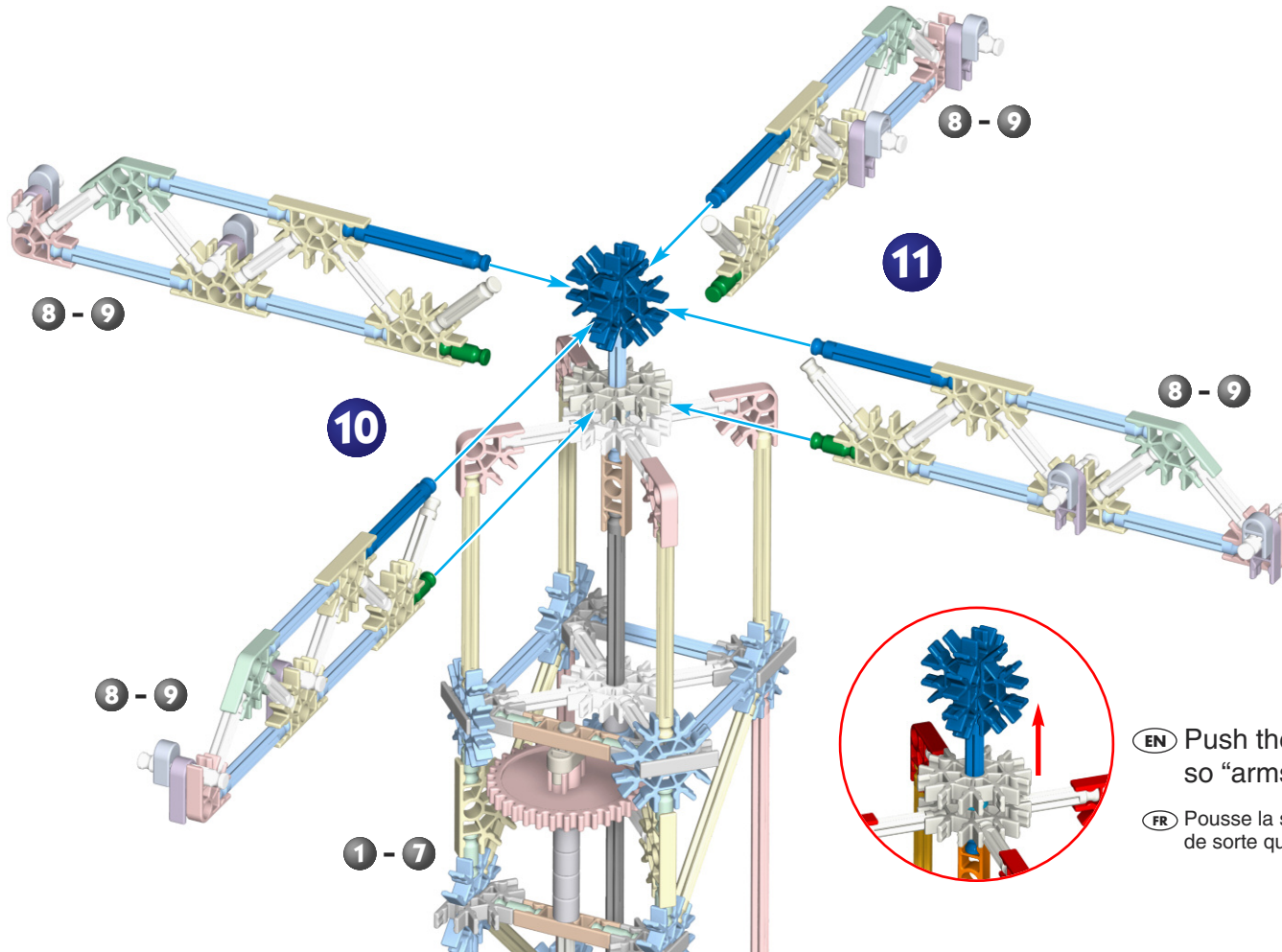
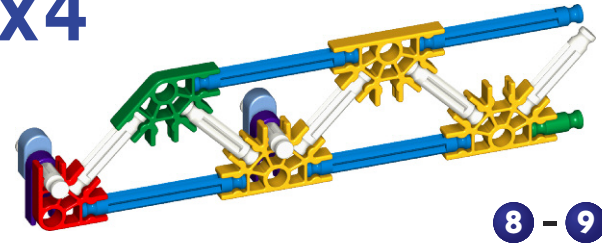

(EN) Push the center blue rod section up so "arms" can connect.

(FR) Pousse la section des tiges du centre vers le haut de sorte que les « bras » puissent se connecter.

x8

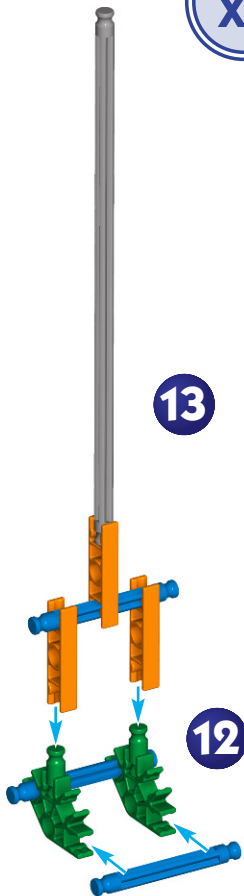

13

12

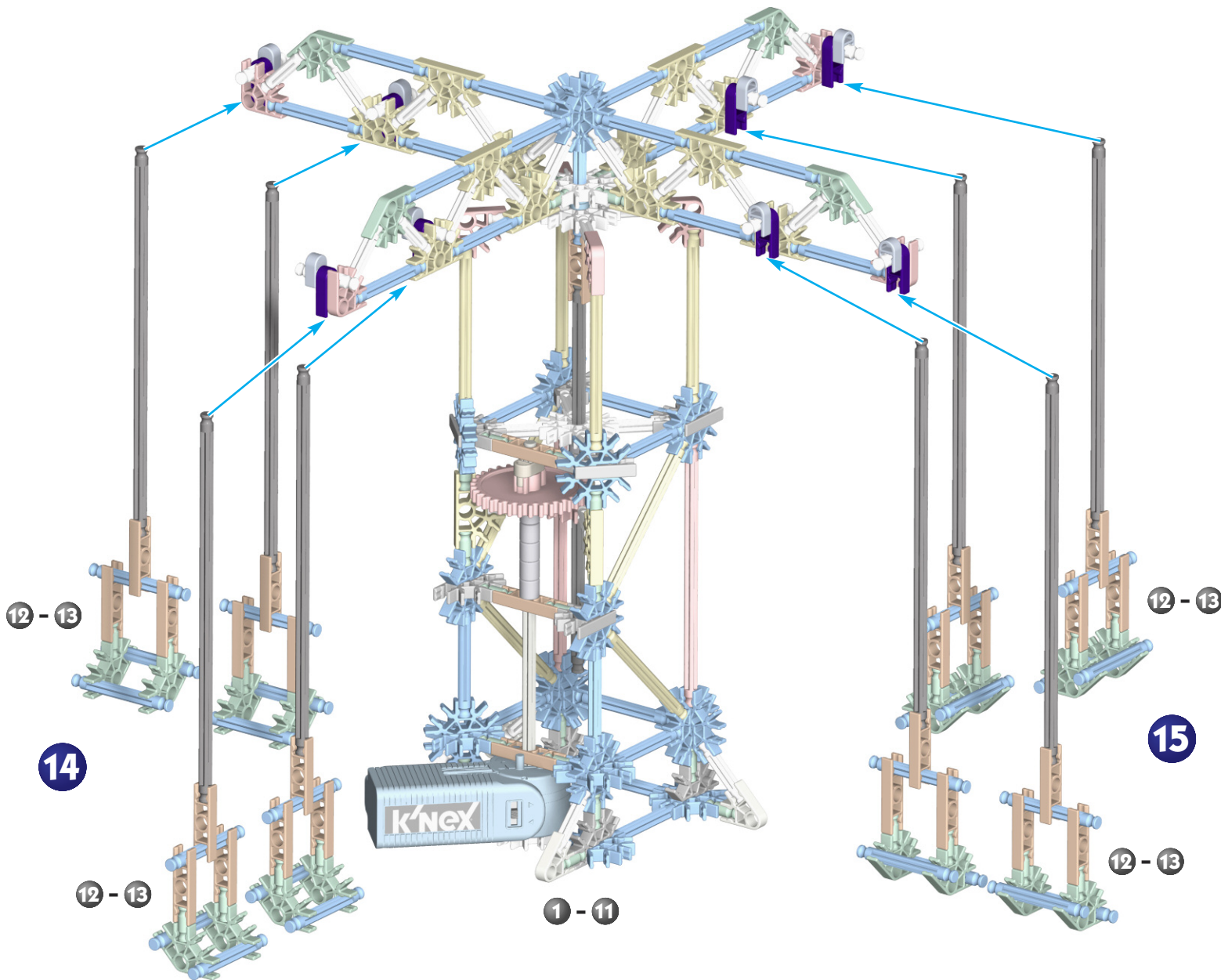

12 - 13

14

12 - 13

1 - 11

12 - 13

15

12 - 13

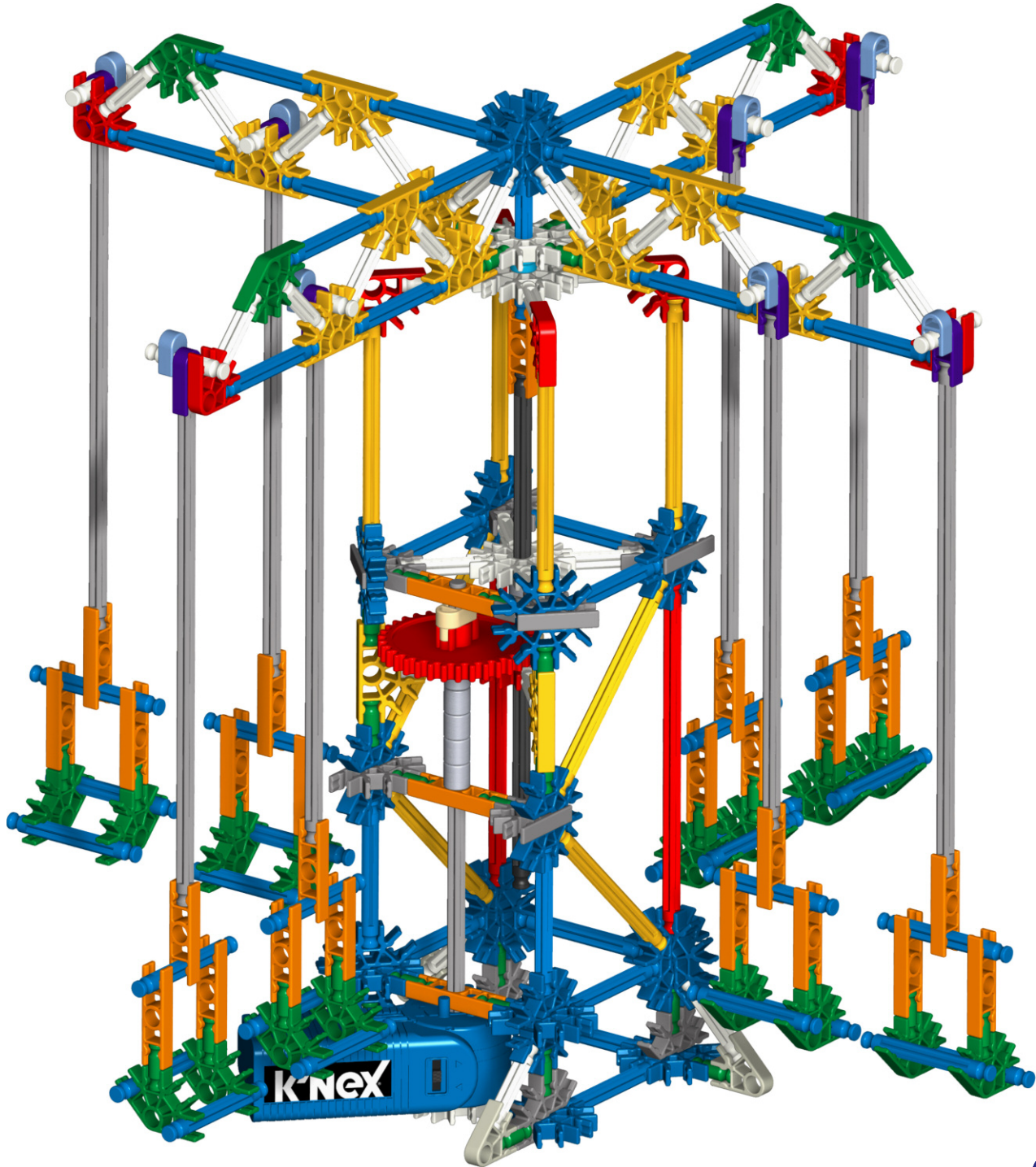

1 - 15