

KNEX®

Education

K-8 CONSTRUCTION SET™ BOOK/LIVRE 2

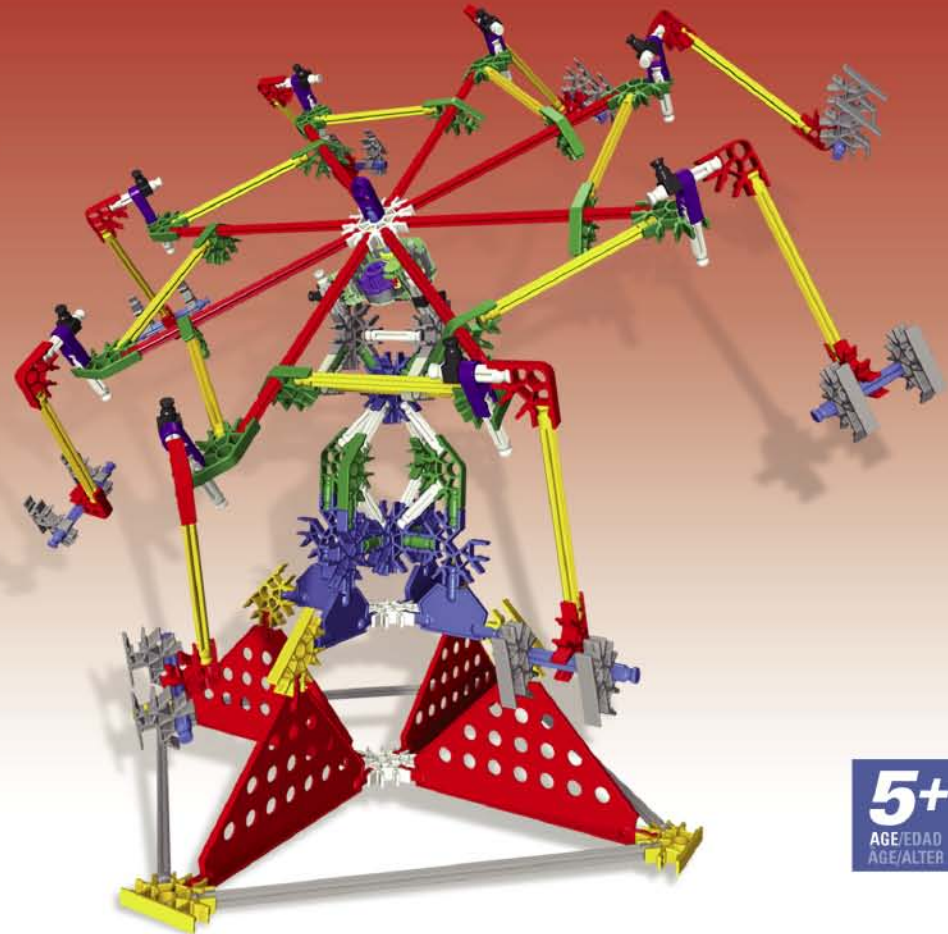

WARNING:

CHOKING HAZARD - Small parts.
Not for children under 3 years.



AVERTISSEMENT :

DANGER D'ÉTOUFFEMENT - Pièces de petite taille.
Ne convient pas aux enfants de moins de 3 ans.

5+
AGE/EDAD
AGE/ALTER

79818

Speedy Bird	
Oiseau rapide	4
CD Holder	
Détenteur de CD.	5
Small Picture Frame	
Petit encadrement	6
Large Picture Frame	
Encadrement de grande.	7
Trolley Car	
Tramway	8
Dragster	
Dragster	10
Trike	
Tricycle	12
Covered Wagon	
Chariot couvert	14
Space Transporter	
Transport spatial	16
Spider	
Araignée	18
Backhoe	
Backhoe.	21
Road Grader	
Niveleuse route	24

Ferris Wheel	
Roue de ferris.	27
Golf Cart	
Chariot de golf	30
Praying Mantis	
Mantis de prière.	32
Helicopter	
Hélicoptère.	34
Windmill	
Moulin à vent	38
Spaceship Ride	
Tour de vaisseau spatial	40
Robot	
Robot	43
Formula Car	
Voiture de formule	46
Sport Bike	
Bicyclette sportive	49
Camera	
Appareil de photo	52
Boom Ride	
Tour de perche	55
Octopus Ride	
Tour de poulpe	58

Boat Ride	
Tour de bateau	60
Hippo	
Hippopotame	64
Elephant	
Éléphant	66
Prop Plane	
Avion de propellar	69
Combine Harvester	
Moissonneuse-batteuse	73
Swing Ride	
Tour d'oscillation.	76
Exploration Vehicle	
Véhicule d'exploration	79
Radar Center	
Centre radar	84
Cherry Picker Truck	
La nacelle élévatrice	90
Dragon	
Dragon.	94
Space Shuttle	
Navette spatiale.	98

⚠ WARNING: CHOKING HAZARD - Small parts. Not for children under 3 years.

CAUTION: Keep hair, clothing and fingers away from moving parts.

WARNING: Not suitable for children under 18 months. Long cord/Long chain. Strangulation hazard.

⚠ AVERTISSEMENT : DANGER D'ÉTOUFFEMENT - Petites pièces. Ne convient pas aux enfants de moins de 3 ans.

ATTENTION : Gardez les pièces mobiles à l'écart des doigts, des vêtements et des cheveux.

AVERTISSEMENT : Ne convient pas aux enfants de moins de 18 mois. Longue corde/Longue chaîne. Risque d'étranglement.

⚠ ADVERTENCIA: PELIGRO DE ASFIXIA - Piezas pequeñas. No es para niños menores de 3 años.

PRECAUCIÓN: Mantén el pelo, la ropa y los dedos alejados de las piezas móviles.

ADVERTENCIA: No adecuado para niños menores de 18 meses. Cable largo/cadena larga. Peligro de estrangulamiento.

Figure Assembly.
Figure assemblage.
Figura ensamblaje.



Each K'NEX piece has its own color and shape; match it to pieces in the picture instructions. Put pieces together exactly as pictures show. Be sure to put rods in the correct slots of connectors, so you have proper angles in your finished model.

Chaque pièce K'NEX a une couleur et une forme bien à elle. Faites correspondre et montez les pièces les unes sur les autres en suivant exactement les instructions illustrées. Assurez-vous de bien assembler les tiges dans les fentes des connecteurs afin d'obtenir des angles corrects une fois le modèle fini.

Assurez-vous de bien assembler les tiges dans les fentes des connecteurs afin d'obtenir des angles corrects une fois le modèle fini. Asegurarse de colocar las varillas en las ranuras correctas de los conectores, de modo que al terminar el modelo, los ángulos sean los adecuados.

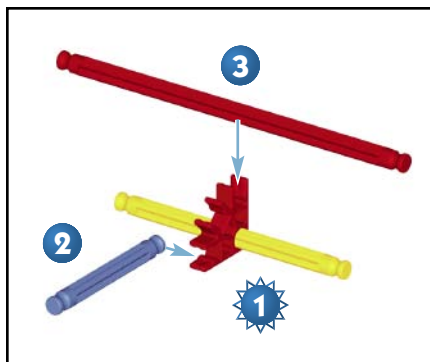

Faded colors indicate sections previously built; connecting points will be in full color.

Les couleurs plus claires indiquent les sections déjà construites. Les points de jonction sont indiqués en couleurs vives.

Los colores apagados indican secciones que ya han sido montadas anteriormente. Los puntos de conexión se indican con colores vivos.

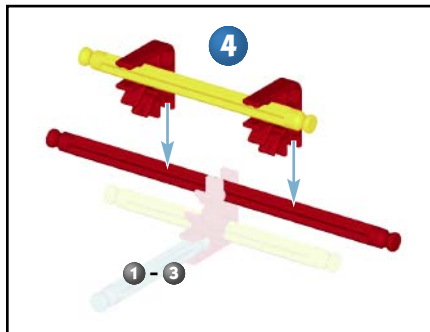

Pay close attention to the number of blue spacers needed.

Comptez bien le nombre de rondelles bleues nécessaires.

Prestar atención al número de espaciadores azules que se necesitan.

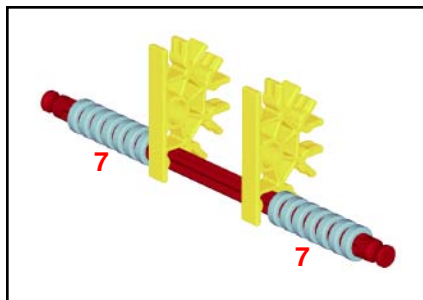

⚠ CAUTION: Rubber Bands can cause injury from snap-back, breaking, or loss of control. While assembling models shown in instructions, hold Rubber Band tightly, and do not overstretch. Use Rubber Bands only as shown in these instructions. DO NOT USE FRAYED OR TORN RUBBER BANDS. Caution: Keep Rubber Bands away from face and eyes.

⚠ ATTENTION : Les élastiques peuvent causer des blessures en claquant, en se cassant ou quand on les manipule imprudemment. Tenez fermement l'élastique lors de l'assemblage du modèle en veillant à ne pas trop le tendre. N'utilisez les élastiques que selon les instructions. N'UTILISEZ PAS D'ELASTIQUES ÉRAILLÉS OU DÉCHIRÉS. Attention : Tenez les élastiques en caoutchouc à l'écart du visage et des yeux.

⚠ PRECAUCIÓN: Las gomas pueden causar daños si se sueltan con fuerza, se rompen o se pierde su control. Al construir los modelos que se muestran en las instrucciones, sujetar bien la goma y no estirarla demasiado. Las gomas deben usarse únicamente como se indica en las instrucciones. NO USAR GOMAS QUE ESTÉN DESGASTADAS NI RASGADAS. Precaución: Mantenga las gomas elásticas alejadas de la cara y los ojos.

You can slide these special connectors together. Push tightly until you hear a "click". Pay close attention to the instructions and position them horizontally or vertically exactly as they are shown.

Les connecteurs bleus et gris ont une longue encoche spécialement conçue pour s'emboîter les unes dans les autres, tel qu'illustré. Bien les pousser ensemble jusqu'à ce qu'un dé clic se fasse entendre.

Se puede juntar estos conectores especiales deslizándolos. Empujar ligeramente hasta oír un "clic". Hace falta prestar mucha atención a las instrucciones y posicionar los conectores horizontal o verticalmente exactamente tal como se muestran.

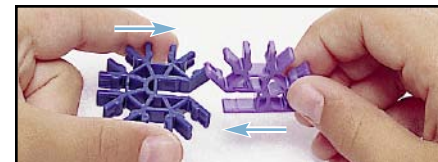
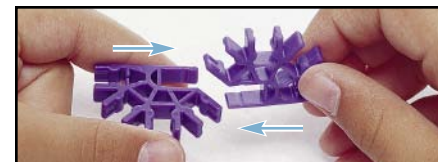
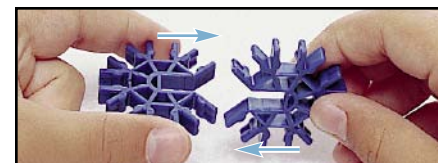

MicroPower motor: Wind until you hear clicking. Then release.

Moteur à MicroPower: Remontez jusqu'à ce que vous entendiez un clic. Puis, relâchez.

Motor de MicroPower: Da cuerda hasta escuchar un clic. Luego, suéltalo.

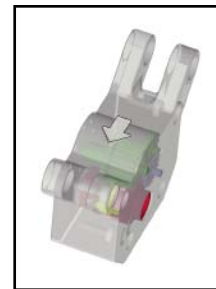

Speedy Bird Oiseau rapide

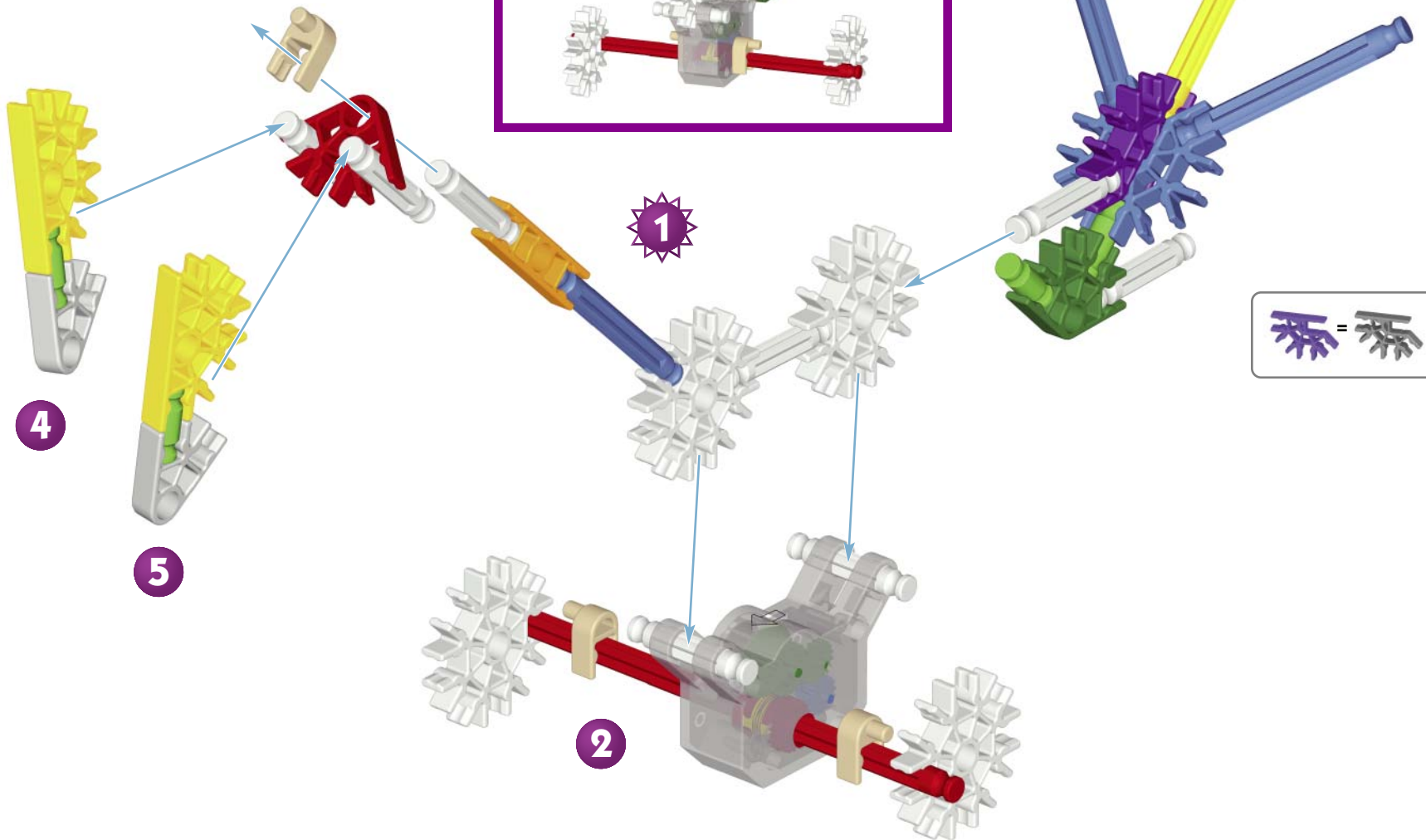
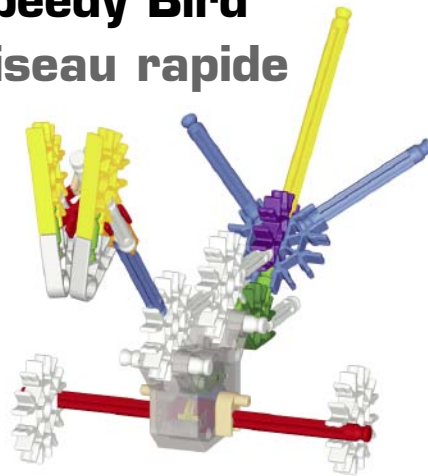

CD Holder Détenteur de CD

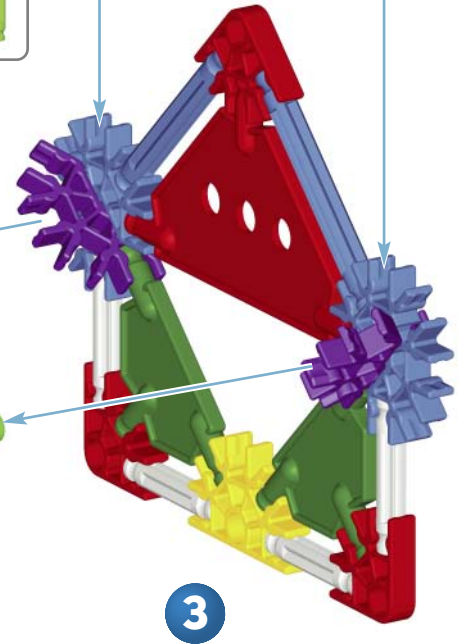
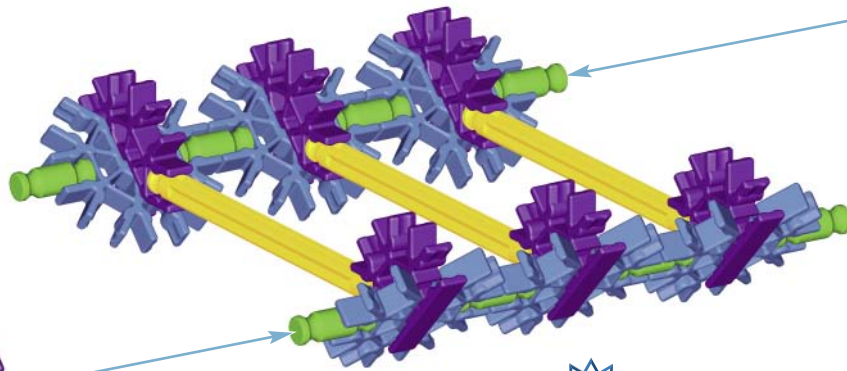
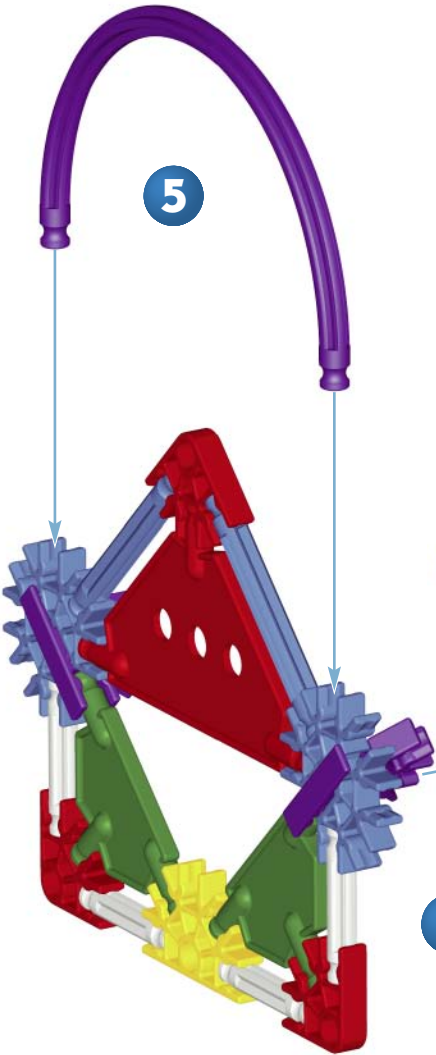
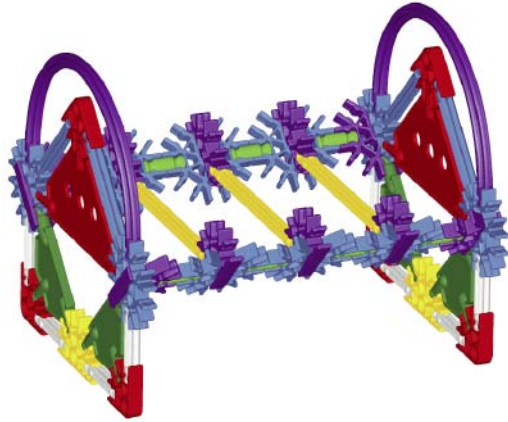

2

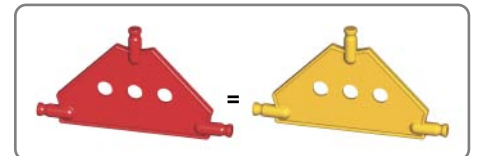
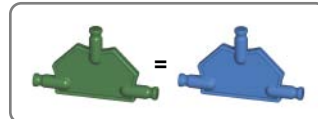

Small Picture Frame Petit Encadrement

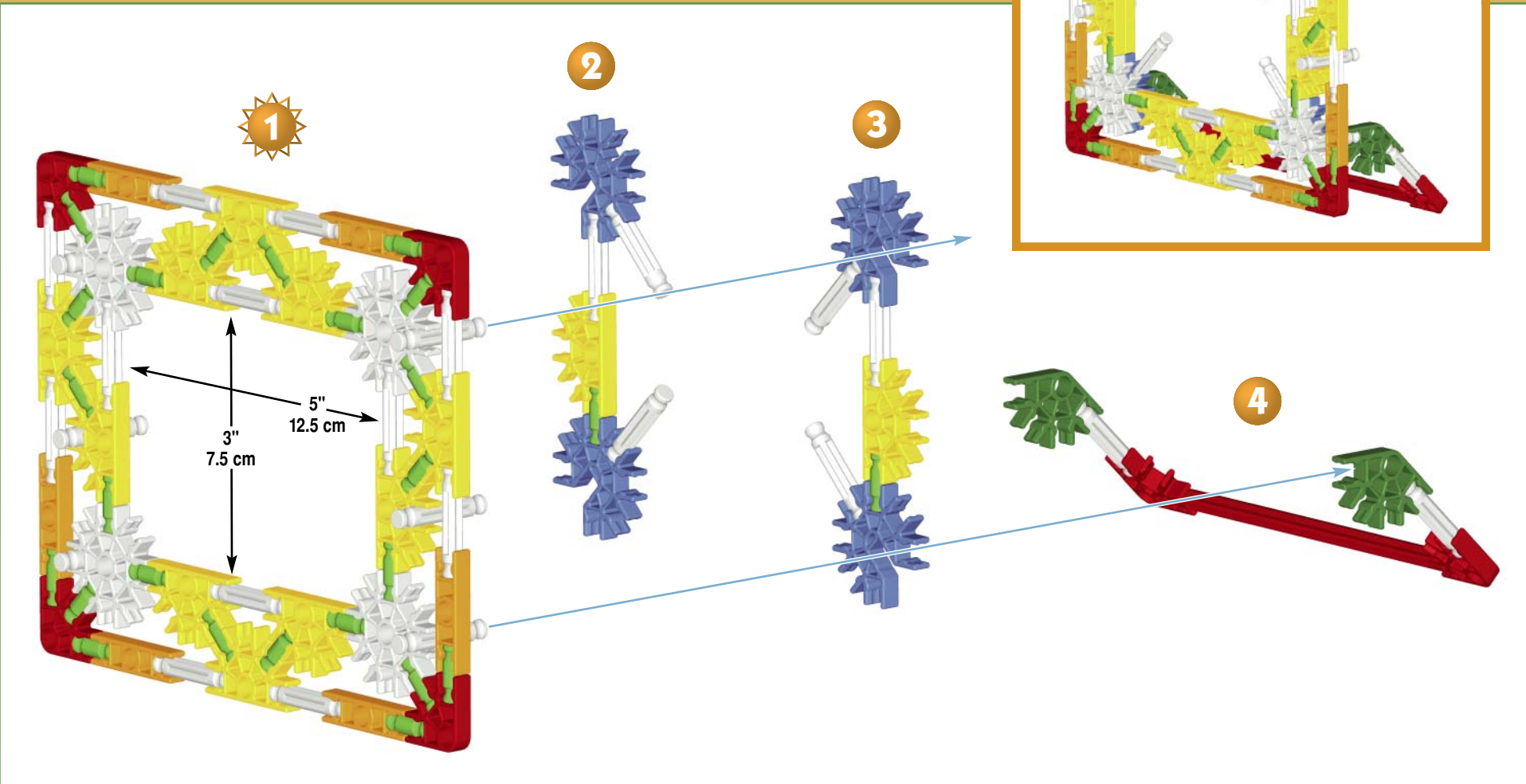

Large Picture Frame

Encadrement de grande

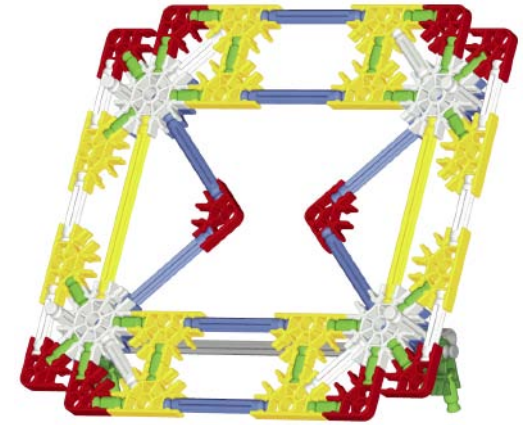

1

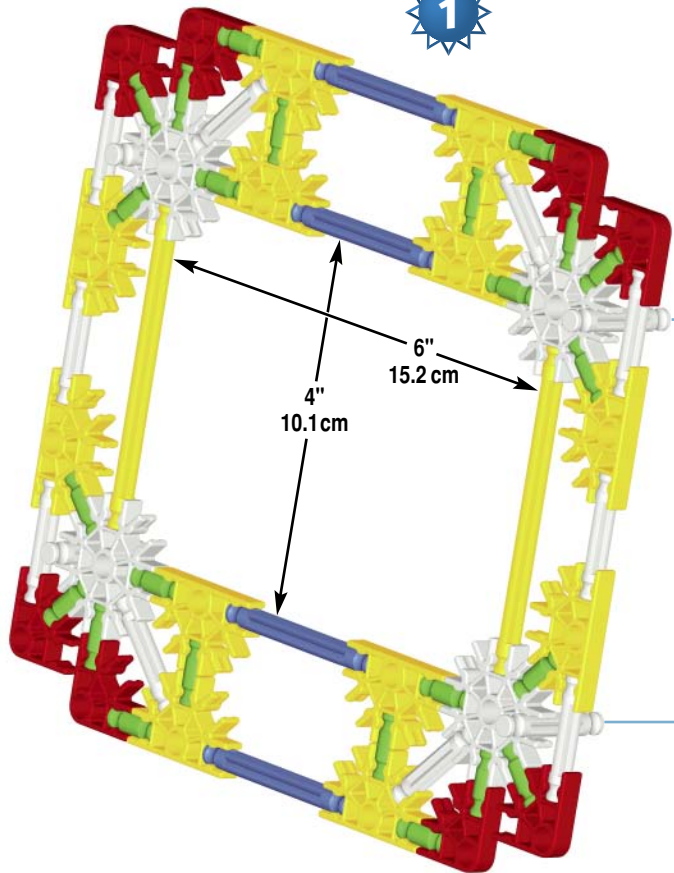

2

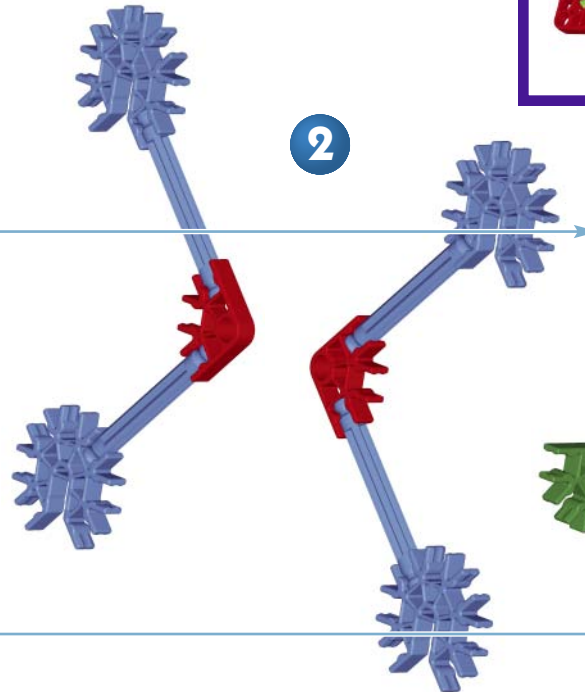

A = A

3

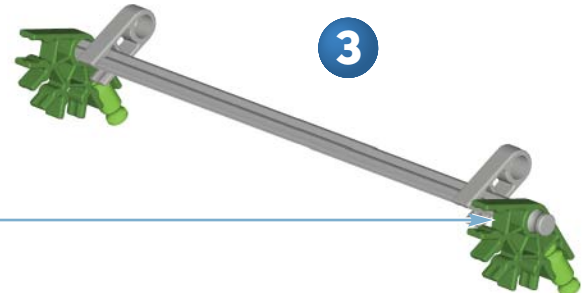

Trolley Car Tramway

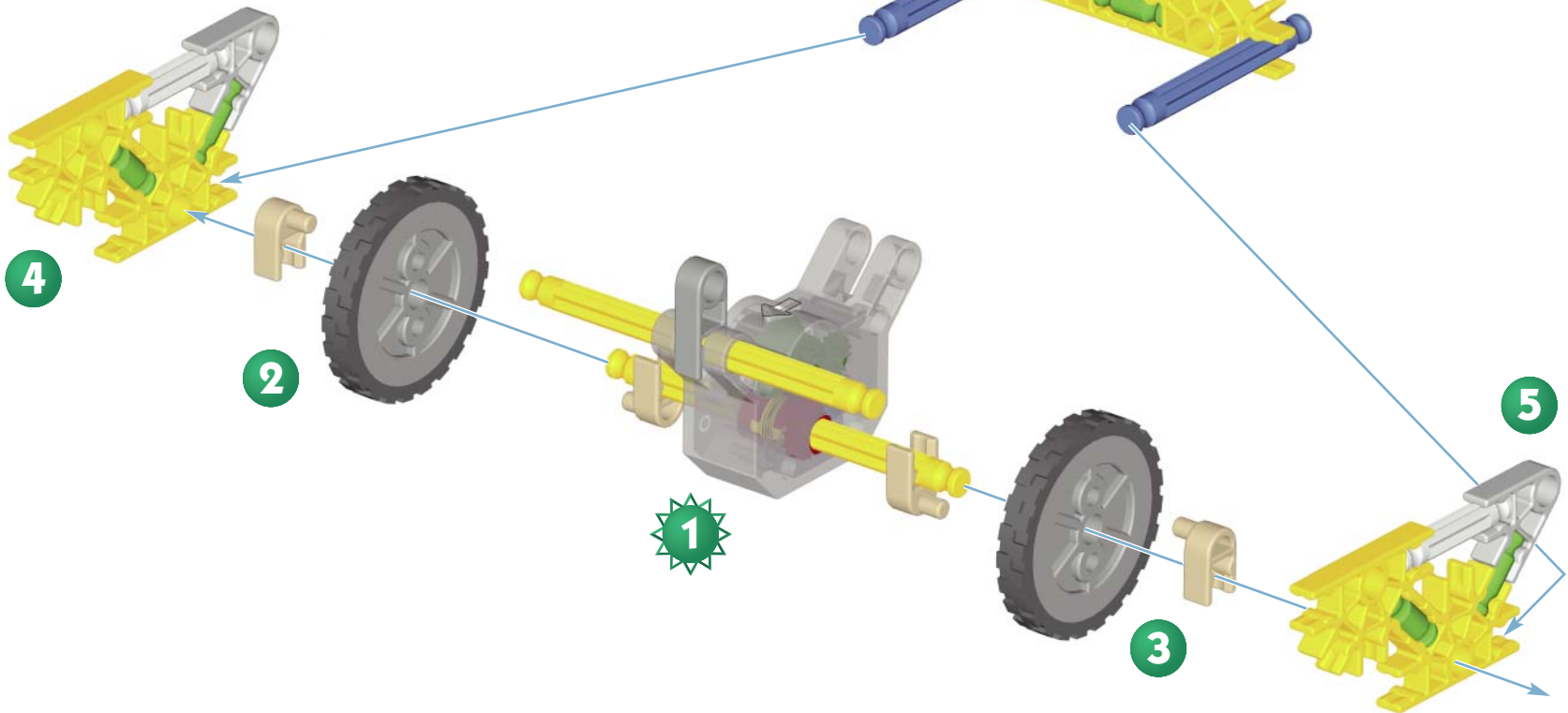

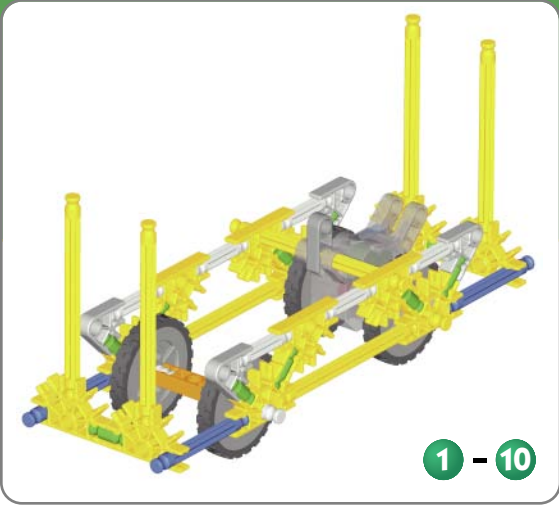

1 - 10

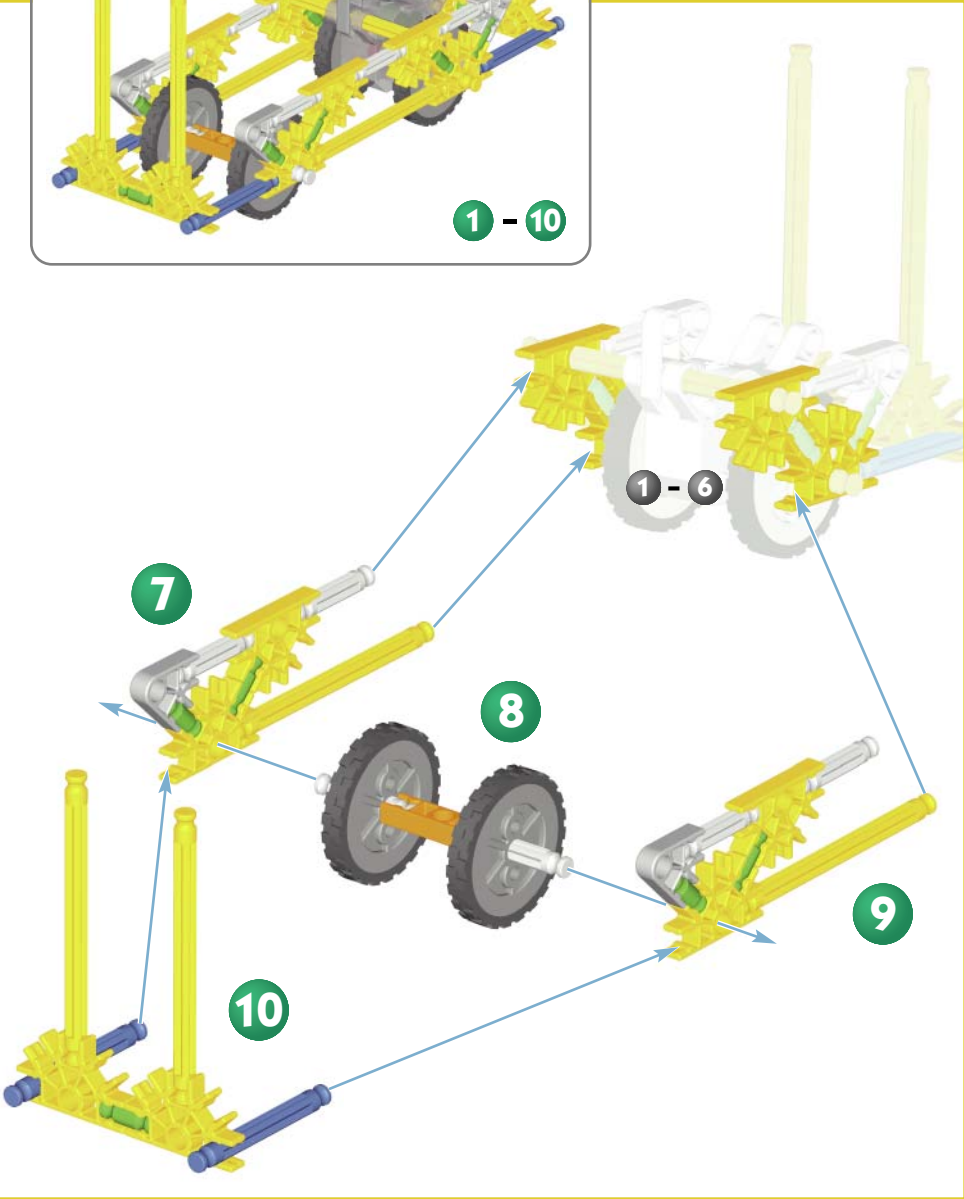

7

8

9

10

1 - 6

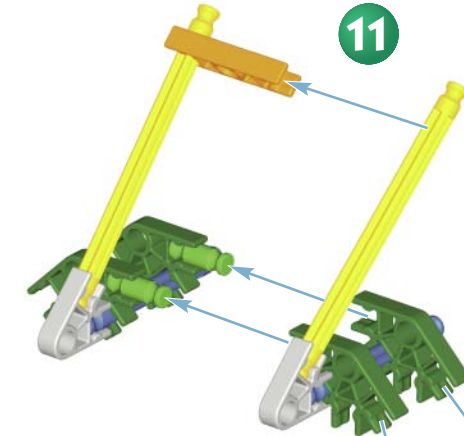

11

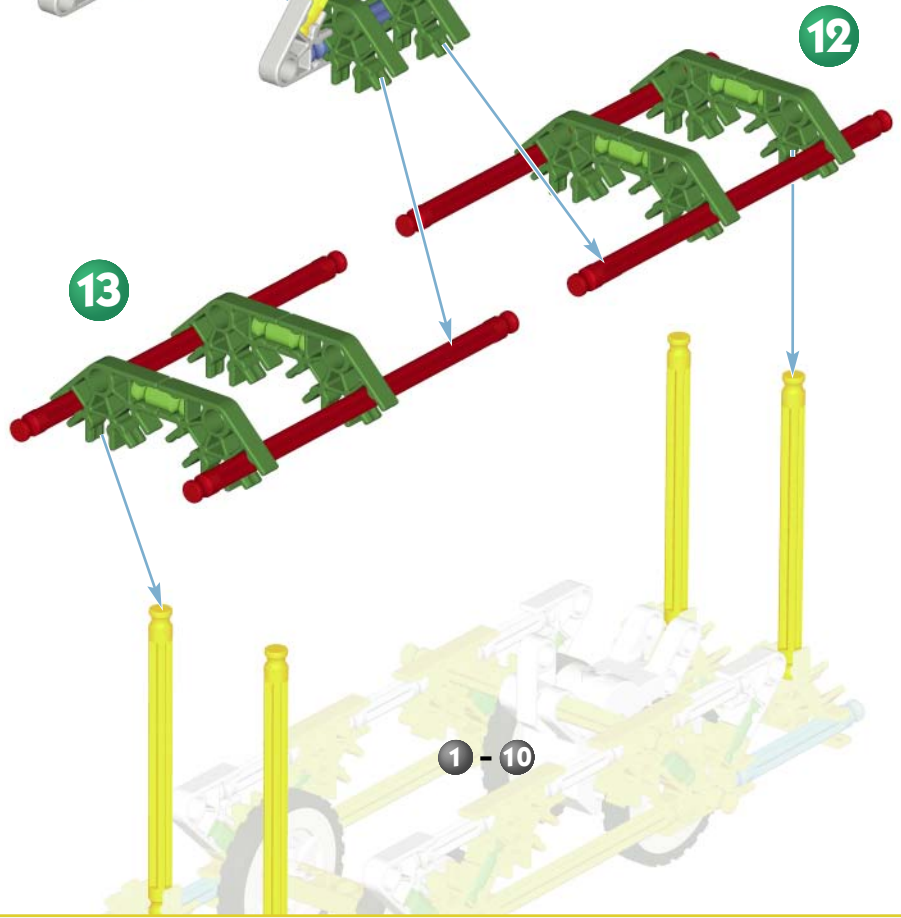

12

13

1 - 10



1 - 13

Dragster Dragster

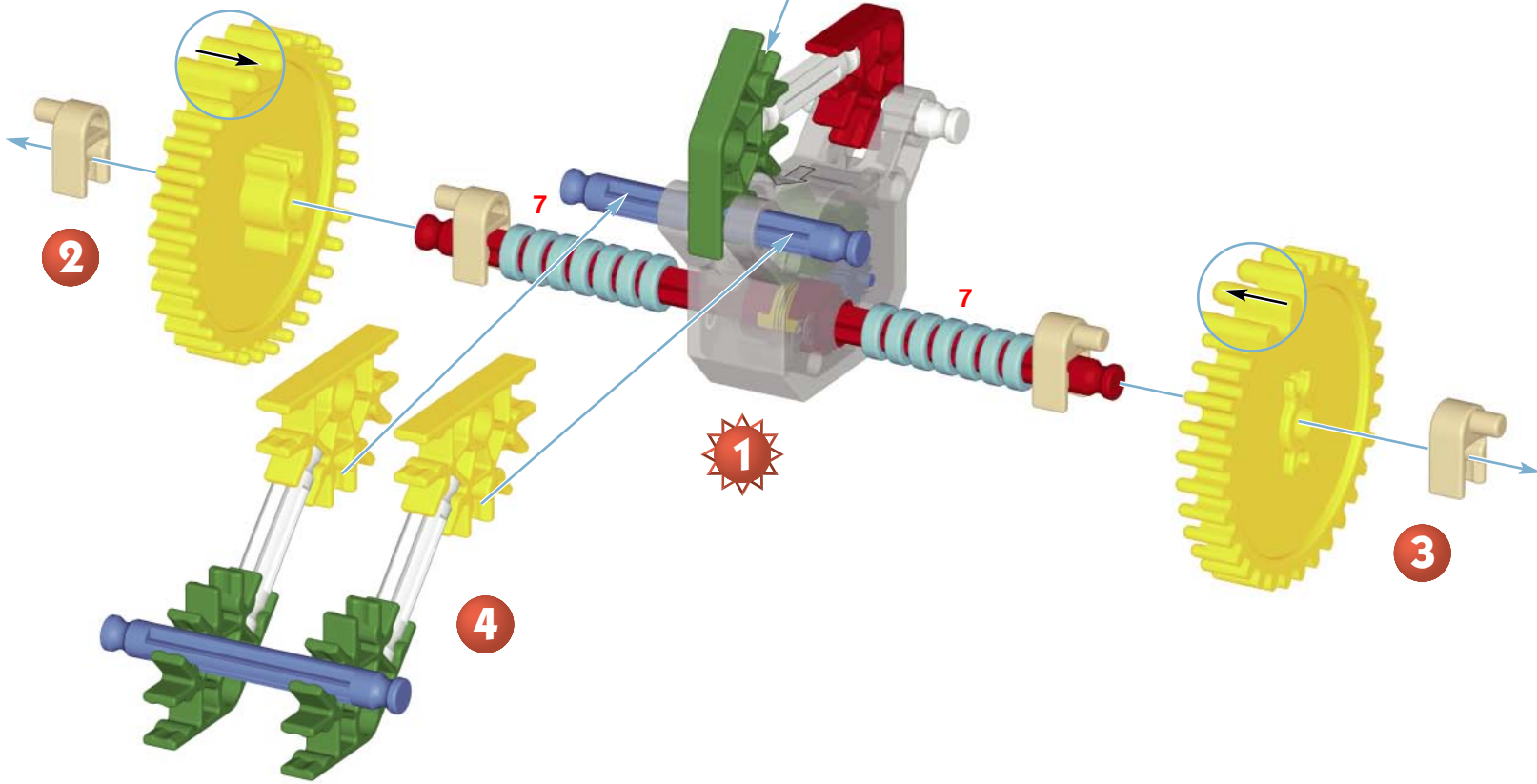
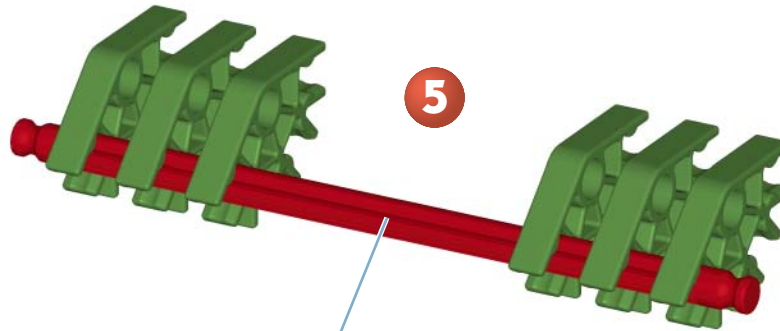
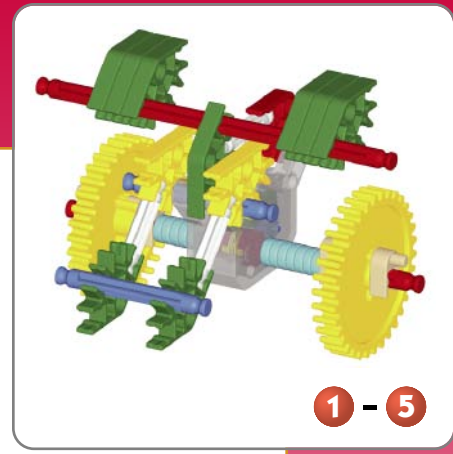
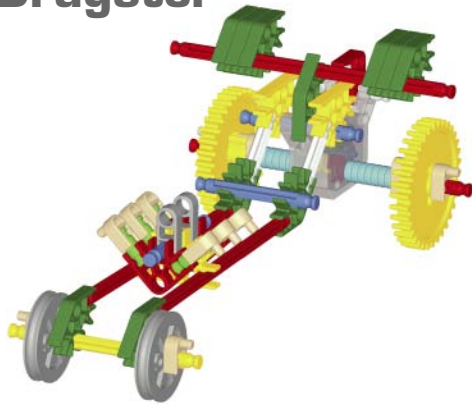

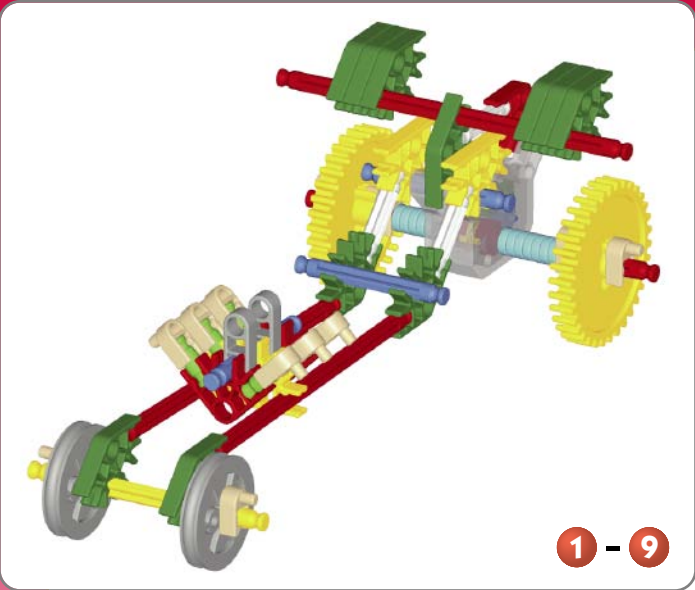

A = A

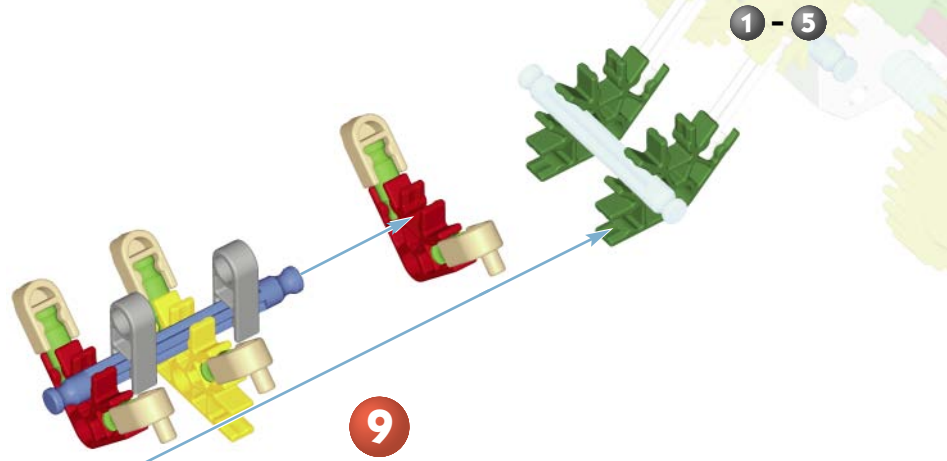
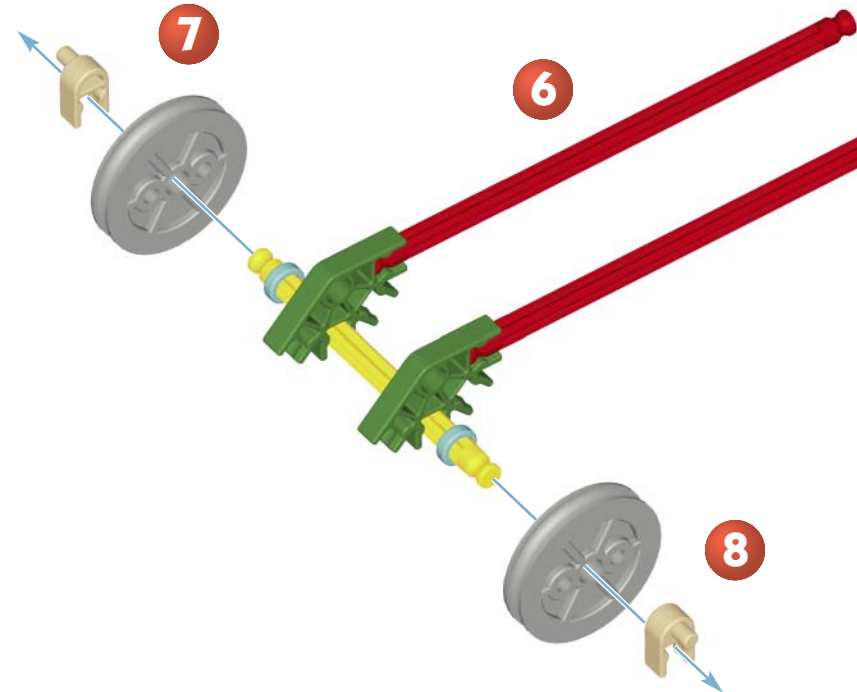

Trike Tricycle

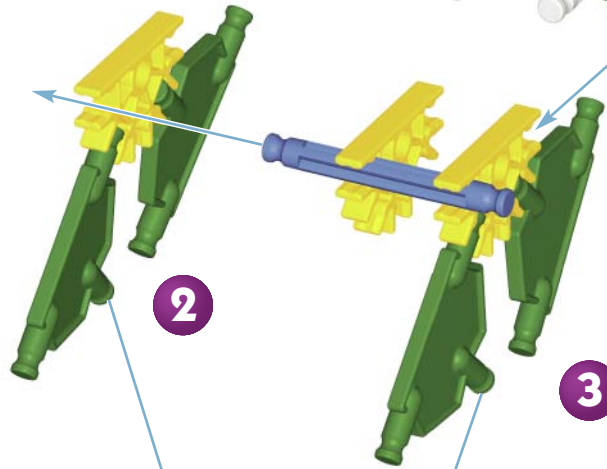
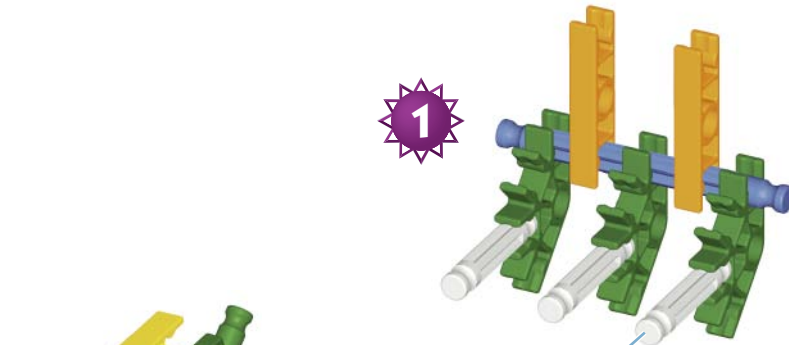
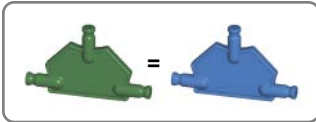

3

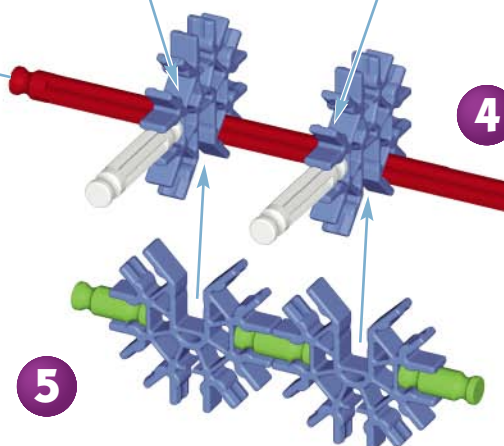

5

1 - 5

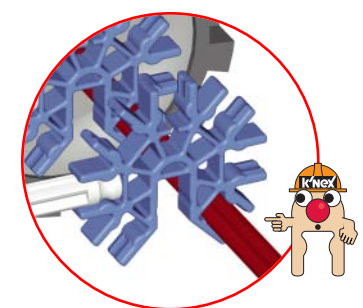

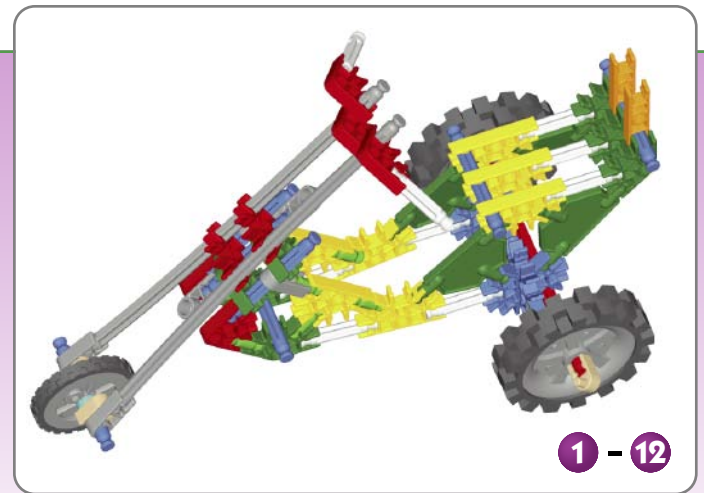
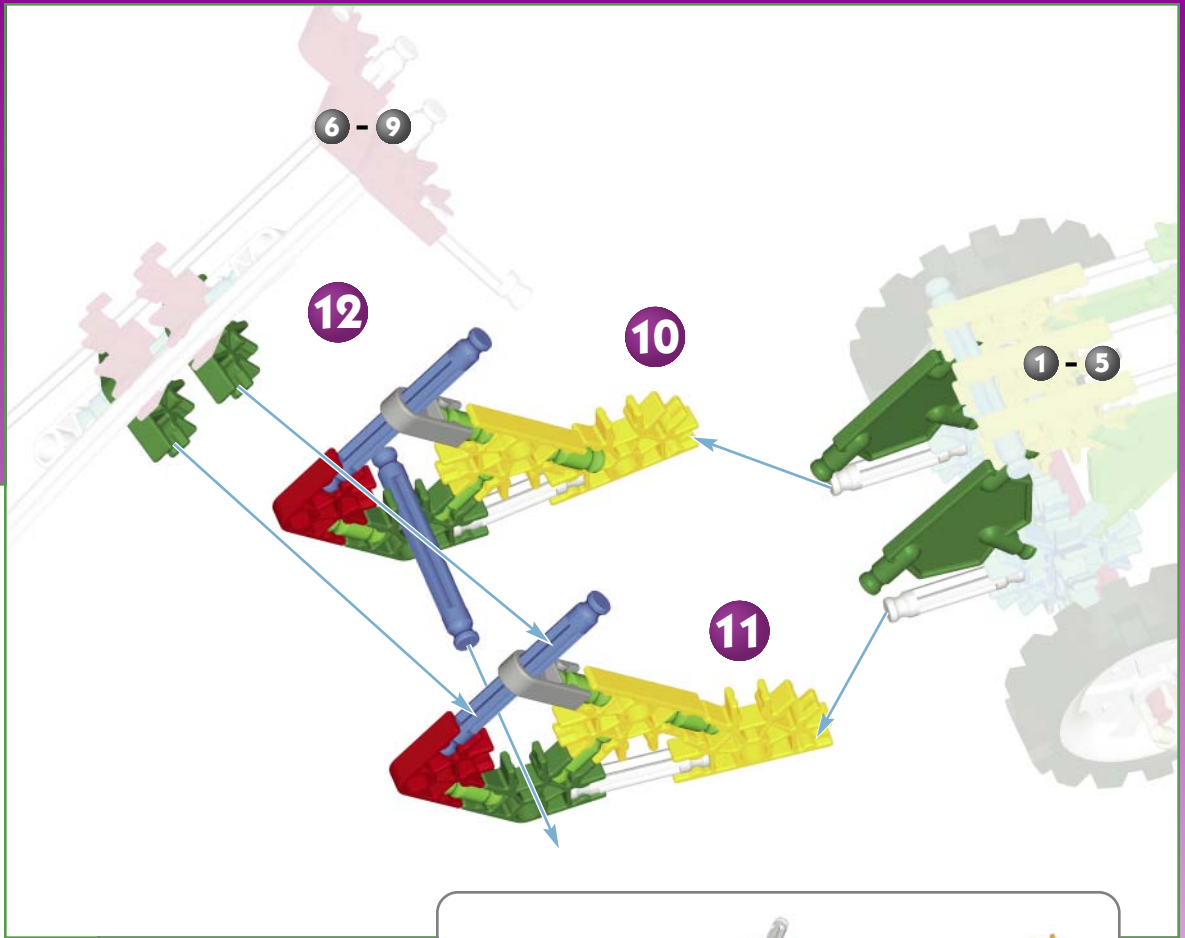
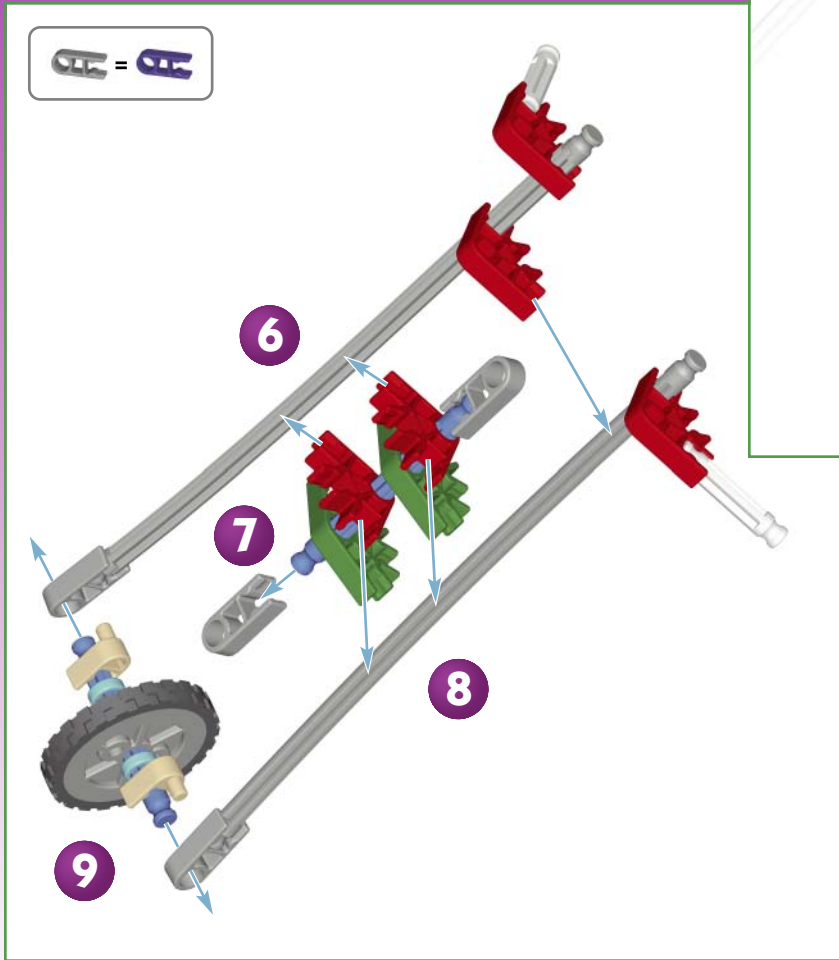

Covered Wagon

Chariot
couvert

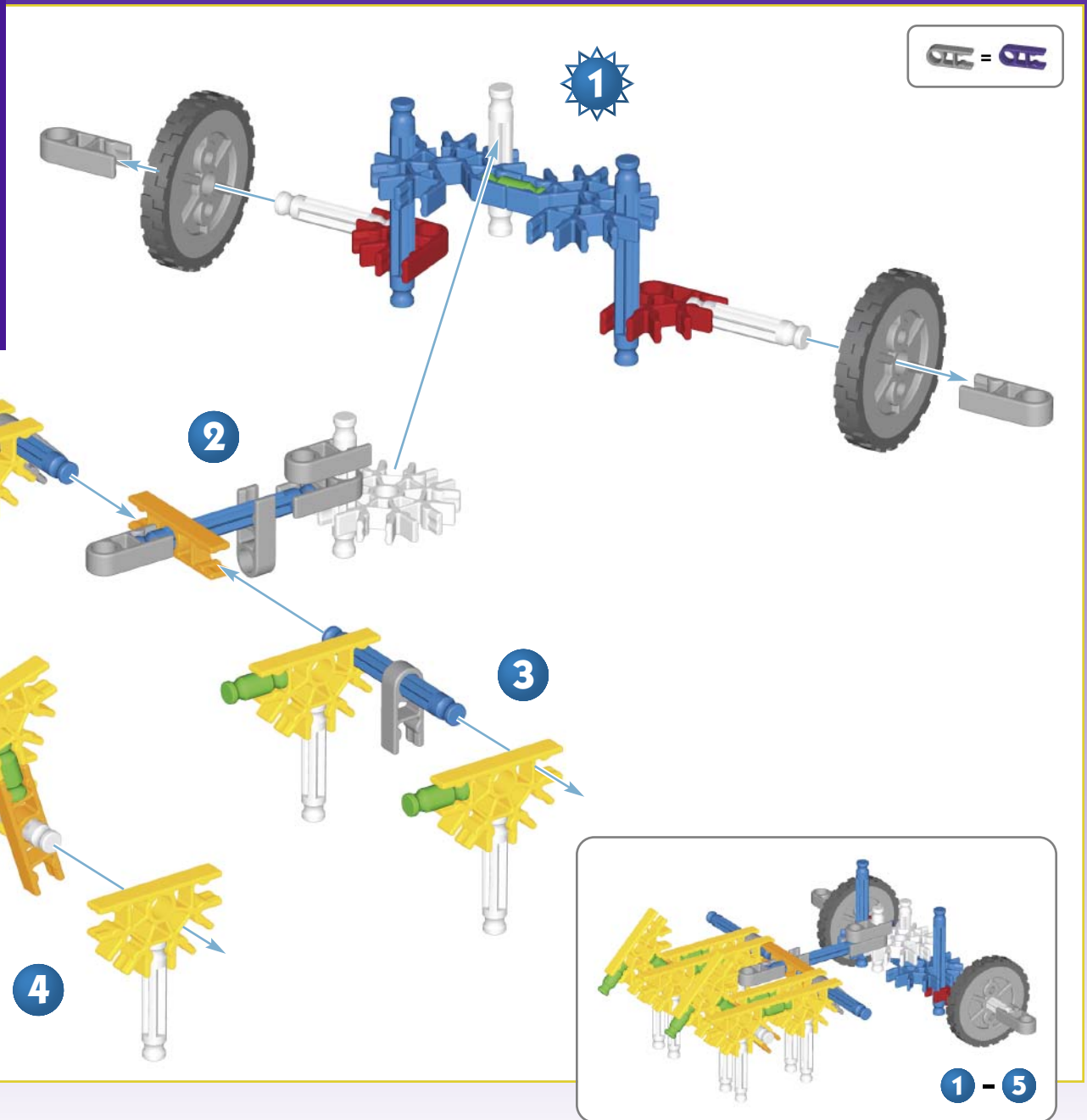
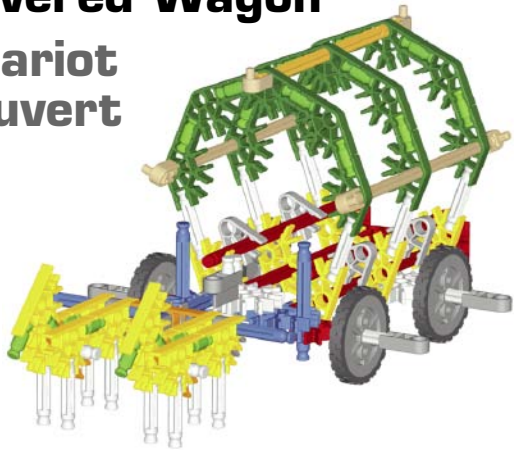

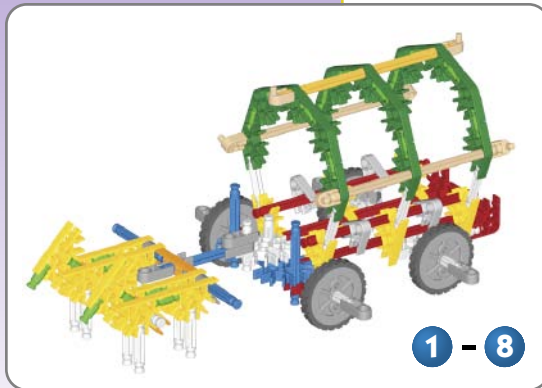
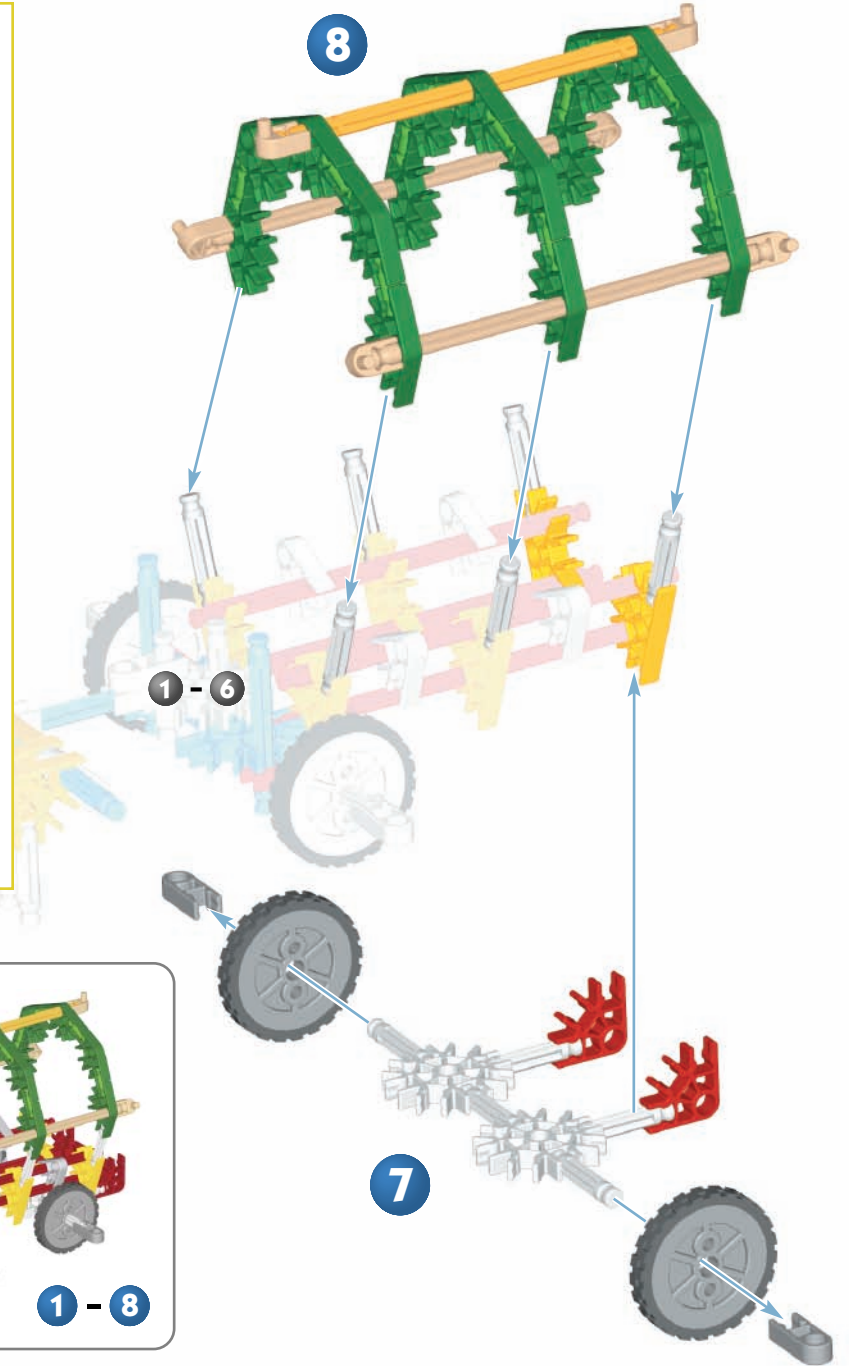
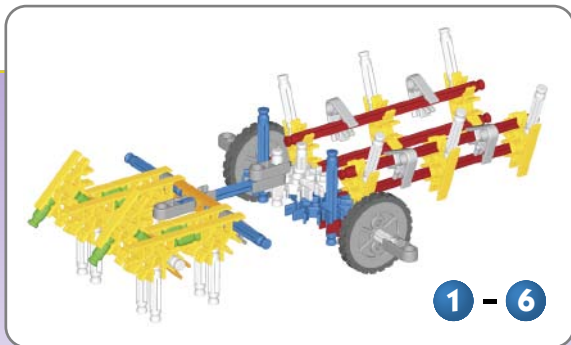
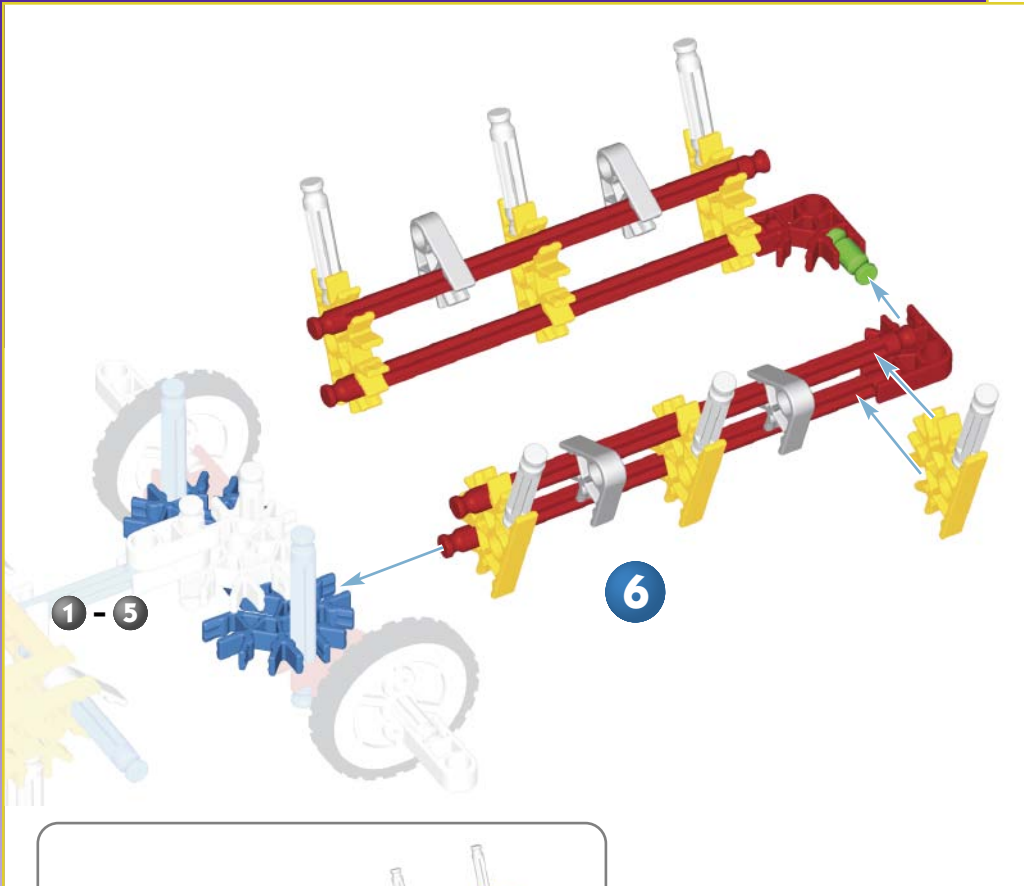

Space Transporter

Transport spatial

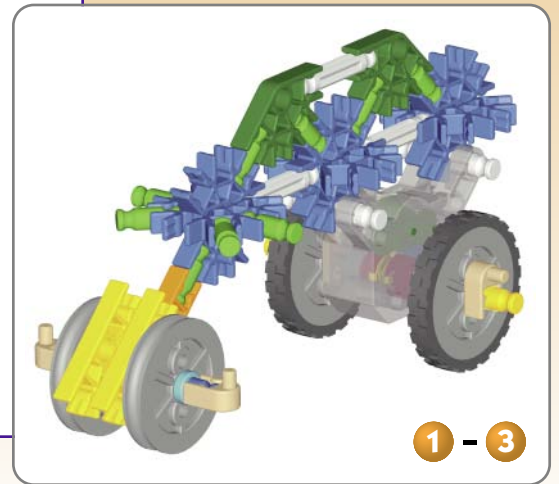
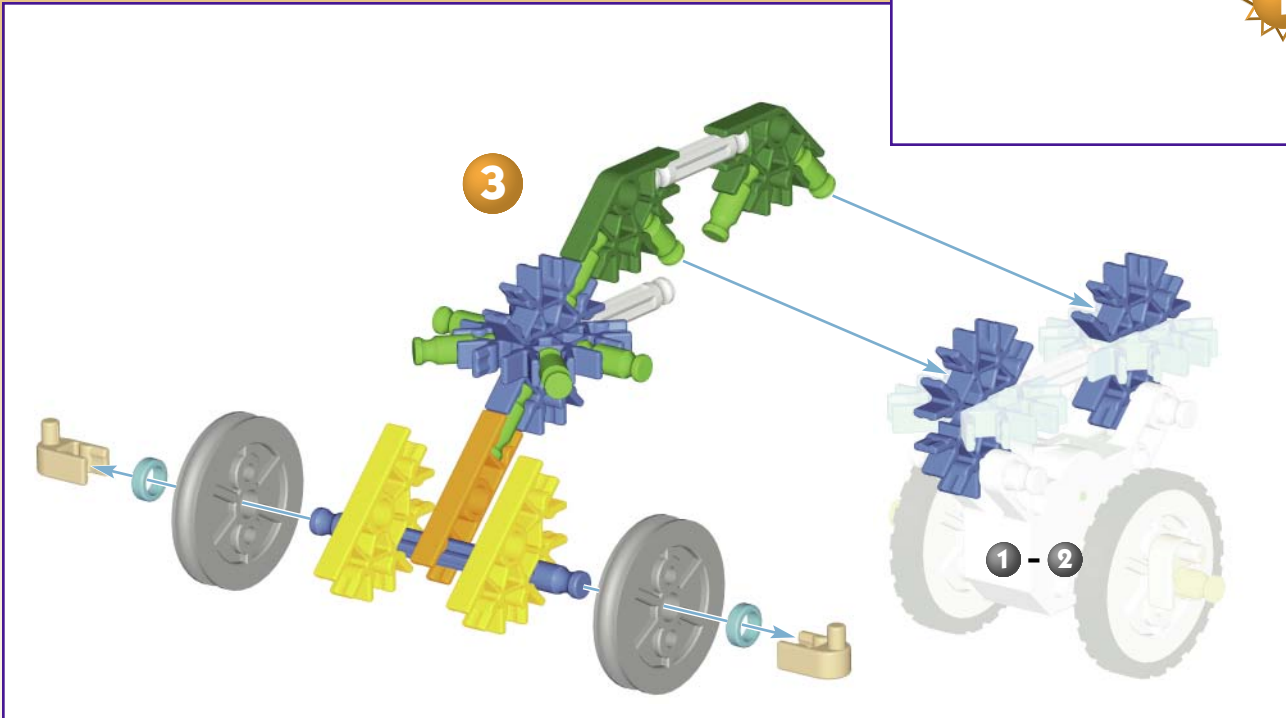
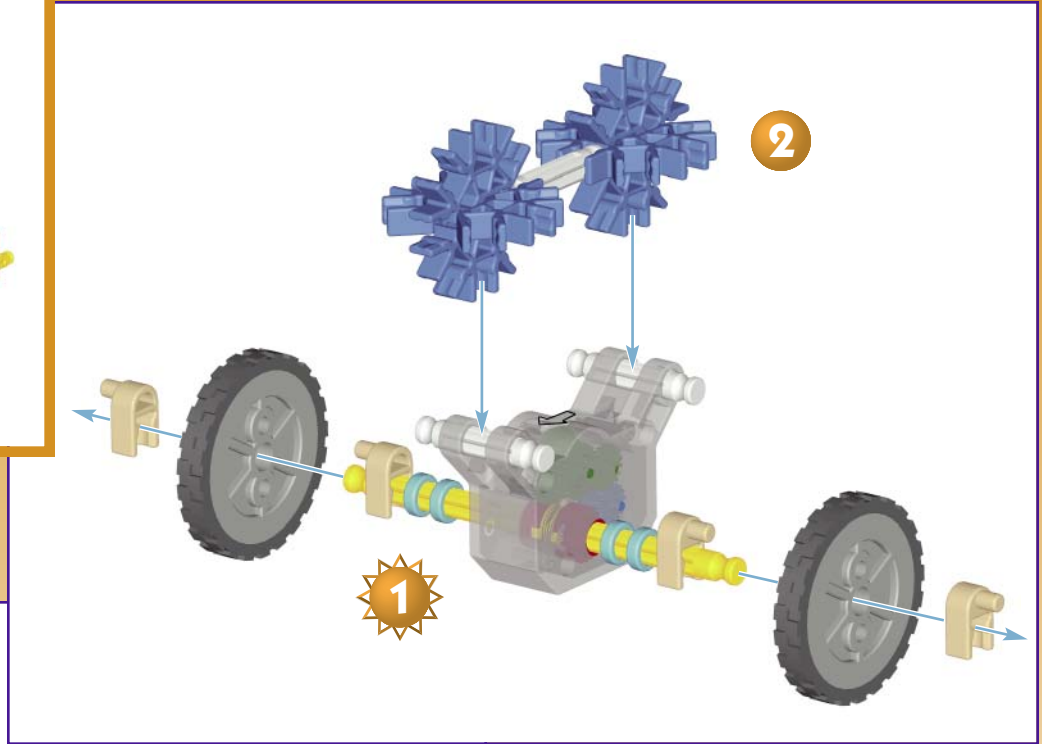

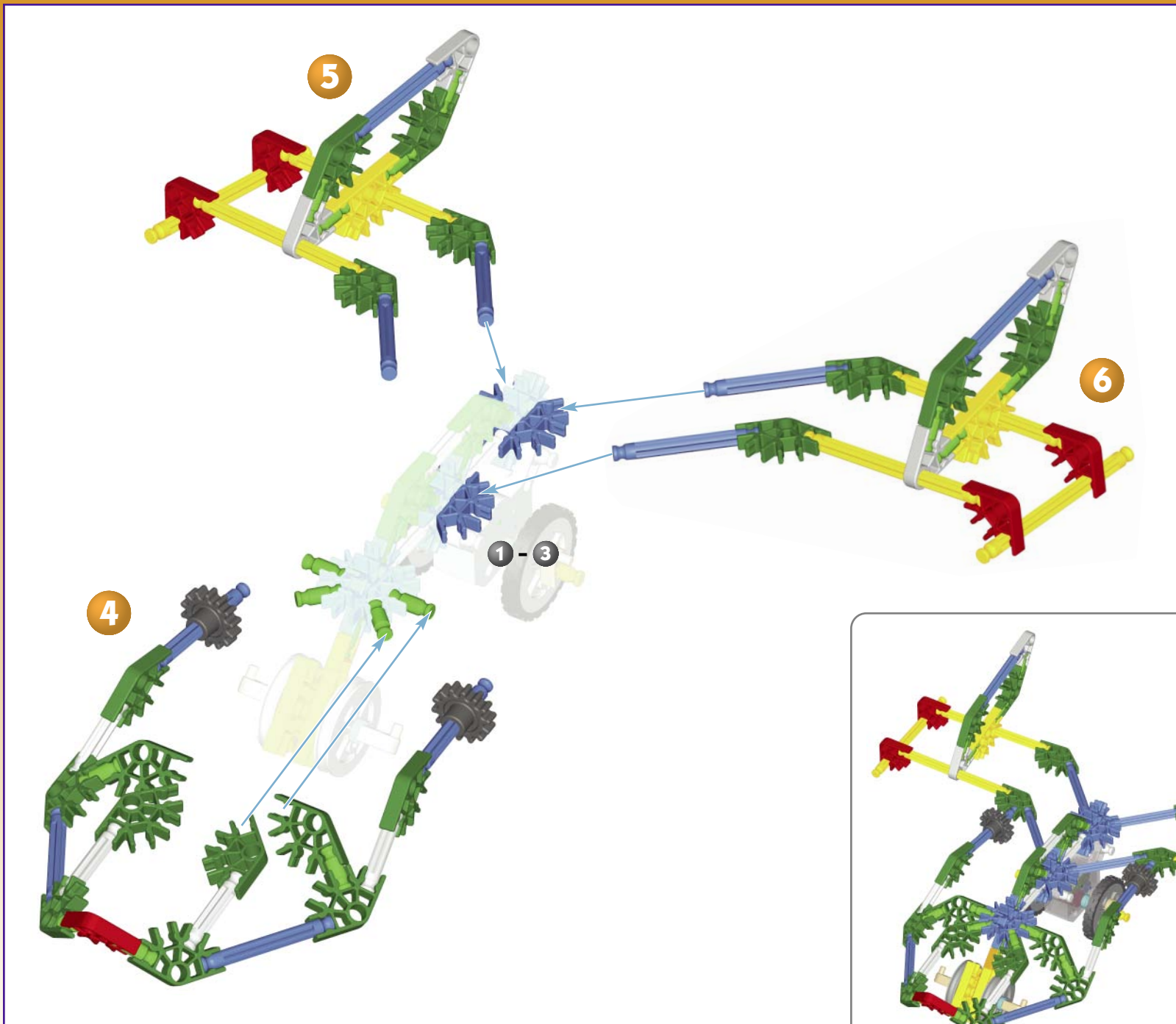

Spider Araignée

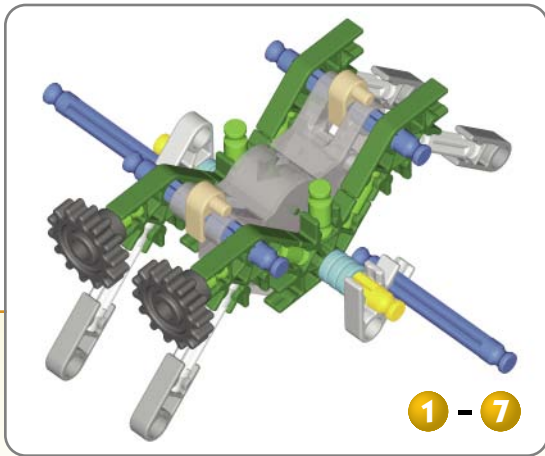
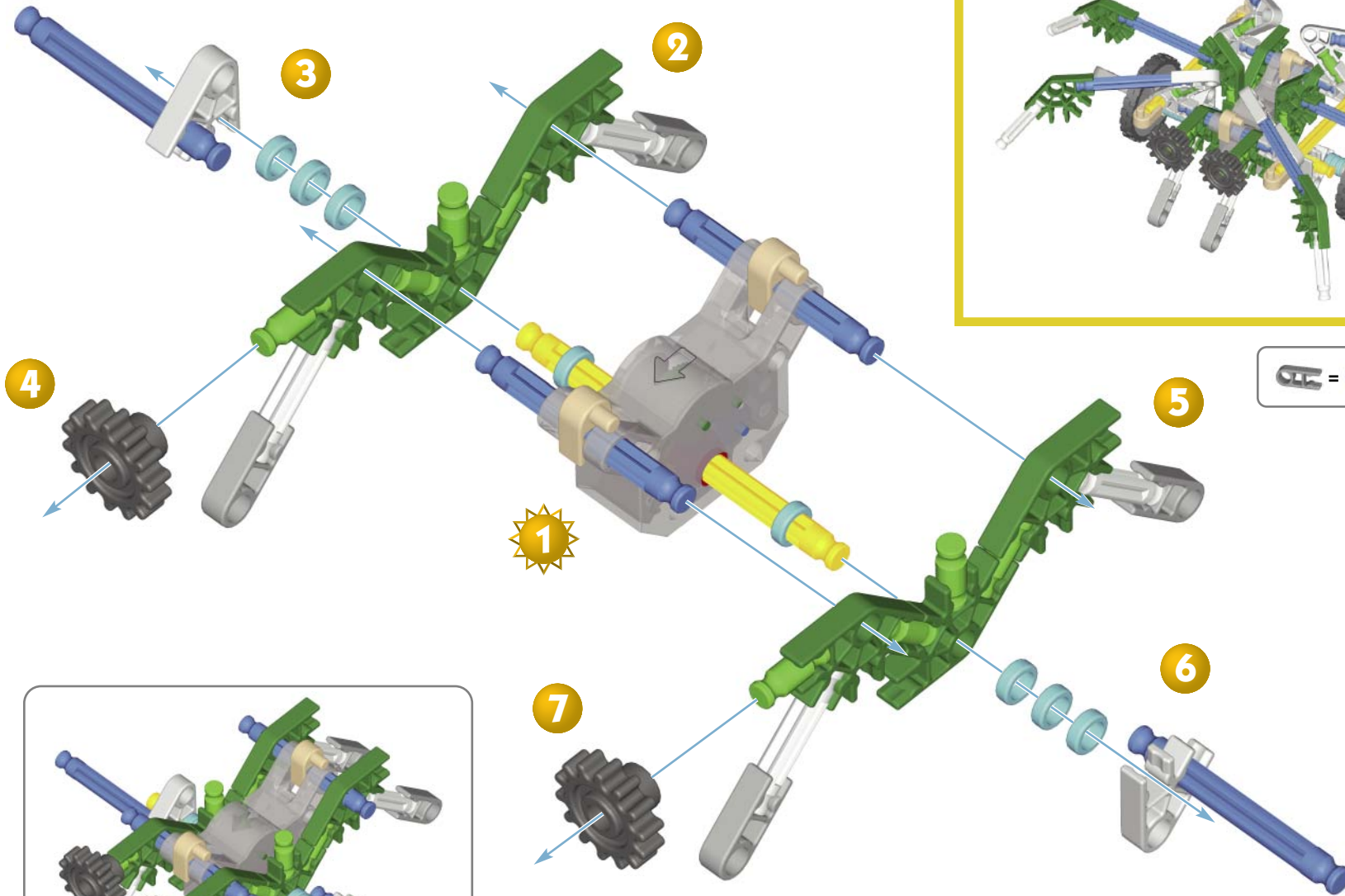
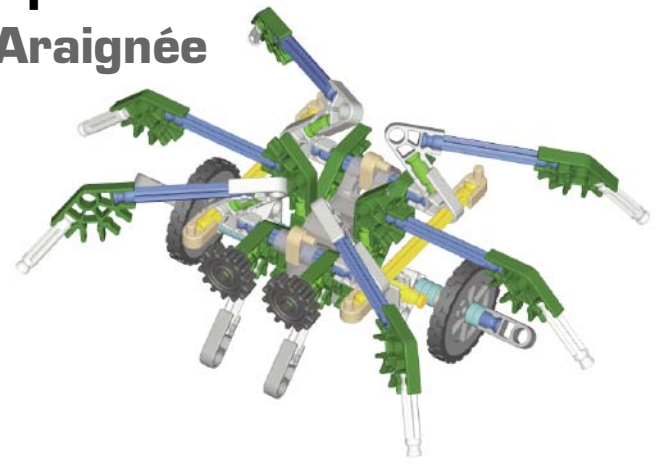

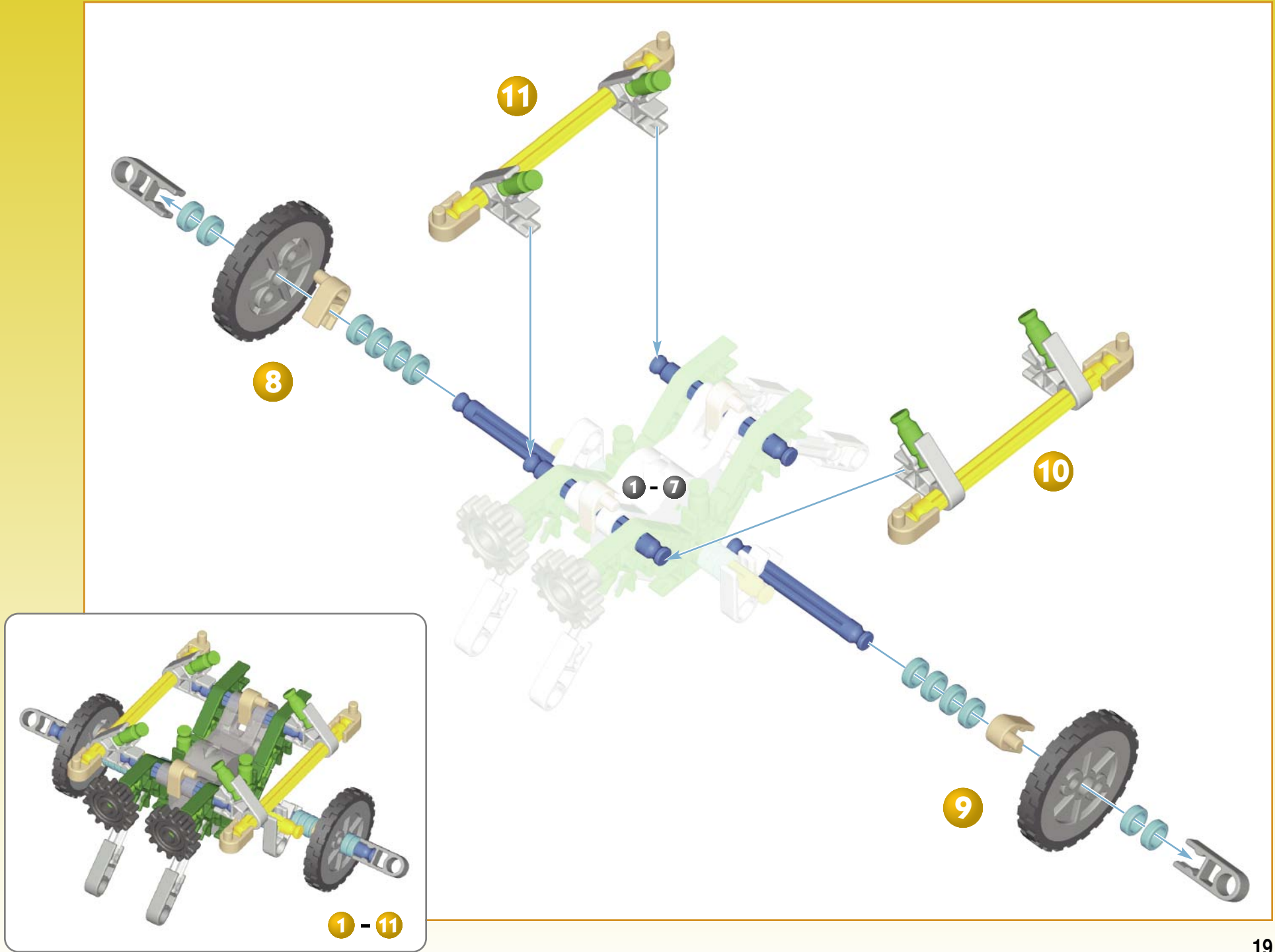

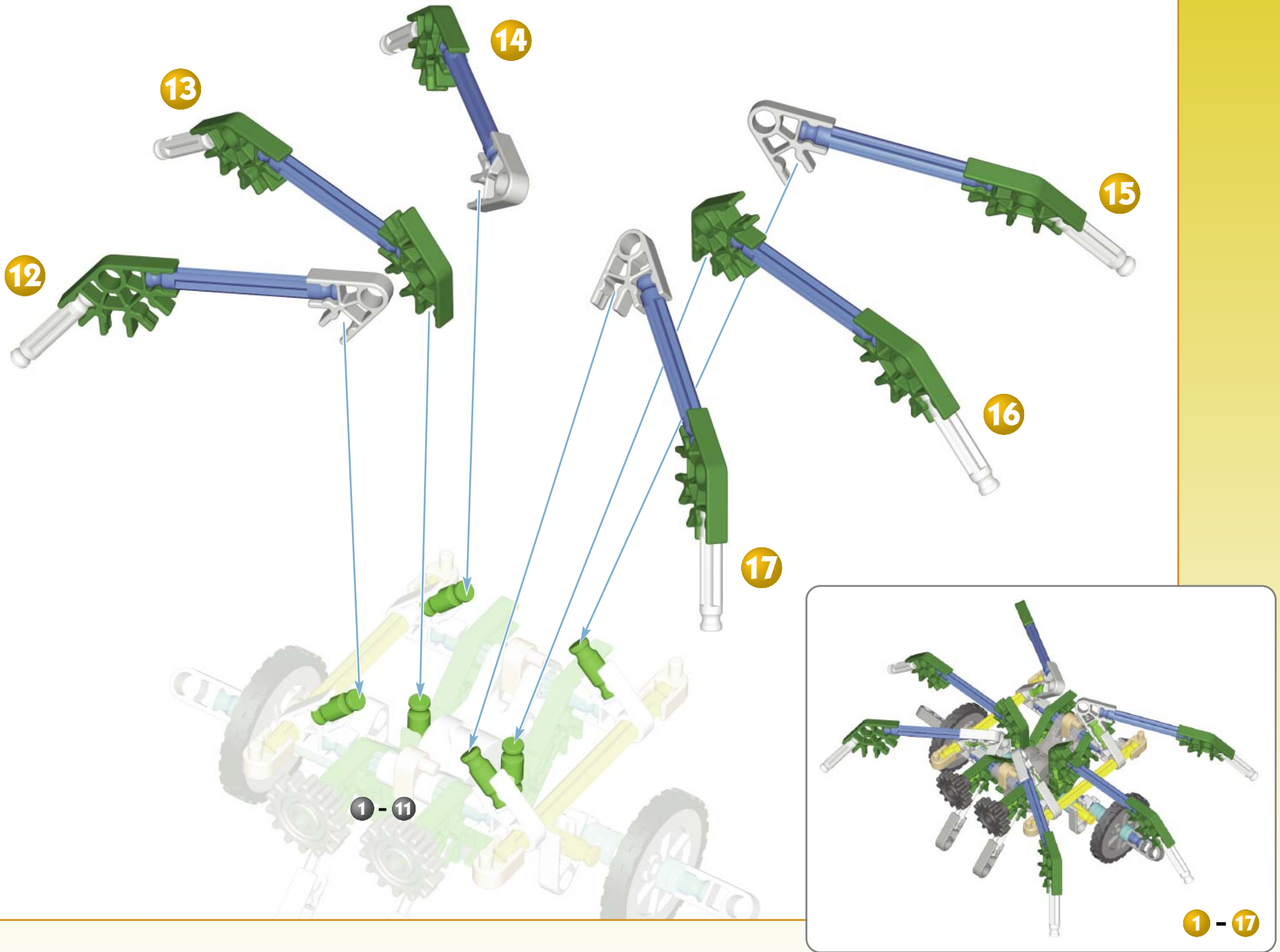

Backhoe

Backhoe

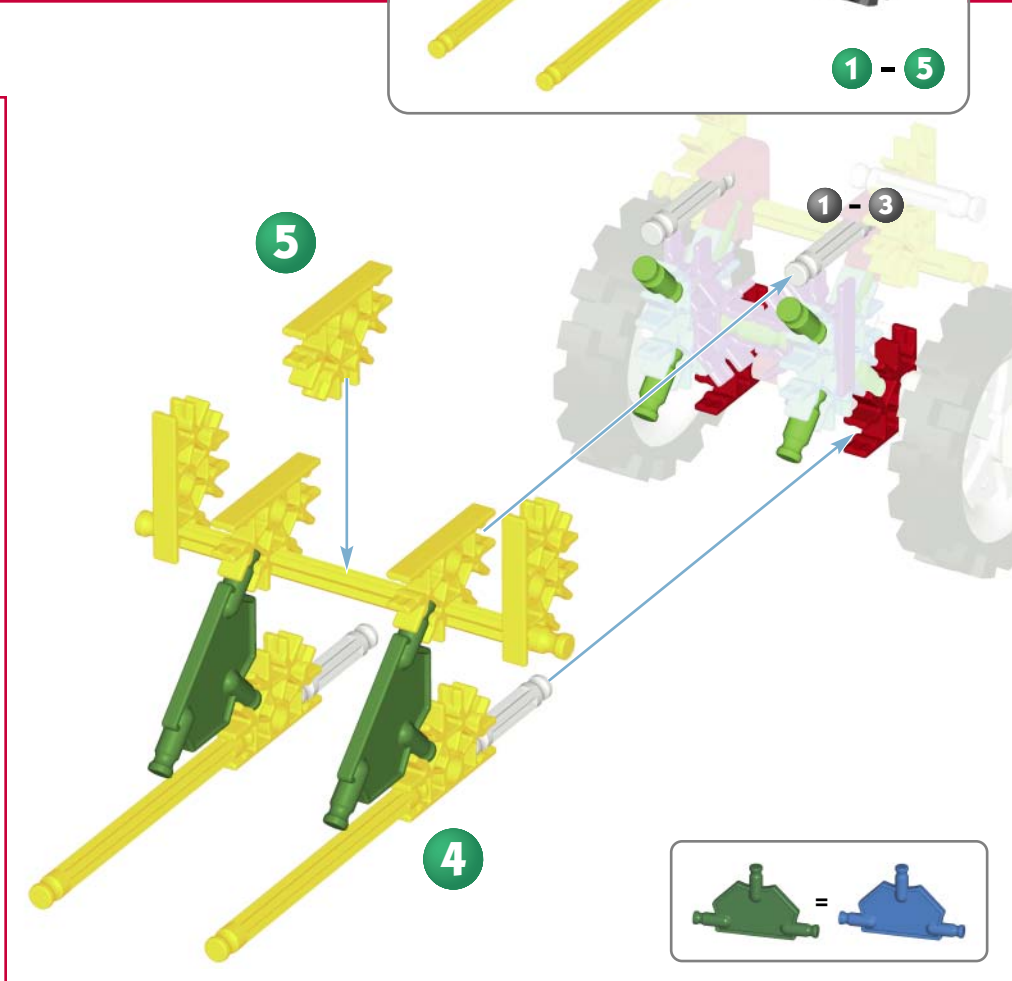
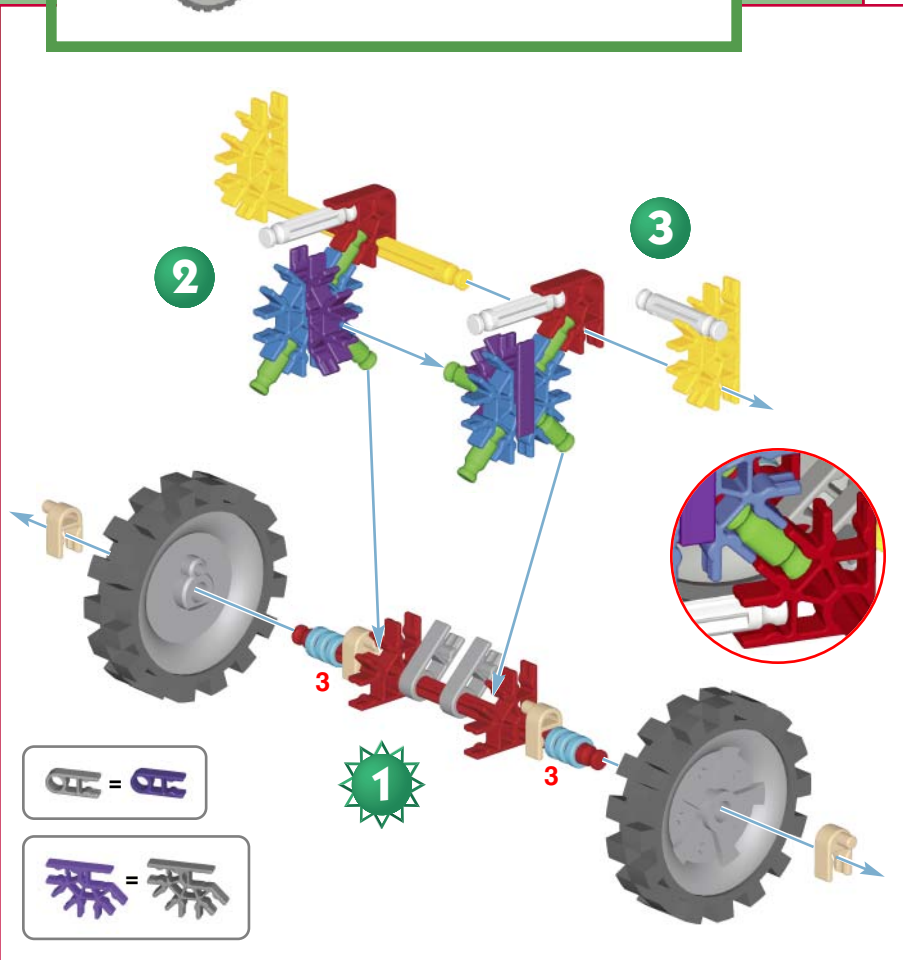
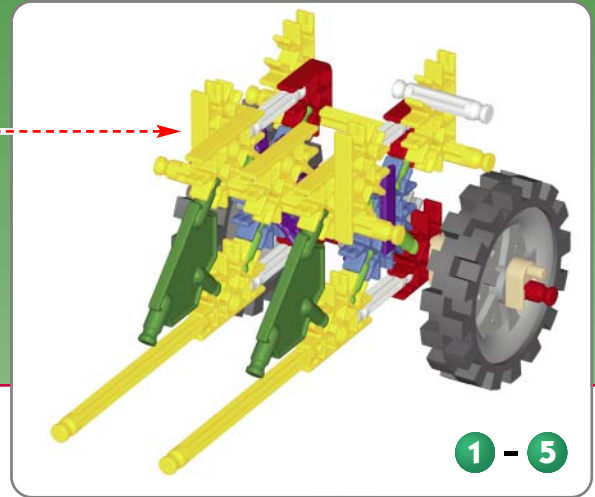
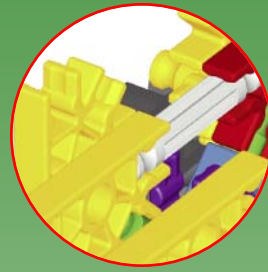

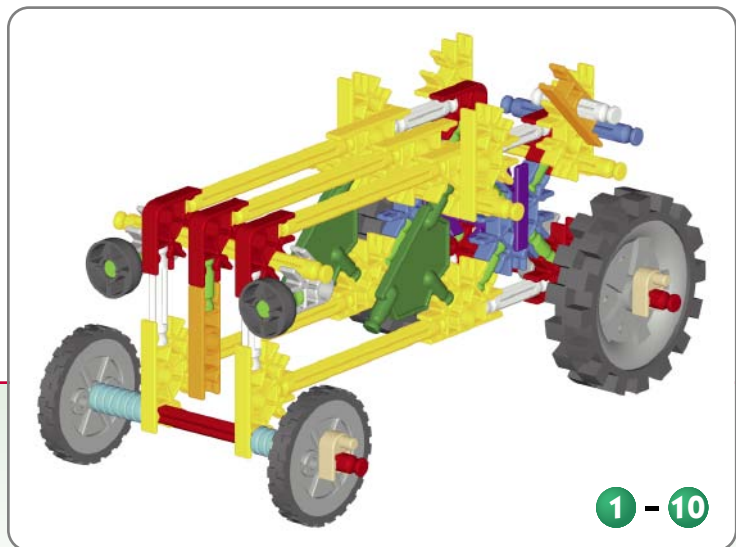
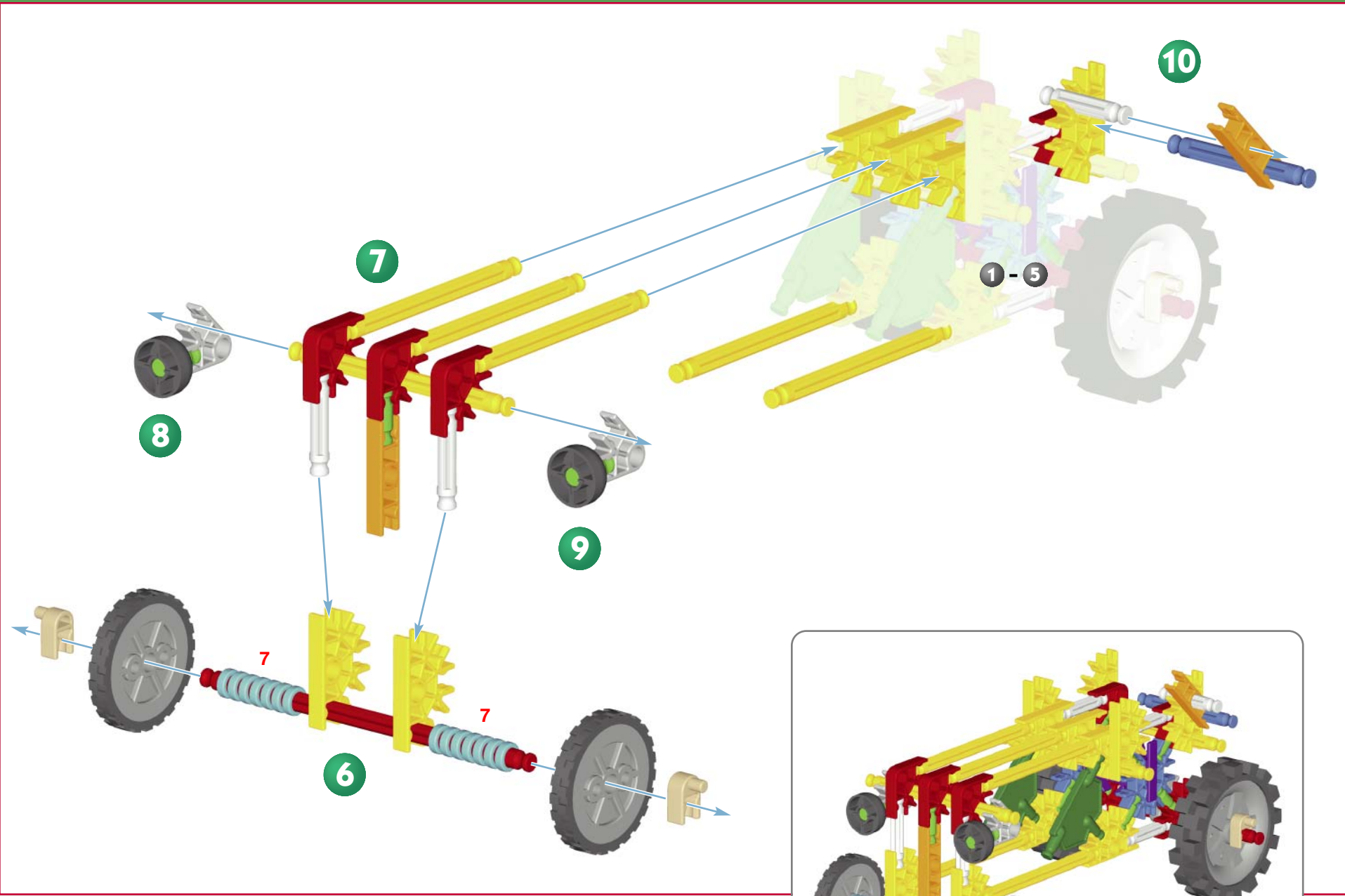

1 - 10

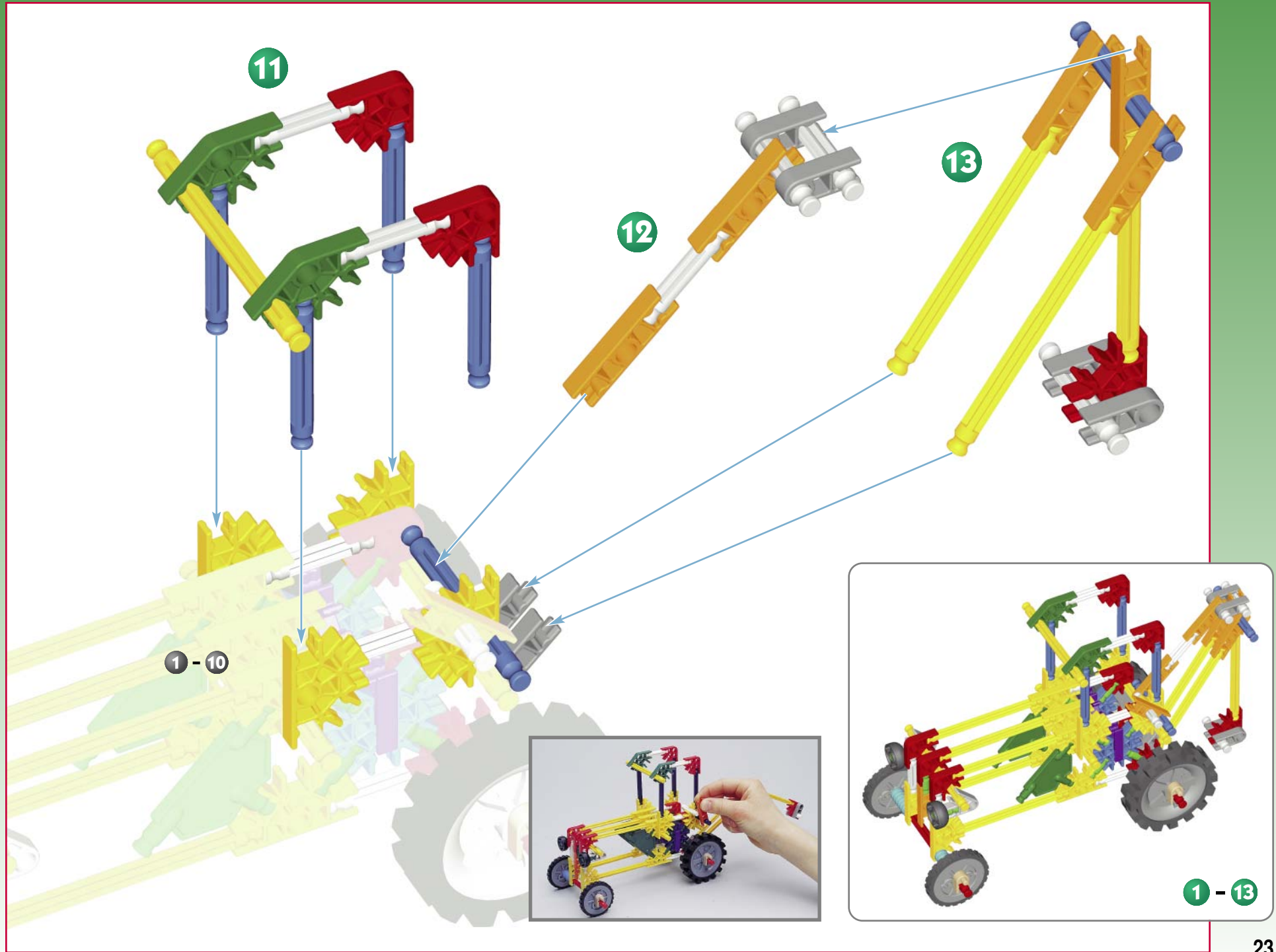

Road Grader

Niveleuse
route

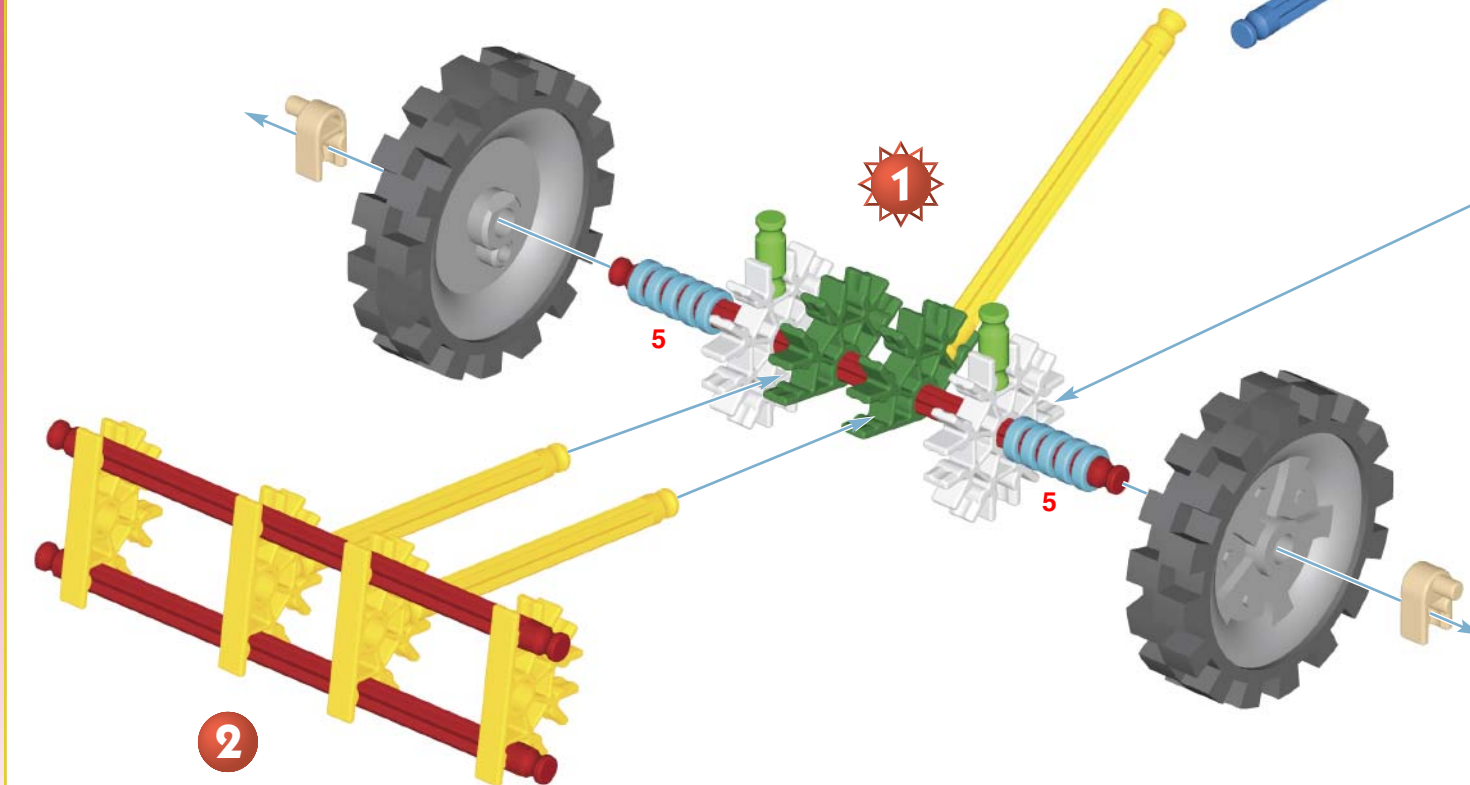
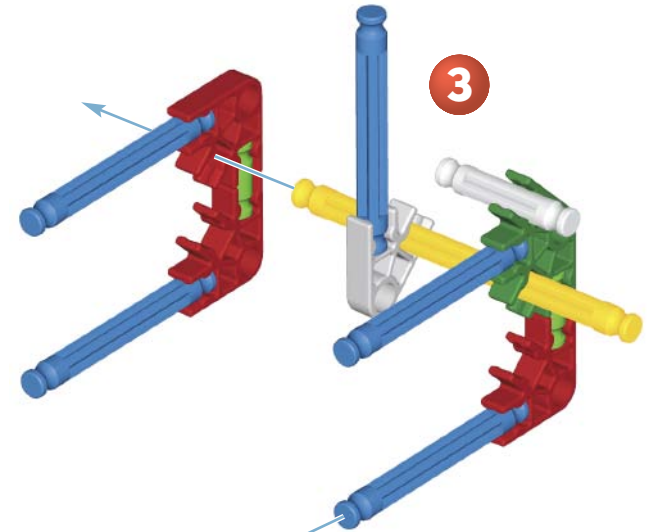
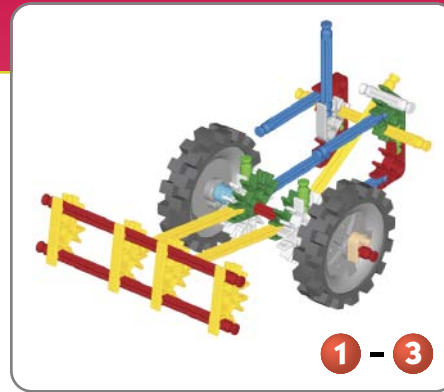

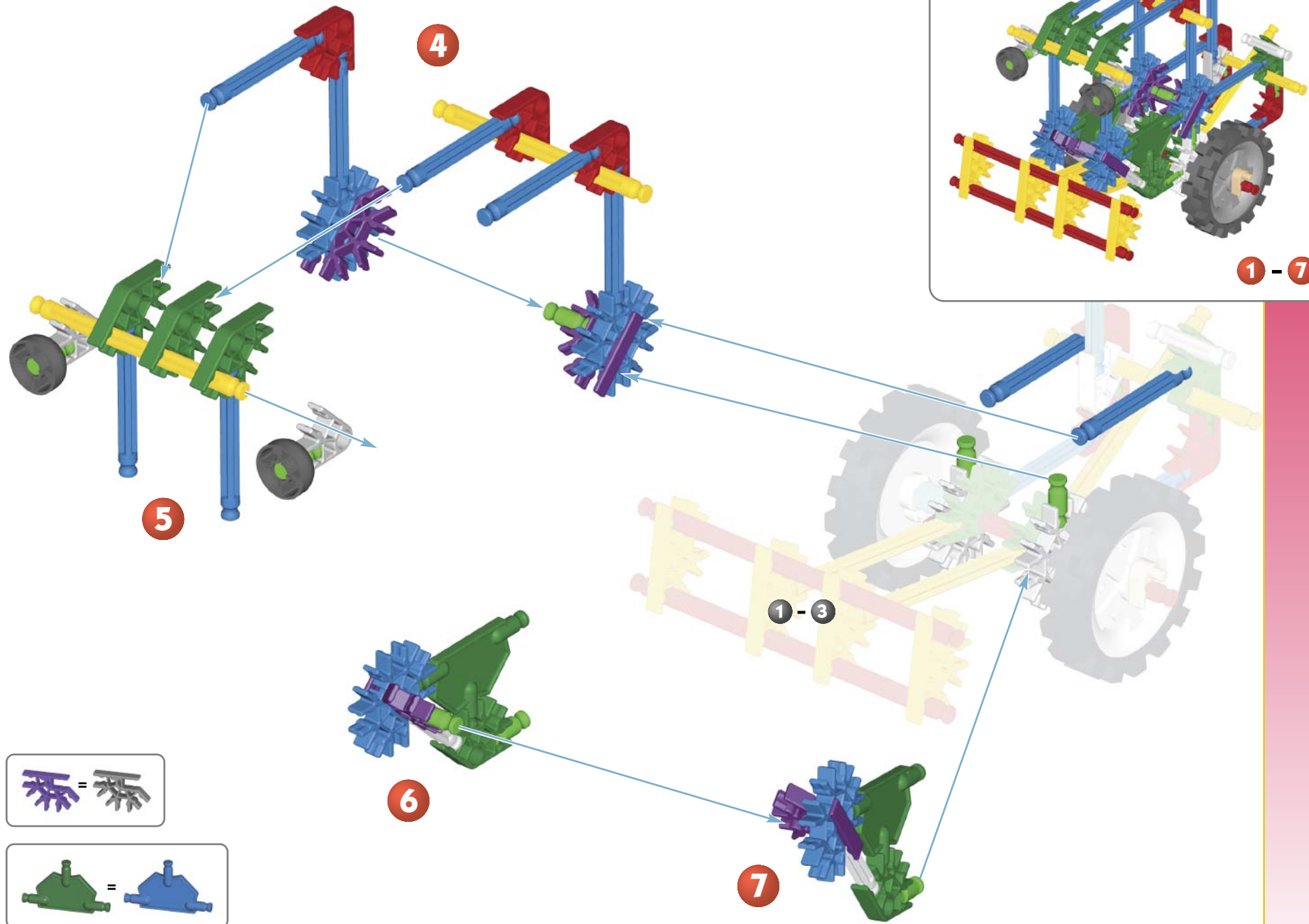

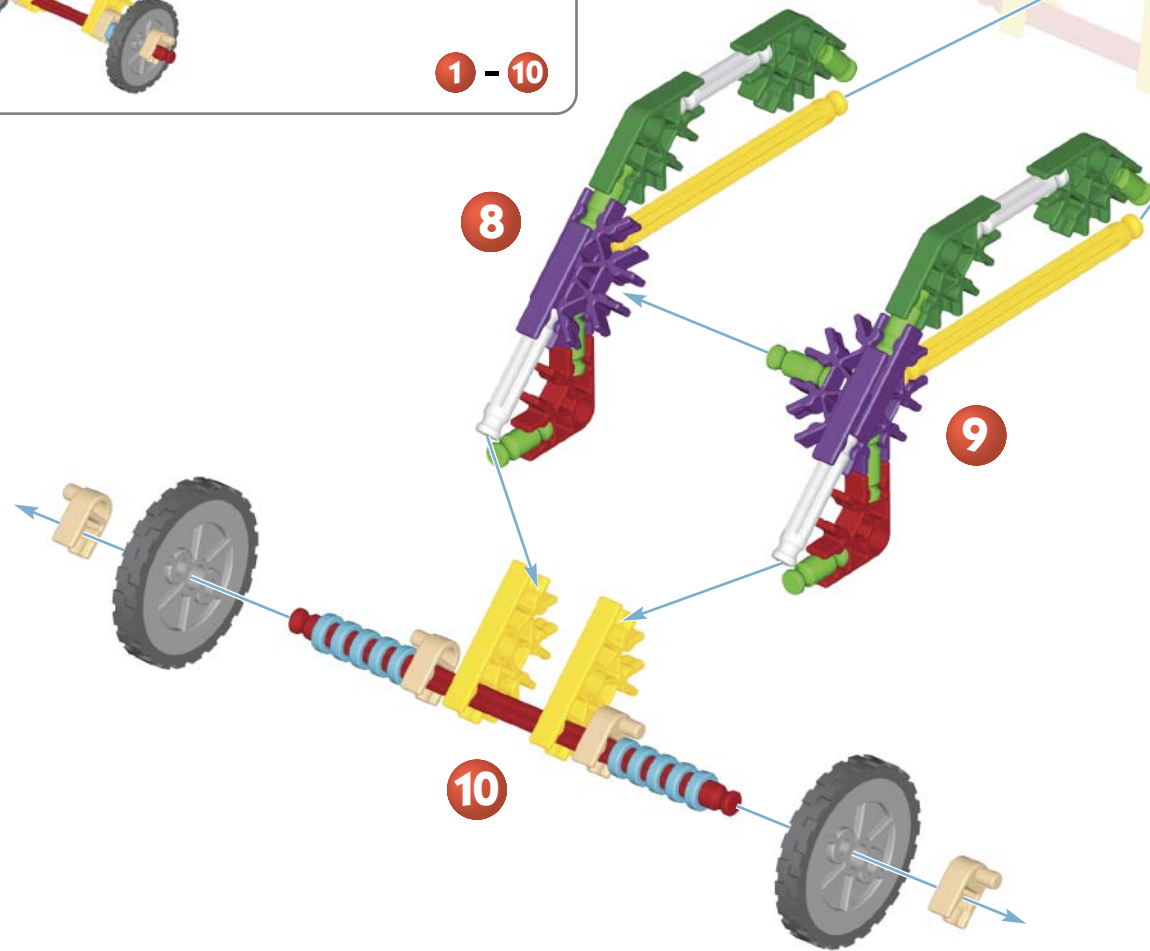
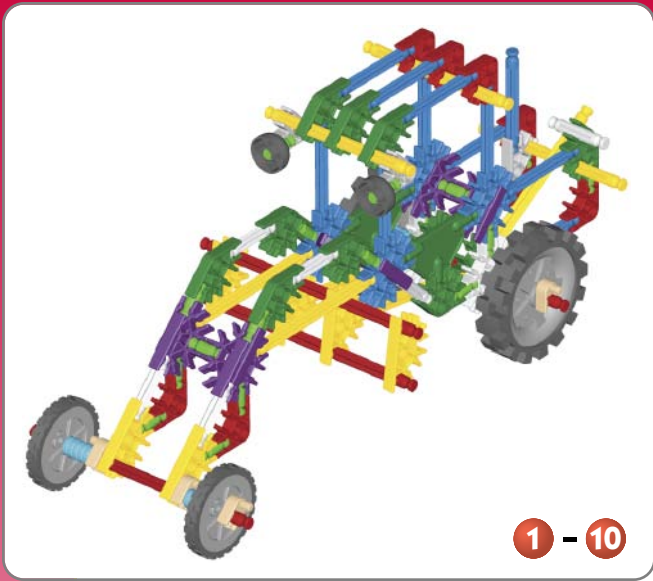

Ferris Wheel

Roue de Ferris

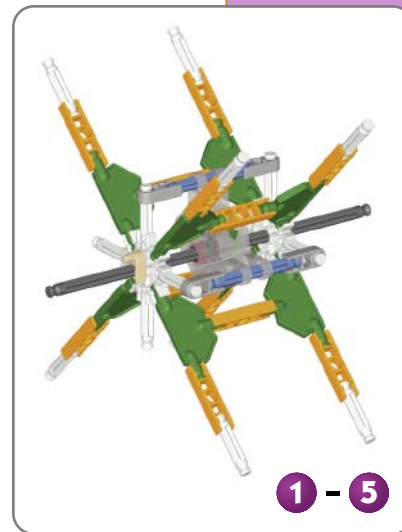
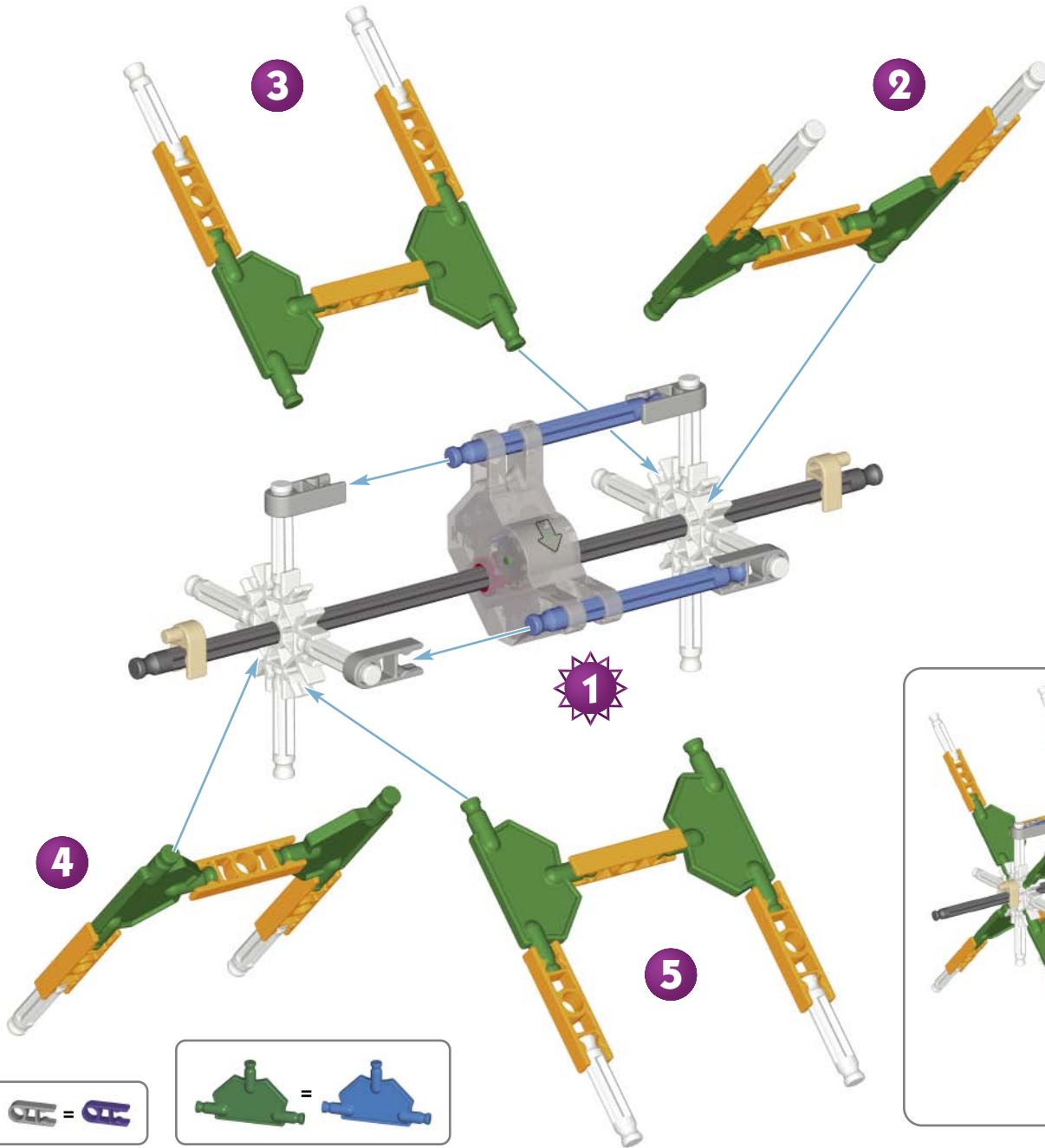
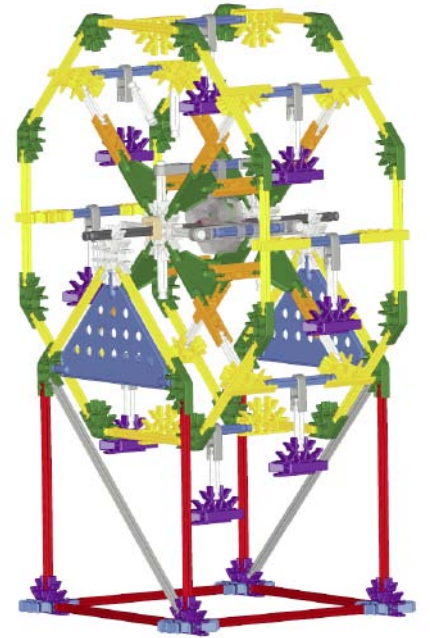

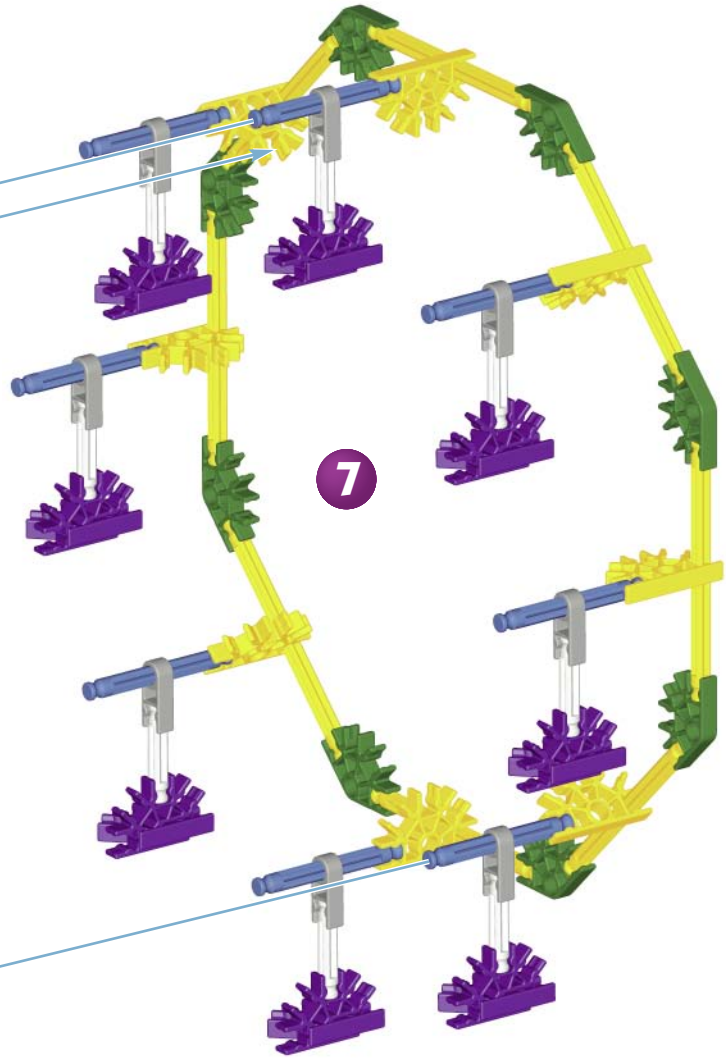
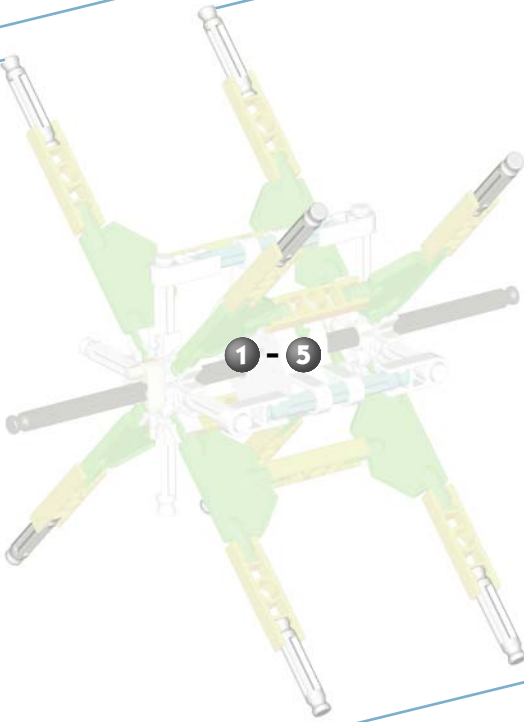
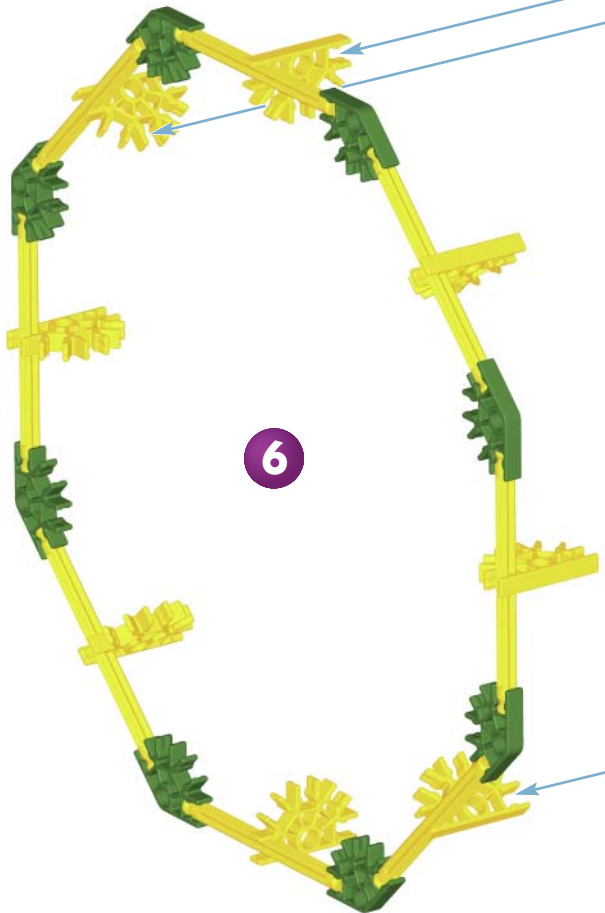
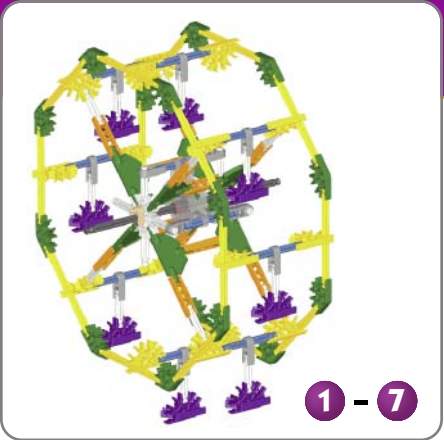

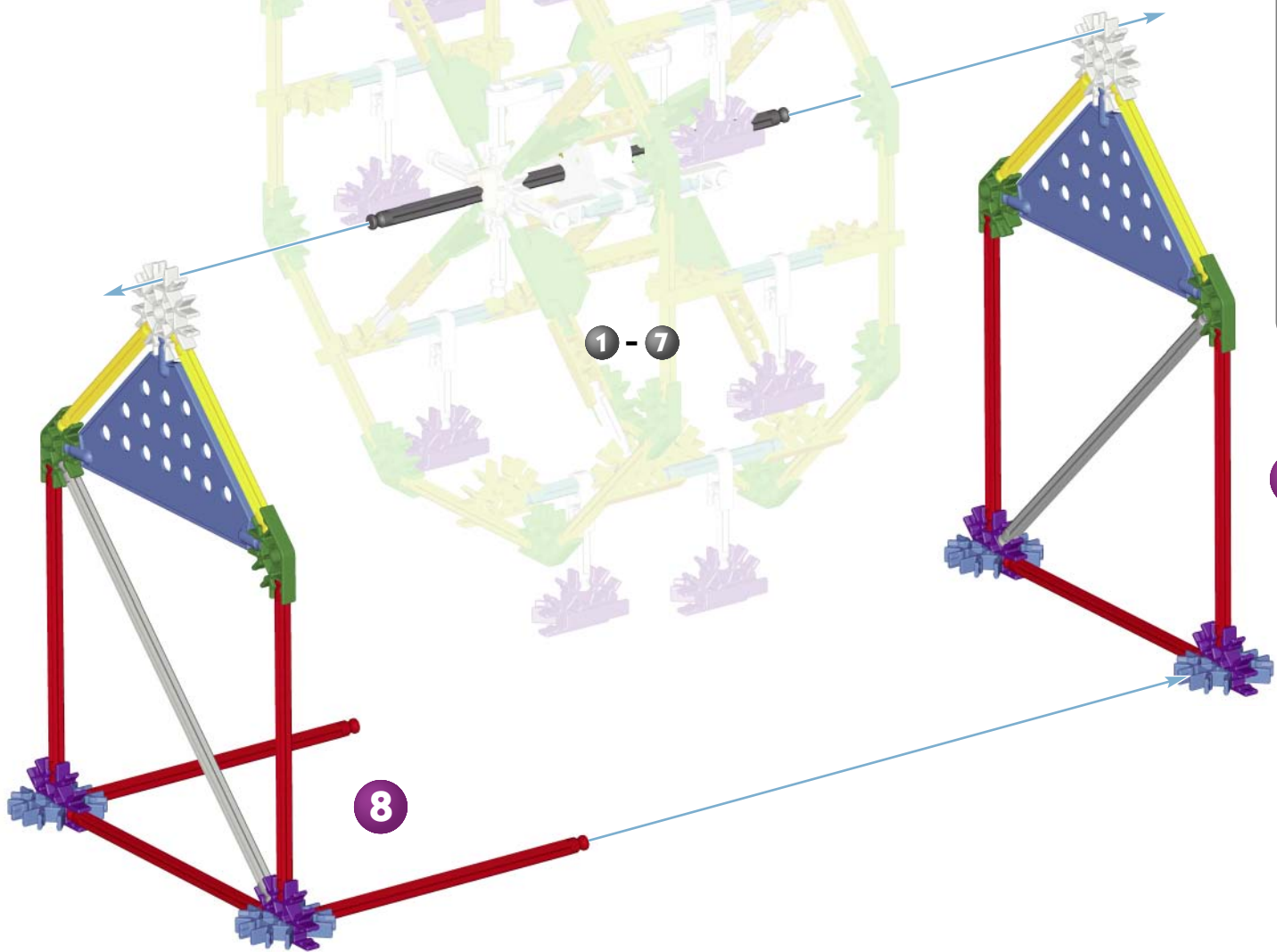
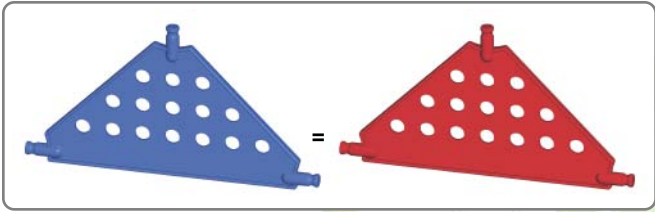

Golf Cart

Chariot
de Golf

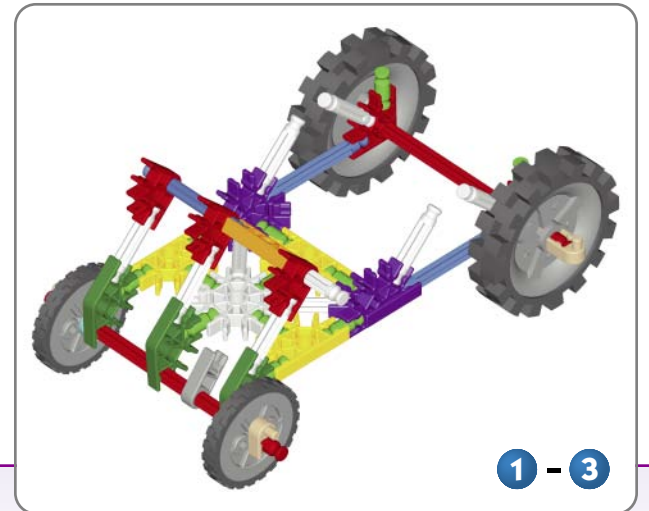
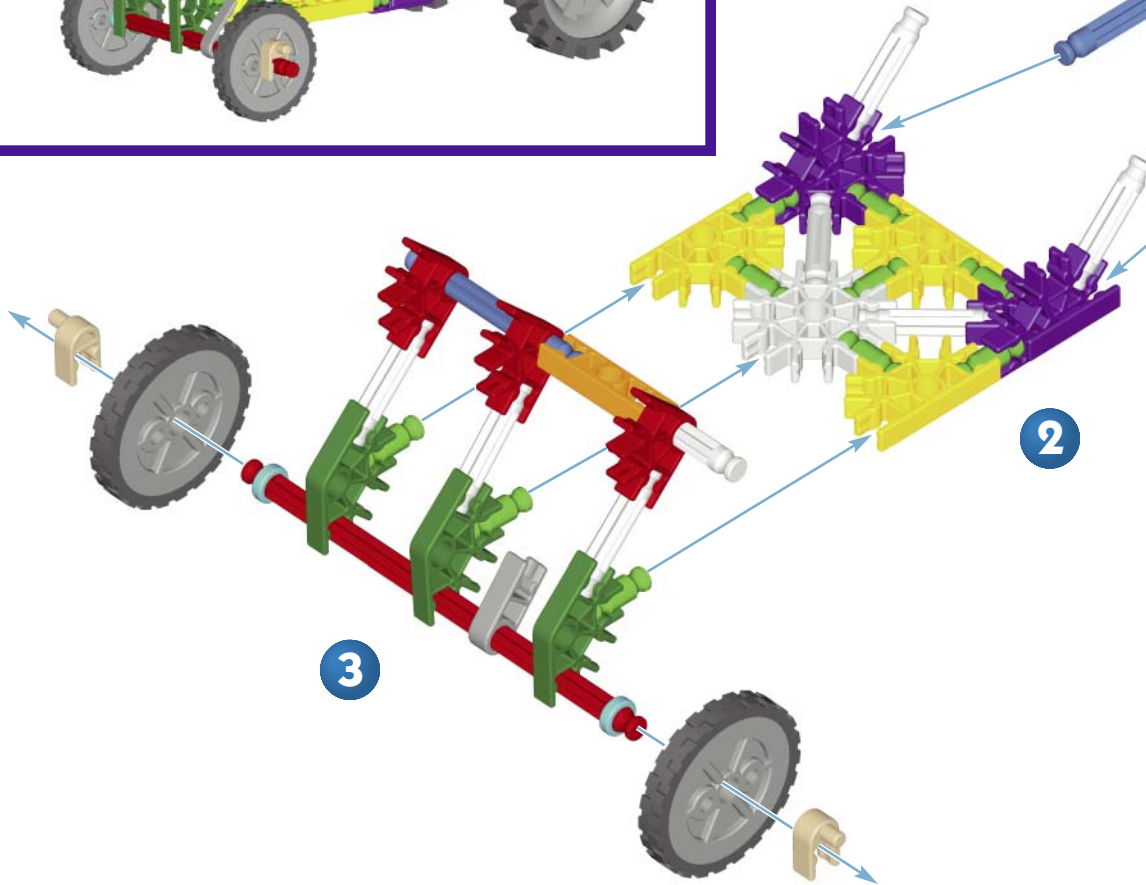
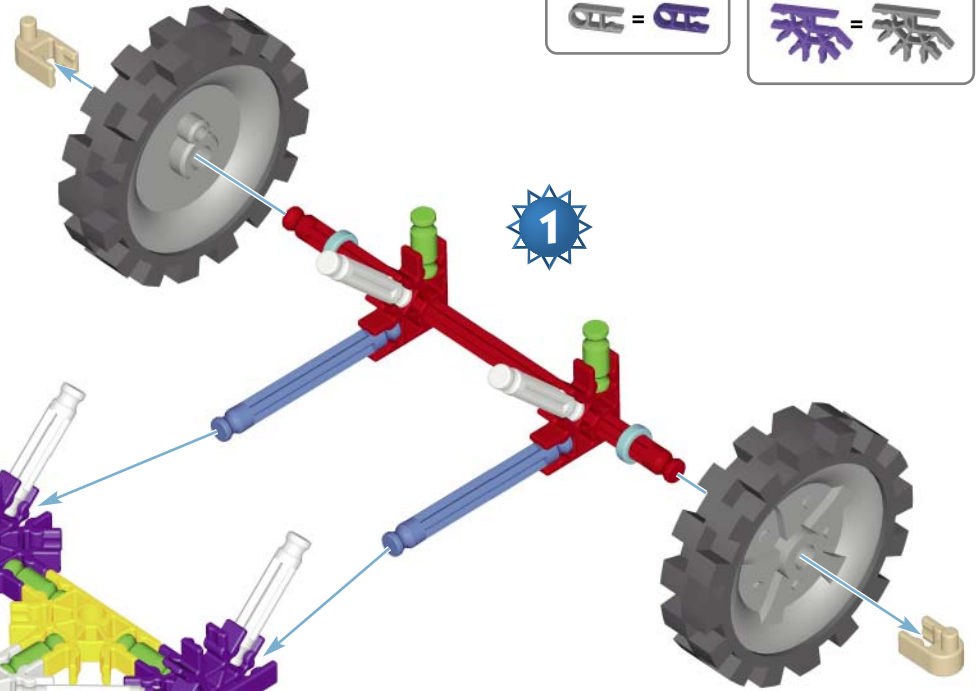
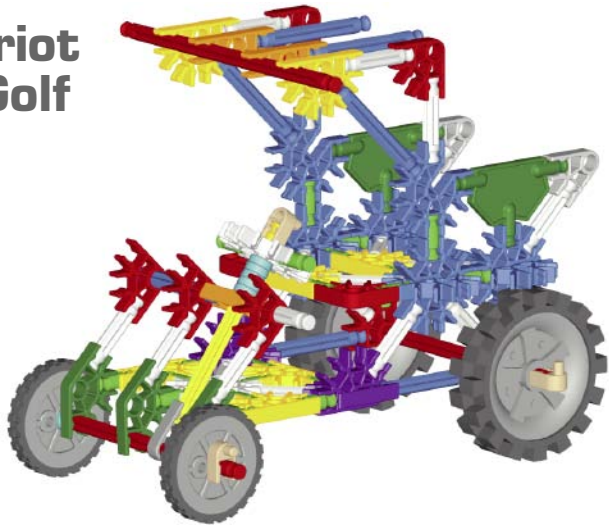

1 - 3

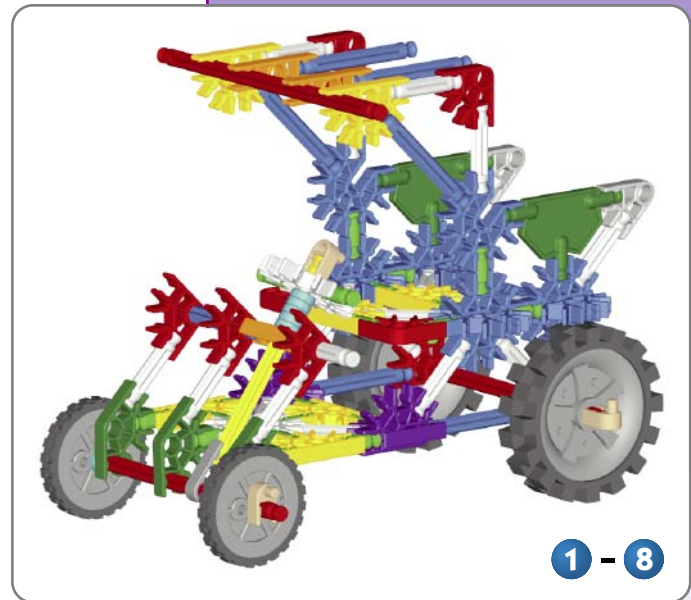
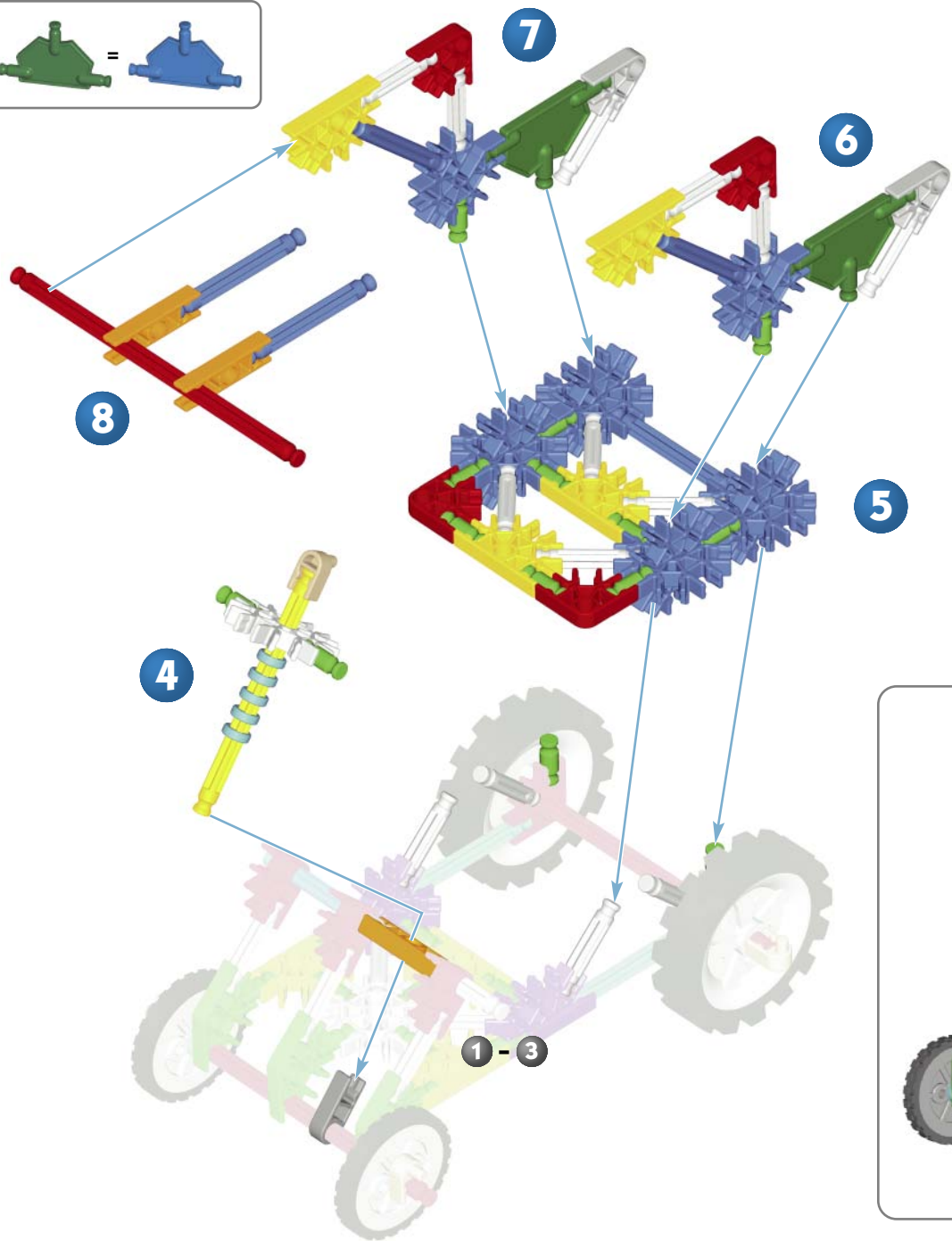
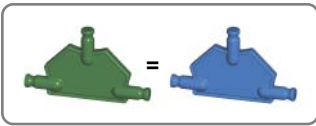

Praying Mantis

Mantis de prière

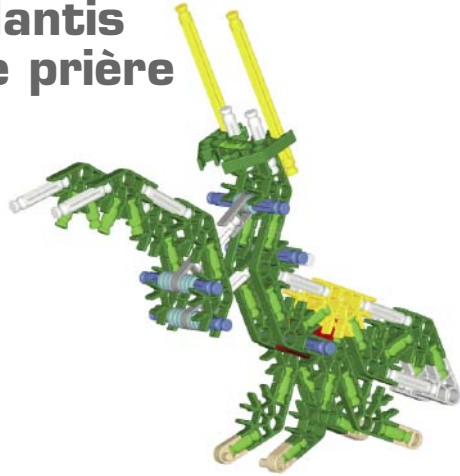

A = A

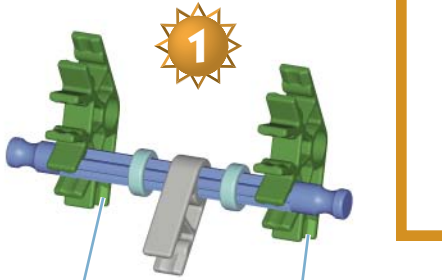

1

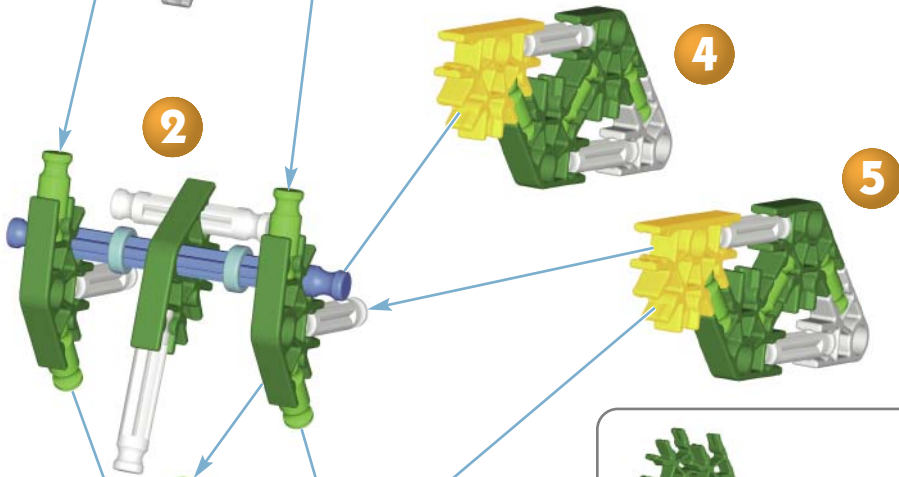

2



4



5



3

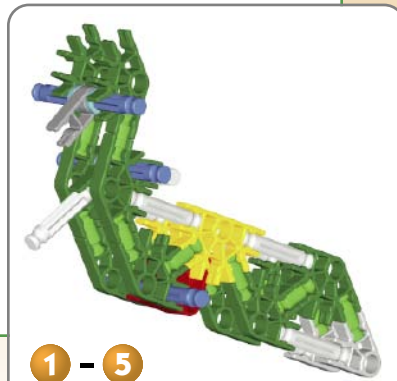

1 - 5

6

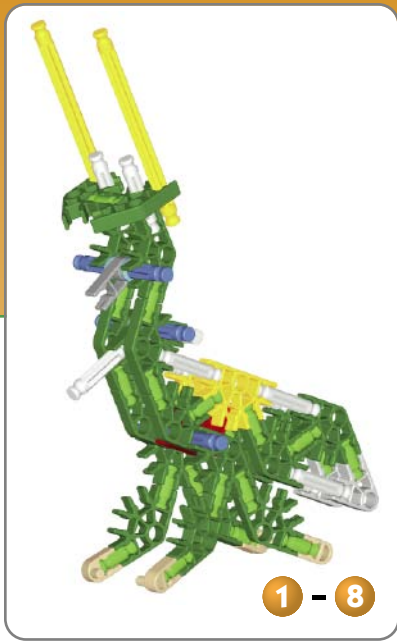

1 - 8

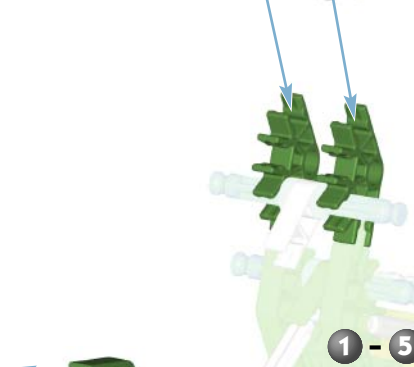

1 - 5

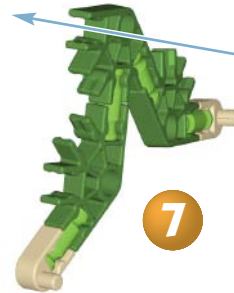

7



8

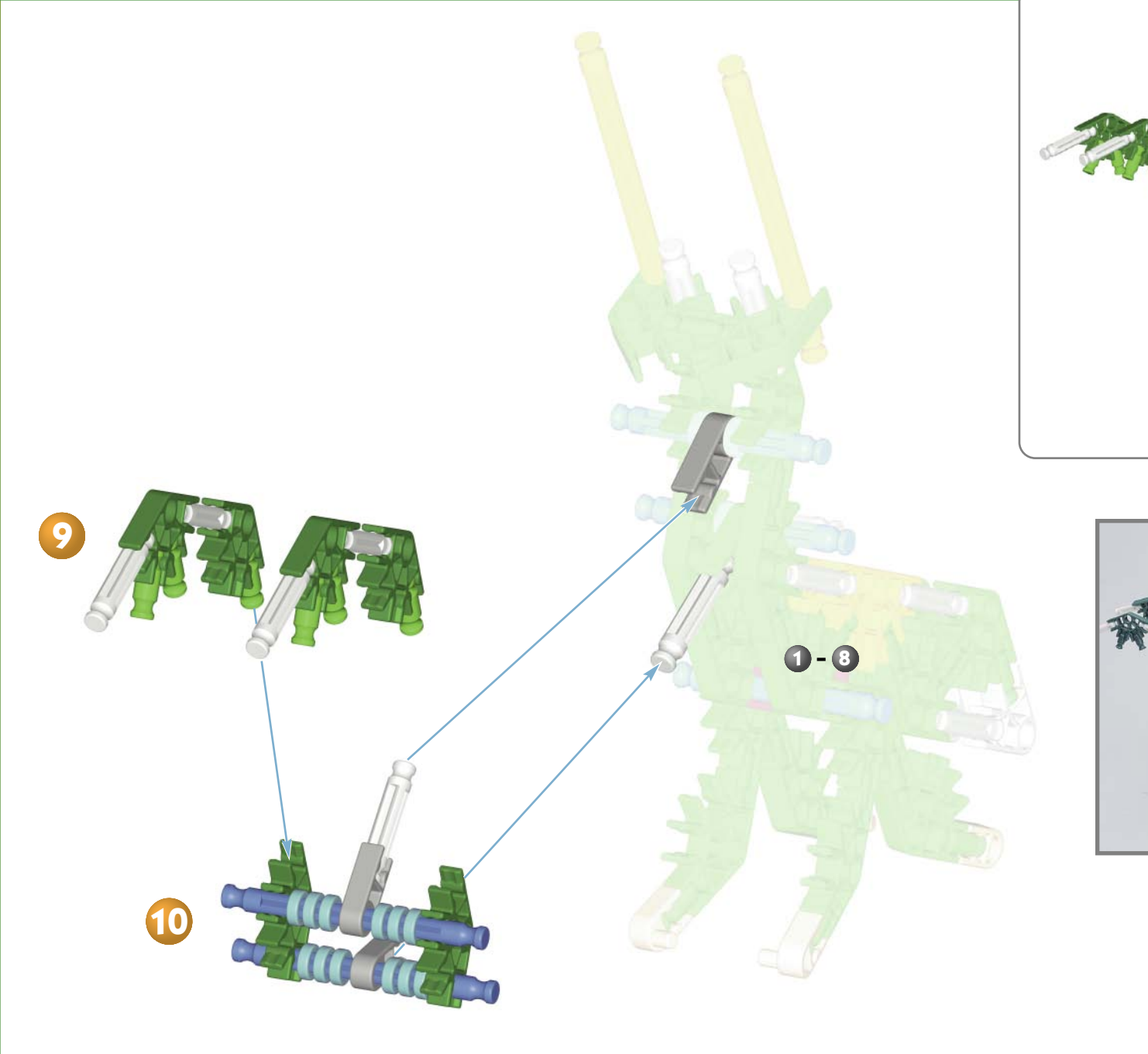

Helicopter

Hélicoptère

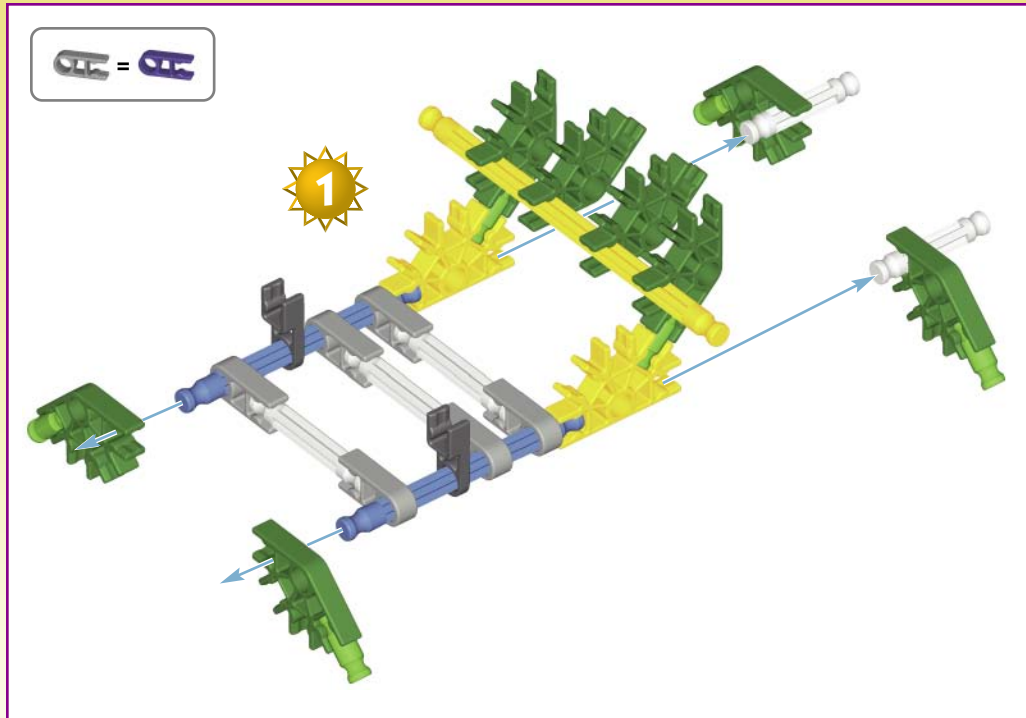
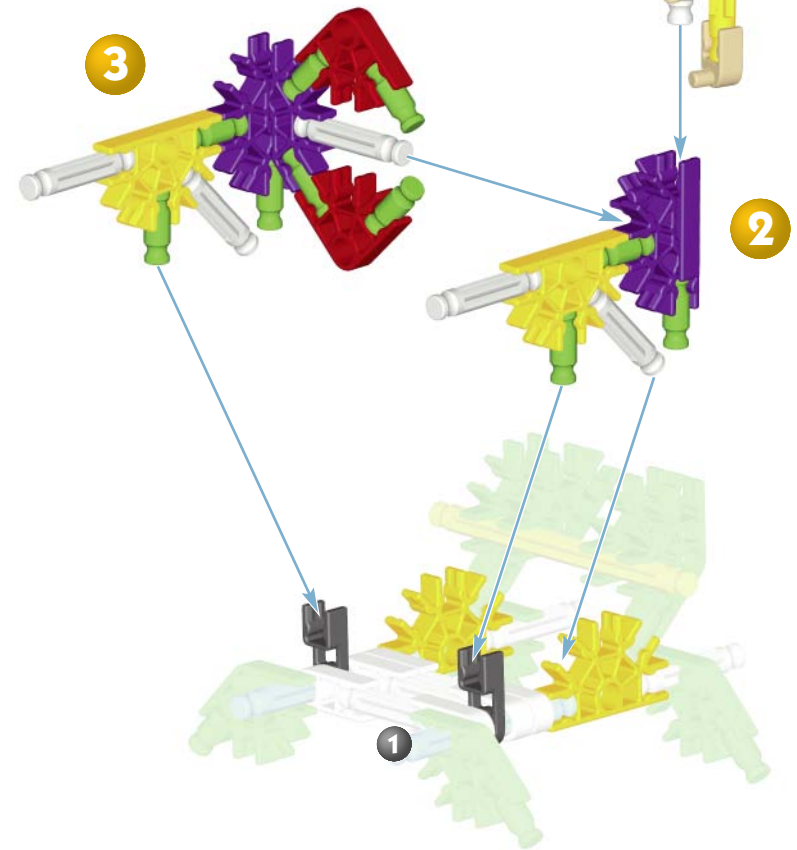
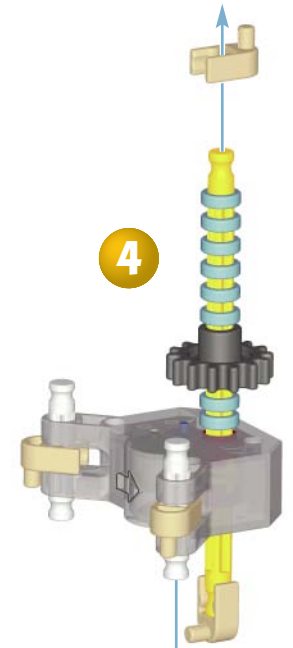
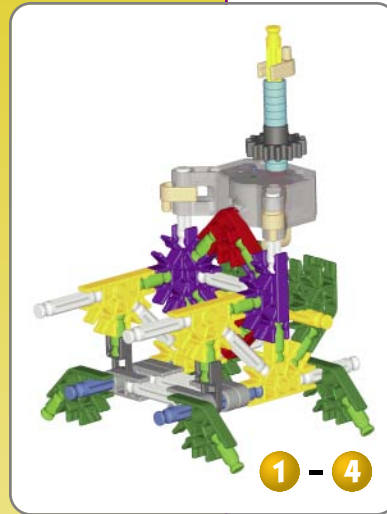
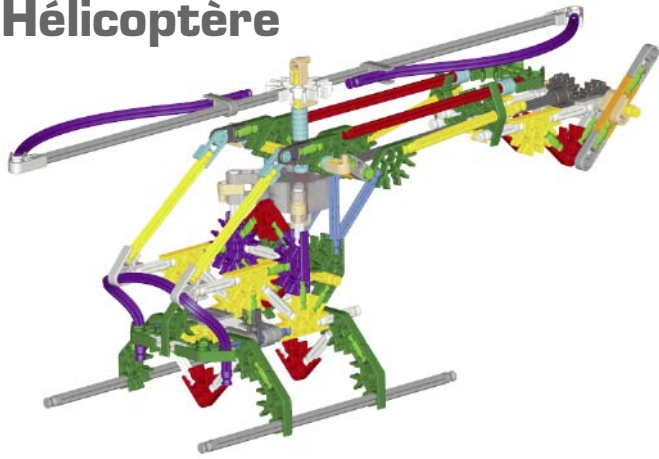

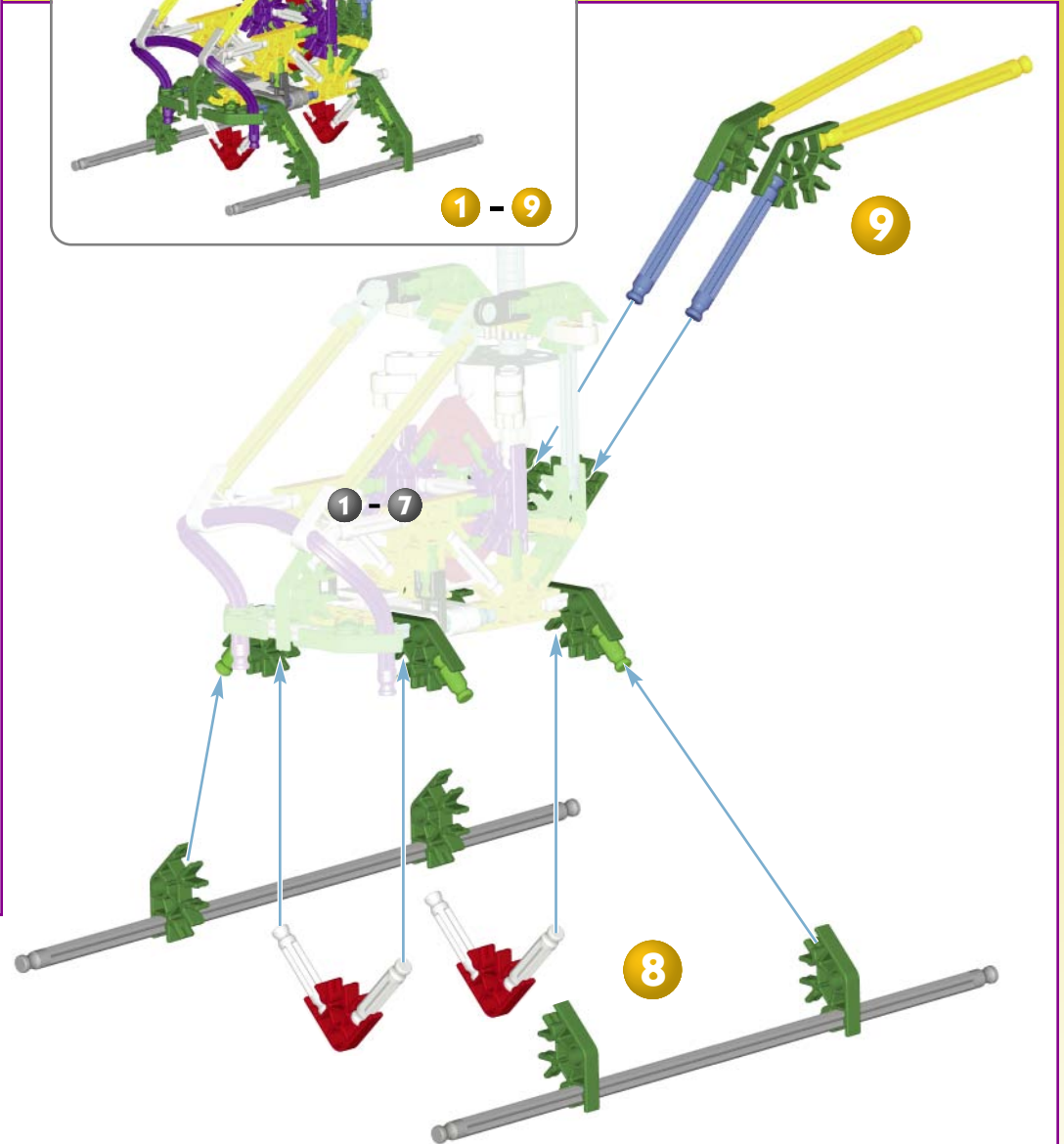
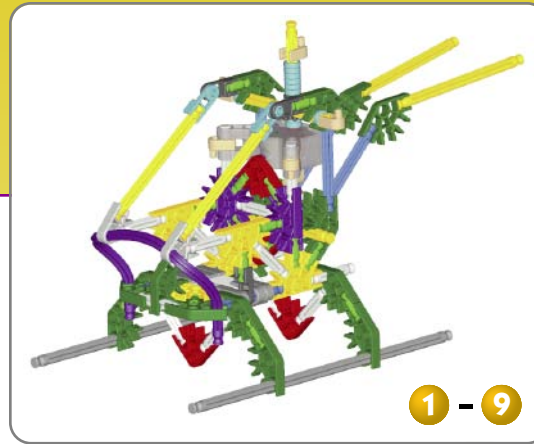
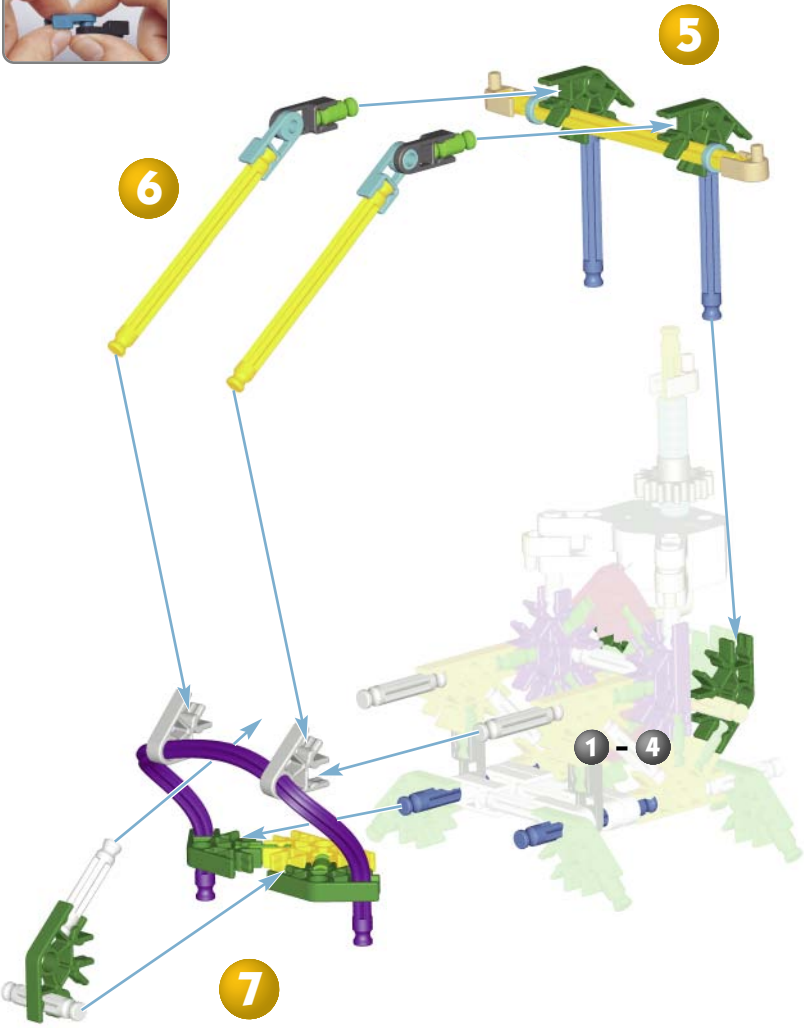

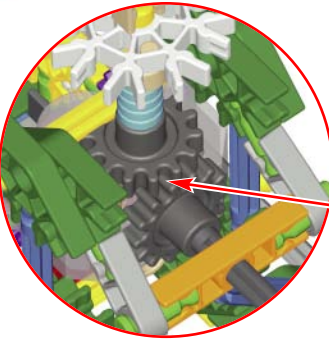
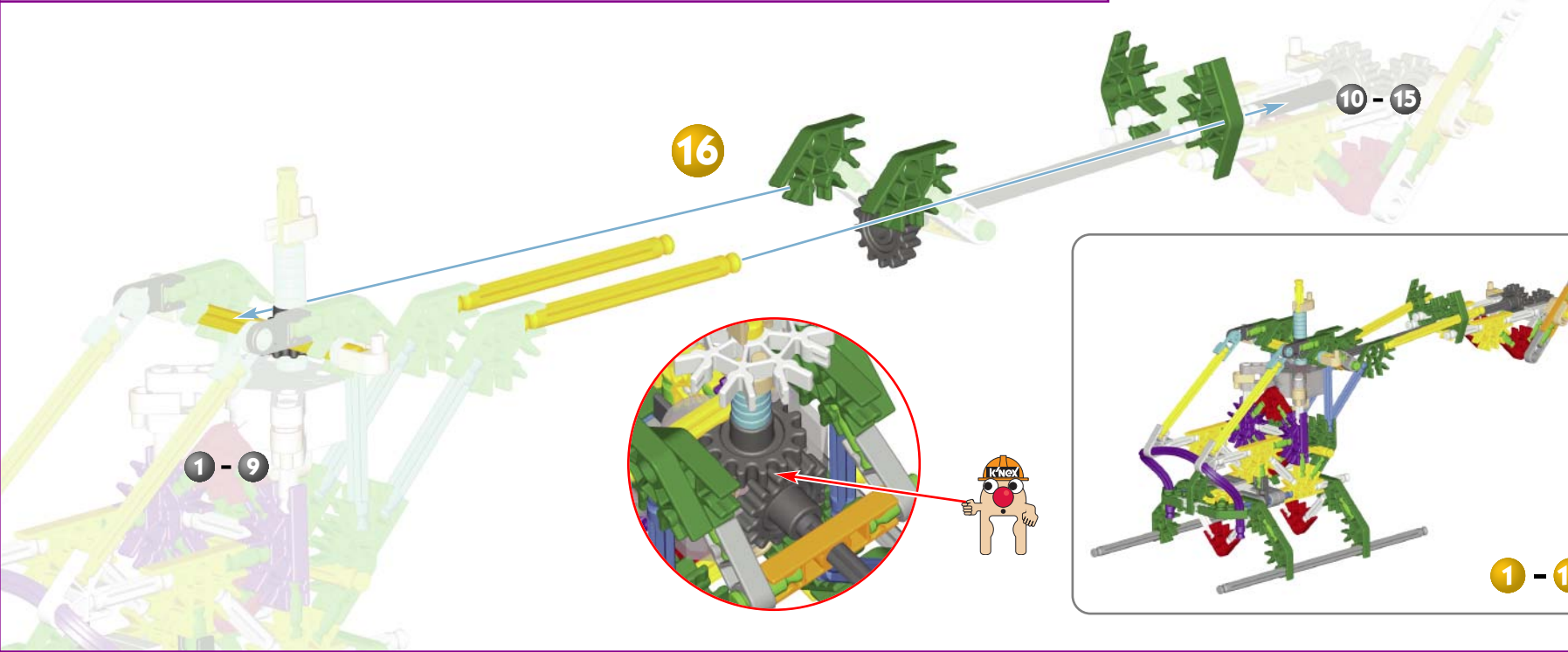
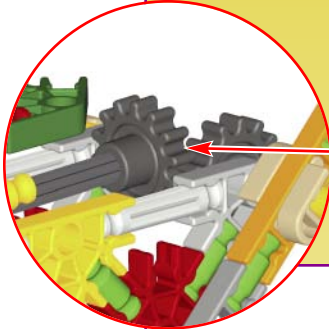
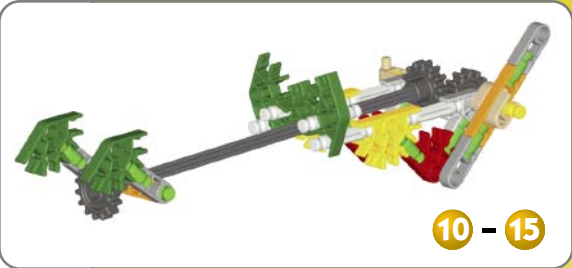
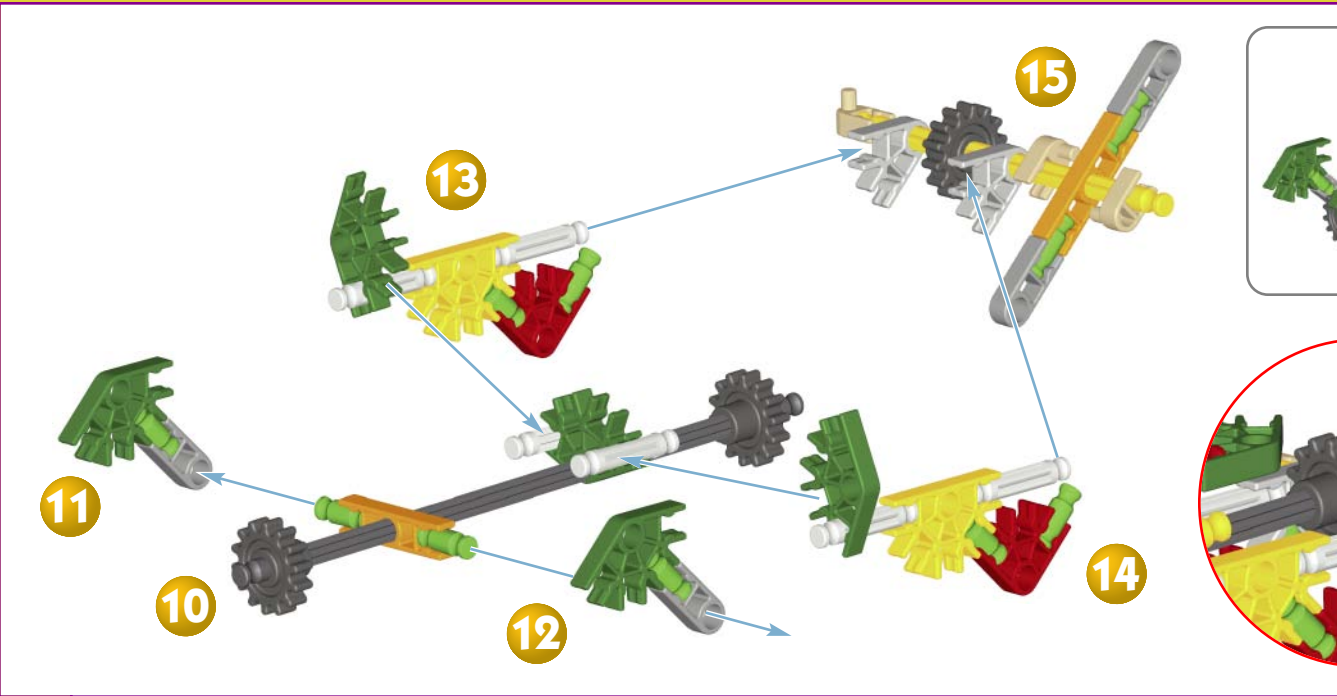

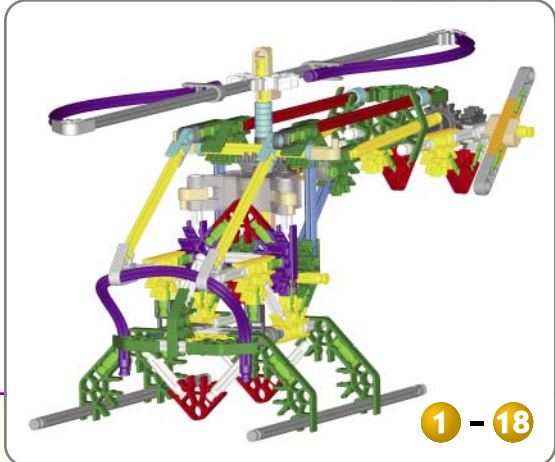
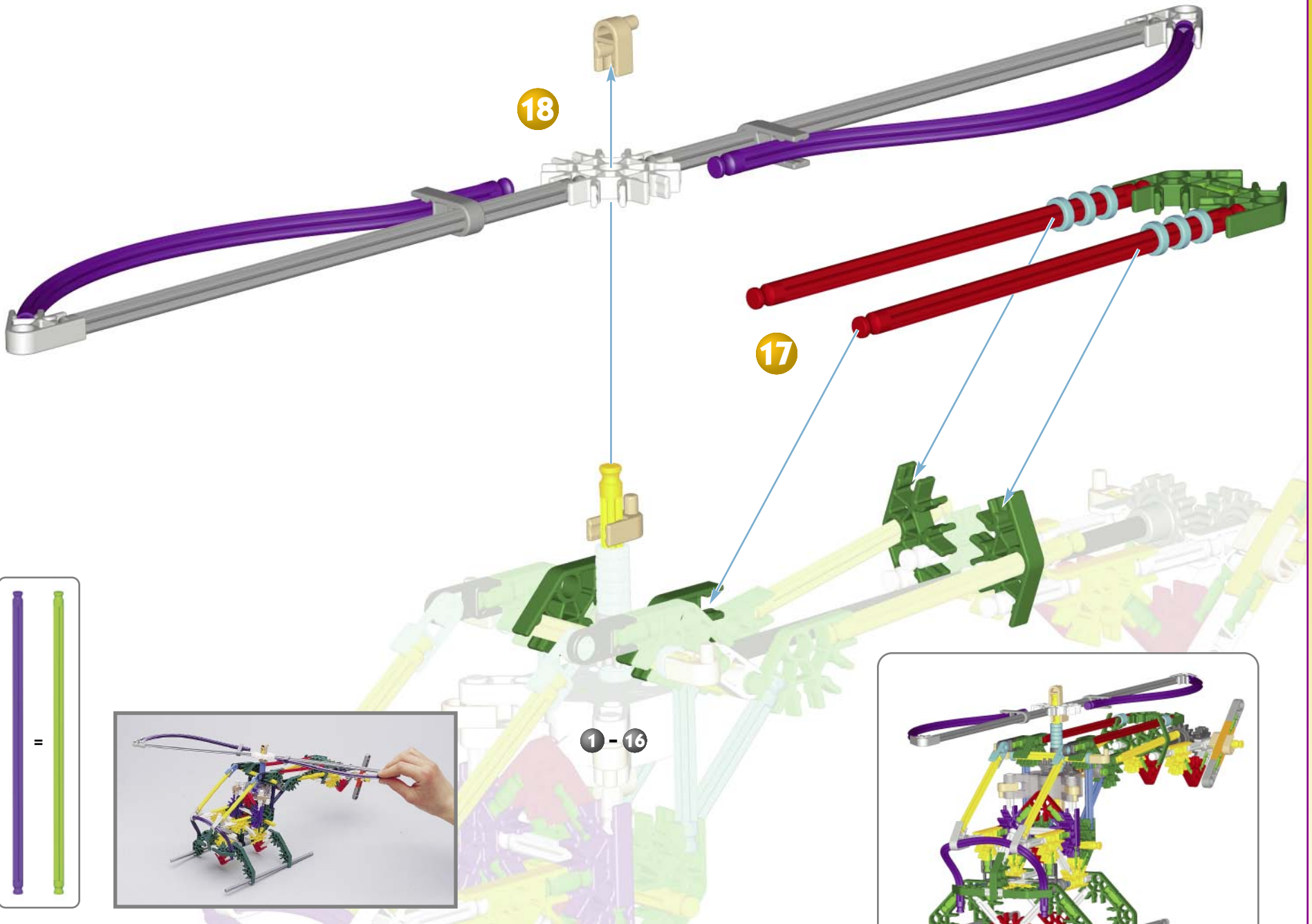

Windmill

Moulin à vent

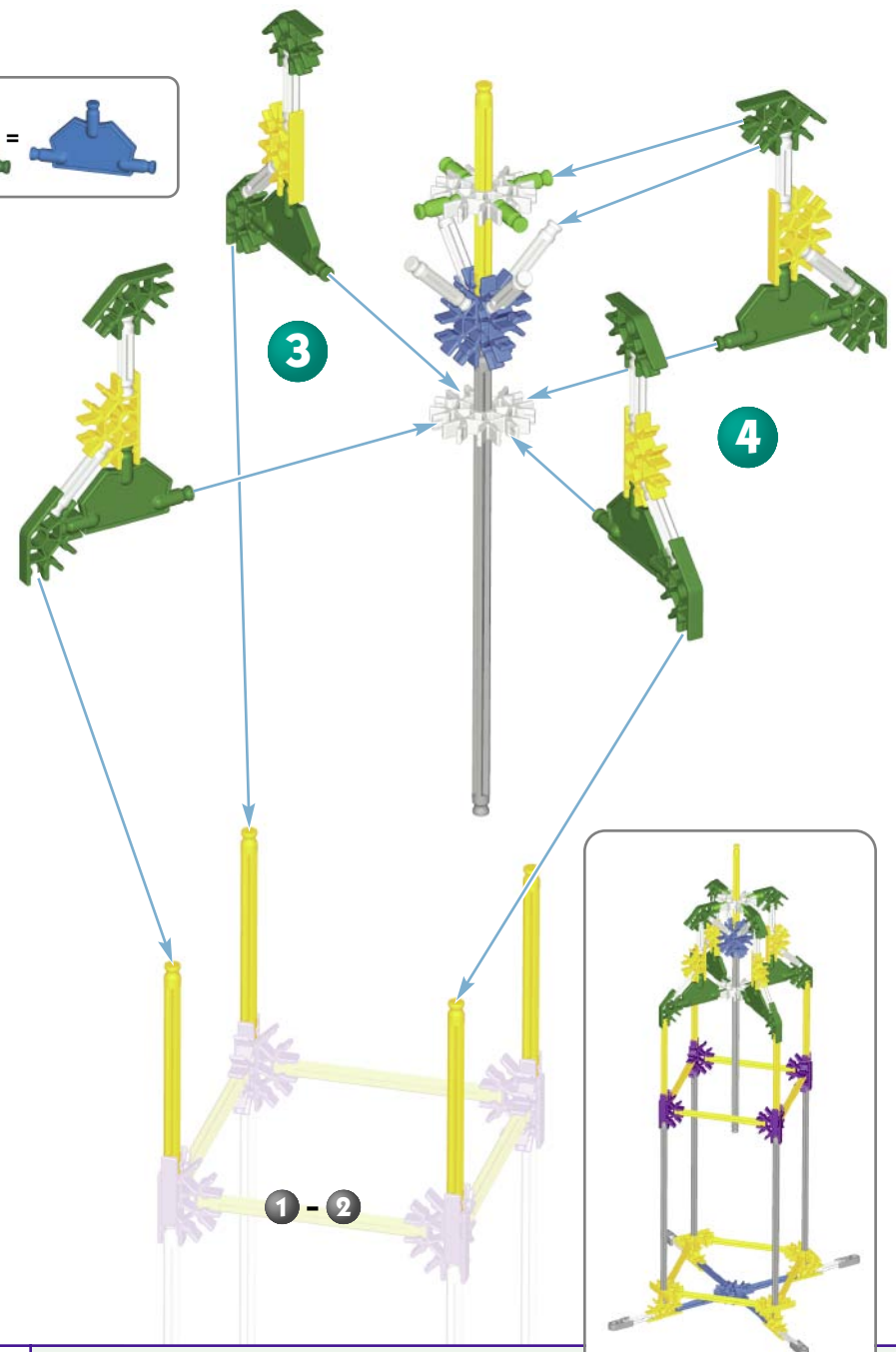
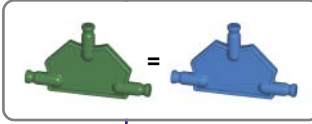
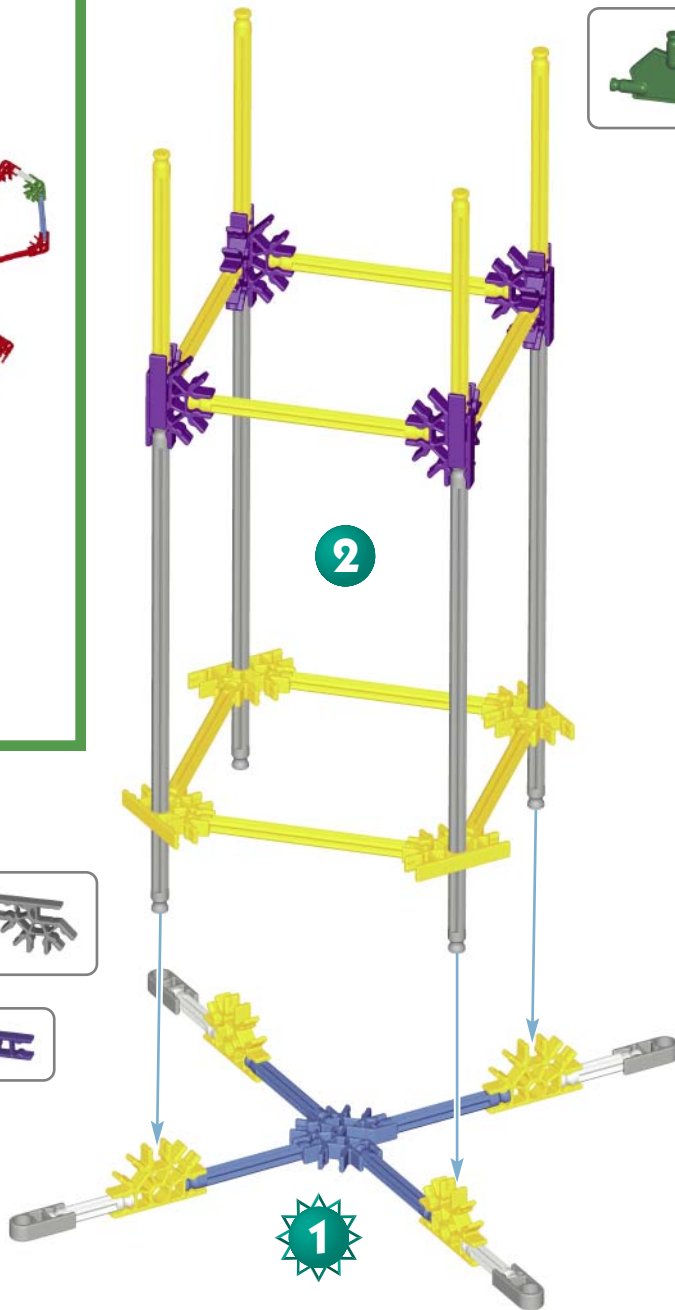
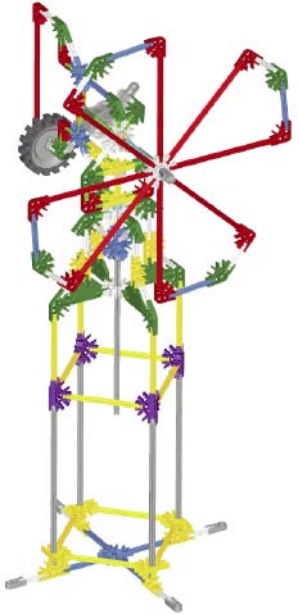

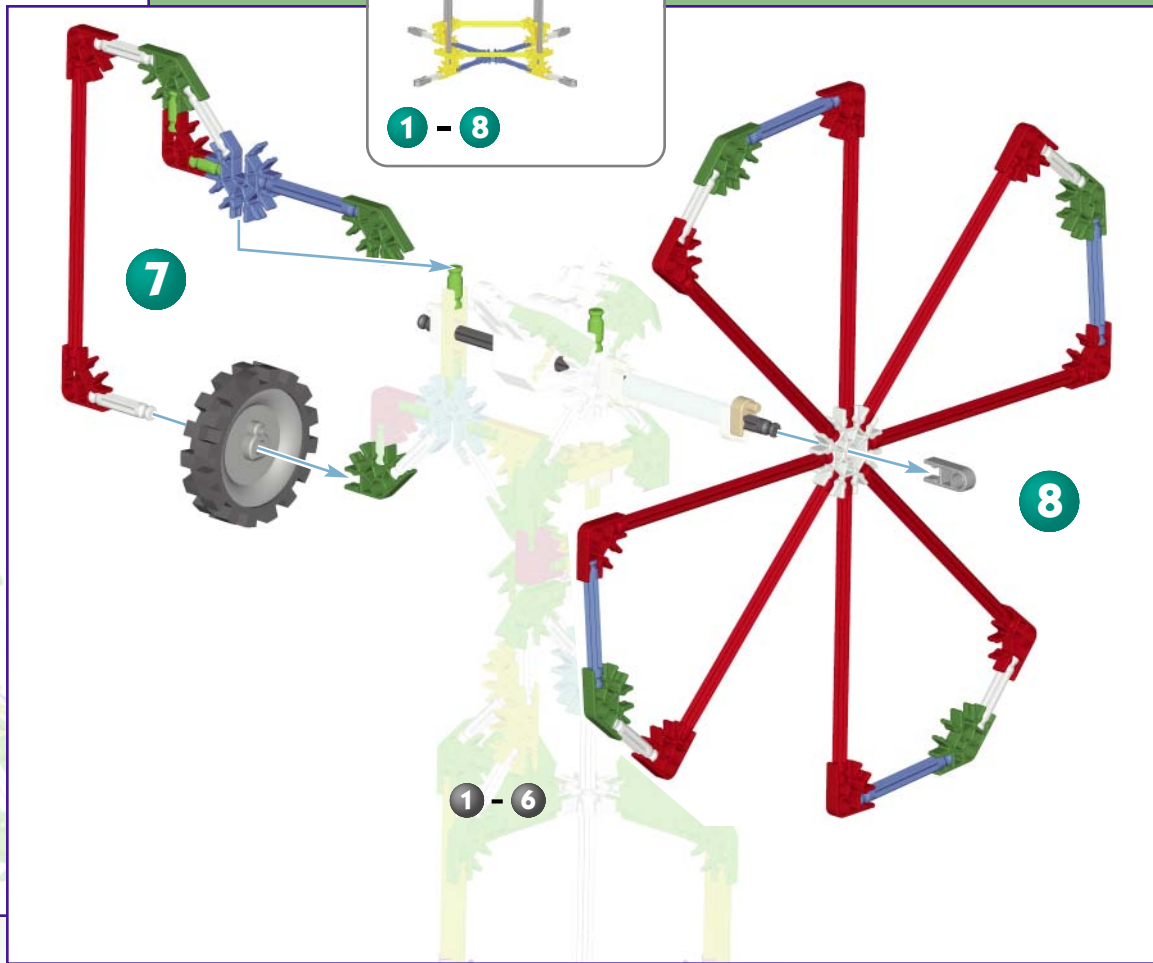
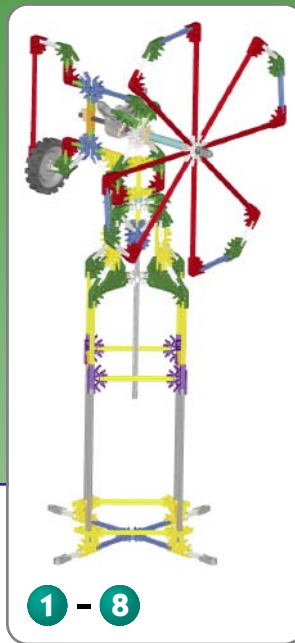
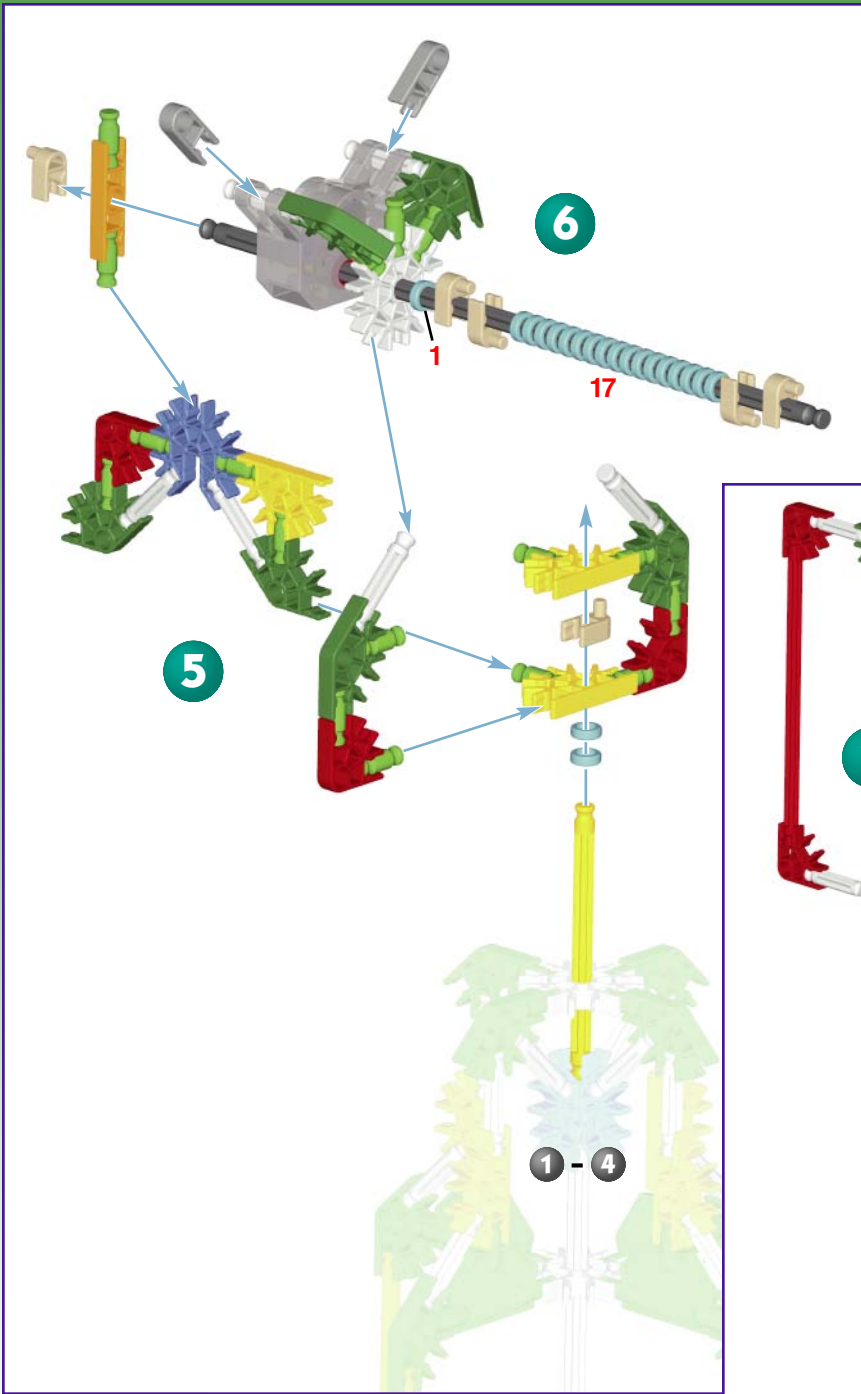

Spaceship Ride

Tour de vaisseau spatial

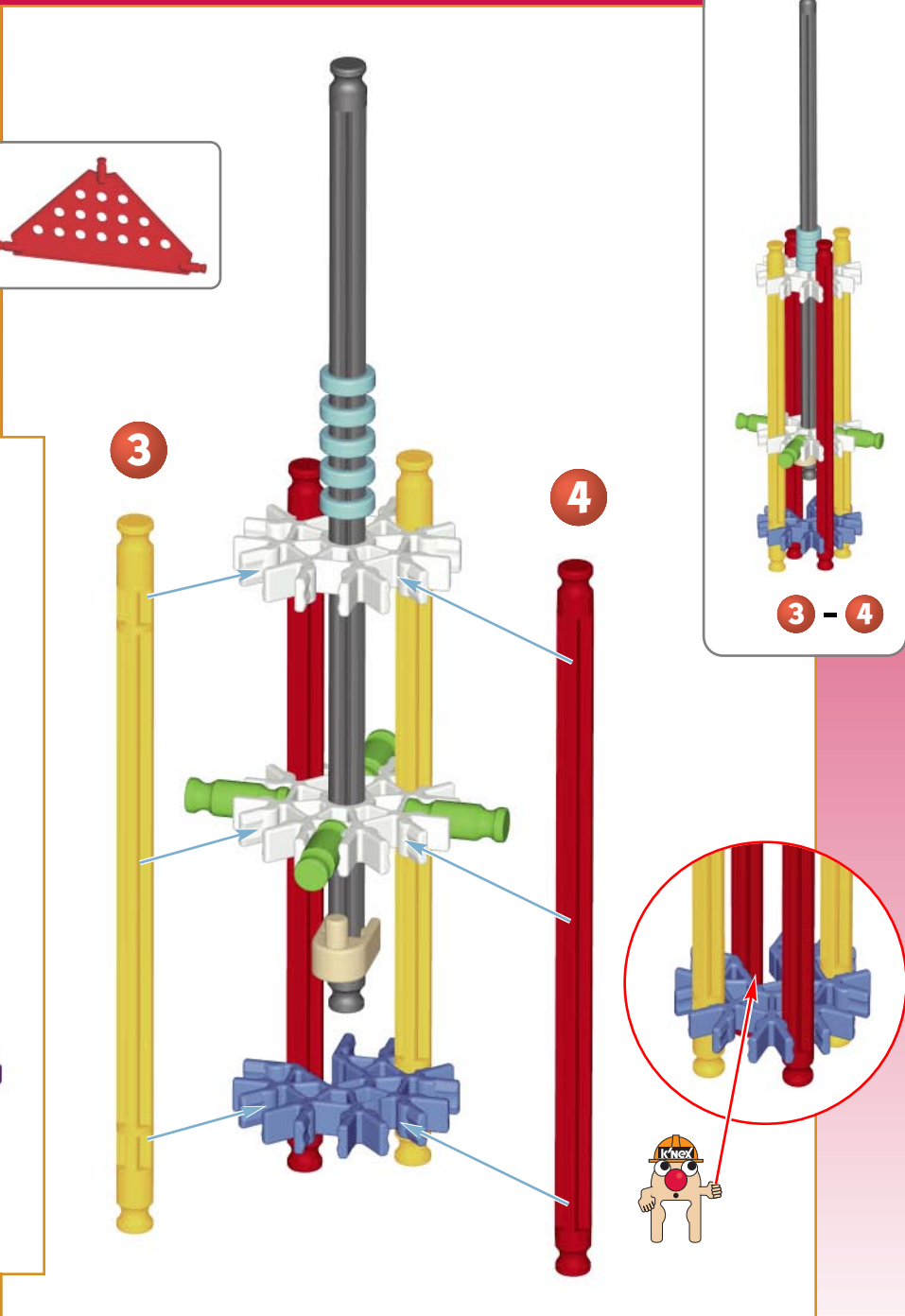
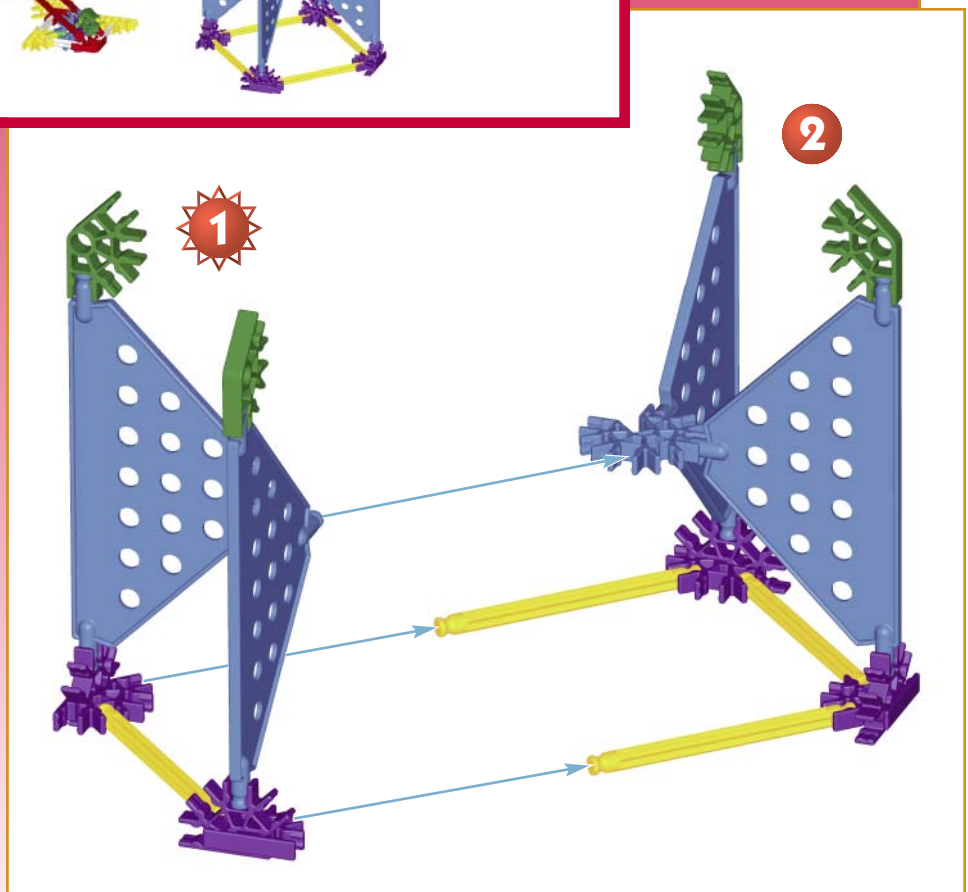
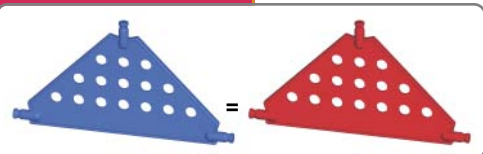
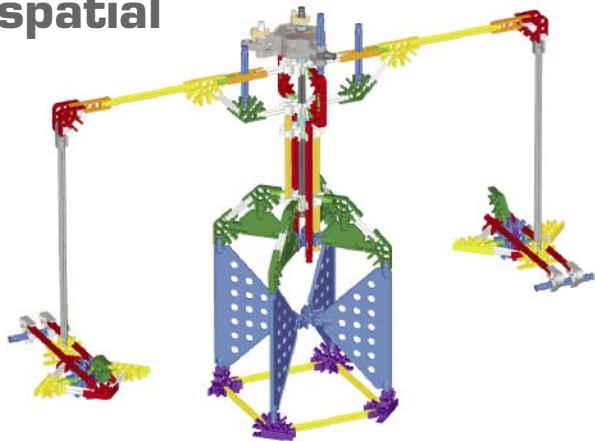

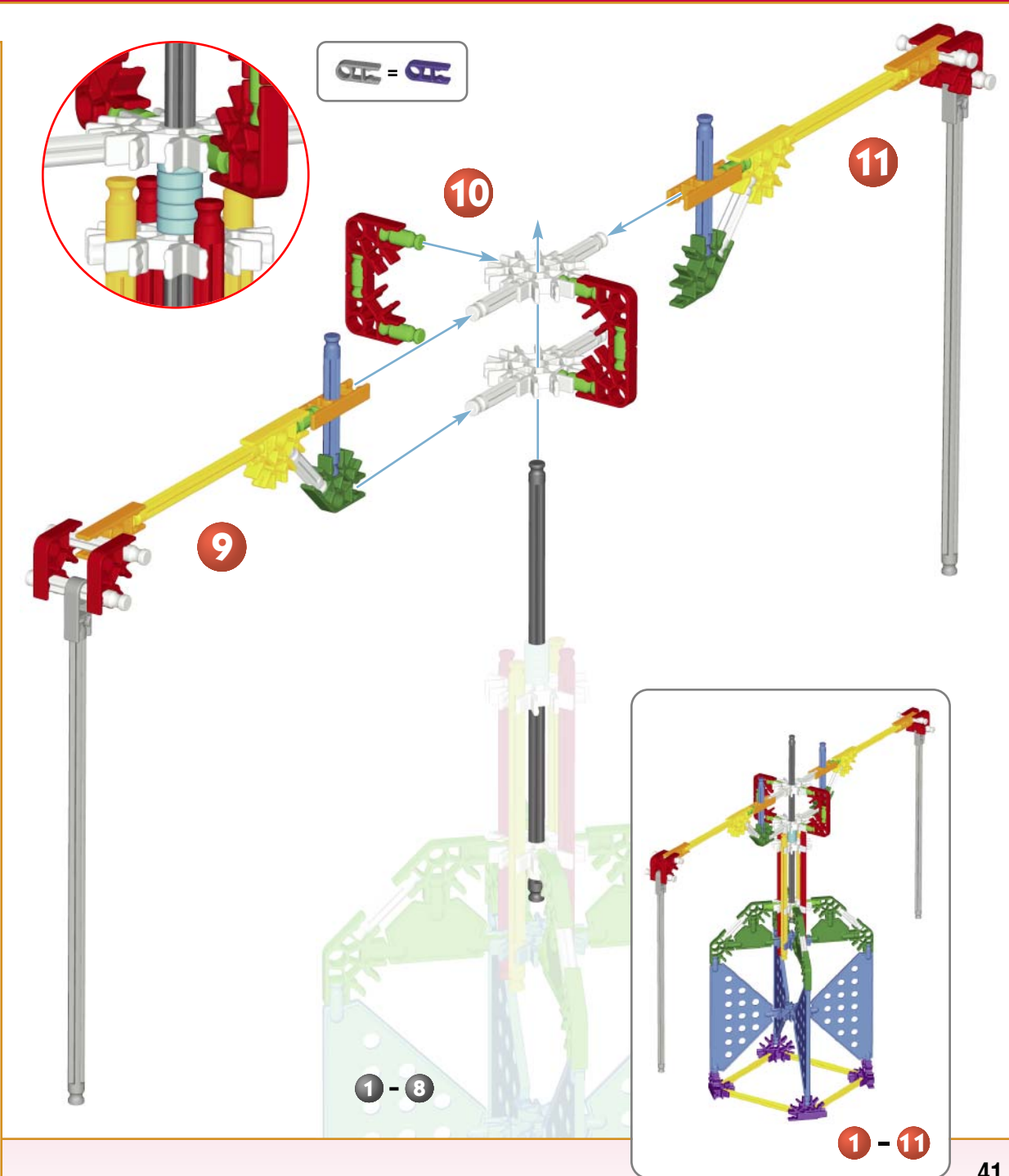
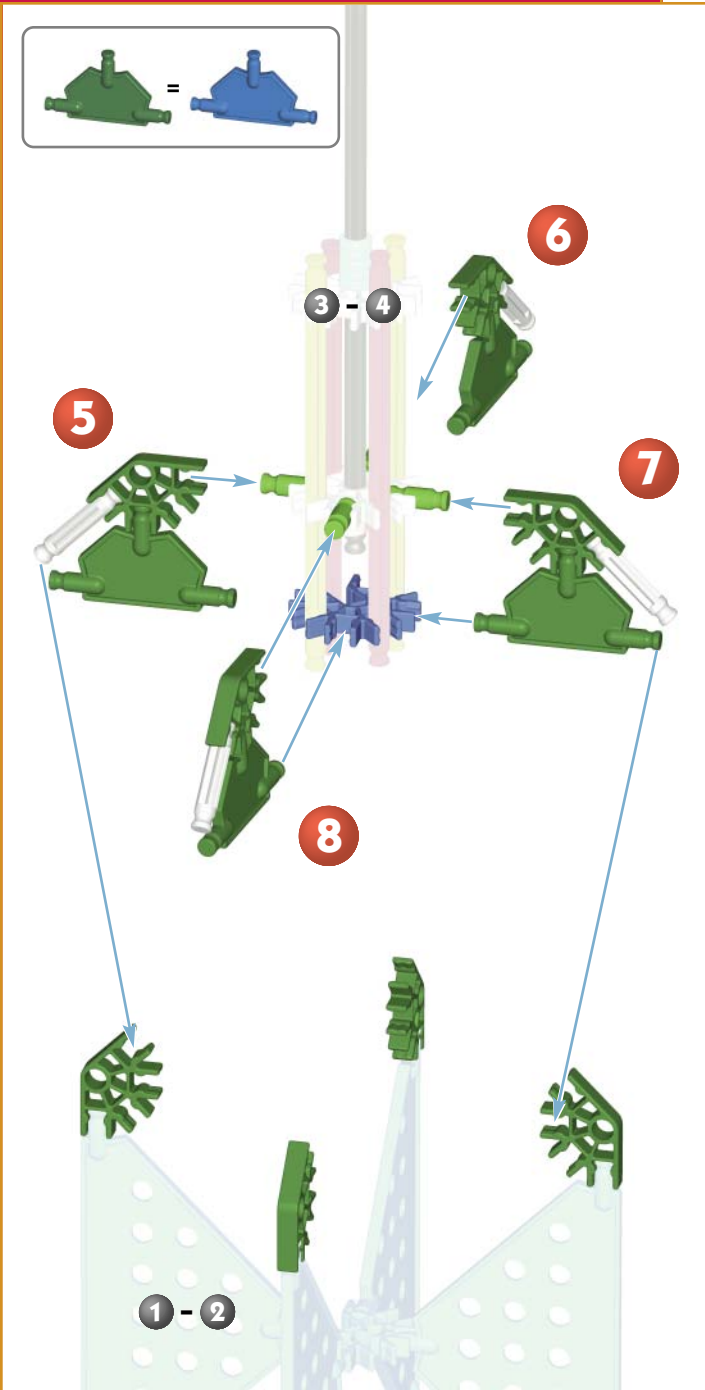

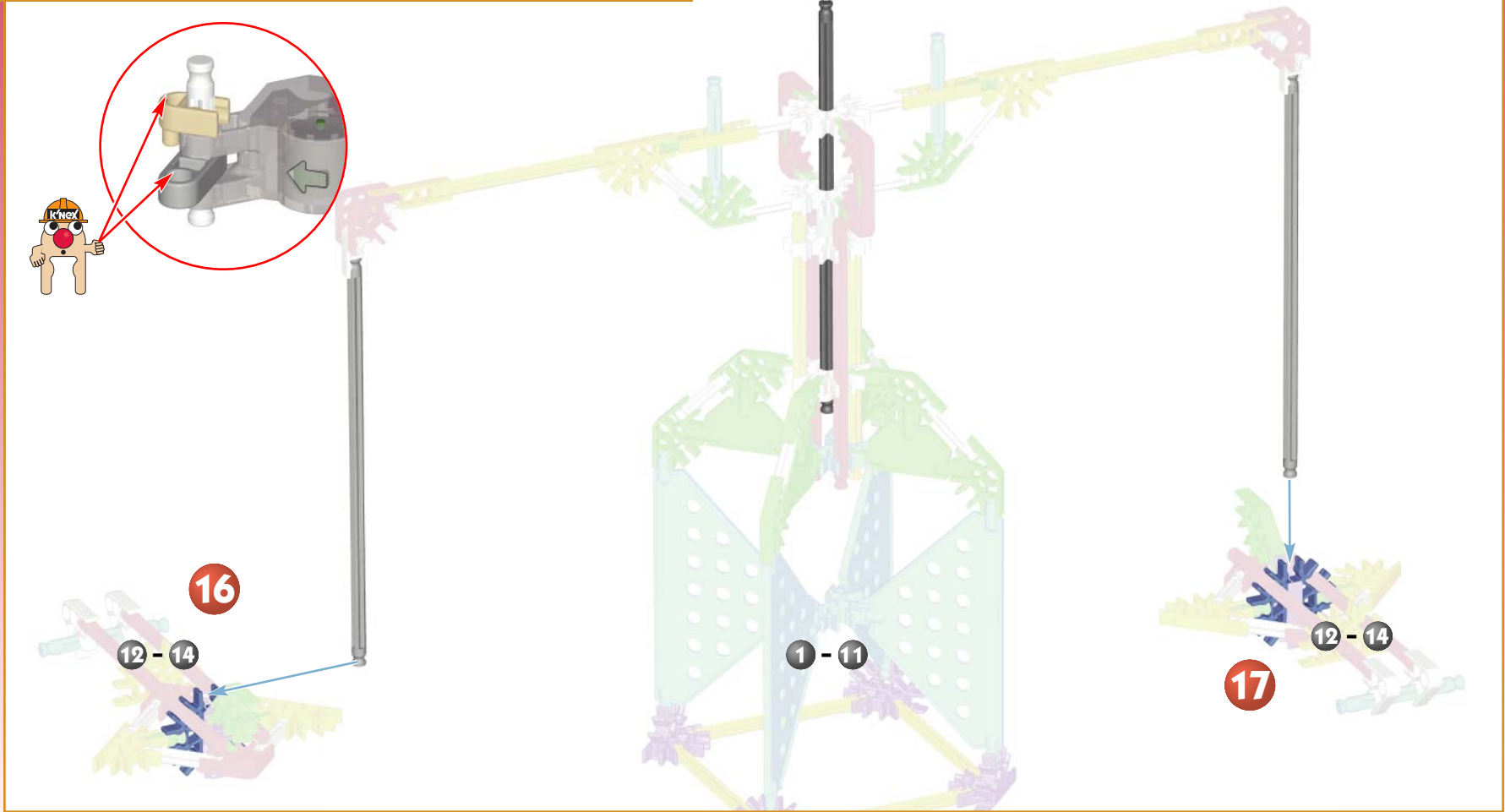
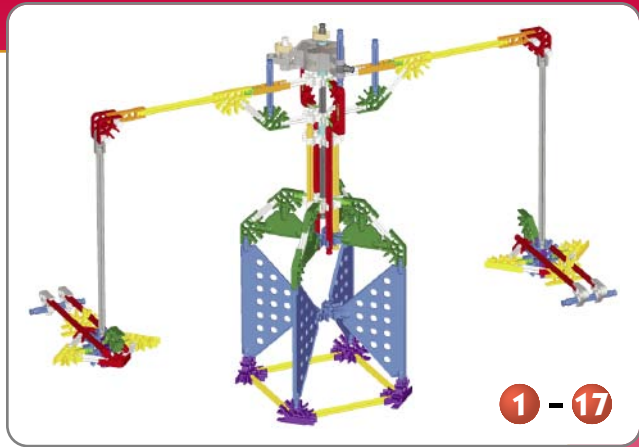
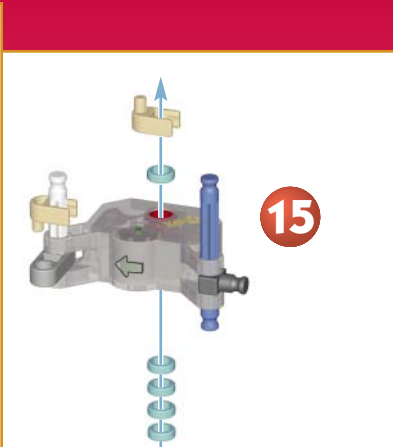
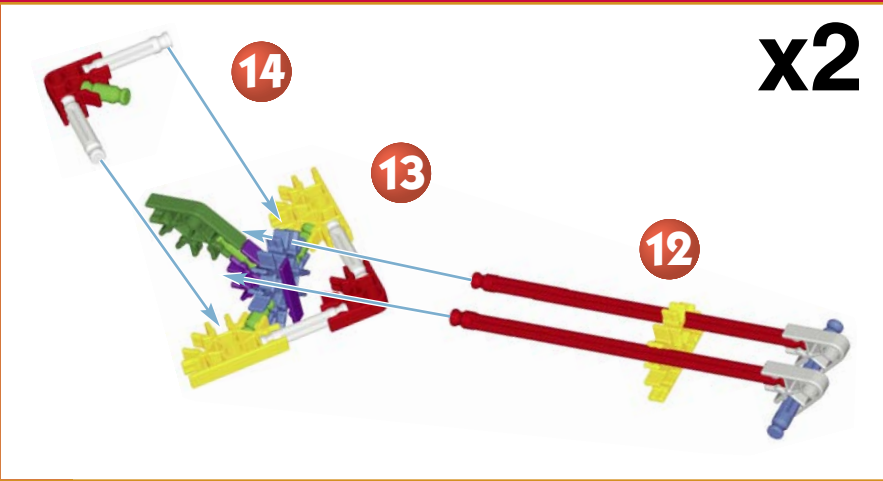

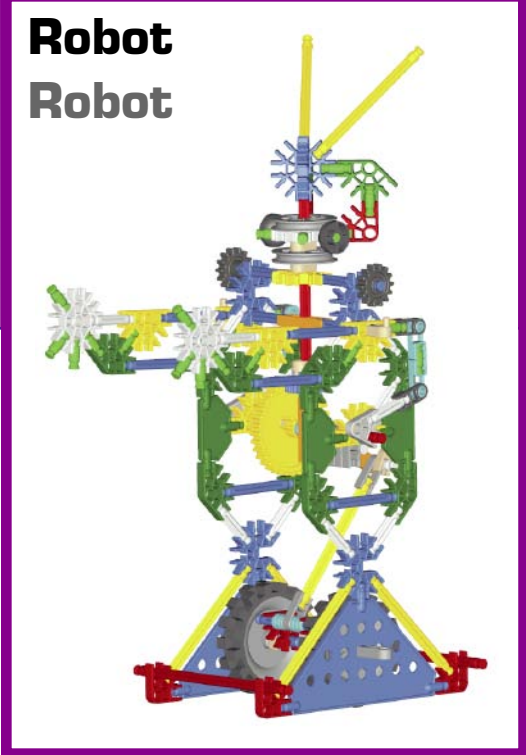
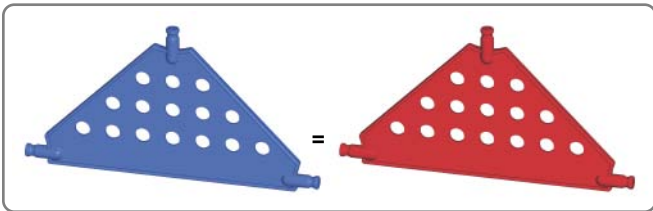
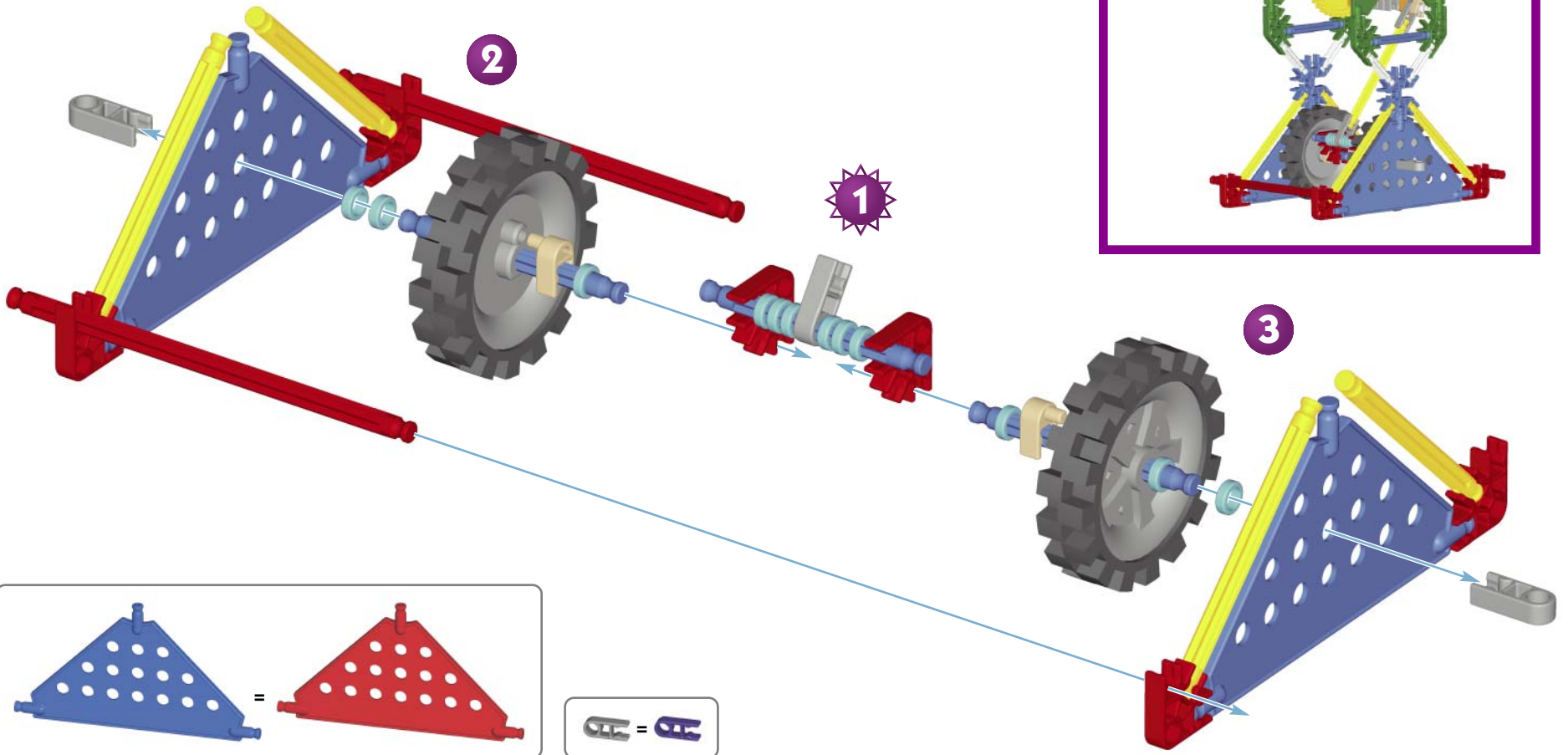
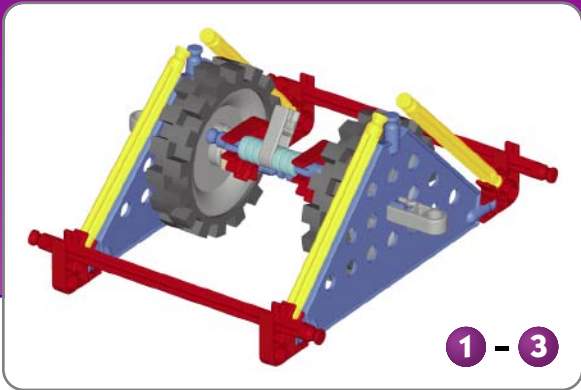

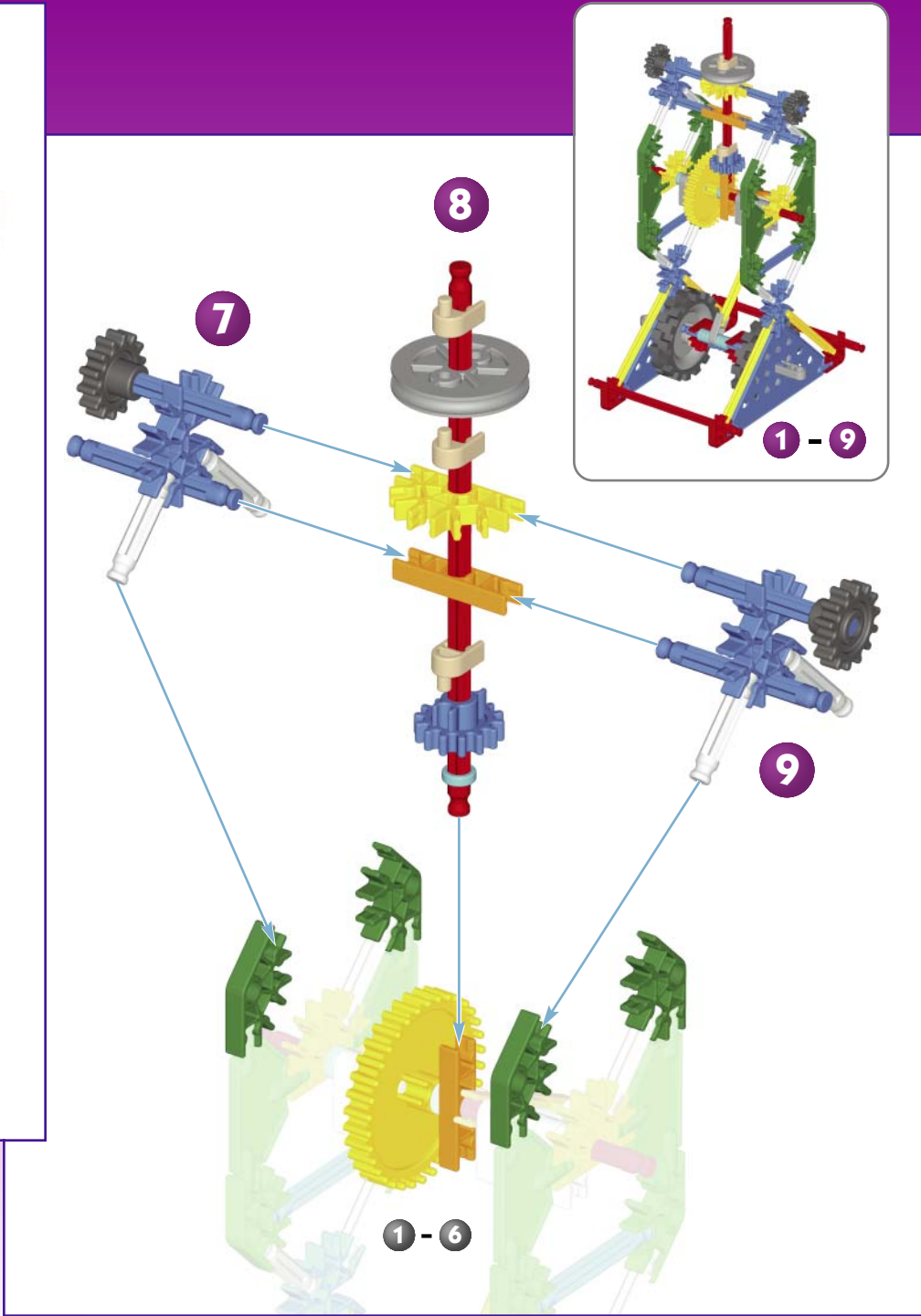
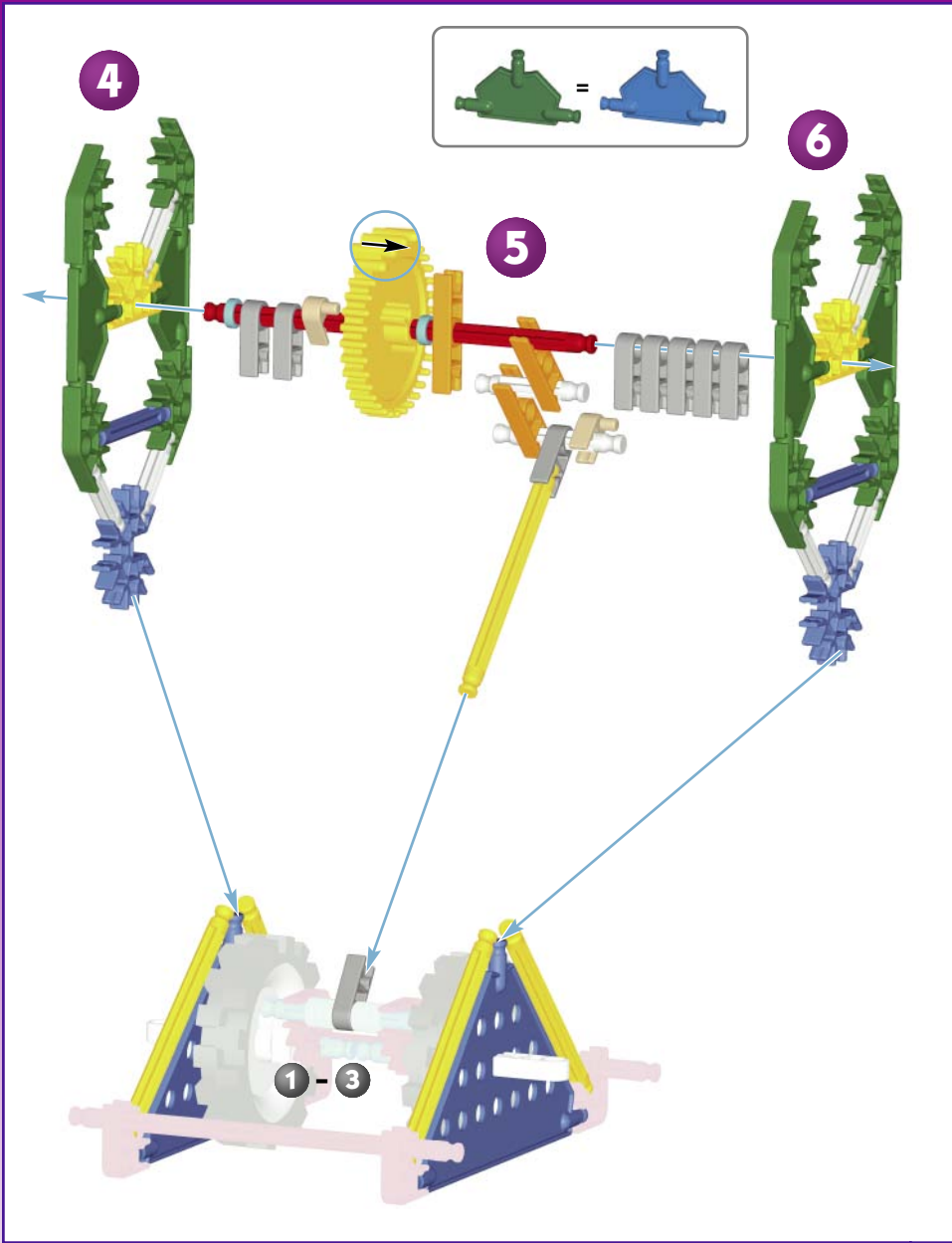

x2

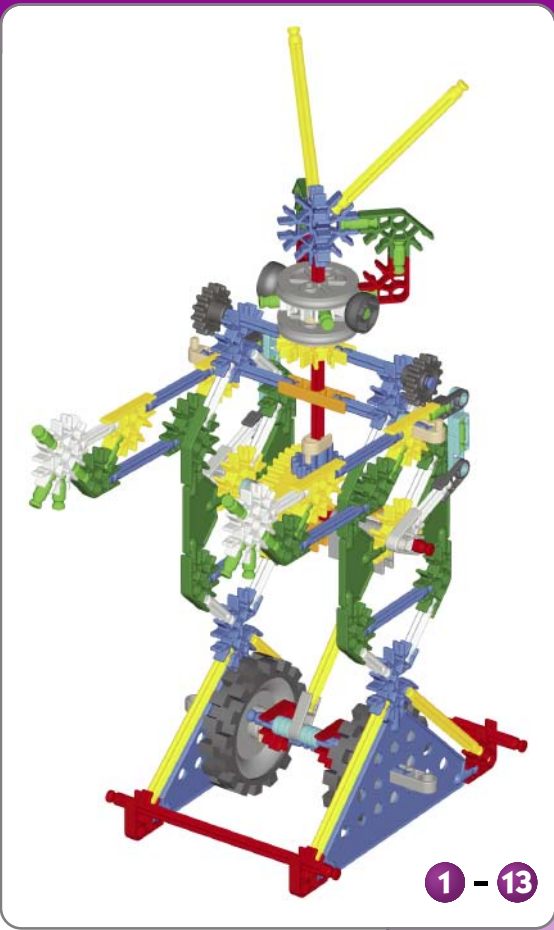
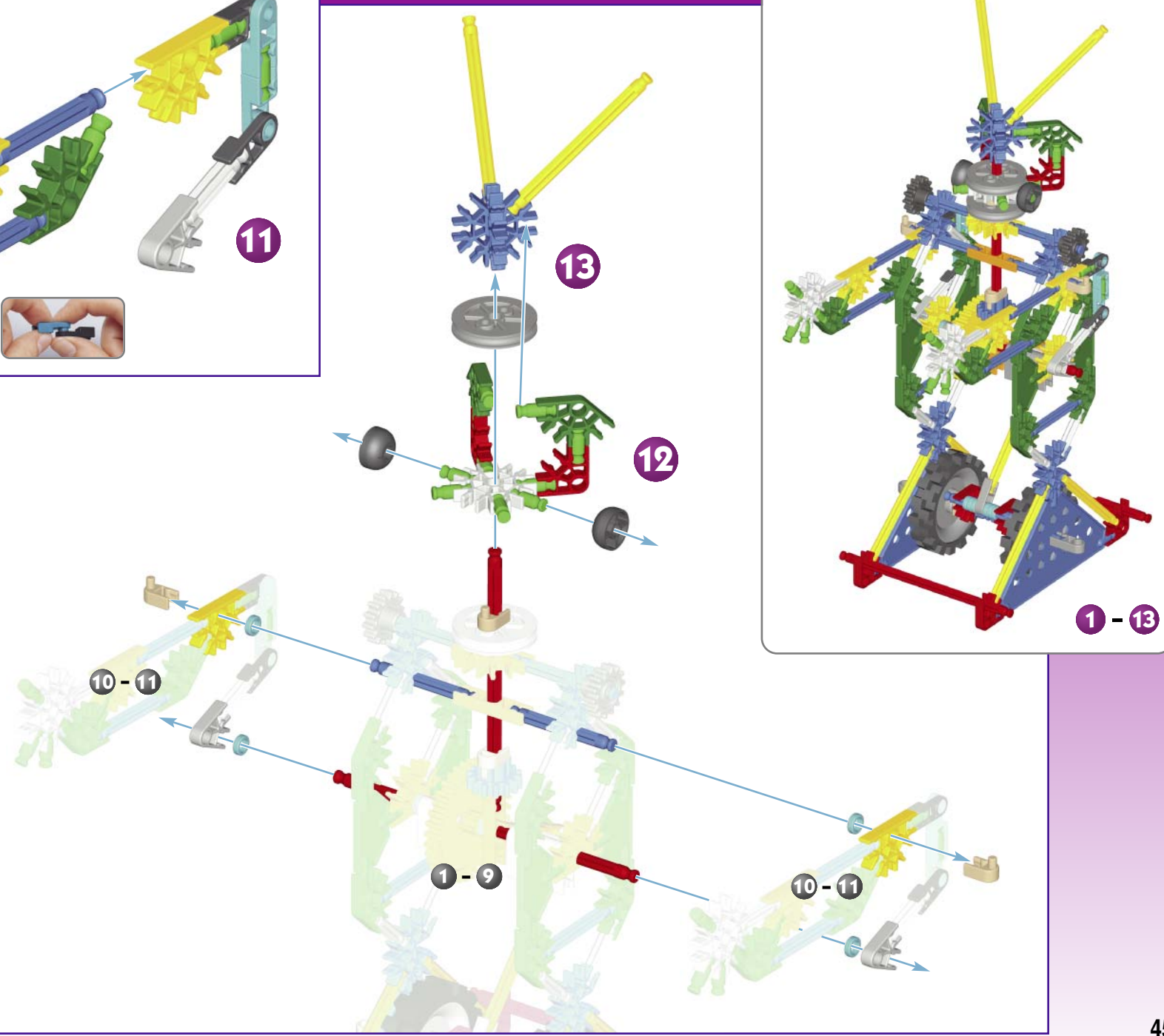
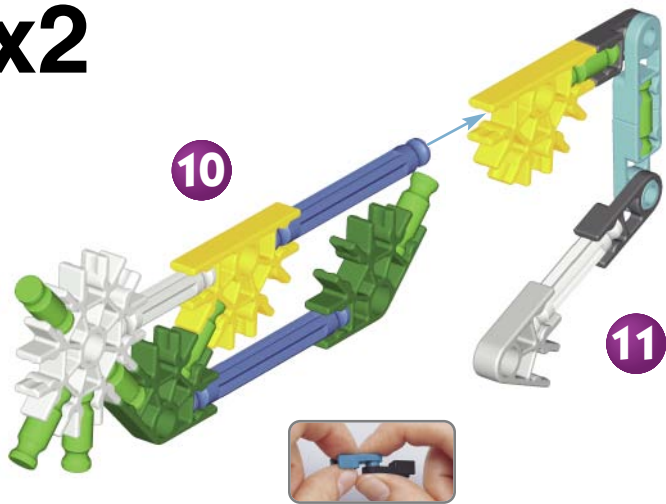

Formula Car

Voiture de Formule

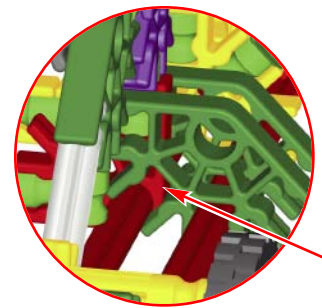
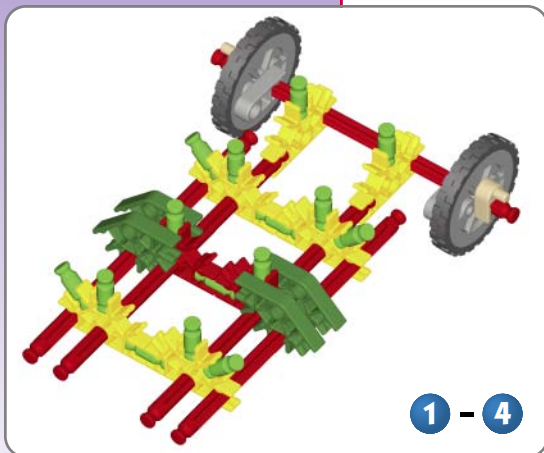
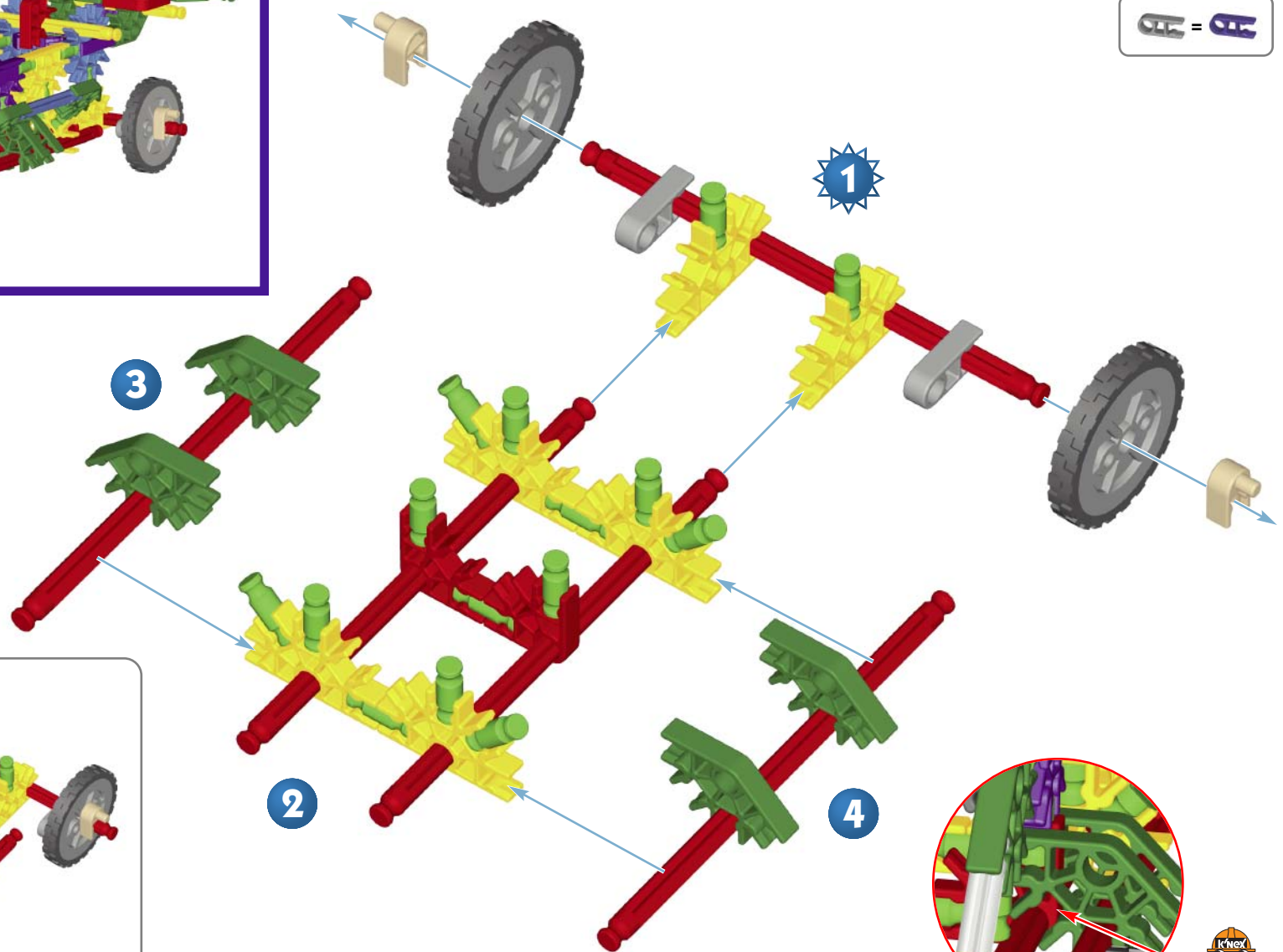

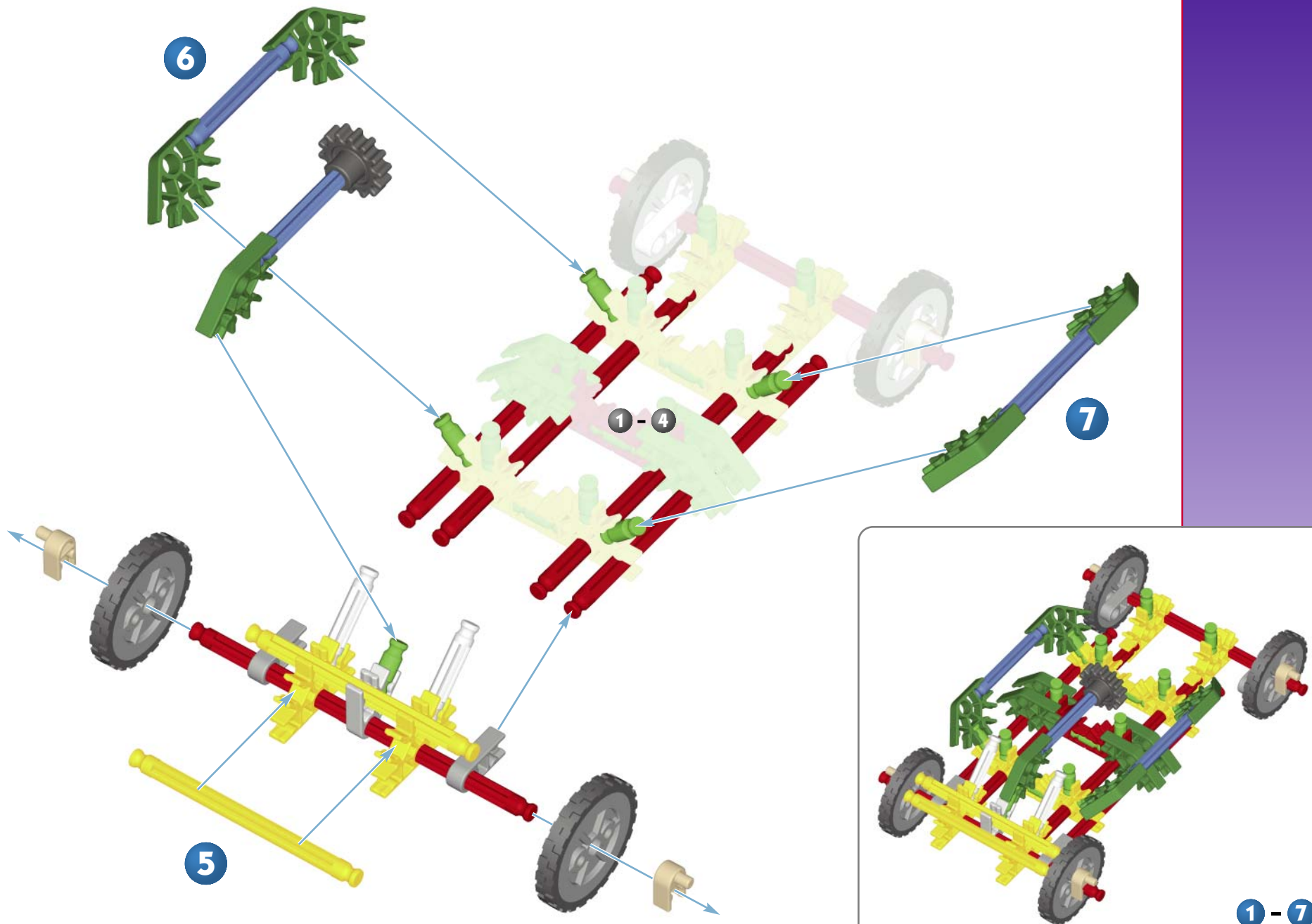

1 - 7

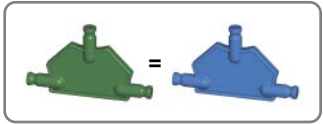
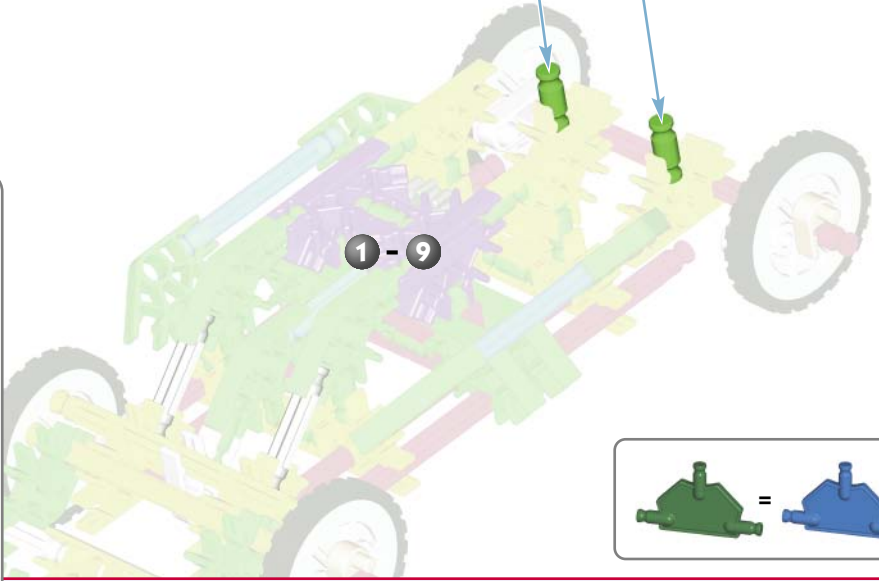
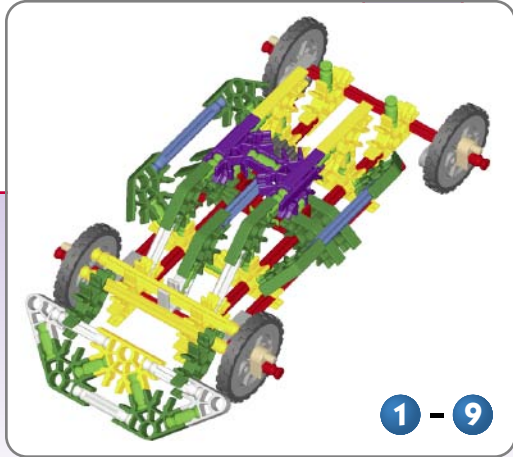
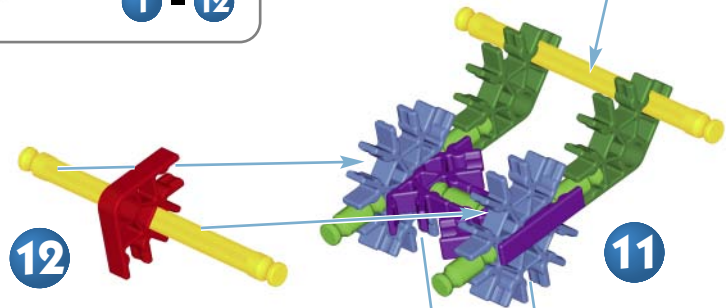
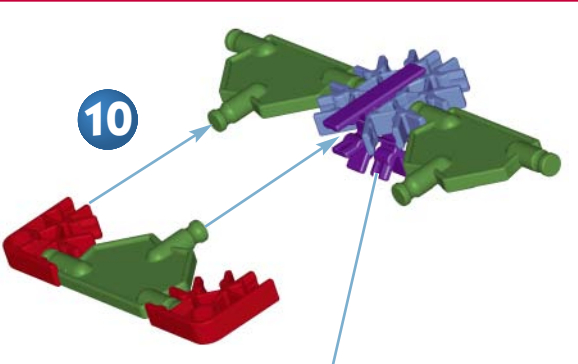
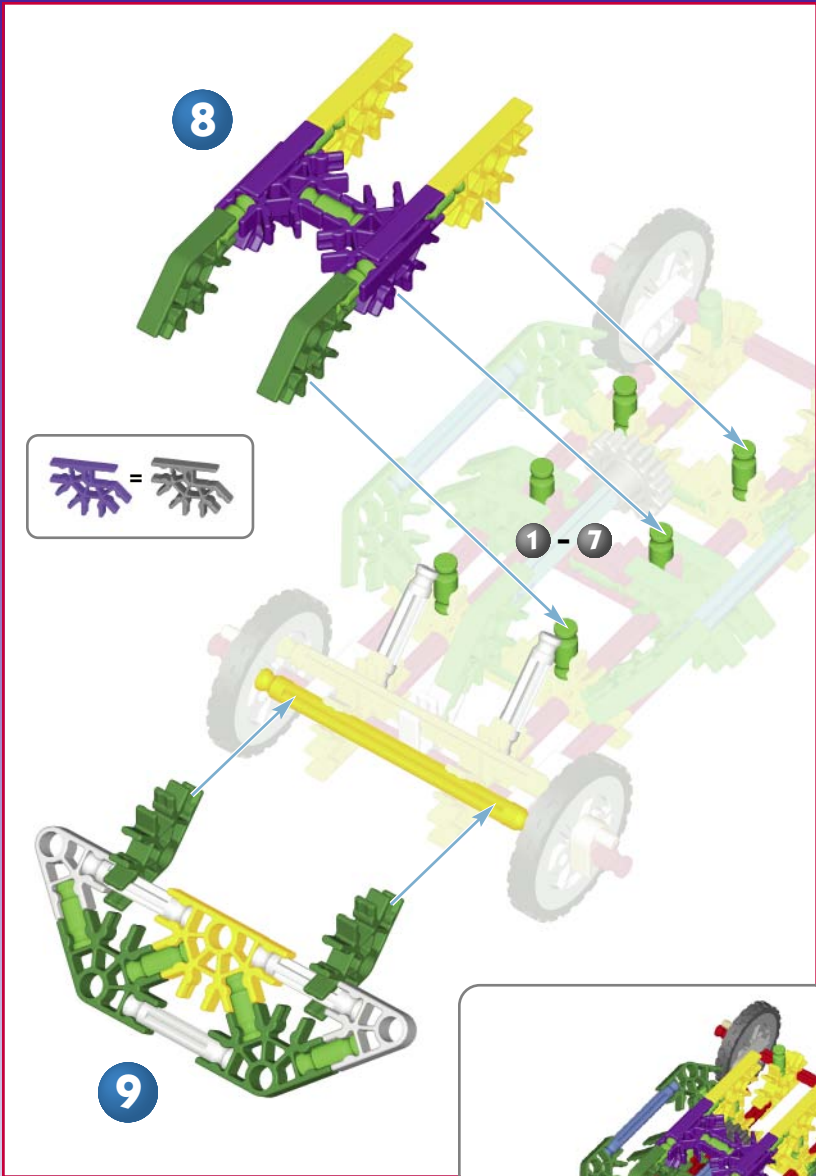

Sport Bike

Bicyclette sportive

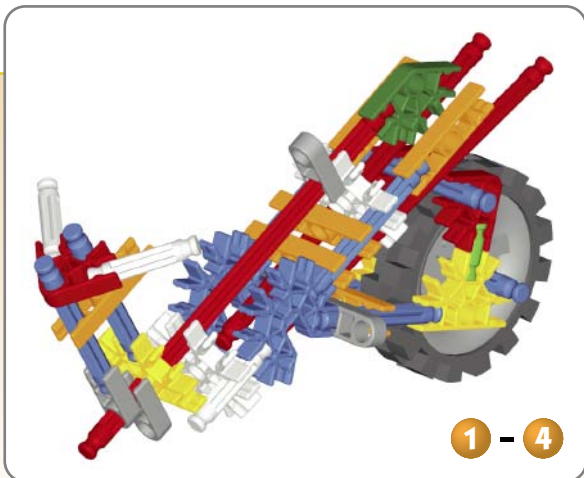
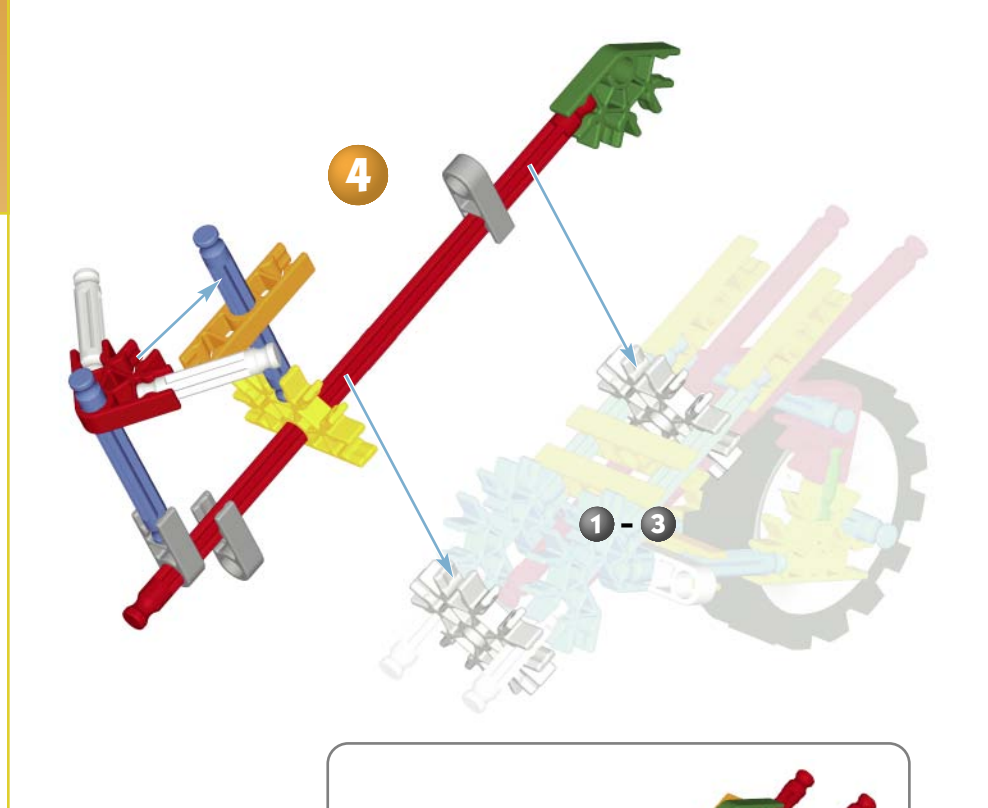
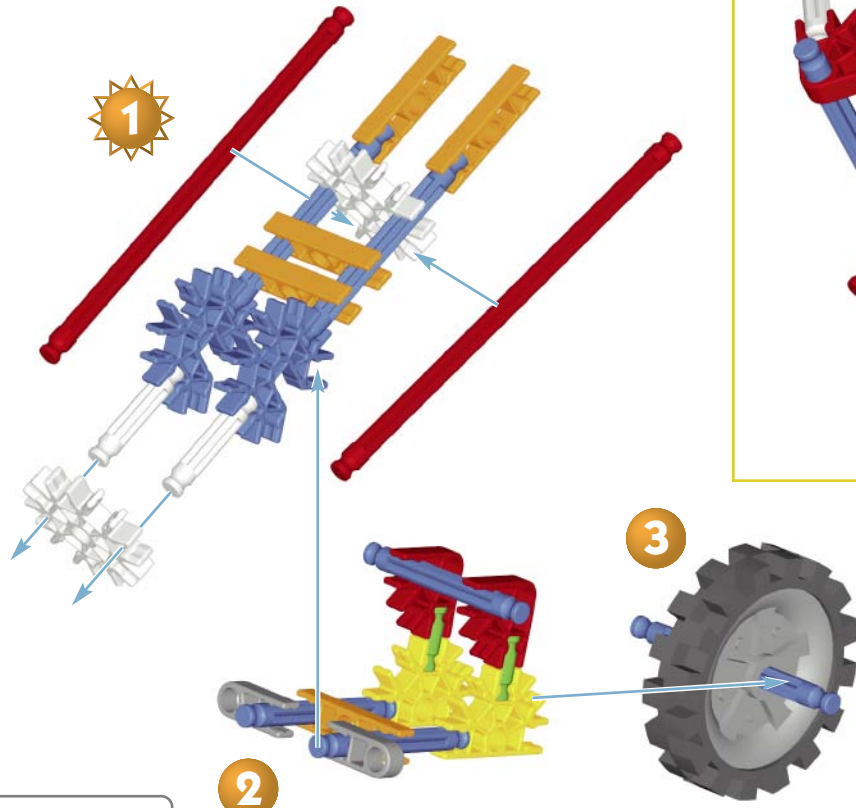

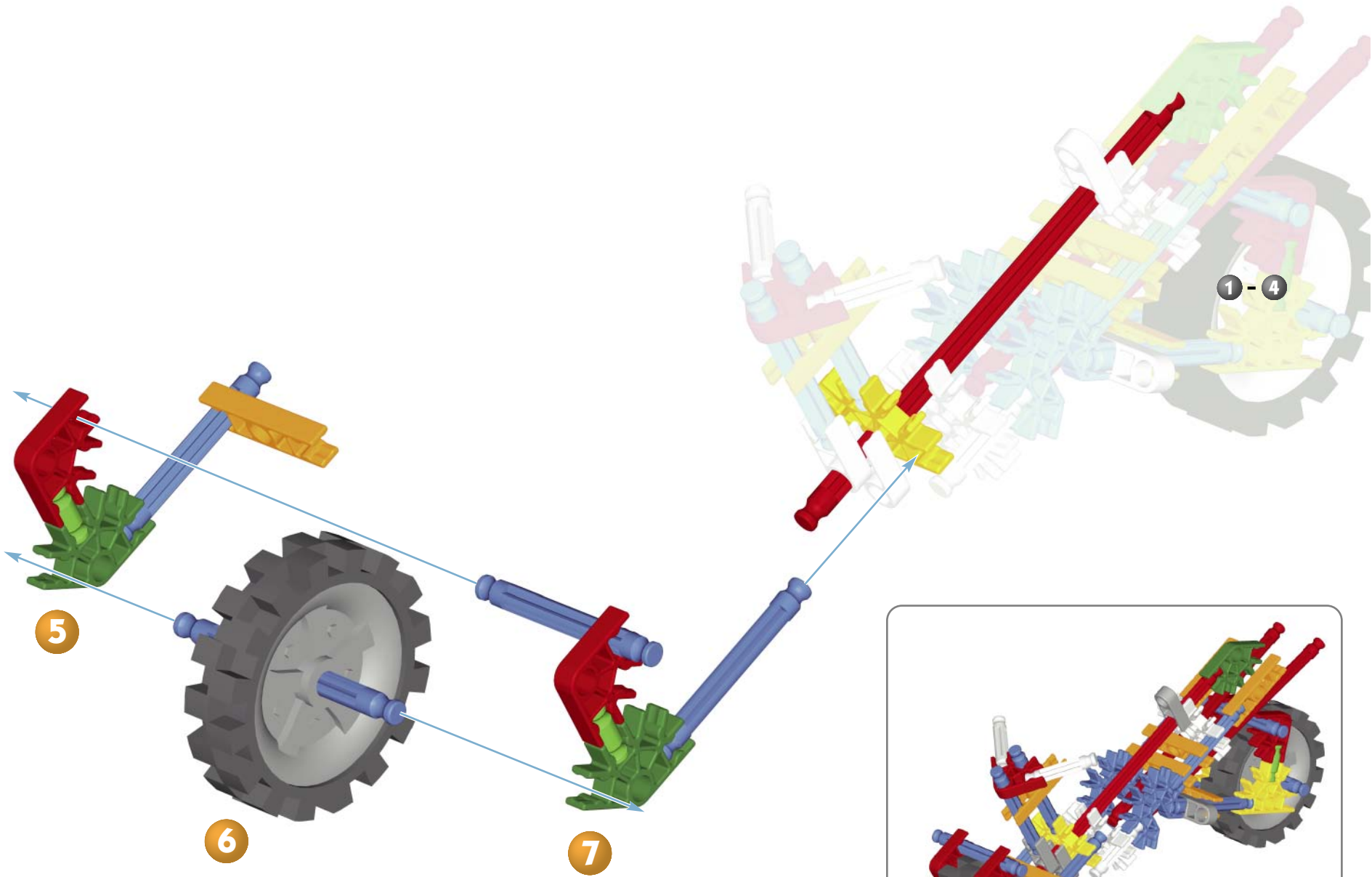

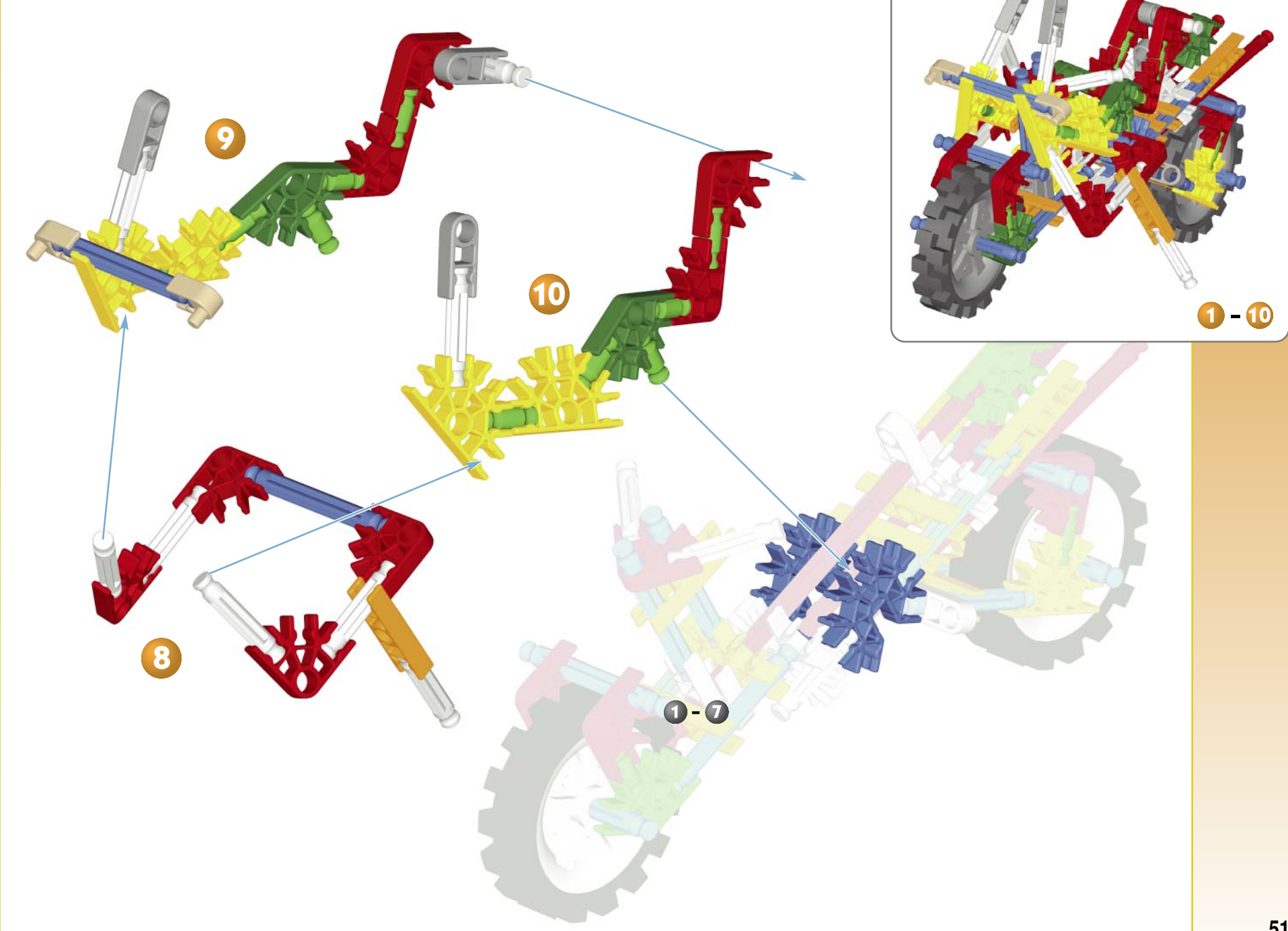

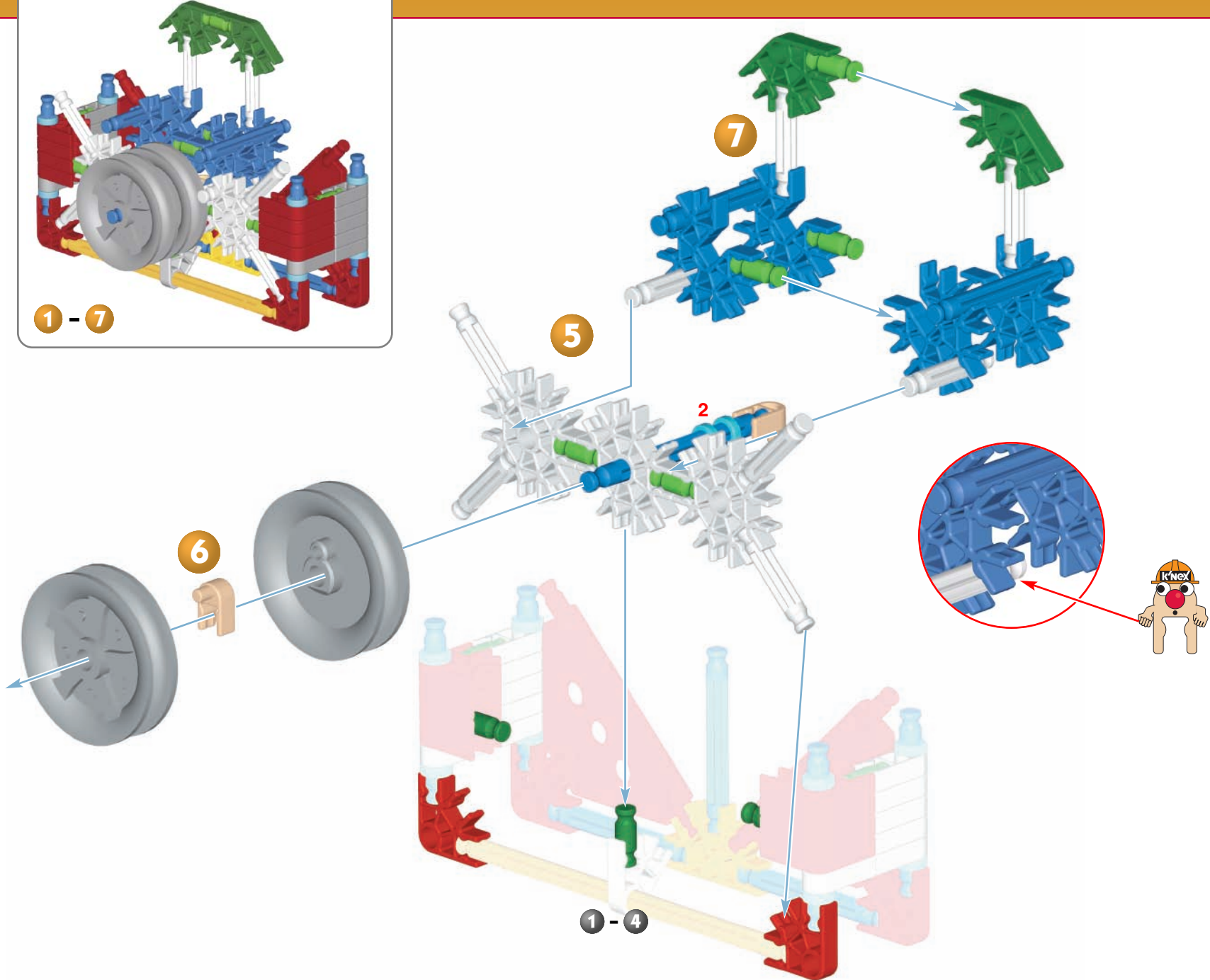
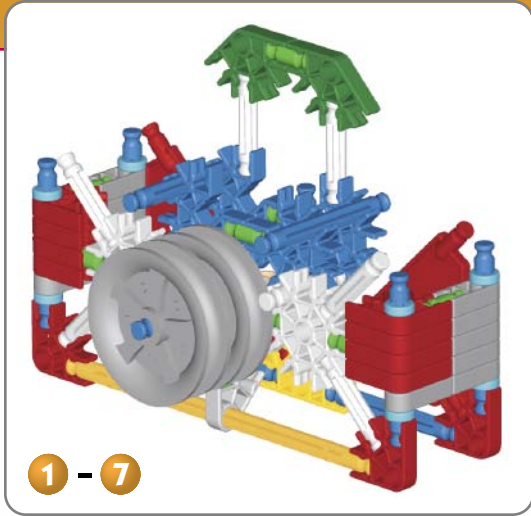

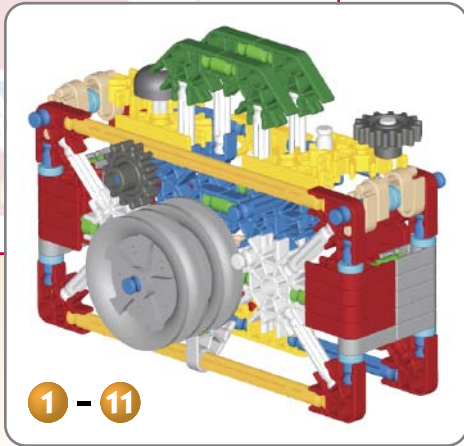
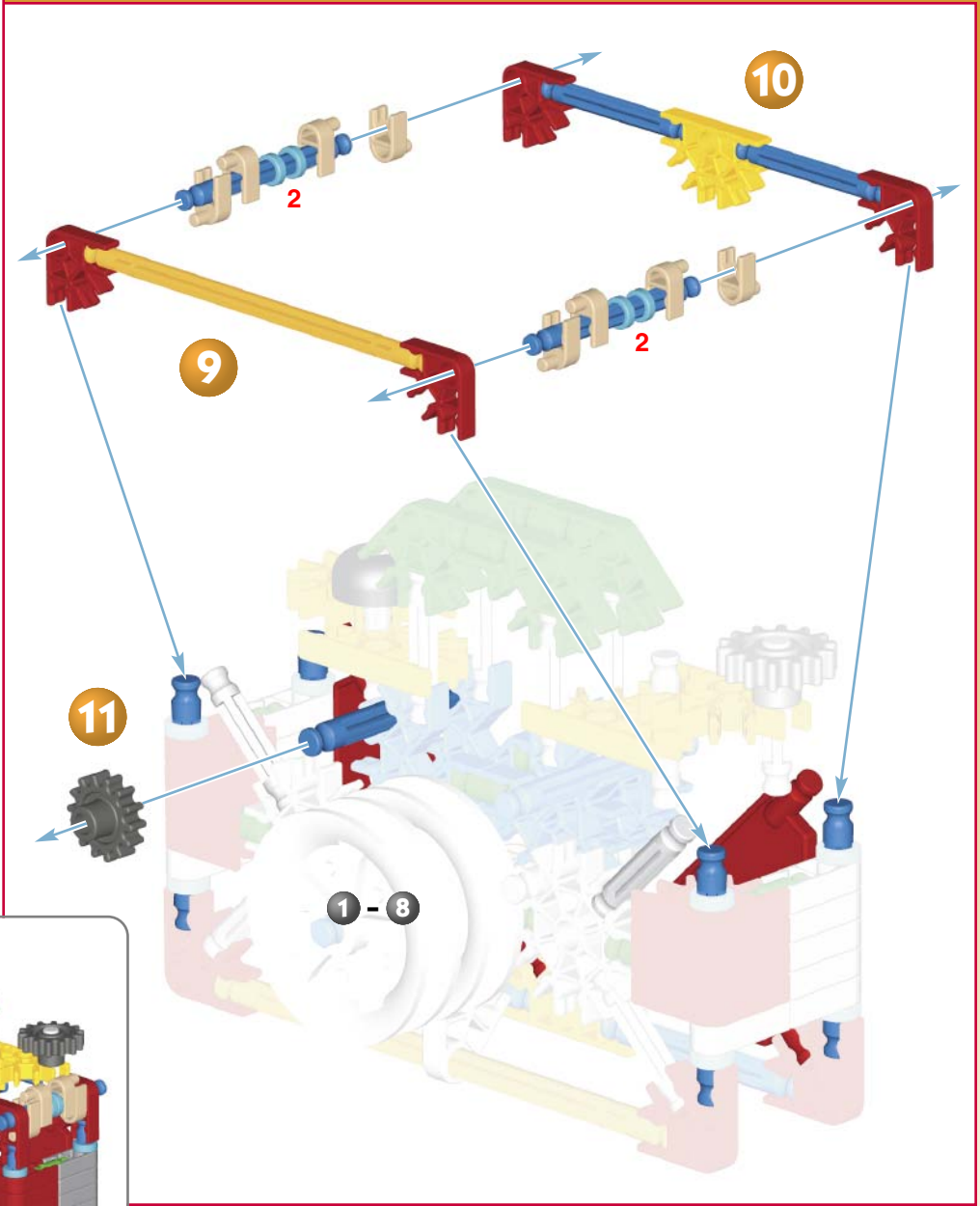
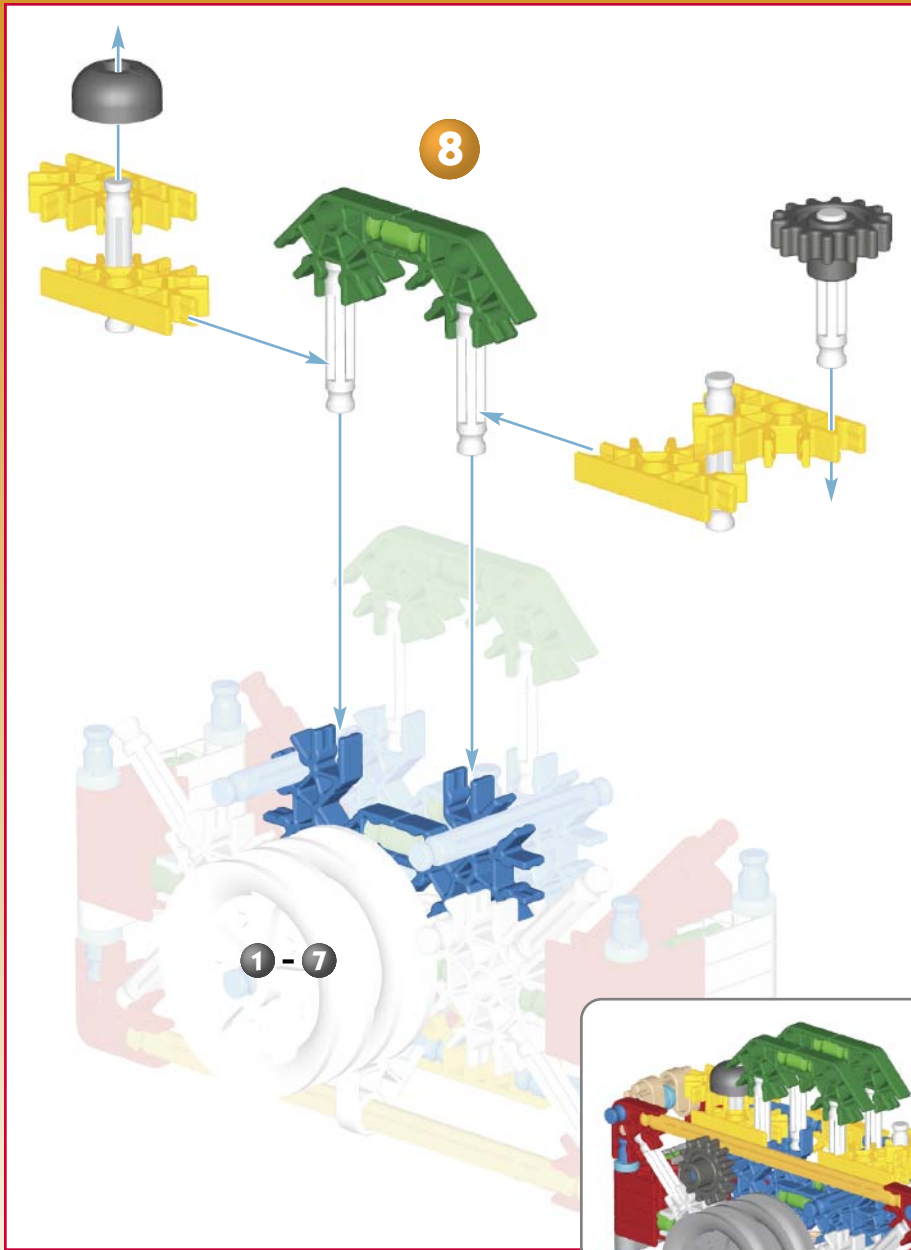

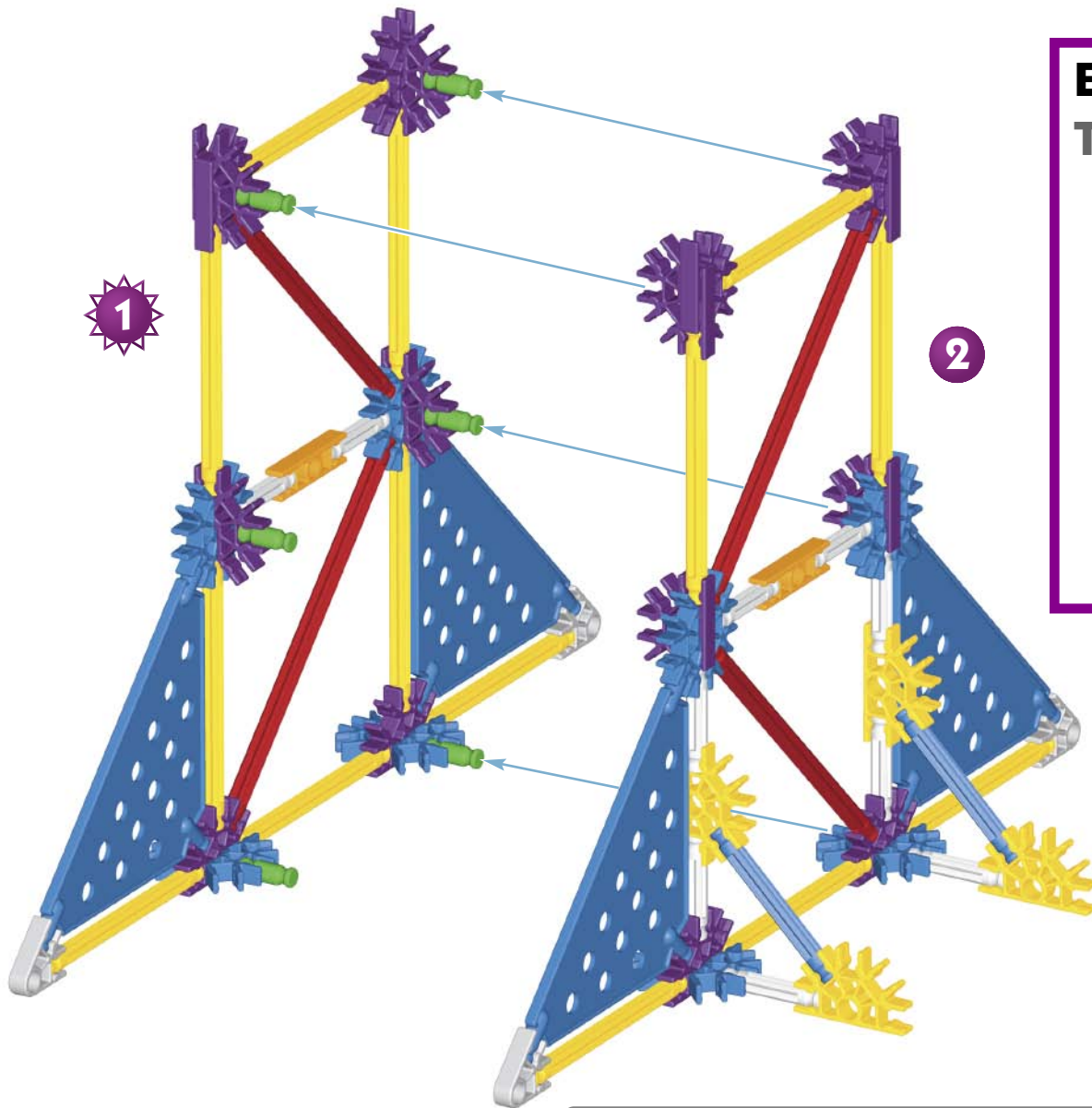

Boom Ride Tour de perche

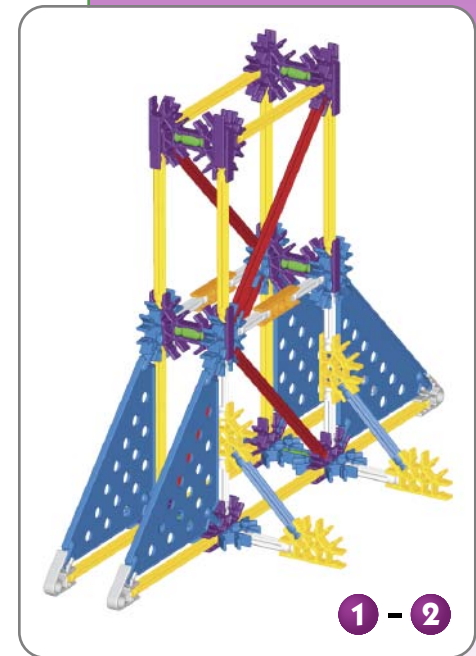
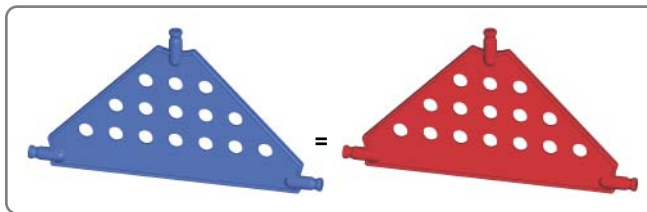
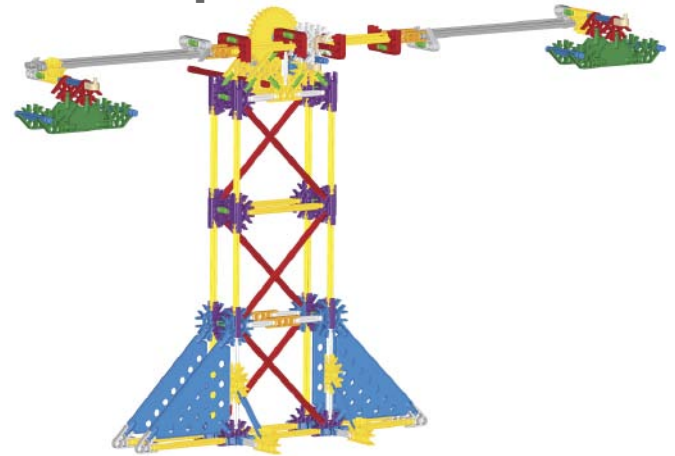

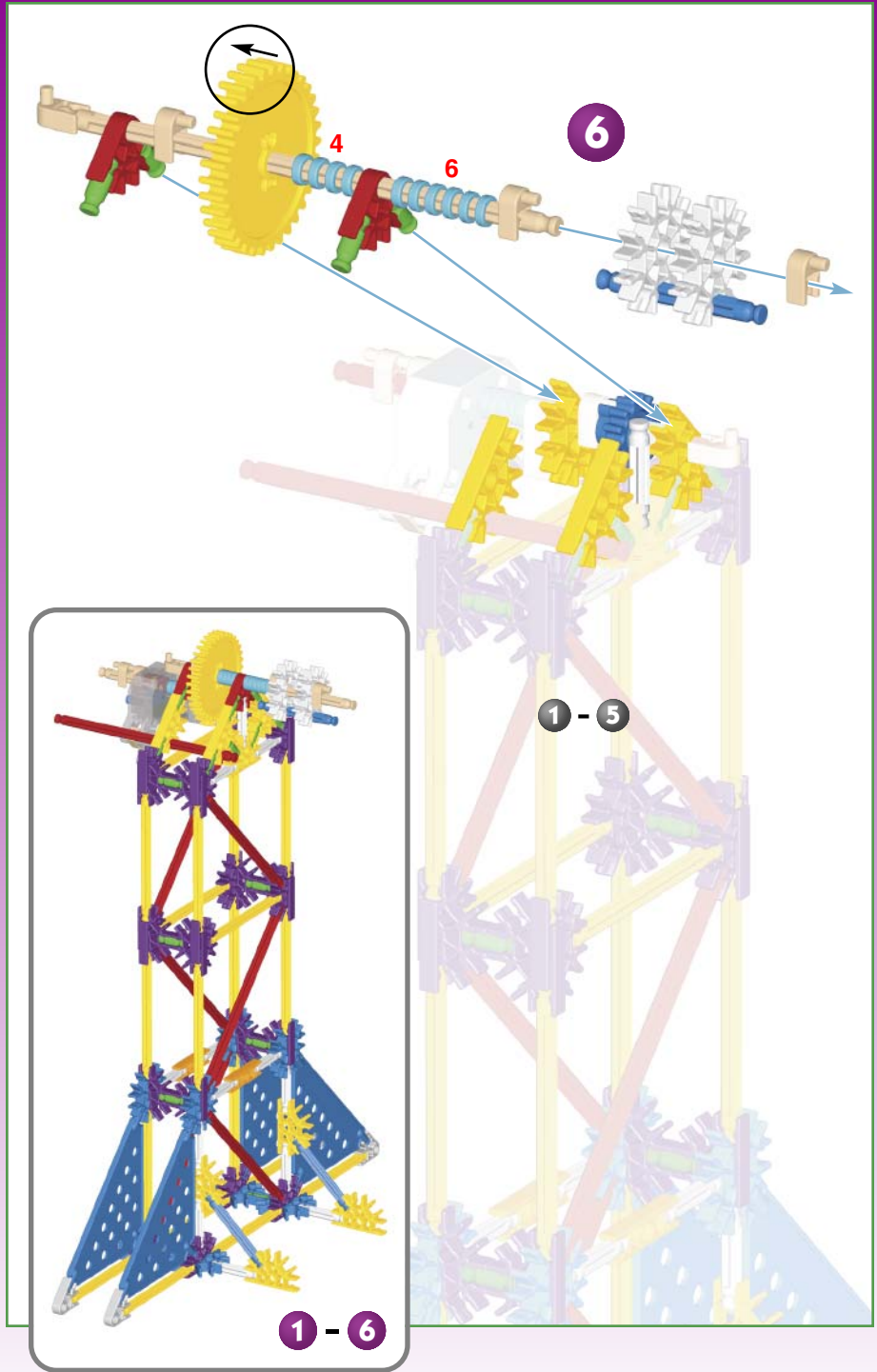
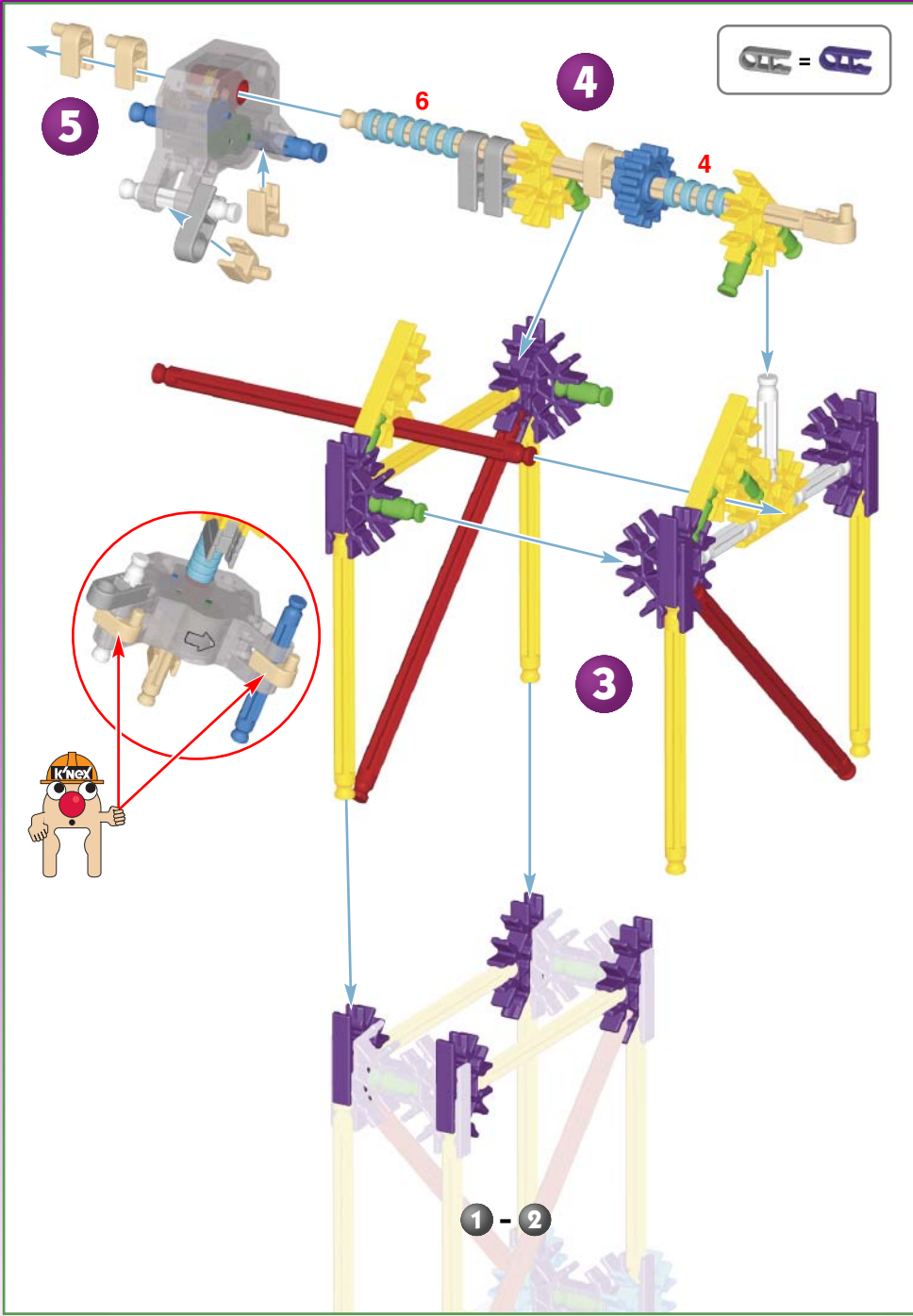

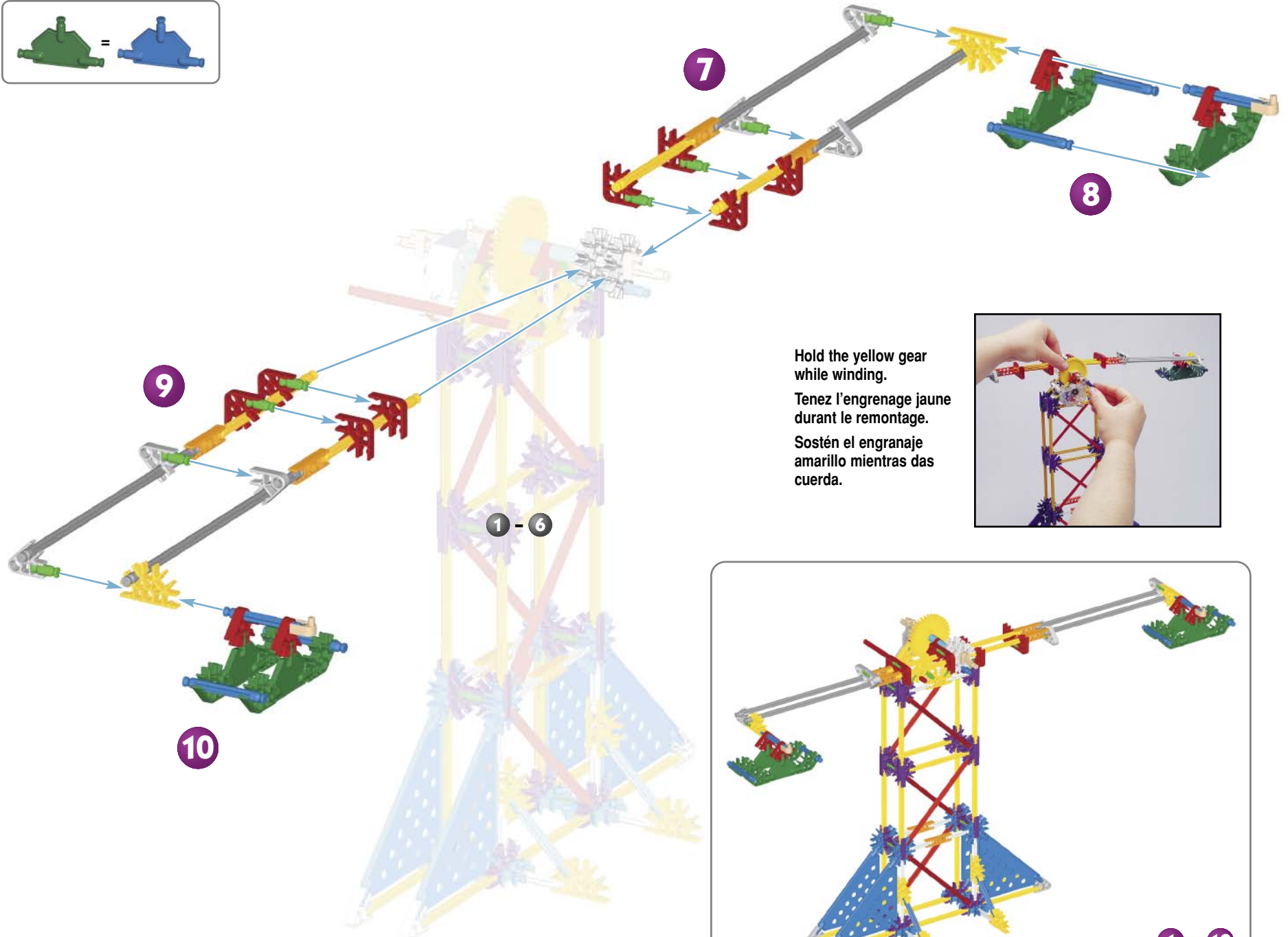
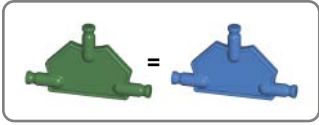

7

8

9

1 - 6

10

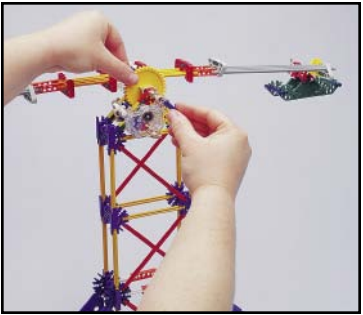

Hold the yellow gear while winding.
 Tenez l'engrenage jaune durant le remontage.
 Sostén el engranaje amarillo mientras das cuerda.

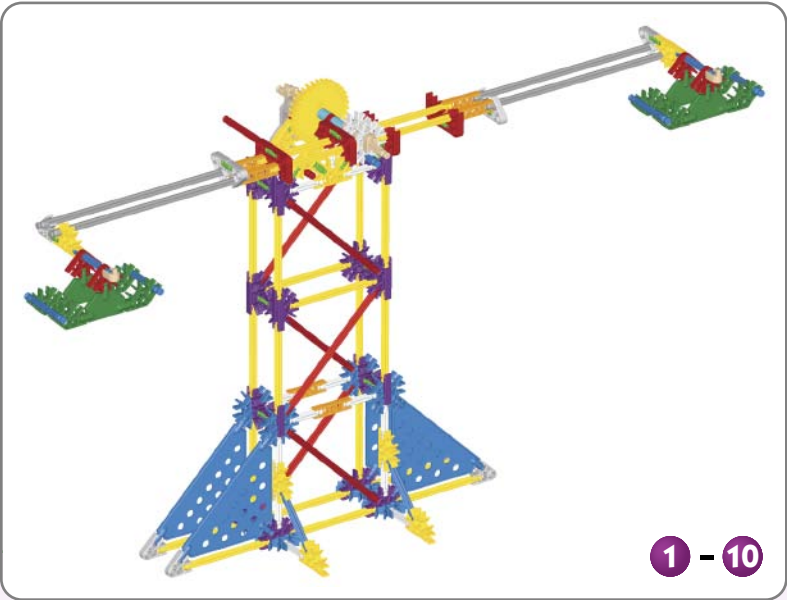

1 - 10

Octopus Ride

Tour de poulpe

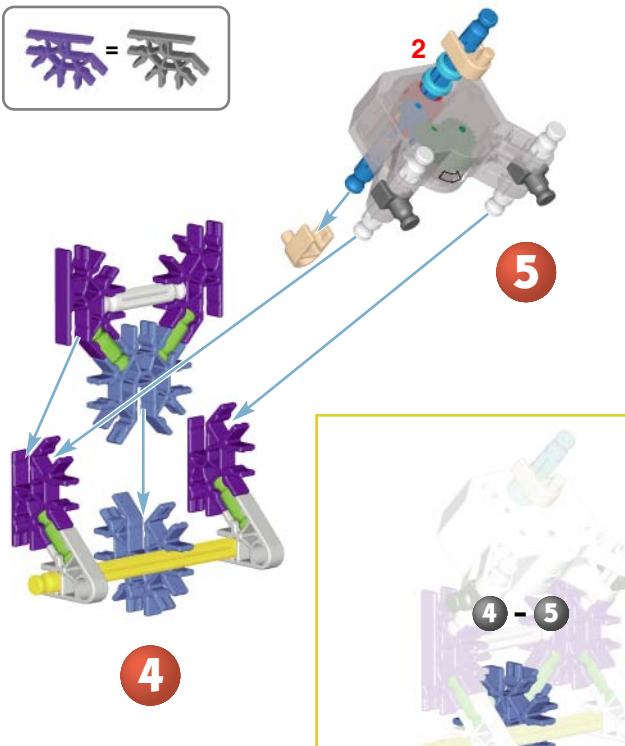
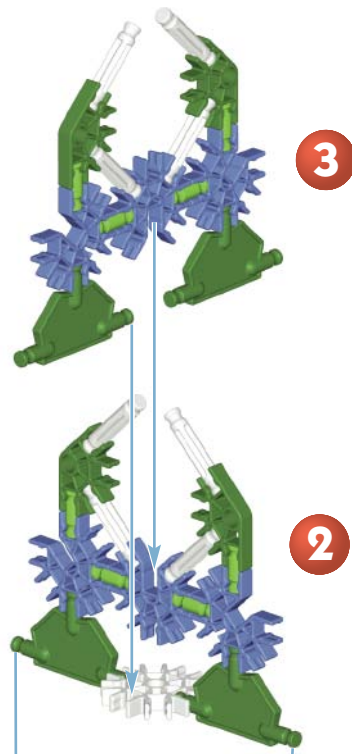
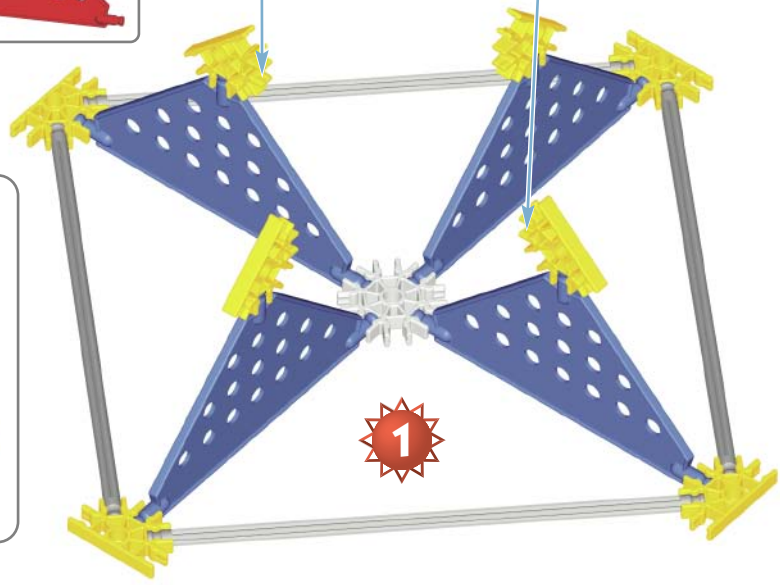
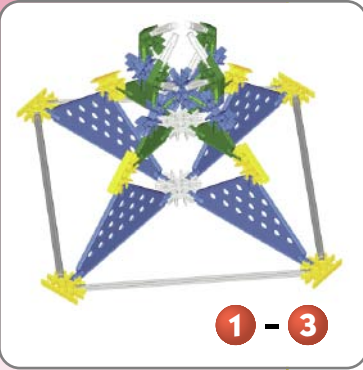
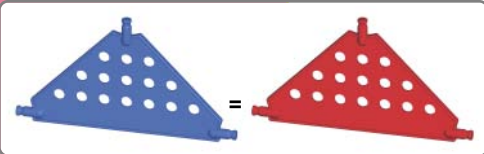
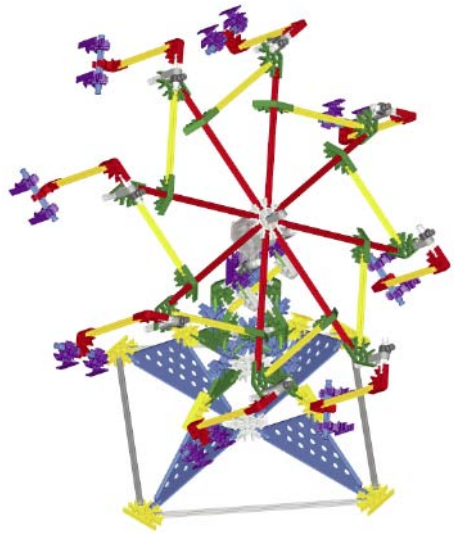

x8

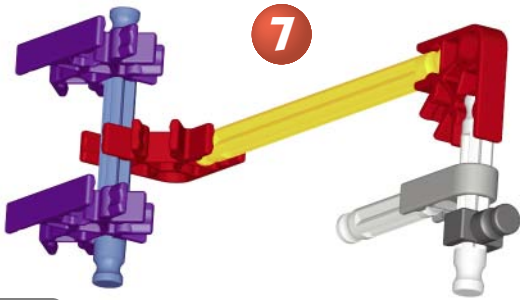

A = A

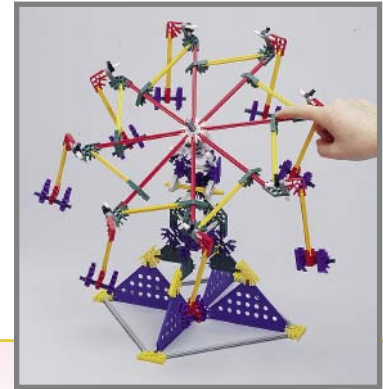
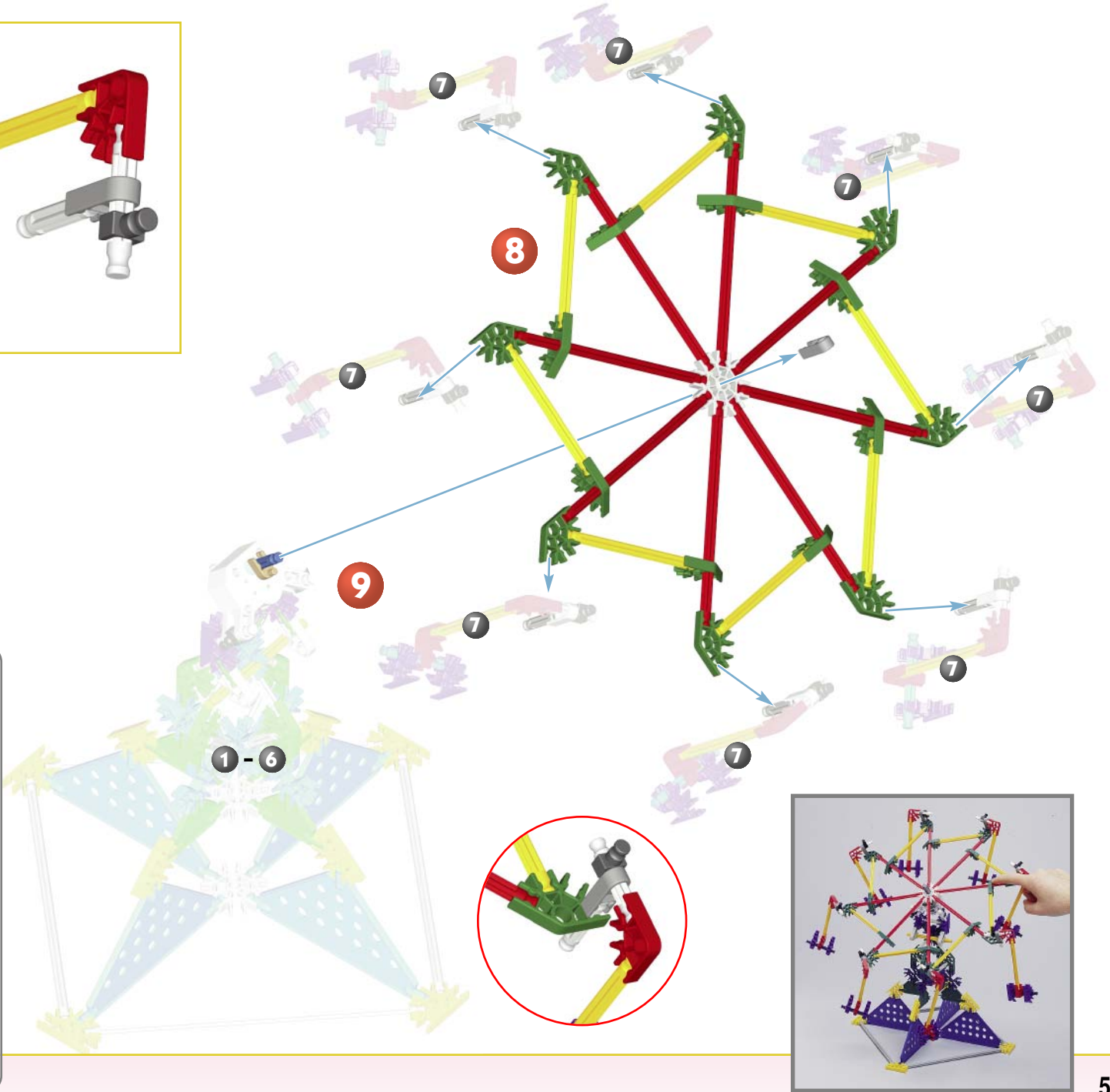
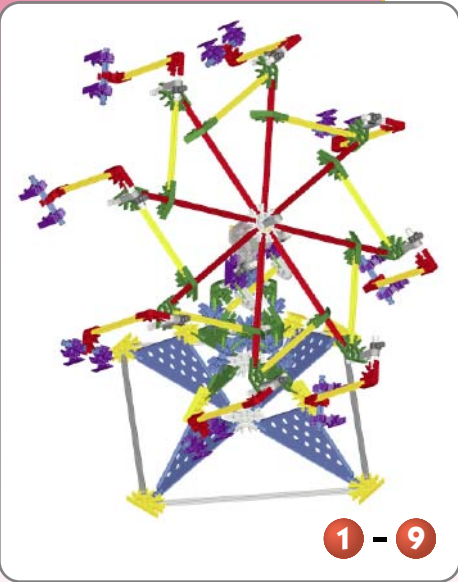

Boat Ride

Tour de bateau

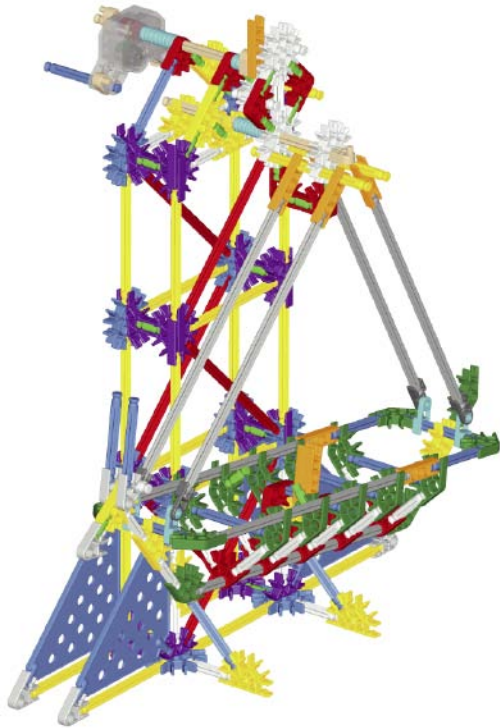

1

2

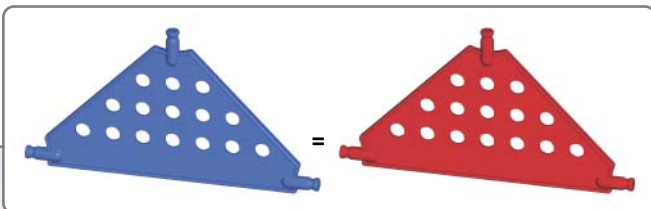
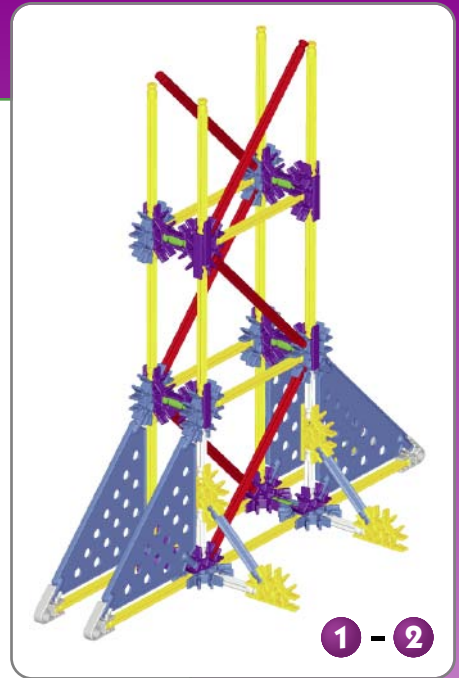

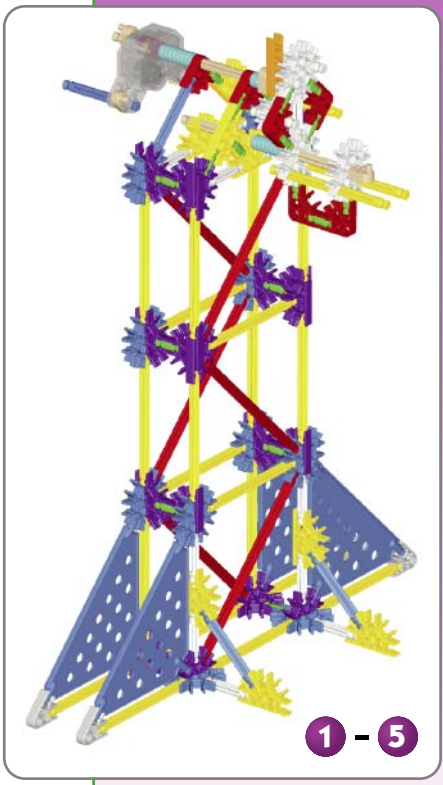
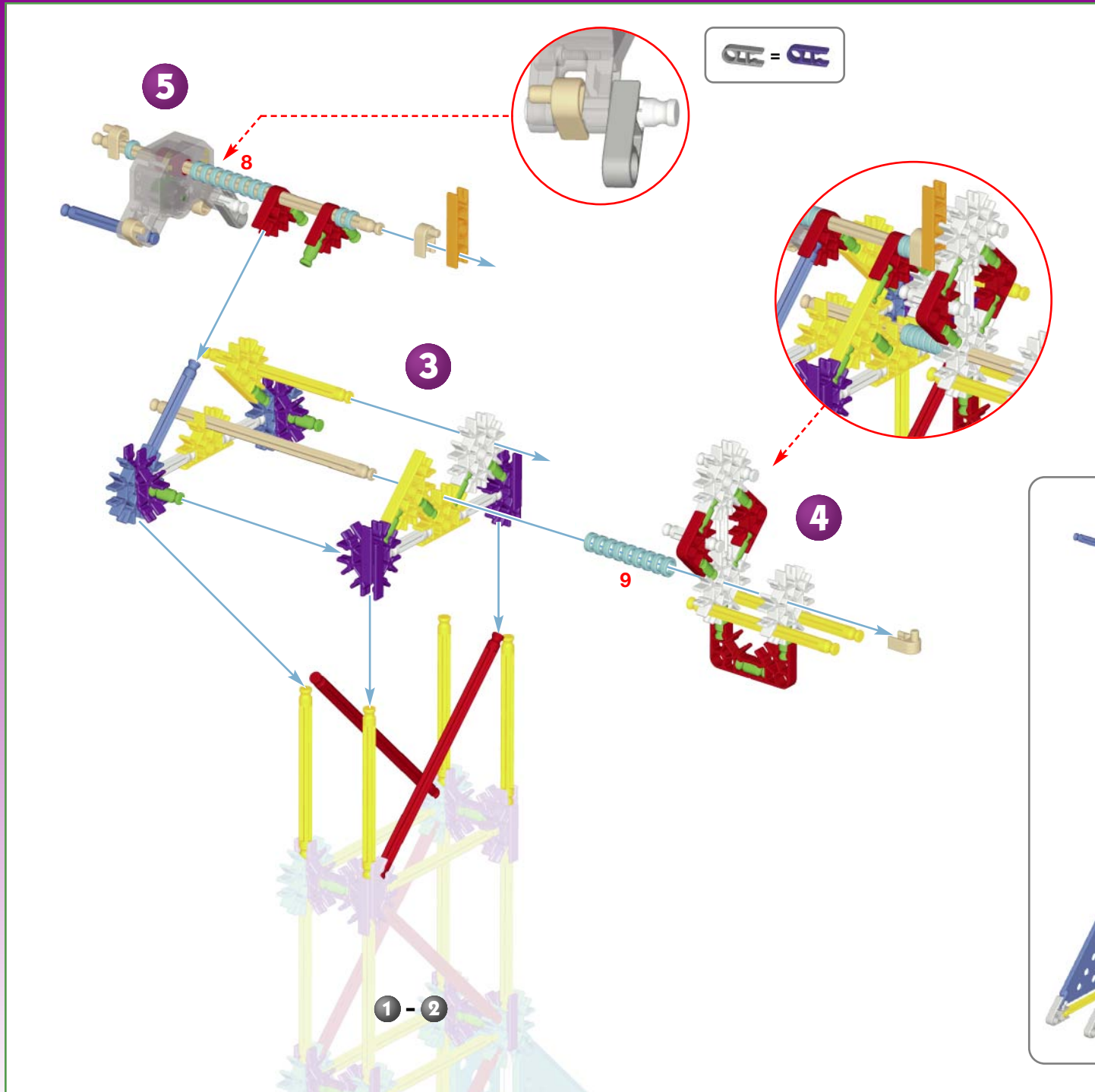

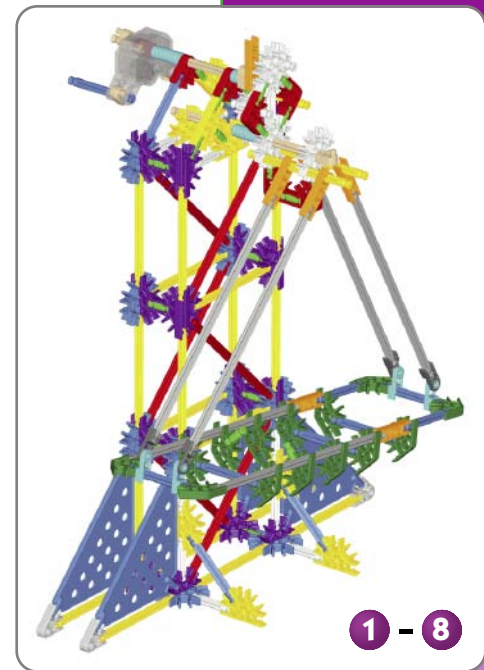
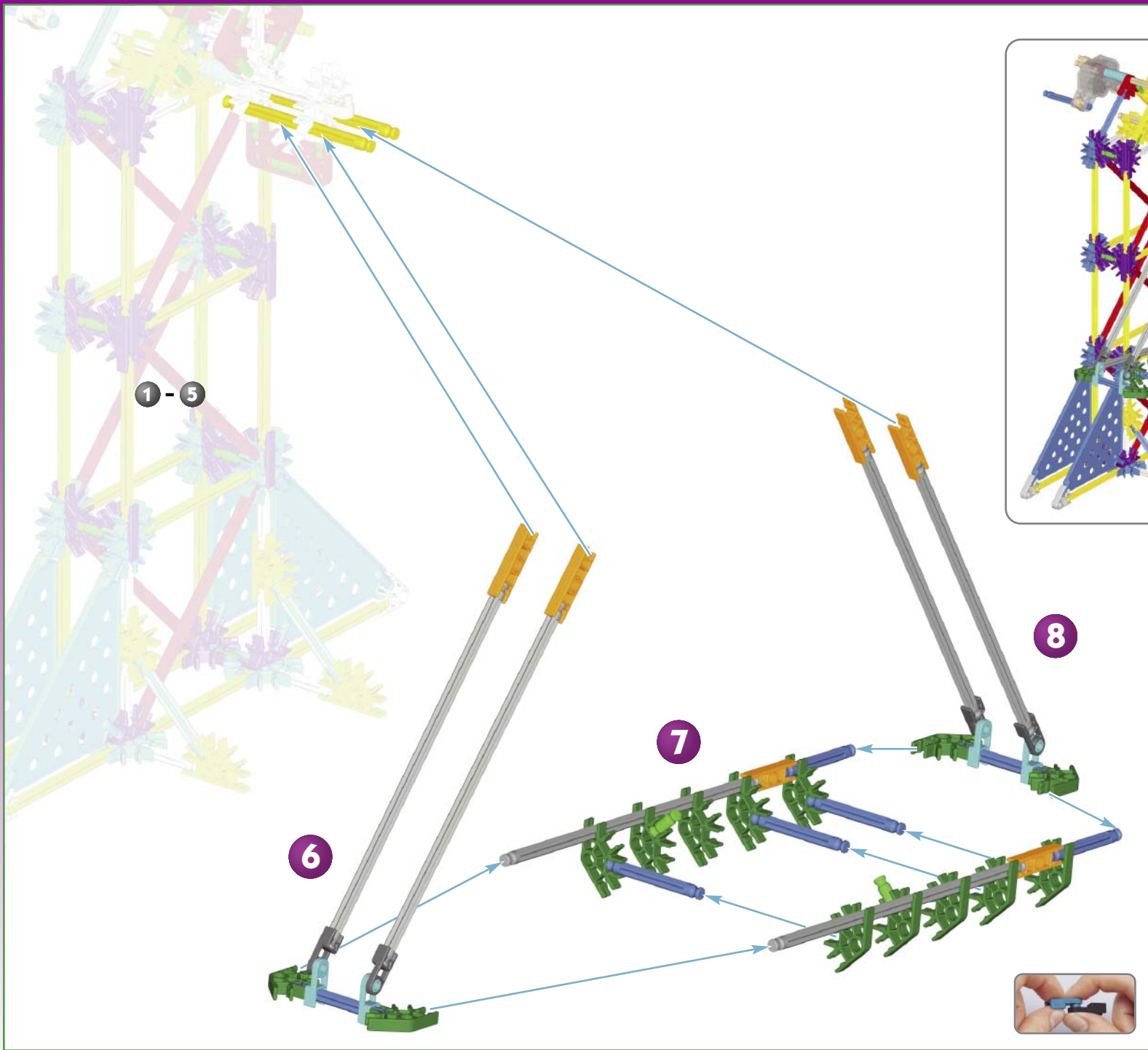

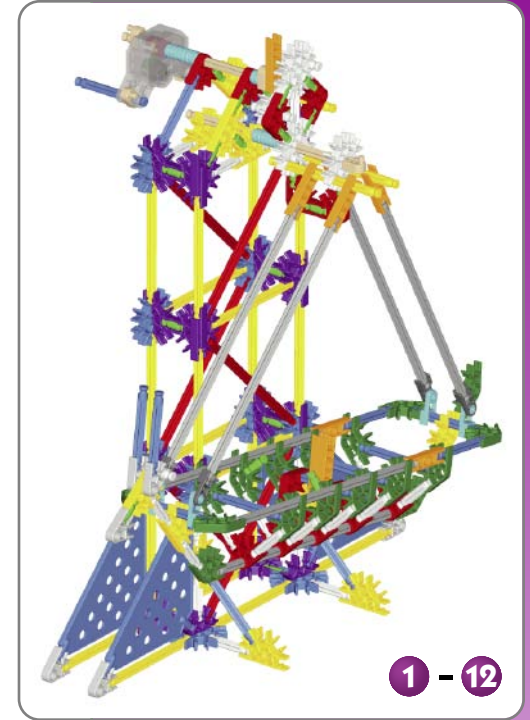
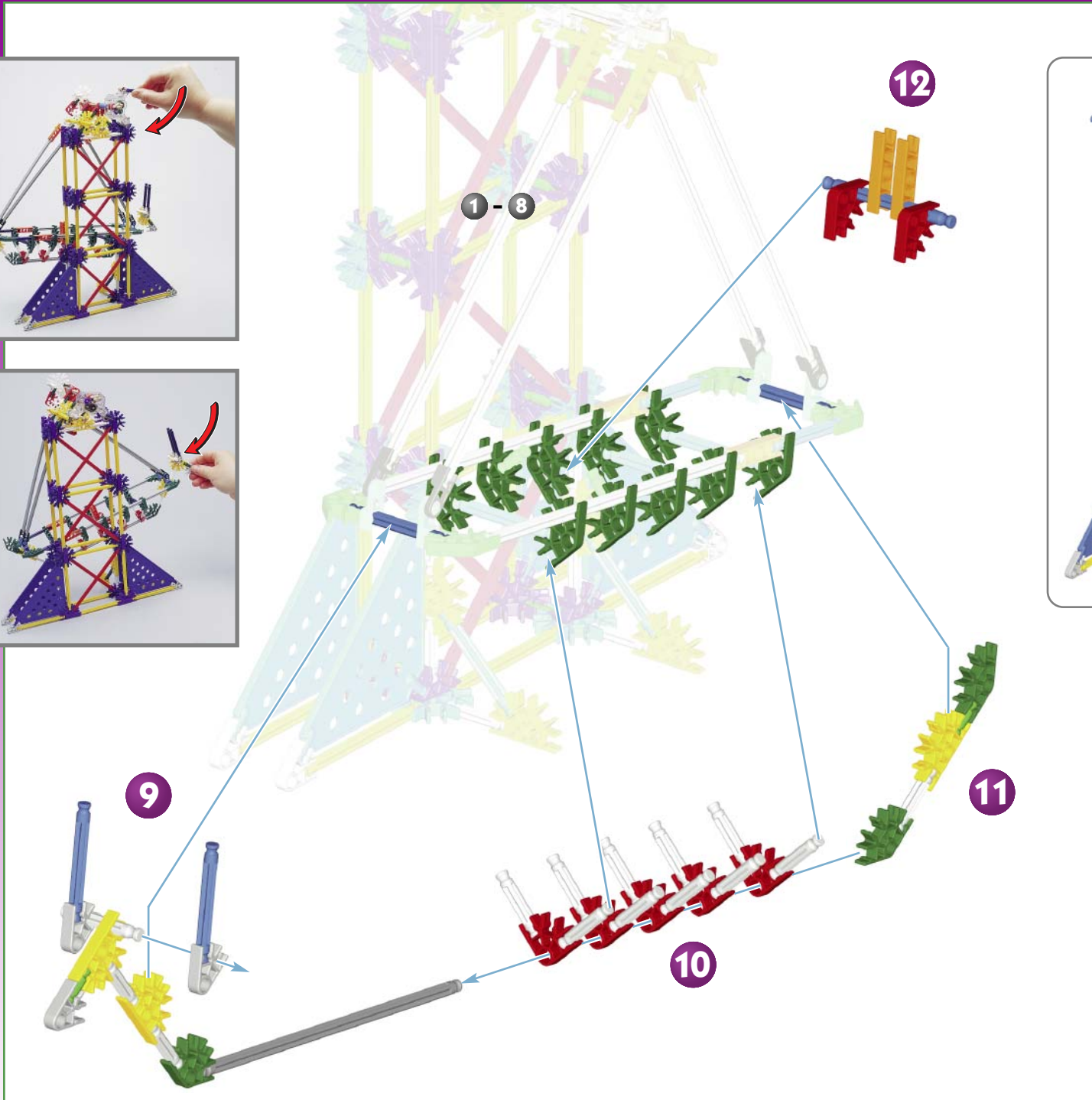

Hippo

Hippopotame

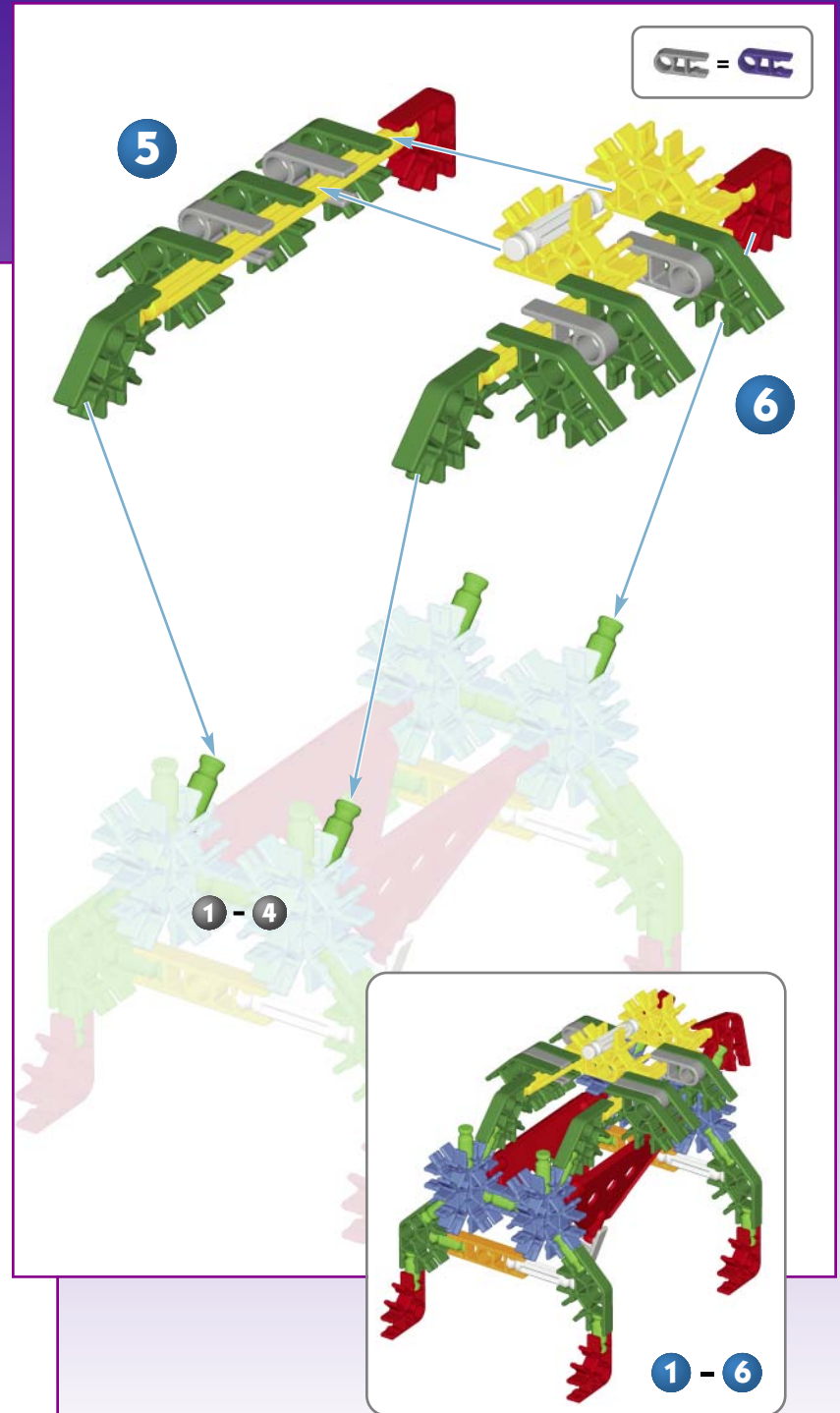
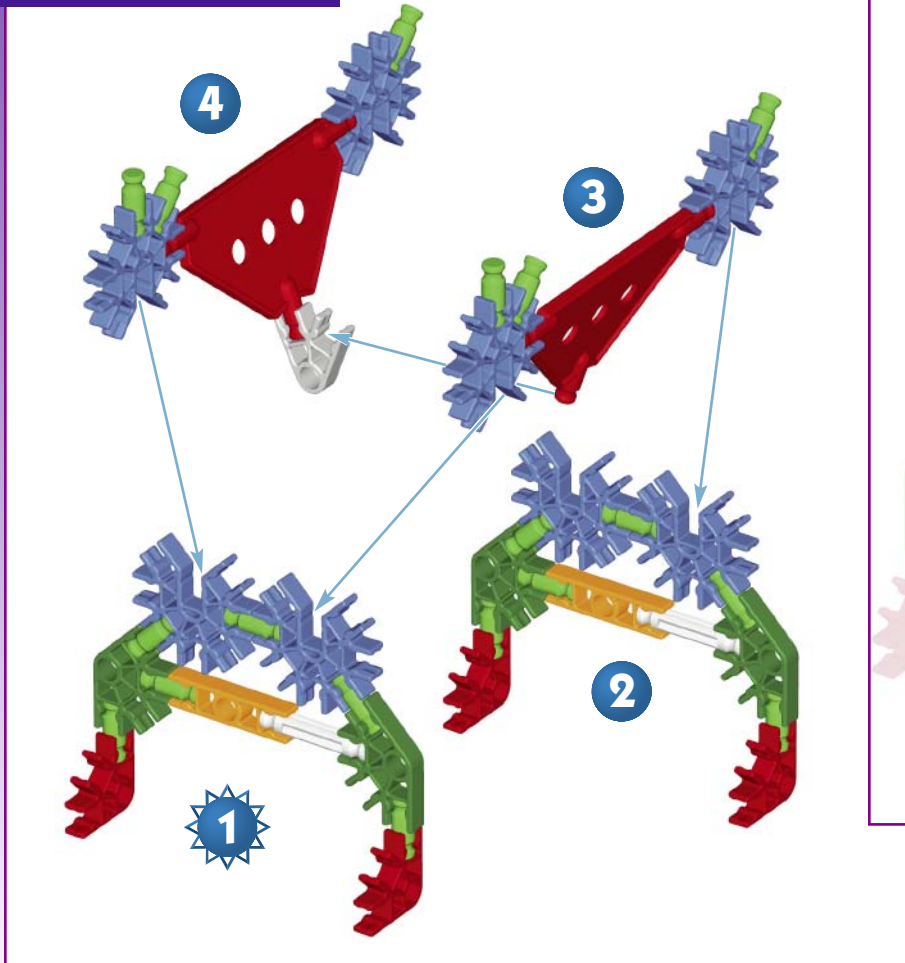
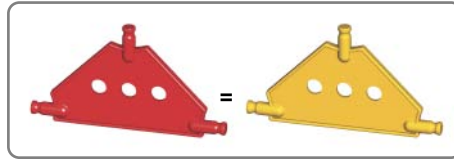
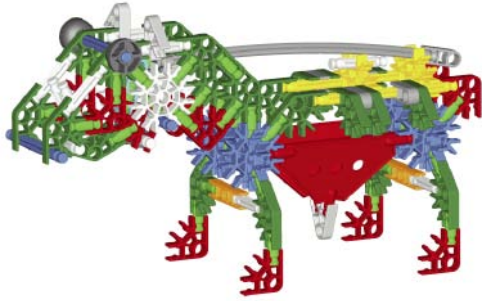



7

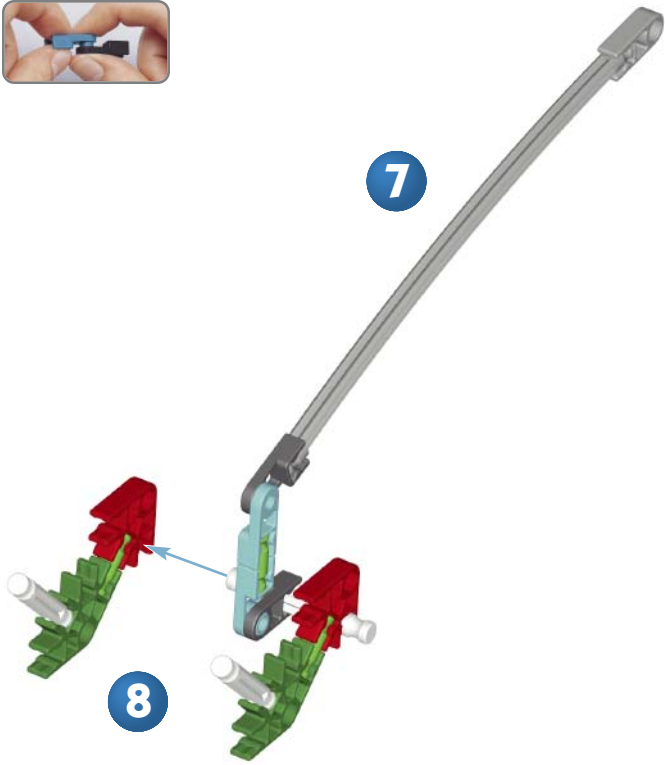

8

10

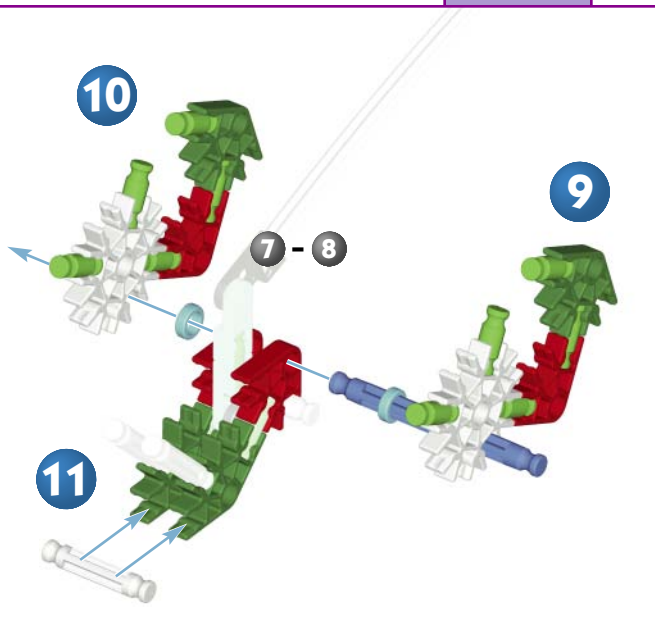

9

11

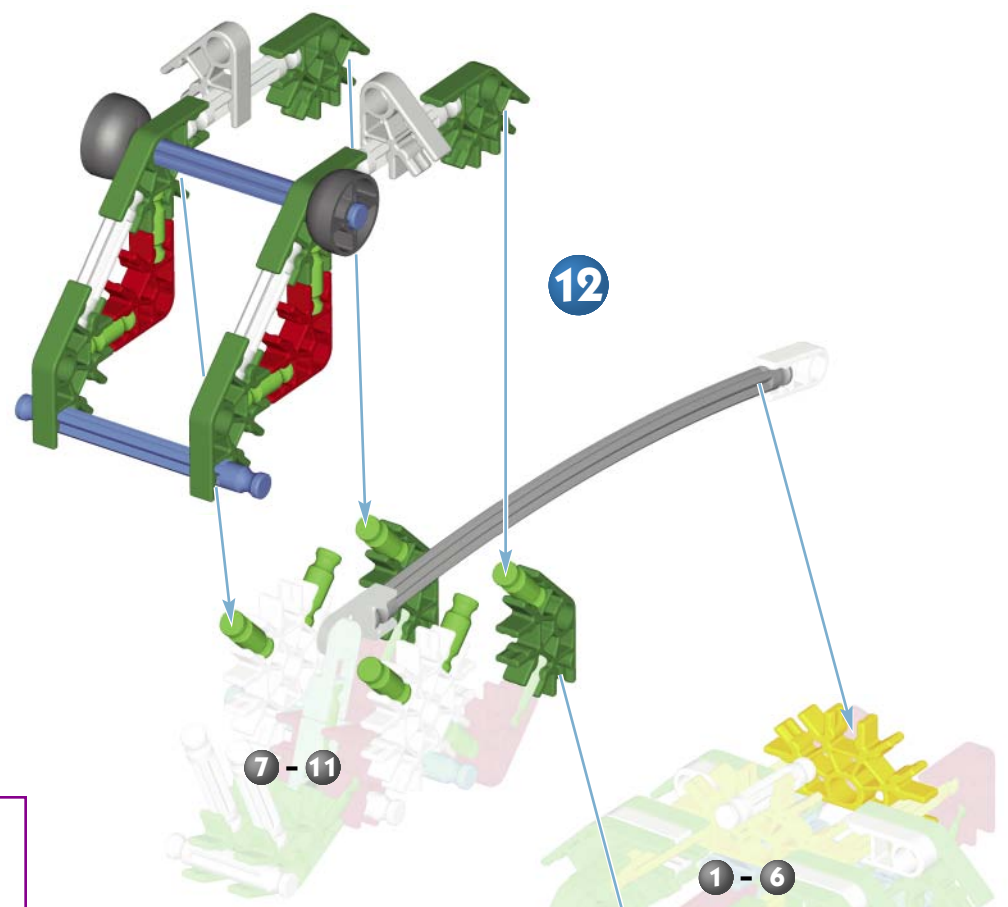

12

7 - 11

1 - 6

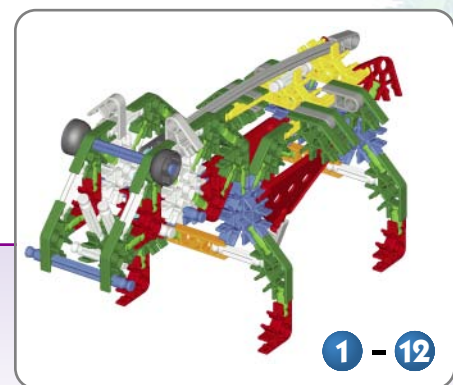

1 - 12

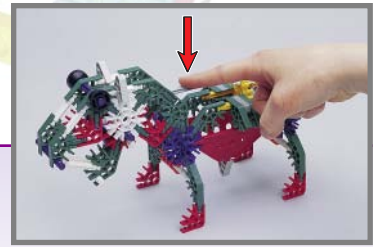

Elephant Éléphant

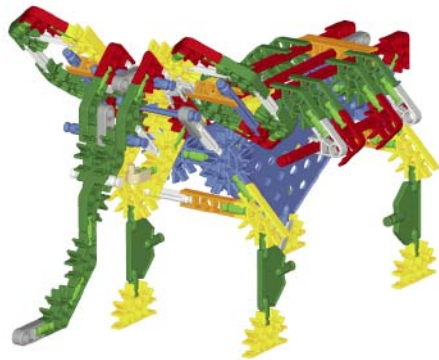

CF = CR

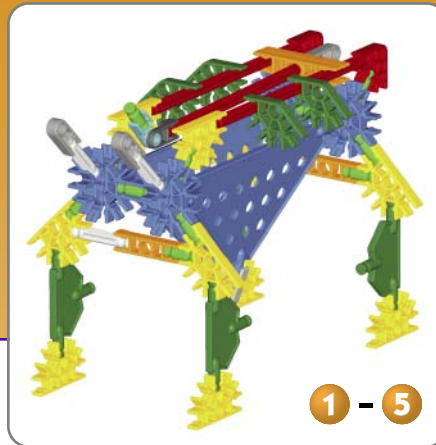
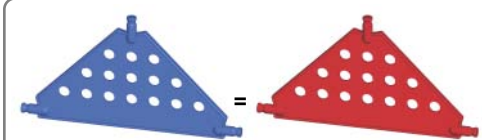

1

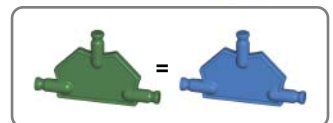
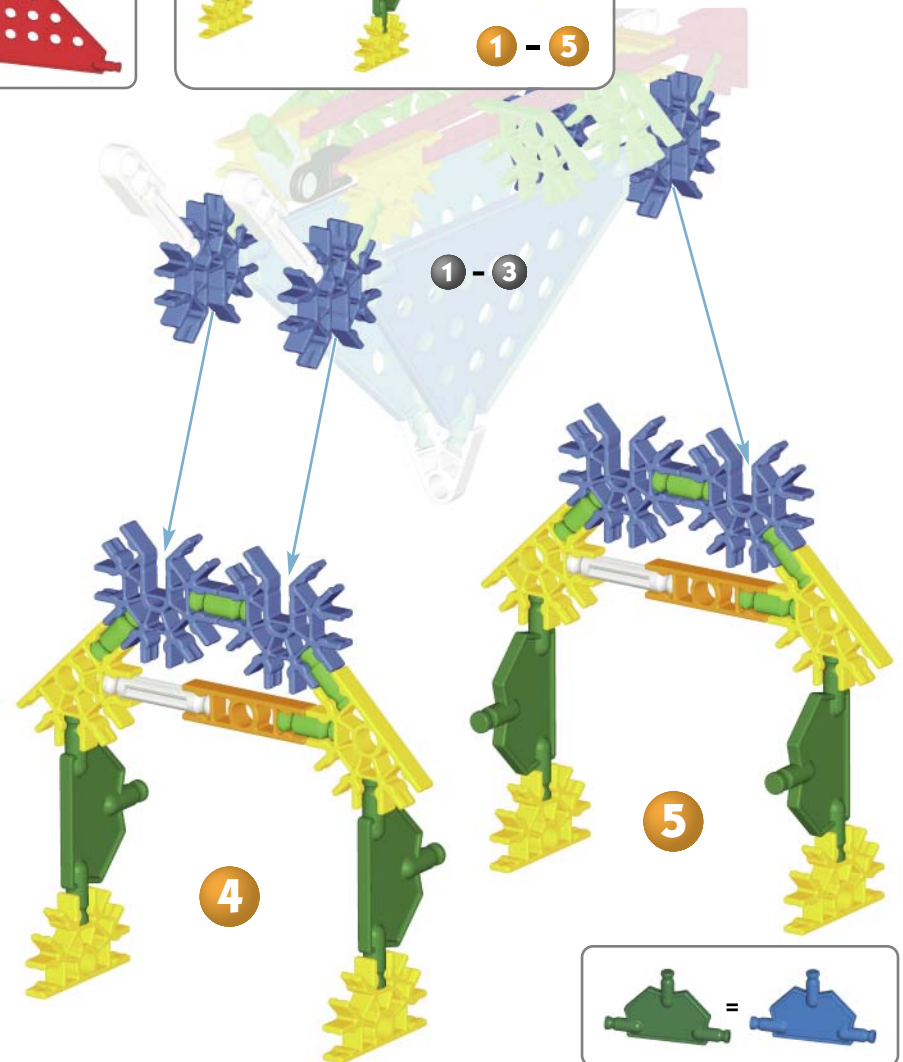
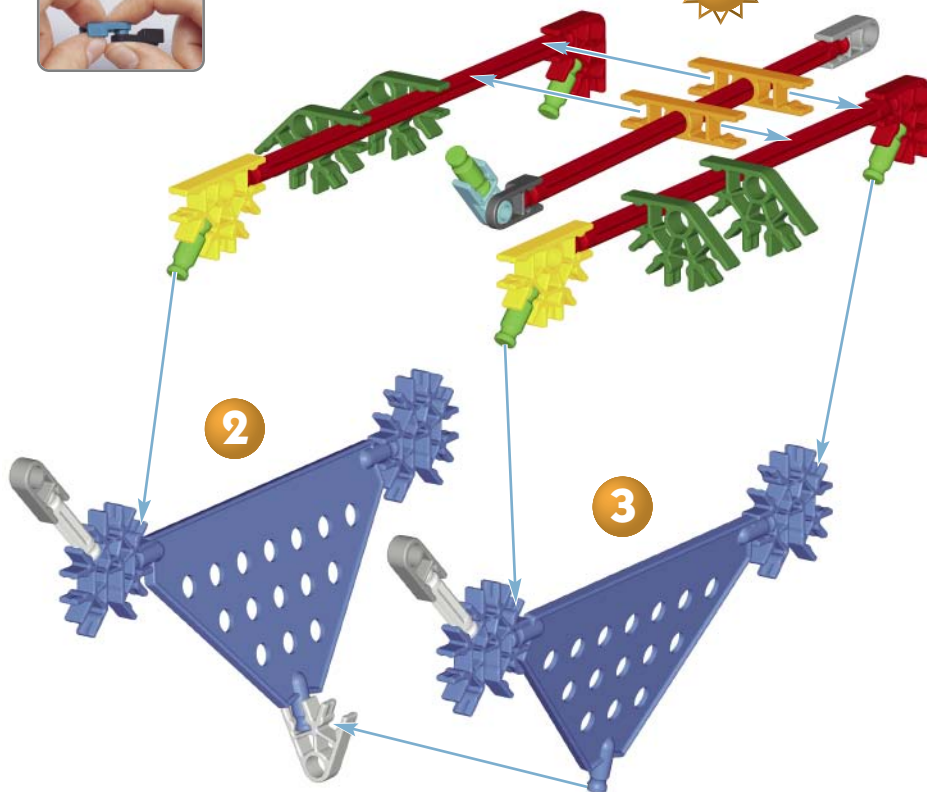

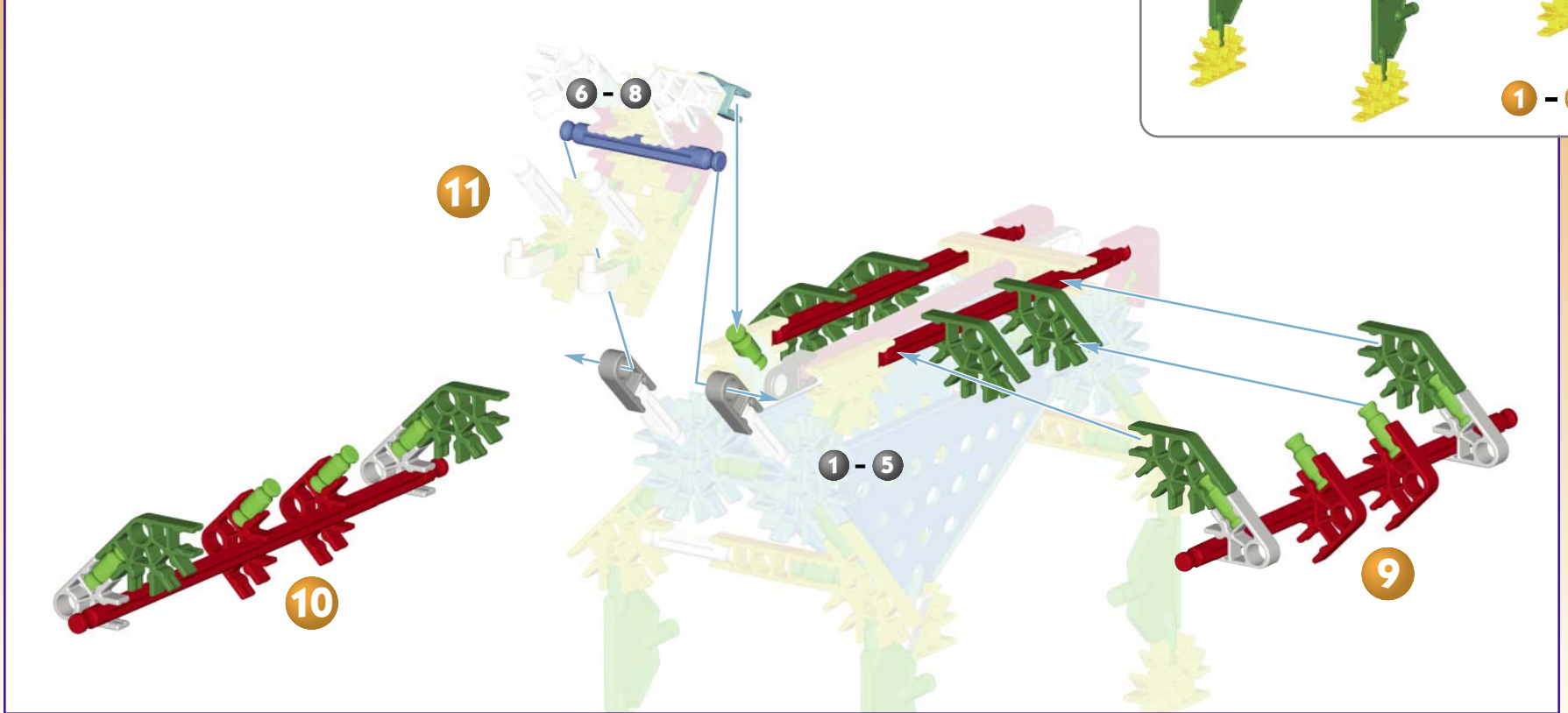
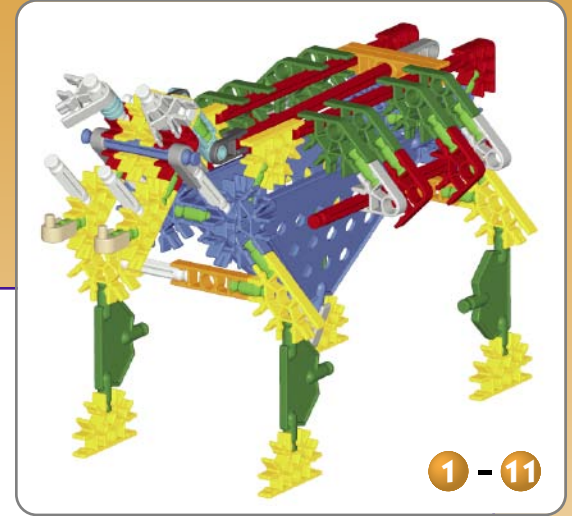
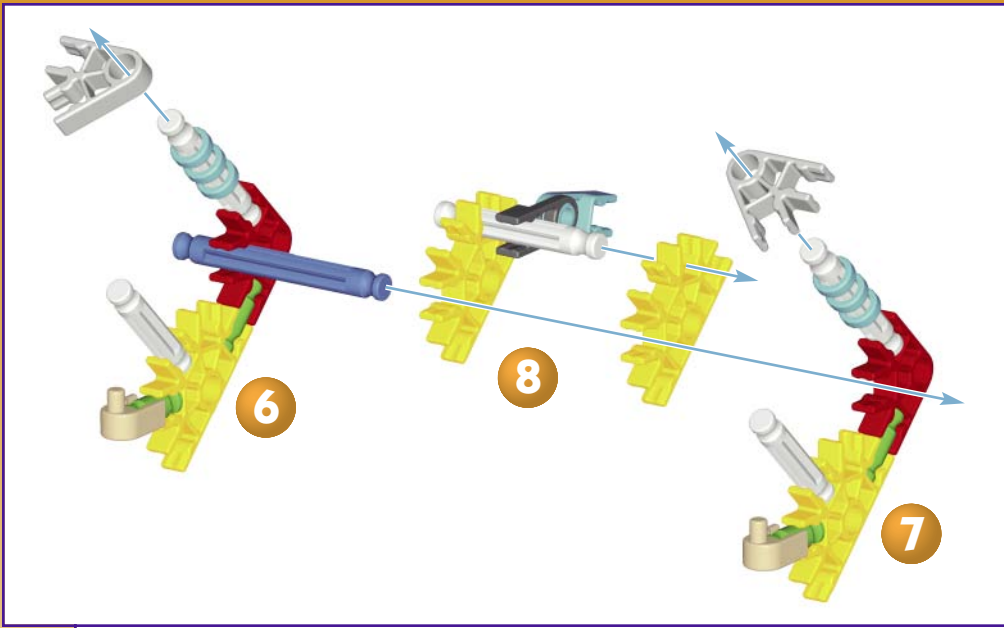

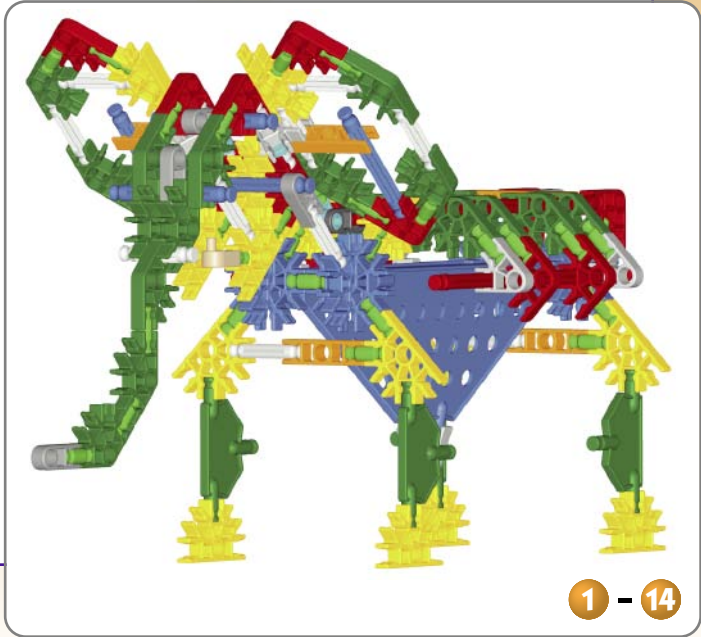
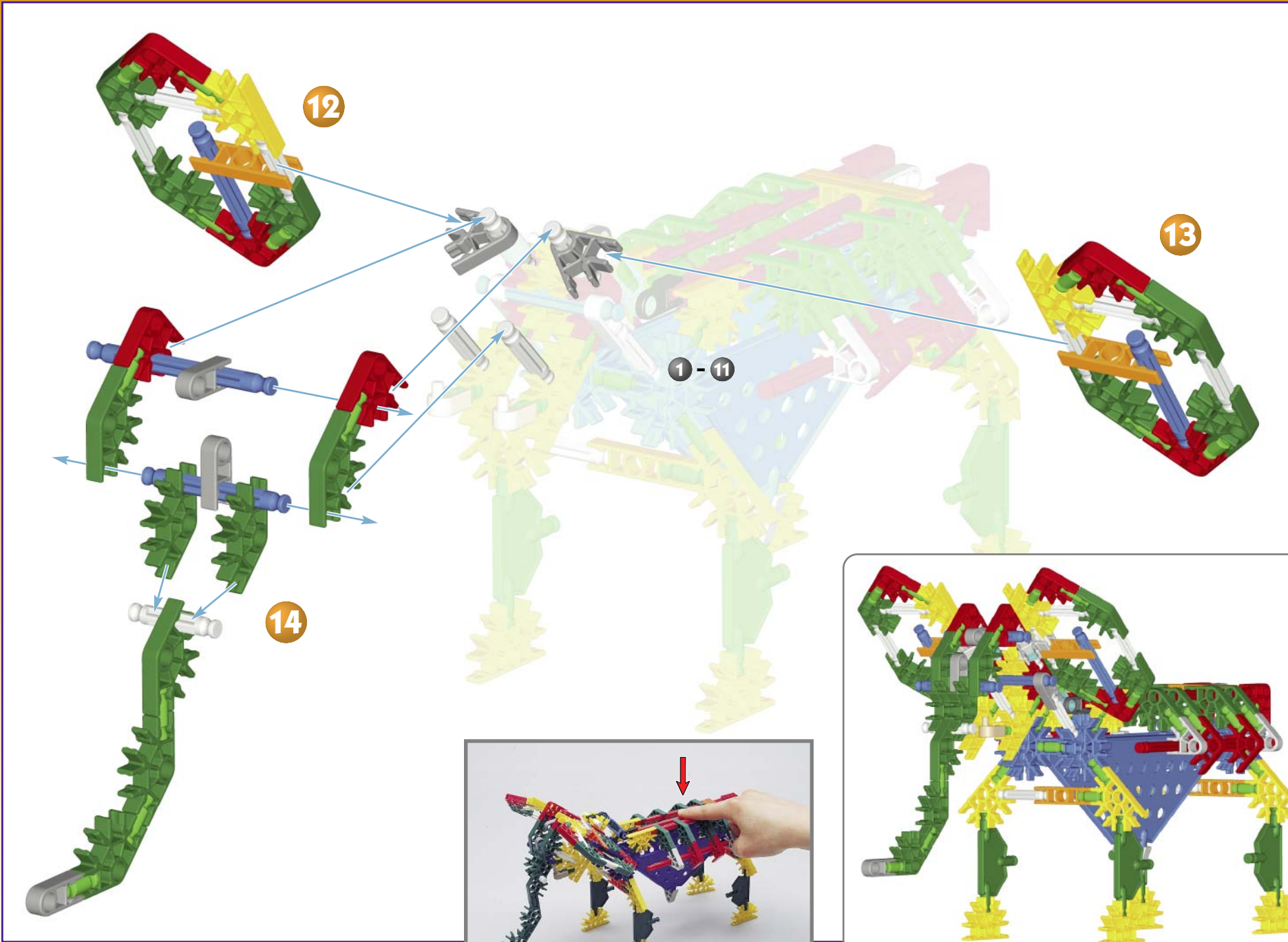

Prop Plane Avion de Propellar

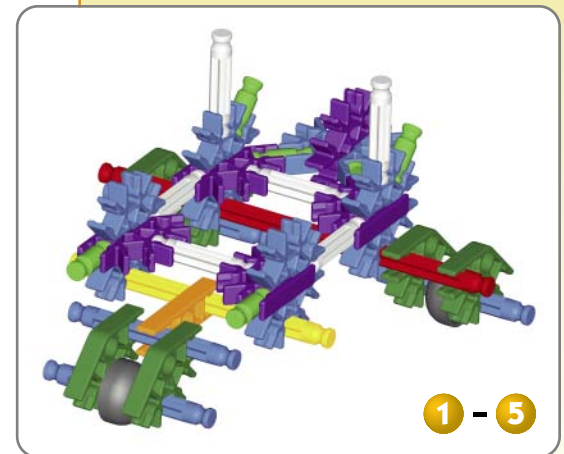
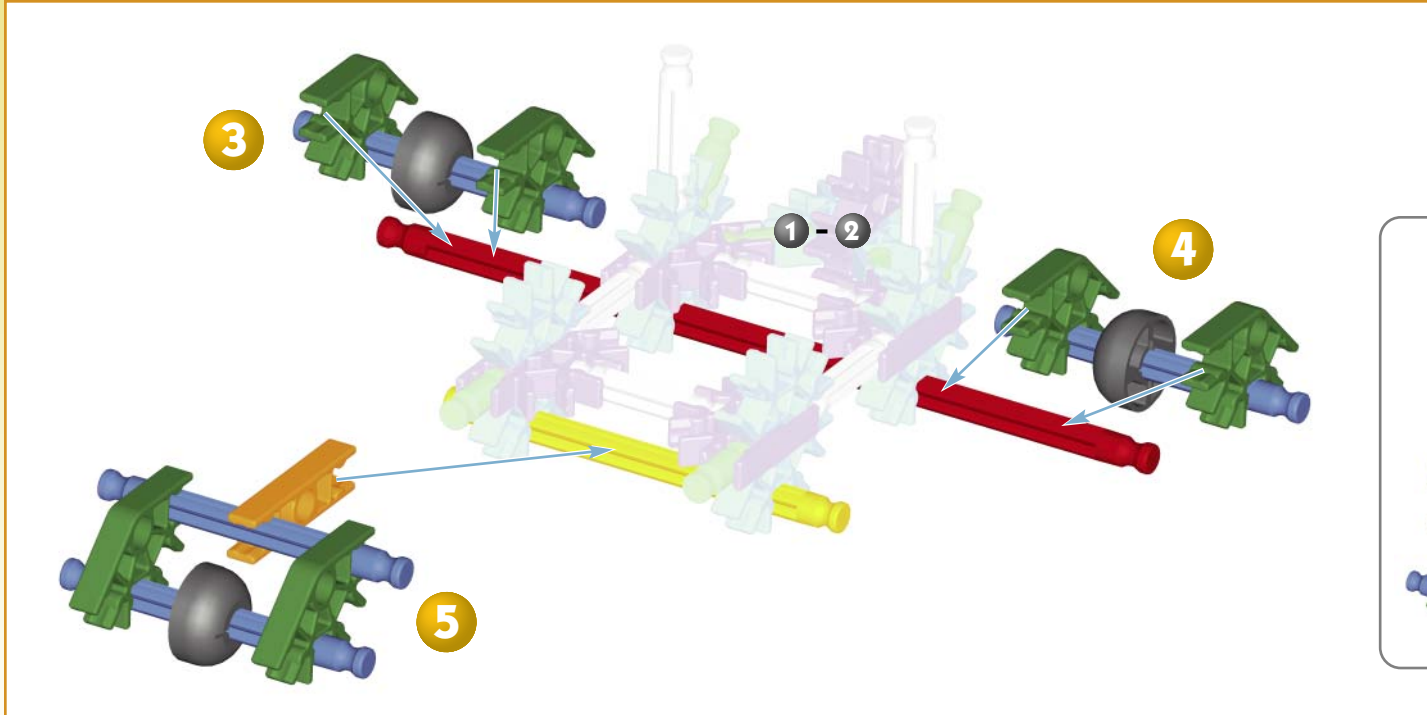
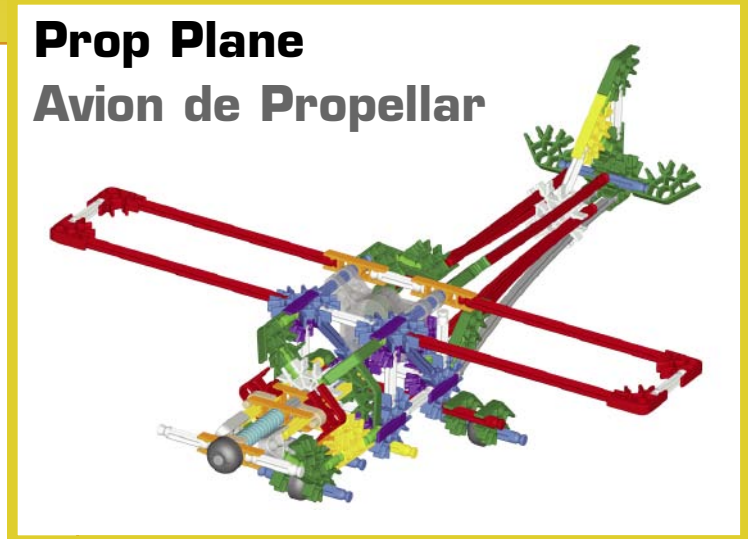
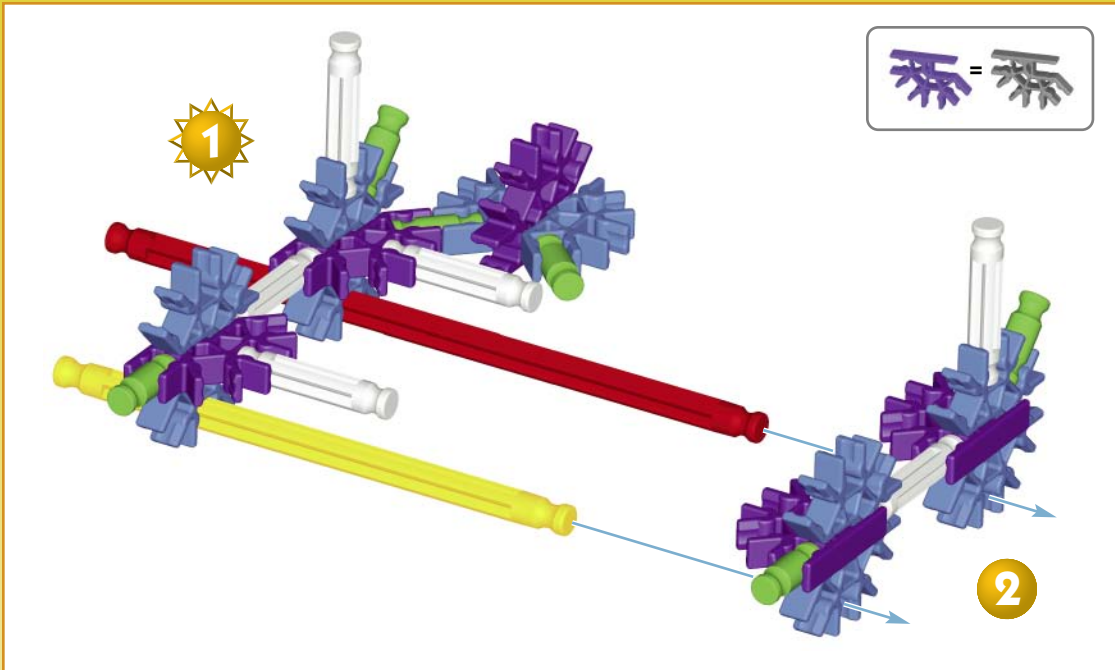

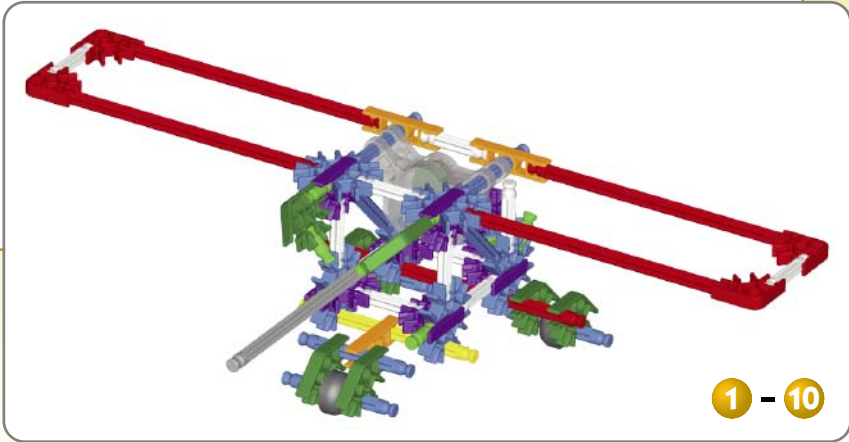
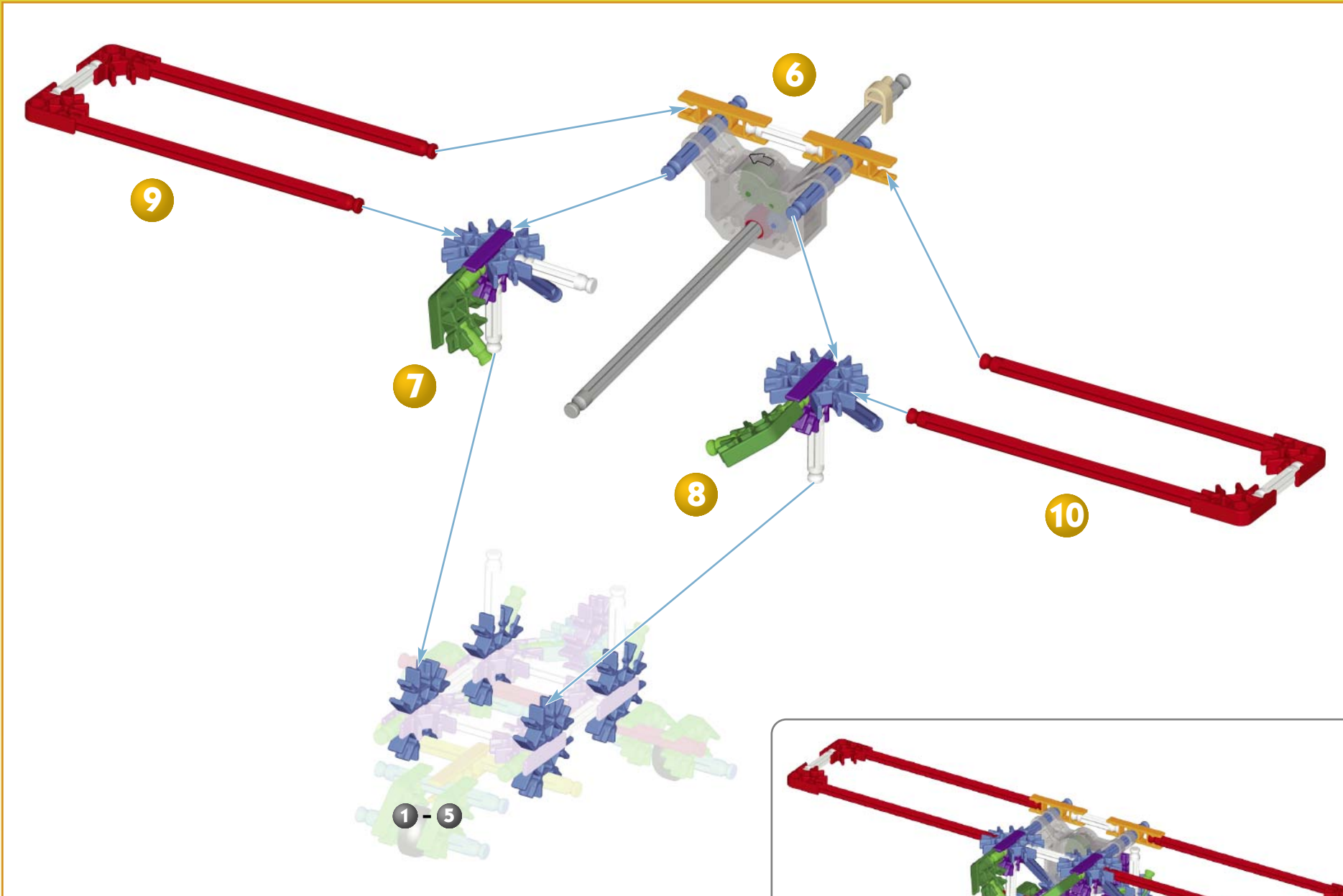

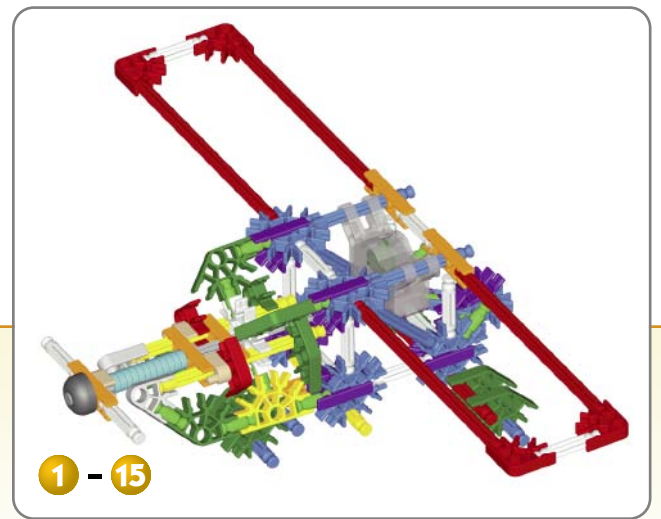
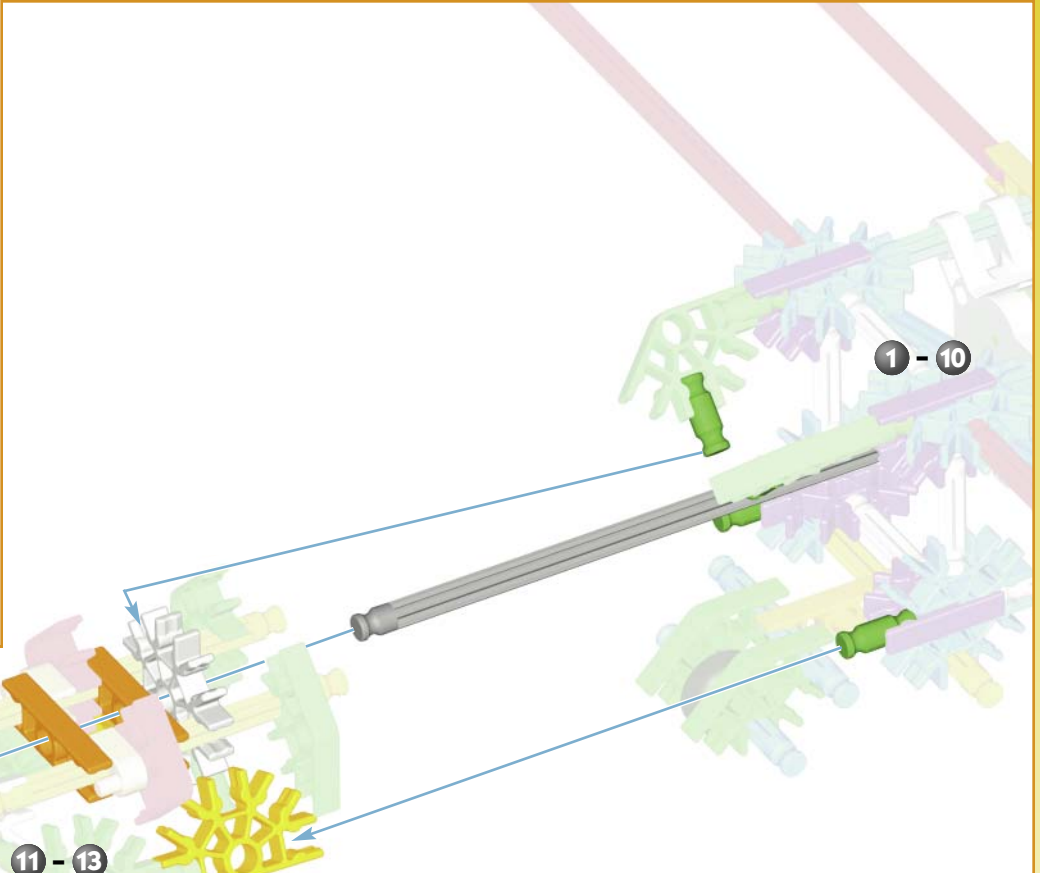
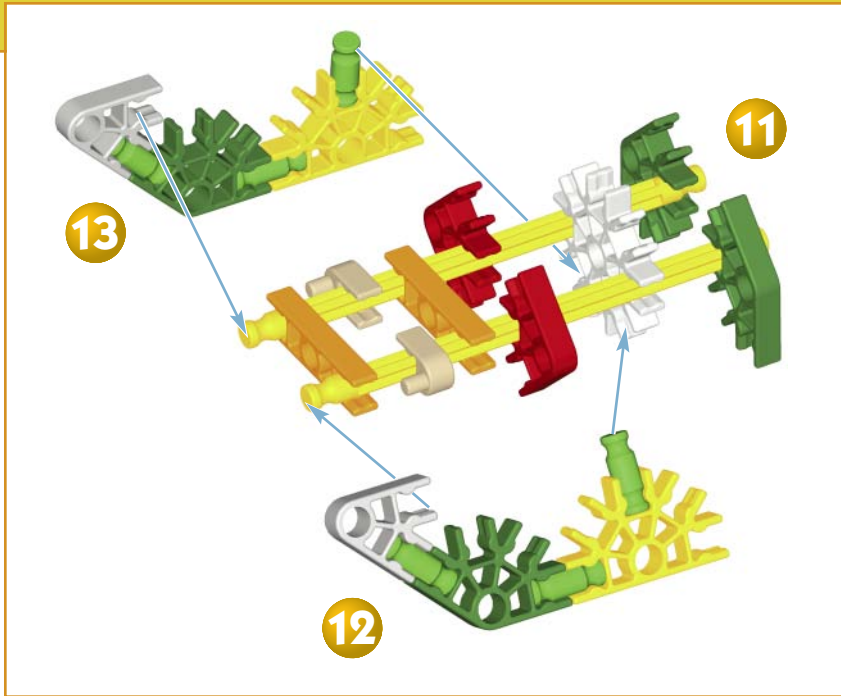

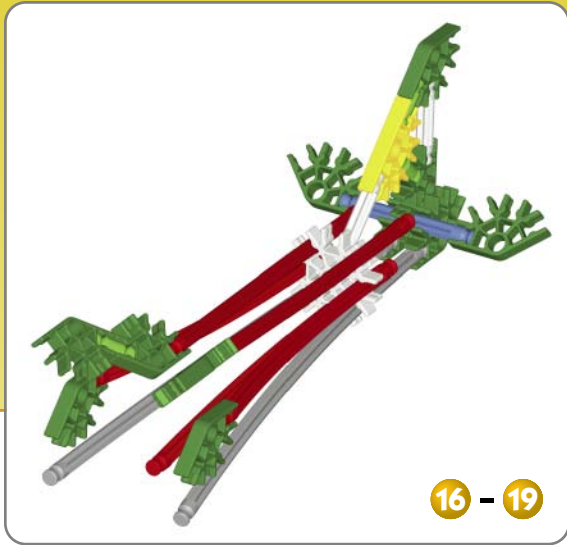

16 - 19

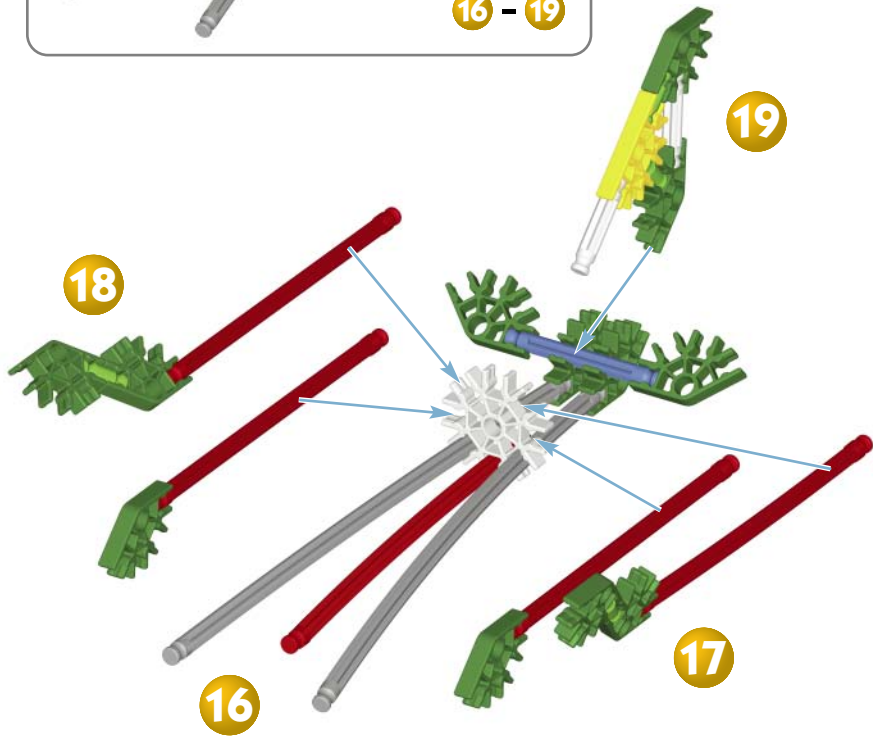

18

16

19

17



1 - 20

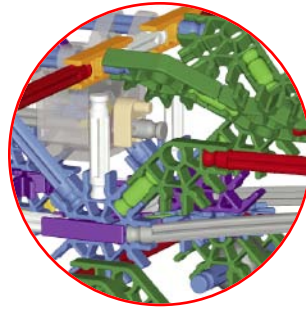

1 - 15

20

16 - 19



Combine Harvester

Moissonneuse-batteuse

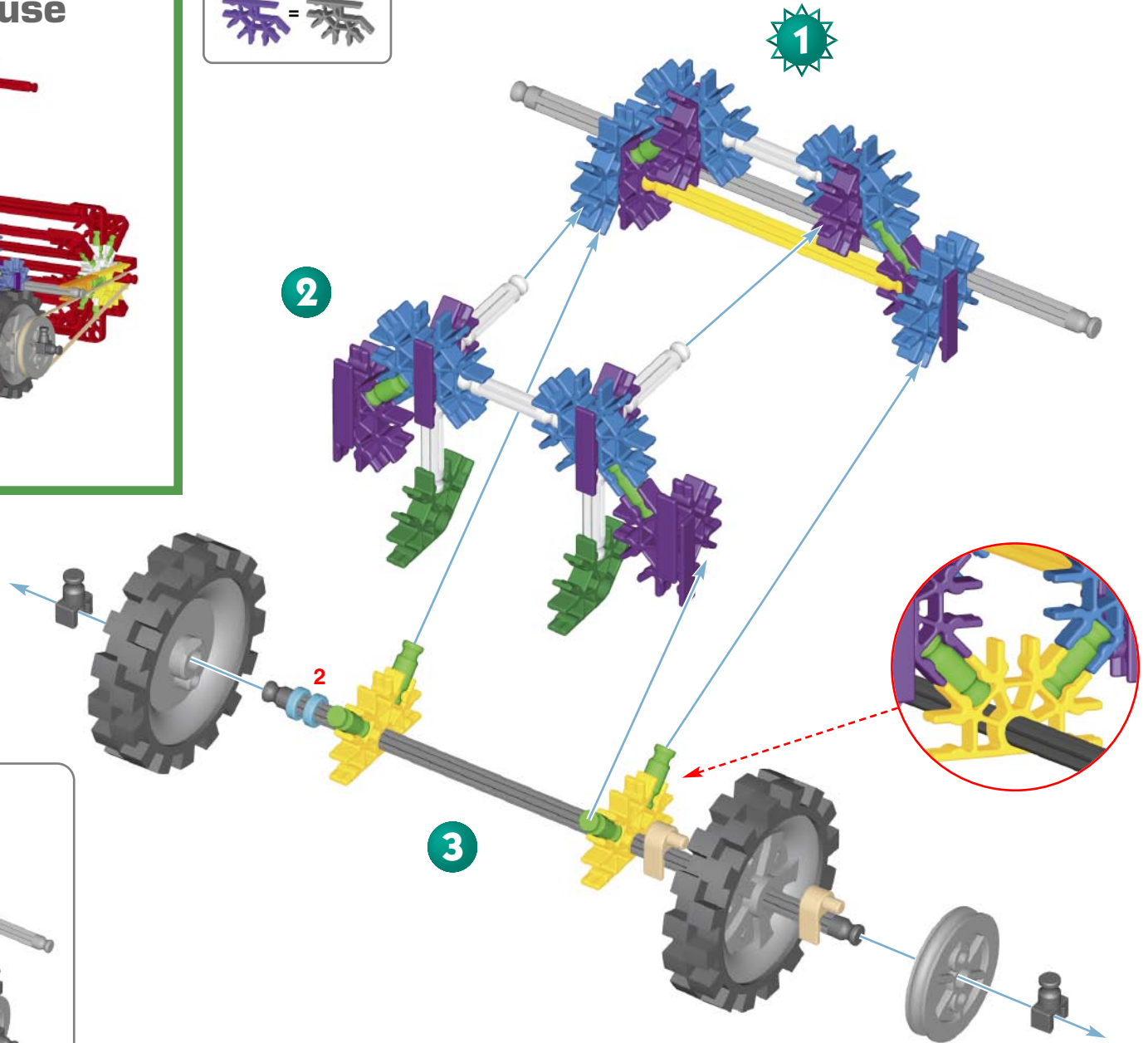
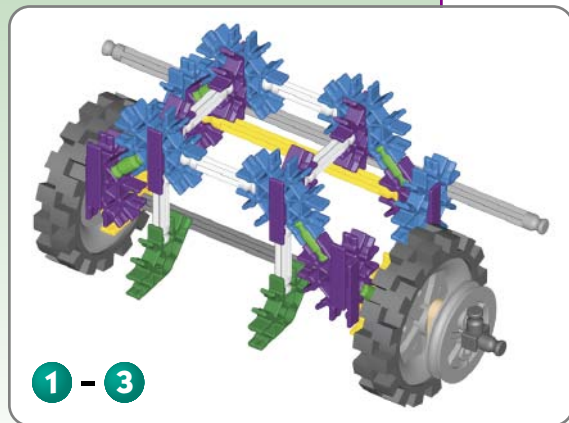
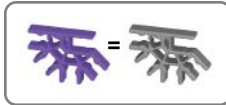

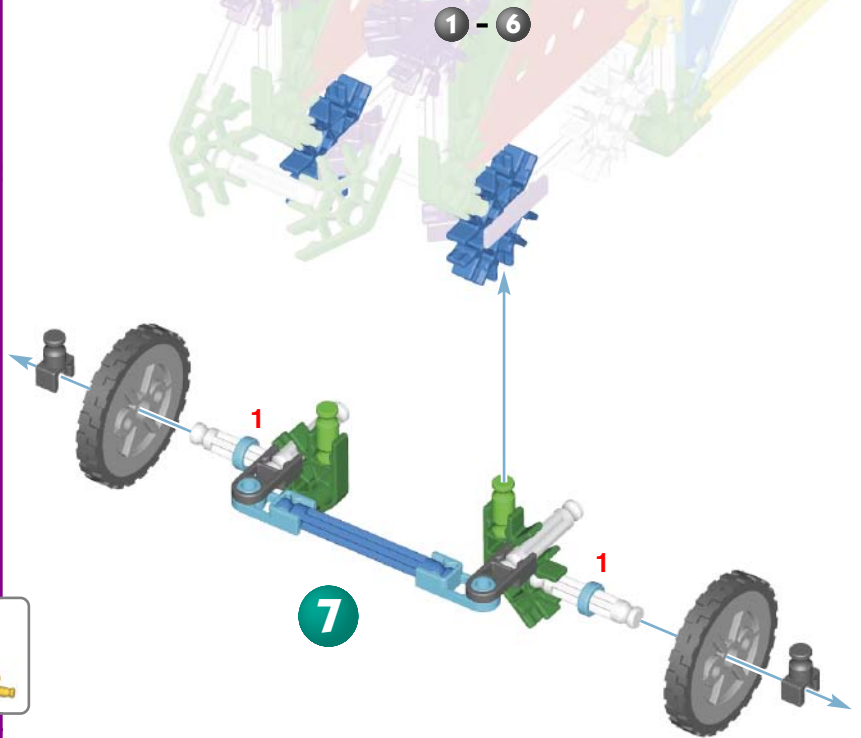
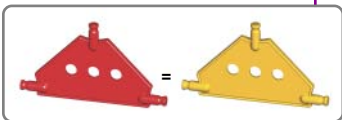
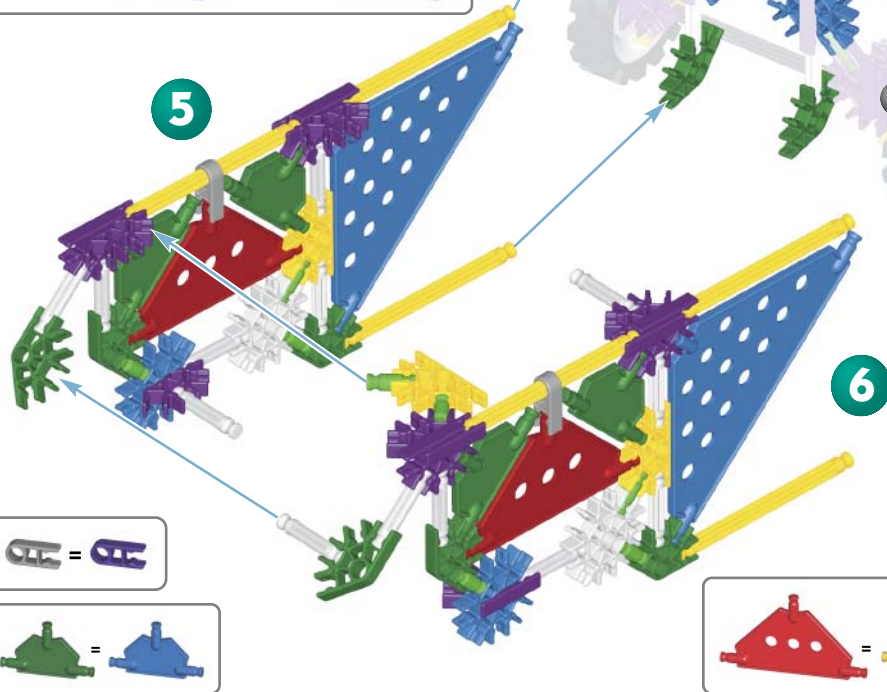
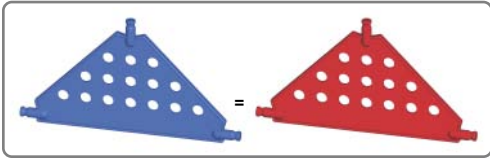
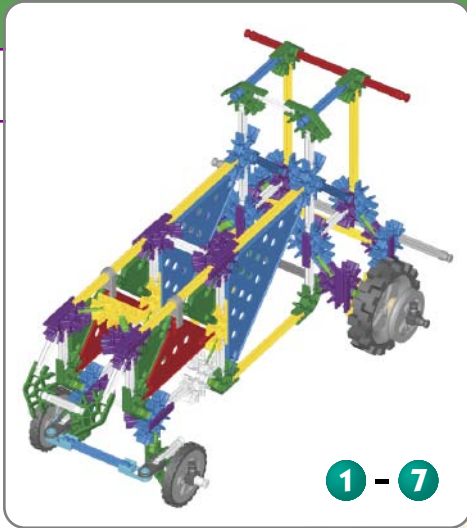
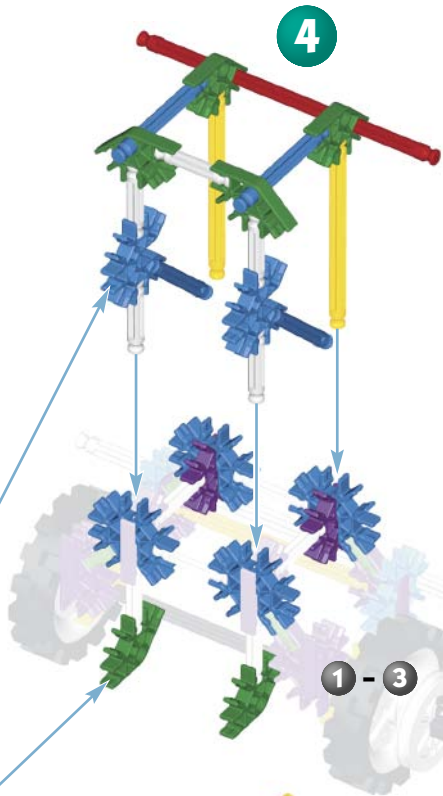

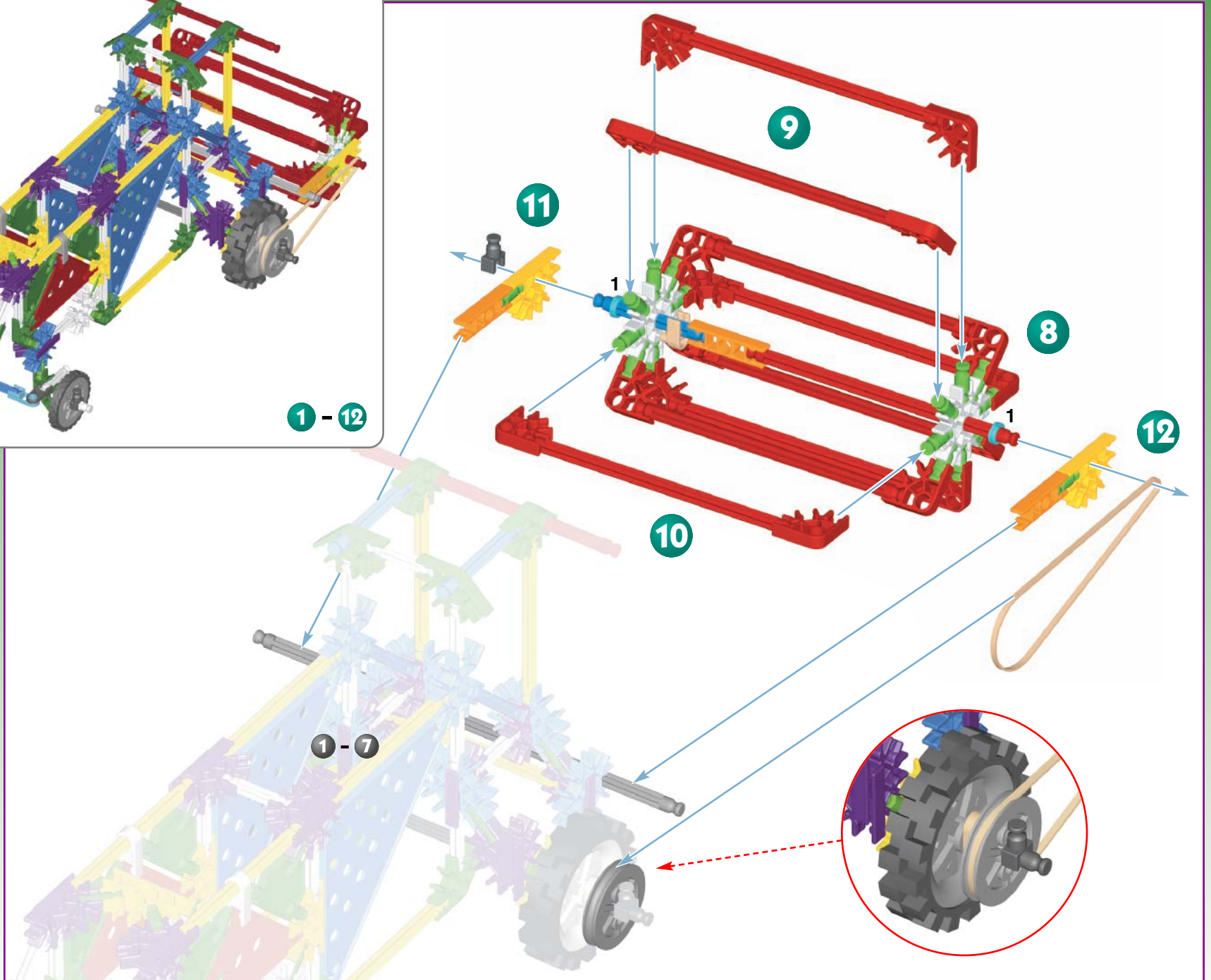
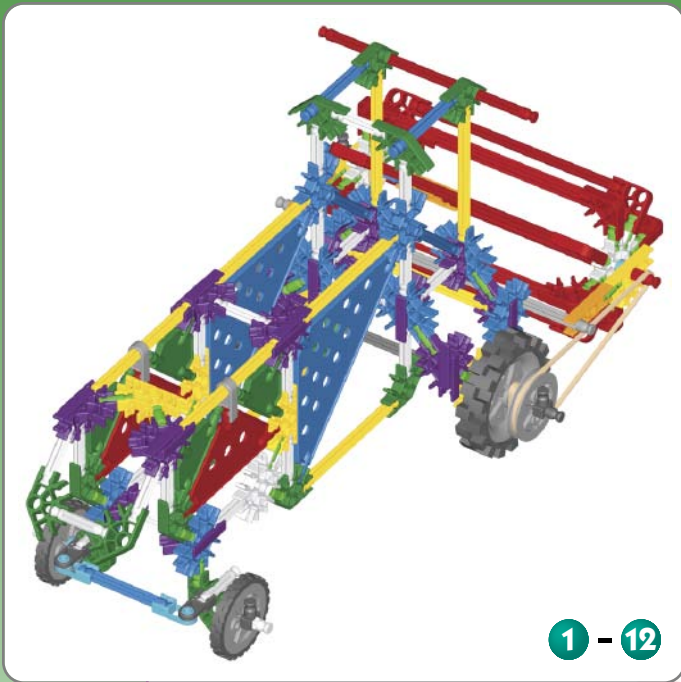

Swing Ride

Tour d'oscillation

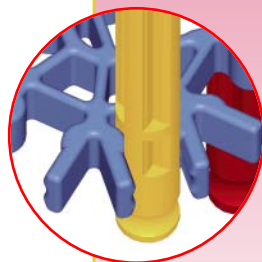
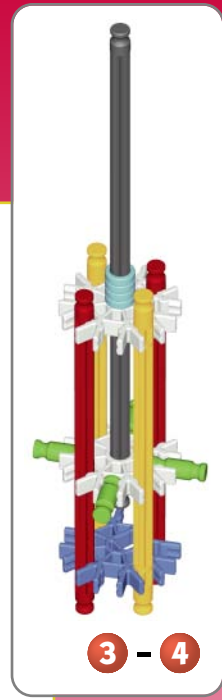
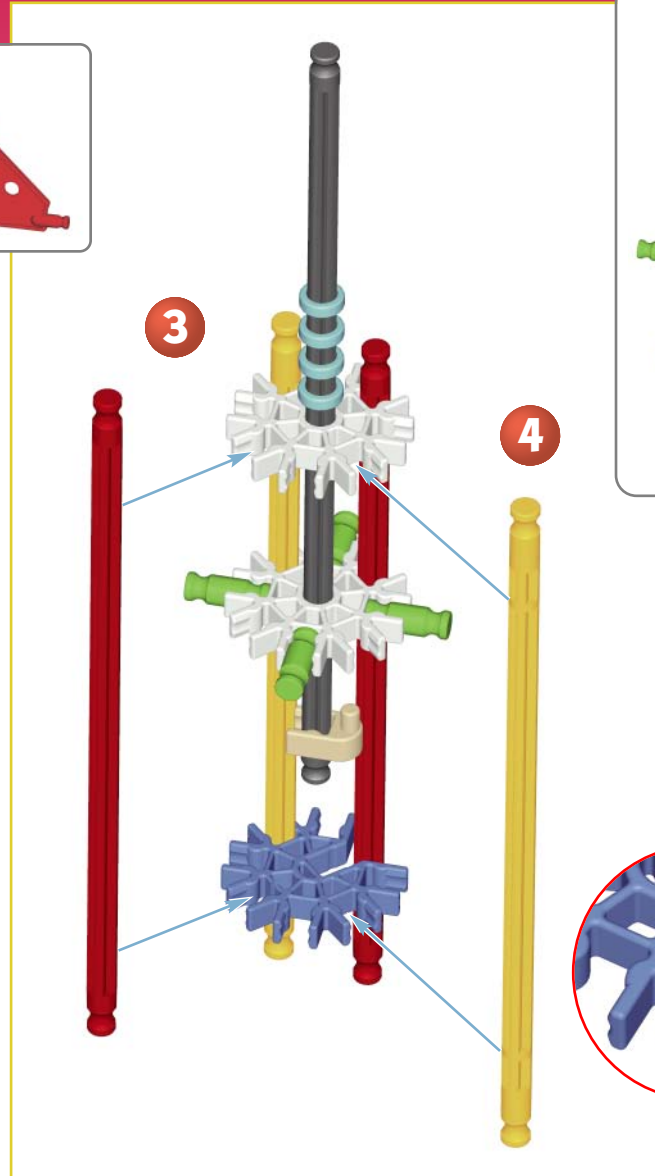
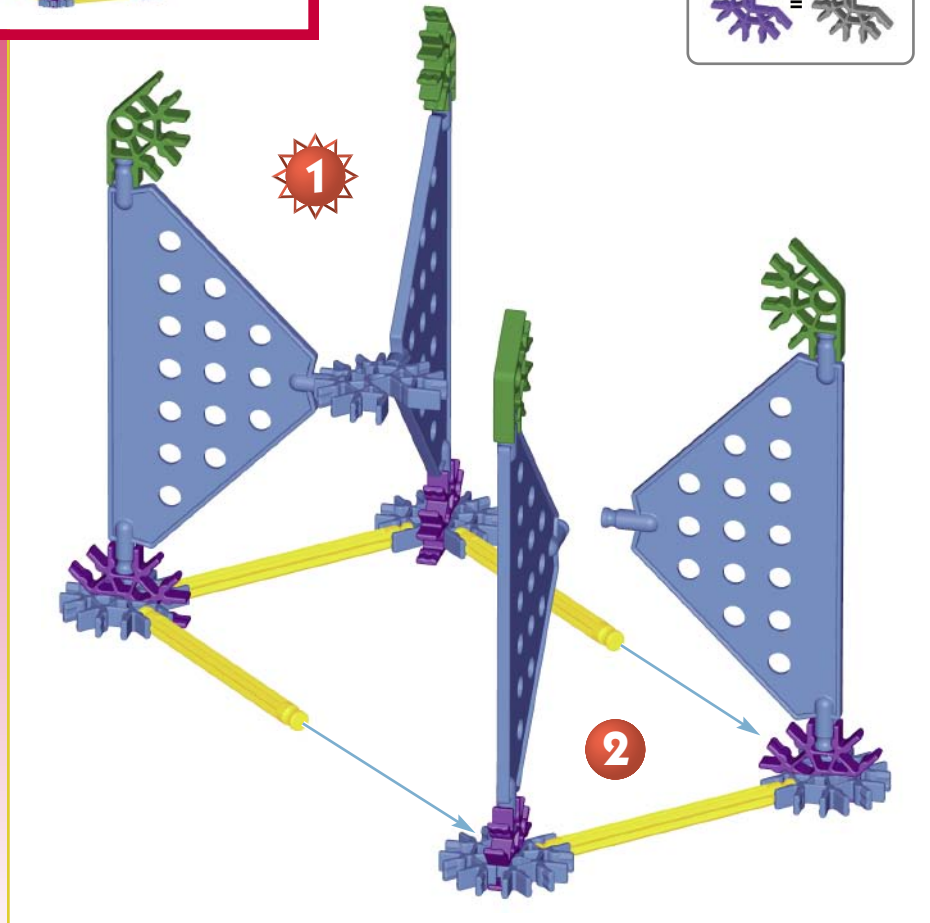
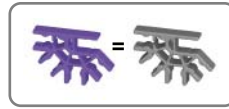
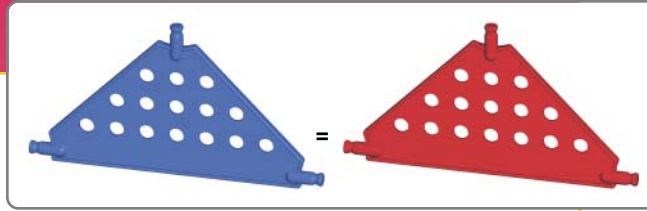

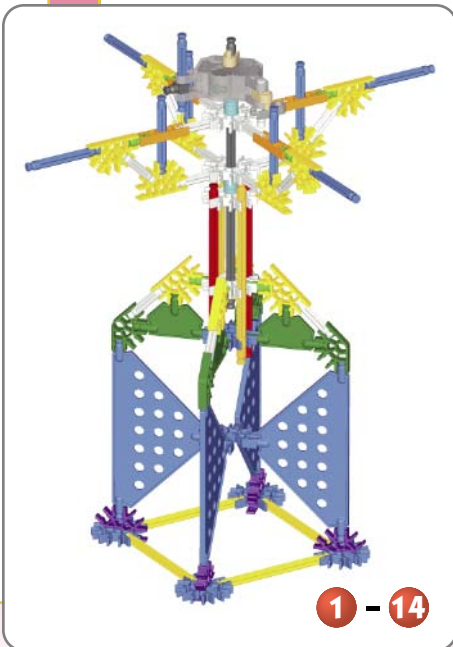
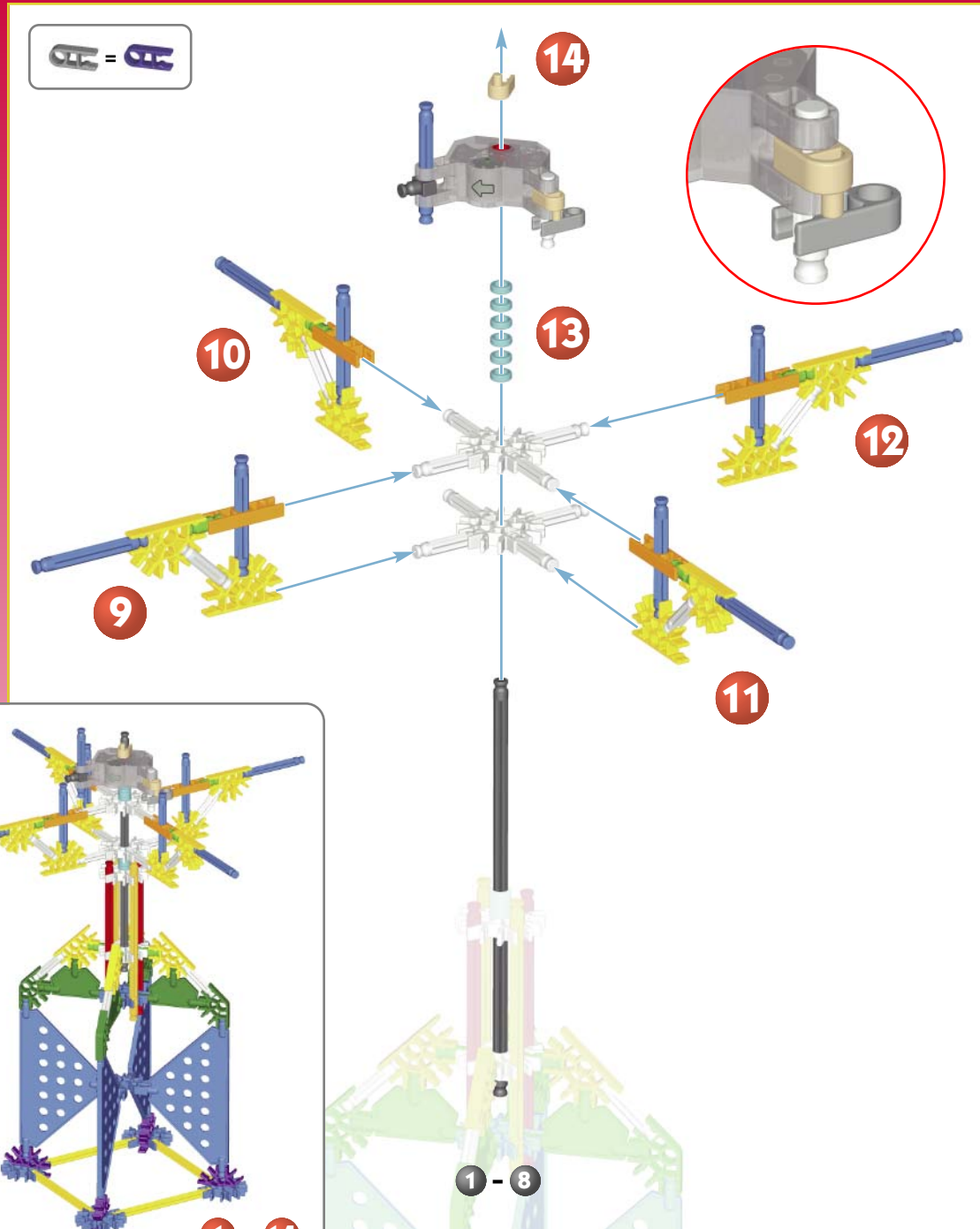
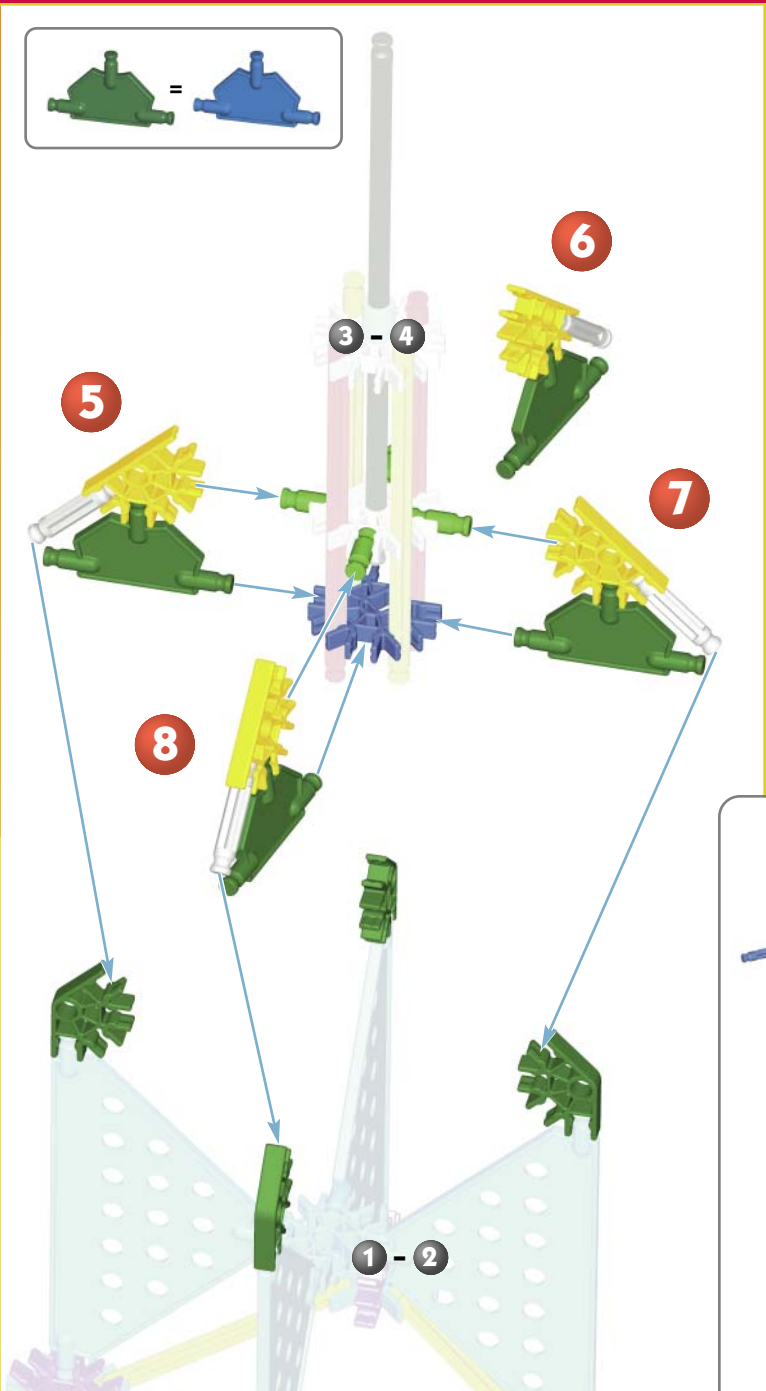

x4

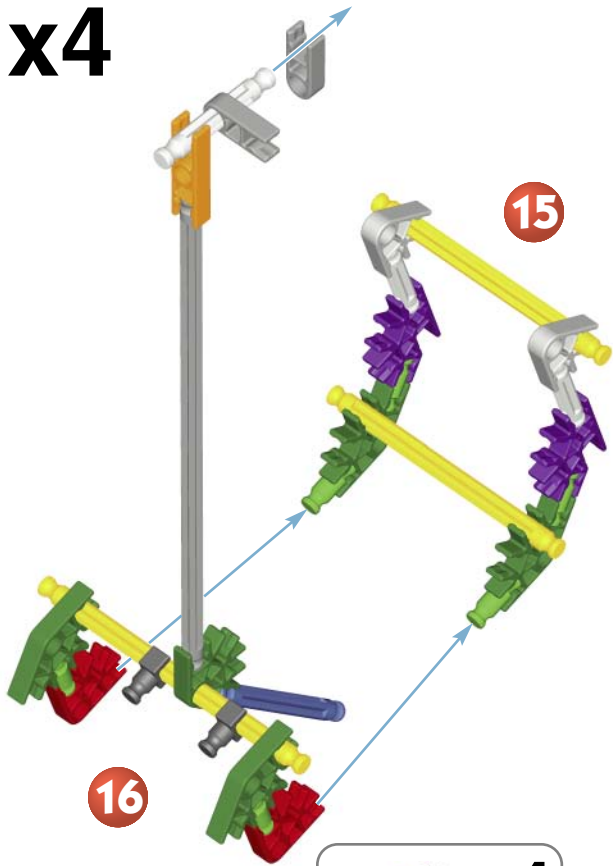

15

16

x4



15 - 16

17

18

15 - 16

1 - 14

15 - 16

15 - 16

20

15 - 16

19

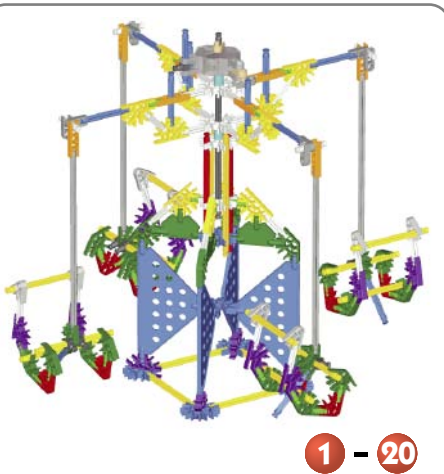
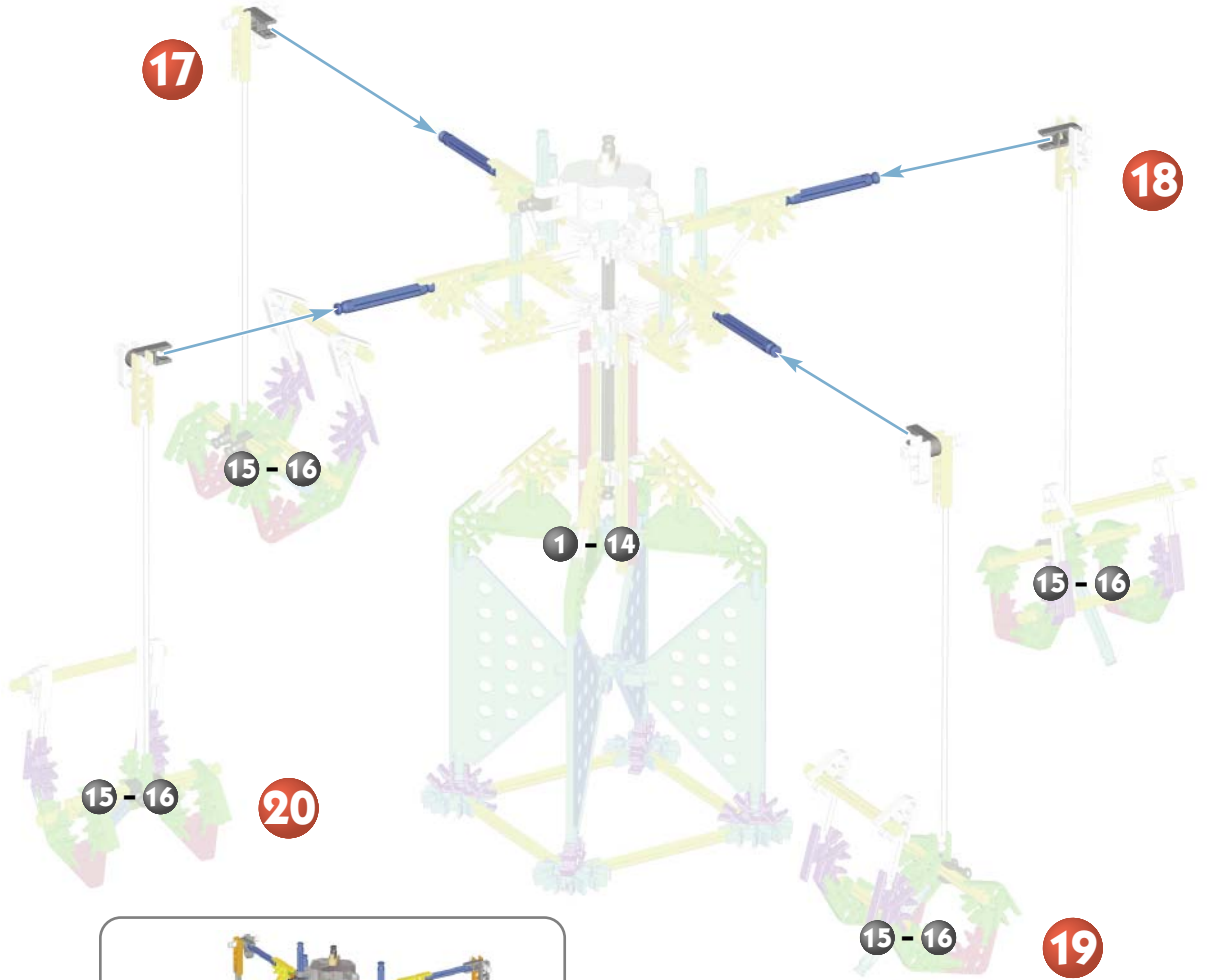

1 - 20

Exploration Vehicle

Véhicule d'Exploration

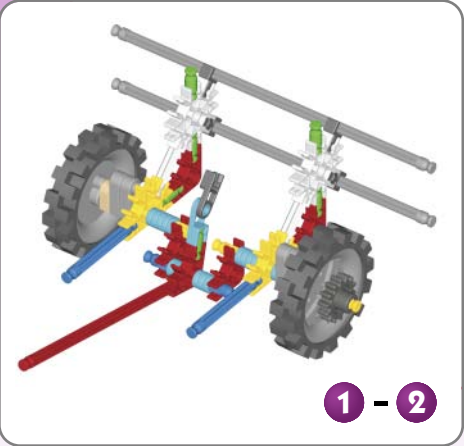
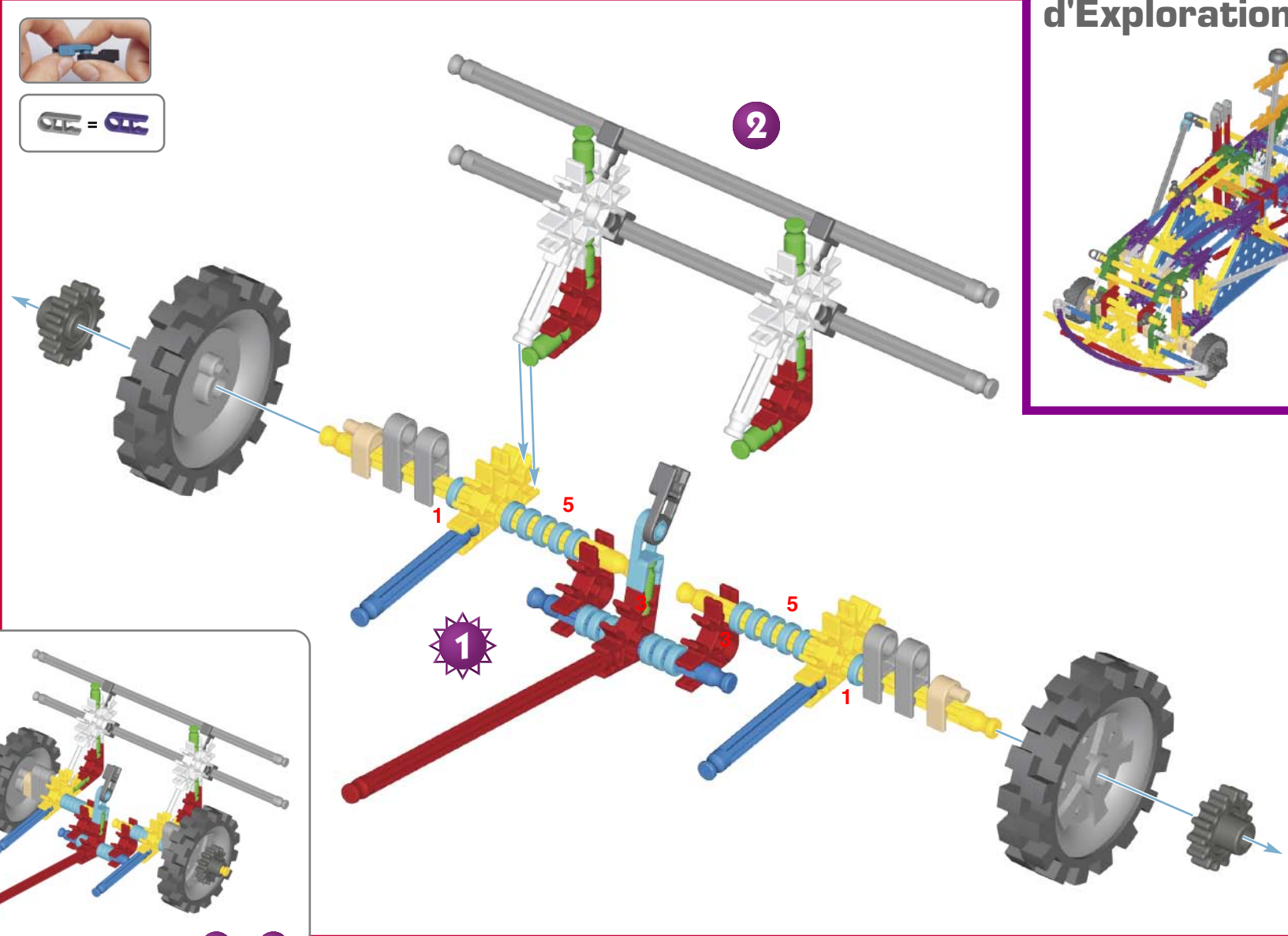

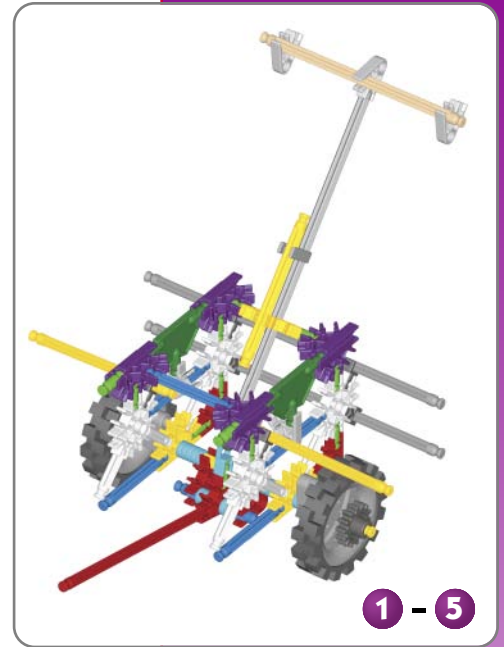
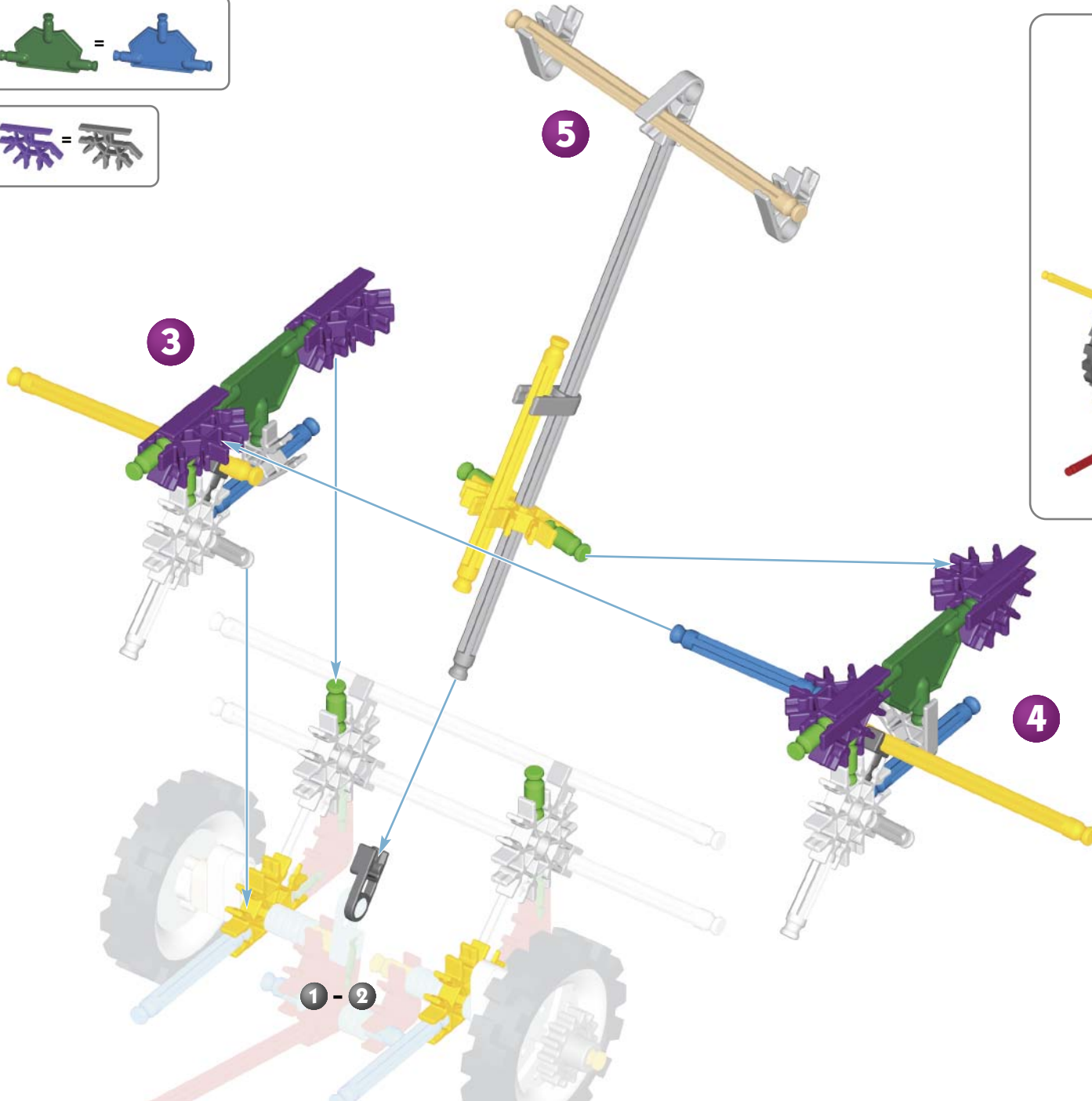
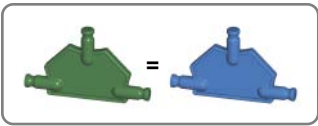

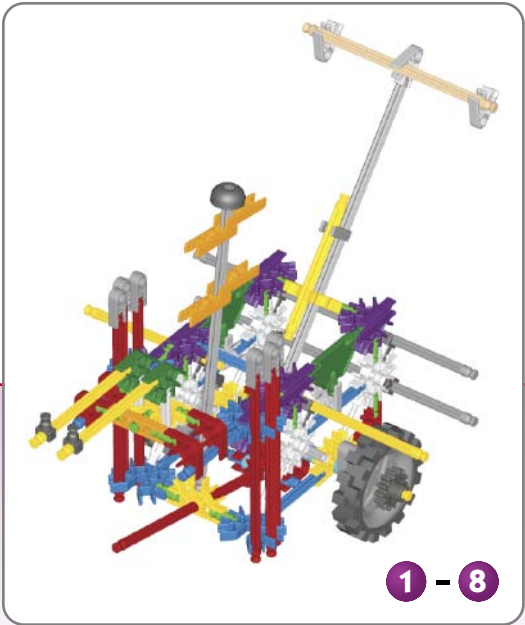
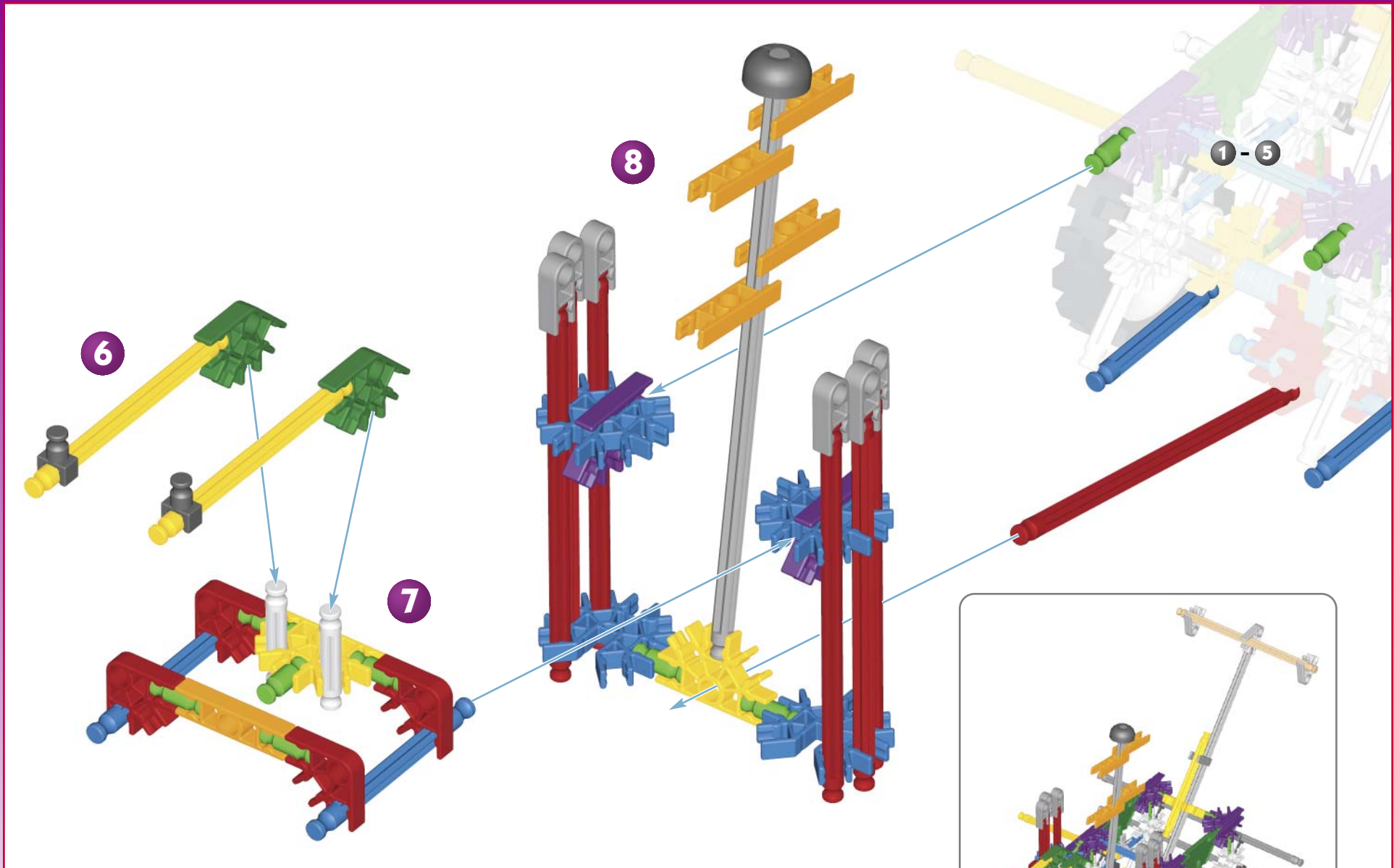

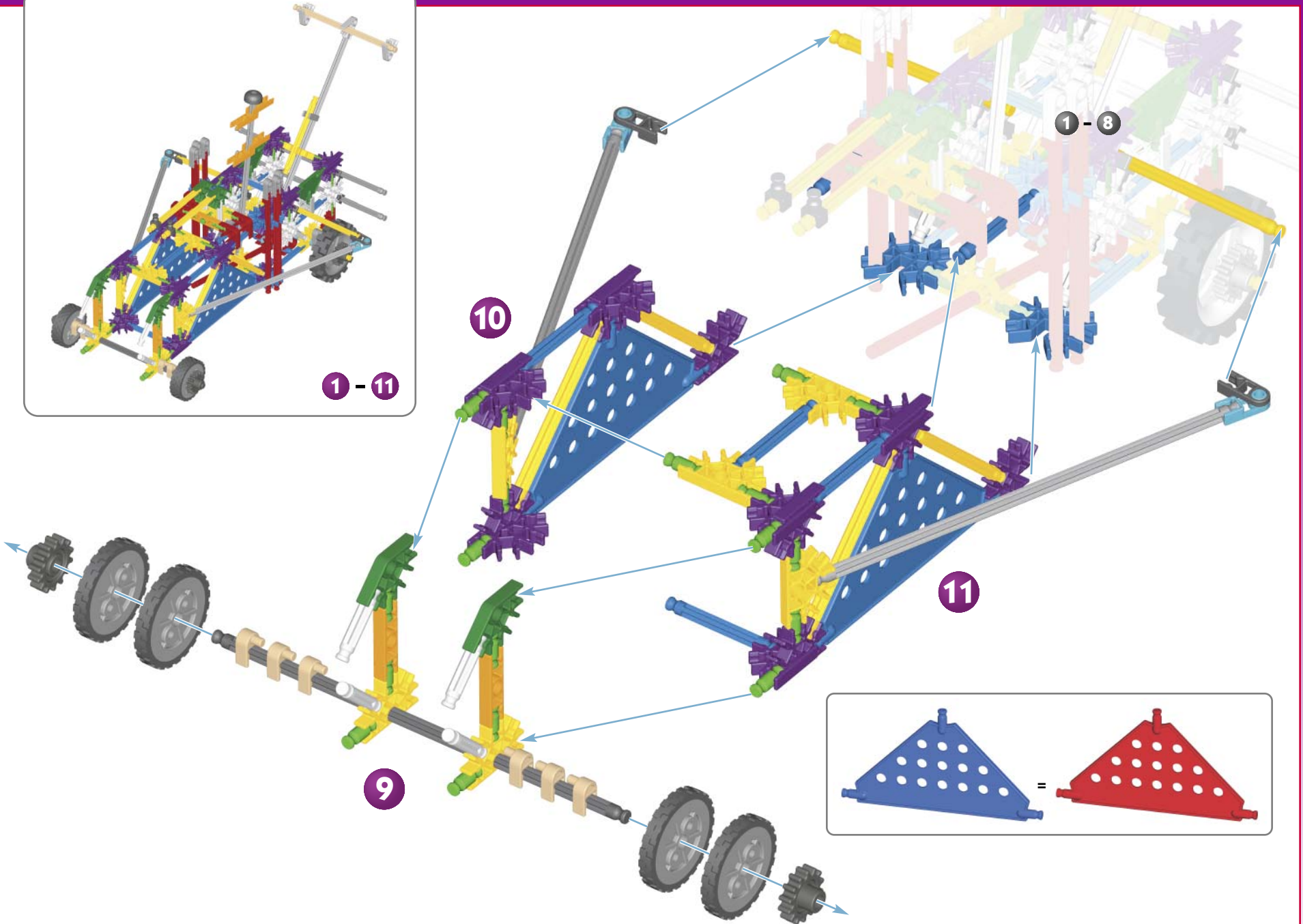
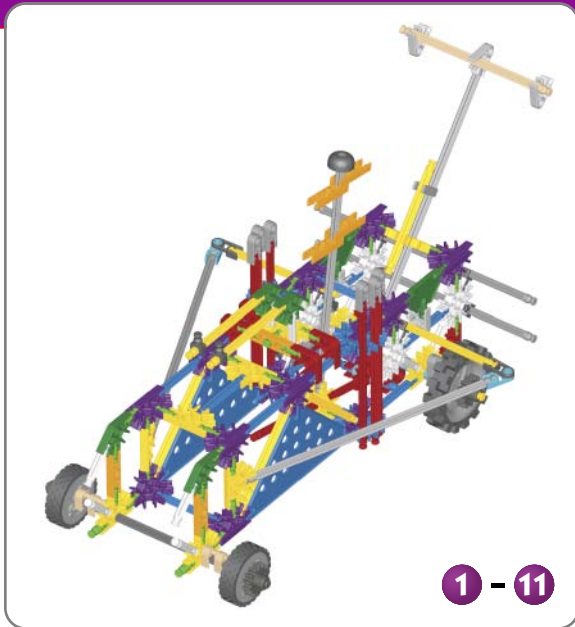

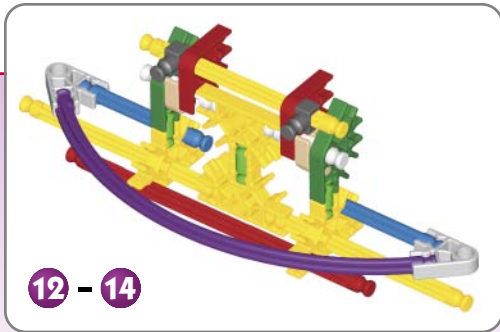
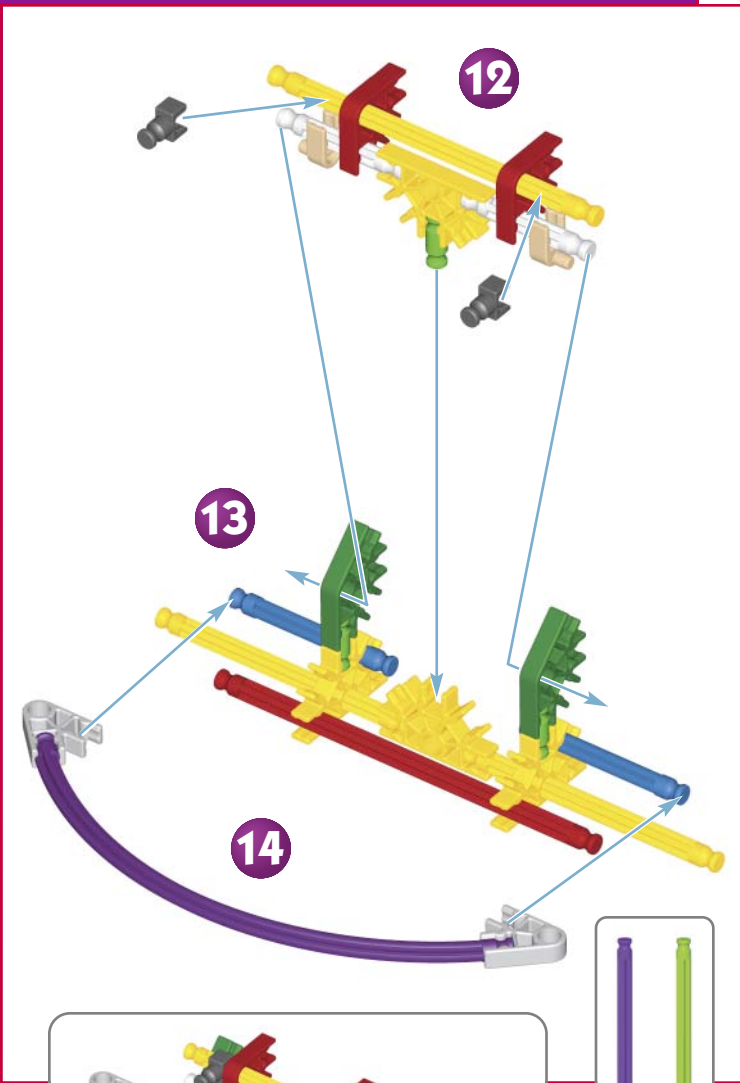

12 - 14

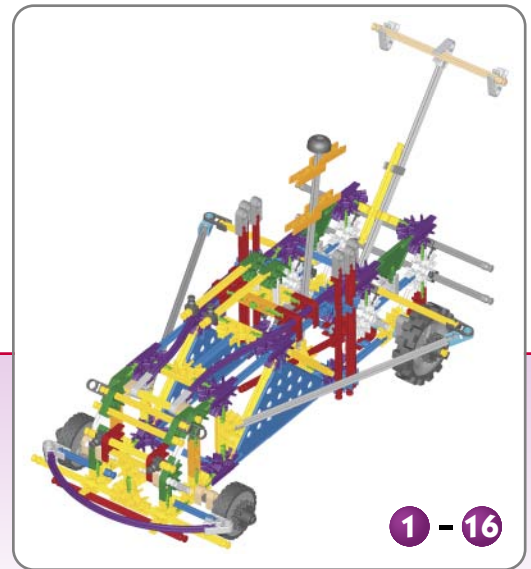
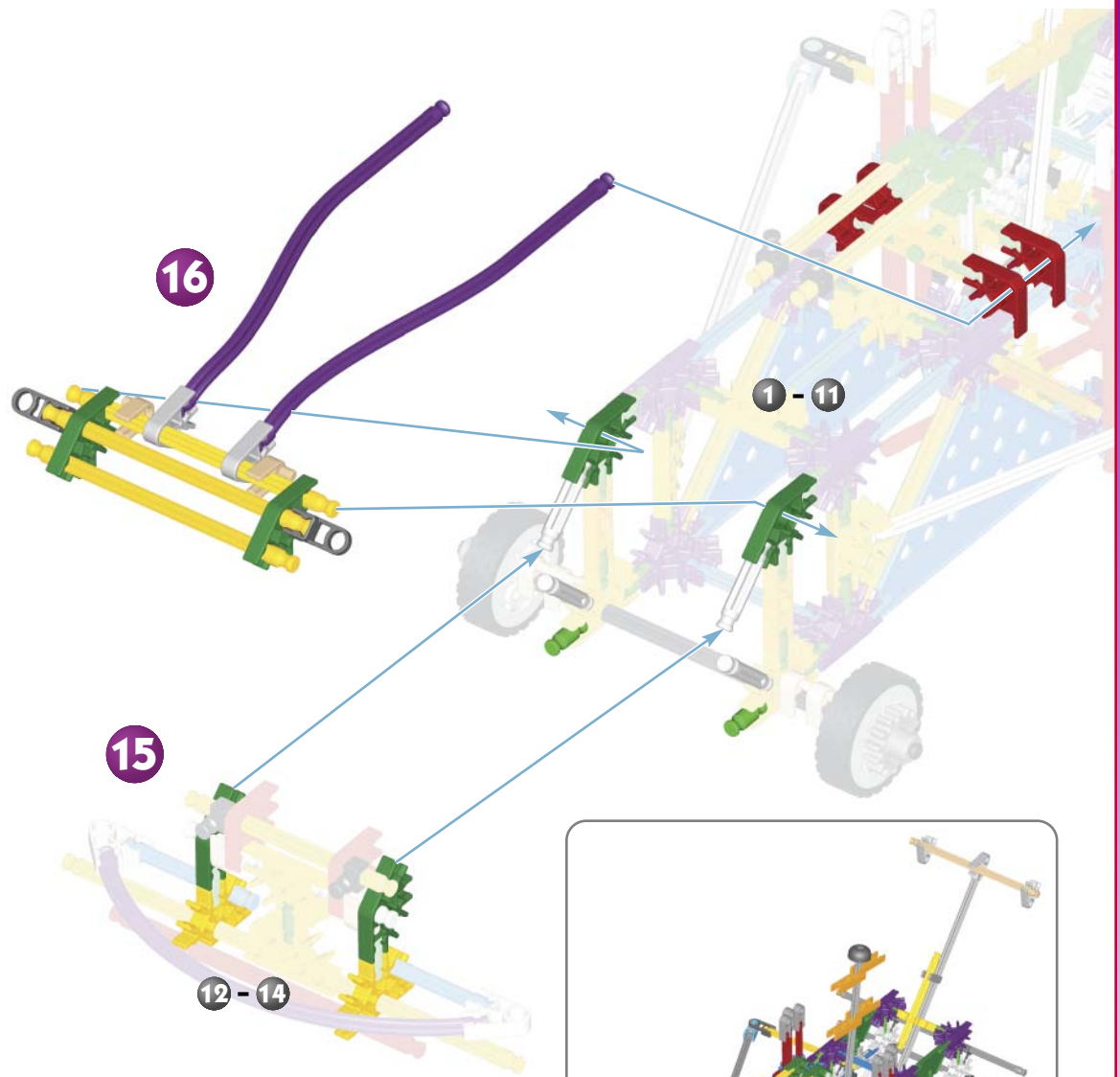

1 - 16

Radar Center Centre Radar

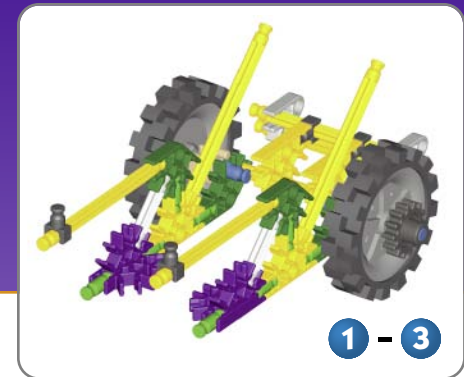

1 - 3

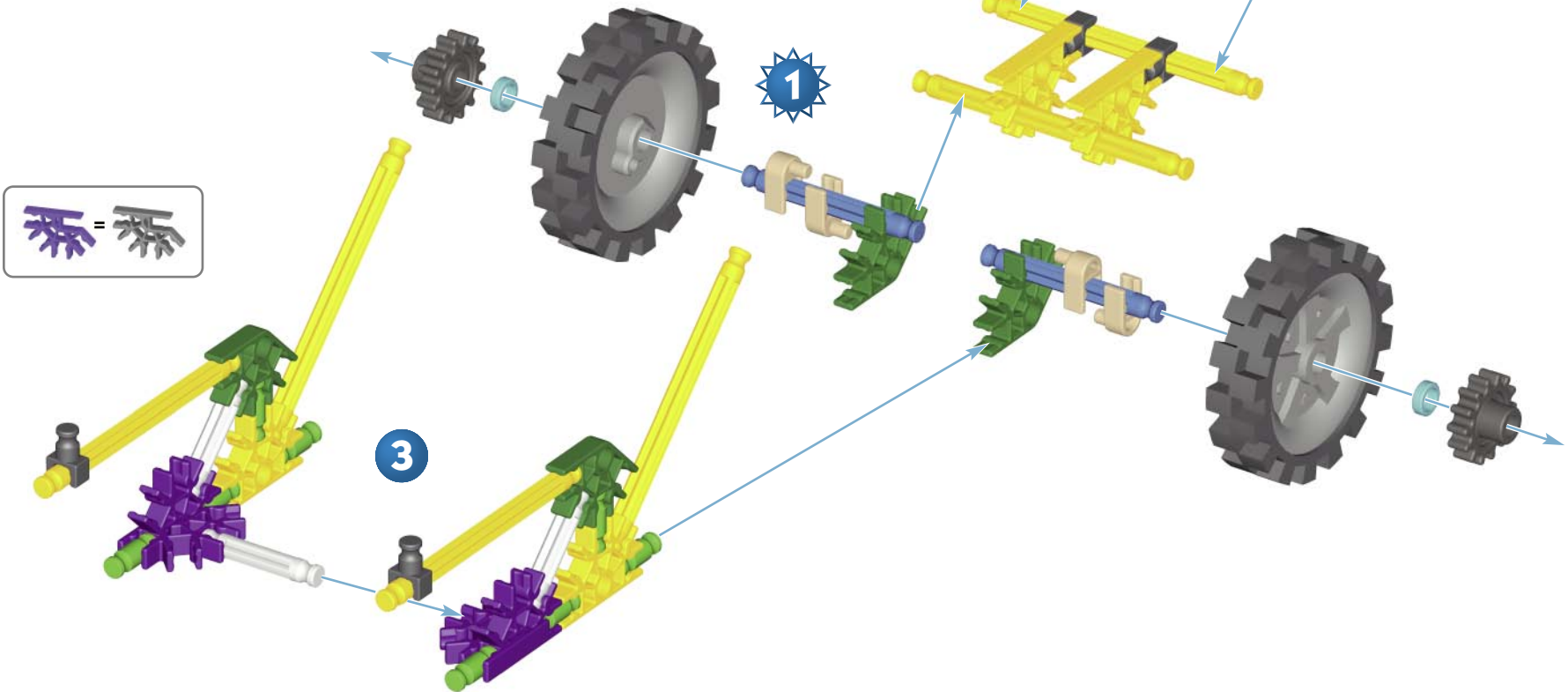

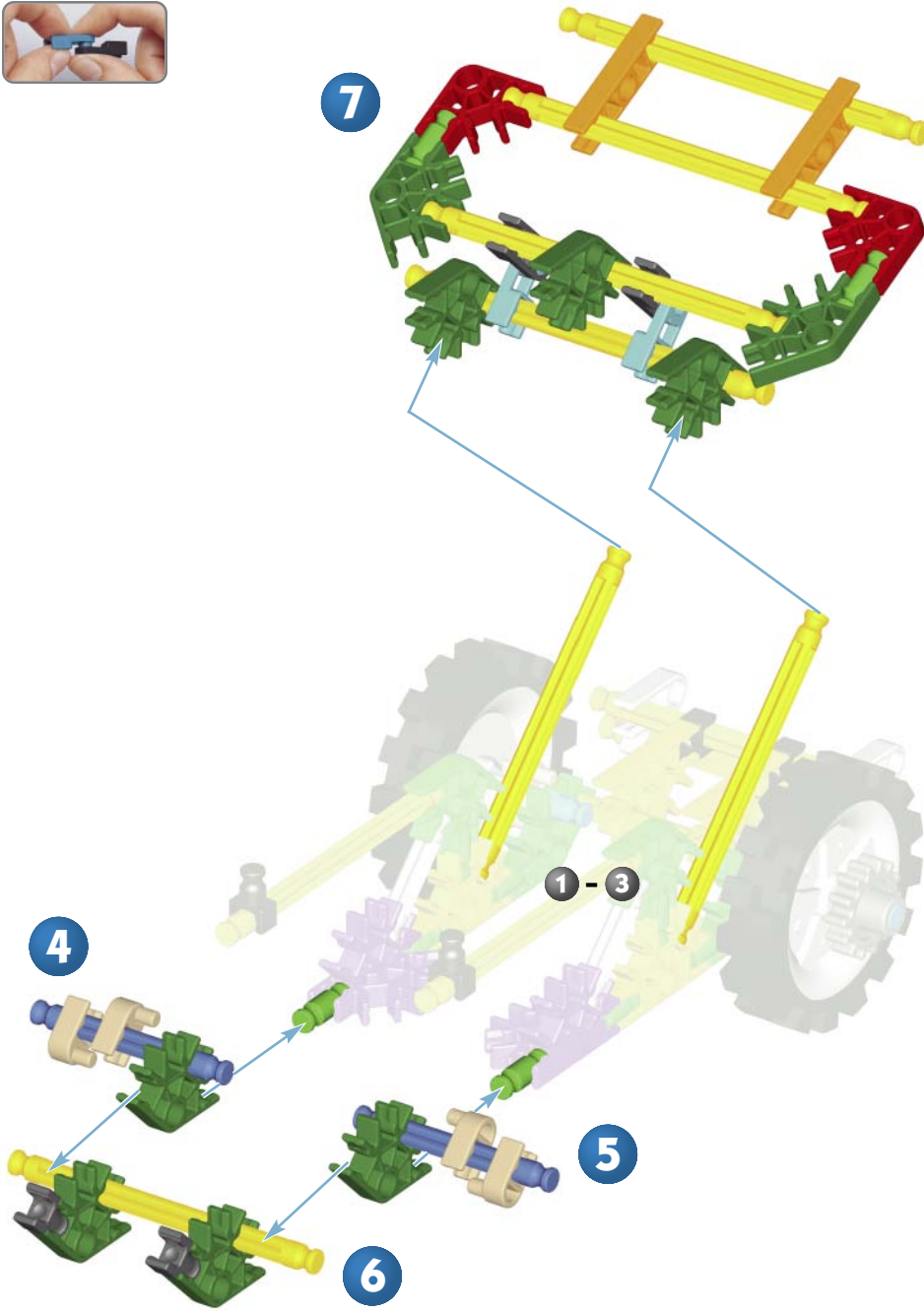

7

1 - 3

4

5

6

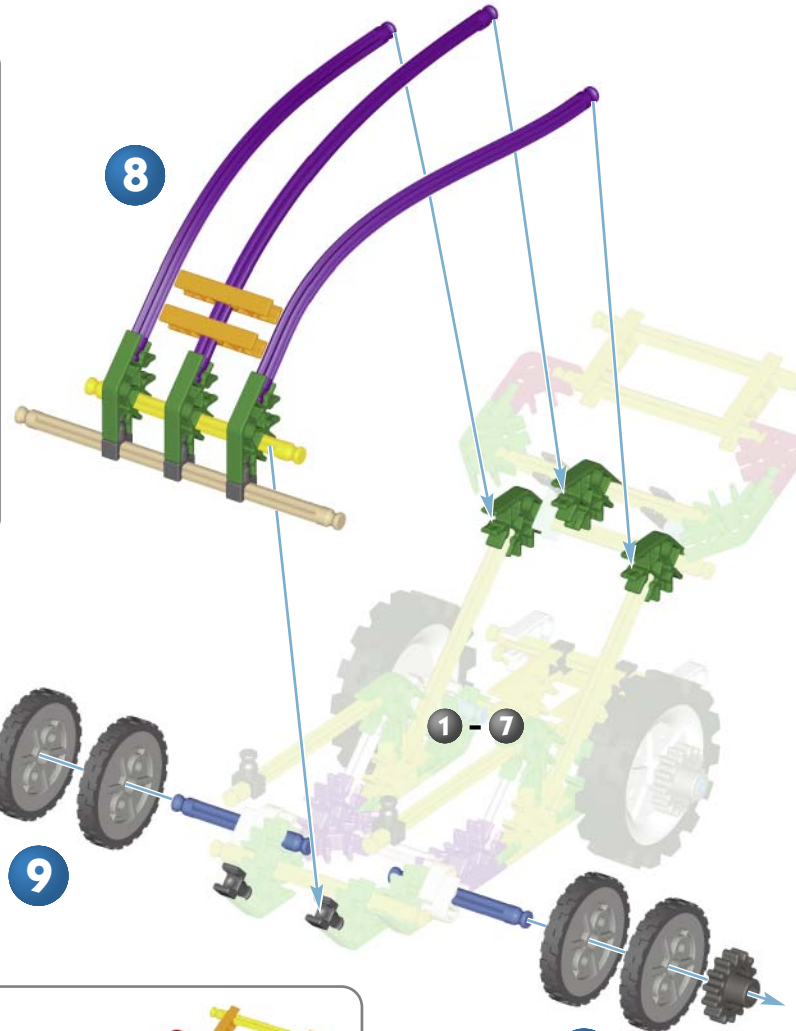

8

9

1 - 7

10



1 - 10

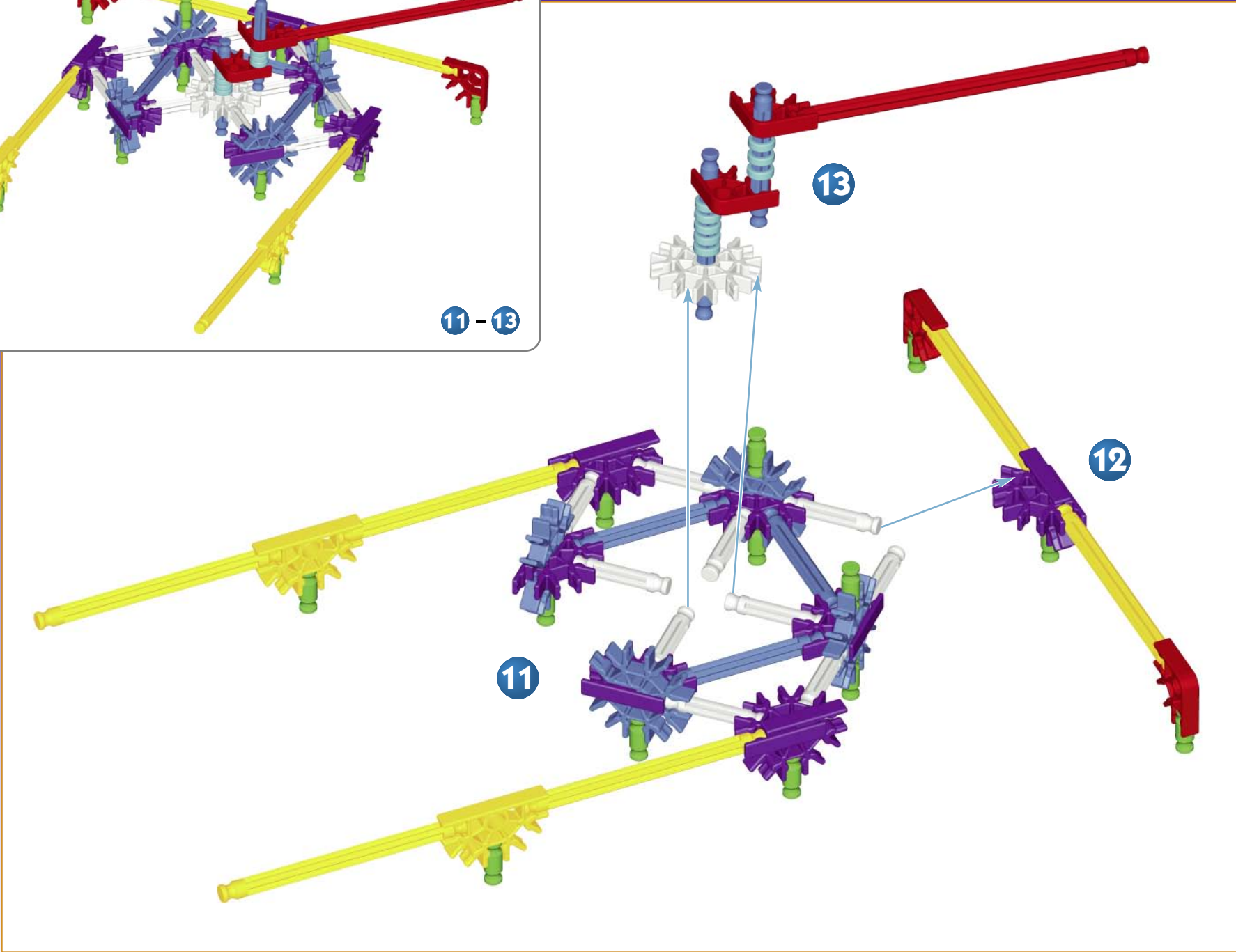
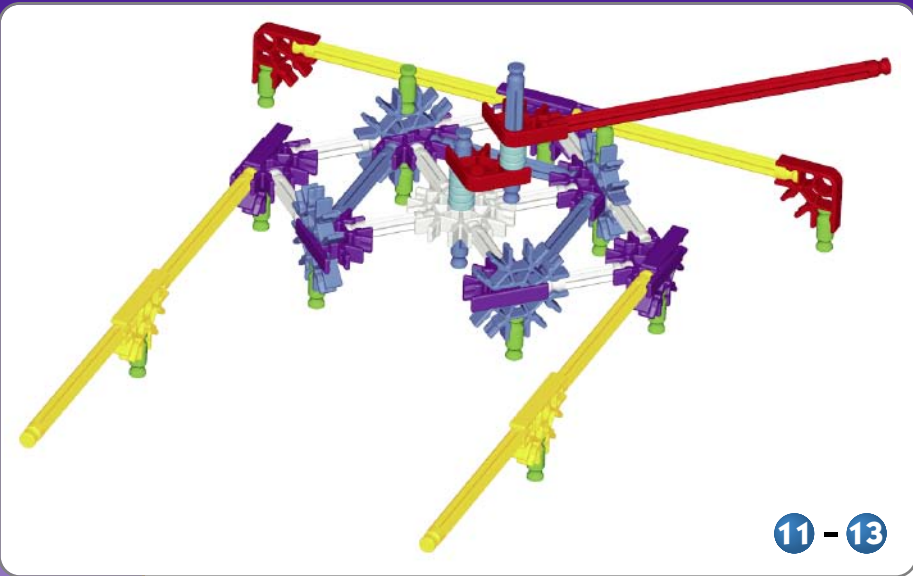

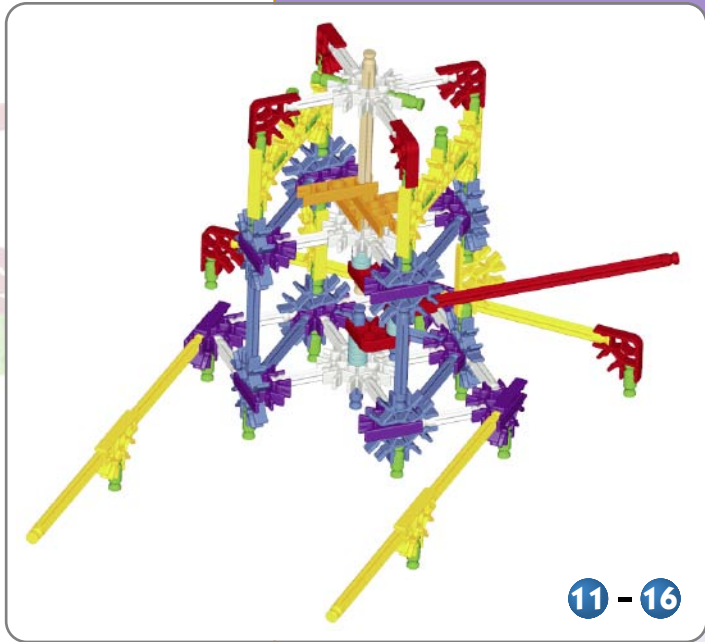
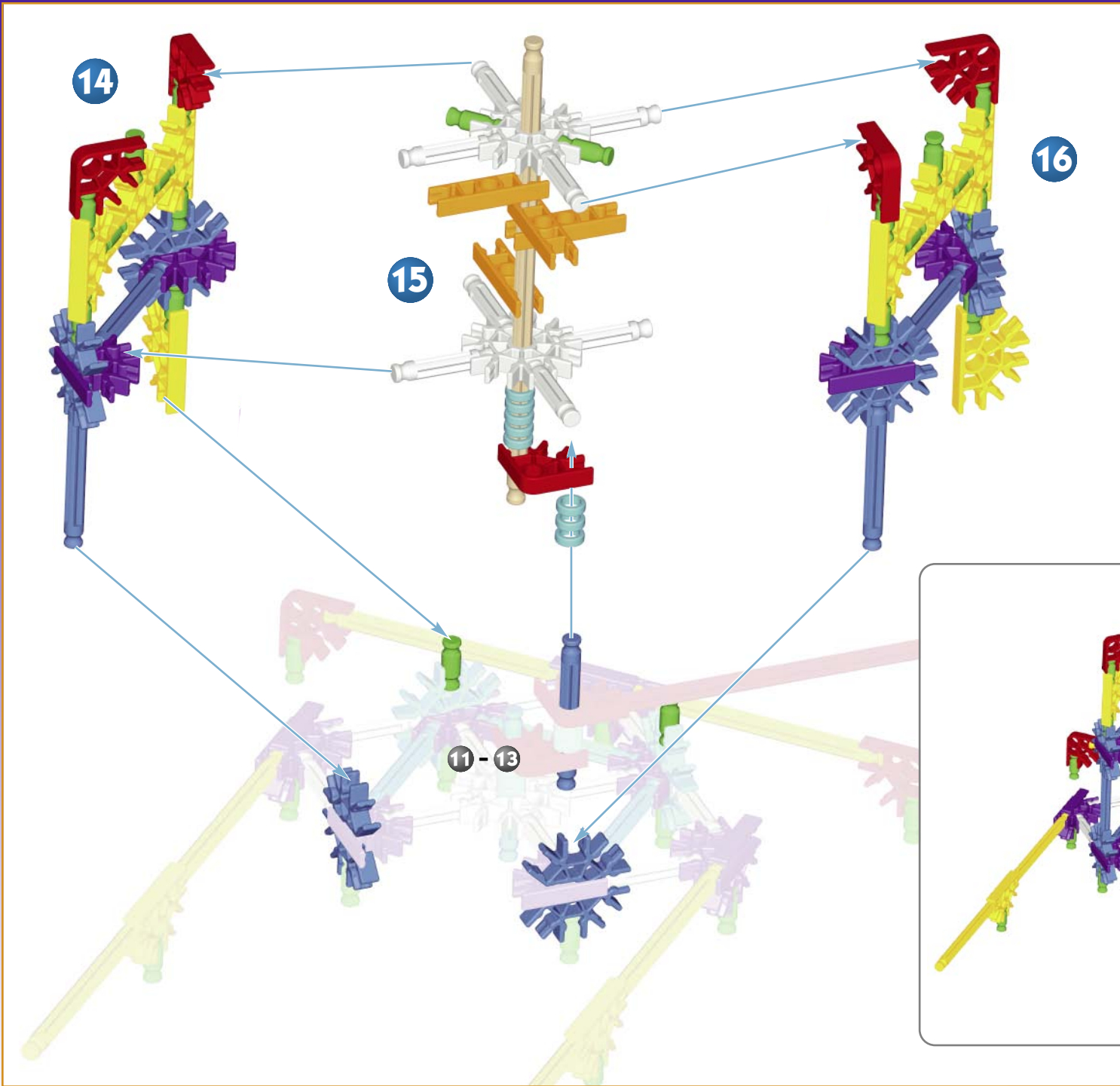

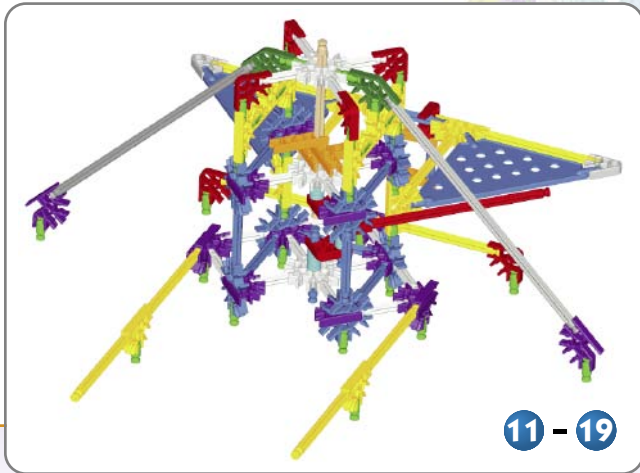
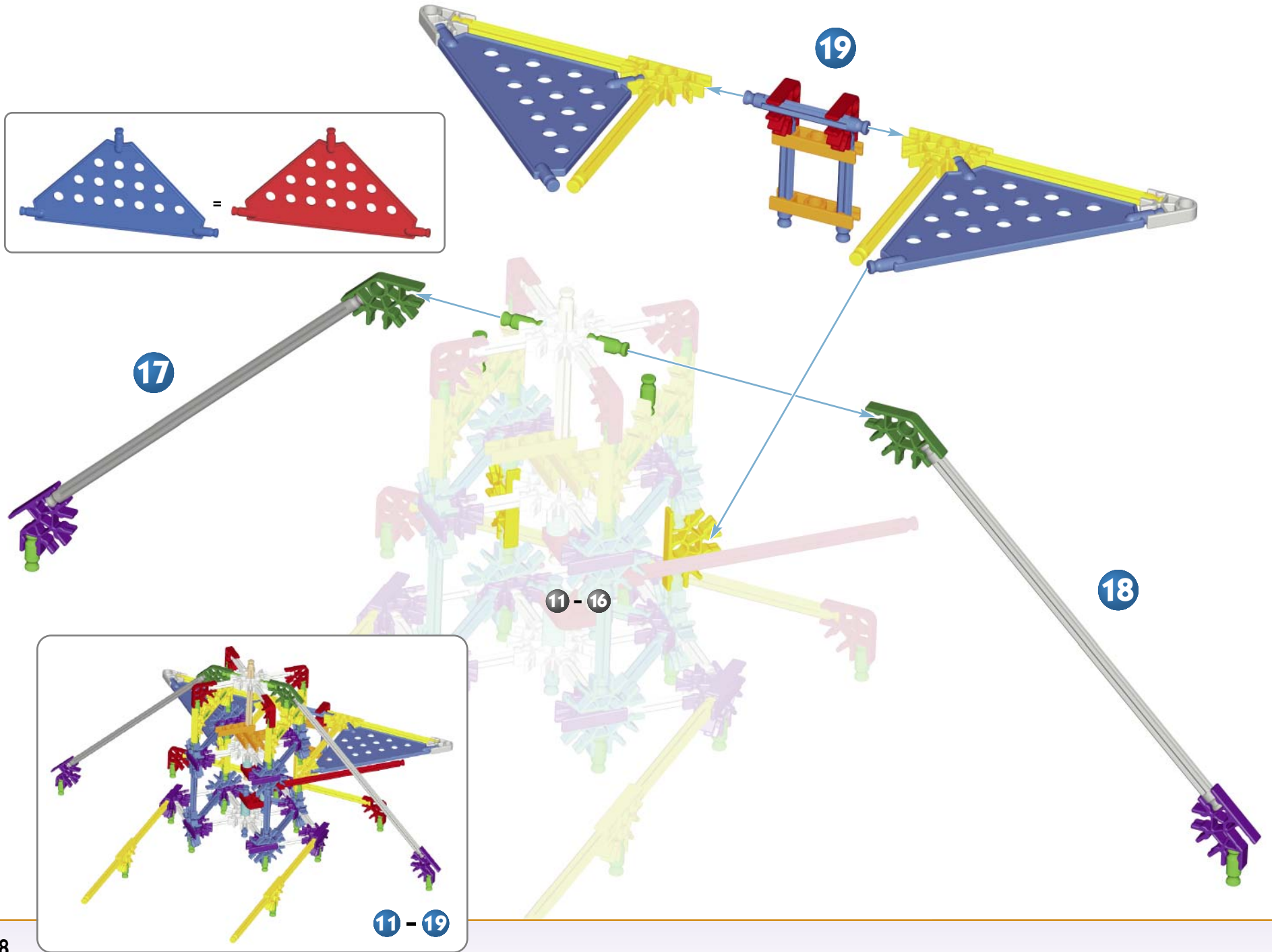
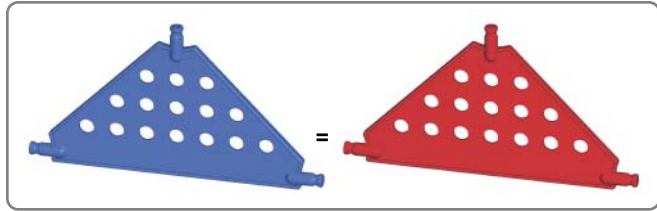

x4

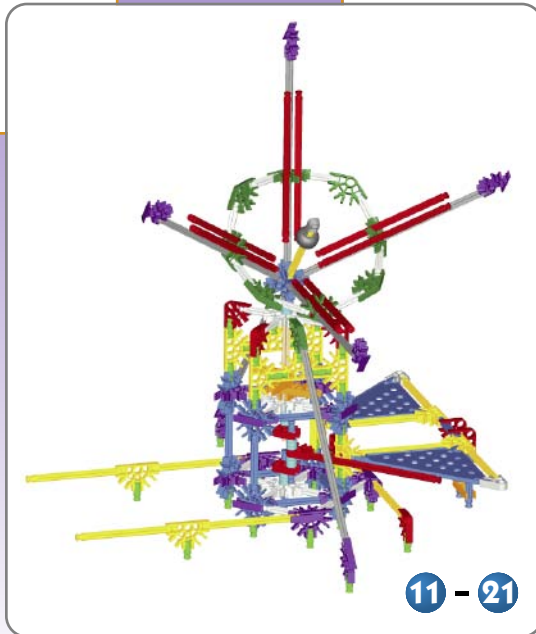
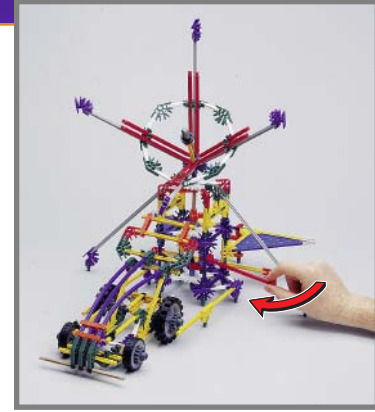
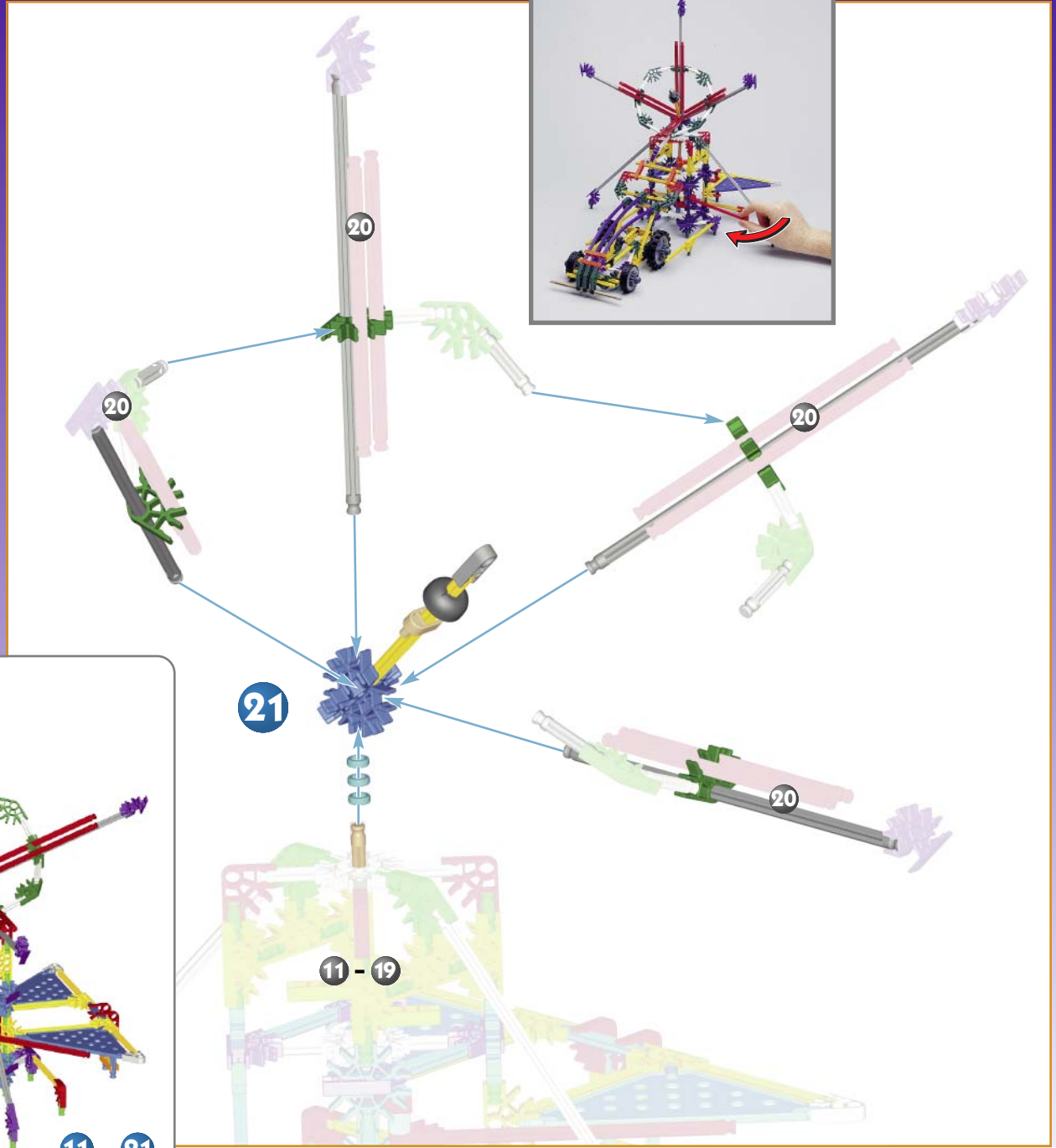
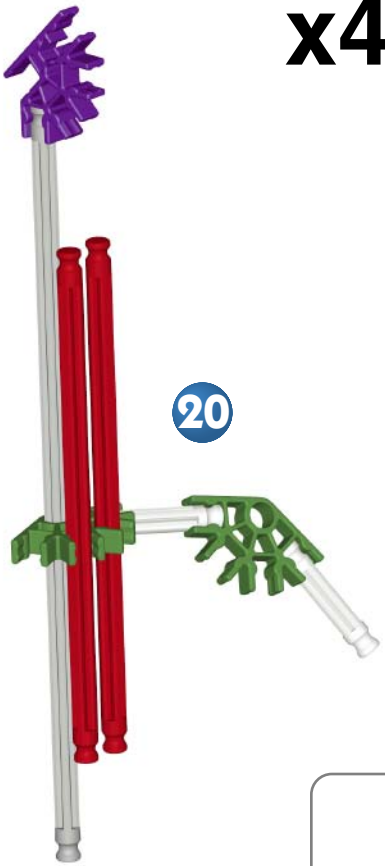

Cherry Picker

La nacelle élévatrice

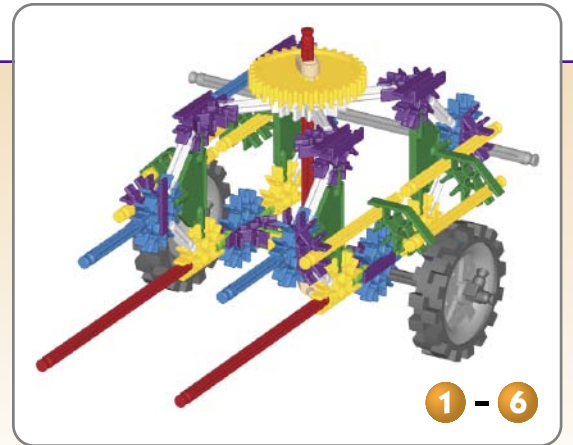
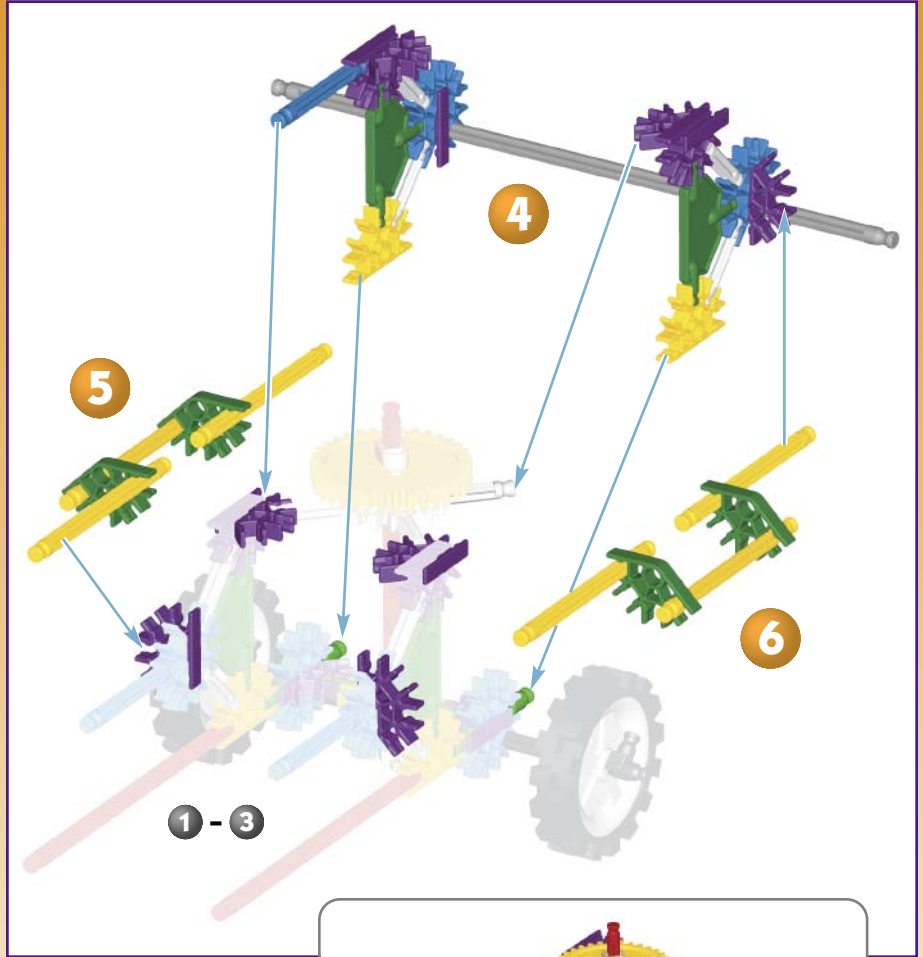
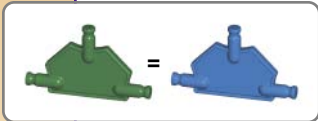
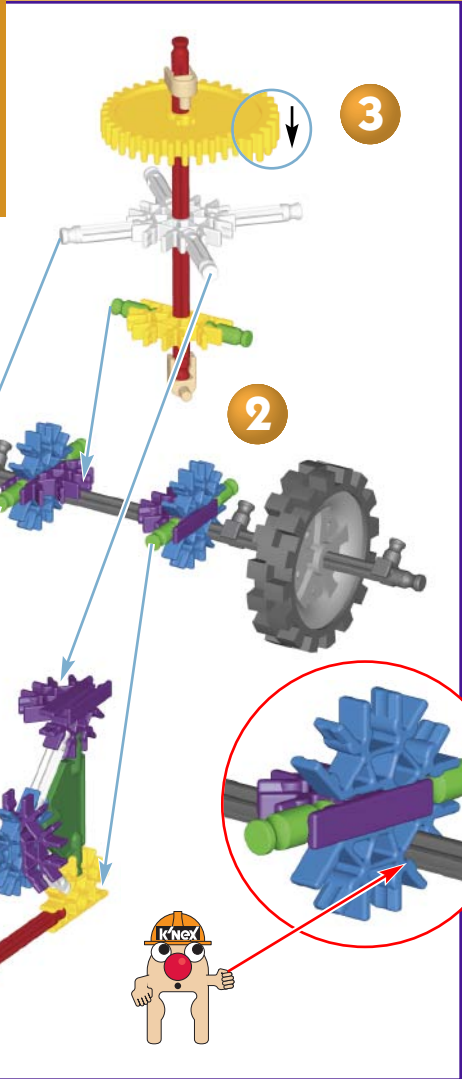

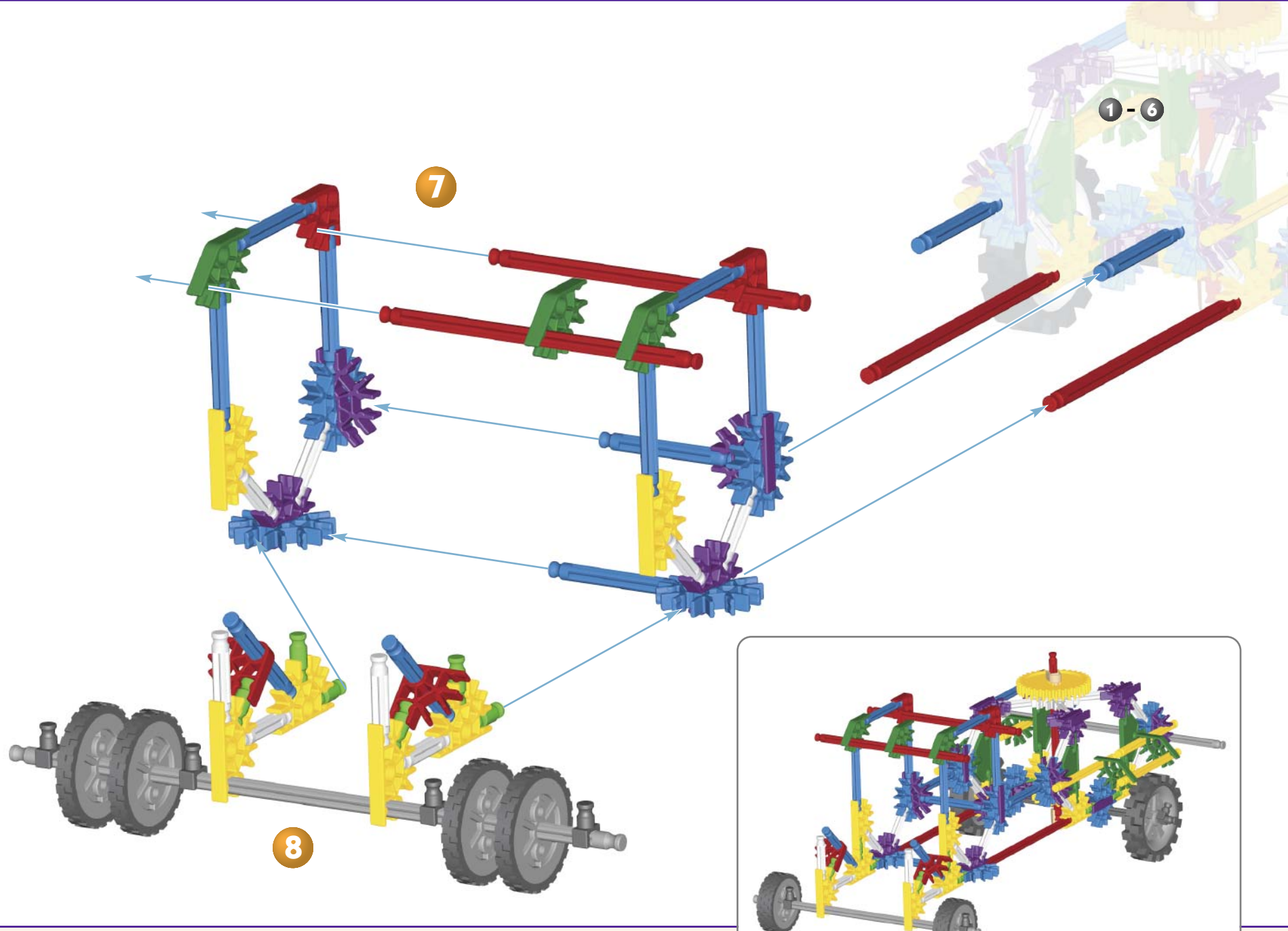

1 - 6

7

8

1 - 8

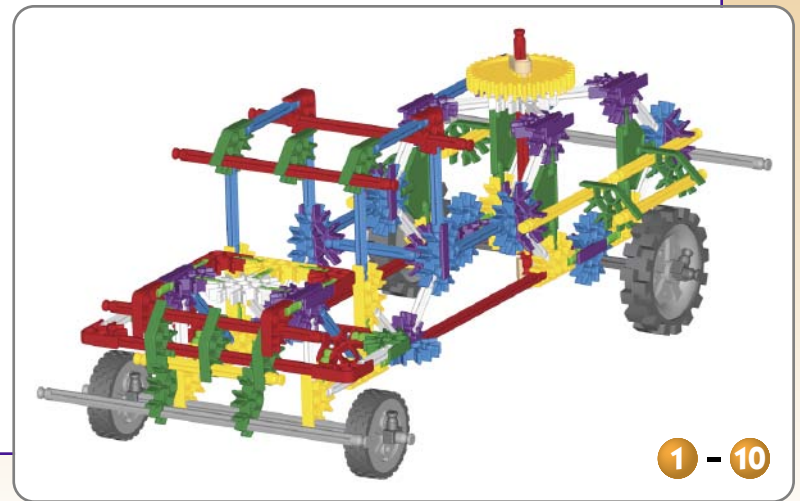
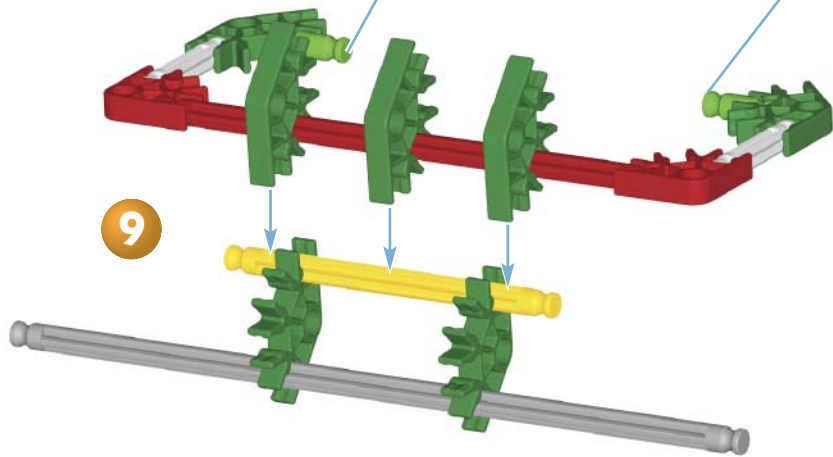
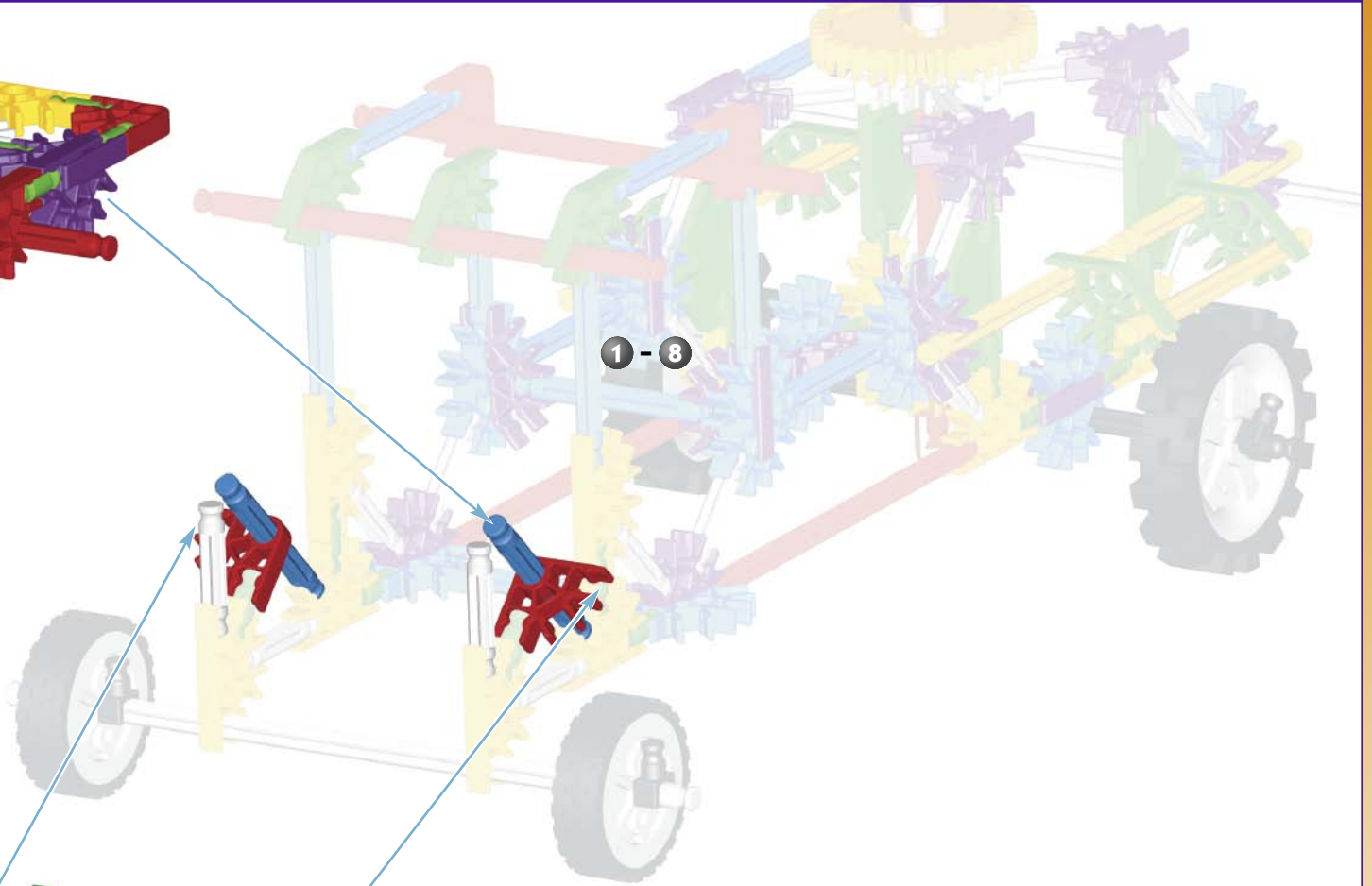
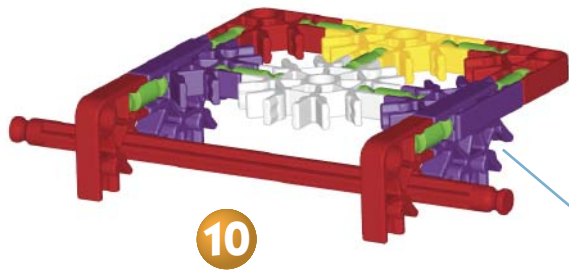

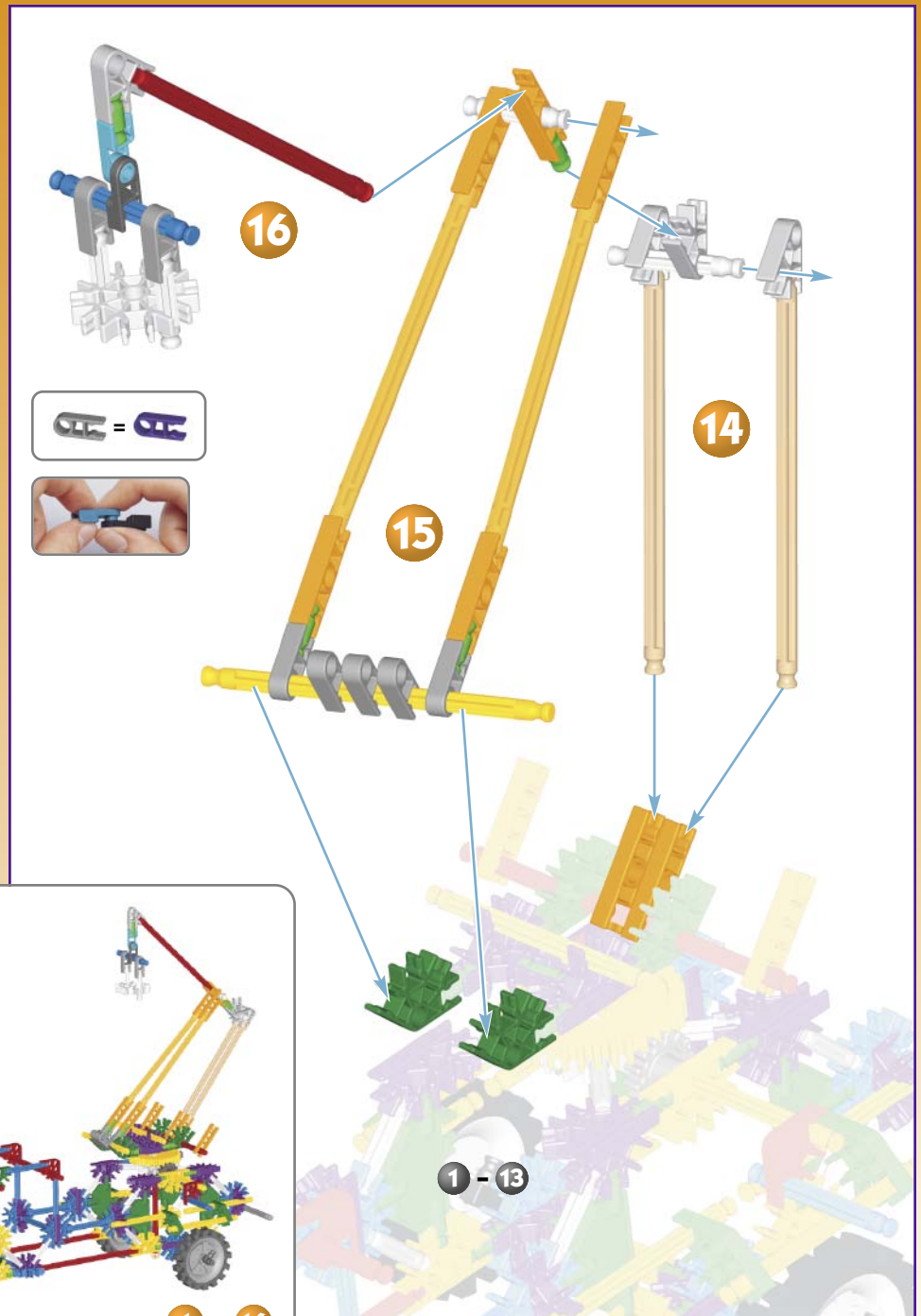
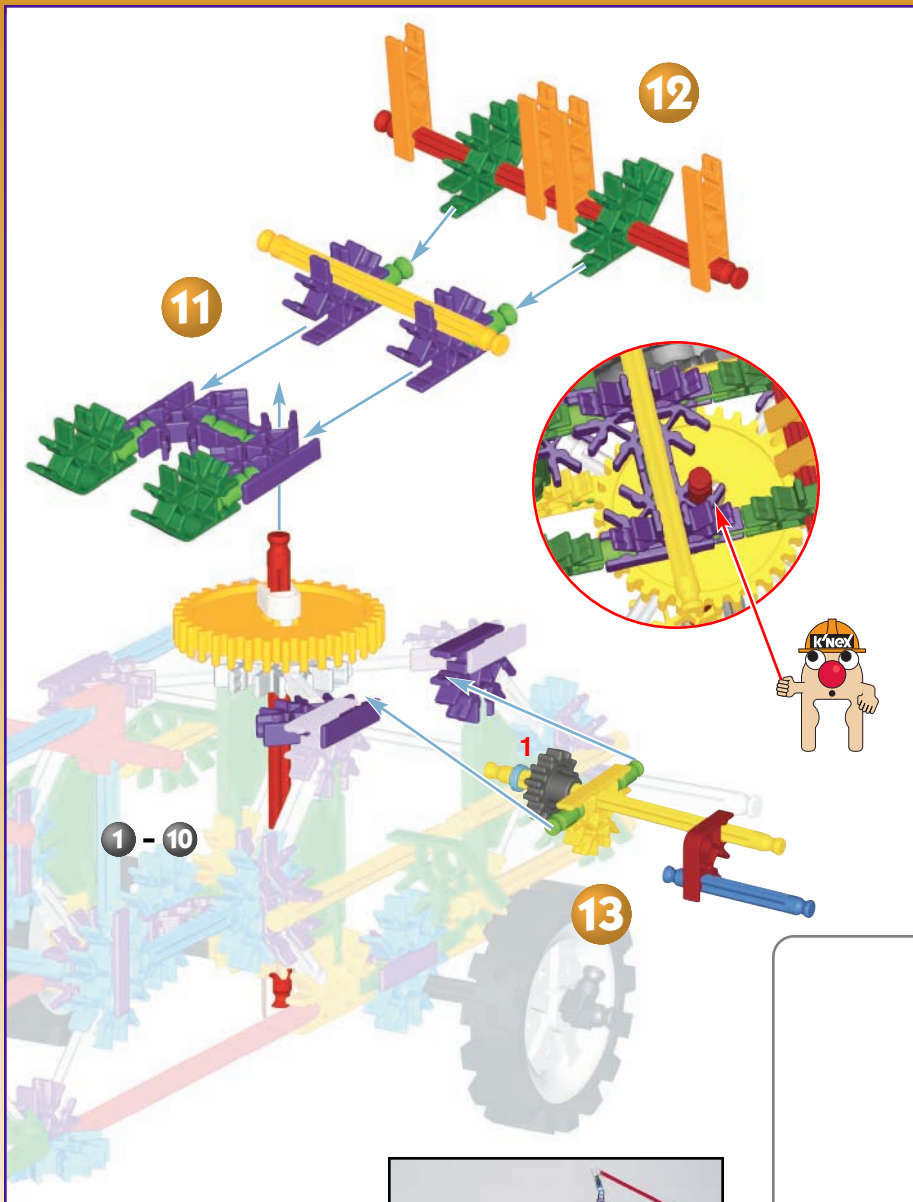

Dragon Dragon

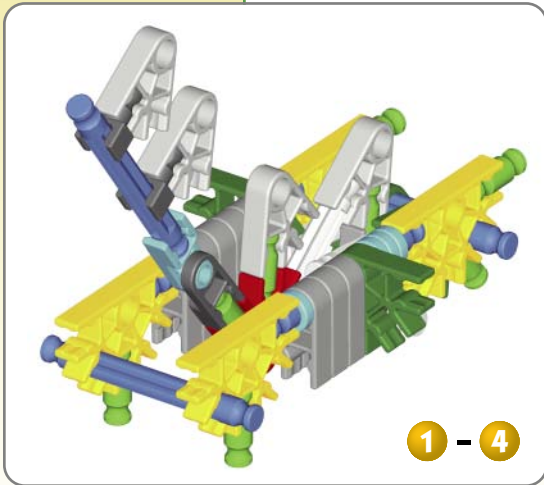
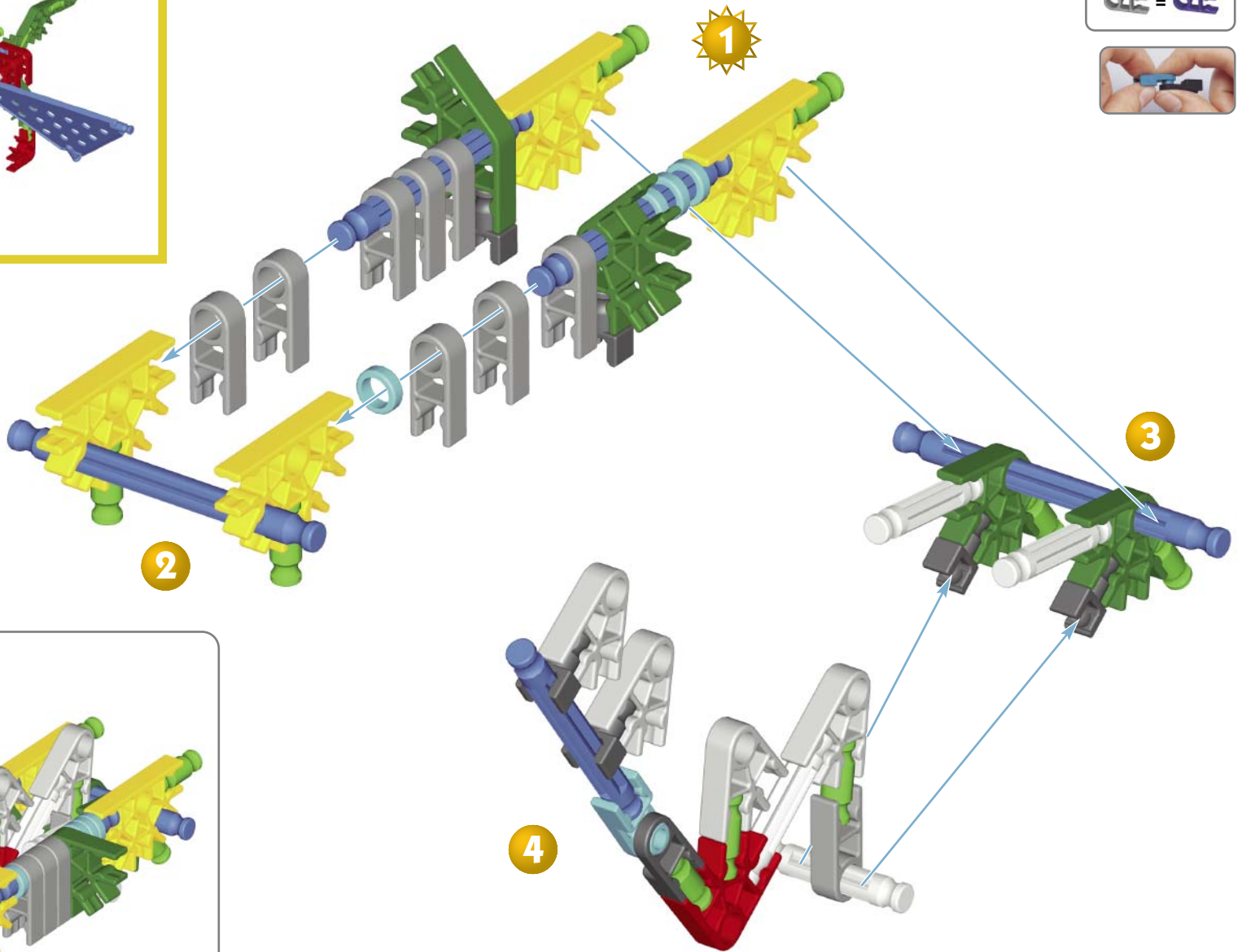
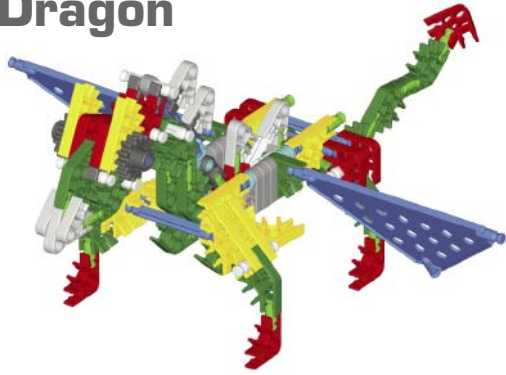

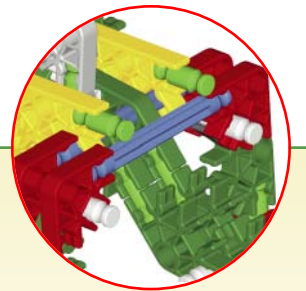
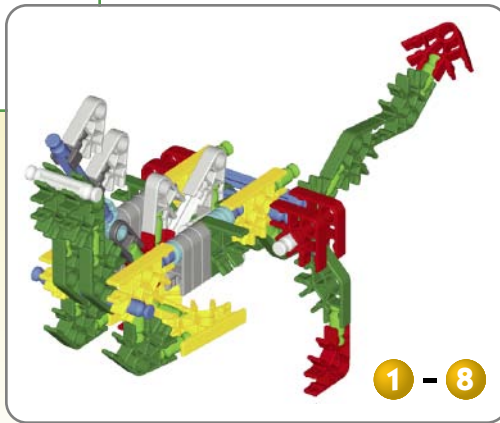
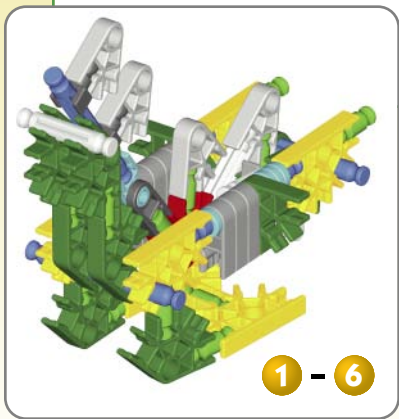
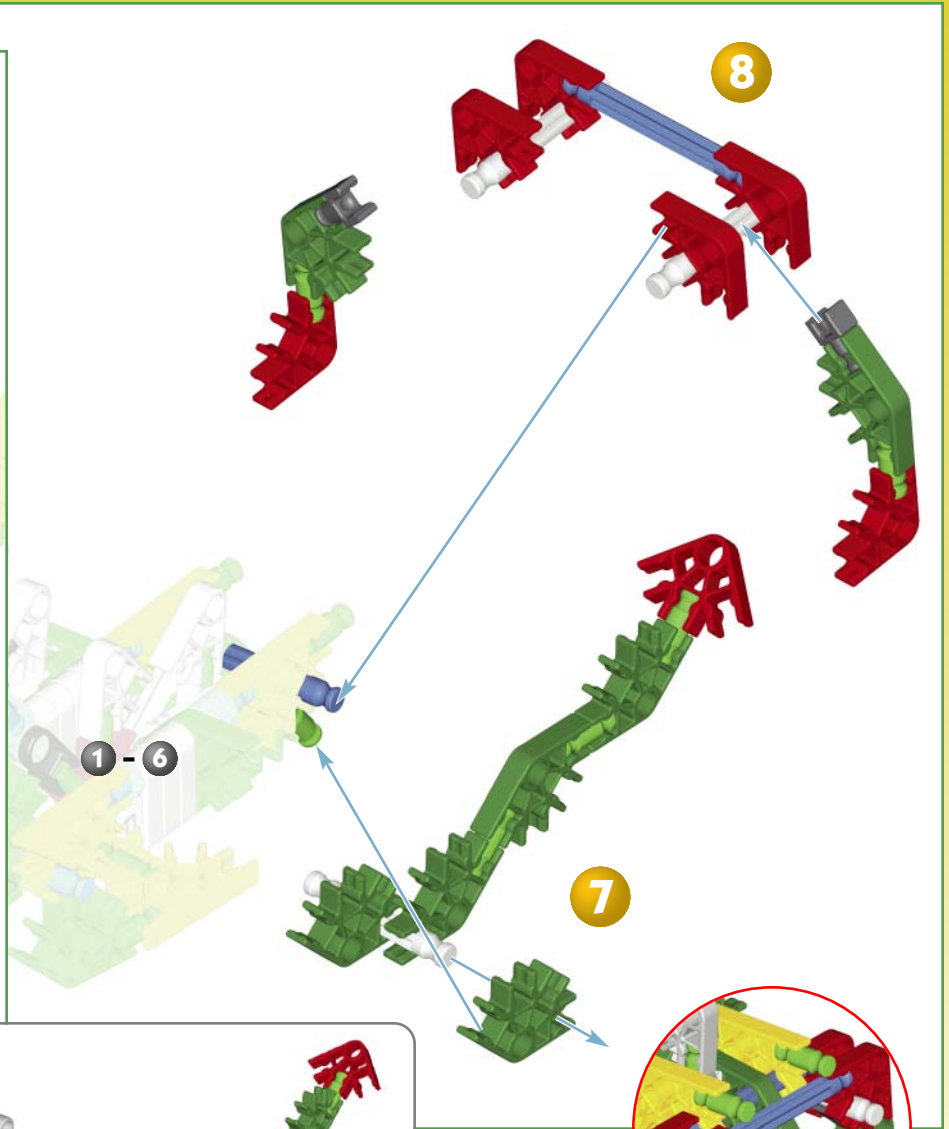
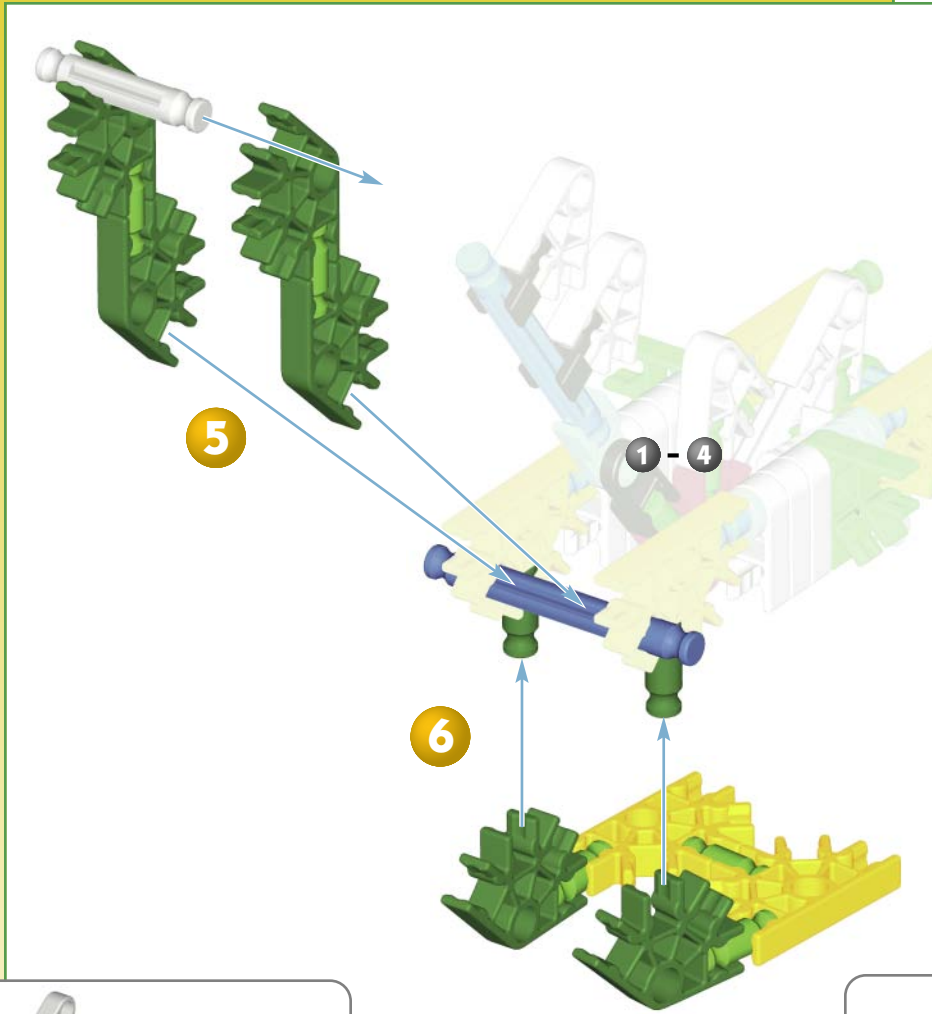

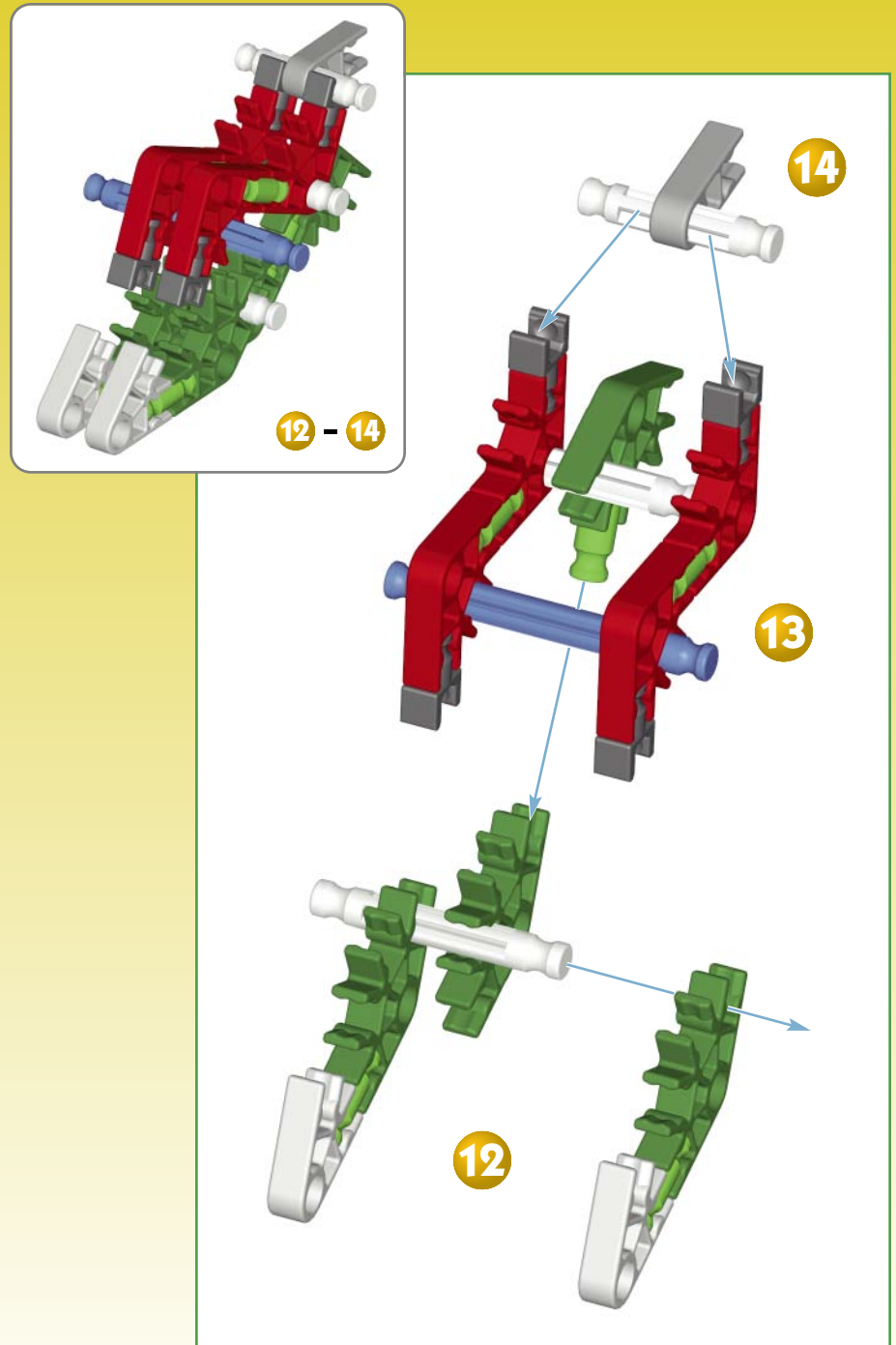
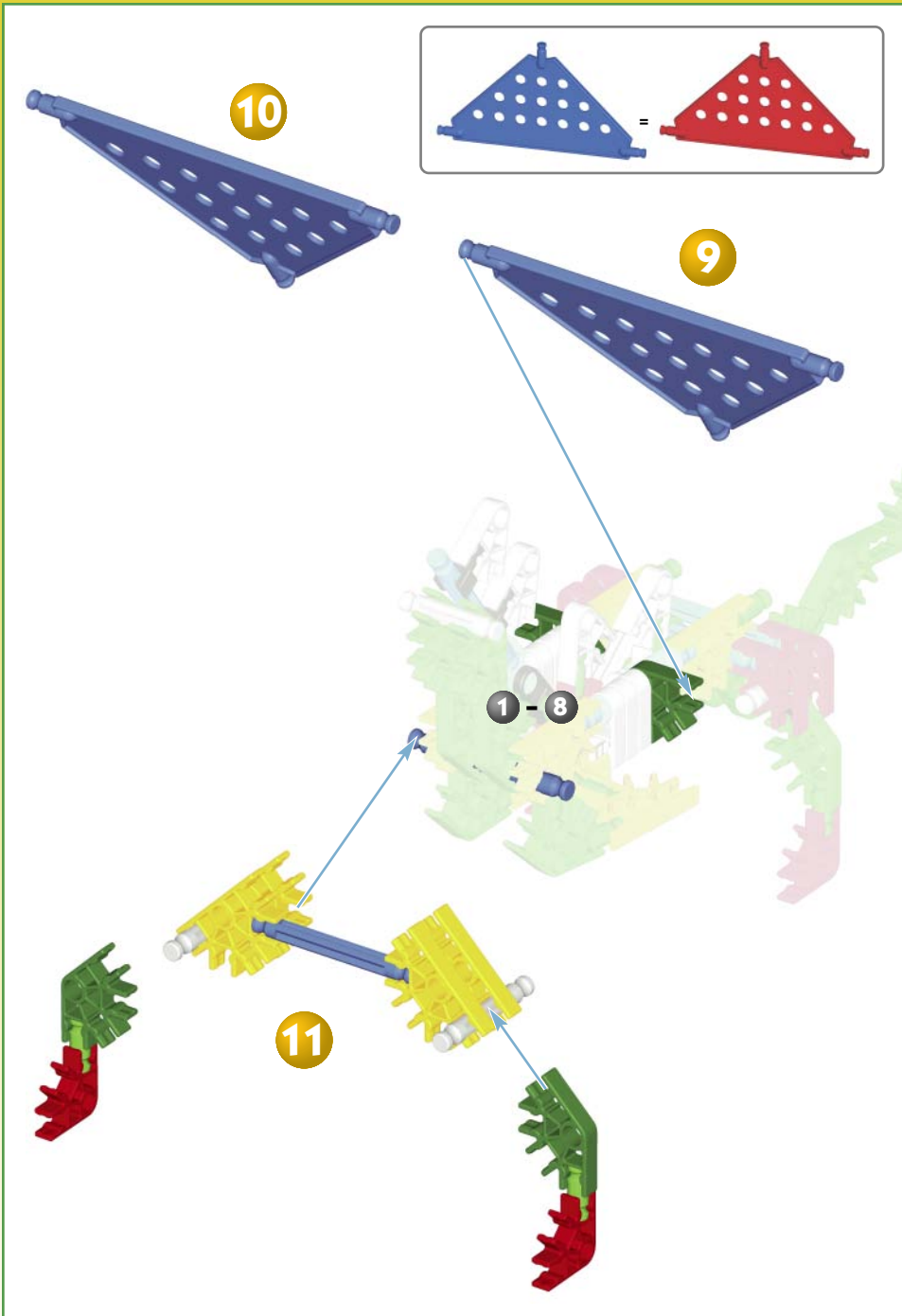

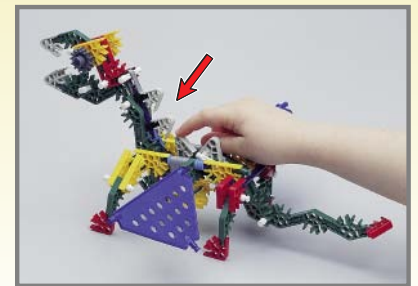
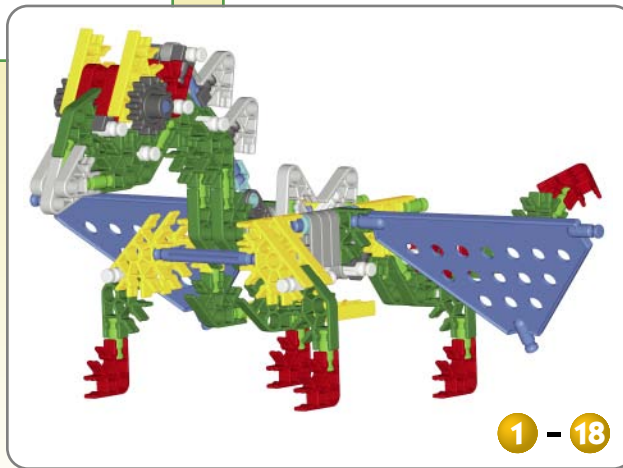
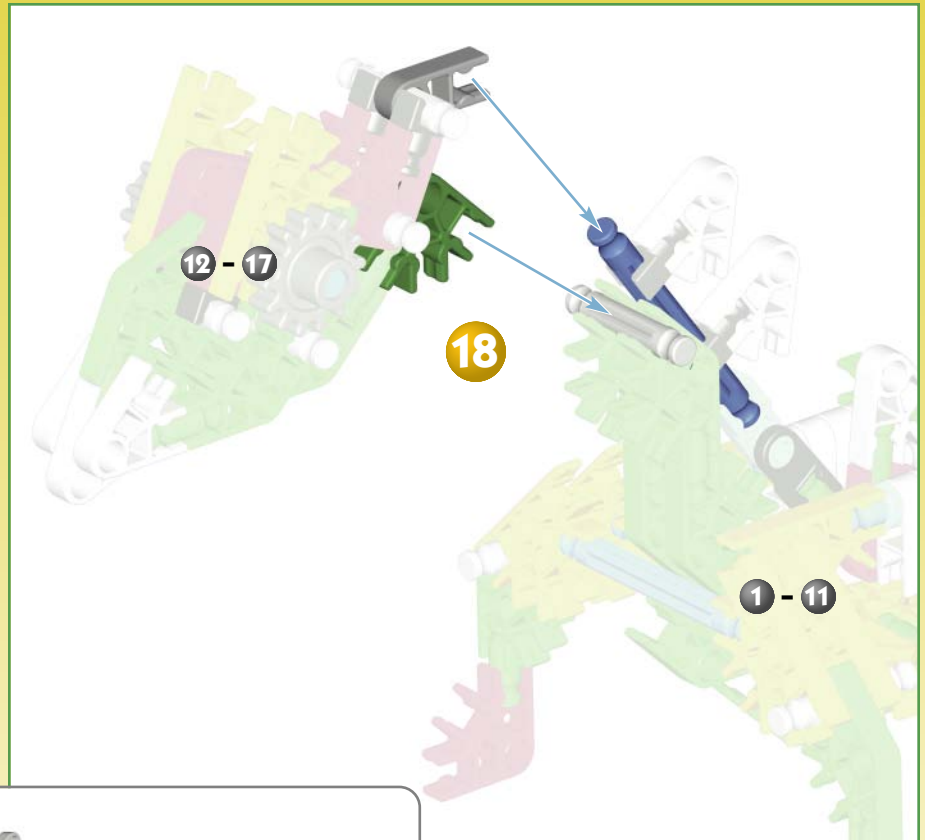
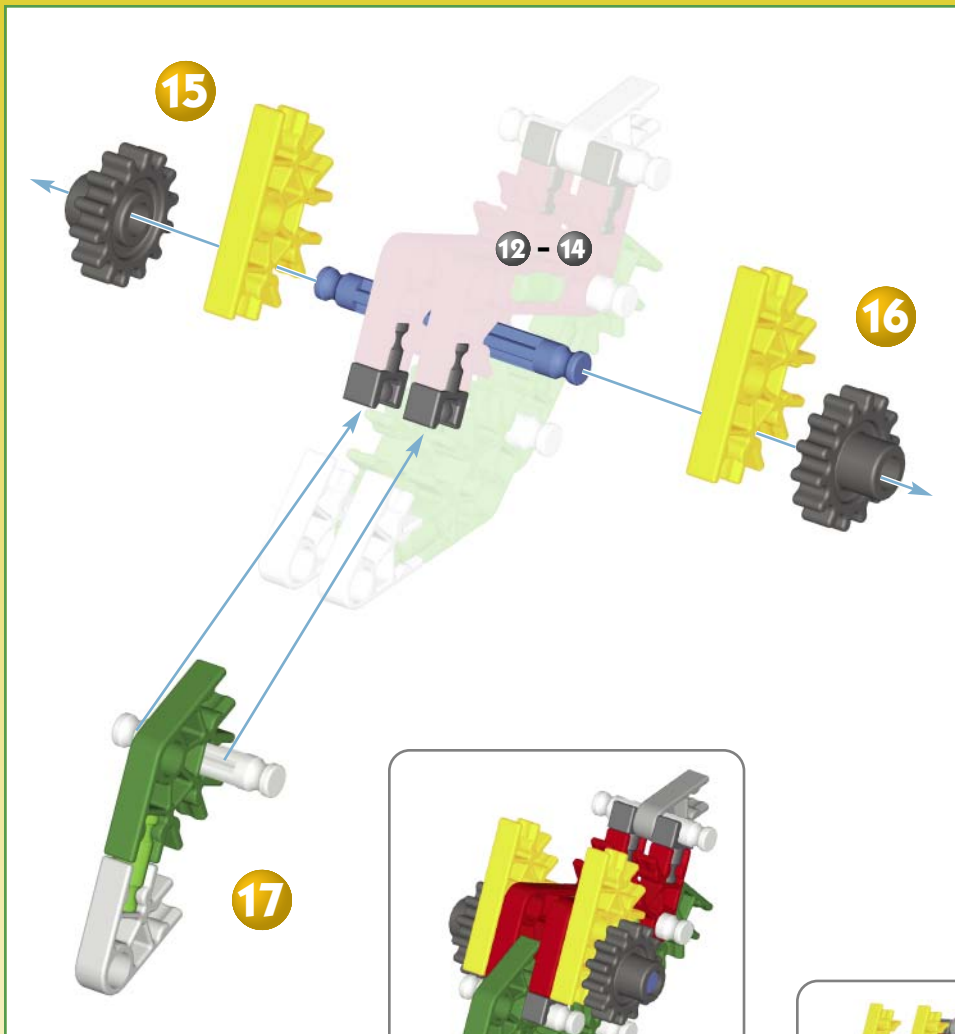

Space Shuttle

Navette spatiale

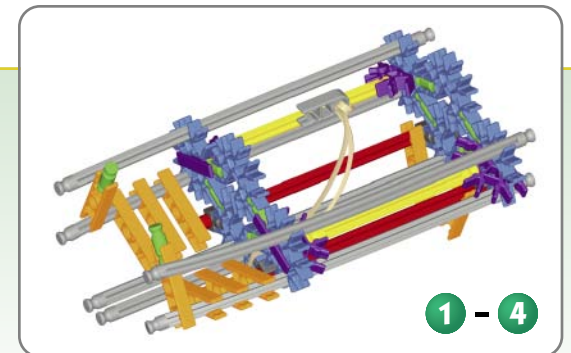
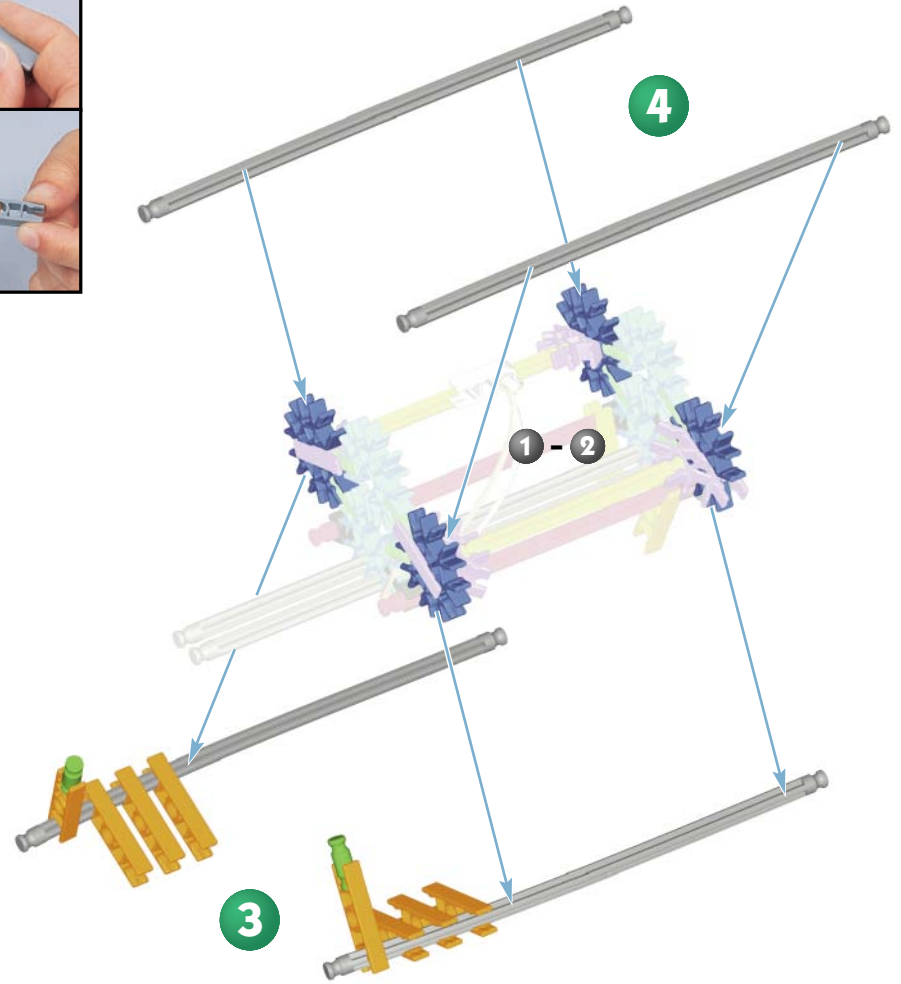
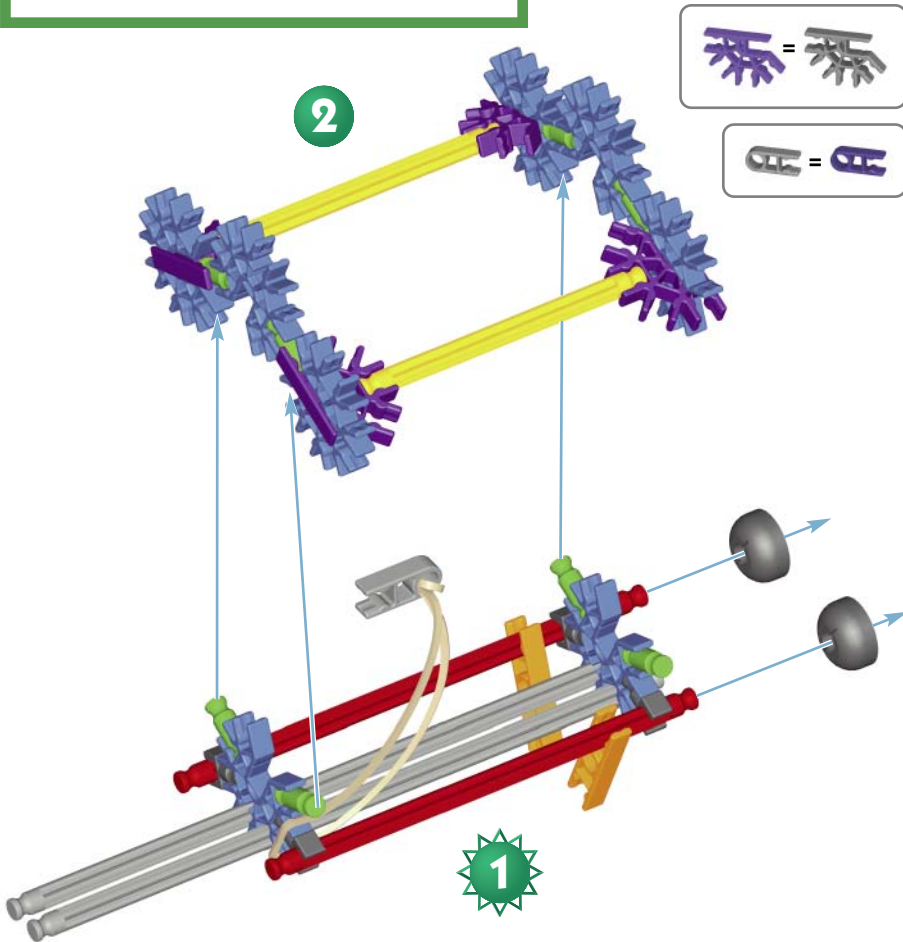
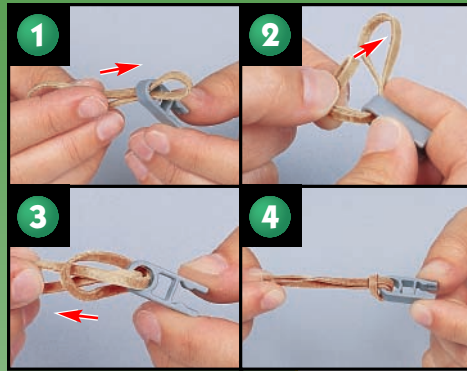
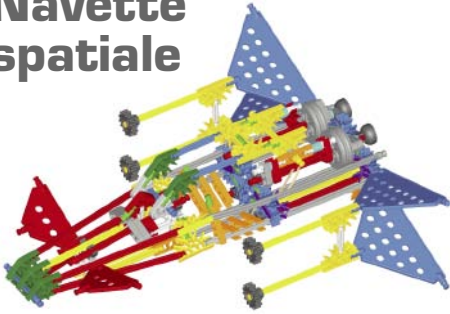

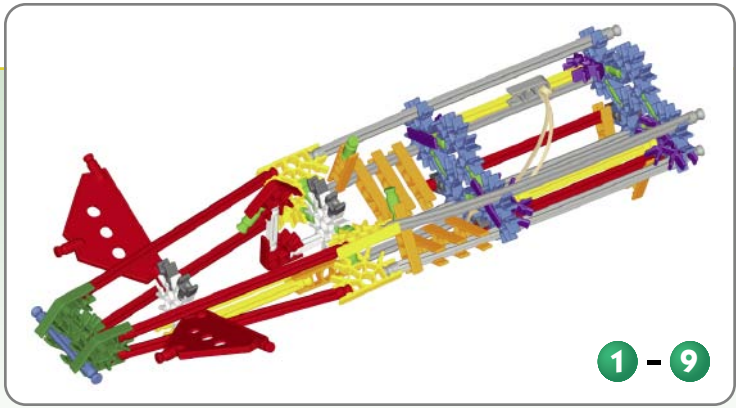
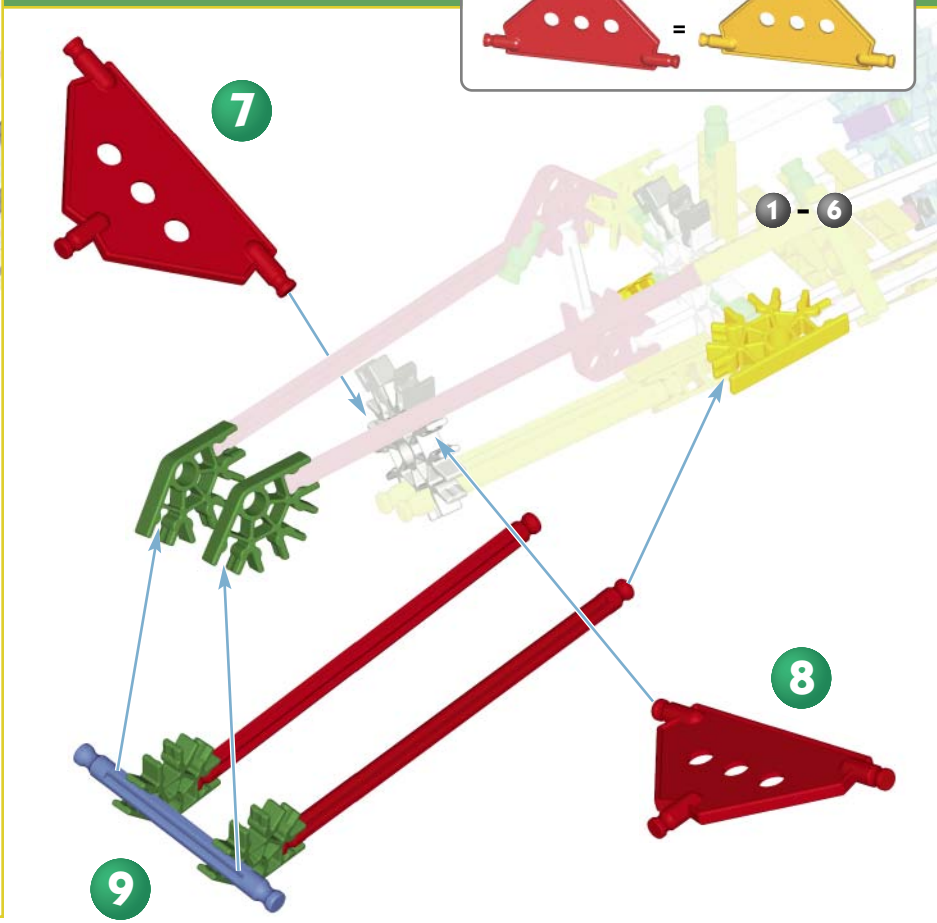
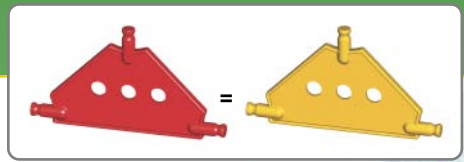
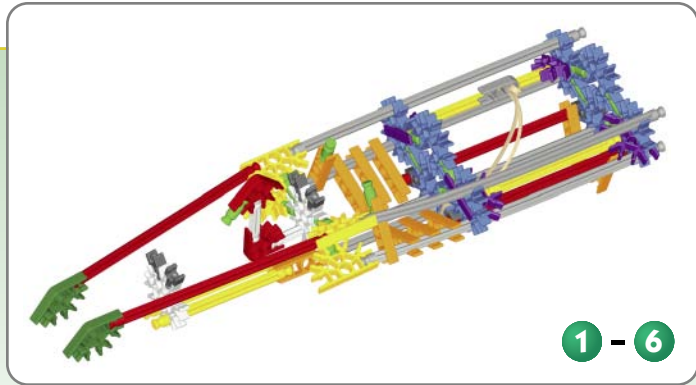
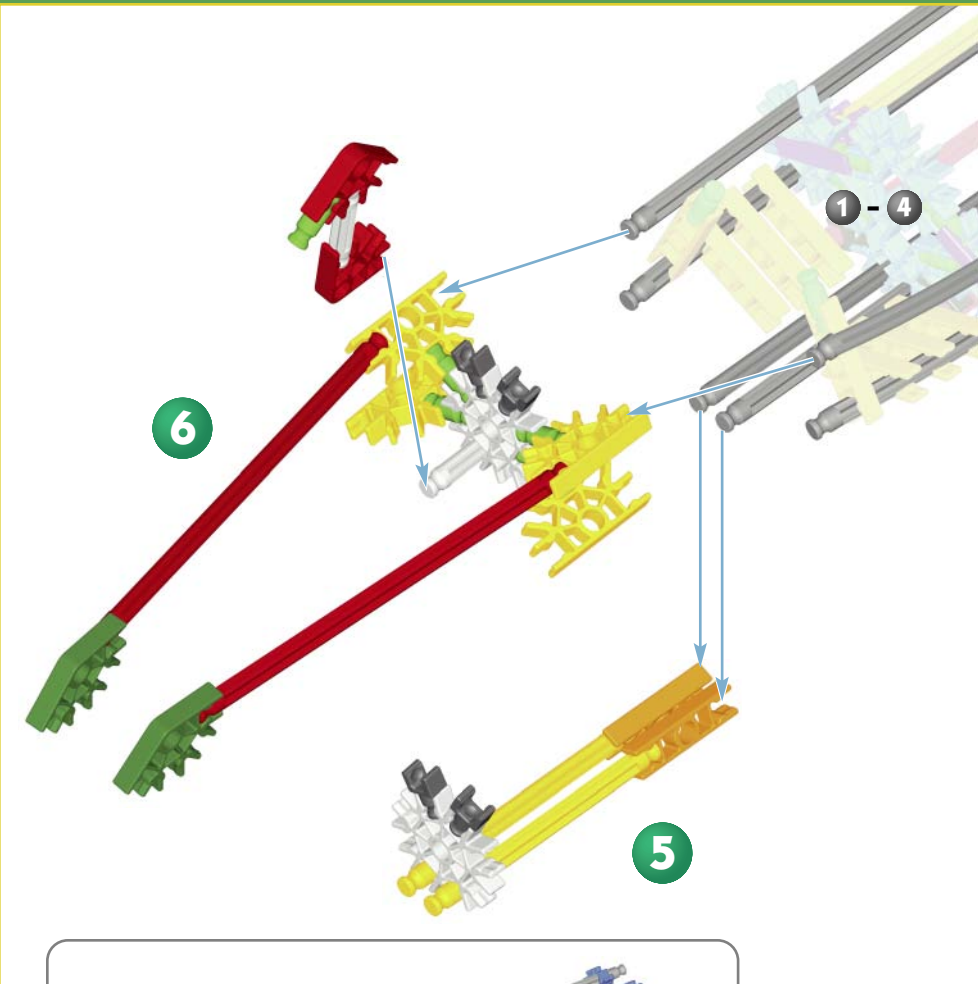

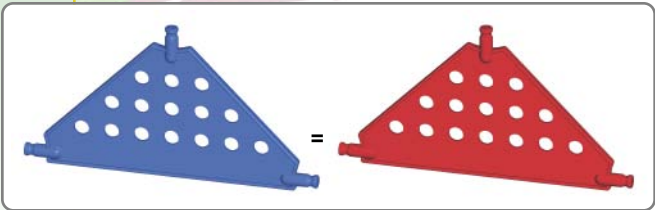
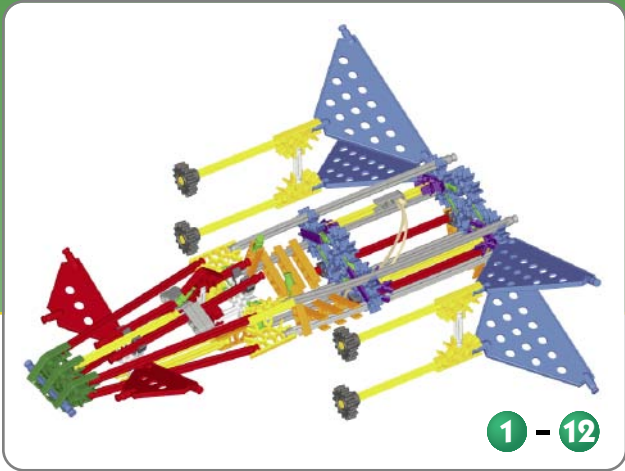
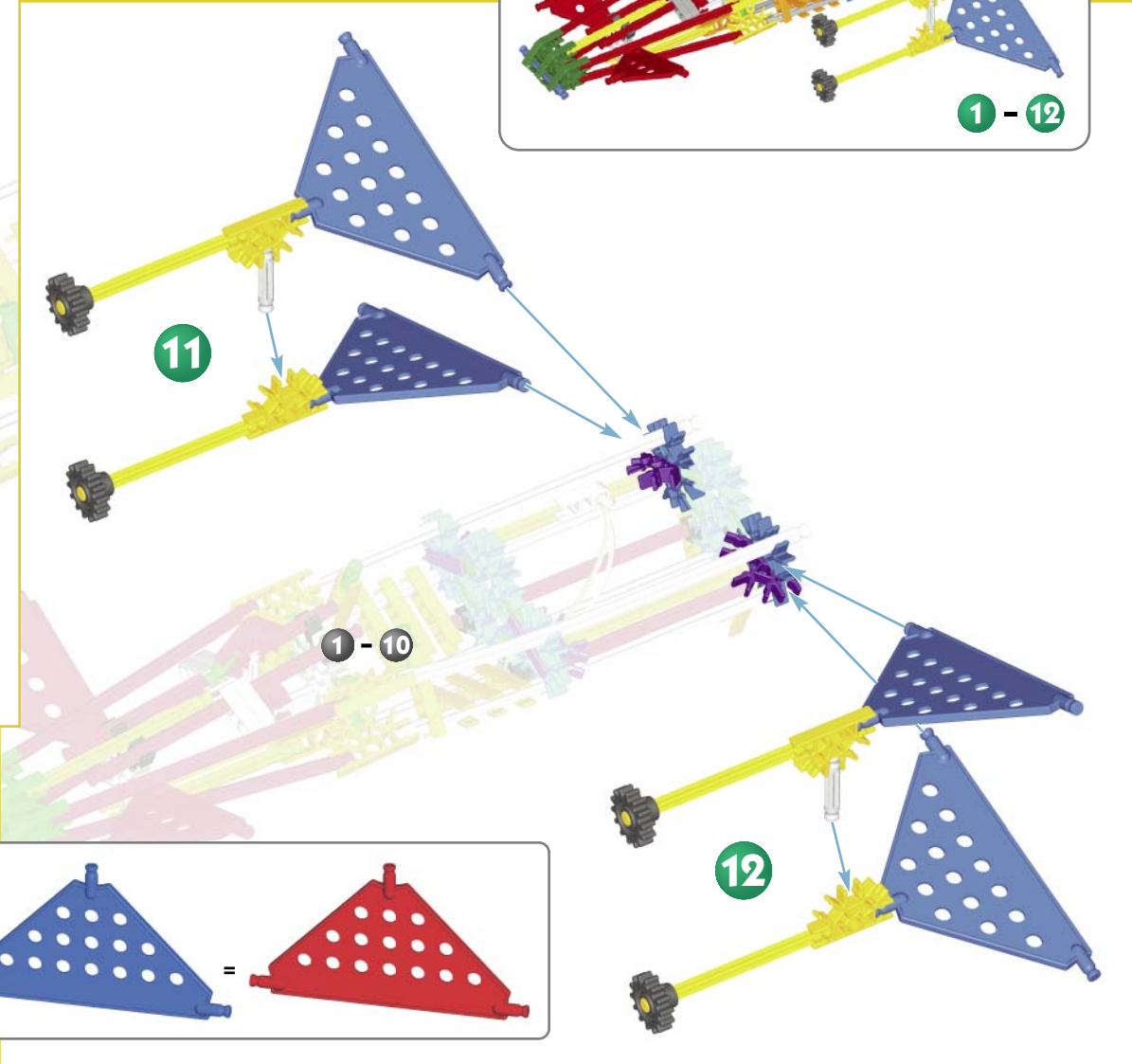
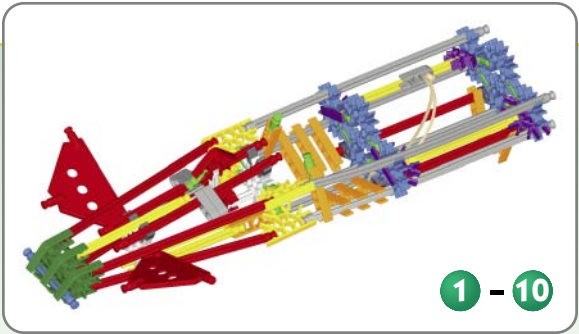
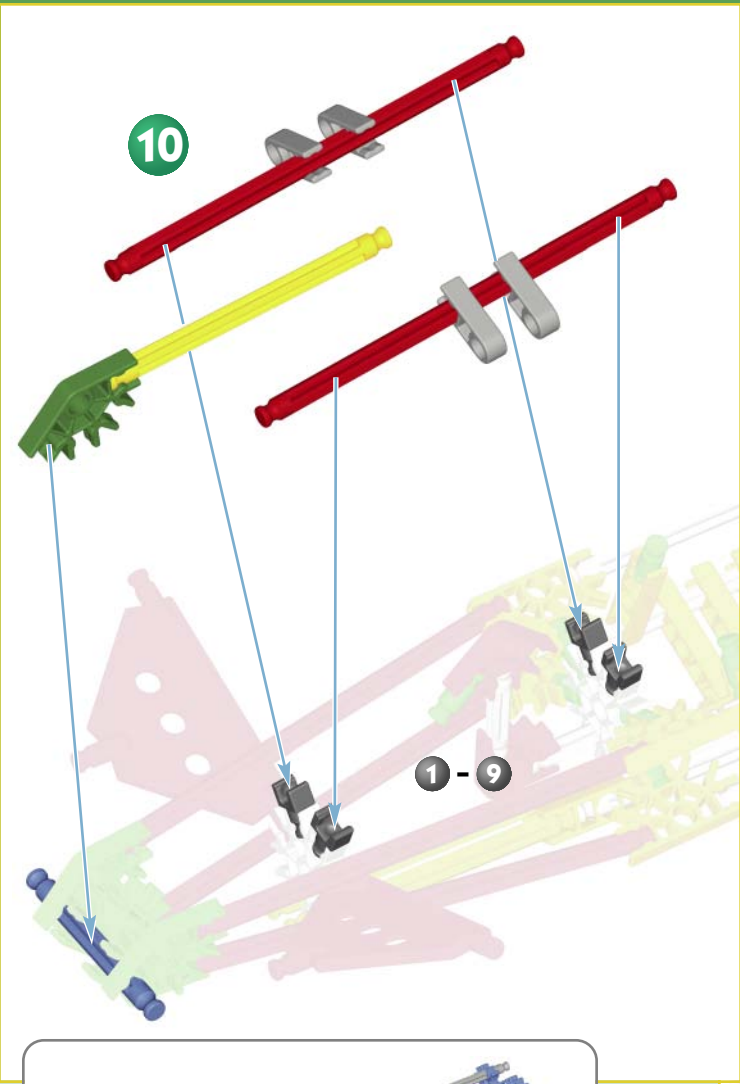

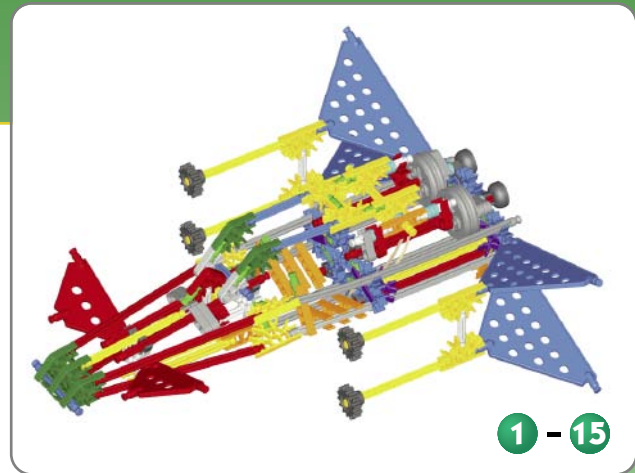
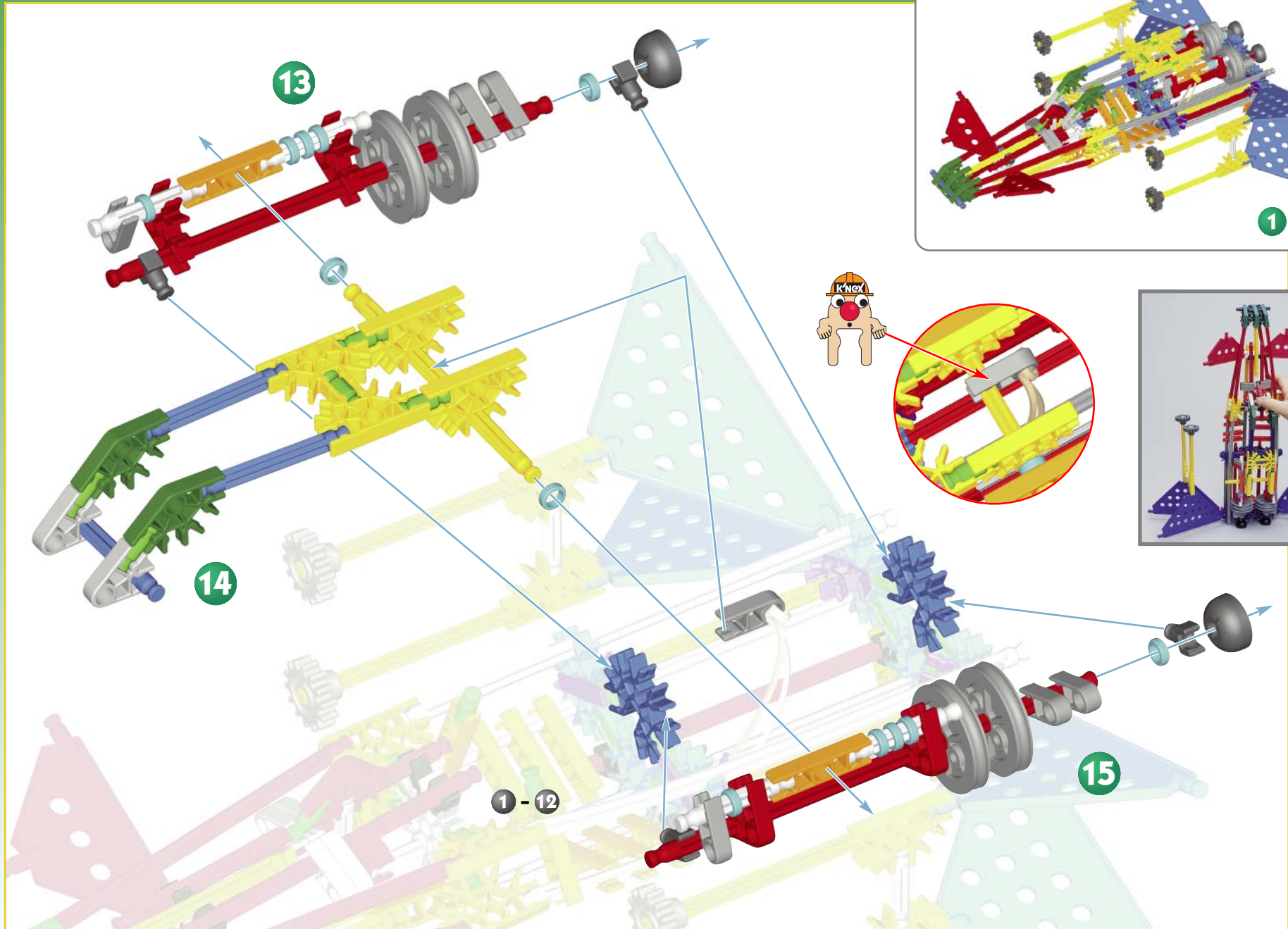

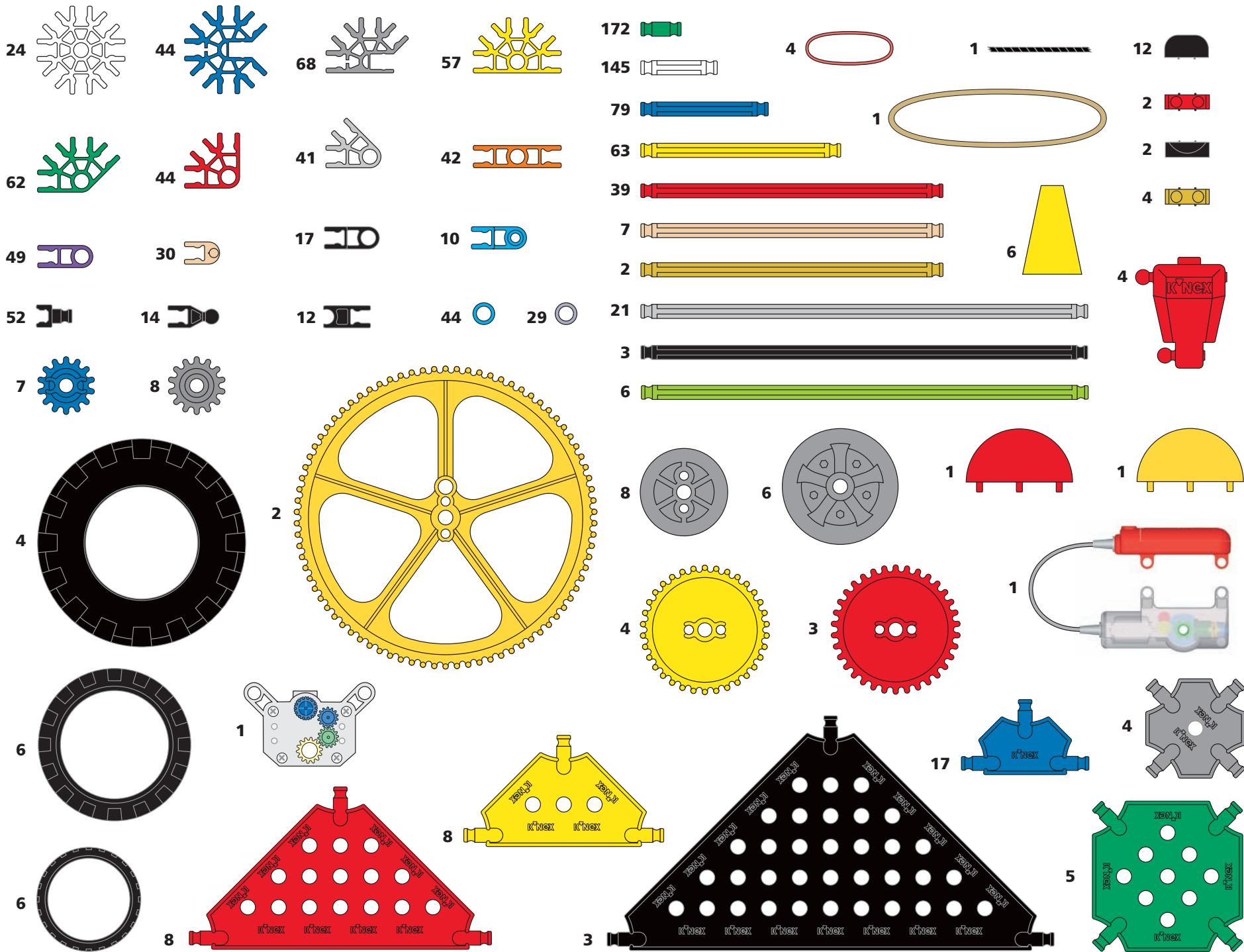

KNEXeducation.com

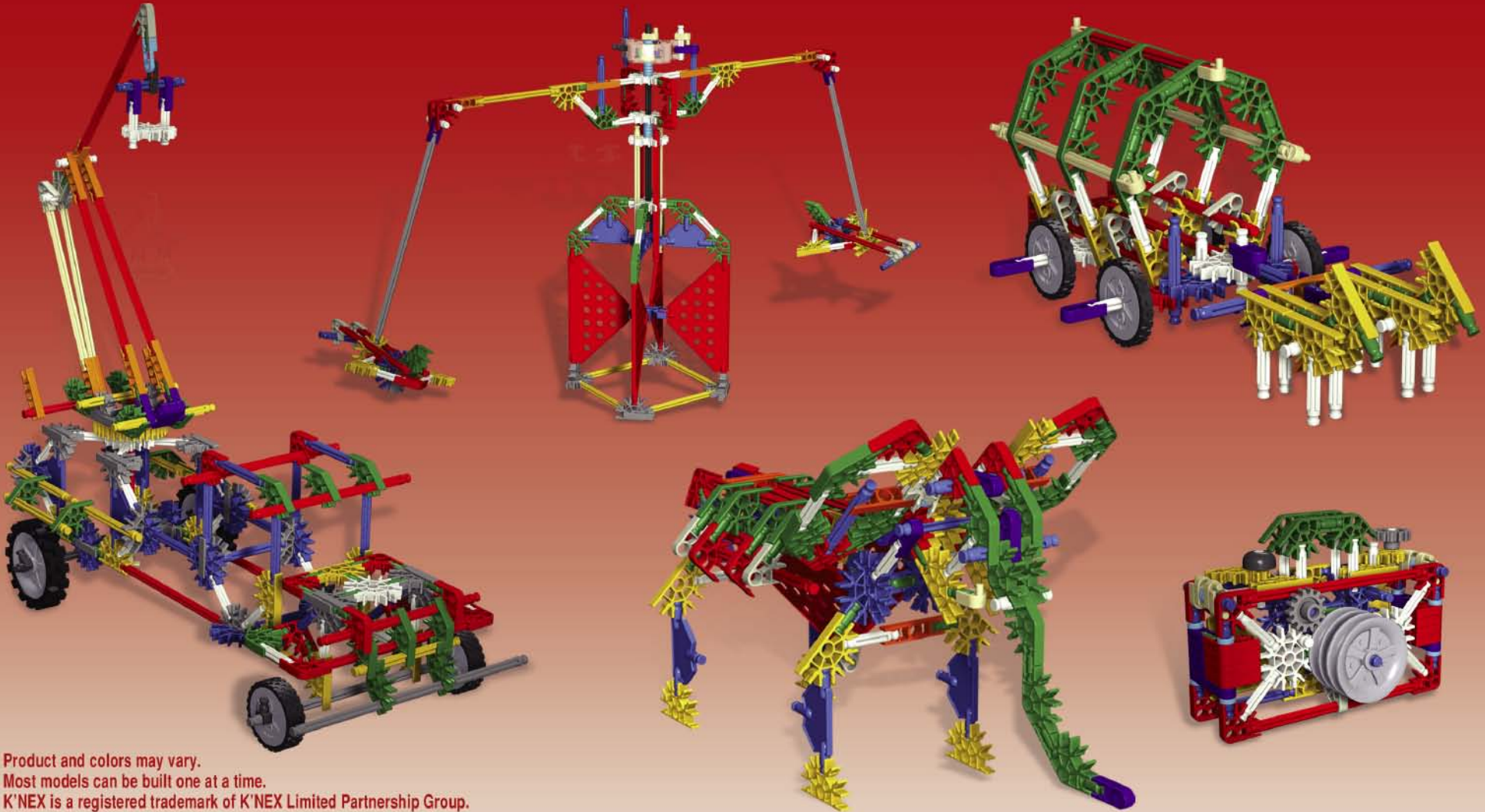

Product and colors may vary.
Most models can be built one at a time.
K'NEX is a registered trademark of K'NEX Limited Partnership Group.

Le produit et les couleurs peuvent varier.
La plupart des modèles ne peuvent être construits que un à un.
K'NEX est une marques déposée de K'NEX Limited Partnership Group.

El producto y los colores podrán variar.
La mayoría de los modelos se puede construir uno a la vez.
K'NEX es una marcas registrada de K'NEX Limited Partnership Group.

K'NEX Education
P.O. Box 700
Hatfield, PA 19440-0700

Email:
abcknex@knex.com

1-888-ABC-KNEX
USA/Canada (English Only)
001-215-997-7722
UK (English Only)

©2013 K'NEX Limited Partnership Group

17981802-V2-07/13