

78497



PREHISTORIC CREATURES

Hadrosaurid
page 1



K'NEX Rex
page 6

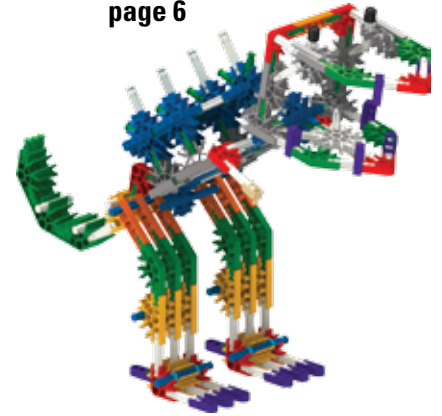

Pterodactyl
page 15



Stegosaurus
page 21

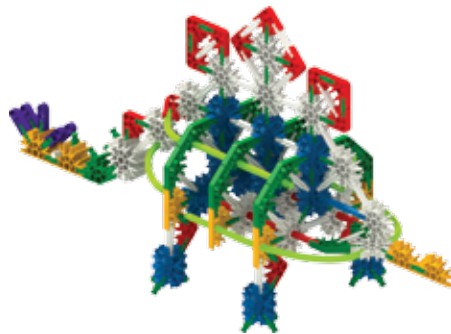

Triceratops
page 30

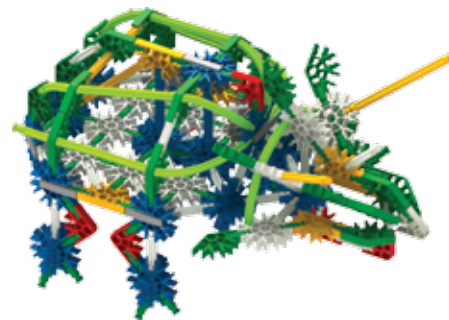

Woolly Mammoth
page 39



Hadrosaurid



1

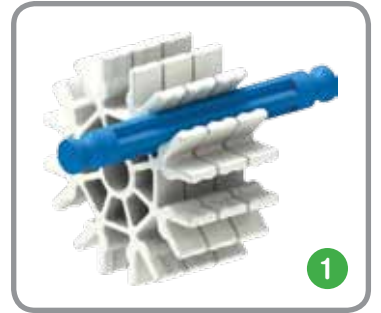
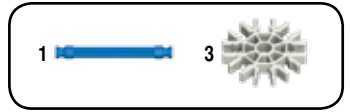
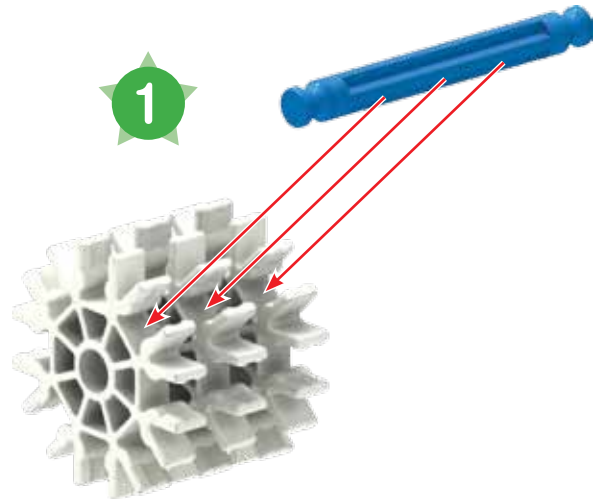



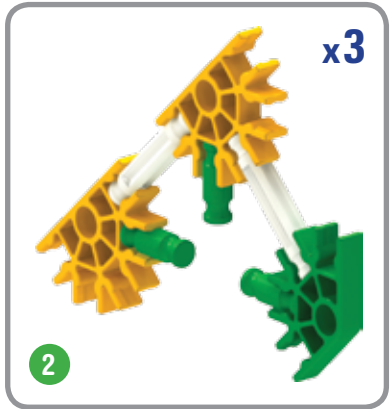
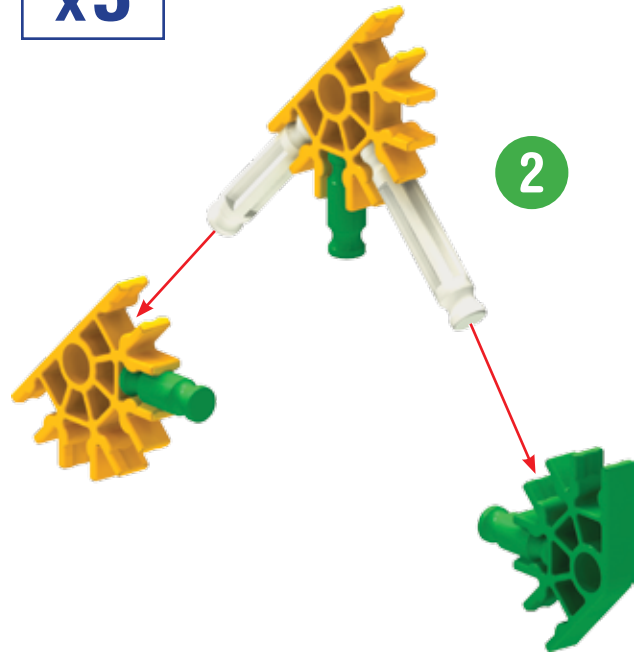

x3

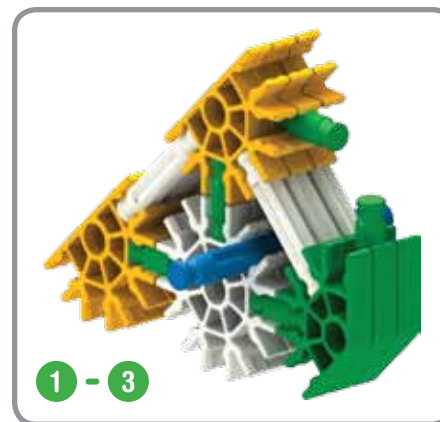
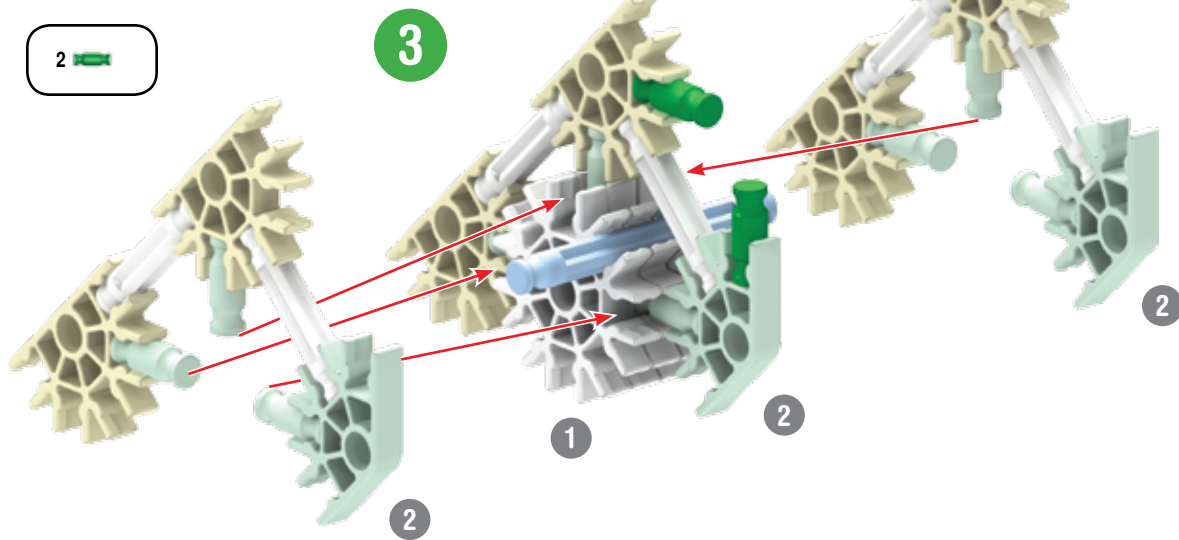

2 



7 
3  3  3 

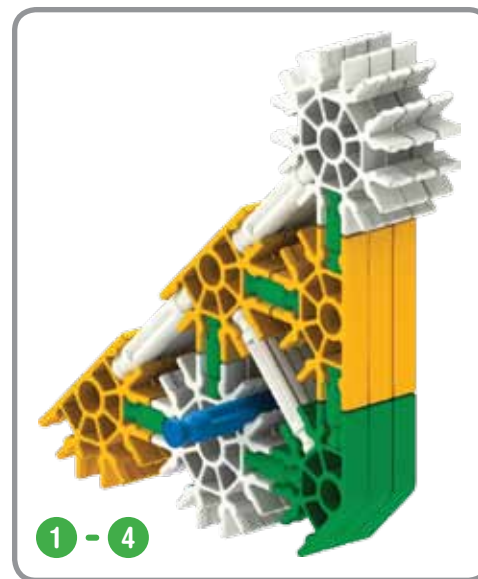
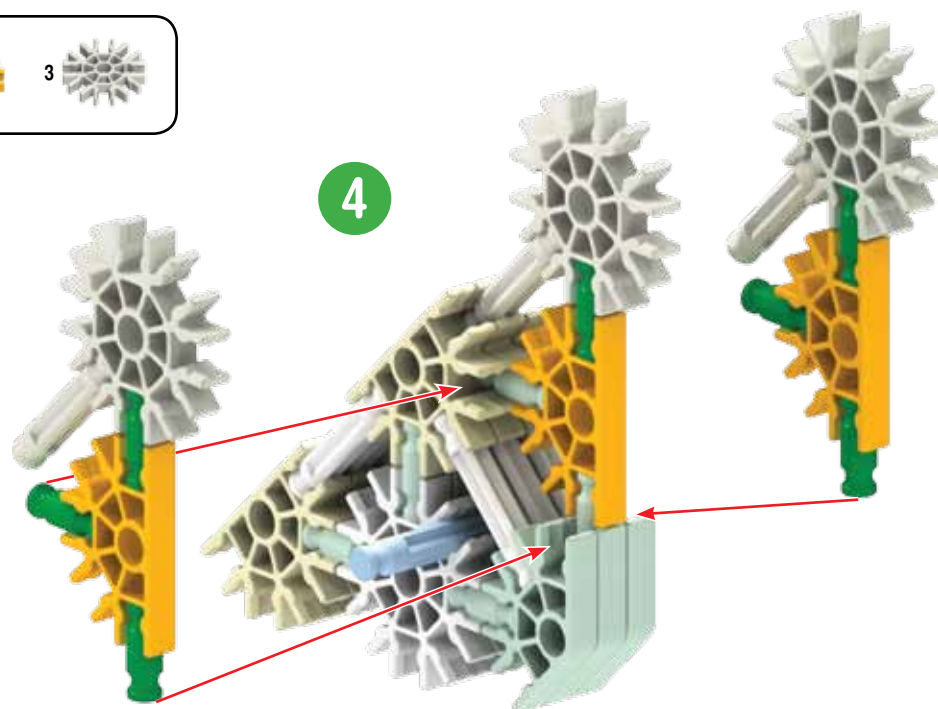

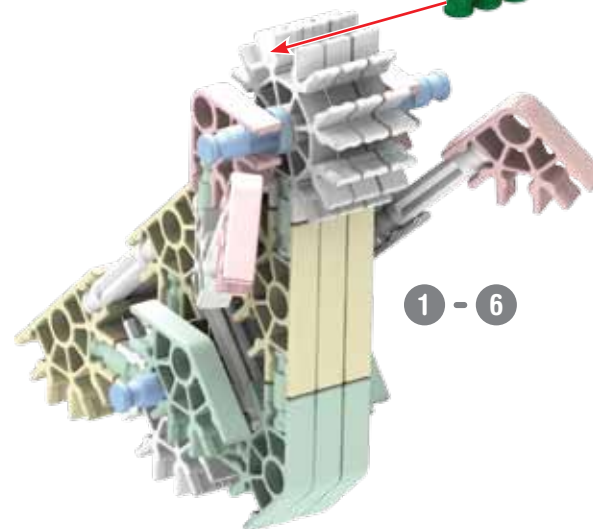
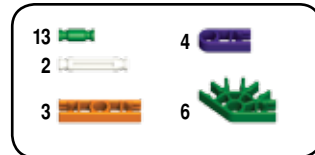
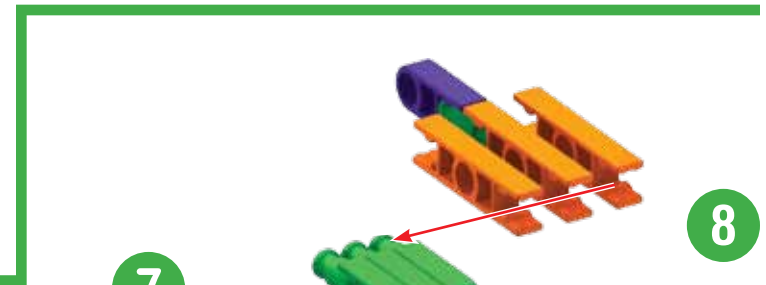
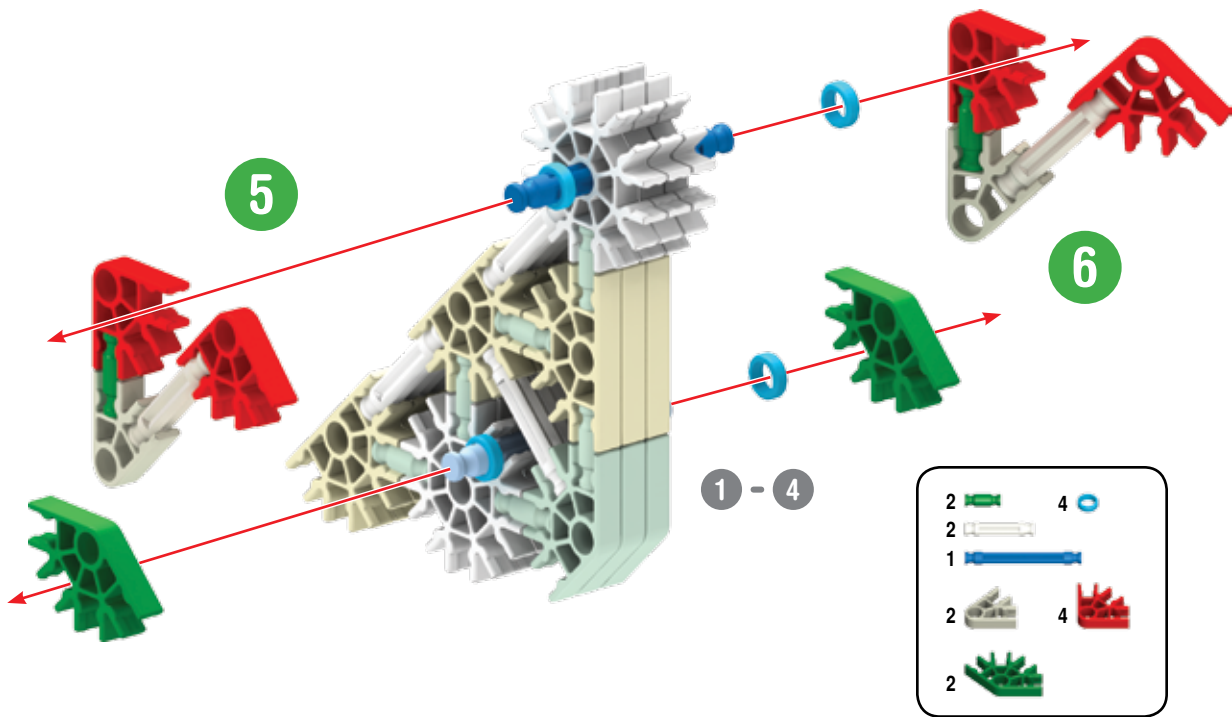

TIP: For this section of the model, it is easier to connect the rods to the connectors by pushing them from the side.

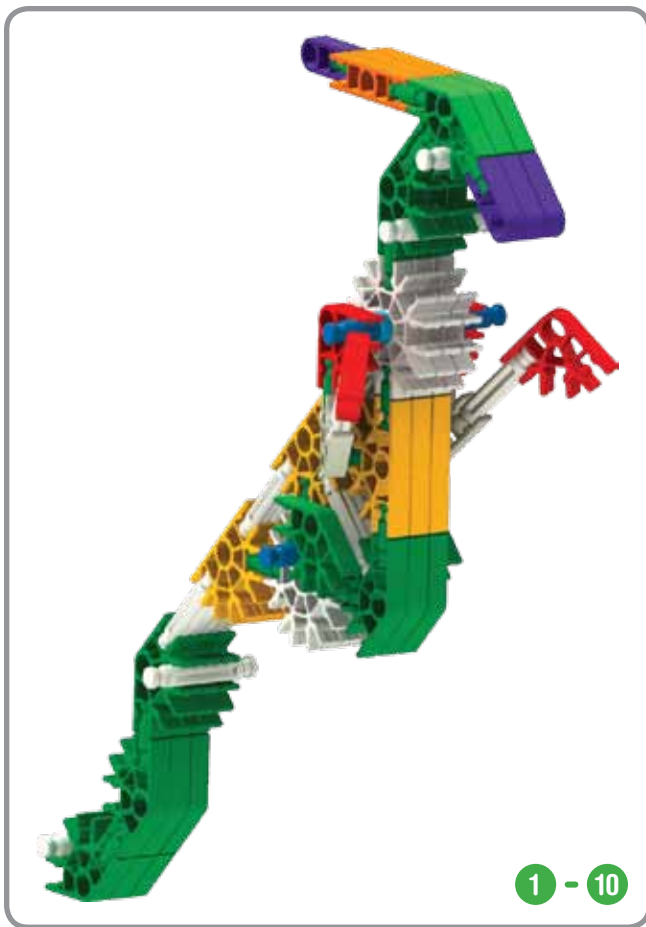

1 - 10

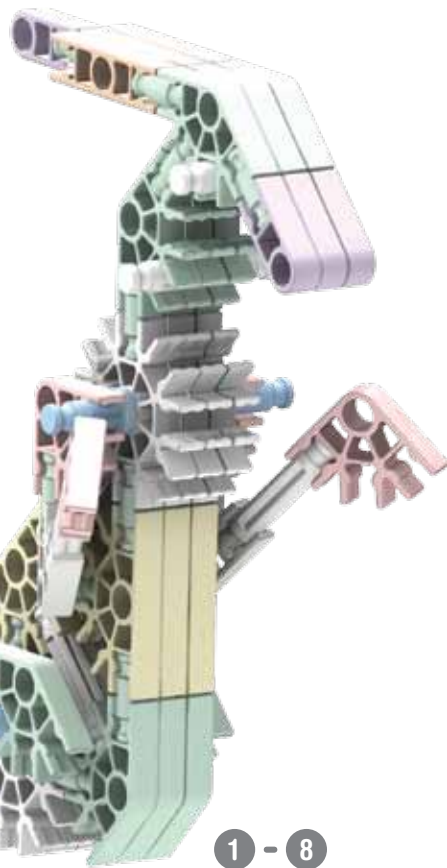

1 - 8

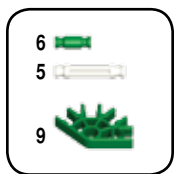

9

10

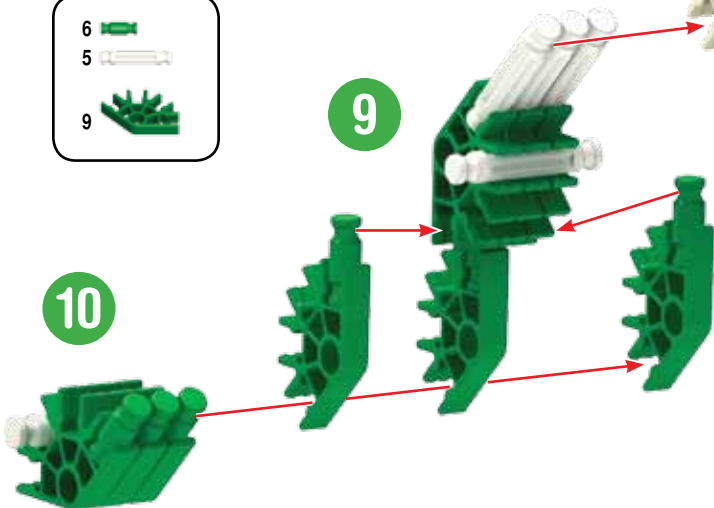

TIP: For this section of the model, it is easier to connect the rods to the connectors by pushing them from the side.

x2

11

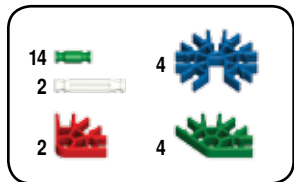
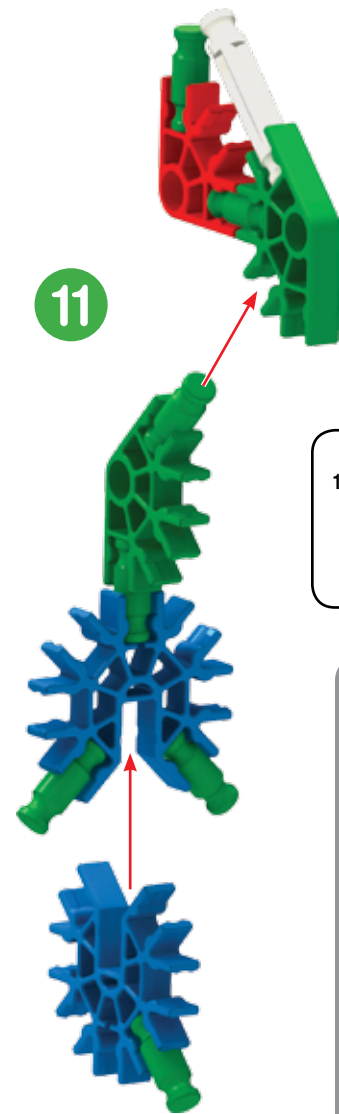

x2

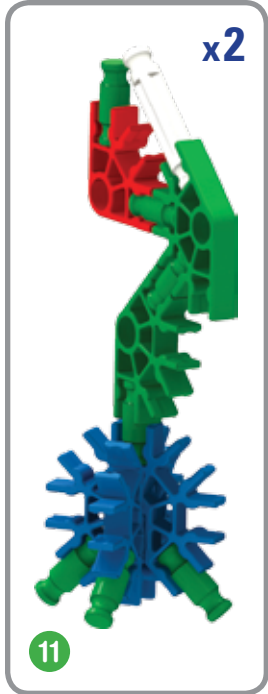

11

Hadrosaurid

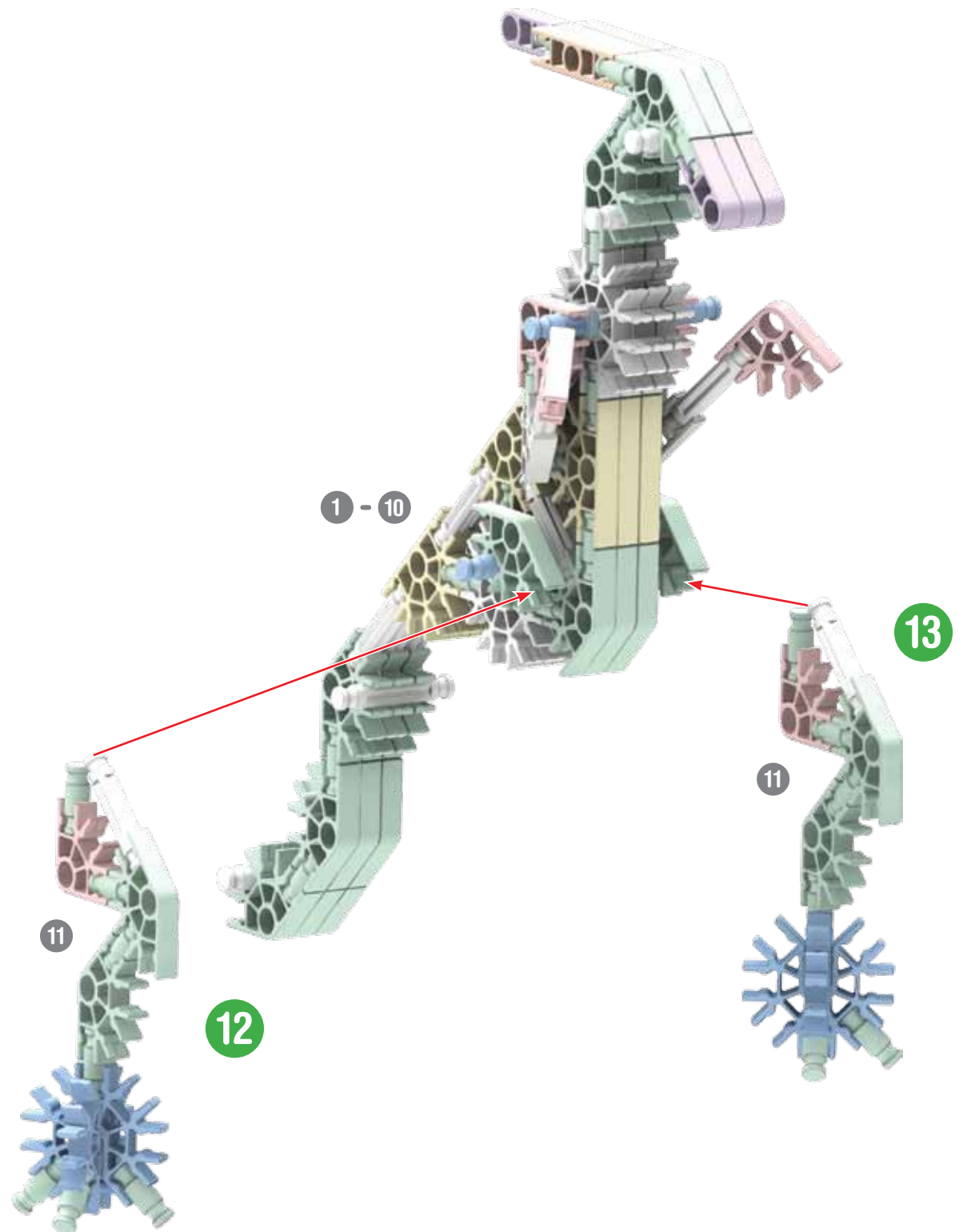

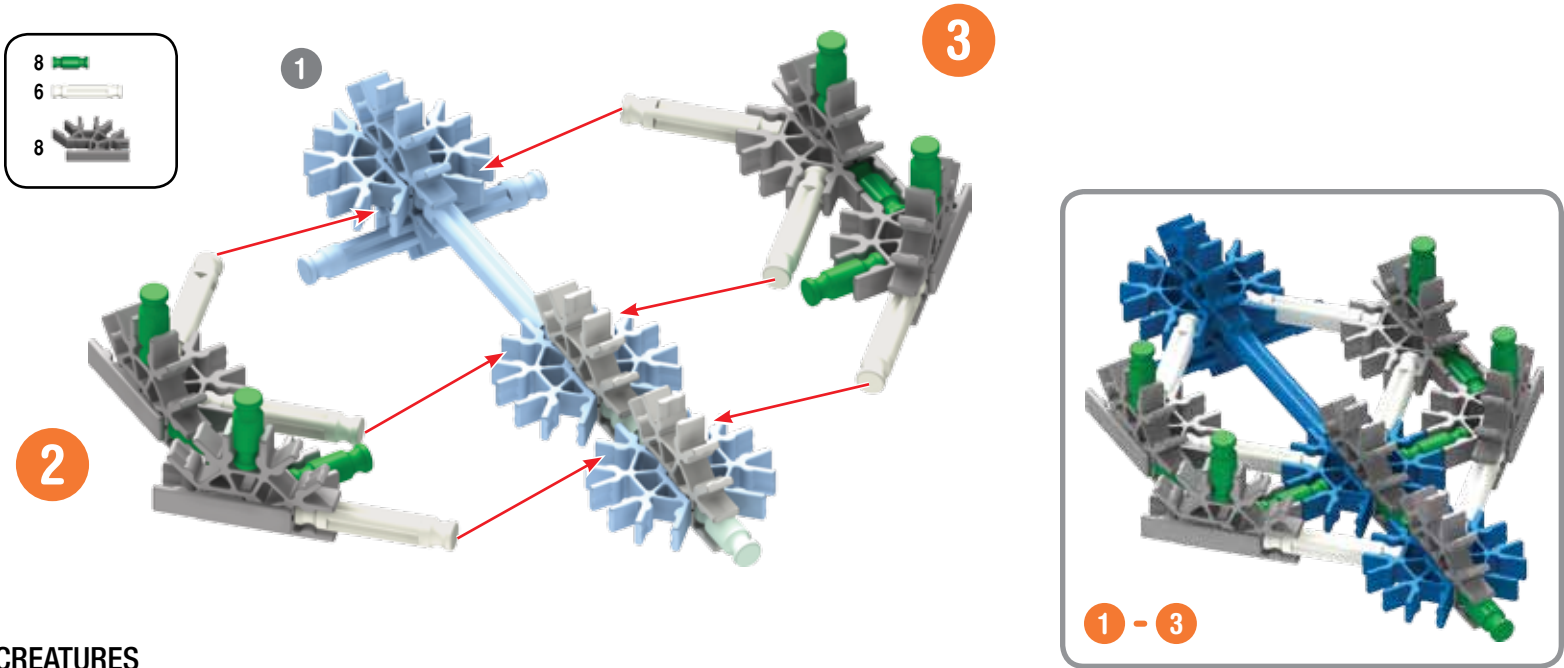
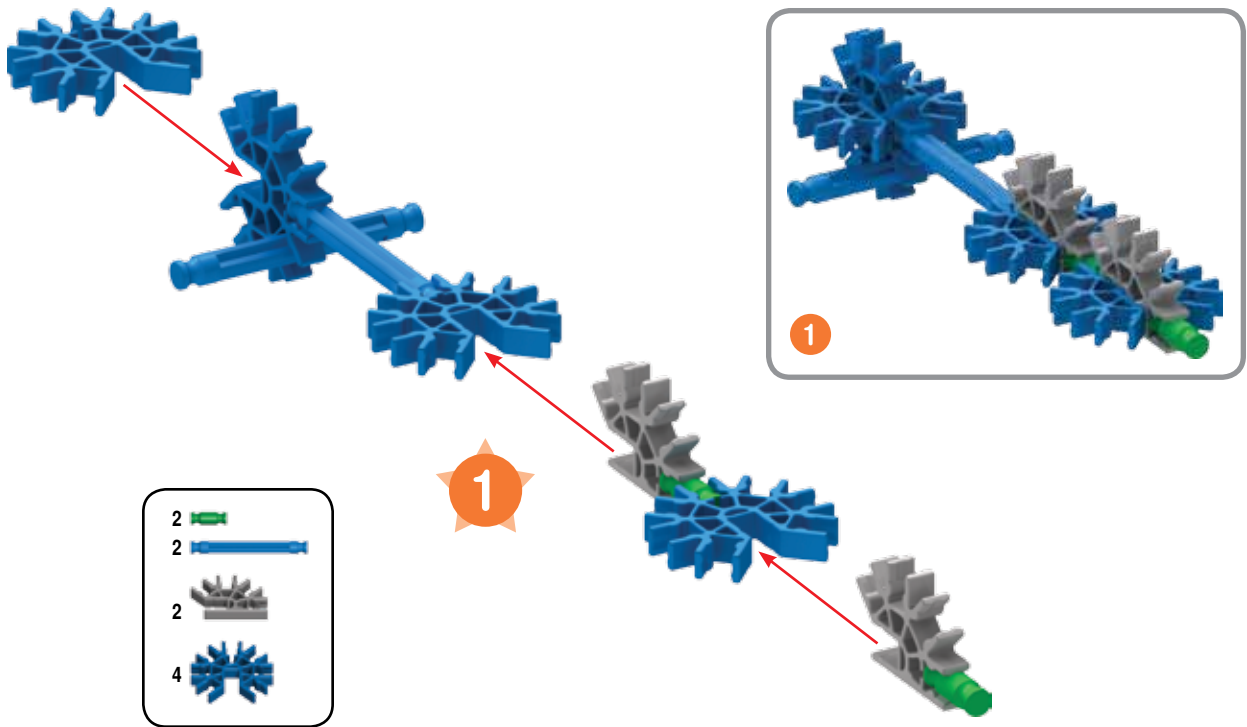

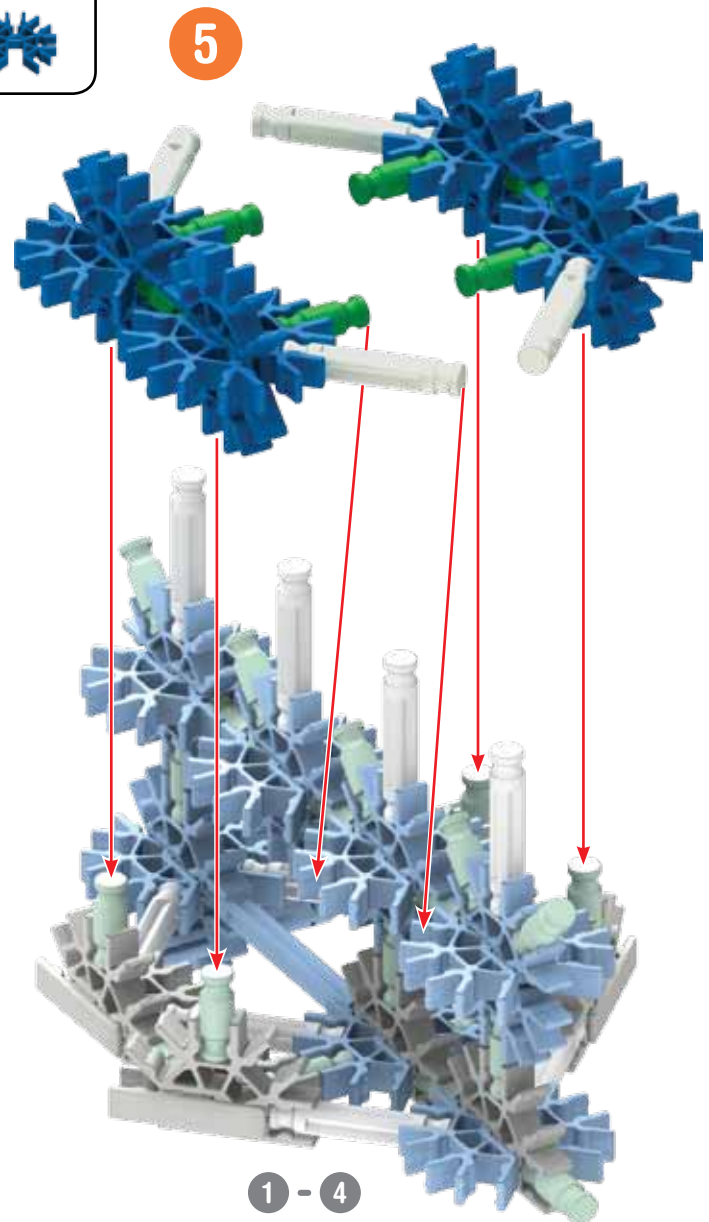
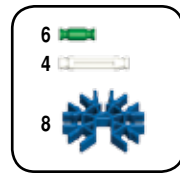
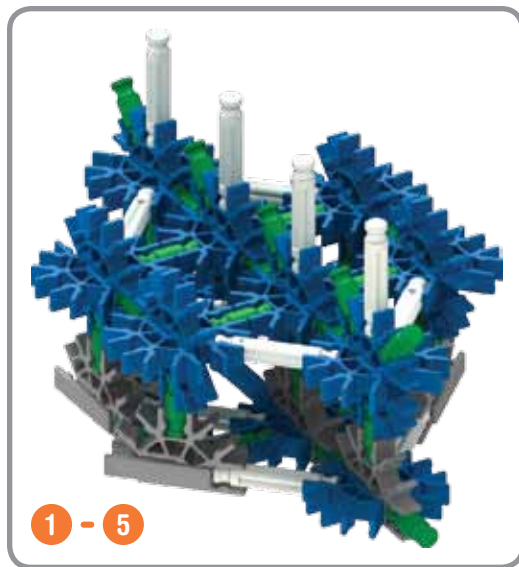
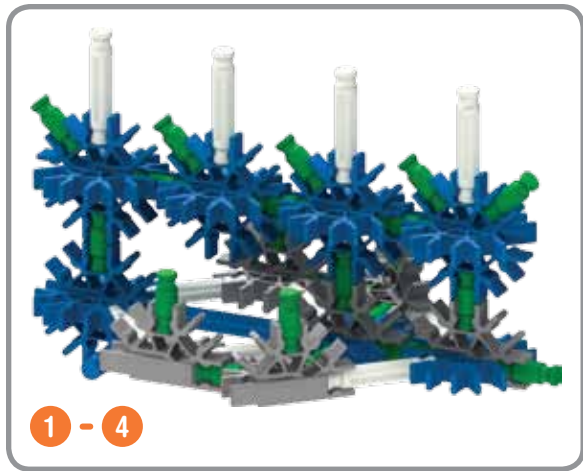
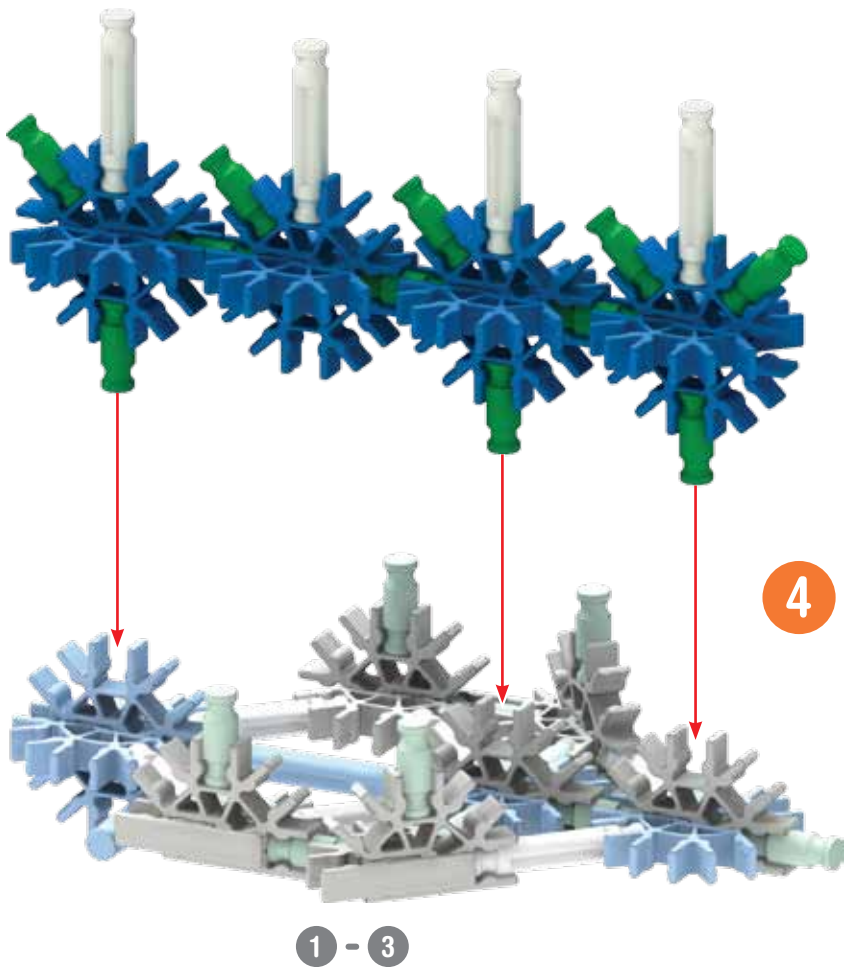

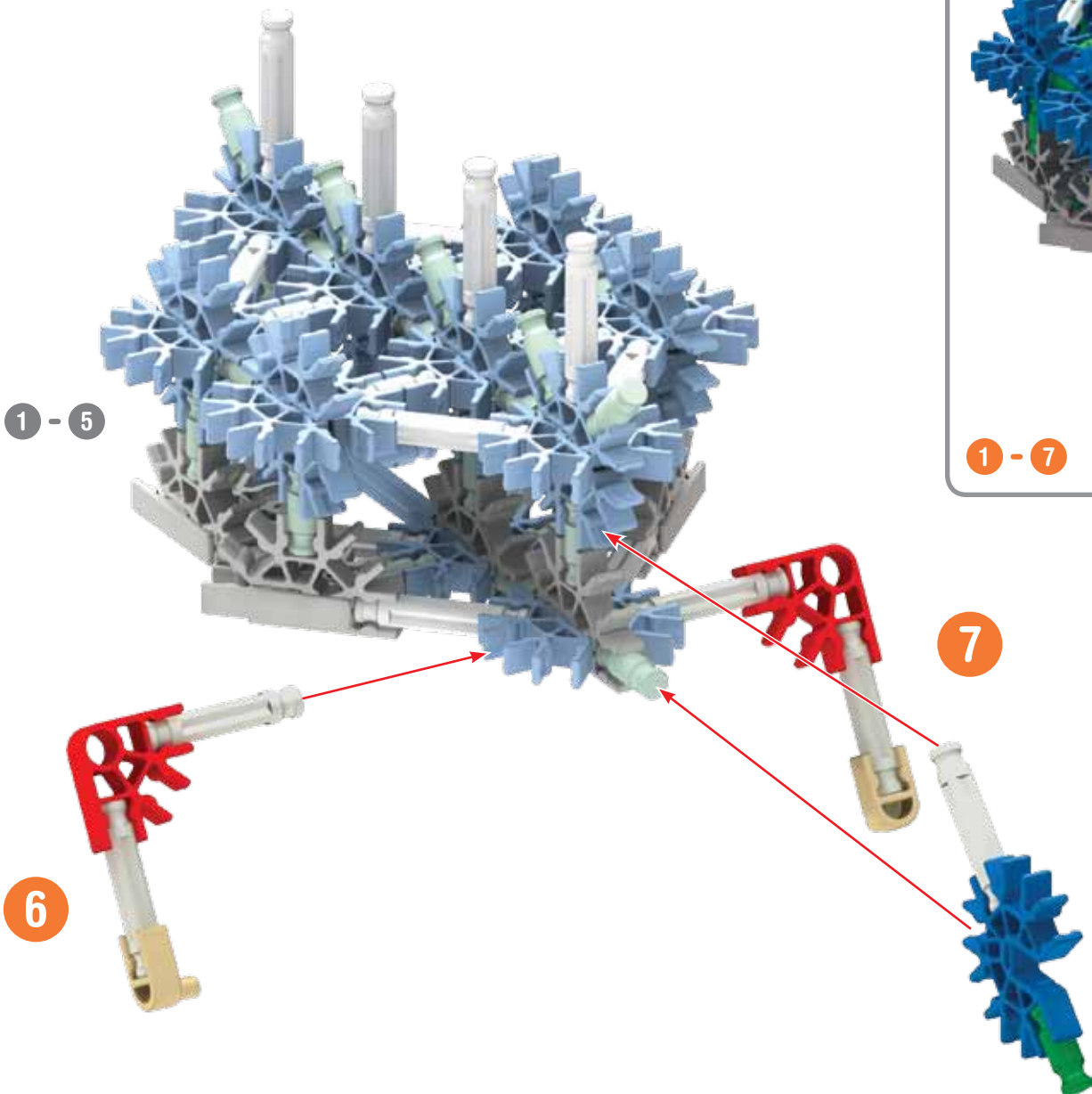

- | | | |
|---|--|---|
| 1 | | |
| 5 | | |
| 2 | | 2 |
| 1 | | |

4		2	
7		1	
4		1	
1		1	
6		1	

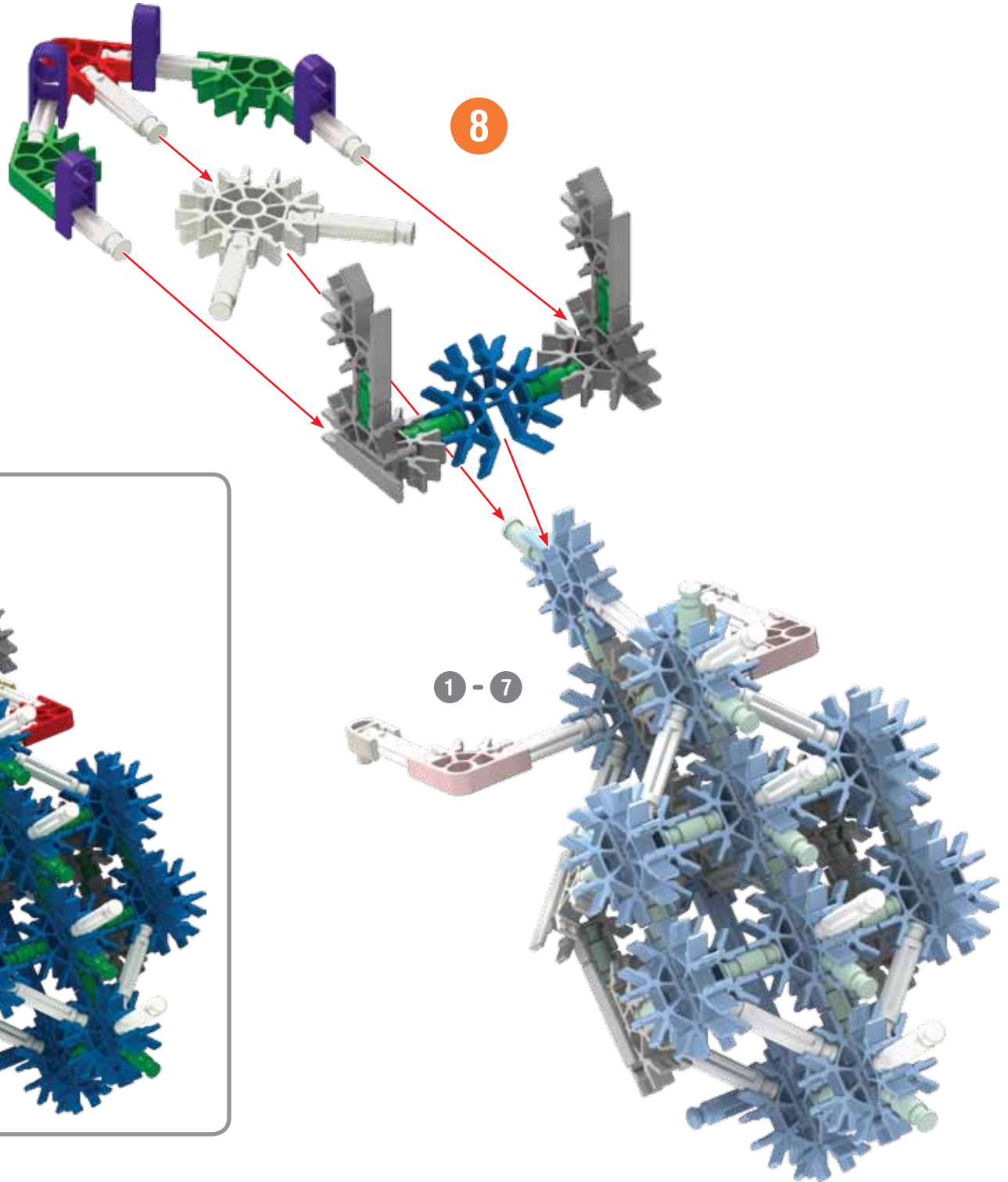

6		2		2		1	
8							
3		2		6			

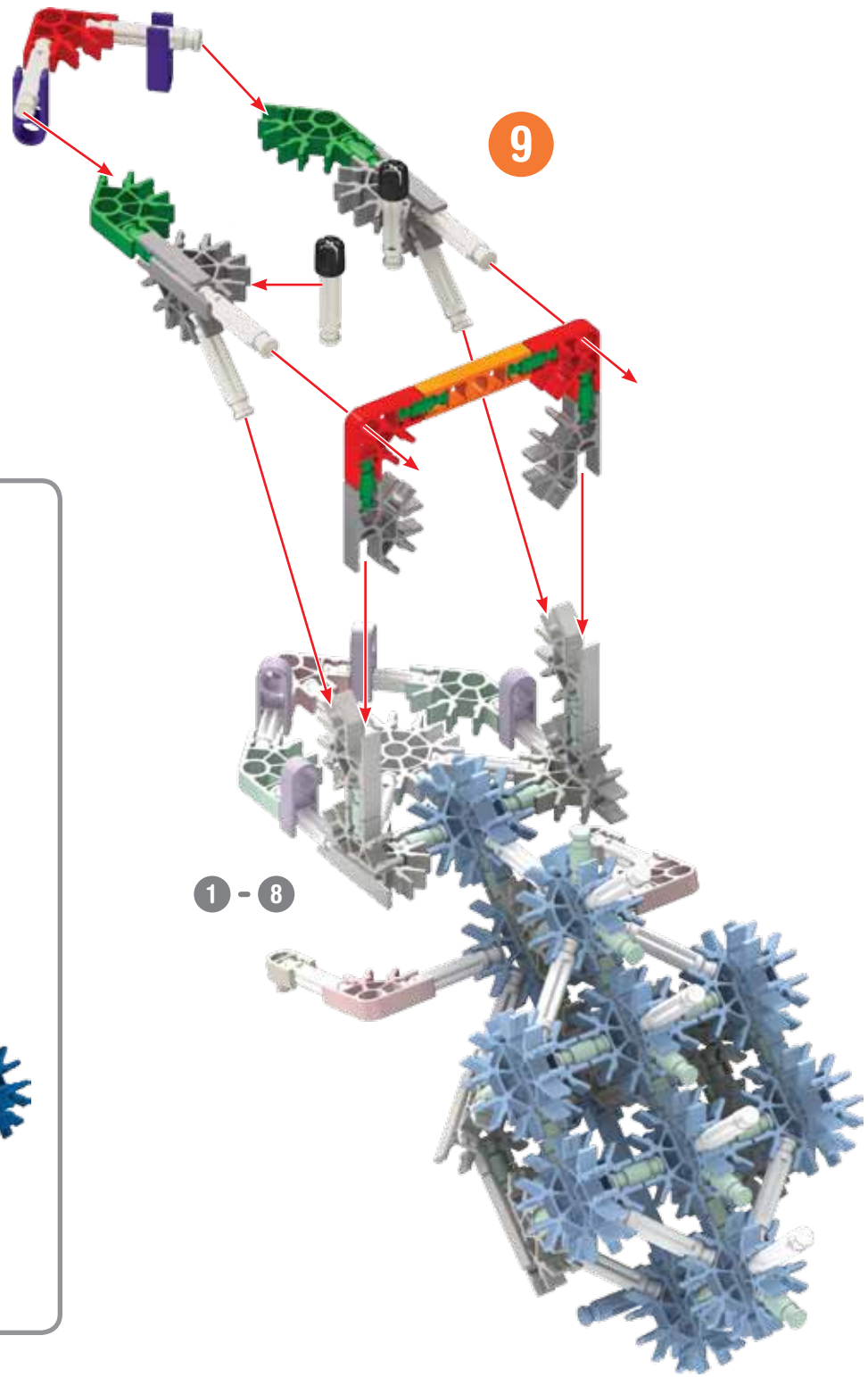
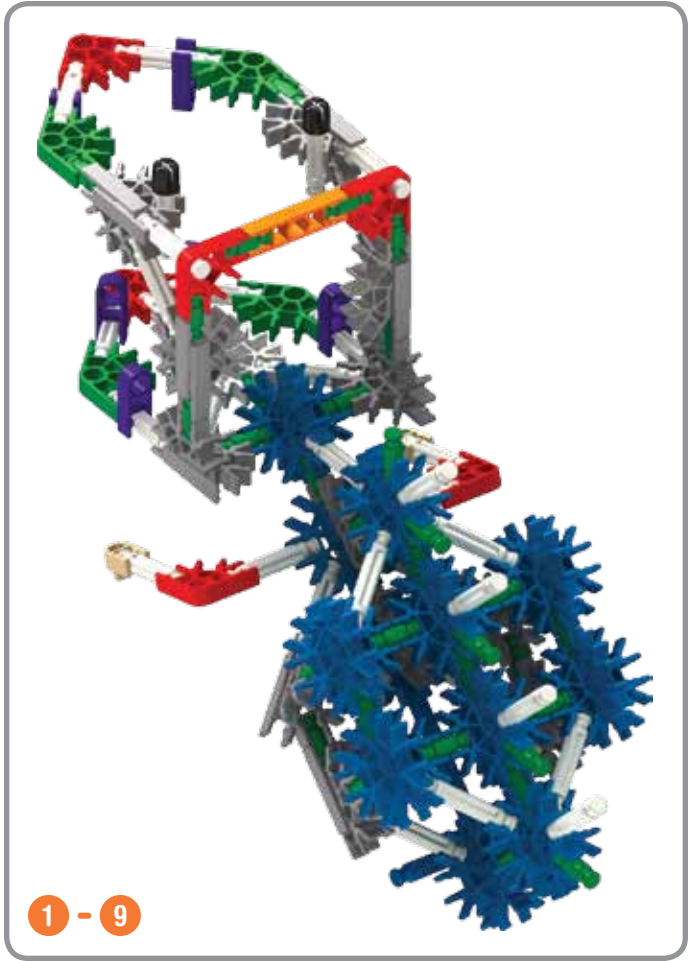

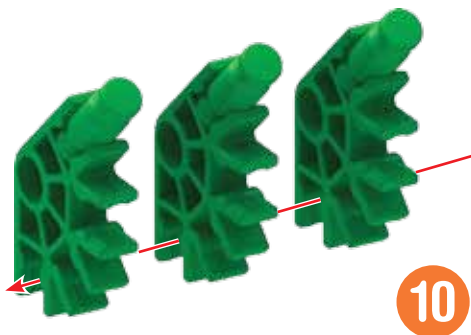

10

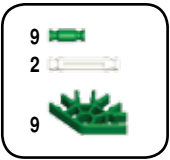

11



TIP: For this section of the model, it is easier to connect the rods to the connectors by pushing them from the side.



10 - 11



12

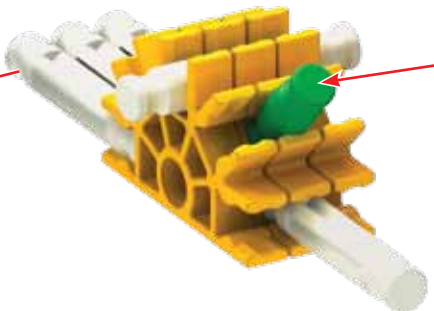

13



10 - 13

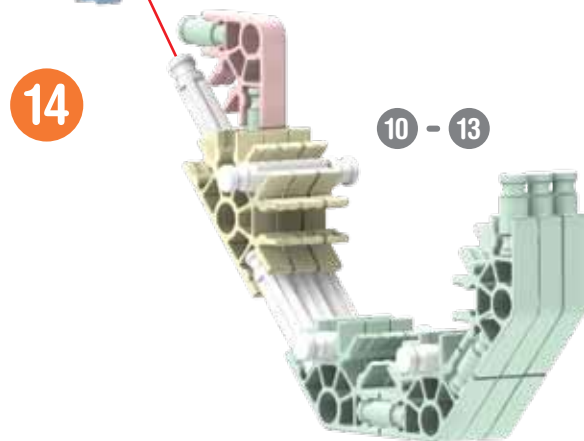
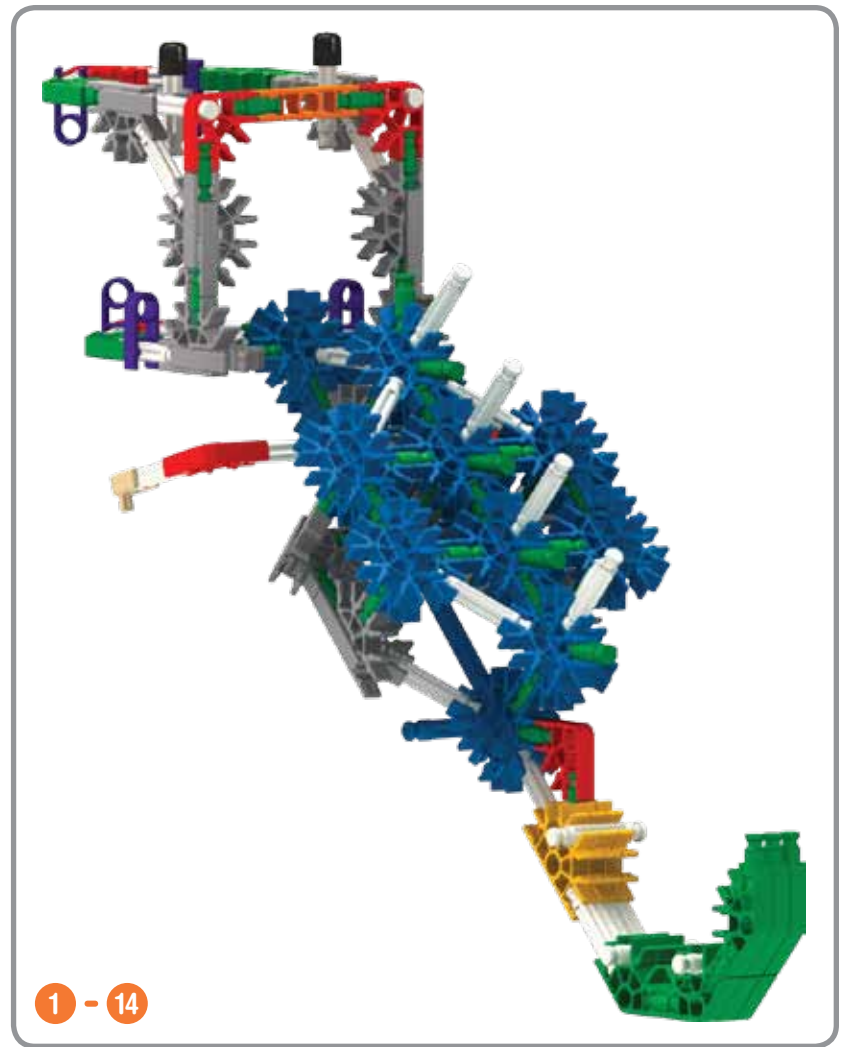
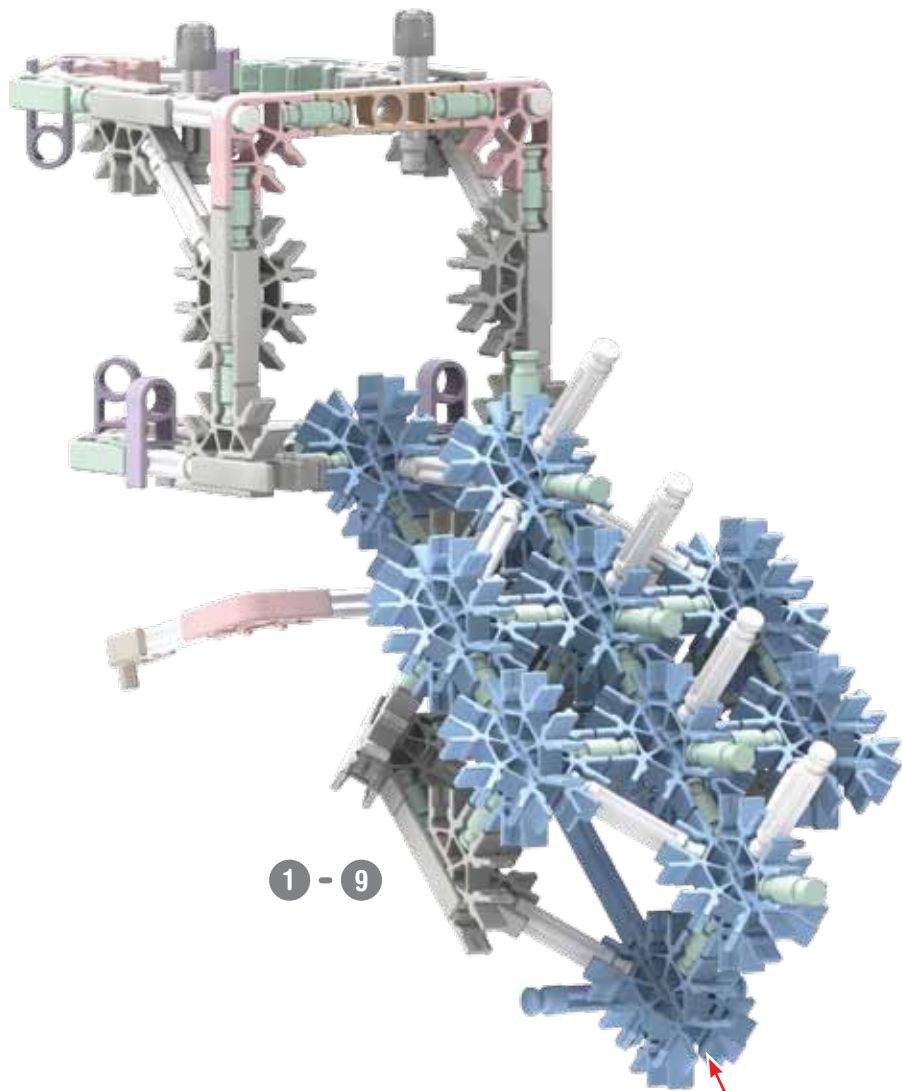

x2

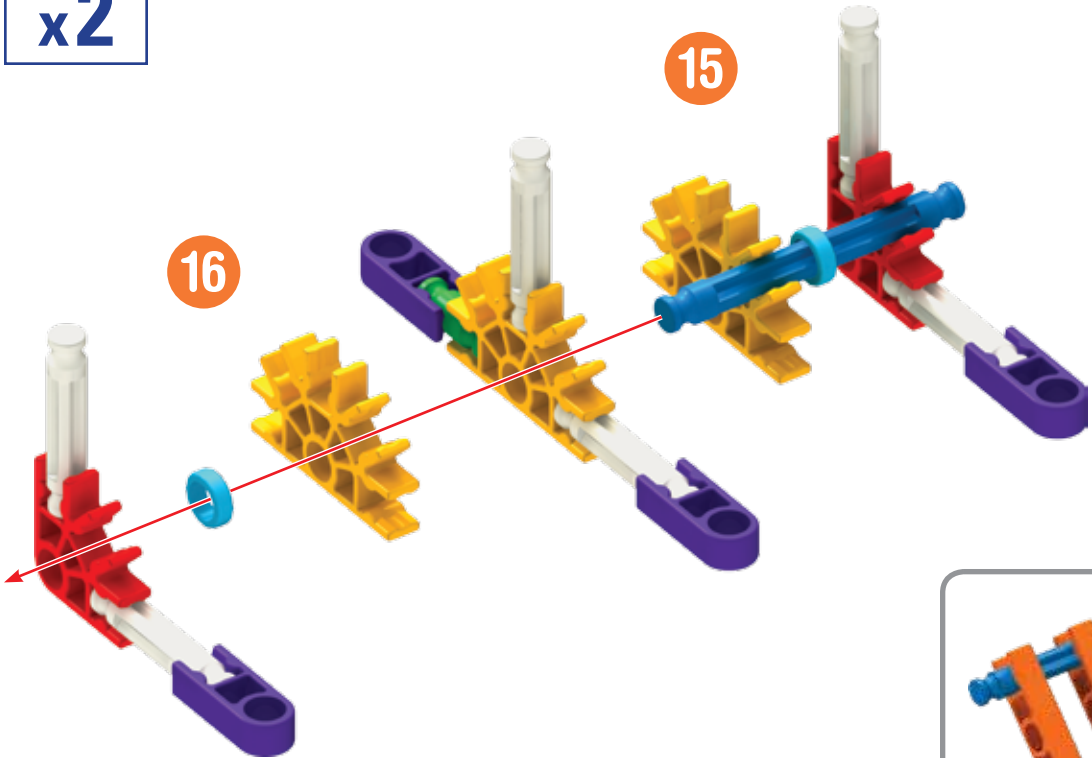

x2

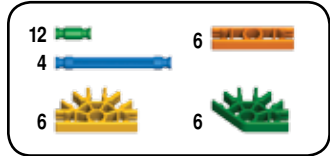

17

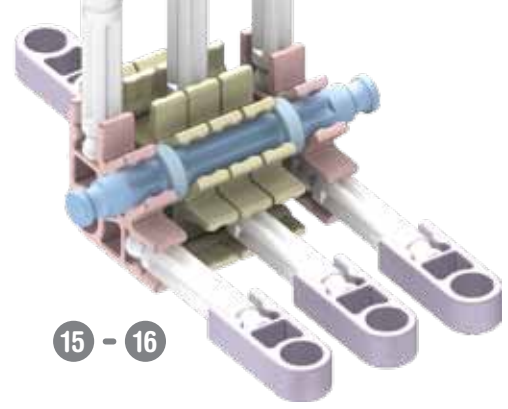
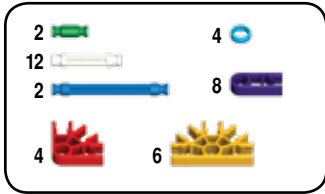
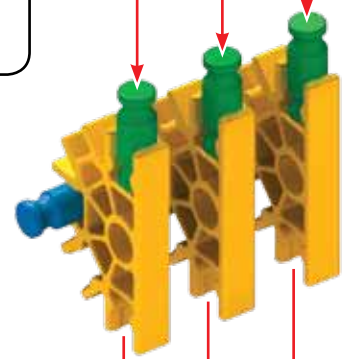

15 - 16

15 - 17

K'NEX Rex

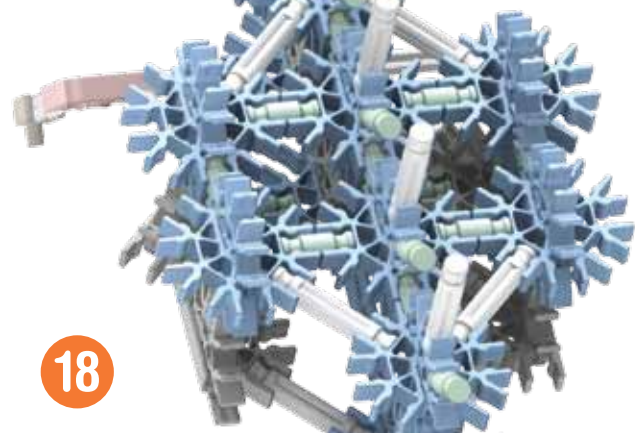

15 - 17

Pterodactyl

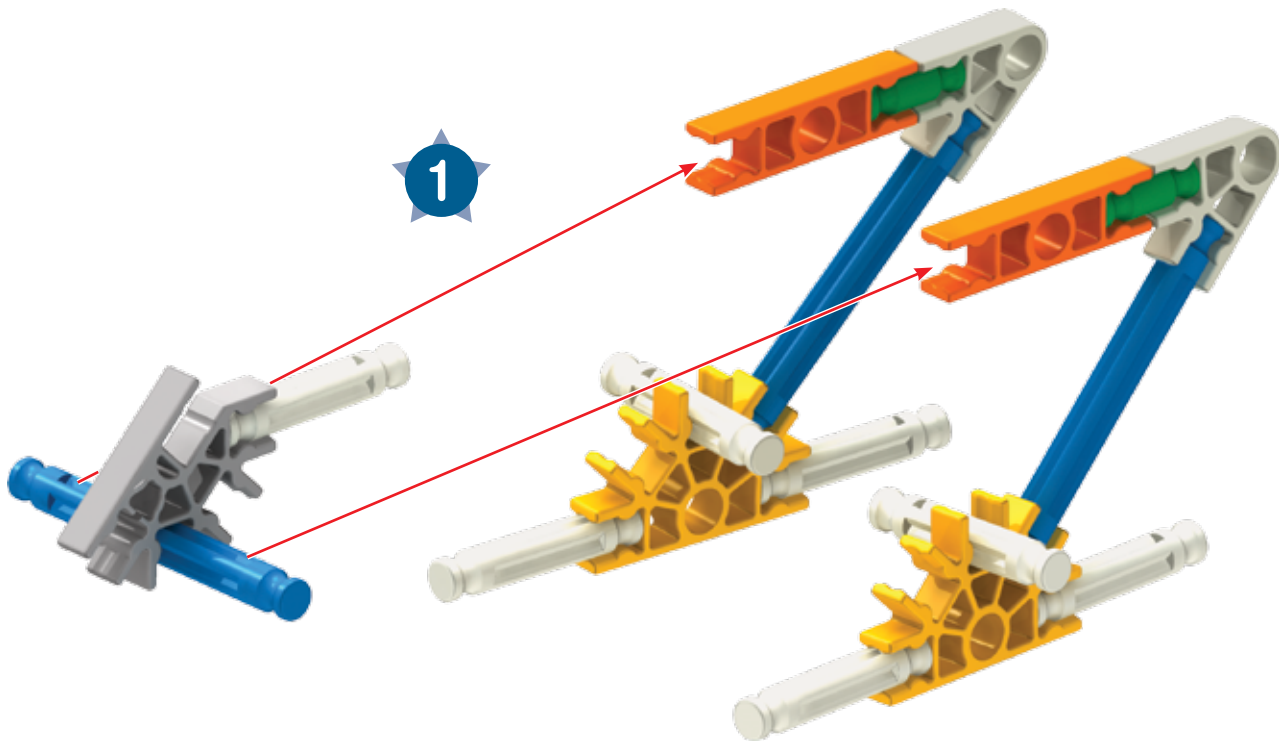
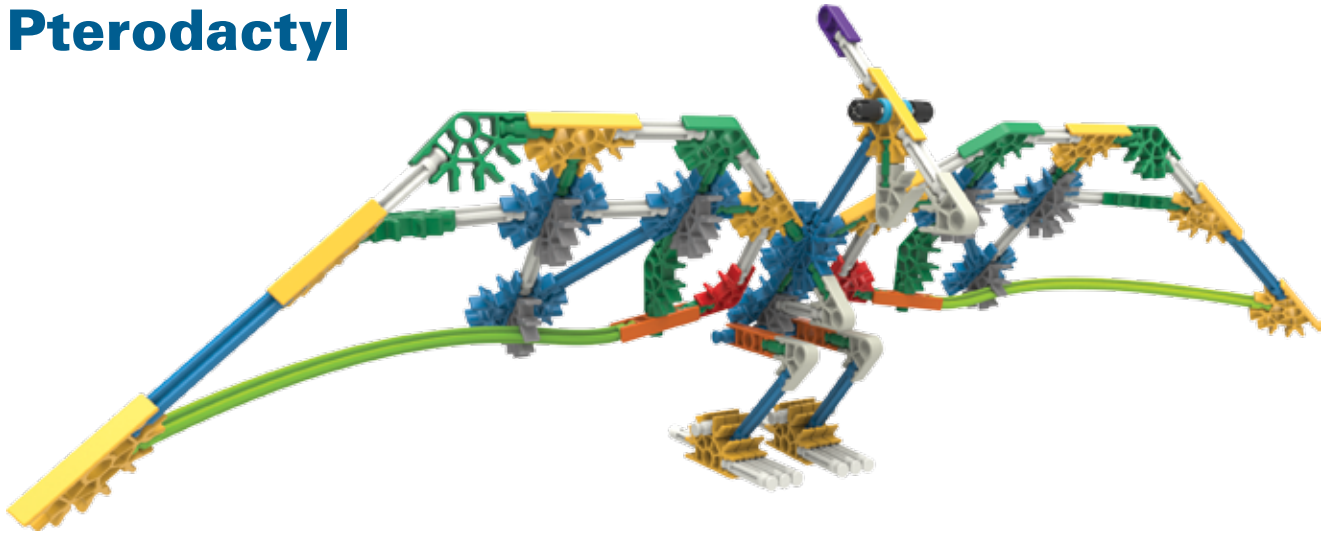

2		2	
7		2	
3		1	
2			



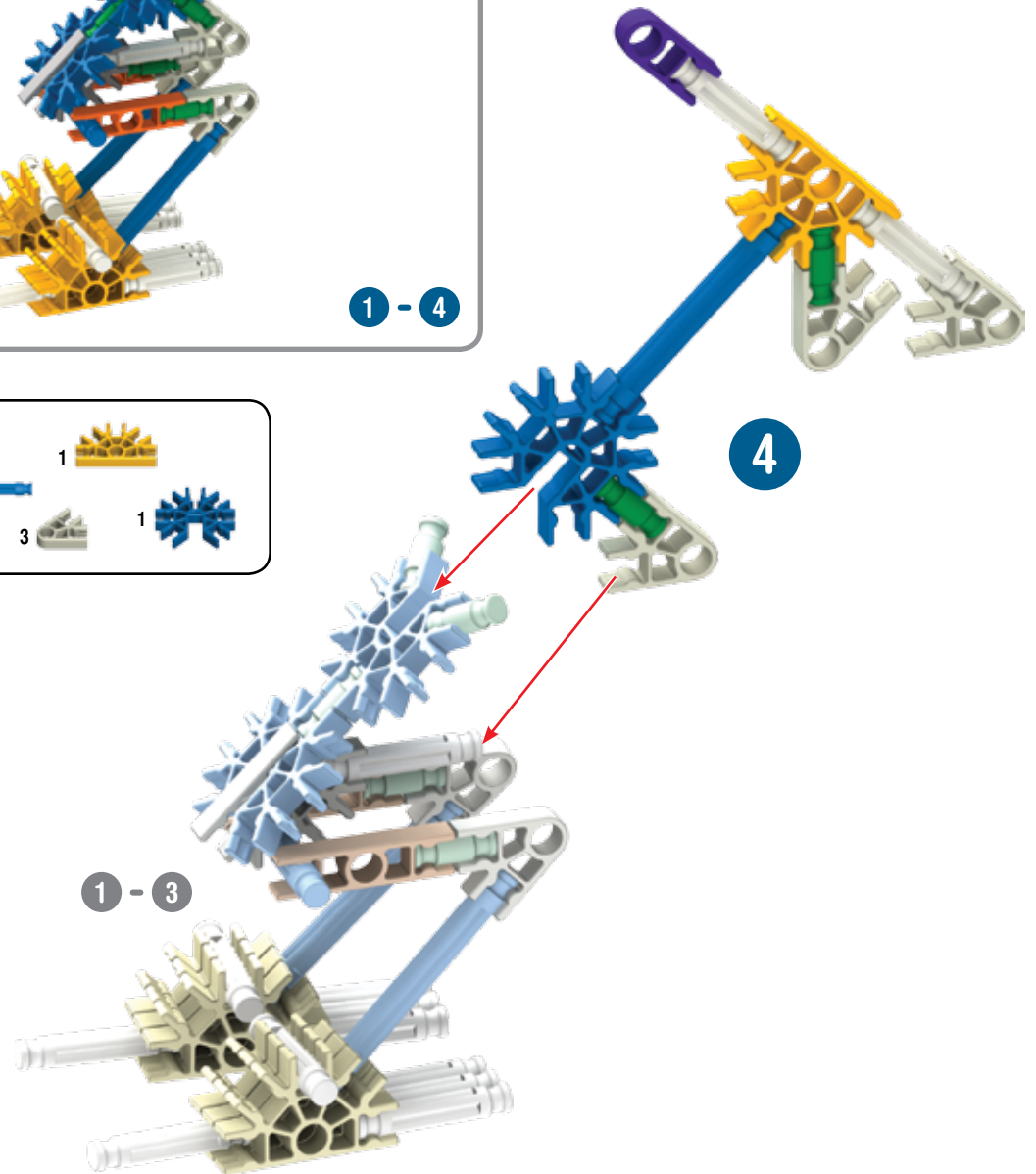
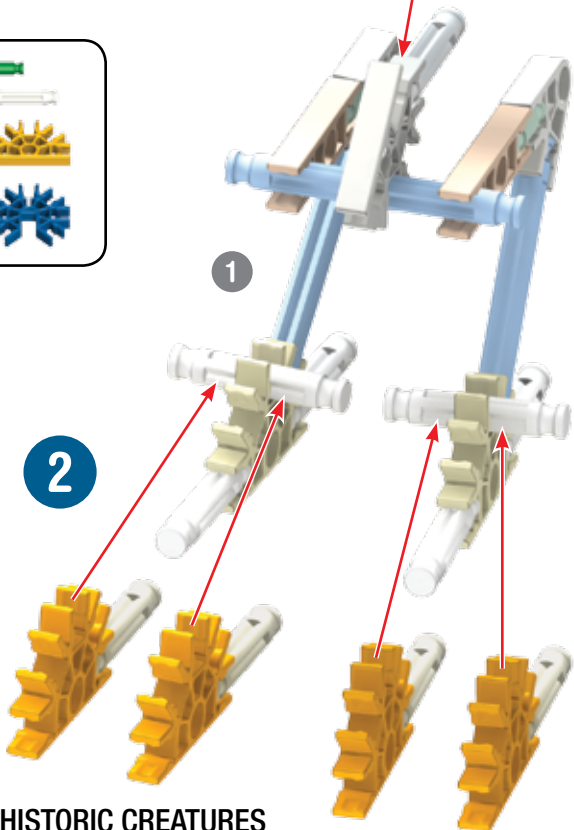
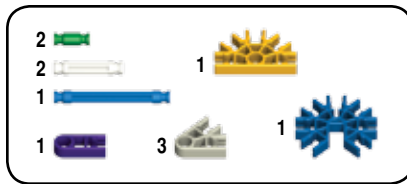
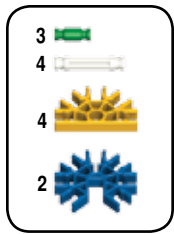
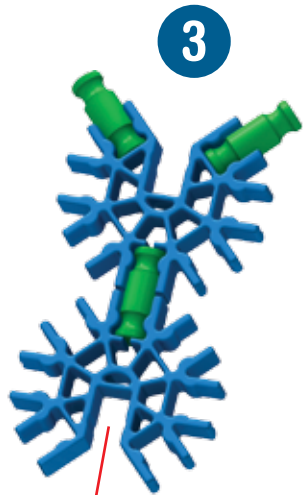

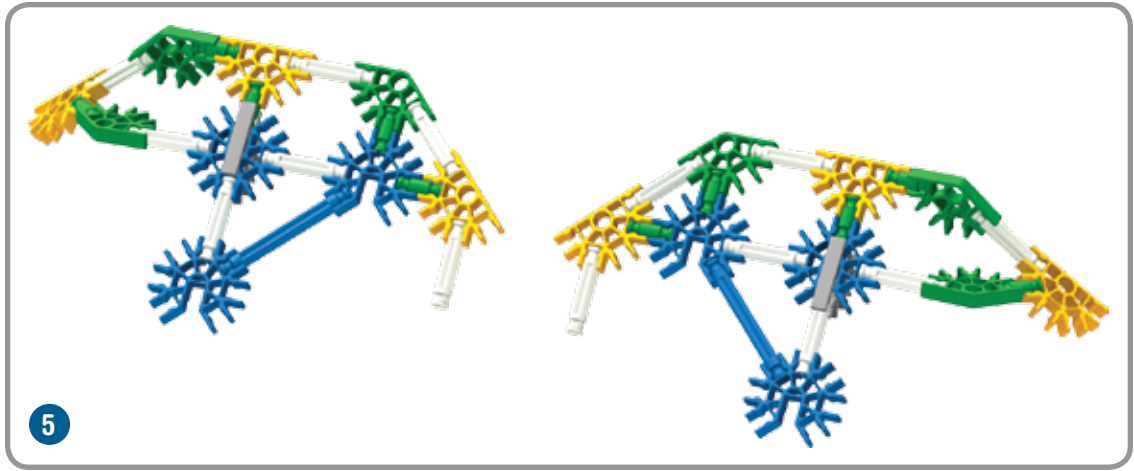
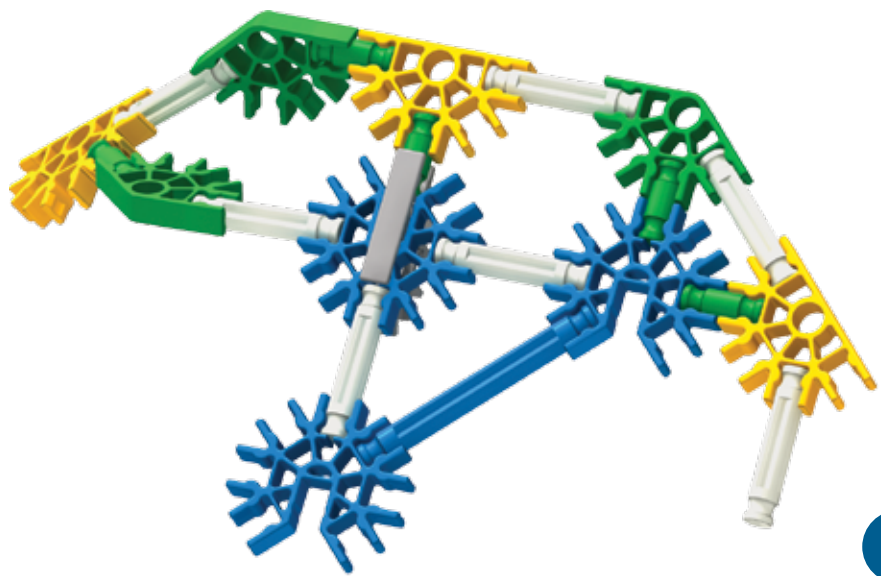

5

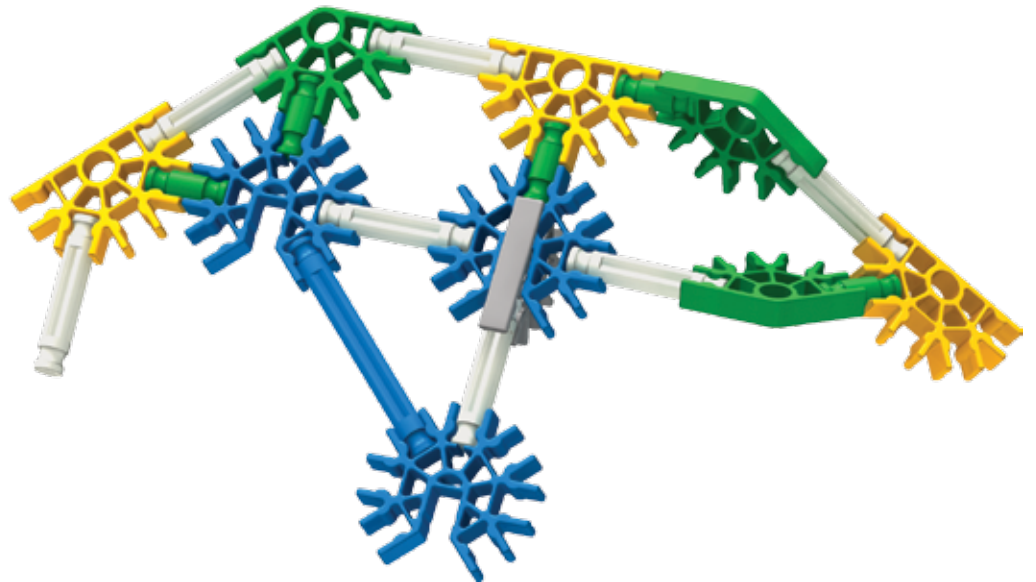

10		6		6	
14		2		2	
6		2			

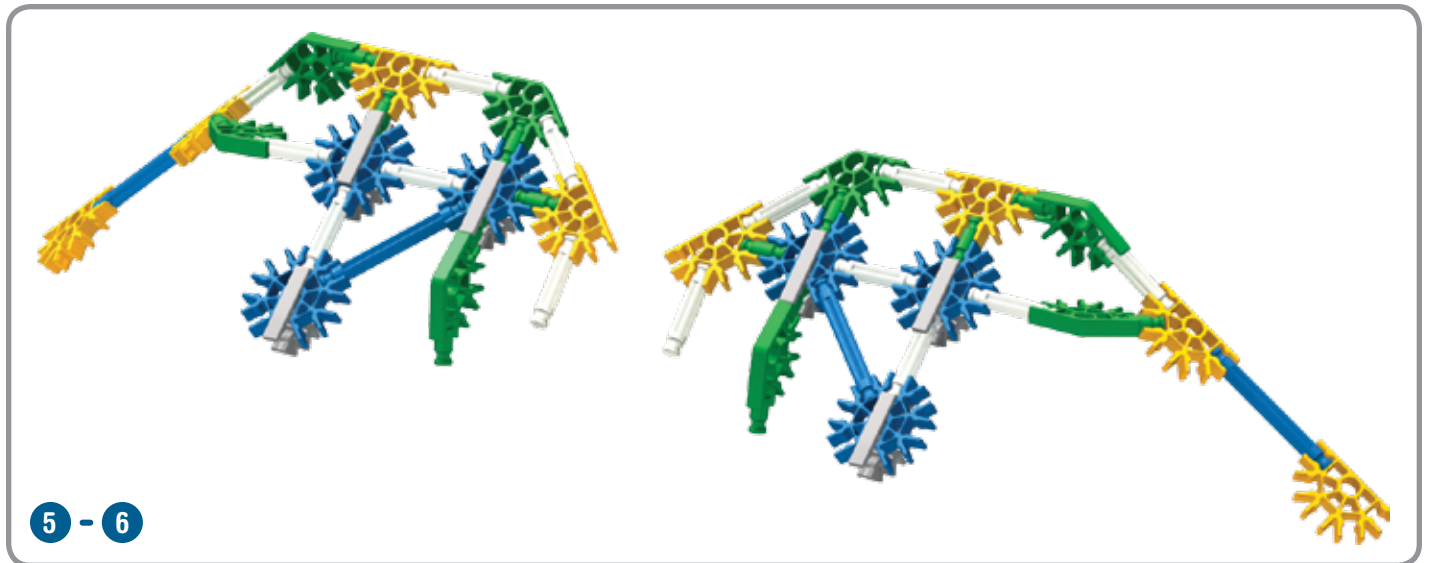
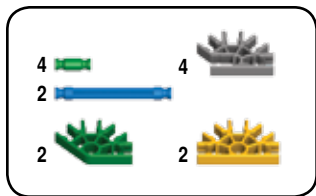
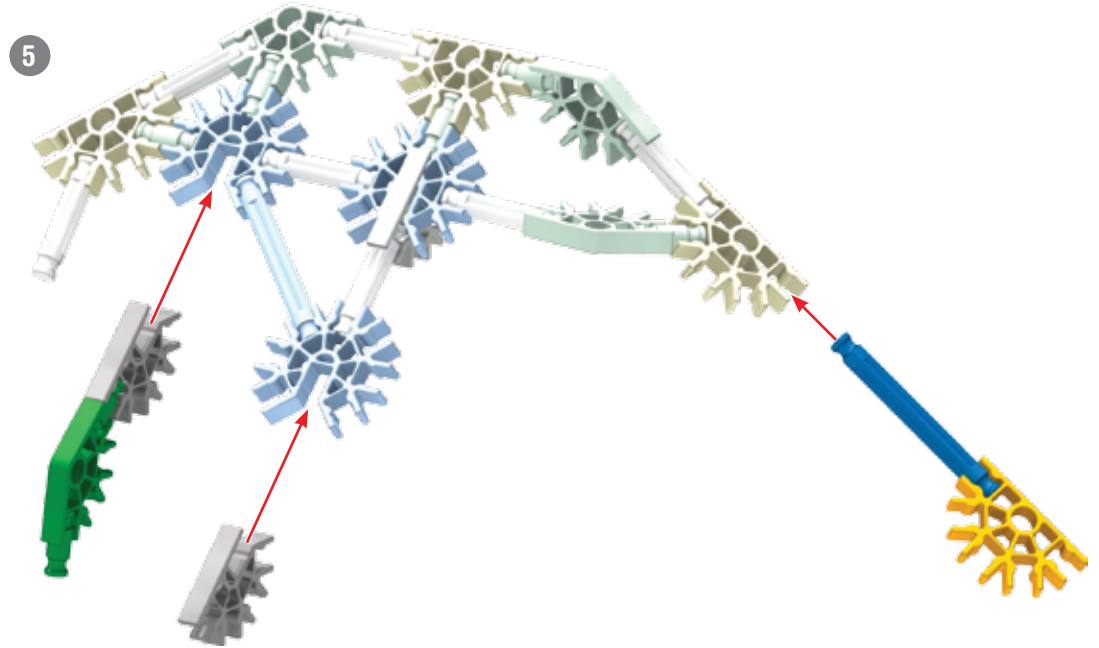
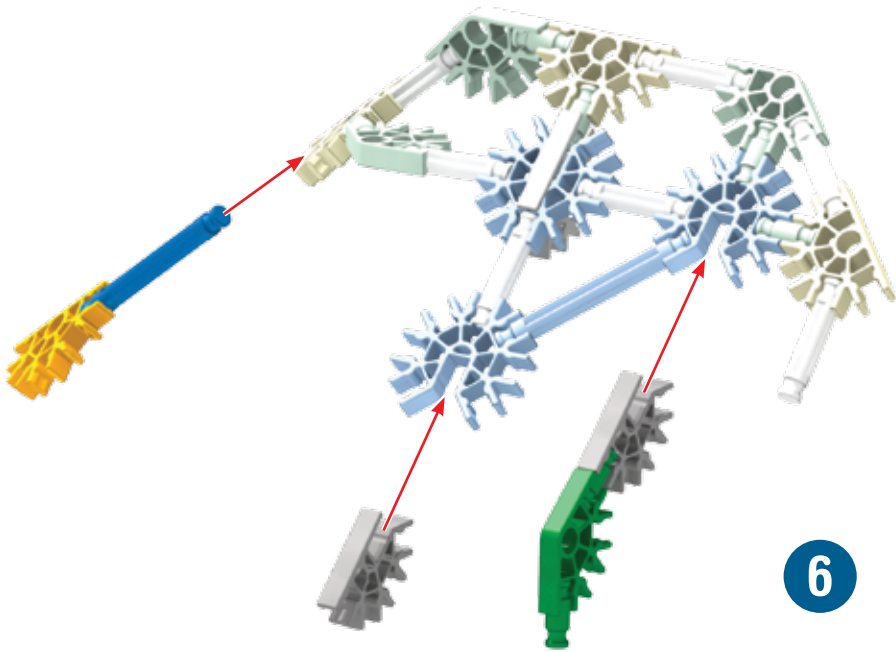

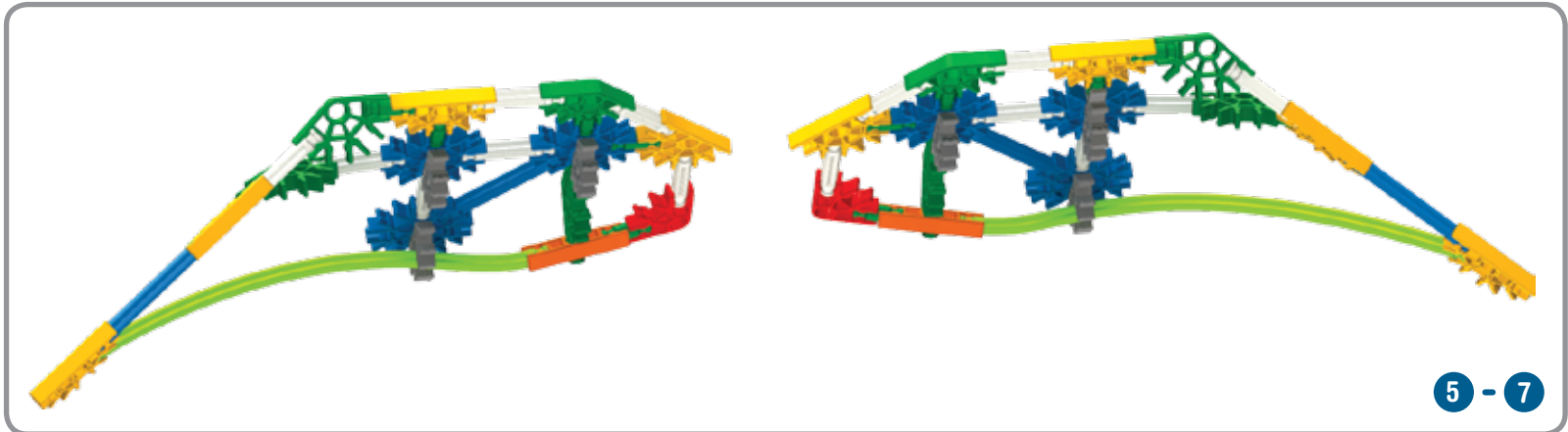
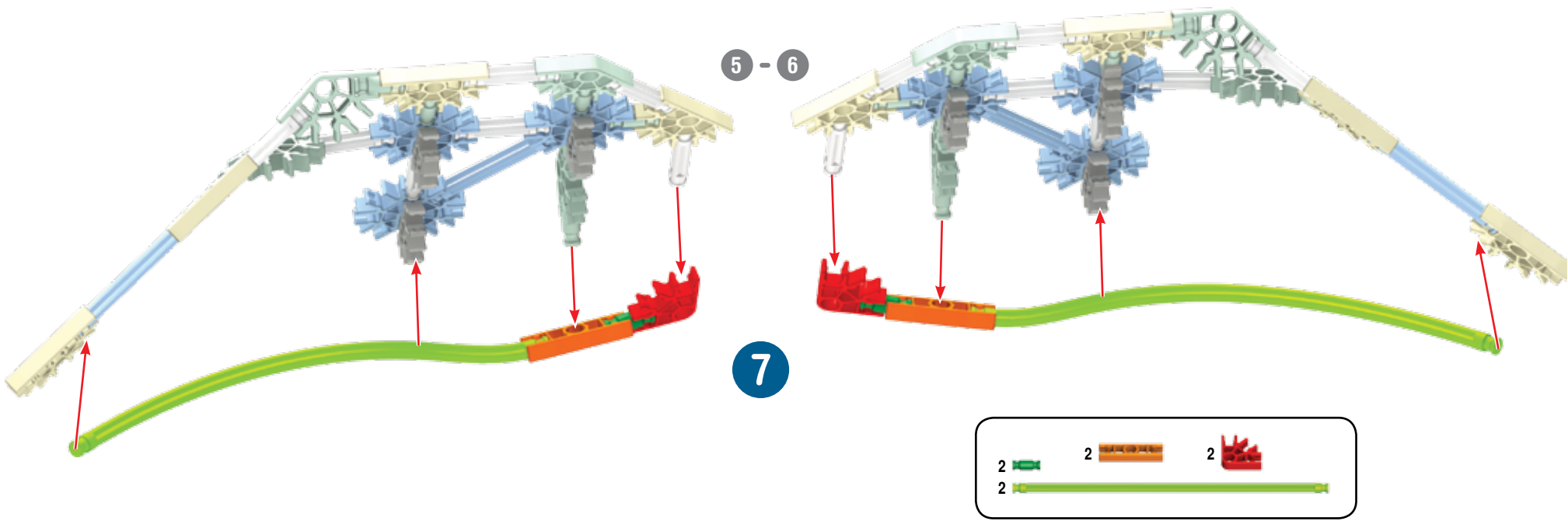

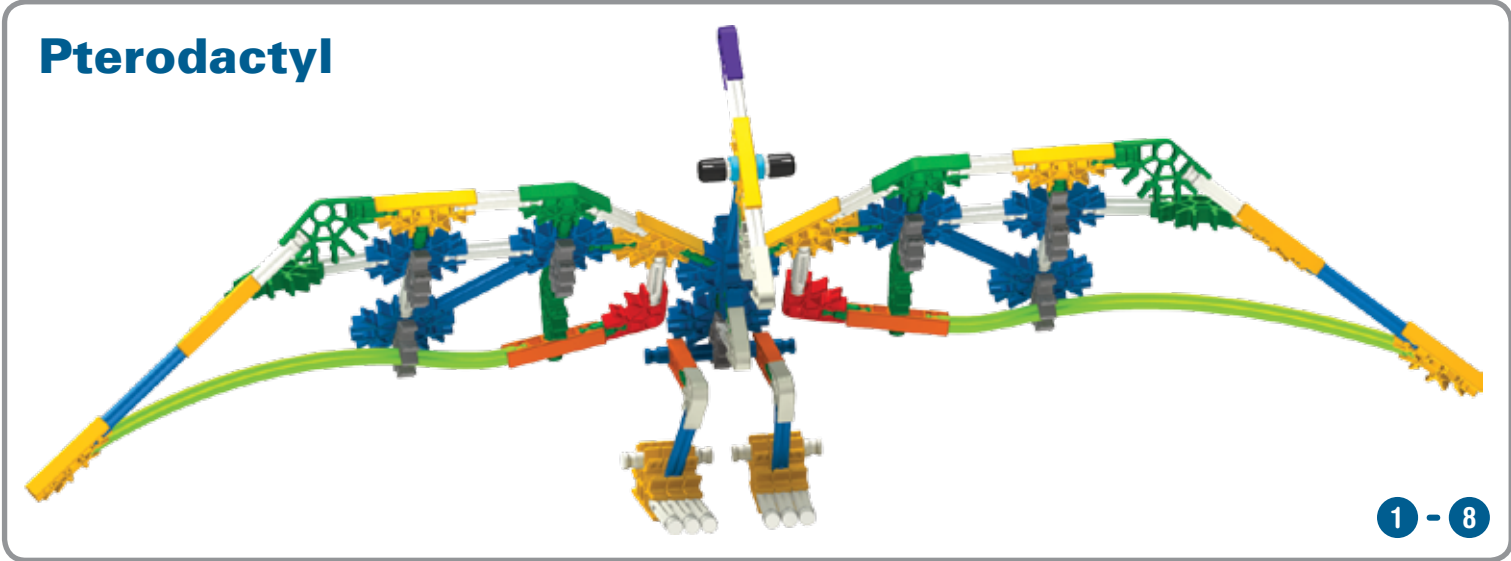
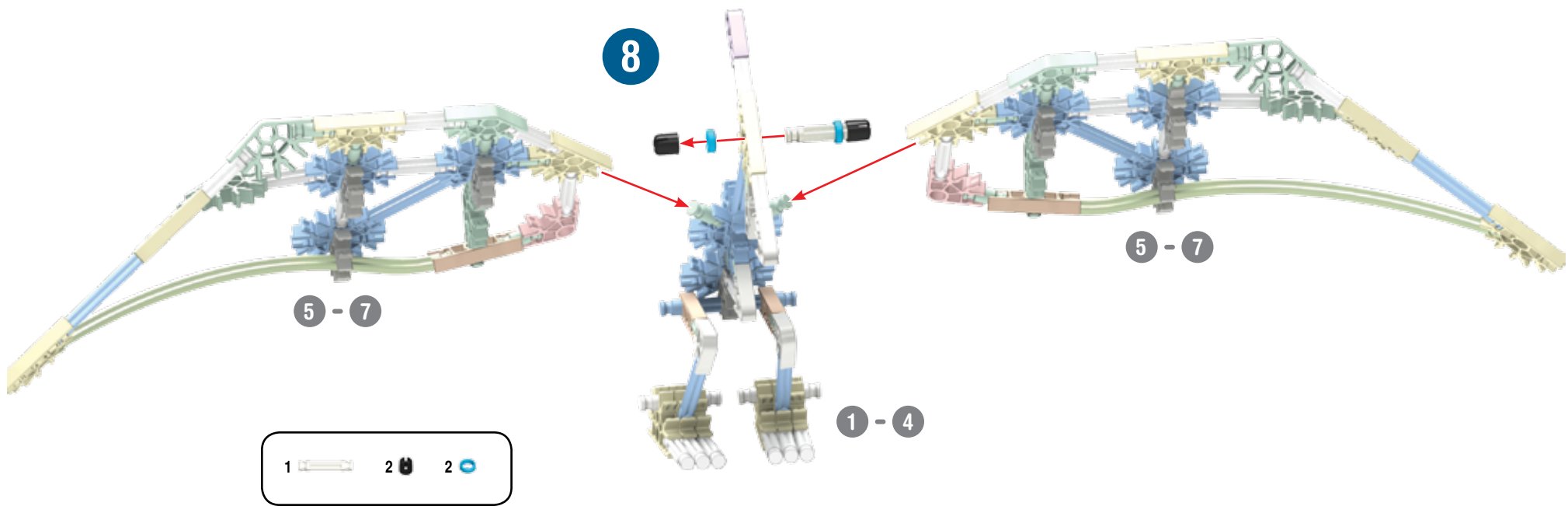

Stegosaurus

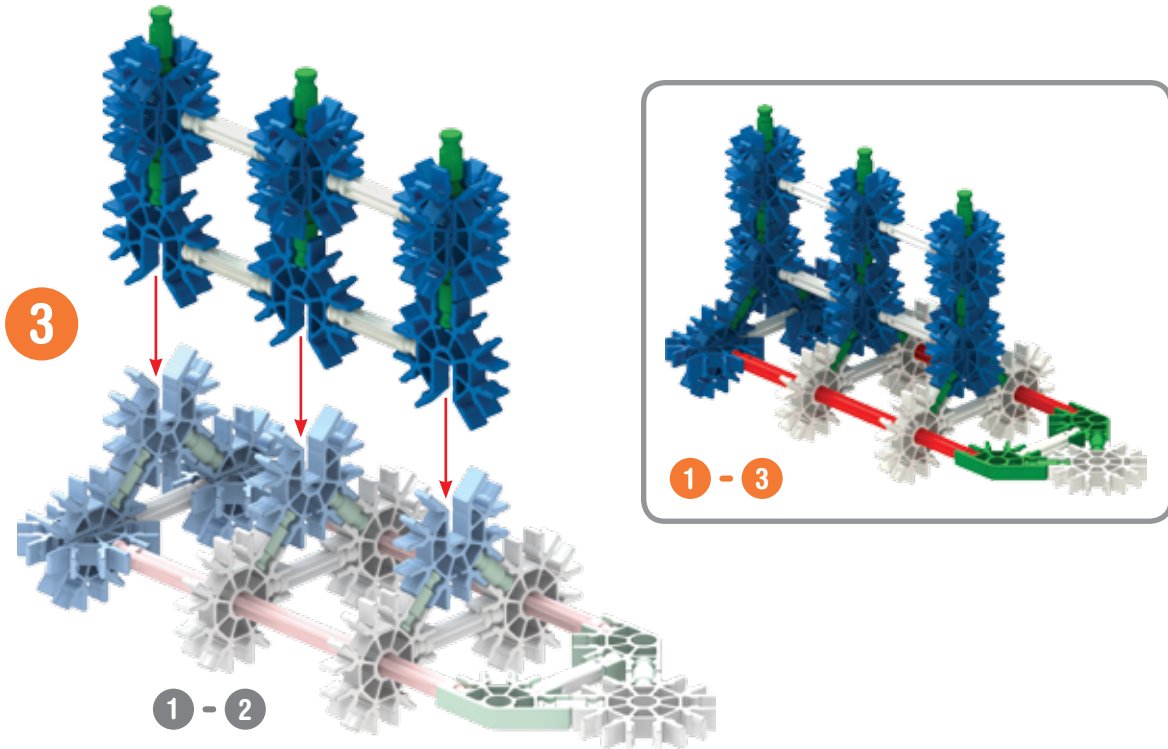
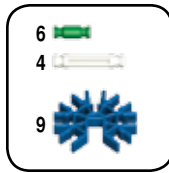
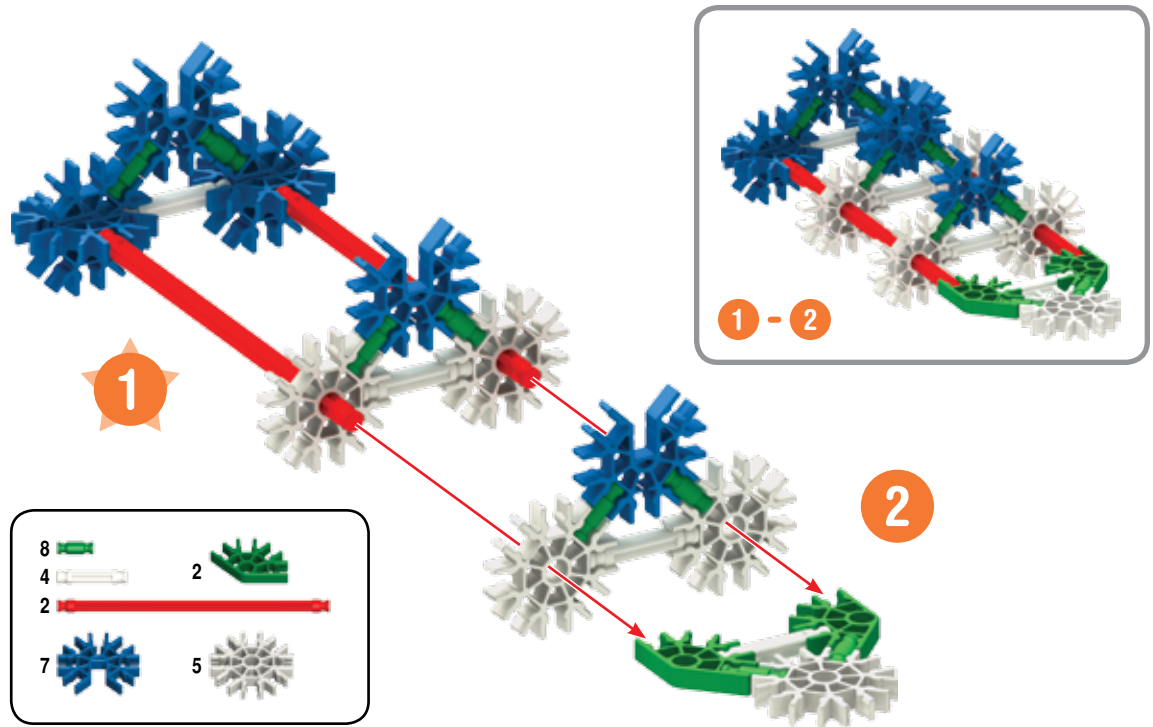
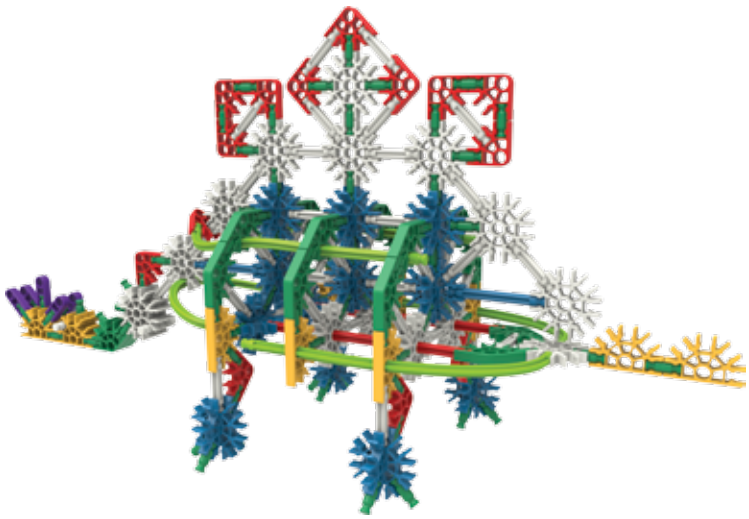

2		1		7	
8					
2					

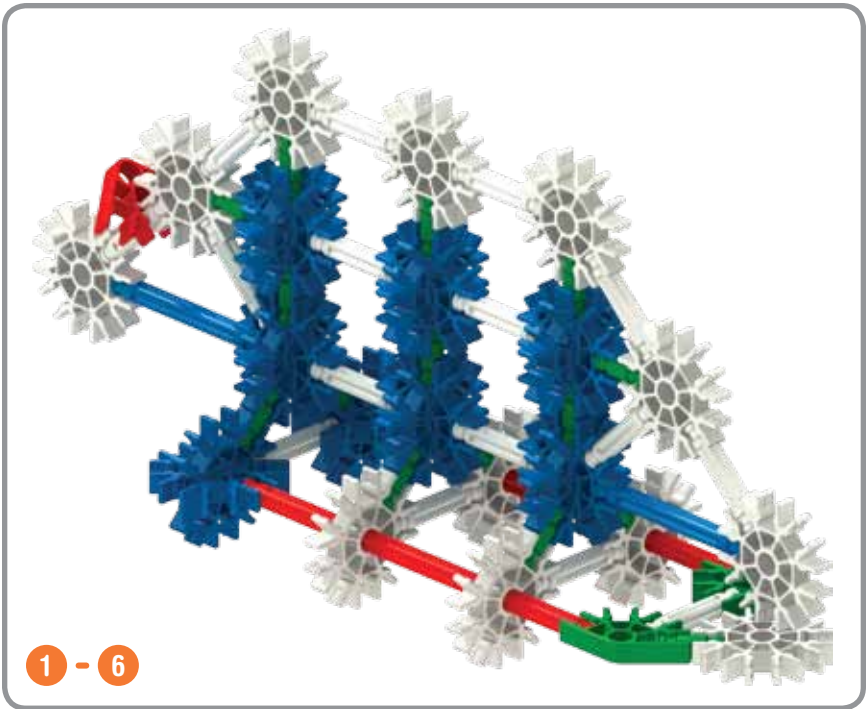
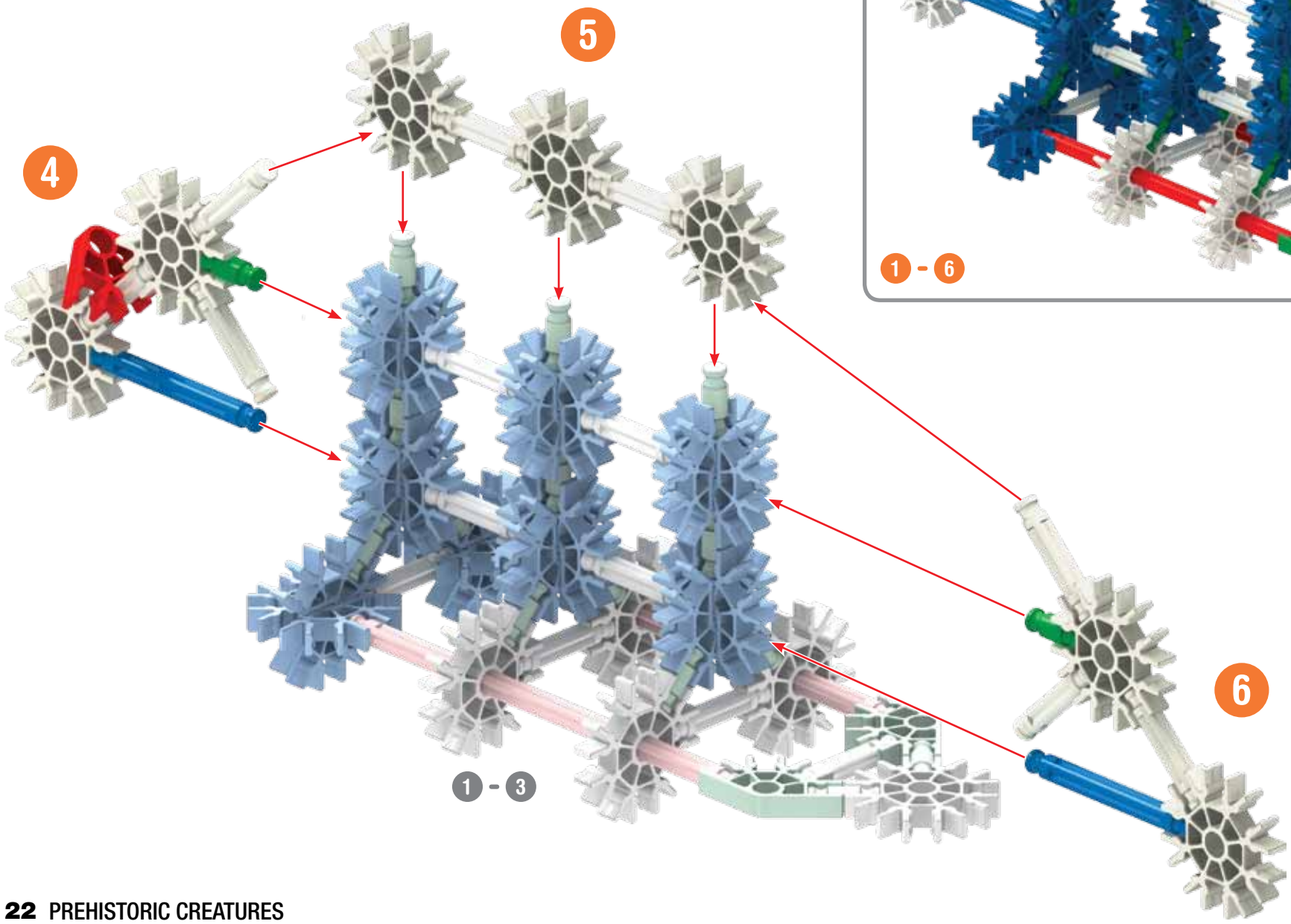

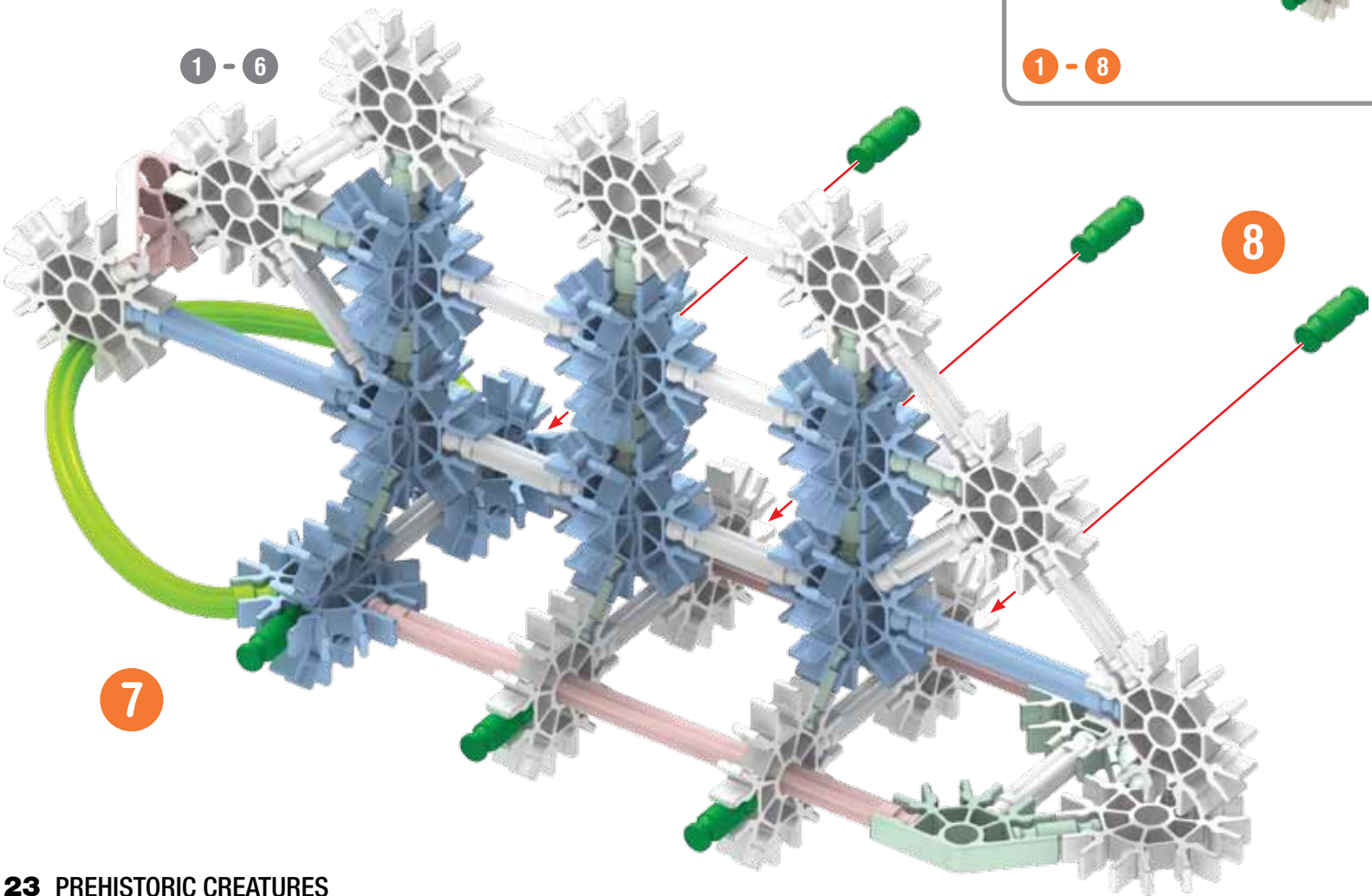
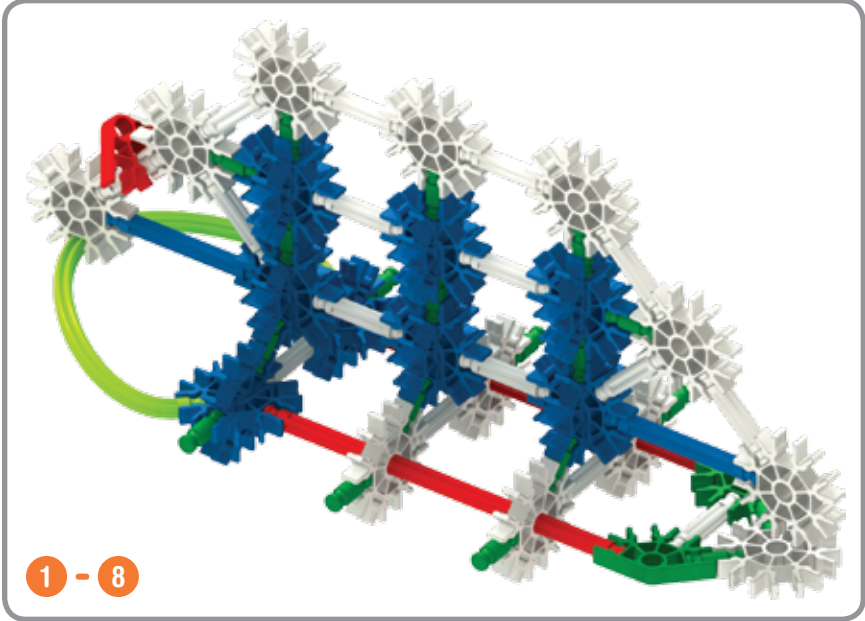

1 - 8

9		6		3	
3					
1					

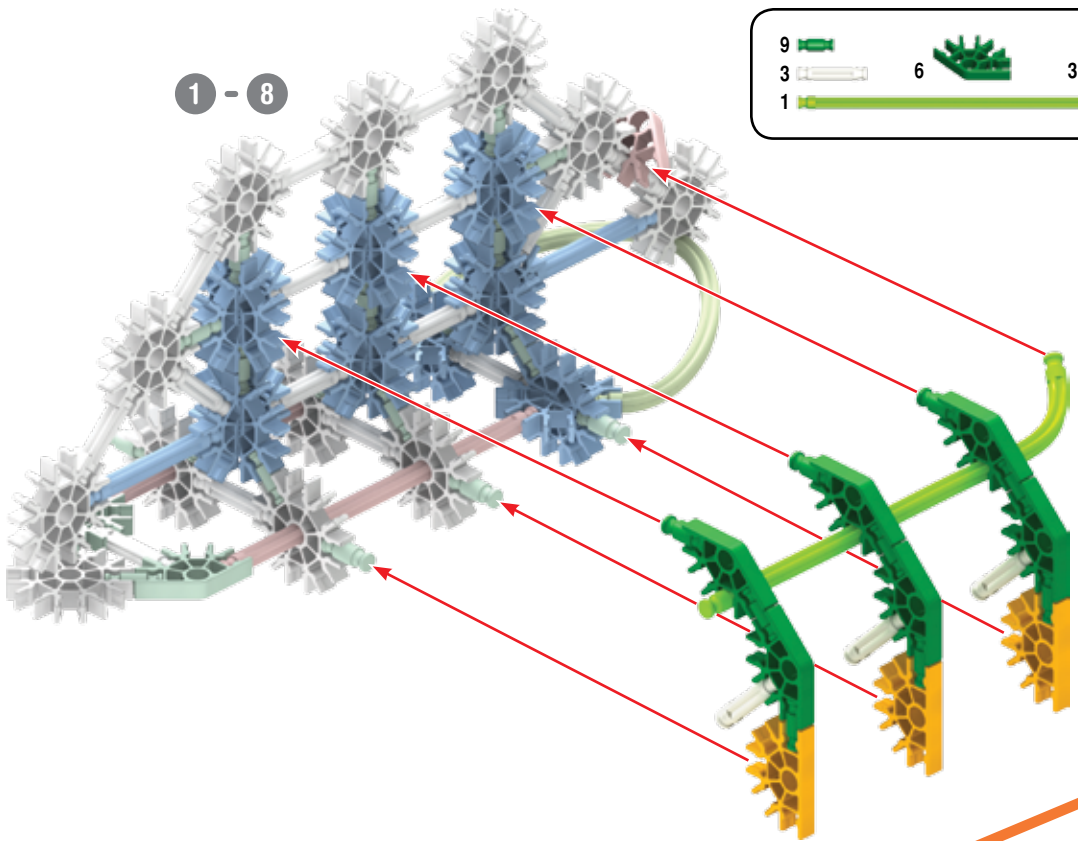

9

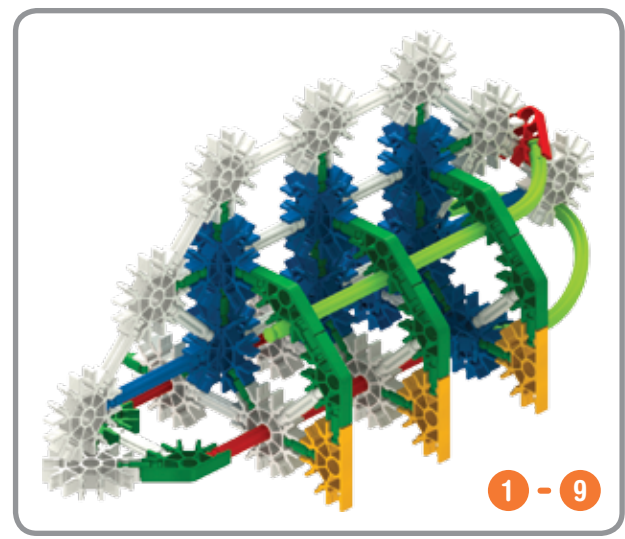

1 - 9

9		6		3	
3					
1					

1 - 9

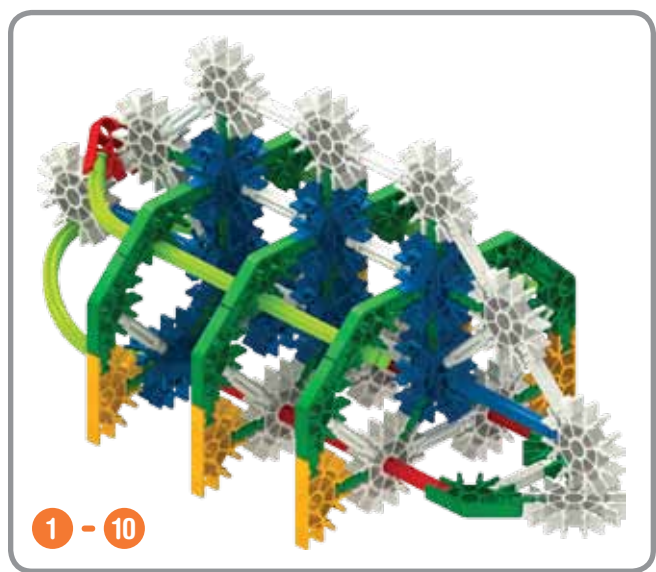

1 - 10

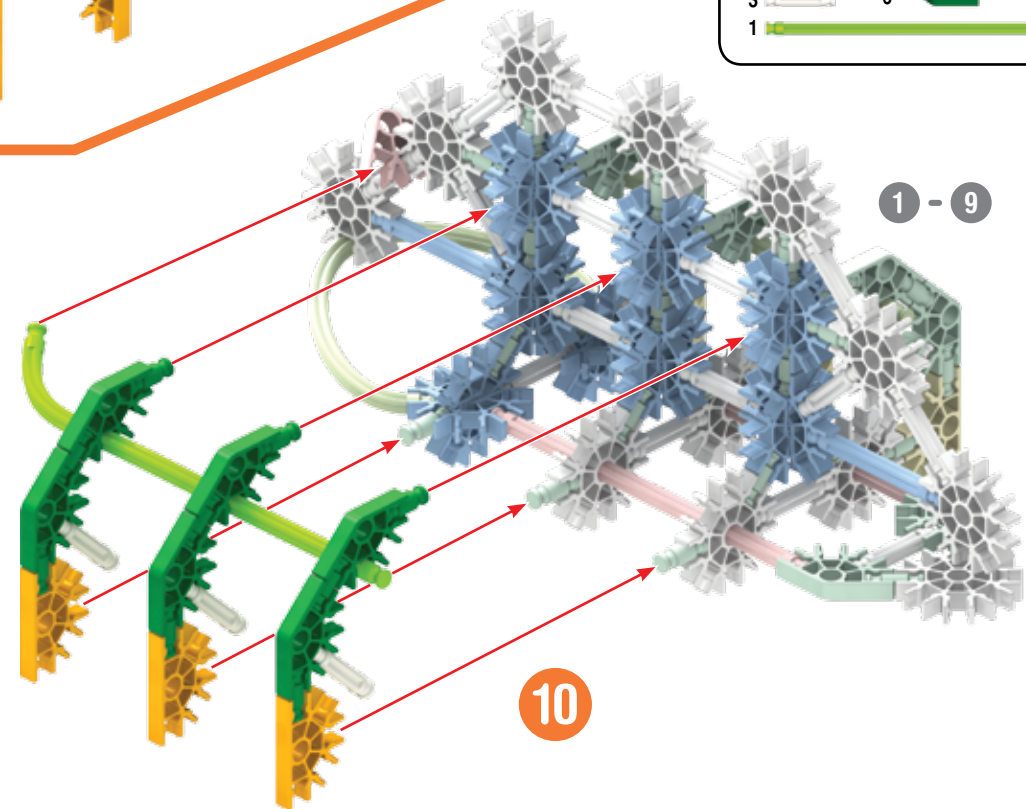

10

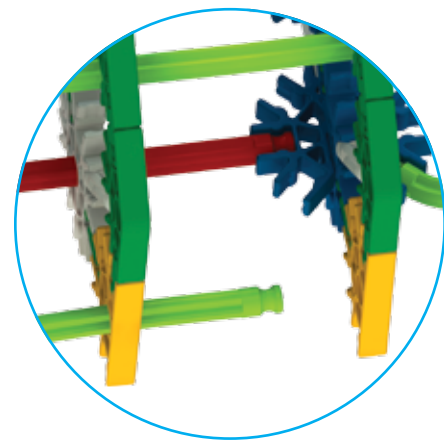
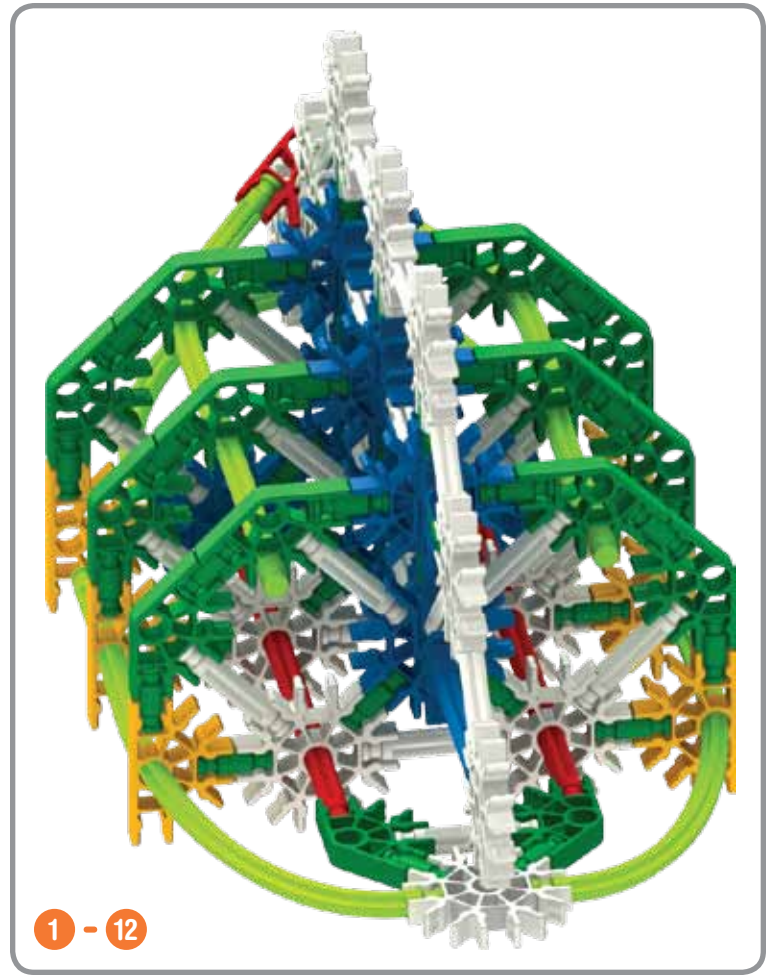
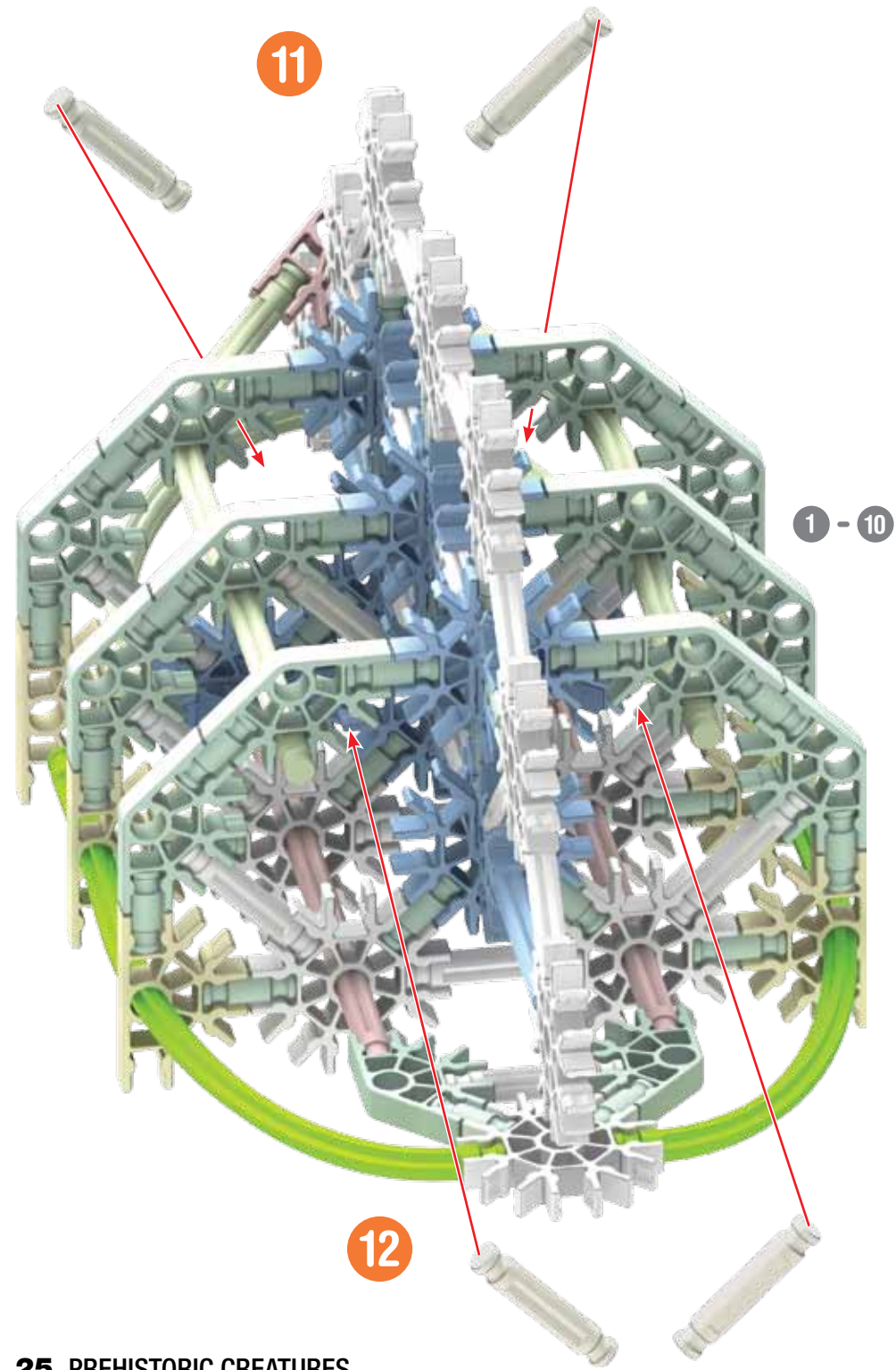

13

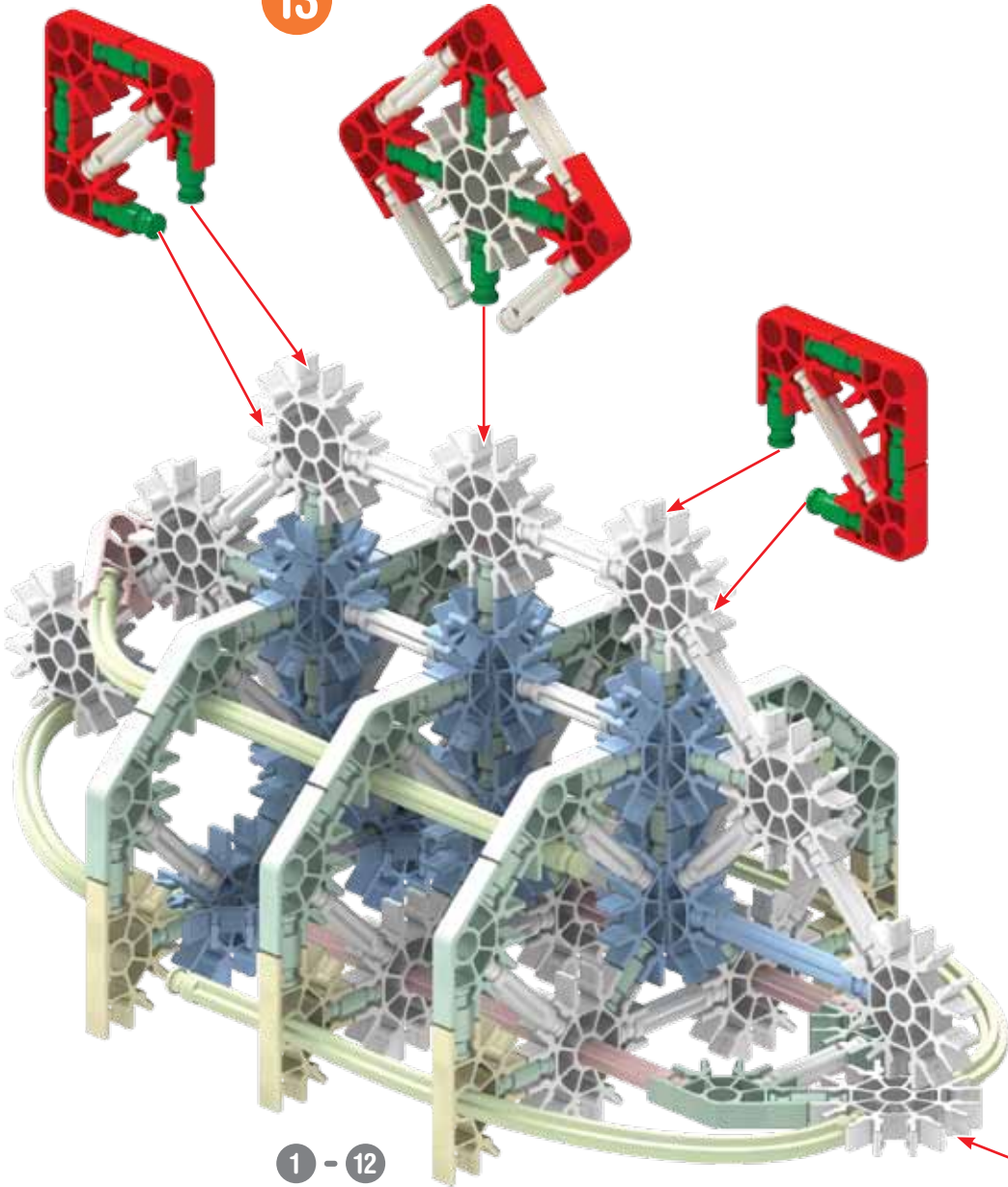

1 - 12



1 - 14

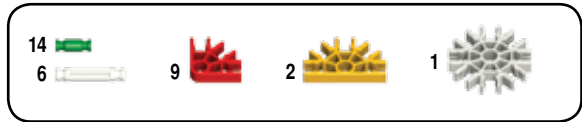

14



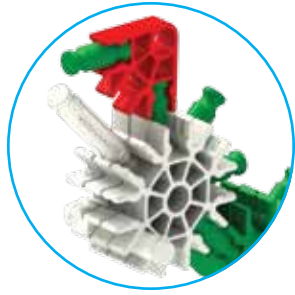

TIP: For this section of the model, it is easier to connect the rods to the connectors by pushing them from the side.

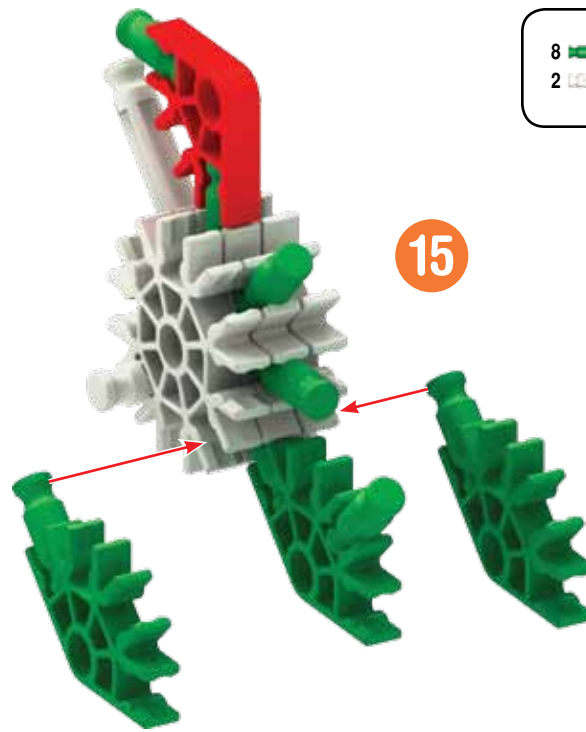

- | | | | | | | | |
|---|--|---|--|---|--|---|--|
| 8 | | 1 | | 3 | | 3 | |
| 2 | | | | | | | |

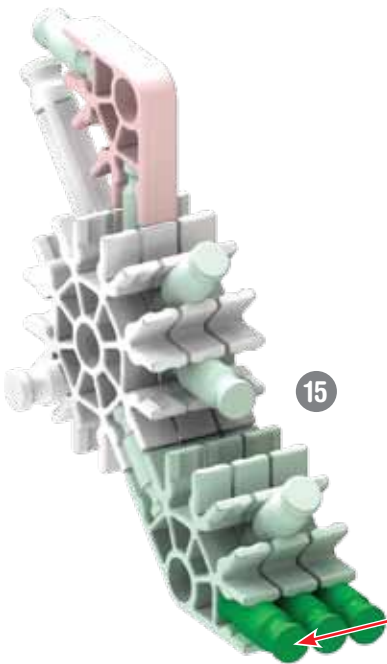

TIP: Connect white rod to the yellow connectors first.

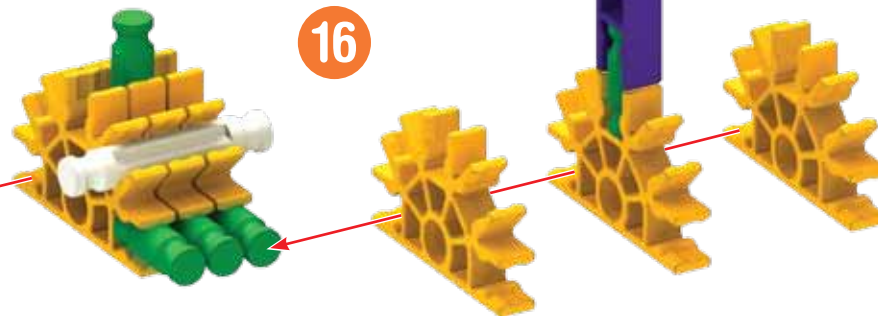

- | | | | | | |
|---|--|---|--|---|--|
| 8 | | 1 | | 6 | |
| 1 | | | | | |

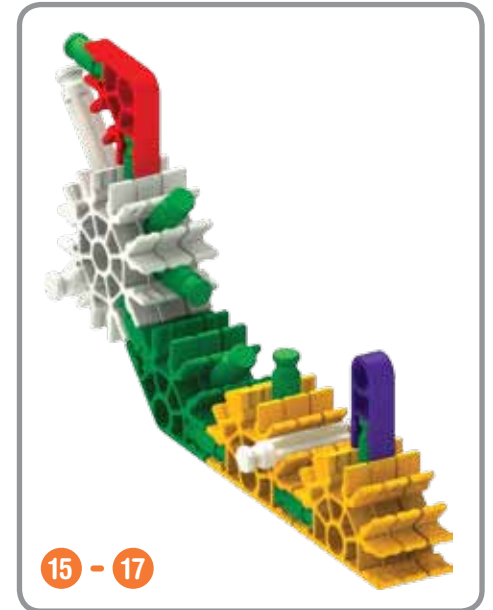

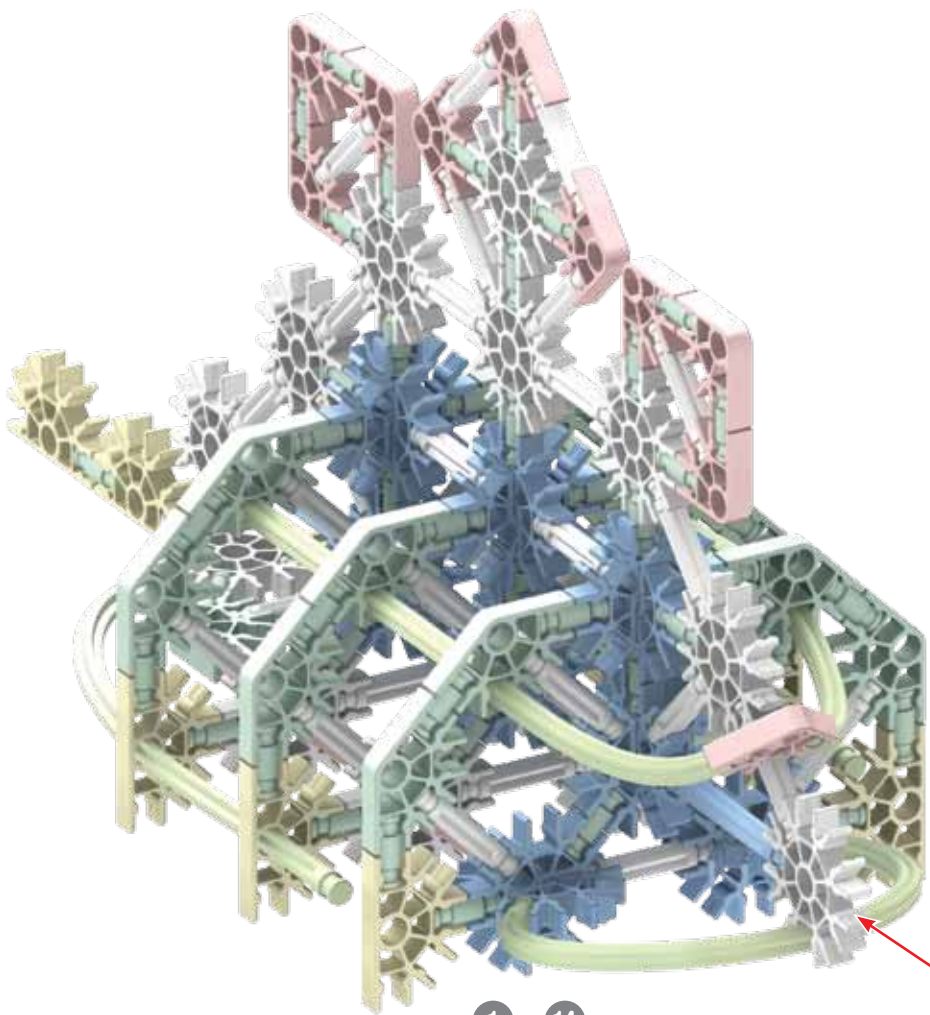

1 - 14

18



1 - 18



15 - 17

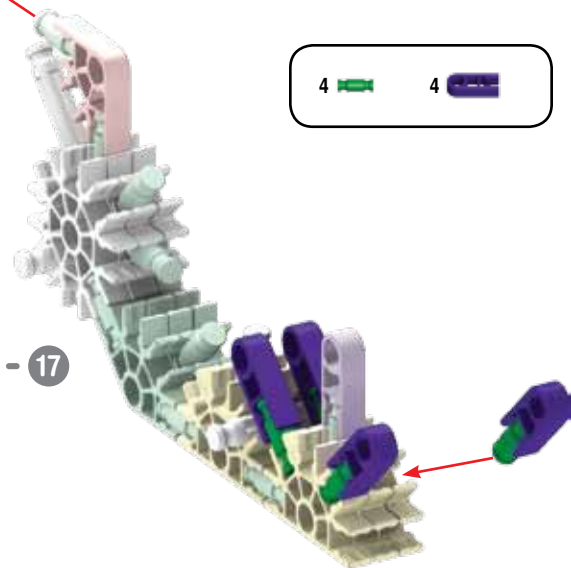

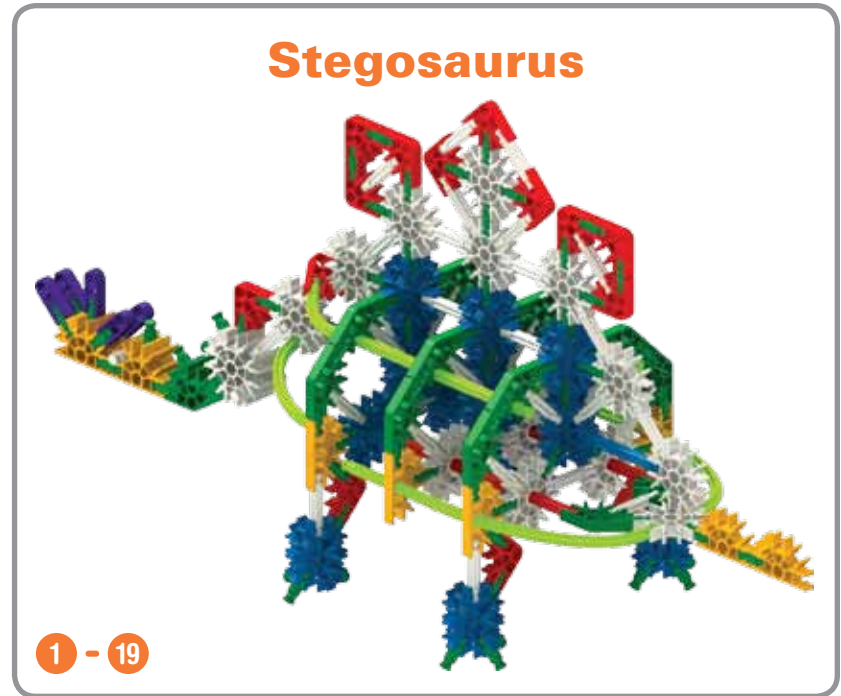
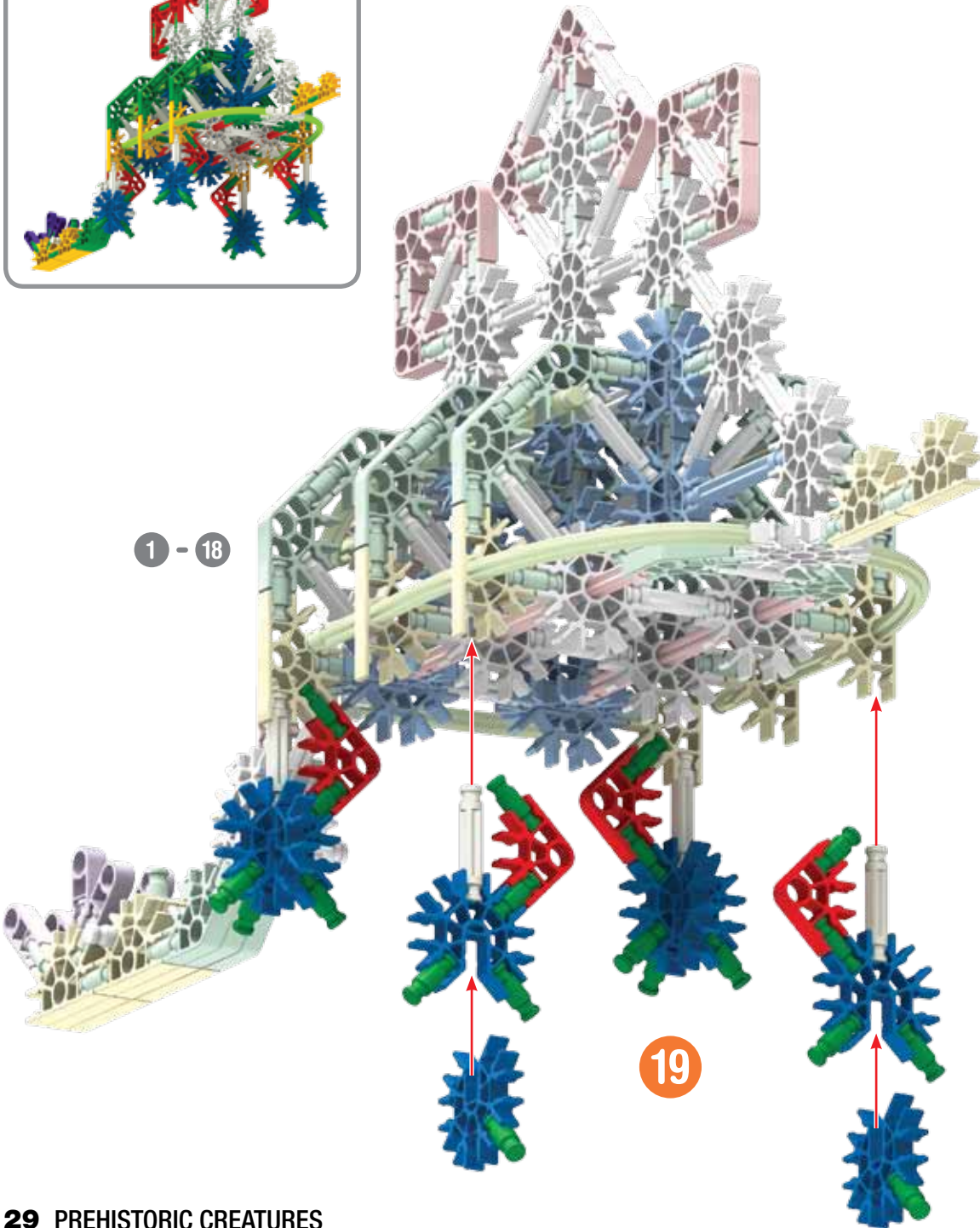

Triceratops

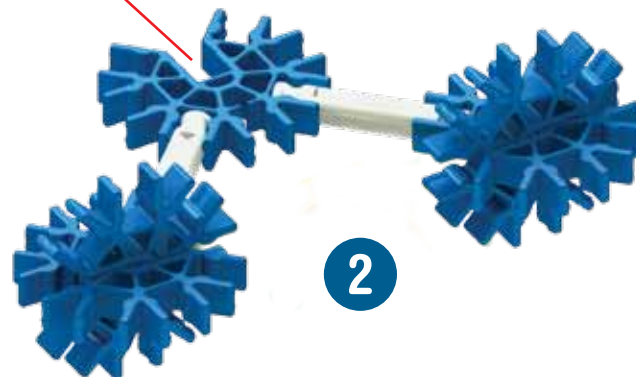
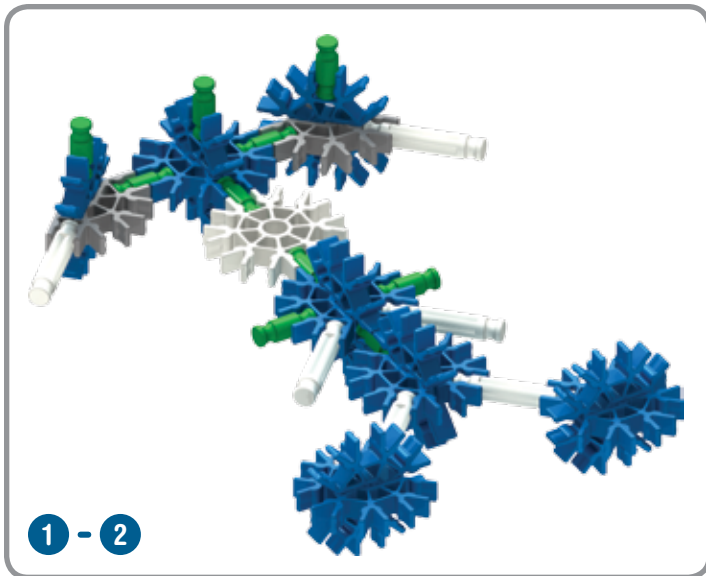
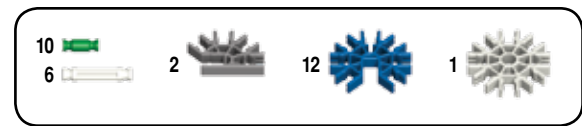
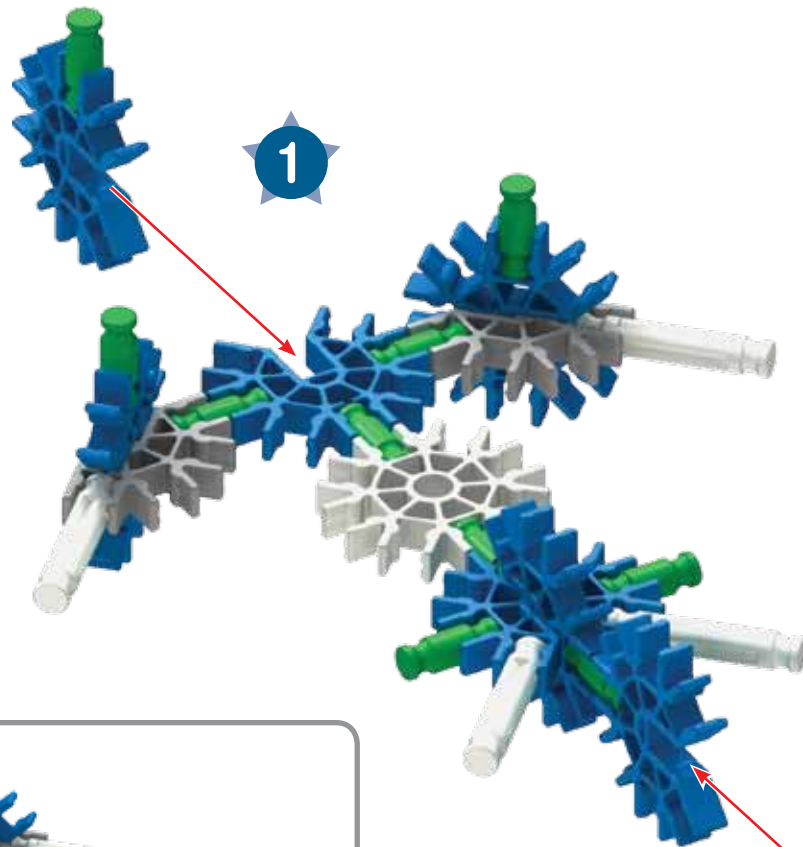
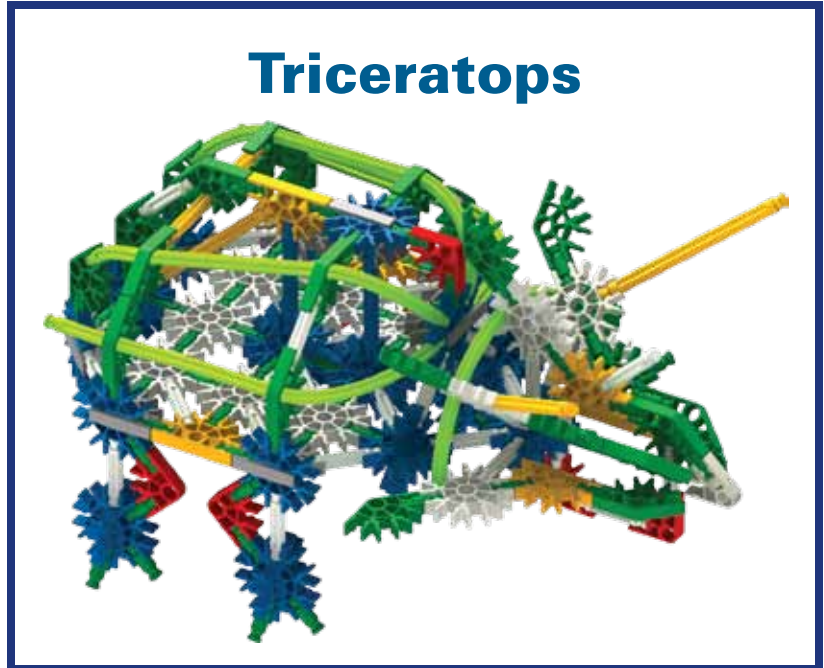

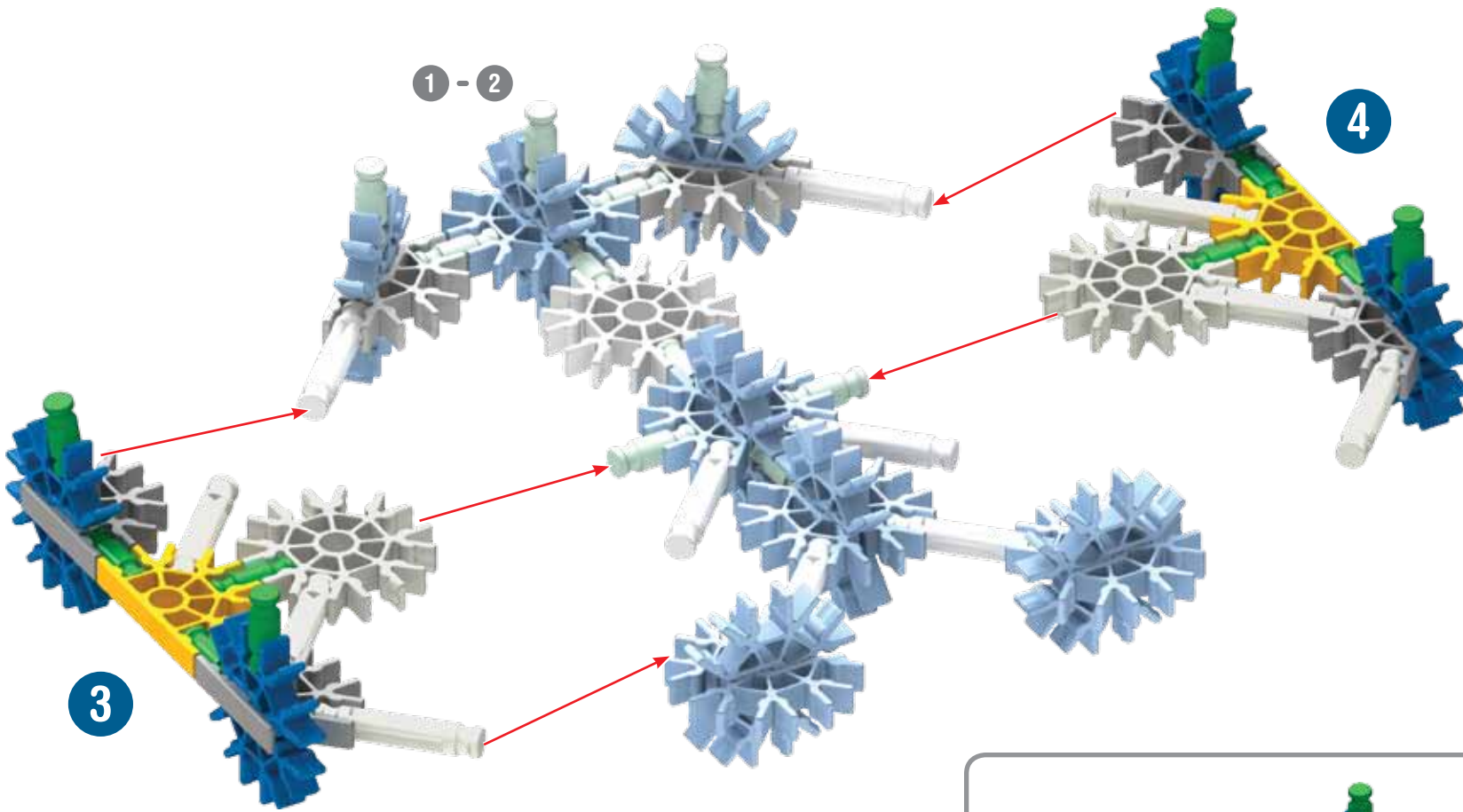

3

1 - 2

4

10		2		4		4		2	
6									

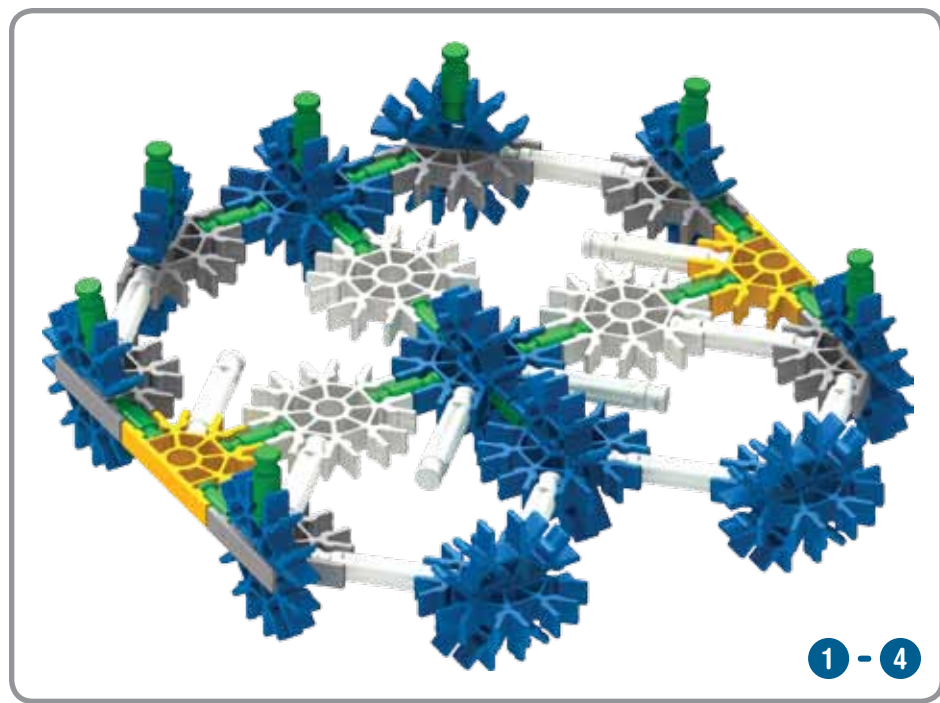

1 - 4

x4

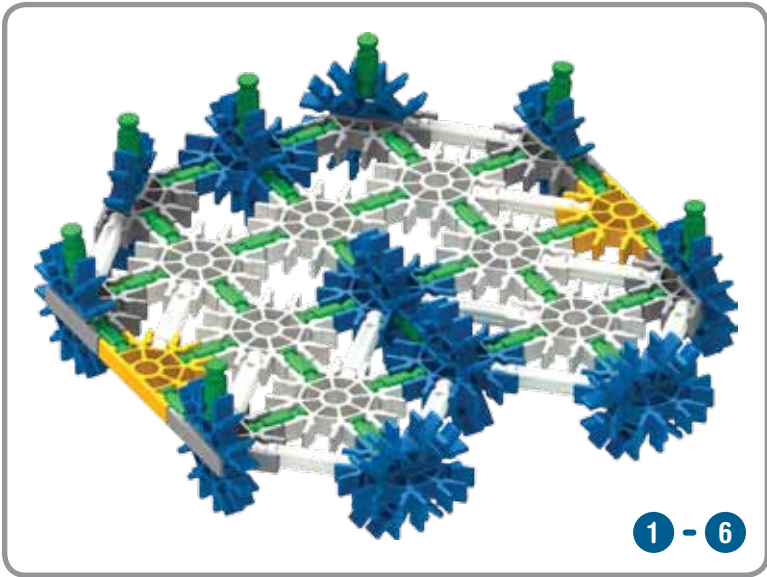
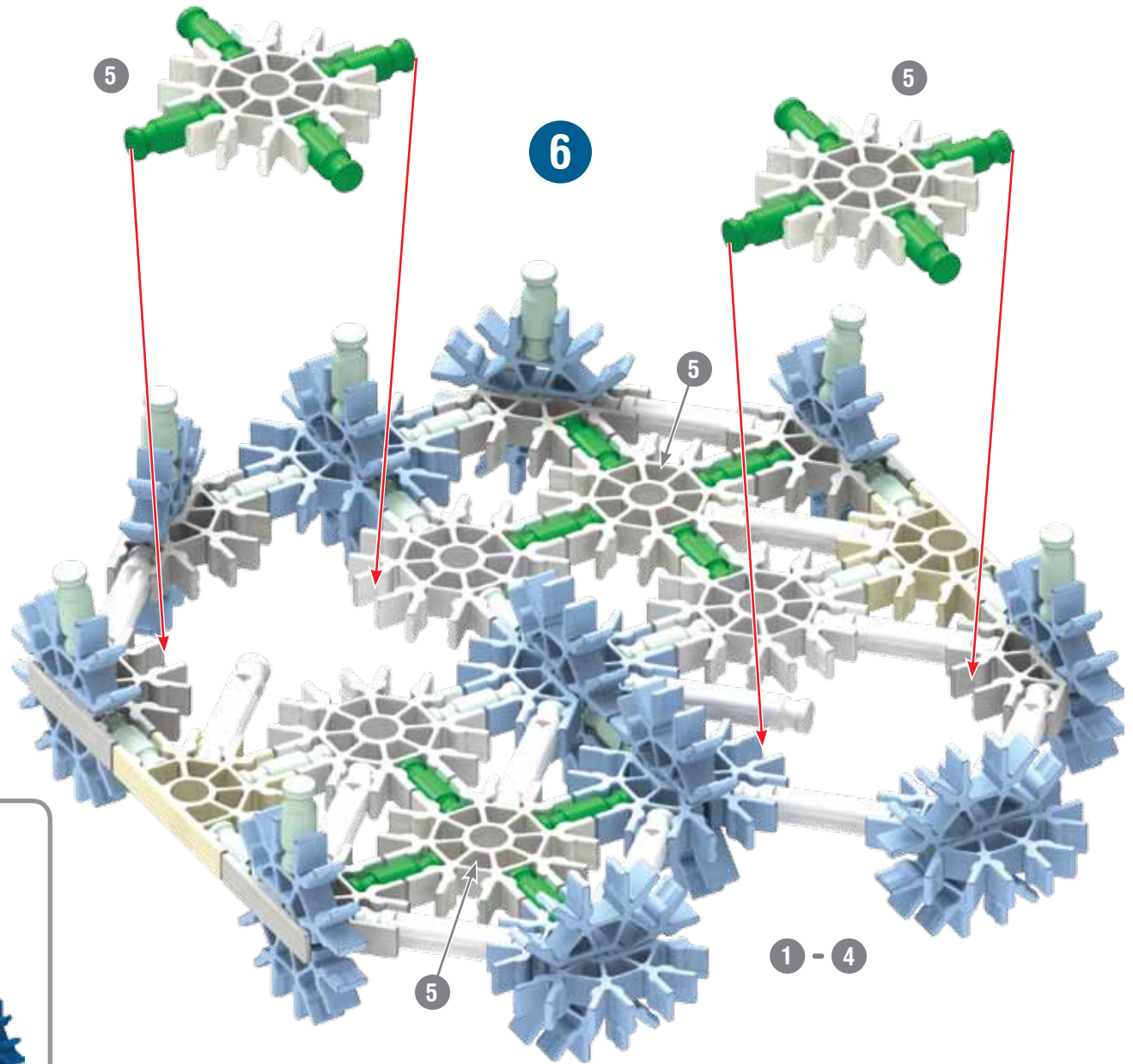
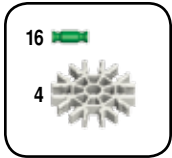
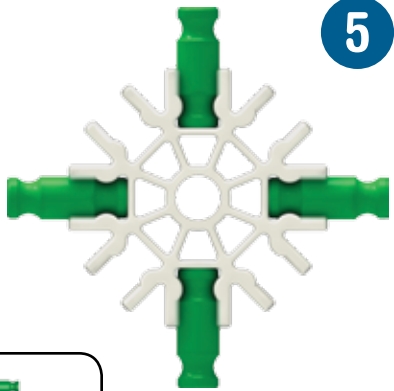

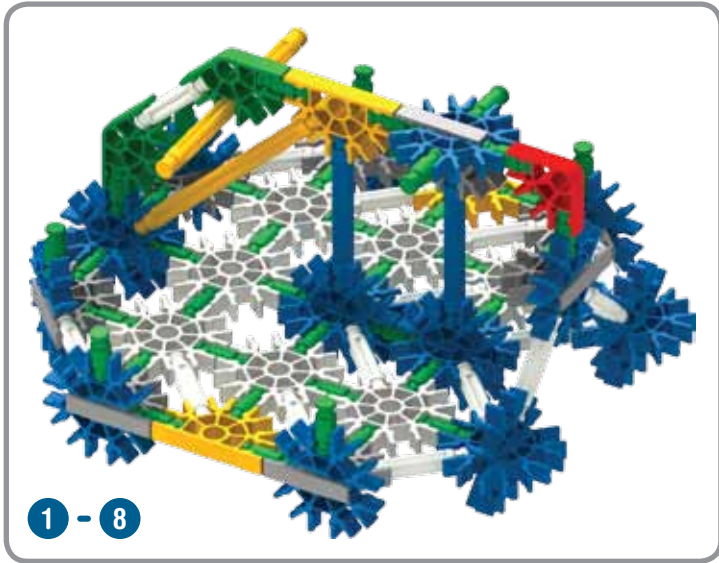
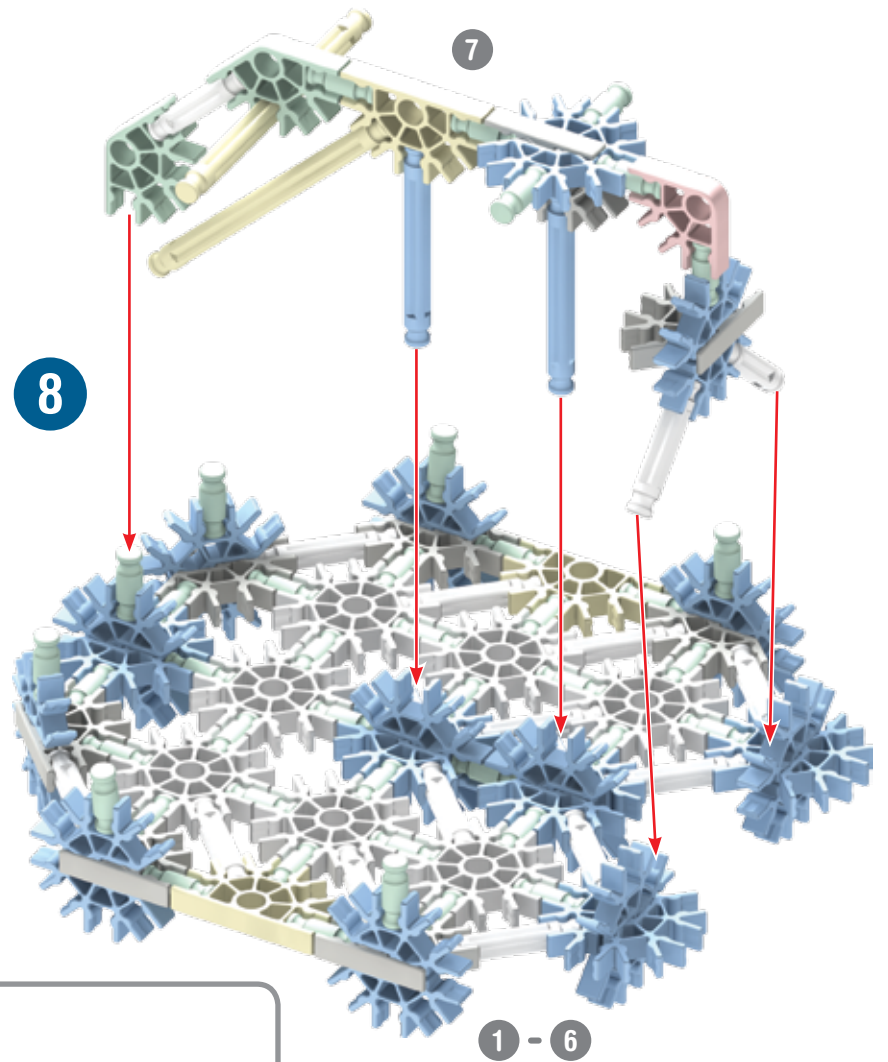
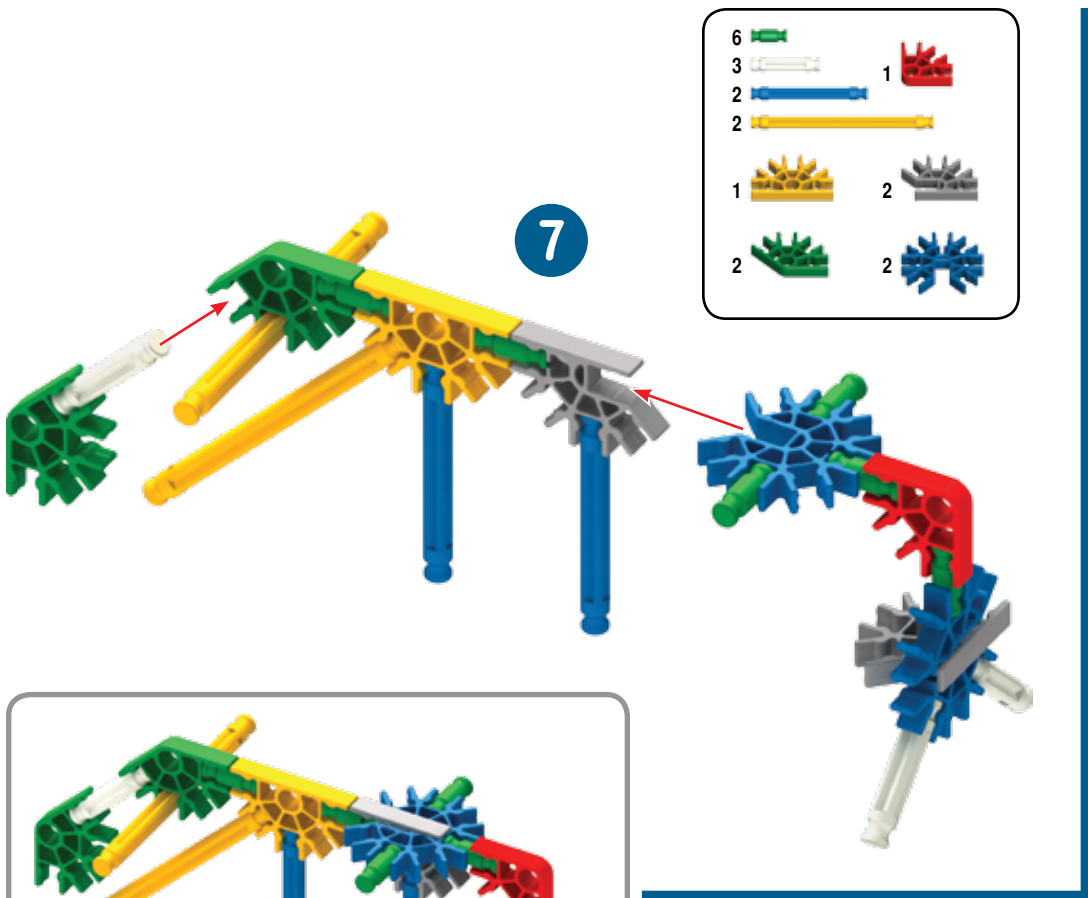

9

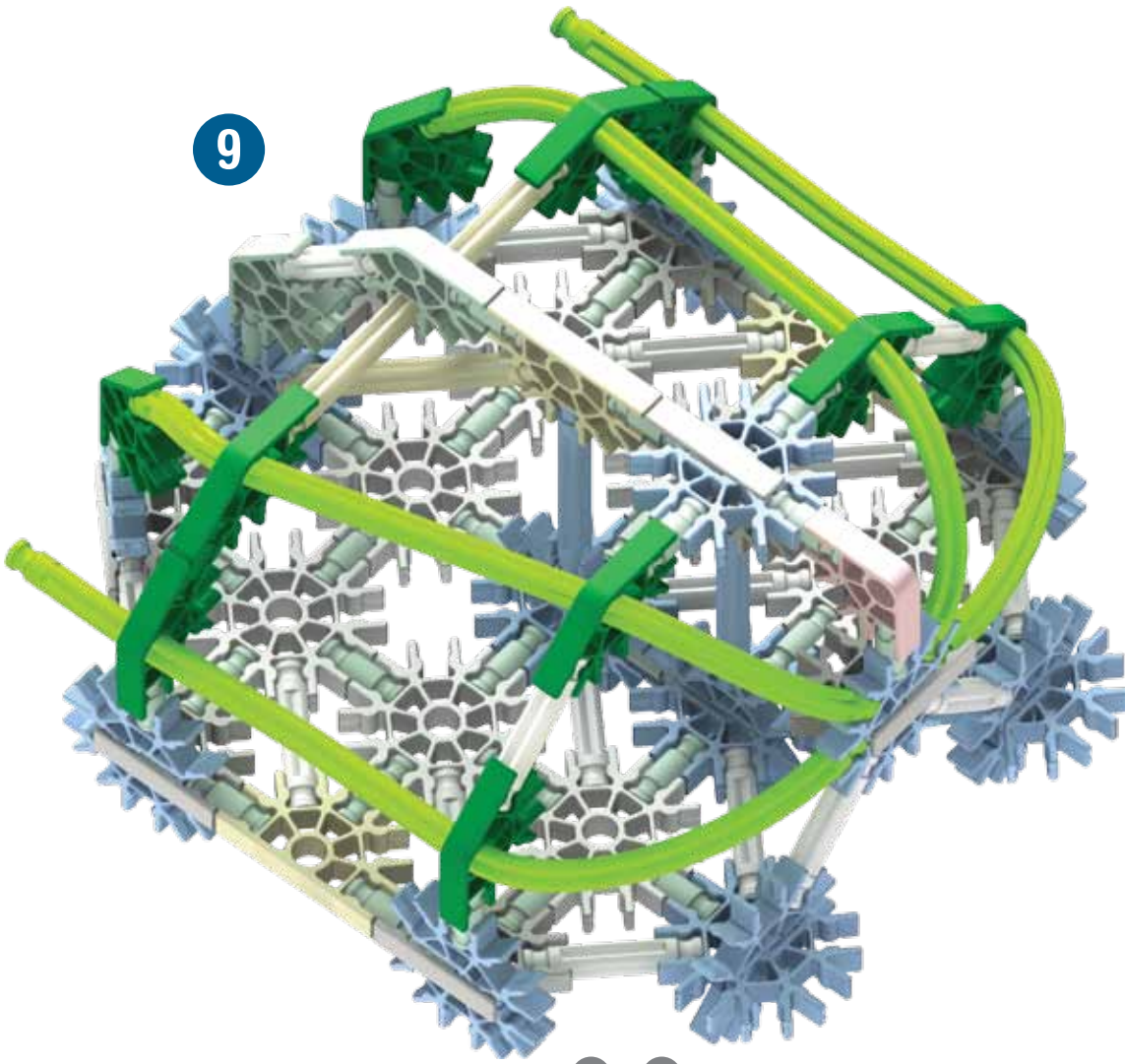

1 - 8

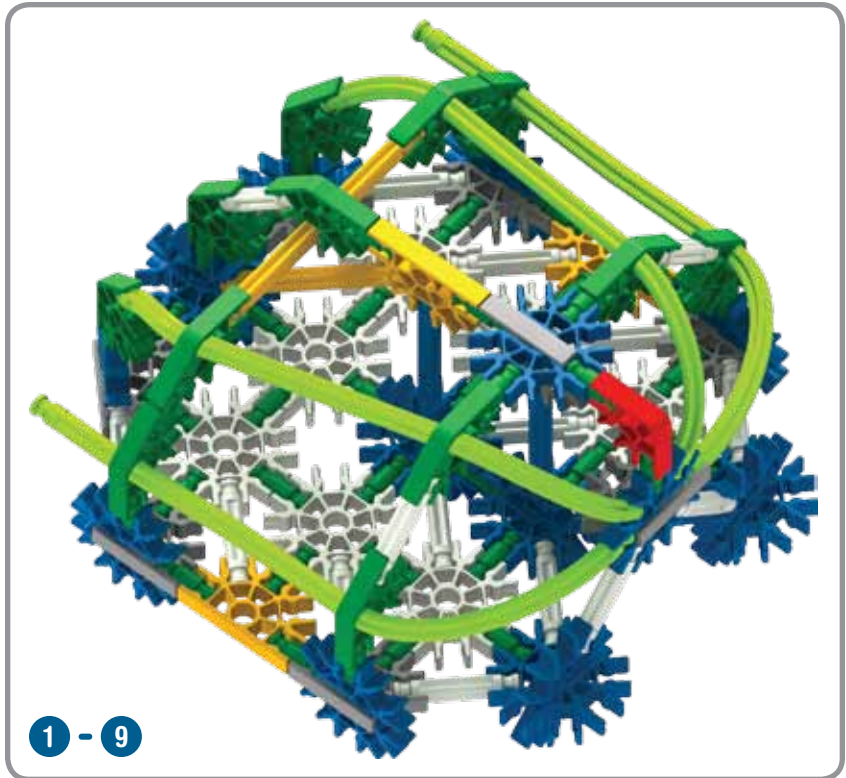
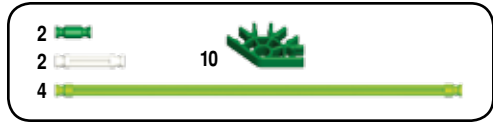

1 - 9

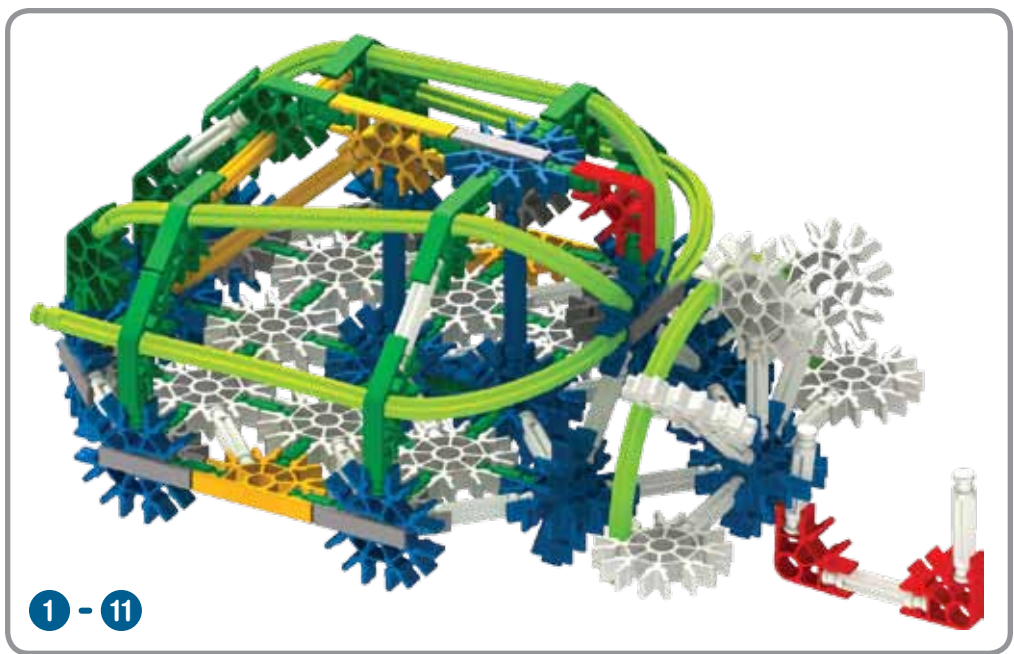
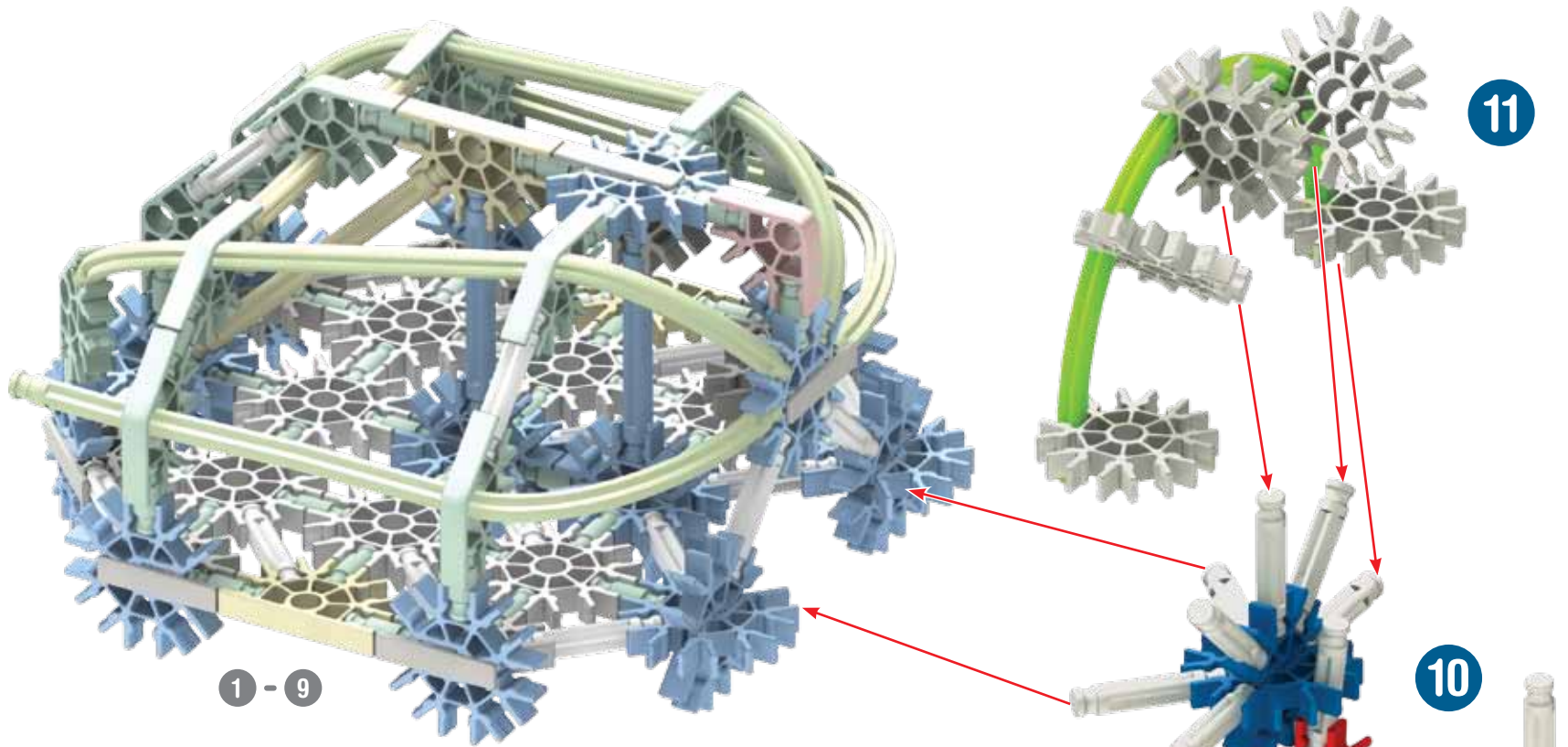

- | | |
|----|--|
| 10 | |
| 1 | |
| 2 | |
| 2 | |
| 5 | |

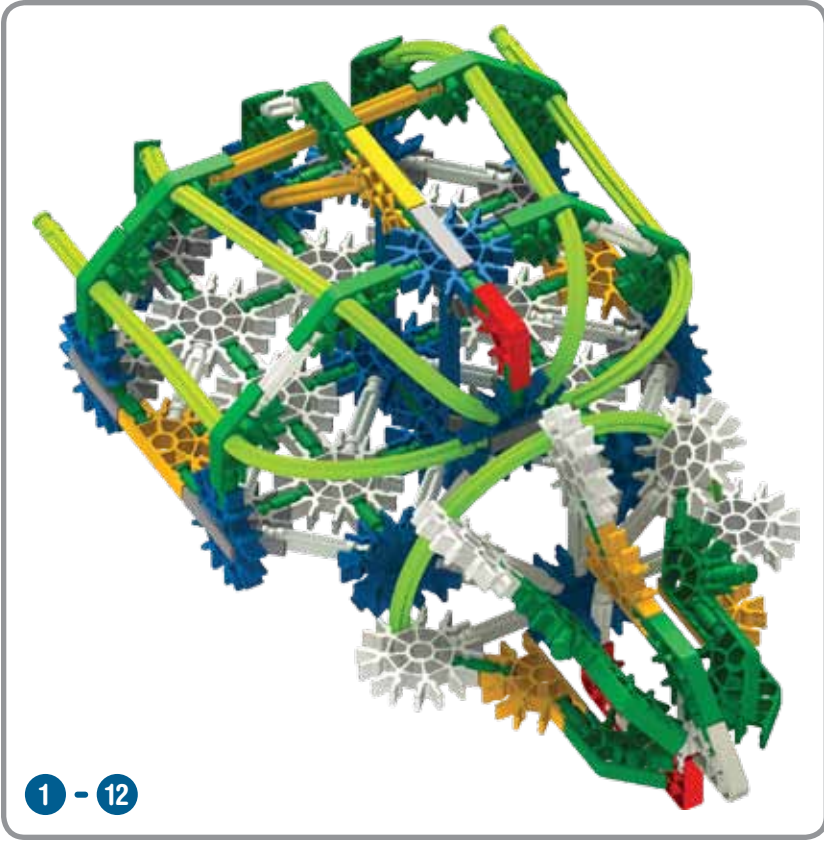
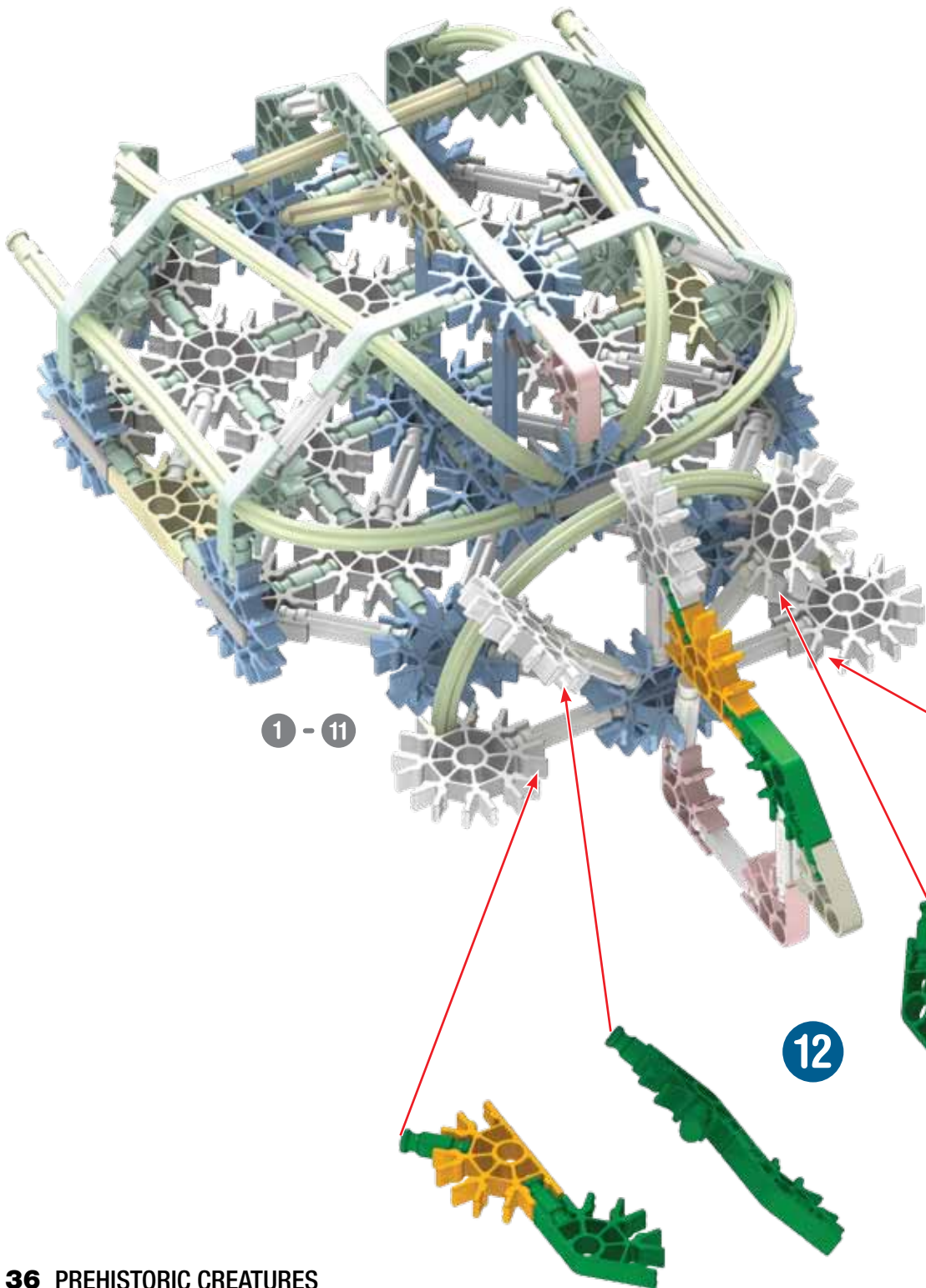

- | | | | |
|----|--|---|--|
| 13 | | 3 | |
| 1 | | 7 | |



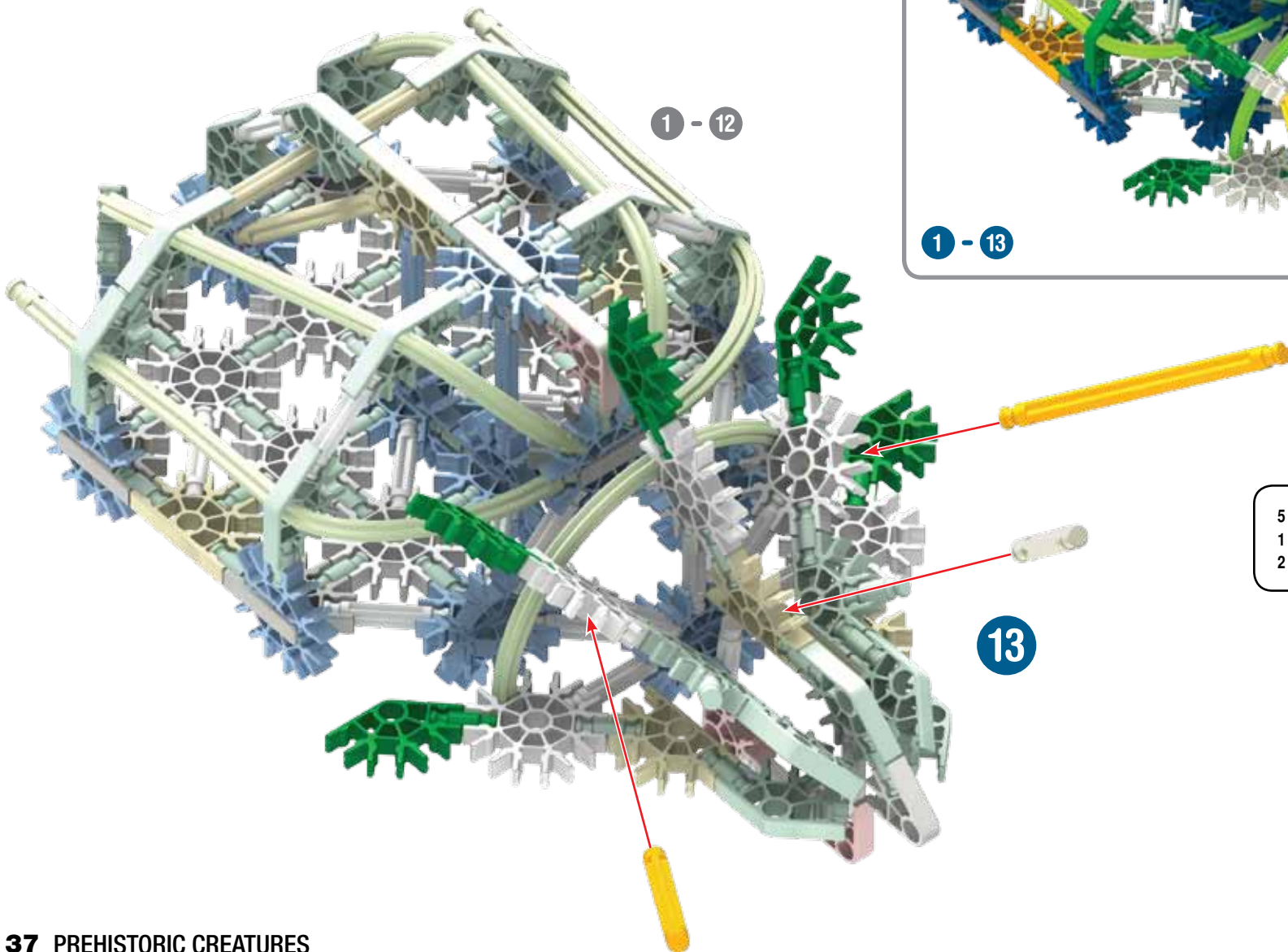

12

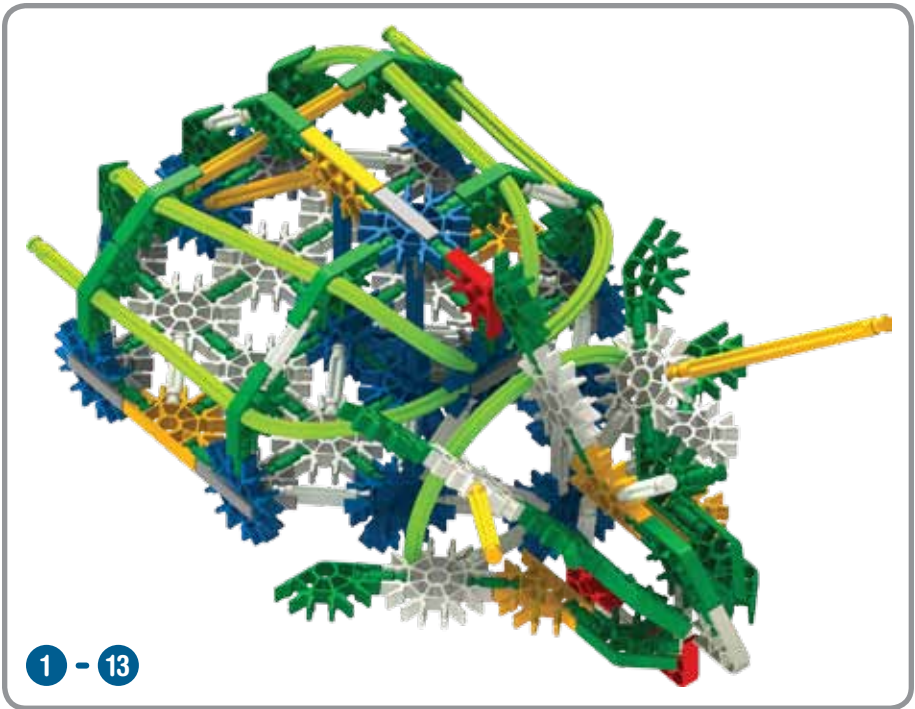

1 - 12



1 - 13

- | | | | |
|---|---|---|---|
| 5 |  | 5 |  |
| 1 |  | | |
| 2 |  | | |

13

1 - 13

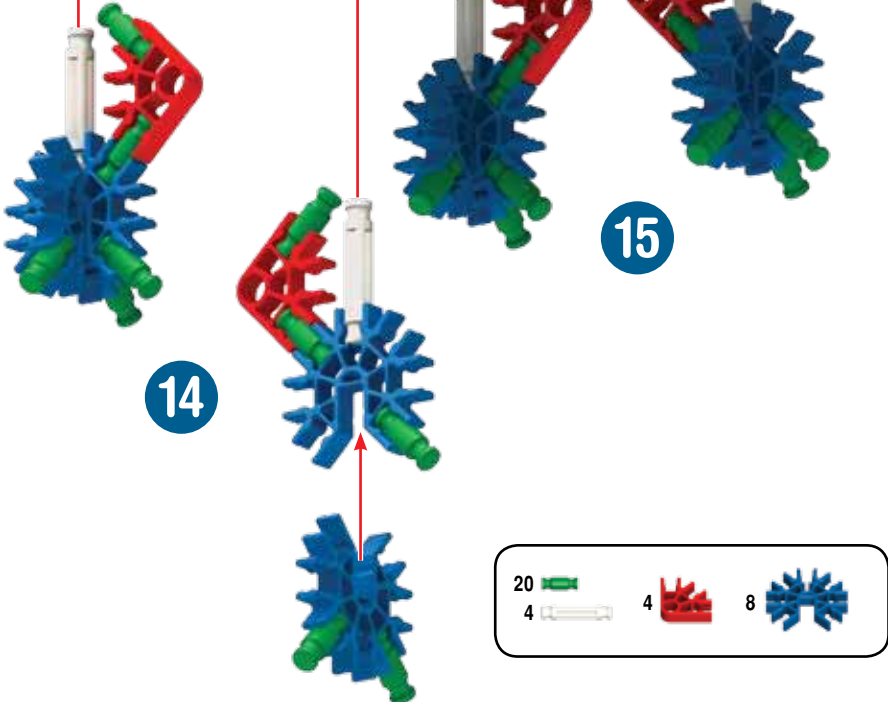
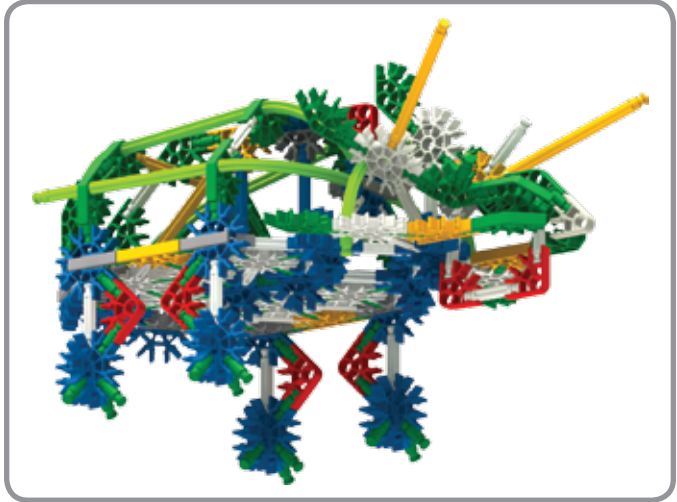
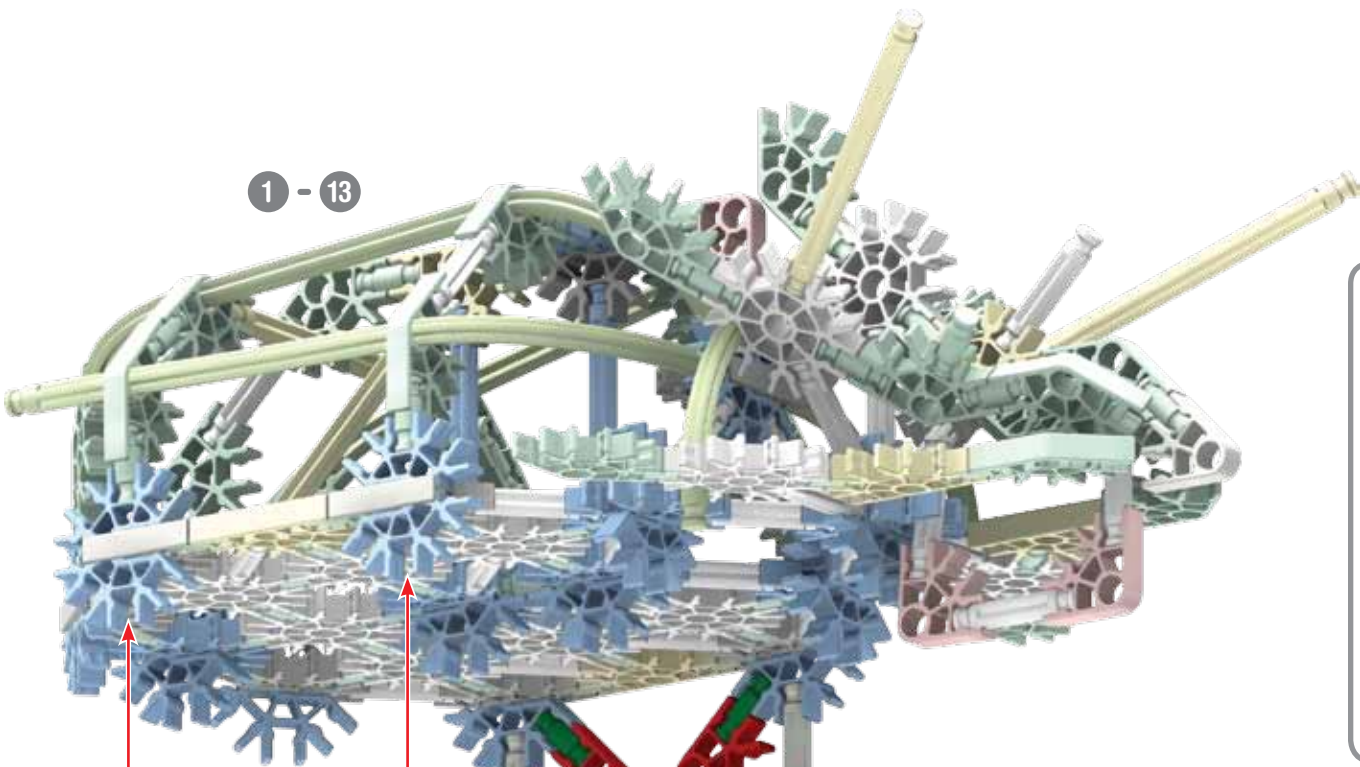

14

15



Triceratops

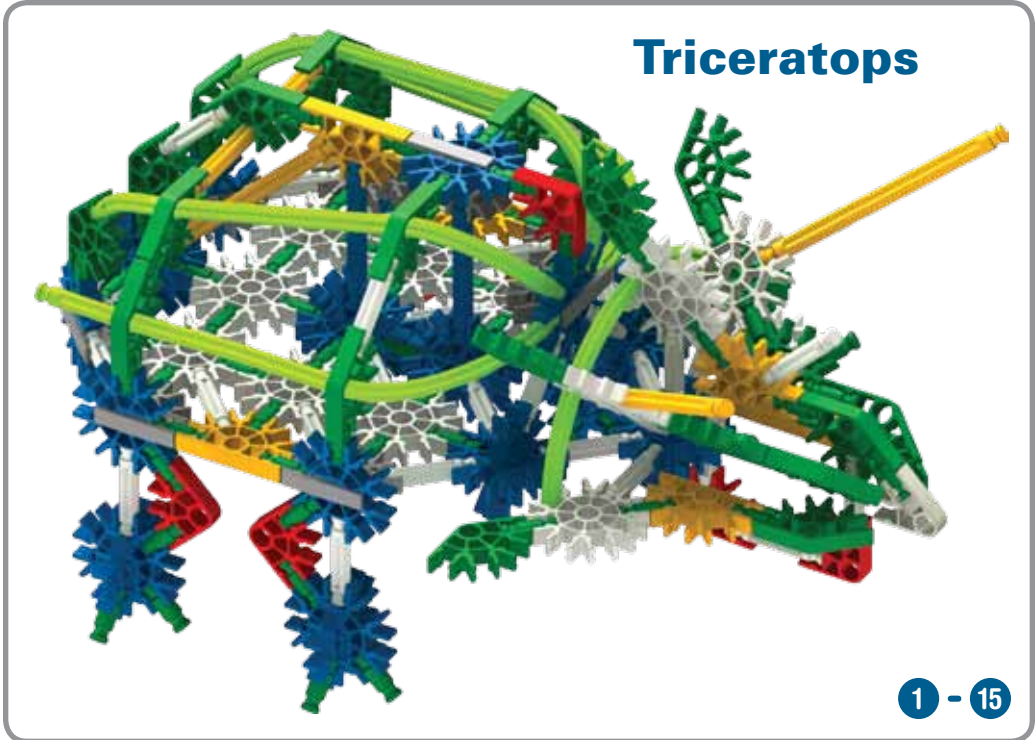

1 - 15

Woolly Mammoth

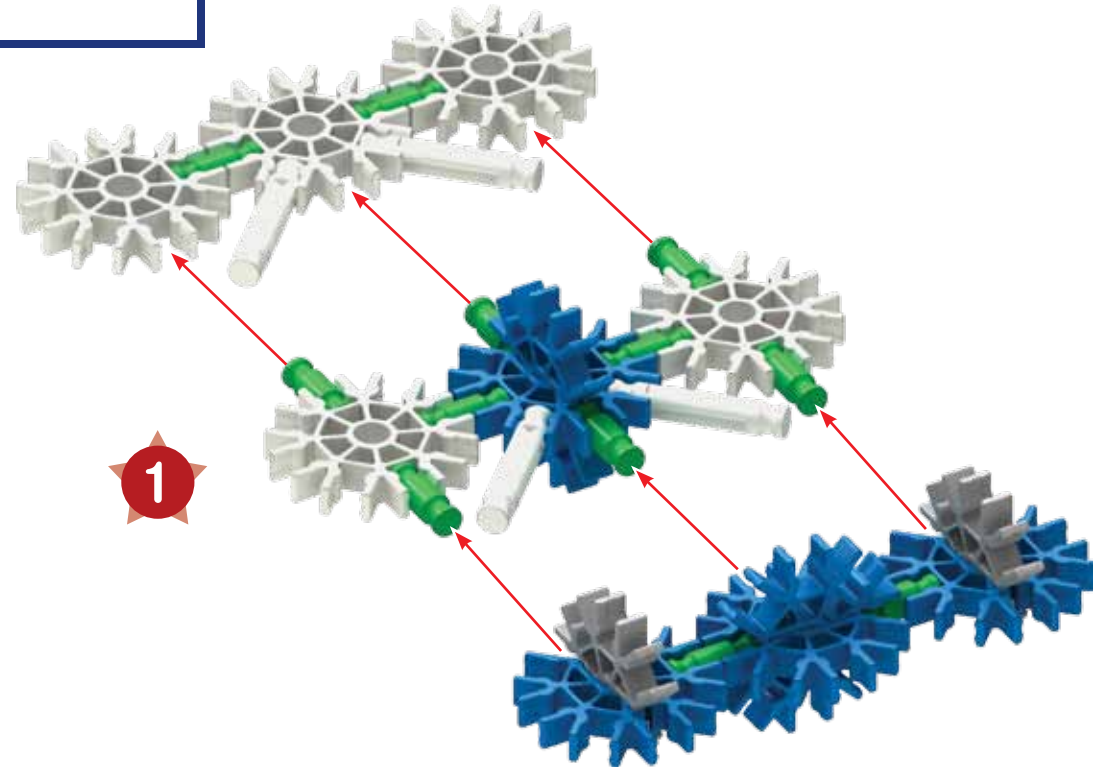
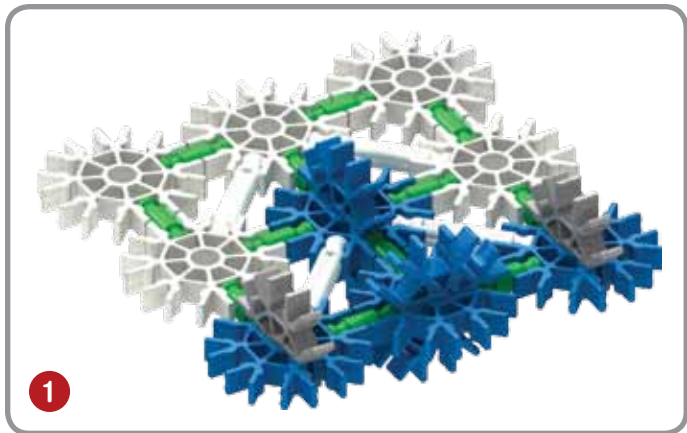
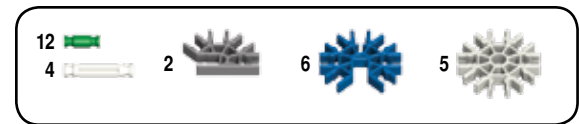

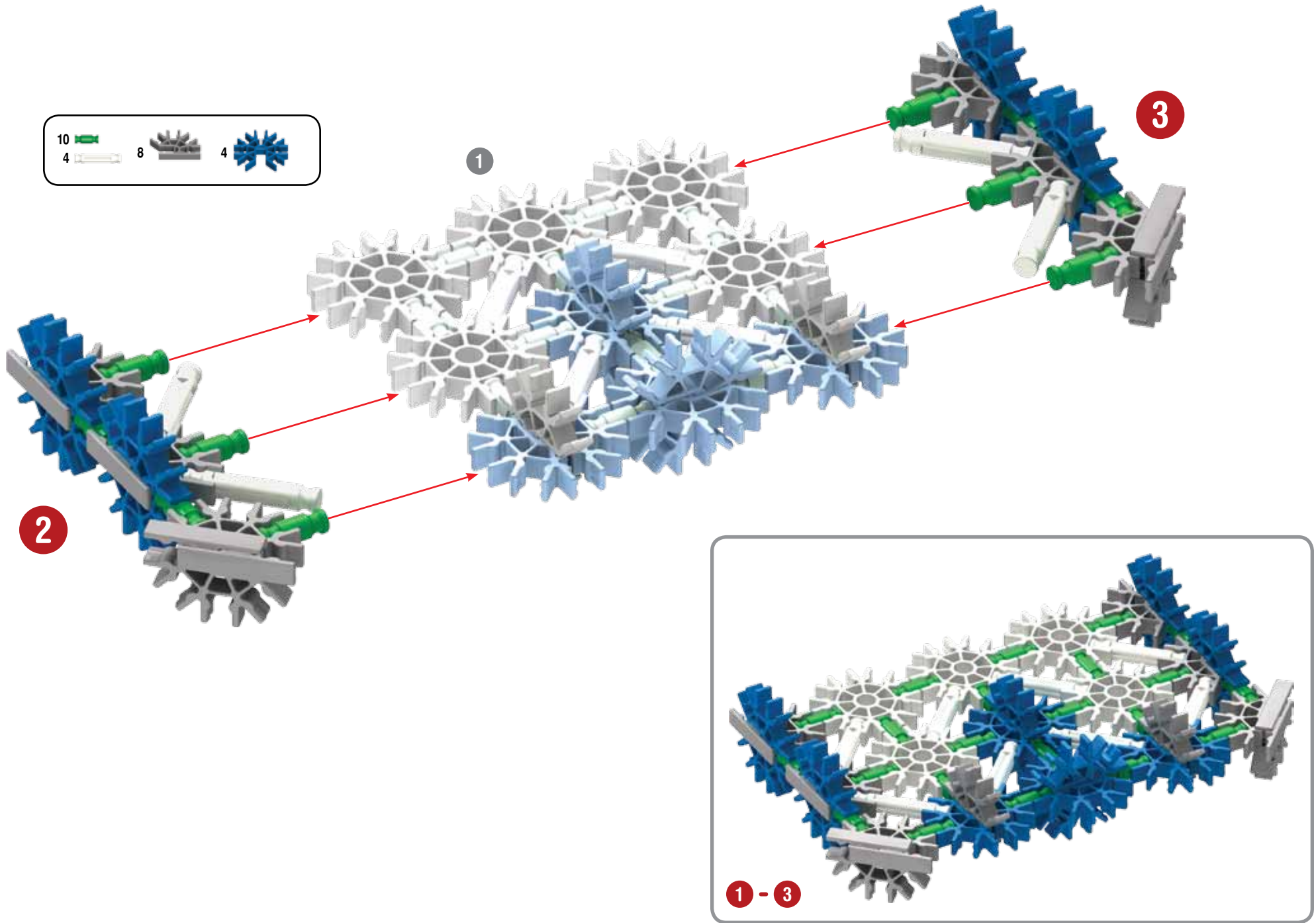

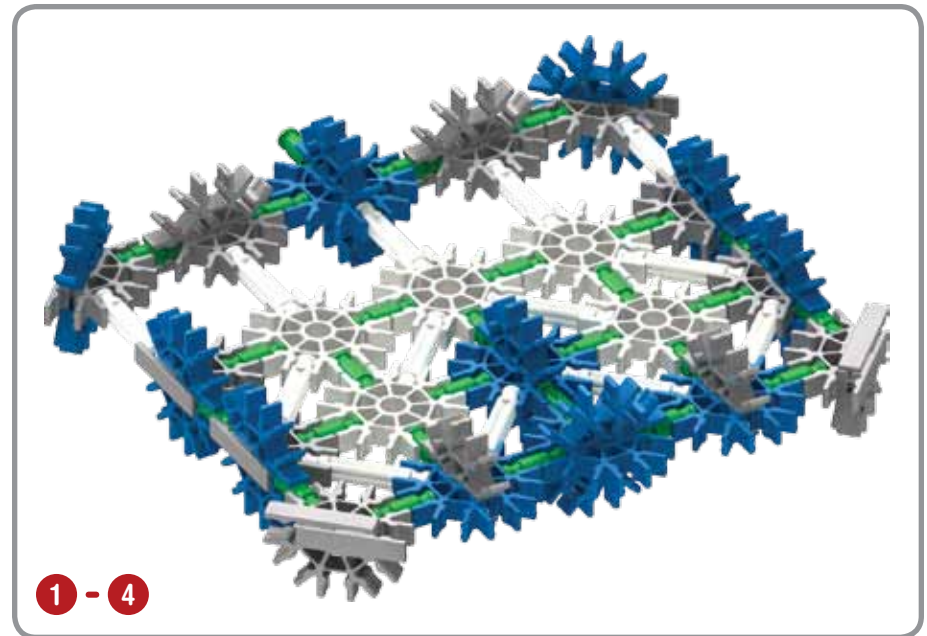
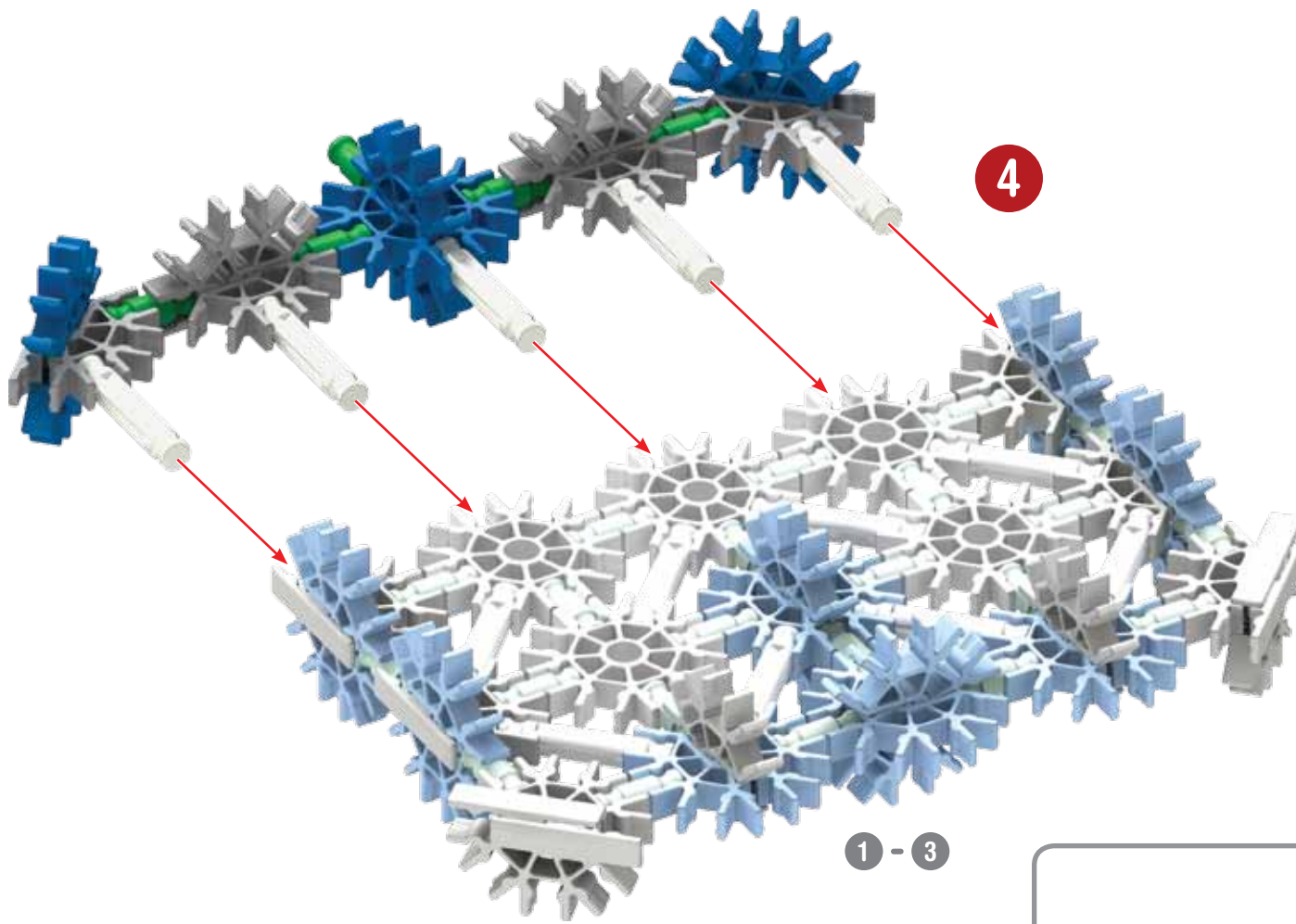

1 - 4

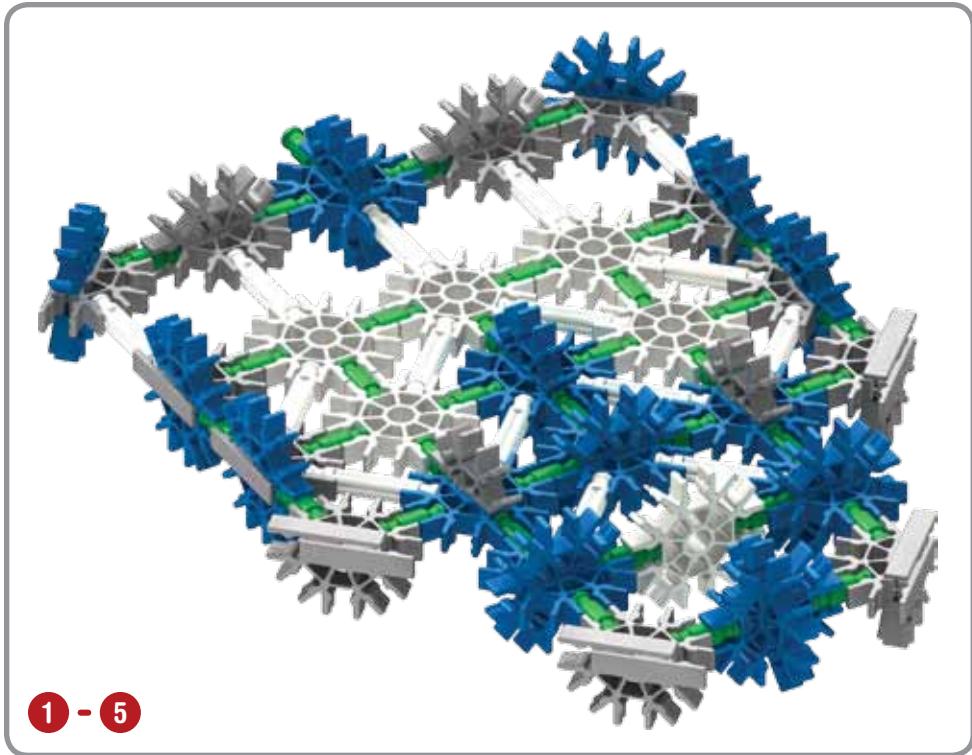
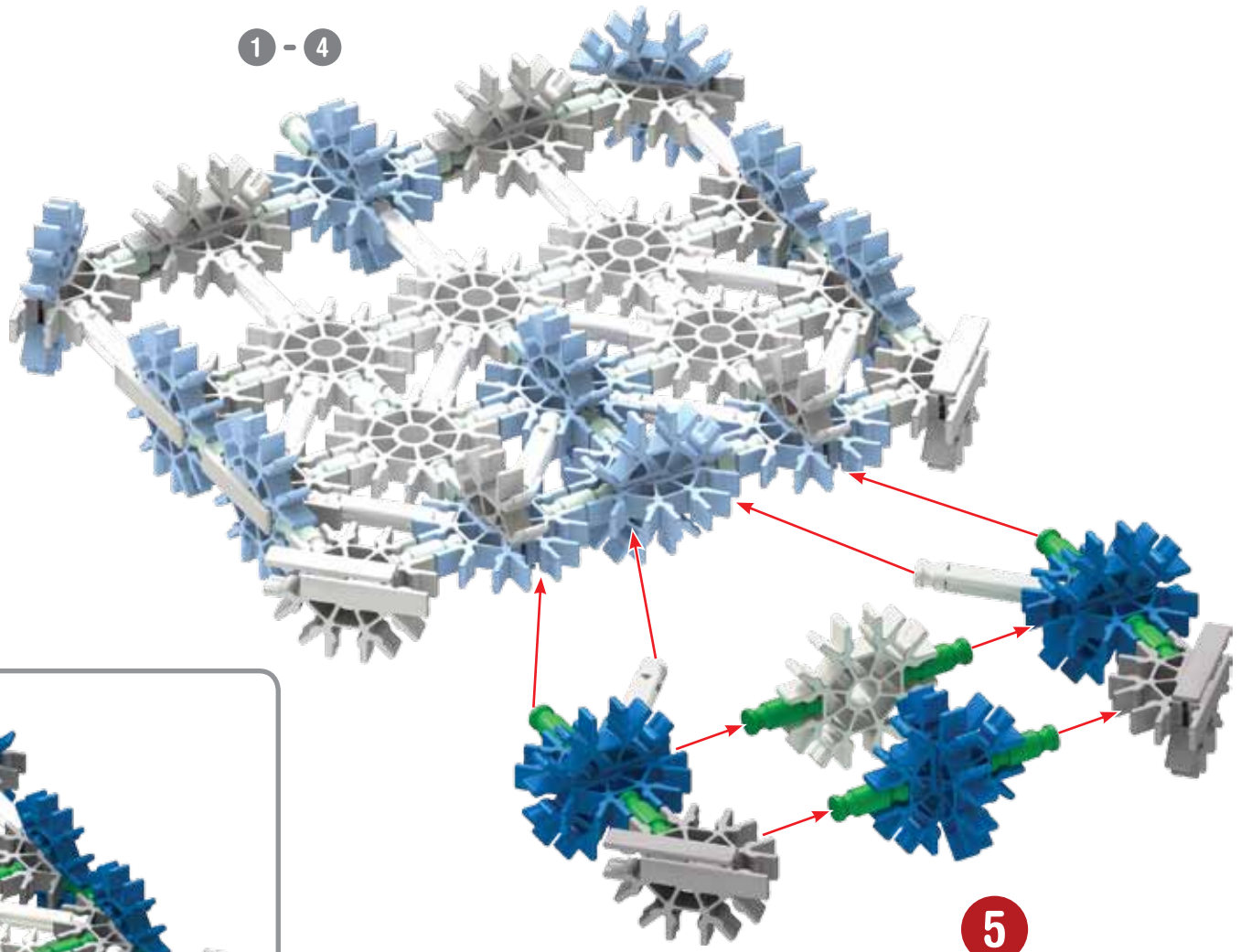

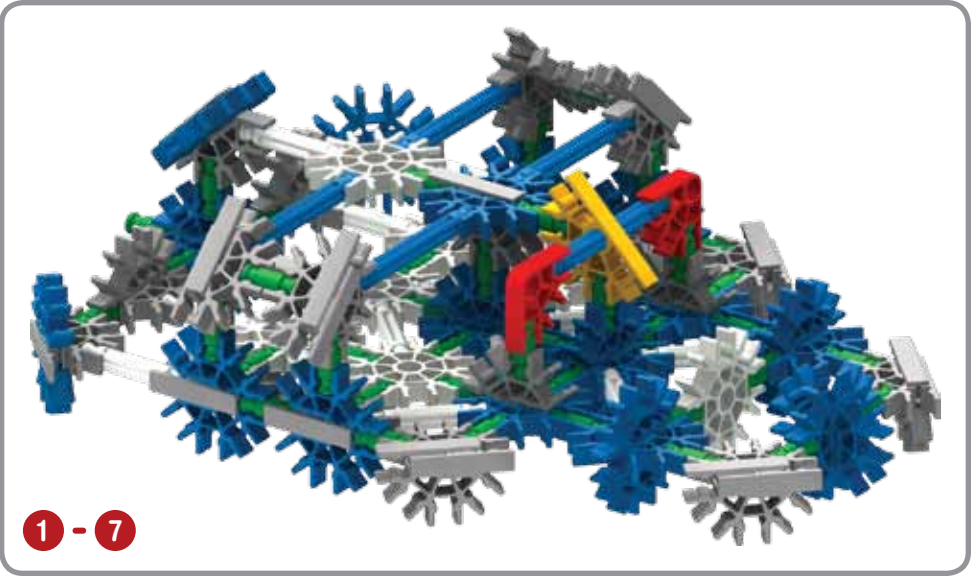
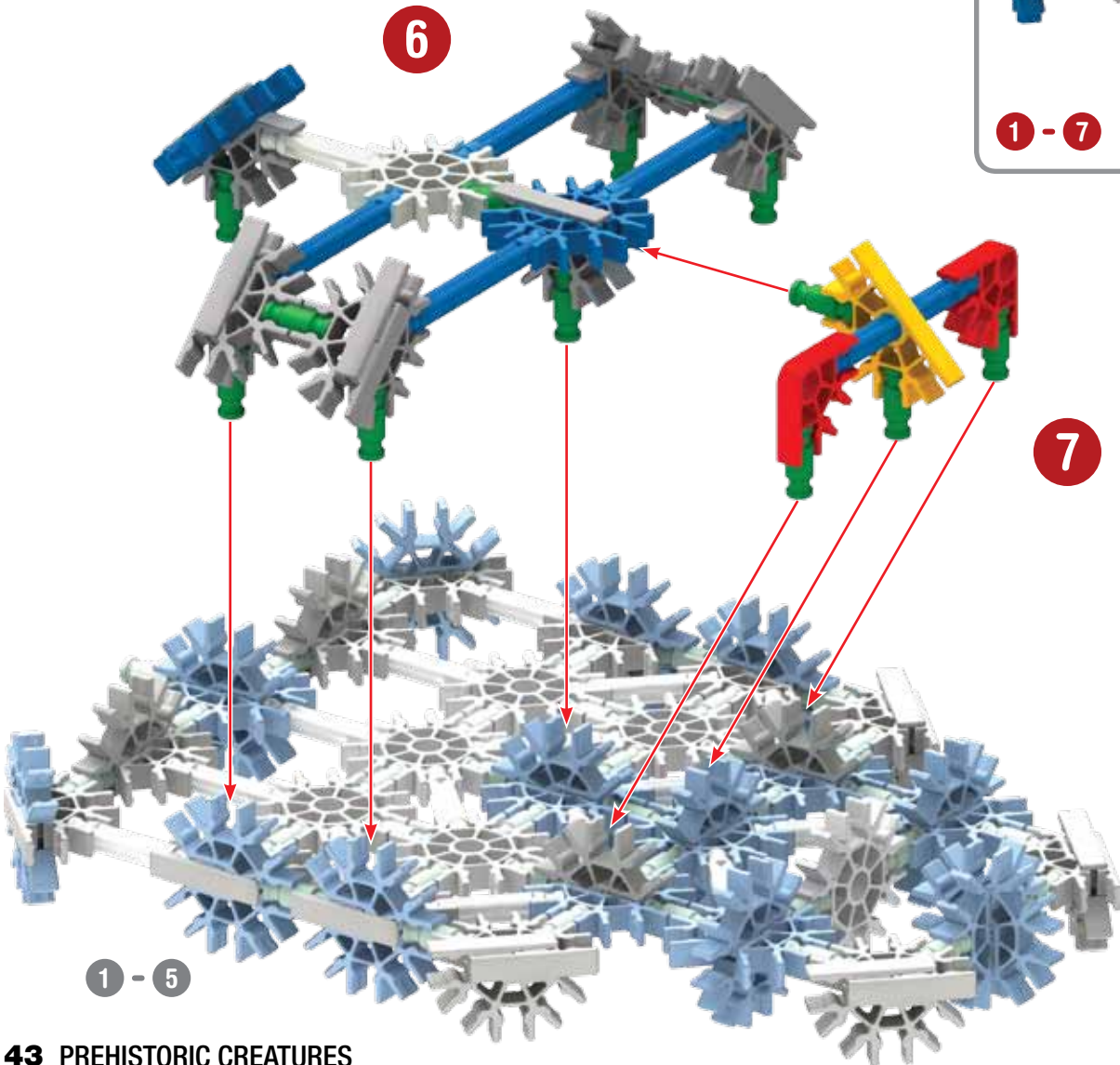

13		2		1	
1					
5					
10		2		1	

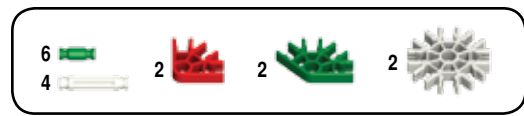
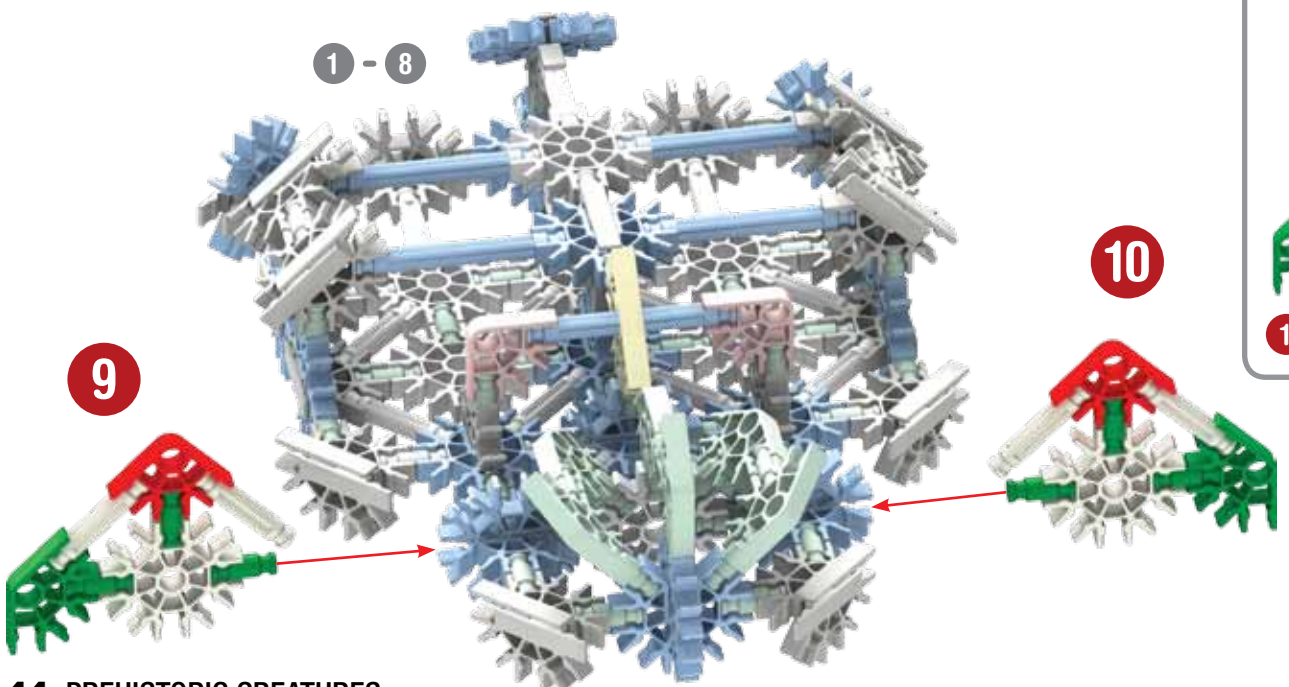
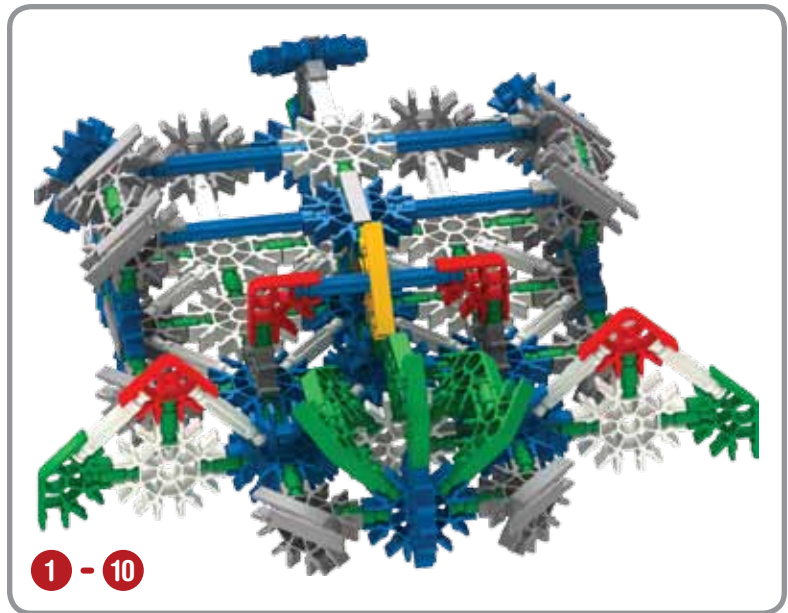
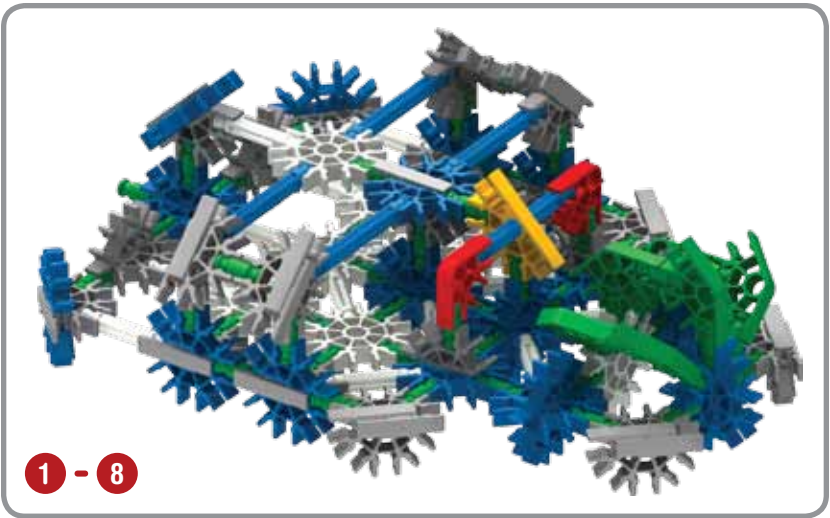
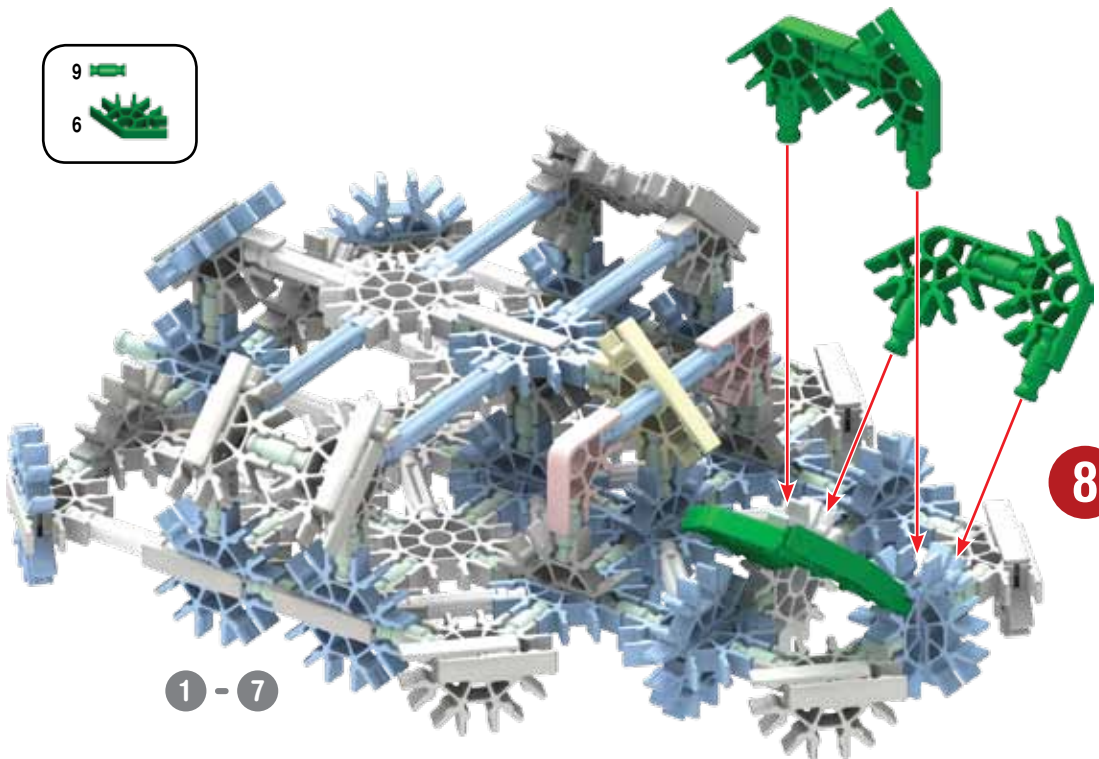
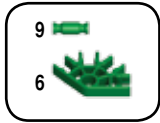

11

x2

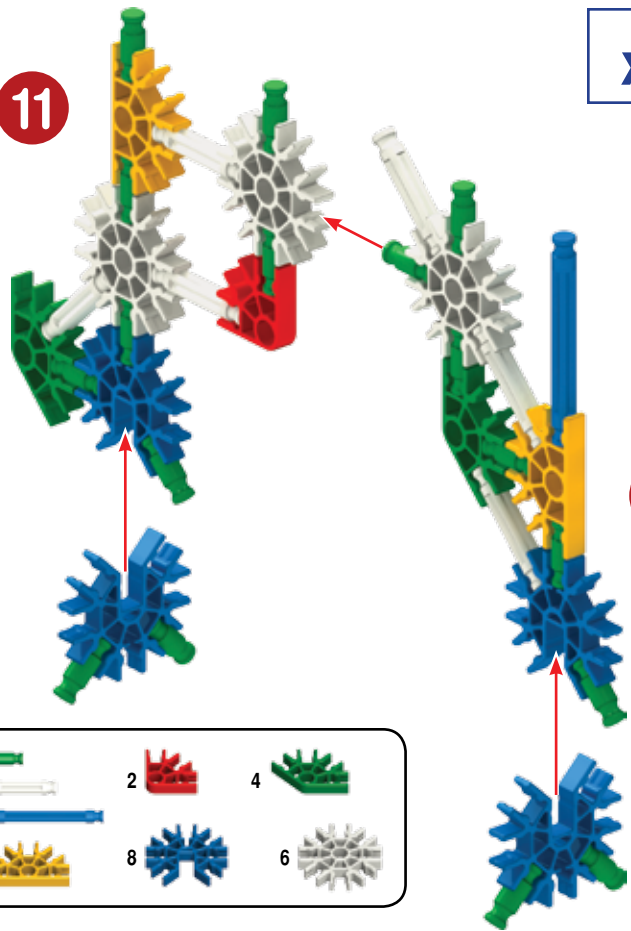

12

34		2		4	
12					
2					
4		8		6	

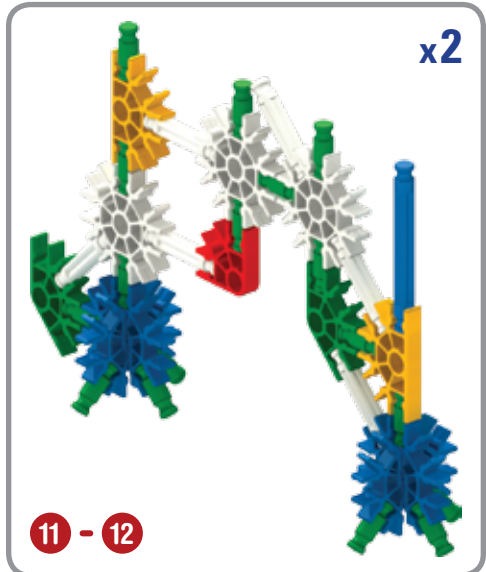

11 - 12

1 - 10

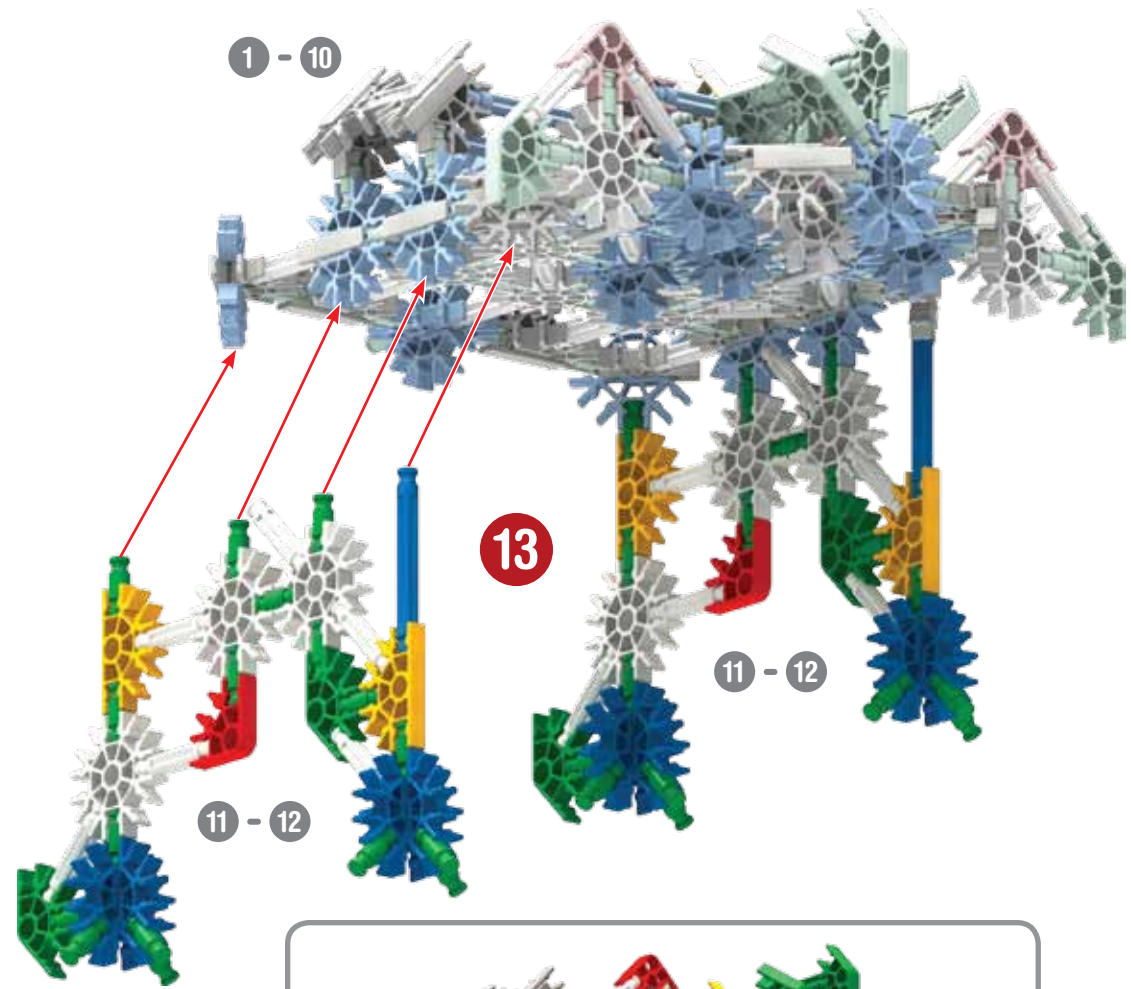

13

11 - 12

11 - 12

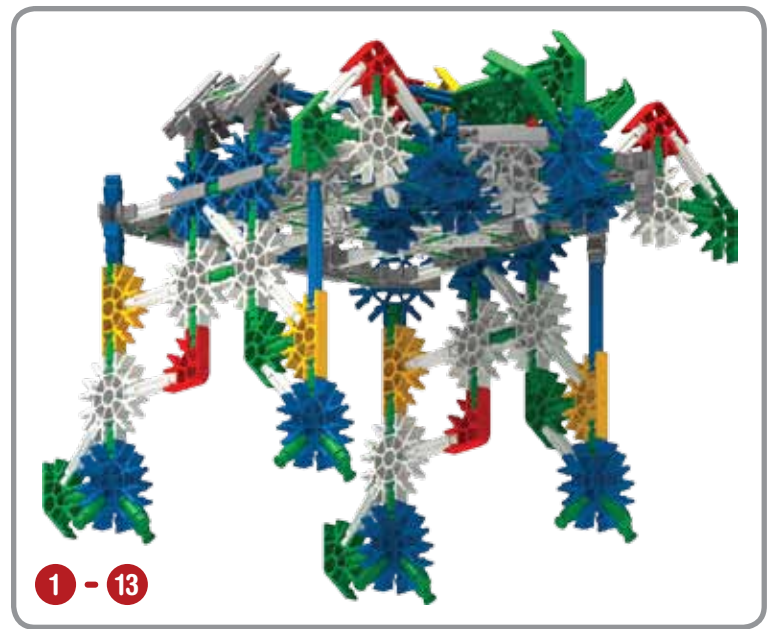

1 - 13

TIP: For this section of the model, it is easier to connect the rods to the connectors by pushing them from the side.

