

# K'NEX®

COOL MACHINES

12016

## FORMULA RACERS



**WARNING:**  
CHOKING HAZARD – Small Parts.  
Not for children under 3 years.

**AVERTISSEMENT:**  
DANGER D'ÉTOUFFEMENT – Pièces de petite taille.  
Ne pas donner aux enfants de moins de 3 ans.

**ATENCIÓN:**  
PELIGRO DE ASFIXIA – Por contener piezas pequeñas,  
no recomendable para niños menores de tres años.

**Piston  
Poppin'  
Action!**



COLOR CODED BUILDING SYSTEM

# Congratulations!

You have discovered K'NEX, the award winning construction system that lets you build and bring to life anything you can imagine.

Stretch your imagination. Make the most of your creativity. And have a ton of fun building, too.

Your set has everything you need to turn K'NEX parts into totally cool models. The instructions get you going, but the fun doesn't stop there. Design your own models! Make your own K'NEX world.

And check out the other great K'NEX Sets, with exciting themes and models for kids of all ages!

Visit the K'NEX website at [www.knex.com](http://www.knex.com). Questions? Call us at 1-800-KID-KNEX.

Félicitations ! Vous venez de découvrir K'NEX, un système de construction unique qui vous permettra de créer tout un monde imaginaire.

Laissez-vous guider par votre imagination, écoutez votre esprit créateur et amusez-vous à construire des modèles pendant des heures.

Vous trouverez dans cette boîte toutes les pièces et accessoires nécessaires pour créer de super modèles. Ces instructions ne sont qu'un exemple. Ne vous y limitez pas. Inventez d'autres modèles et bâtissez votre univers K'NEX !

N'oubliez pas non plus d'essayer les autres kits K'NEX qui vous proposeront encore plus de thèmes et de modèles pour enfants de tous les âges !

Visitez le site K'NEX au [www.knex.com](http://www.knex.com) ou appelez-nous au 1-800-KID-KNEX.

¡Enhorabuena! Has descubierto K'NEX, el sistema de construcción galardonado, que te permite construir y hacer que cobre vida todo aquello que puedas imaginarte.

¡Da rienda suelta a tu imaginación! ¡Sácale partido a tu creatividad! Y, de paso, ¡diviértete de lo lindo!

Este juego tiene todo lo que necesitas para crear, con las piezas K'NEX, los modelos más divertidos. Las instrucciones te muestran el camino, pero el juego no tiene límites. ¡Diseña tus propios modelos! ¡Crea tu propio mundo K'NEX!

Y no olvides que hay muchos otros sets K'NEX para niños de todas las edades, con temas y modelos que te encantarán.

Visita el sitio de K'NEX en la Web, [www.knex.com](http://www.knex.com), o llámanos al 1-800-KID-KNEX.

Each K'NEX piece has its own color and shape; match it to pieces in the picture instructions. Put pieces together exactly as pictures show. Be sure to put Rods in the correct slots of Connectors, so you have proper angles in your finished model.

Chaque pièce K'NEX a une couleur et une forme bien à elle. Faites correspondre et montez les pièces les unes sur les autres en suivant exactement les instructions illustrées. Assurez-vous de bien assembler les tiges dans les fentes des connecteurs afin d'obtenir des angles corrects une fois le modèle fini.

Assurez-vous de bien assembler les tiges dans les fentes des connecteurs afin d'obtenir des angles corrects une fois le modèle fini. Asegurarse de colocar las varillas en las ranuras correctas de los conectores, de modo que al terminar el modelo, los ángulos sean los adecuados.

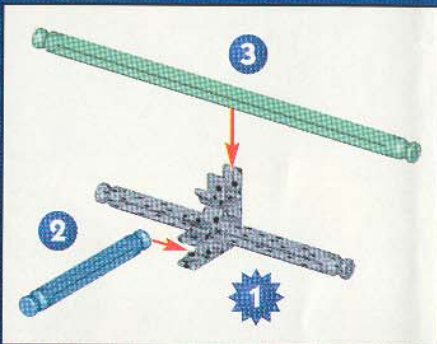

Pay close attention to the number of blue and silver Spacers needed.

Comptez bien le nombre de rondelles bleues et argentées nécessaires.

Prestar atención al número de espaciadores azules y plata que se necesitan.

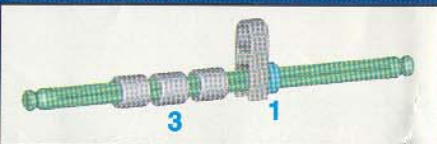

Faded colors indicate sections previously built; connecting points will be in full color.

Les couleurs plus claires indiquent les sections déjà construites. Les points de jonction sont indiqués en couleurs vives.

Los colores apagados indican secciones que ya han sido montadas anteriormente. Los puntos de conexión se indican con colores vivos.

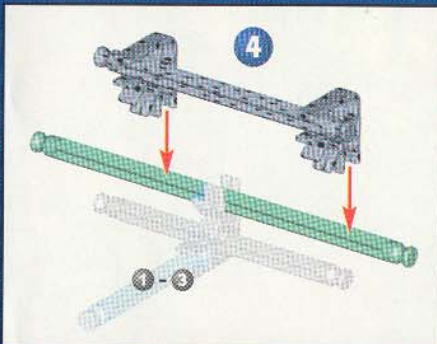

Bend Flexi-Rods before attaching to model.

Pliez les Flexi-Rods avant leur fixation au modèle.

Dobla las Flexi-Rods antes de conectarlas al modelo.



It's very important to position blue and purple Connectors in a specific direction. Pay close attention to the instructions, and position these Connectors horizontally or vertically exactly as they are shown. Push together tightly until you hear a "click".

Il est important de bien placer les connecteurs bleus et violets dans le bon sens. Lisez attentivement les instructions et placez ces connecteurs horizontalement ou verticalement selon l'indication. Appuyez dessus en forçant légèrement jusqu'à ce que vous entendiez un dé clic.

Es muy importante colocar los conectores de color azul y morado en una dirección específica. Prestar mucha atención a las instrucciones y colocar estos conectores según se indica, ya sea horizontal o verticalmente. Para conectarlos, presionar hasta oír un "clic".

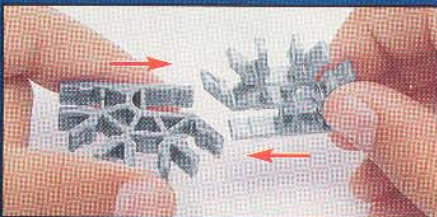
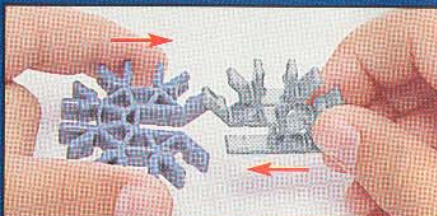

# K'NEX®

# Formula Racer

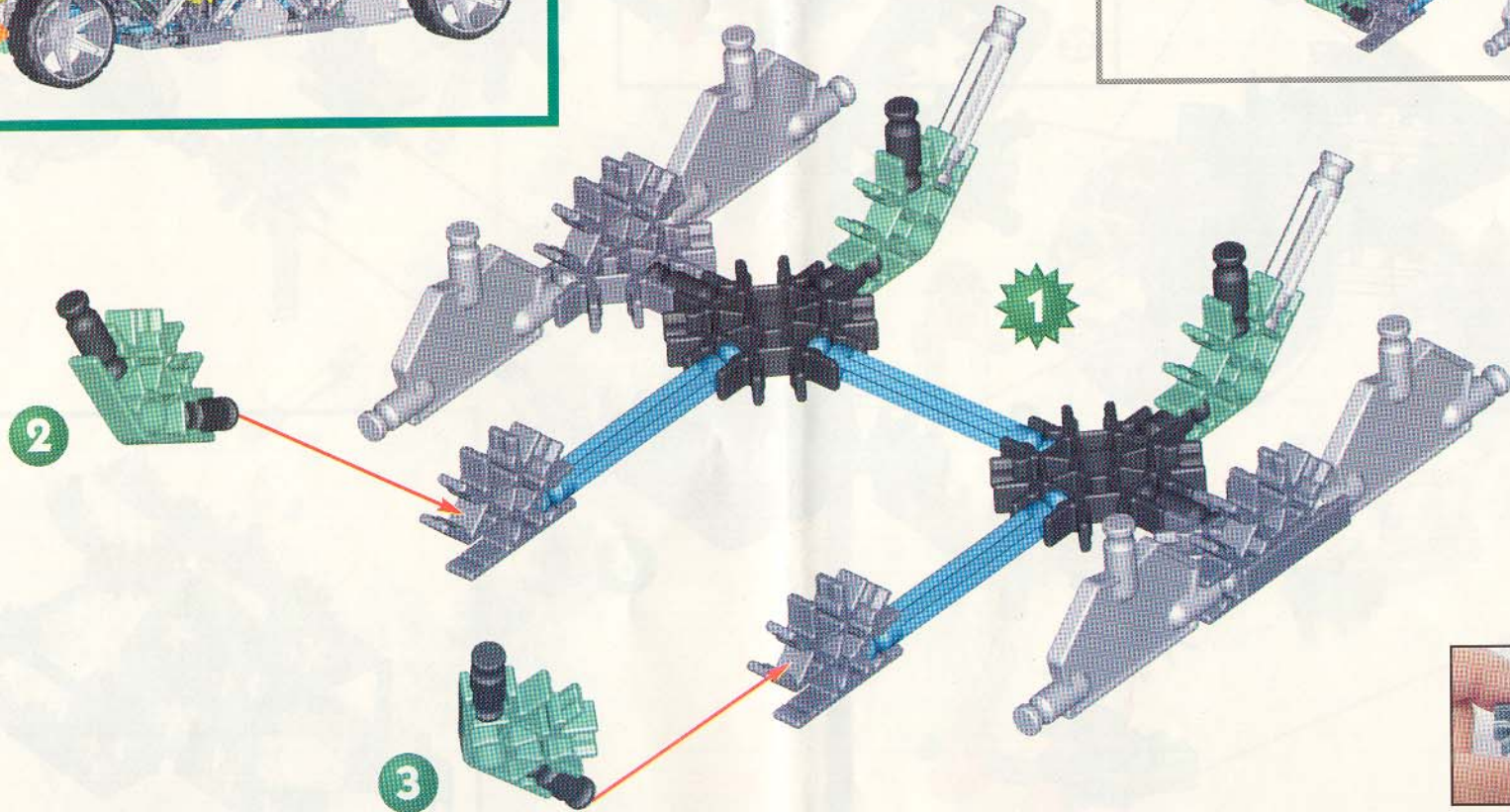
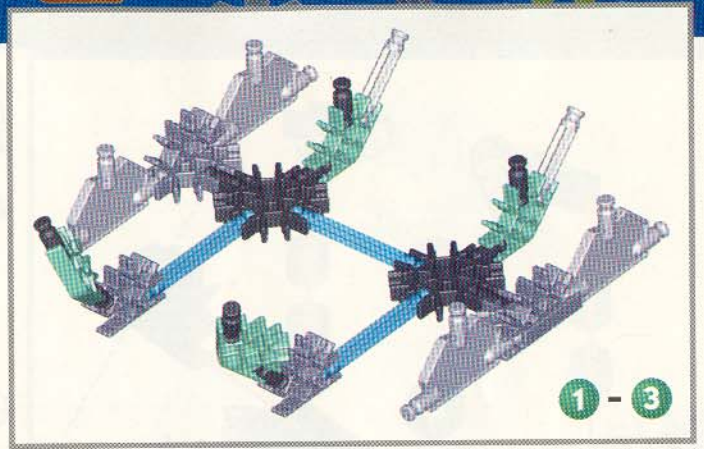
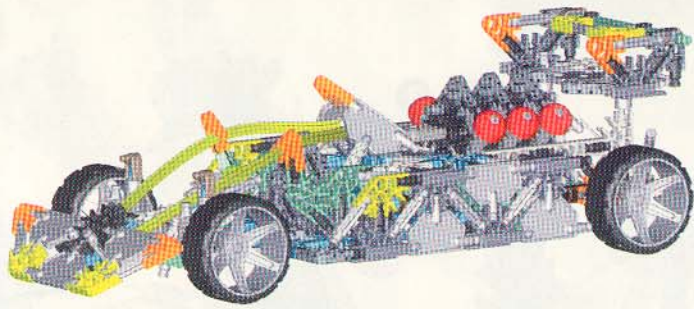

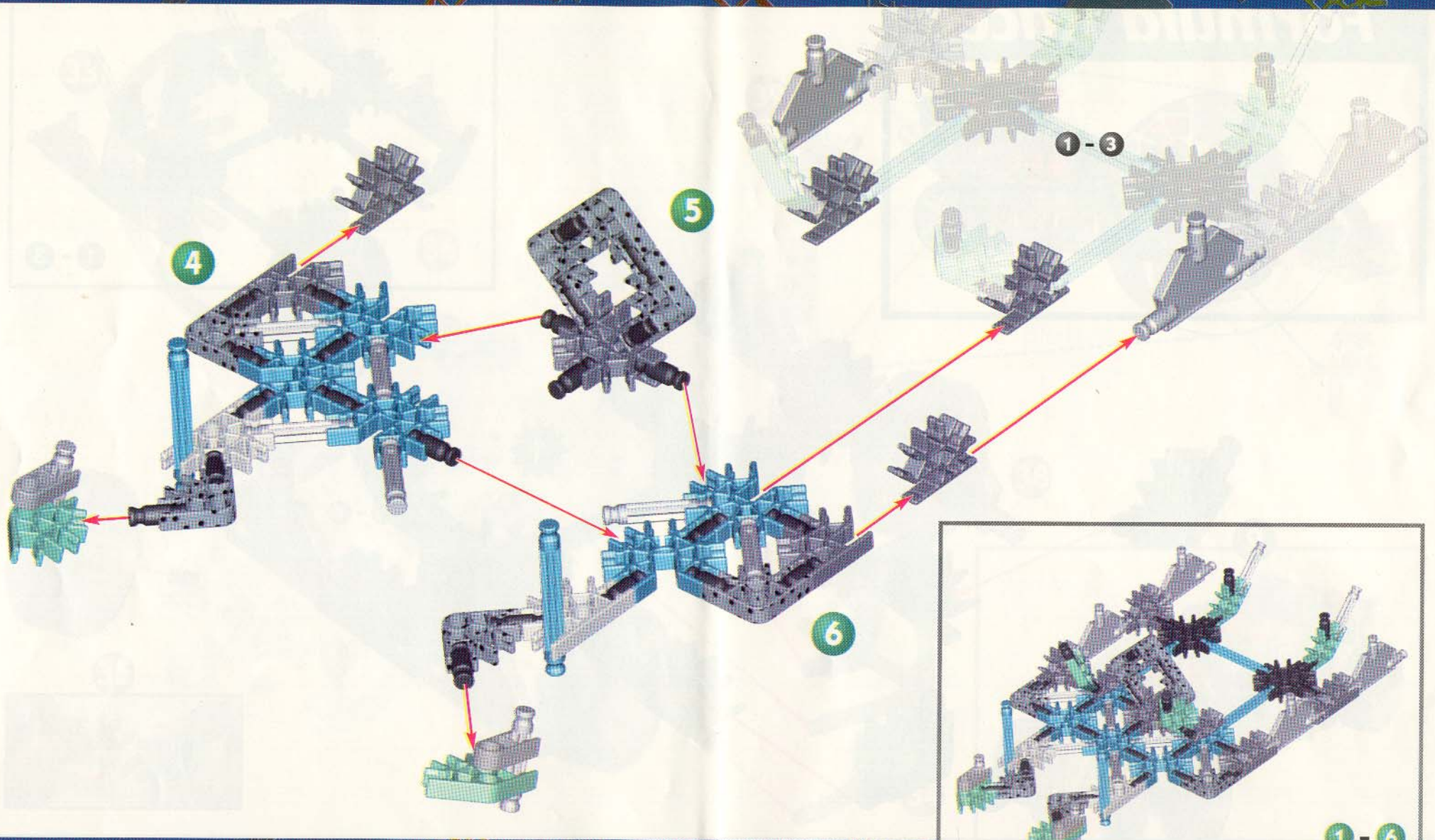

x6

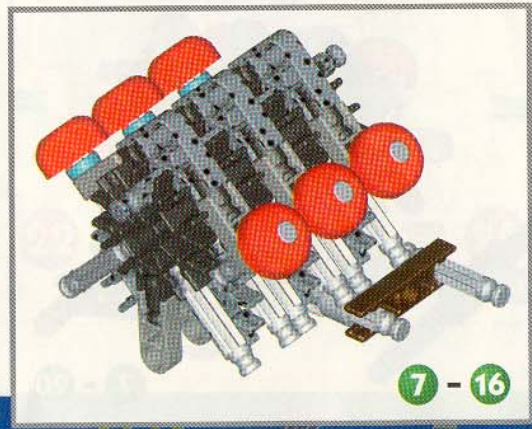
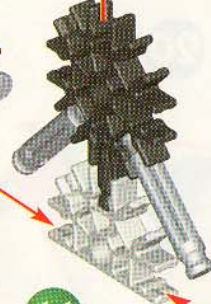
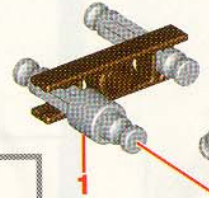
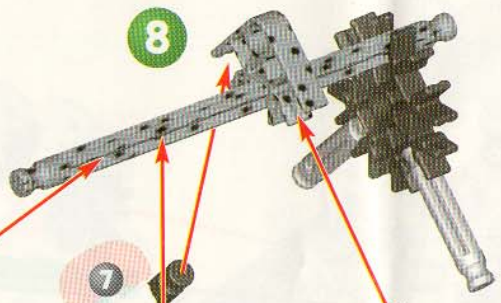

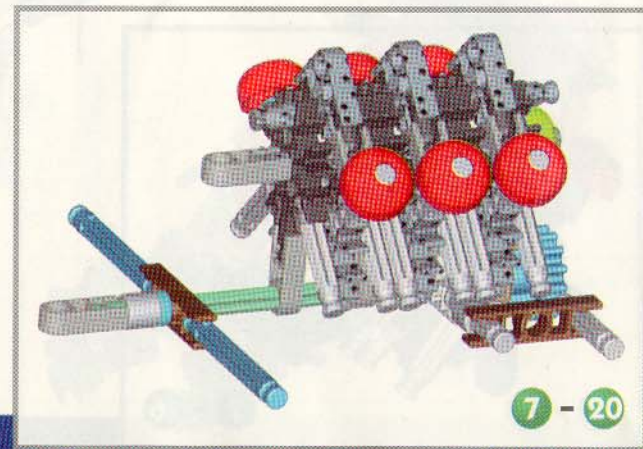
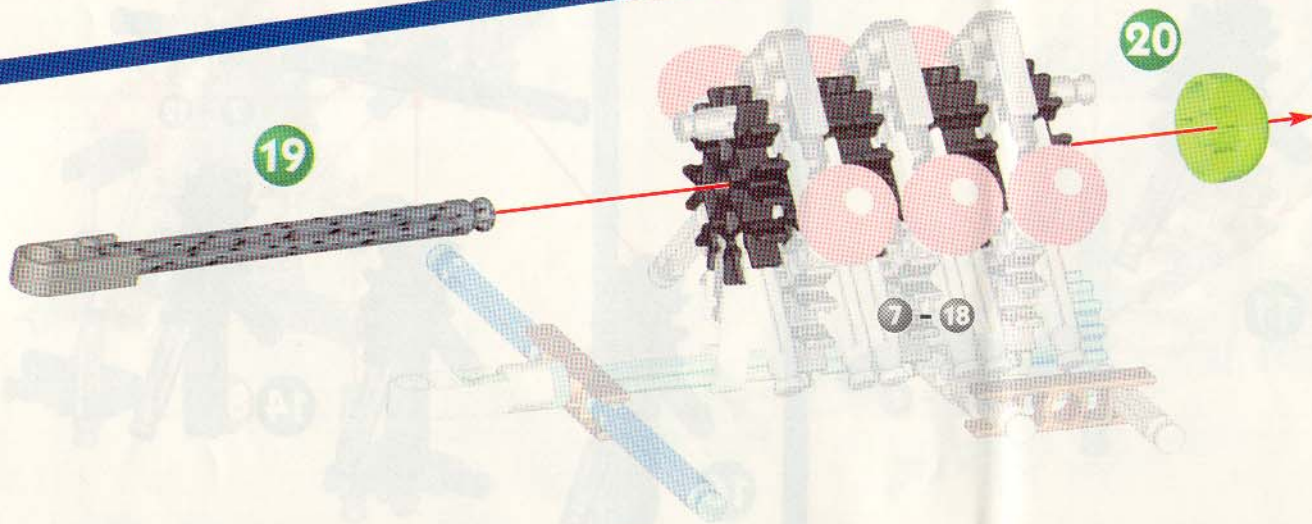
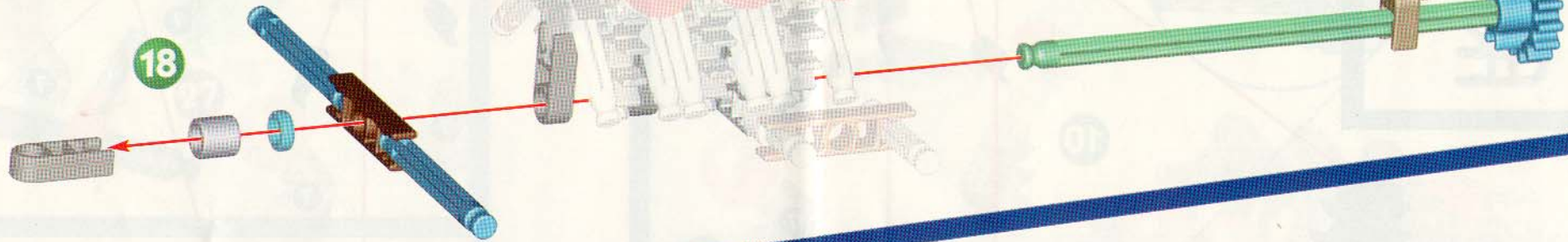

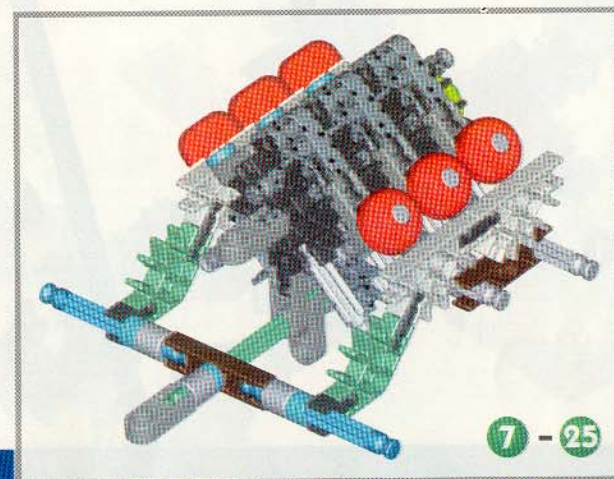
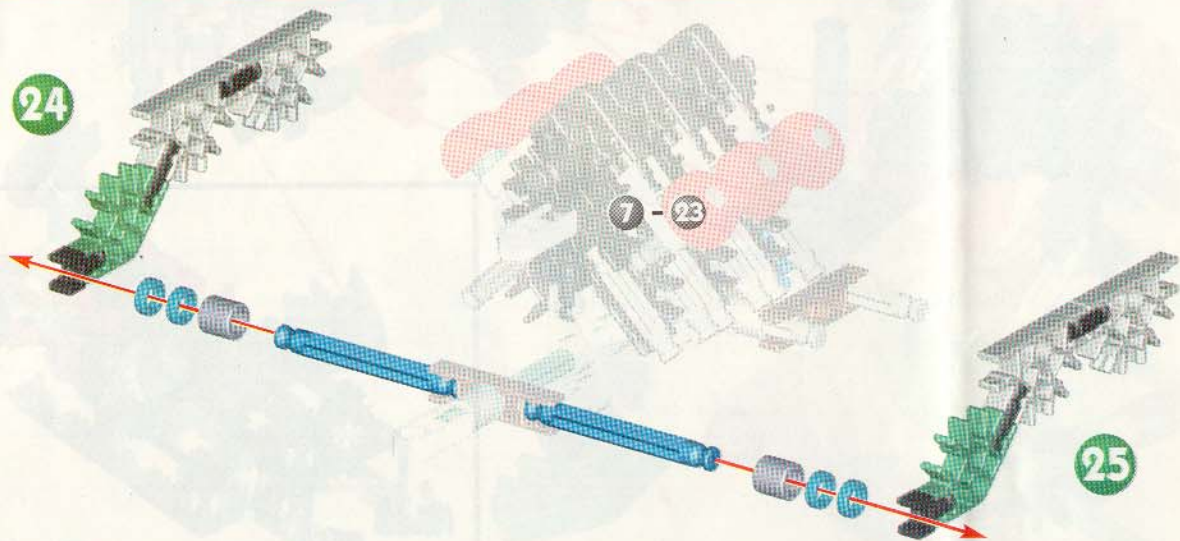
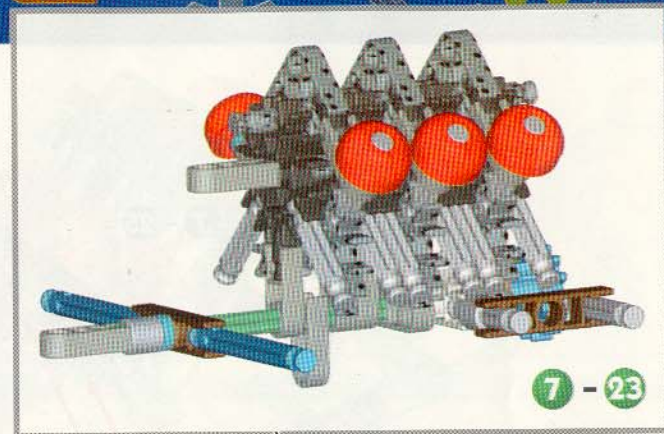
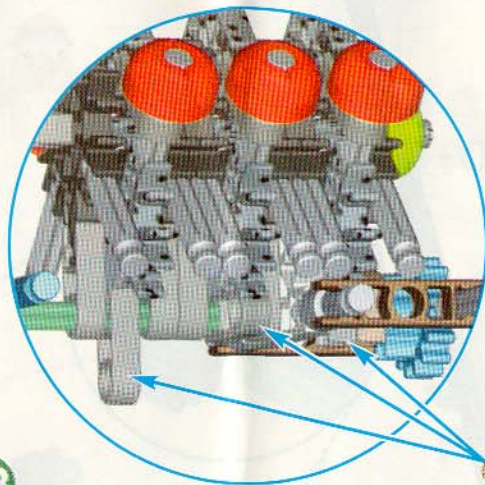
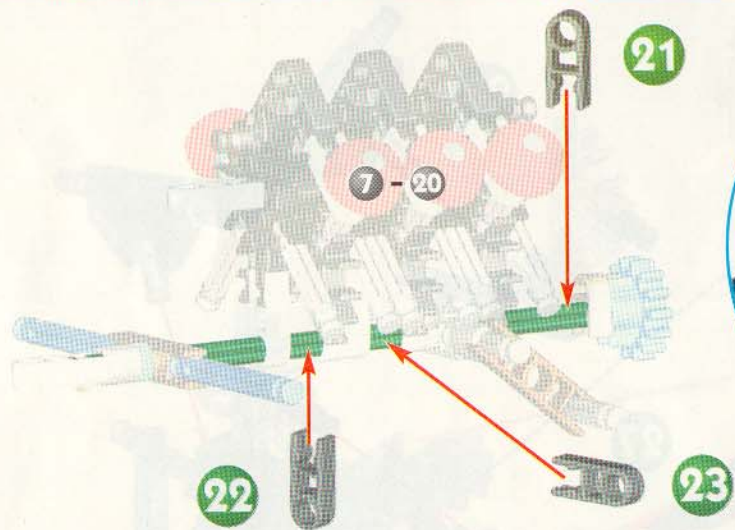

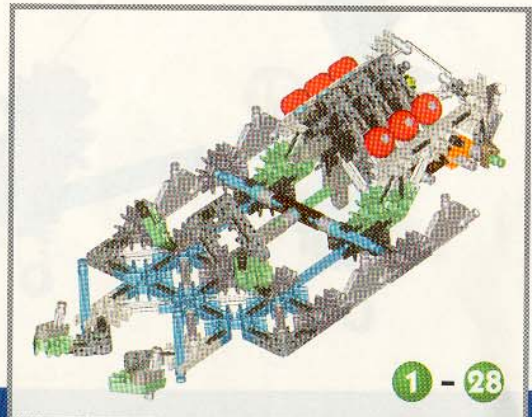
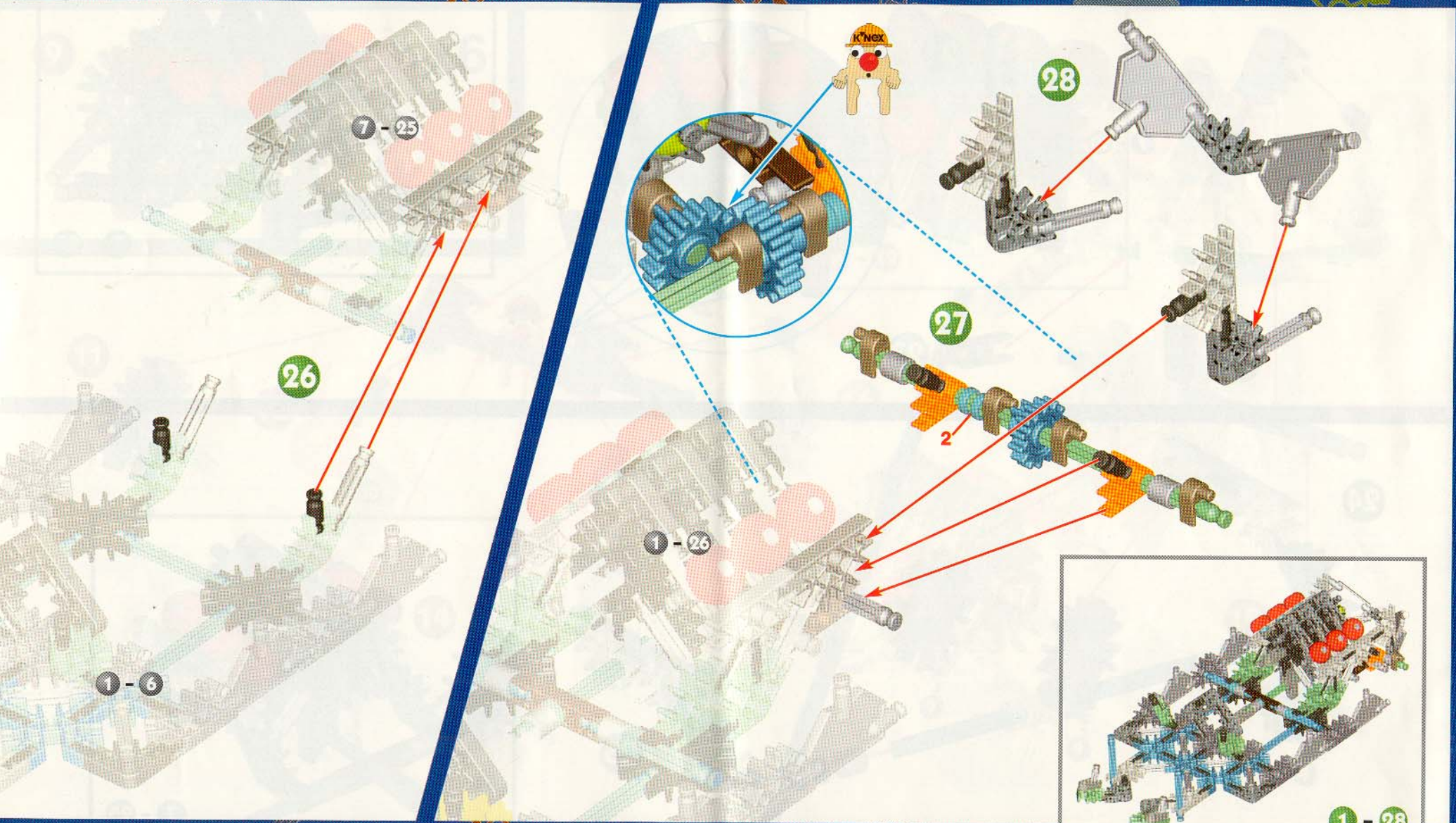

26

7 - 25

1 - 6

1 - 26

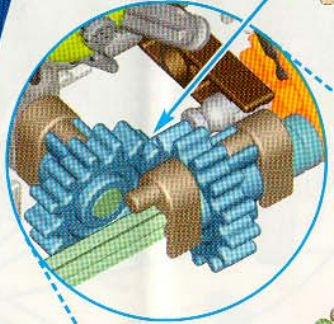

28

27

2

1 - 28



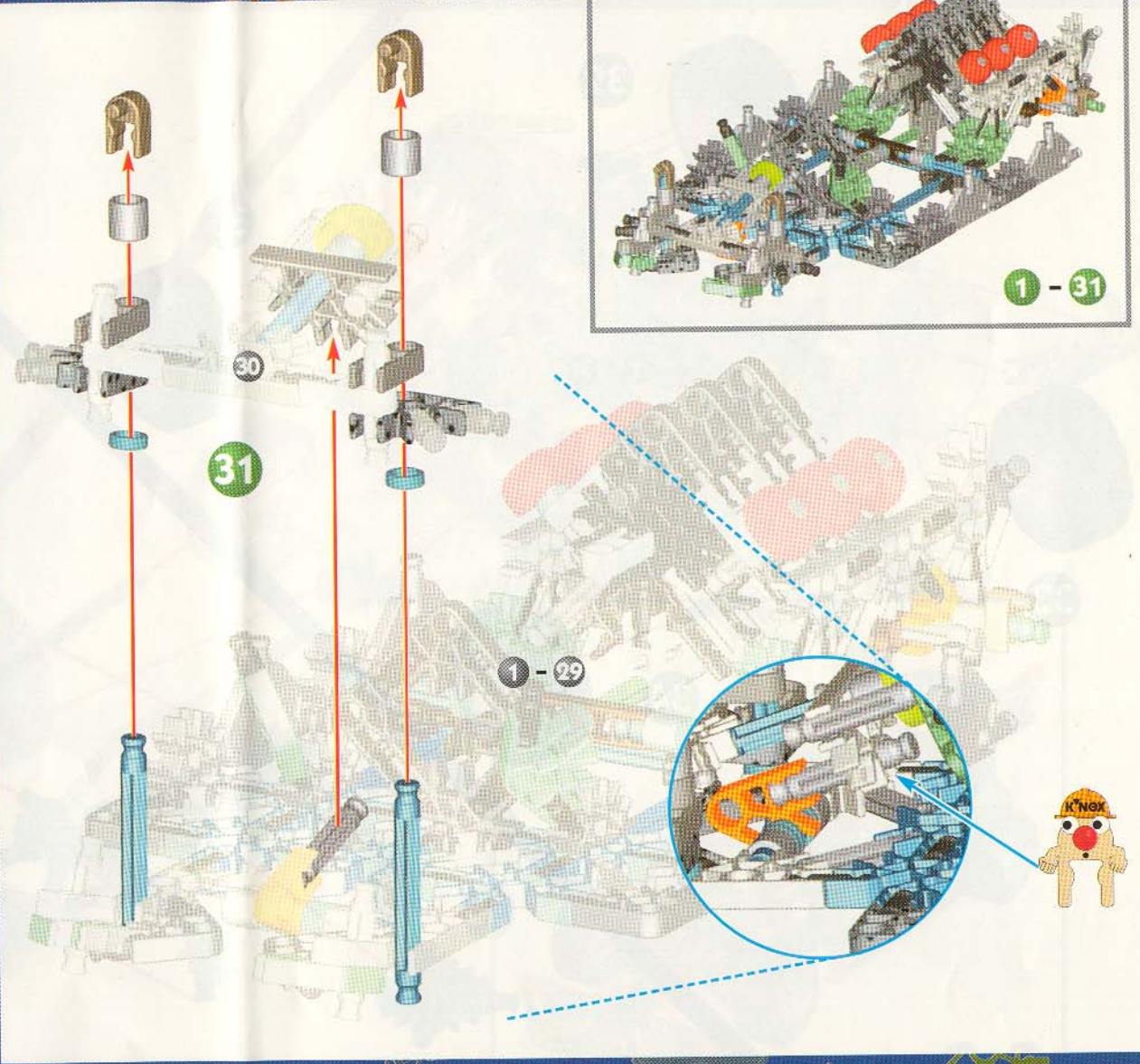
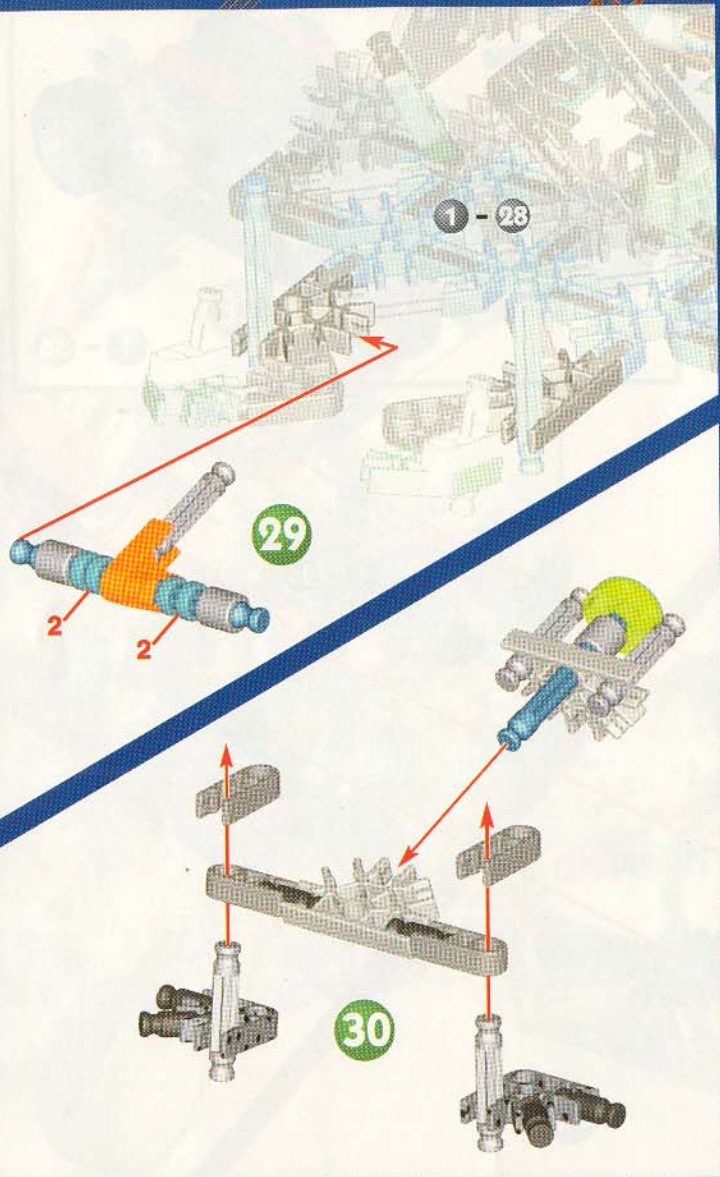

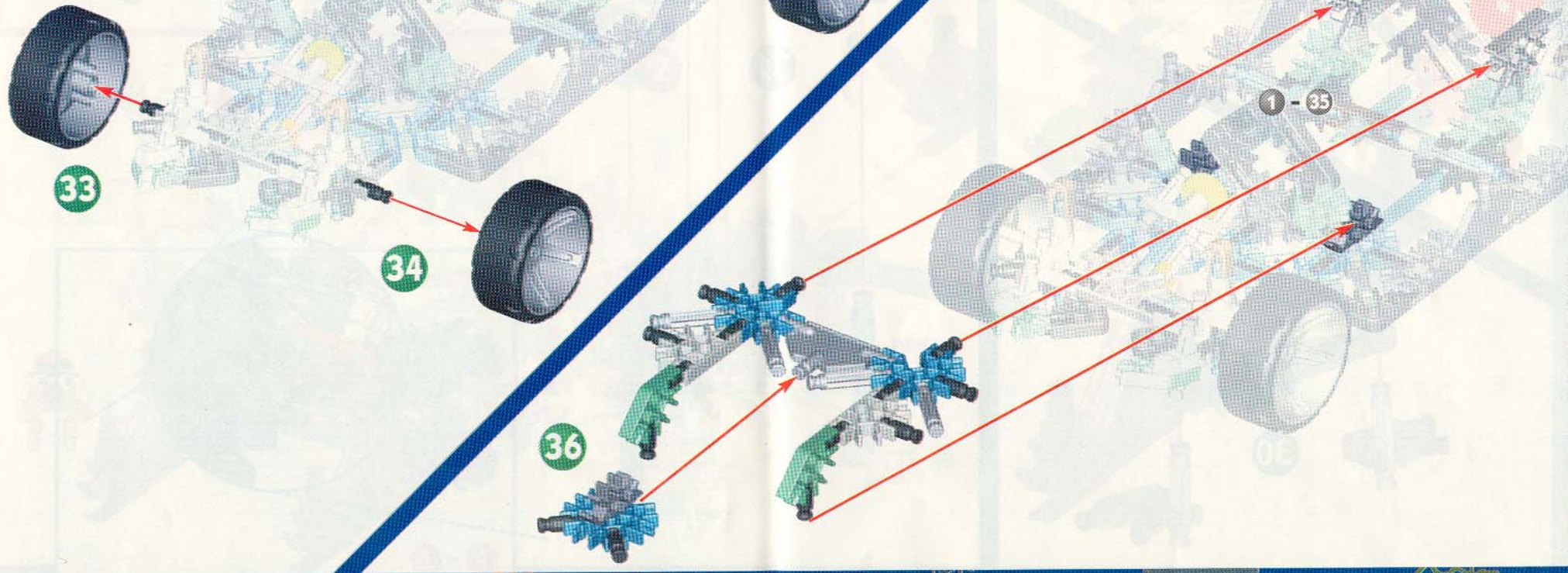
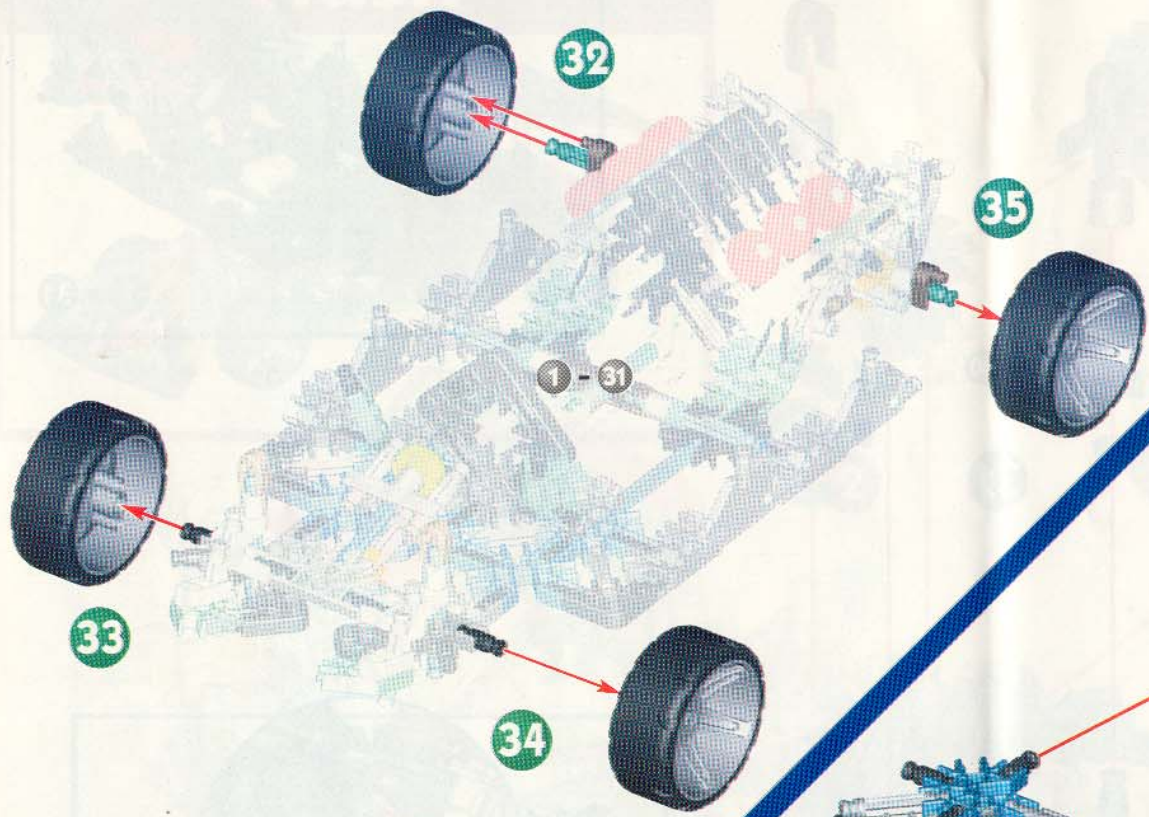

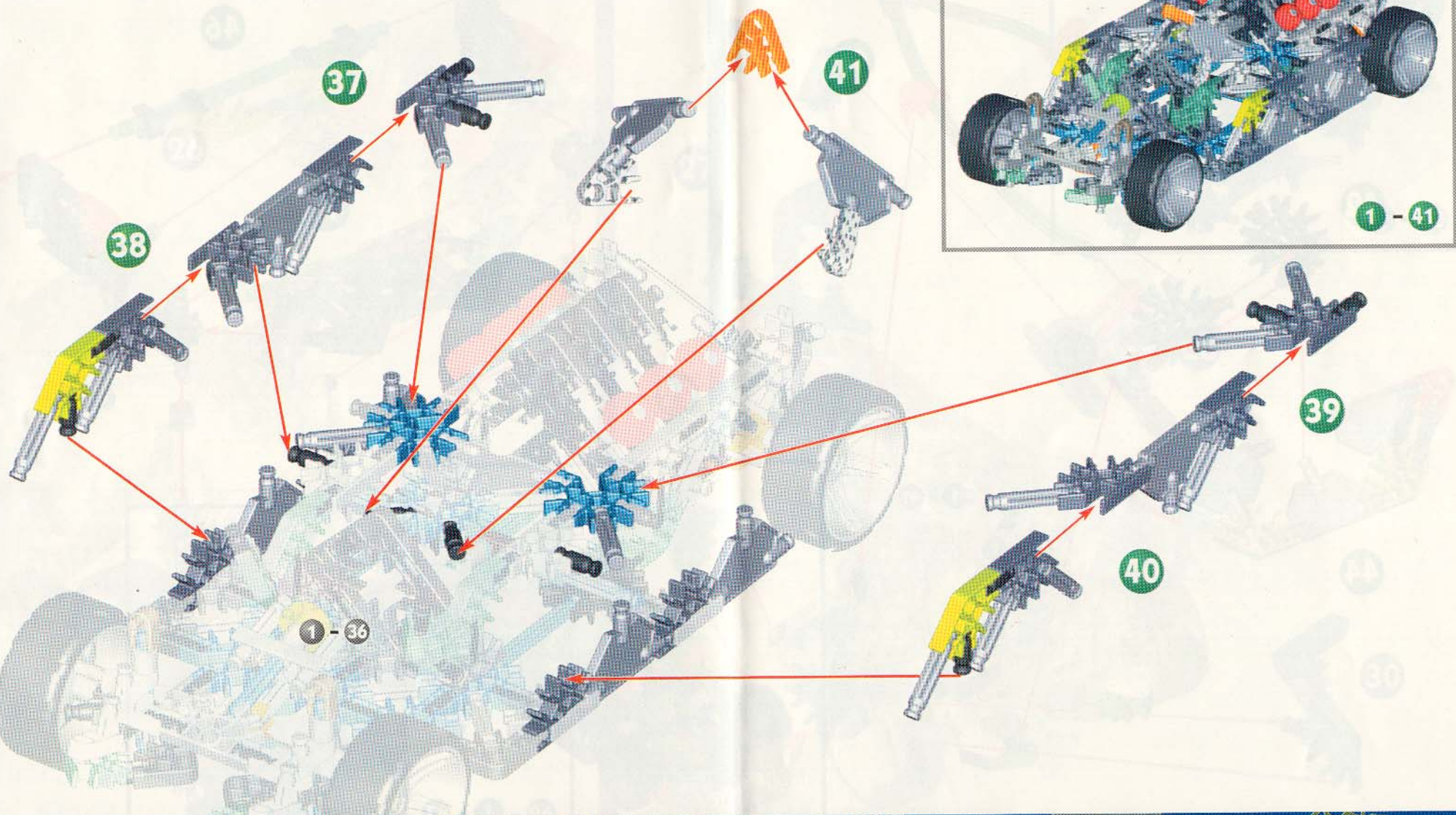

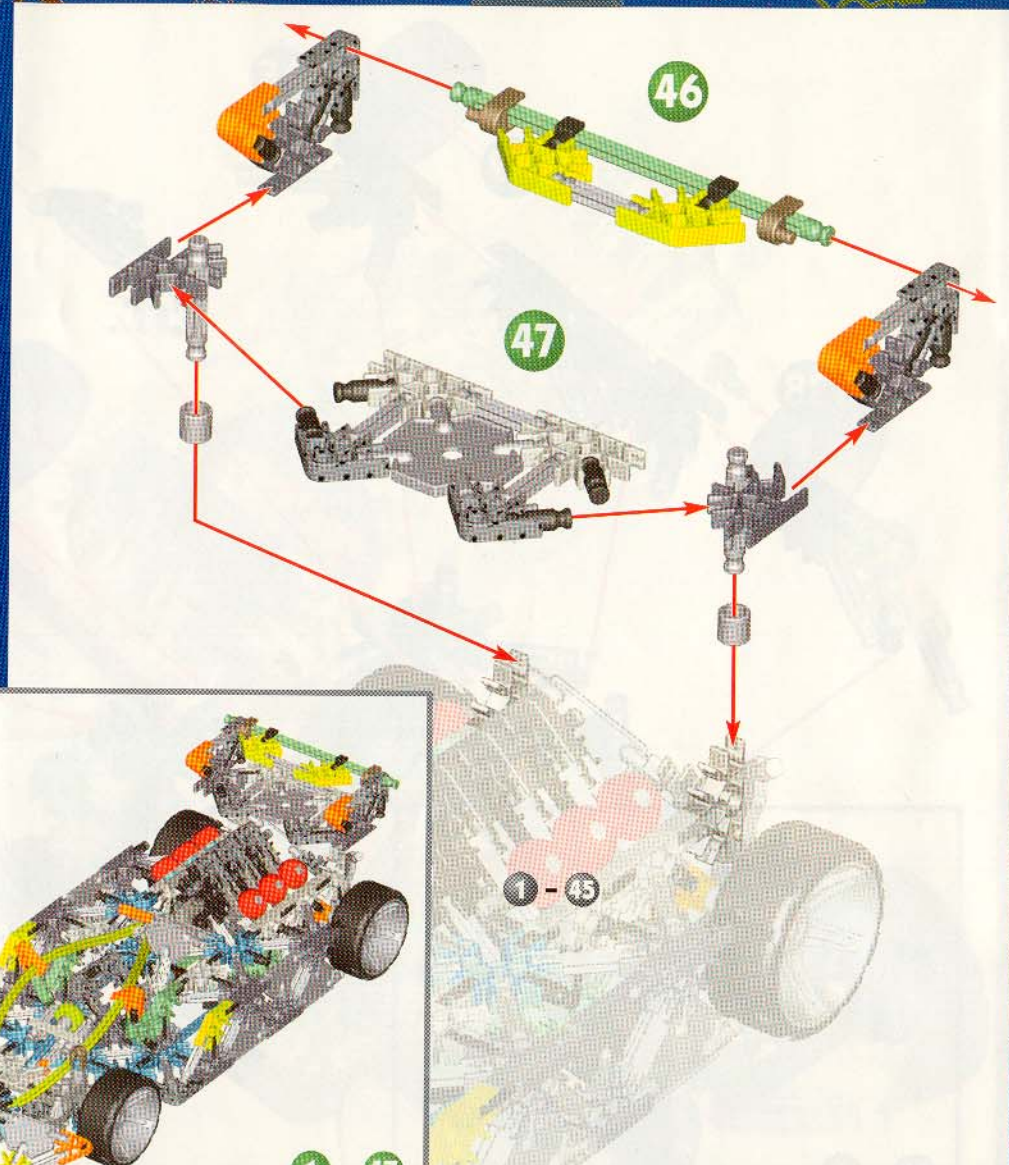
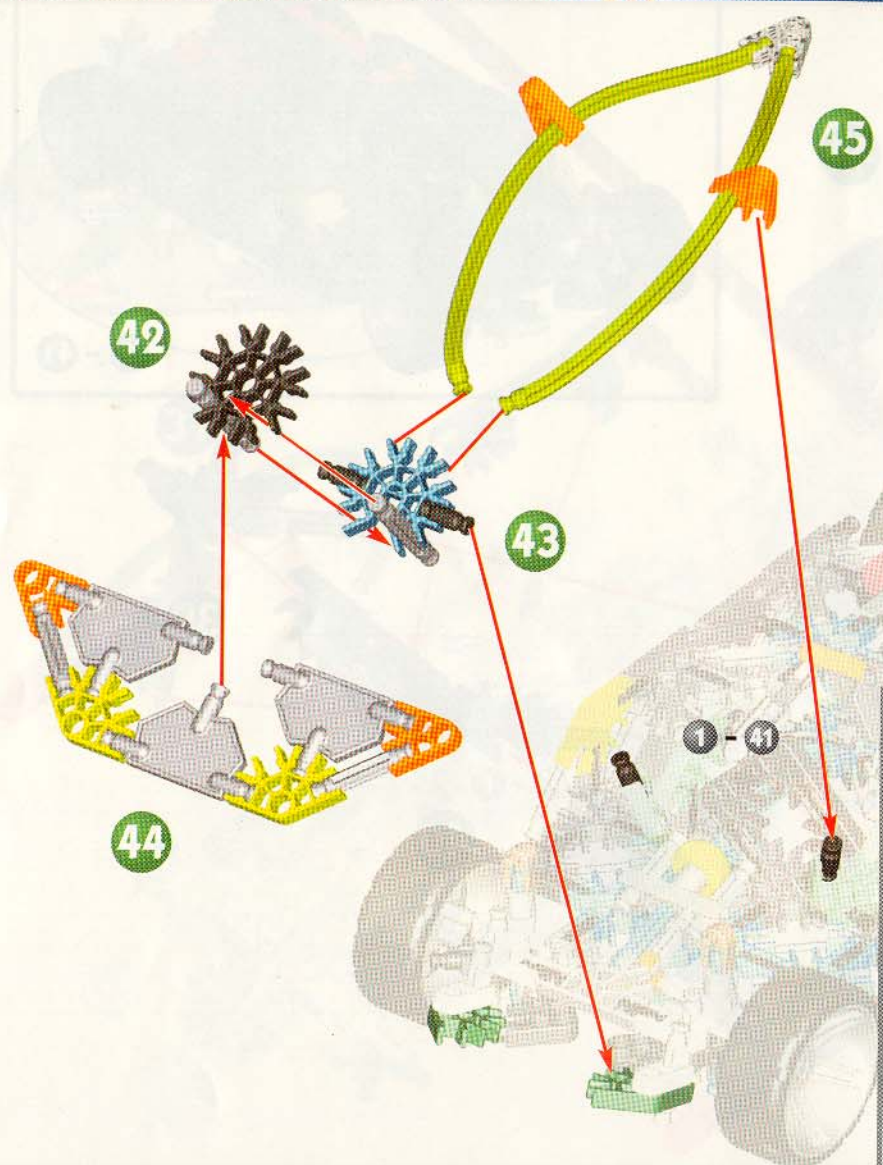

1 - 47

# Turbo

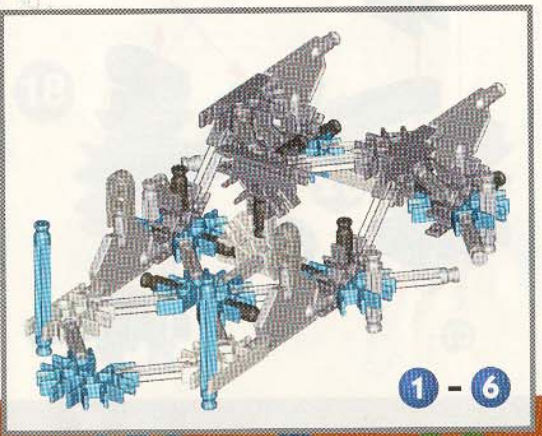
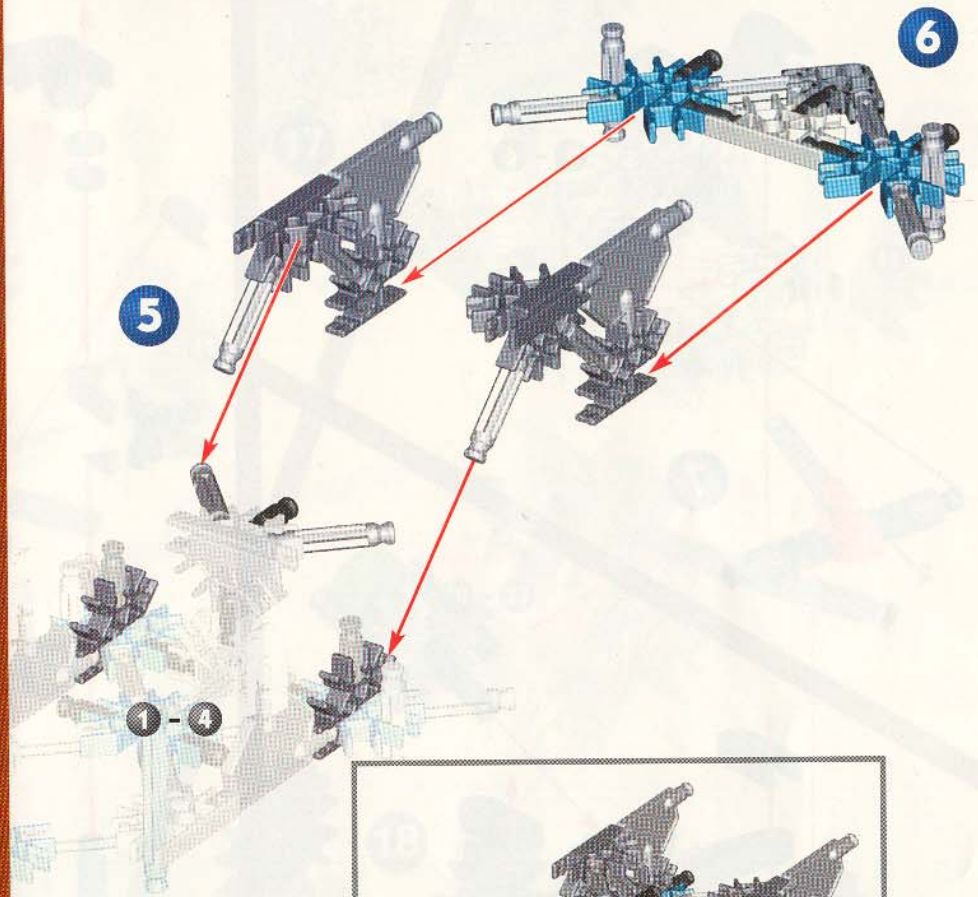
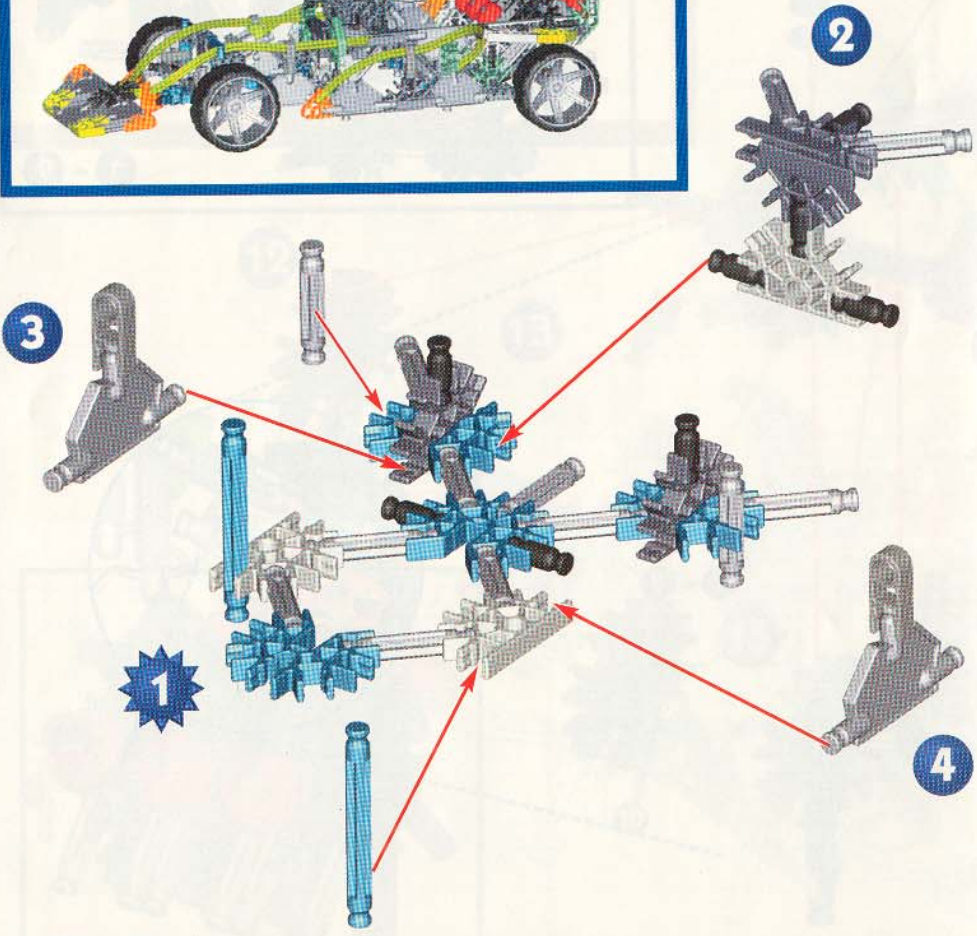
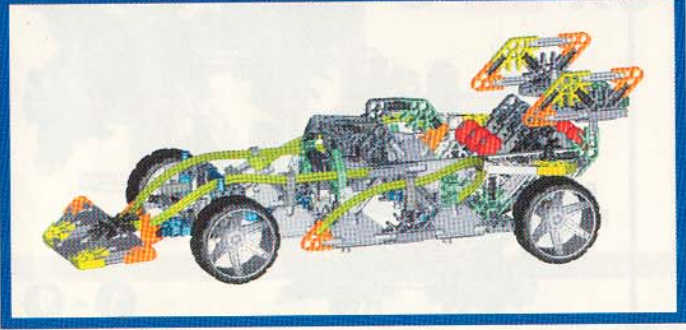

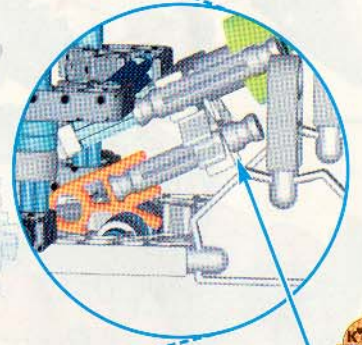
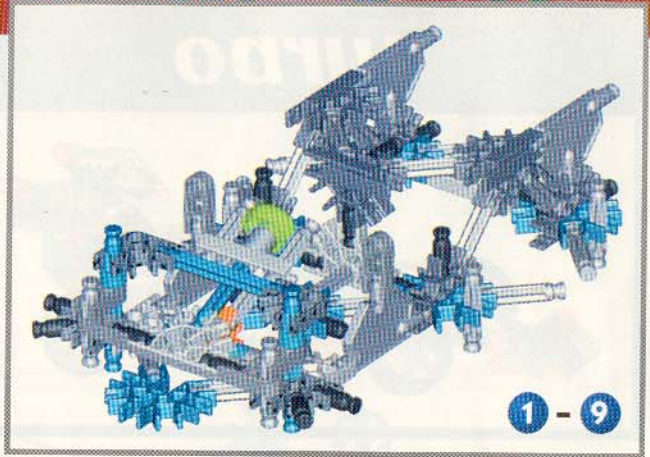
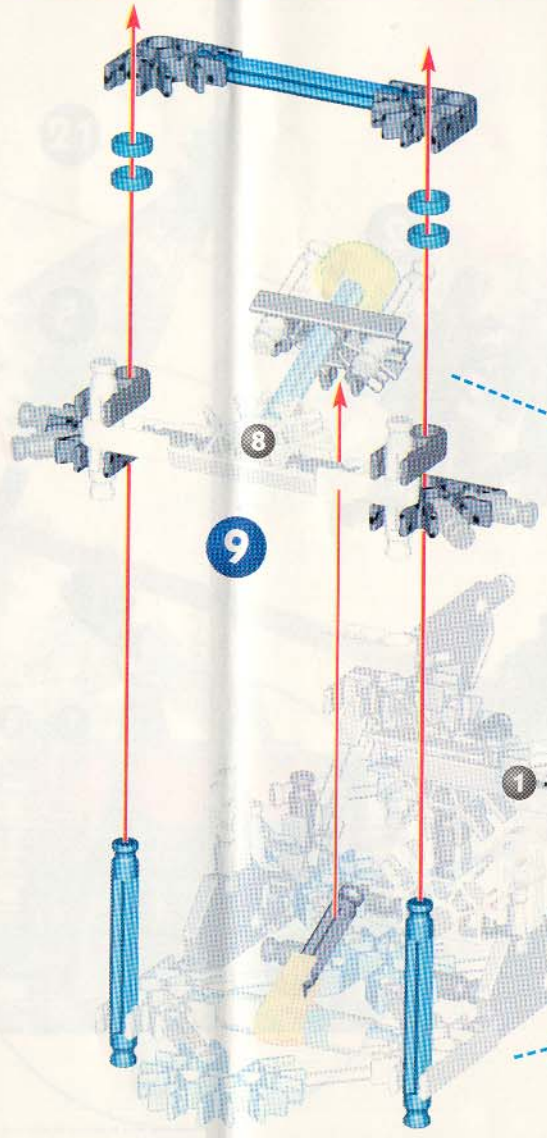
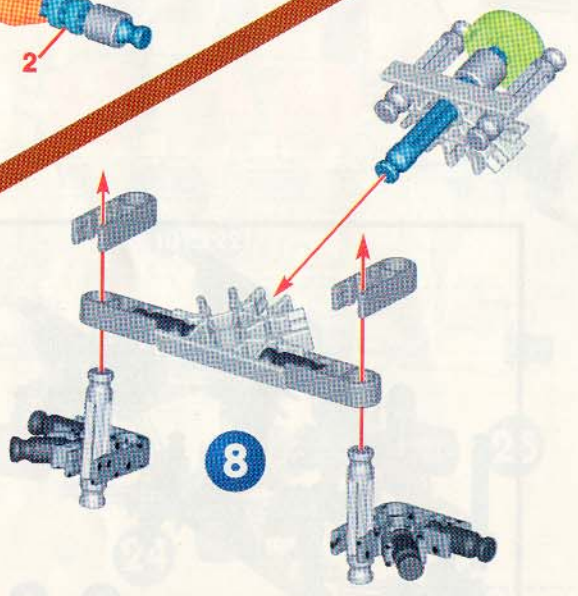
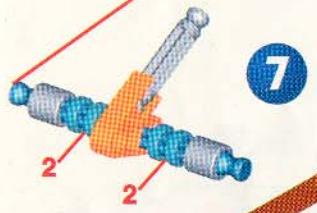
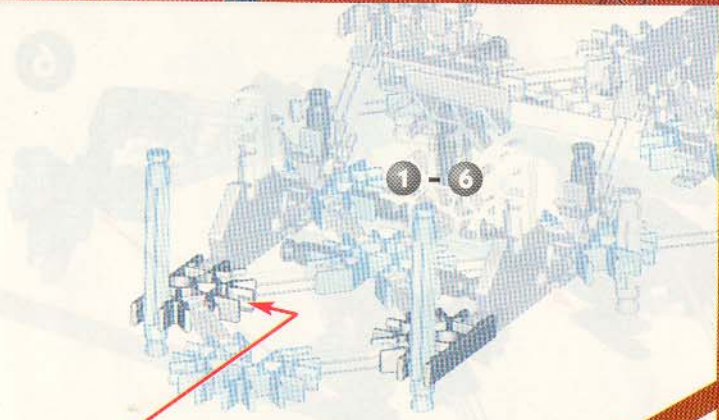

10 x6



11 x6

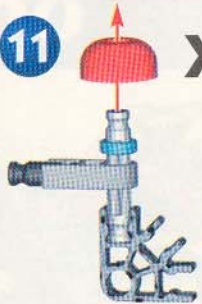

12



13



14



17



16



15

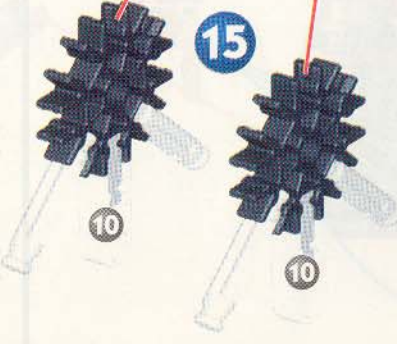

18



20



19

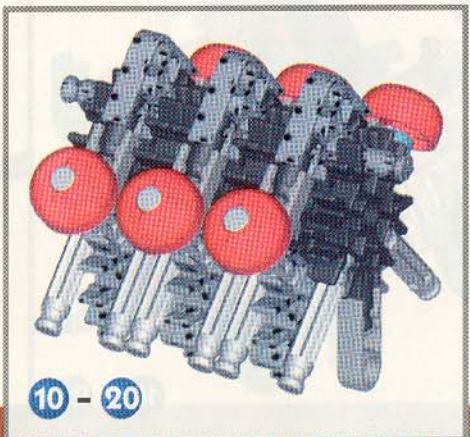
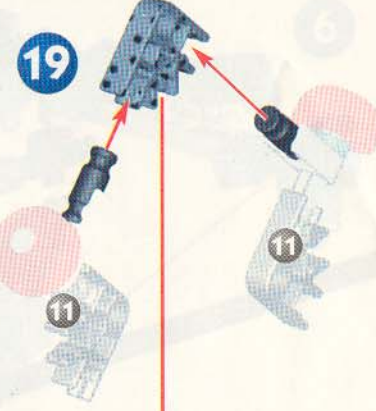

10 - 20

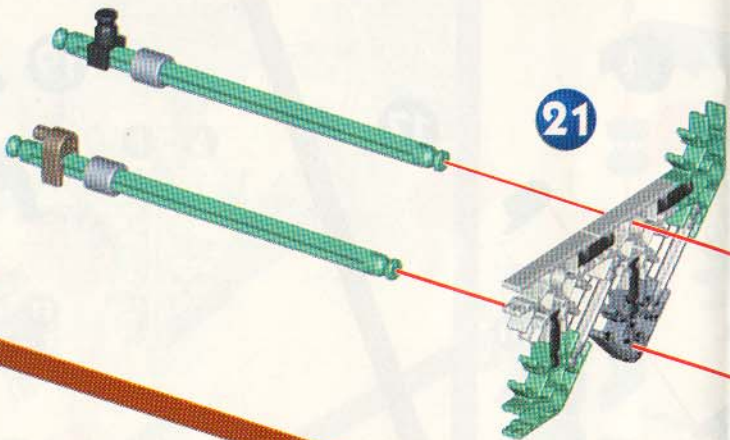

21

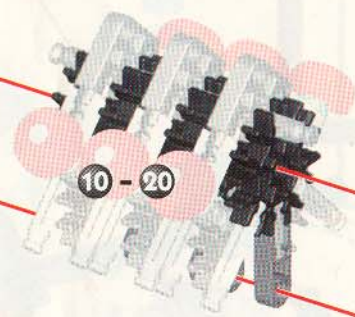

10 - 20

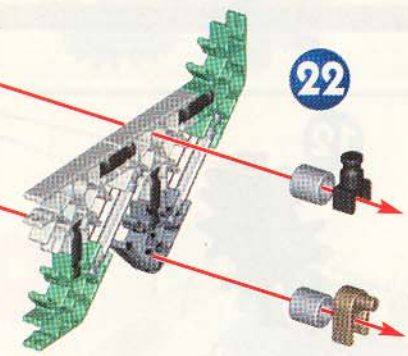

22

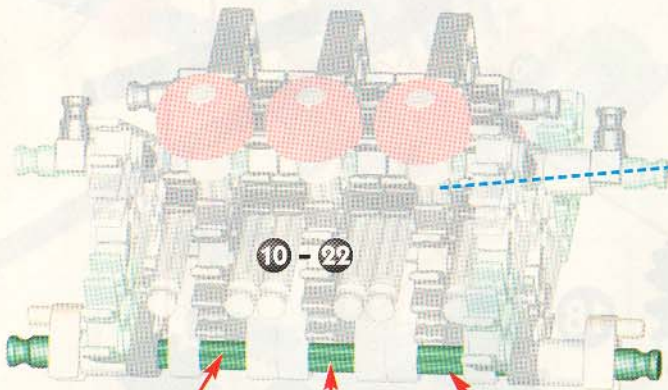

10 - 22

23

24

25

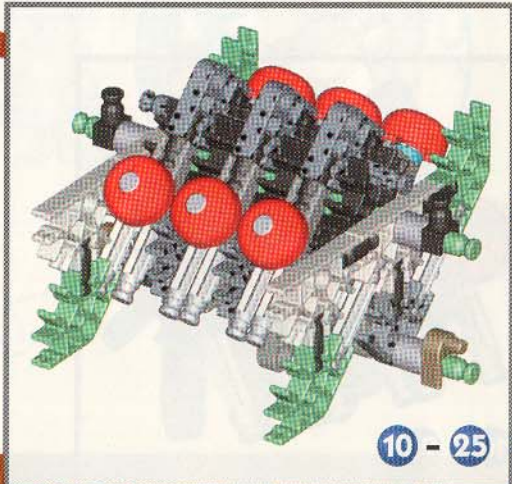
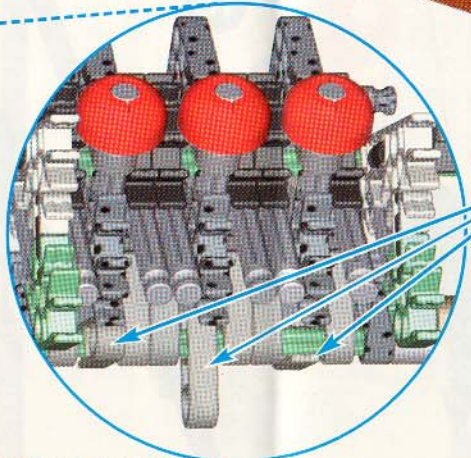

10 - 25



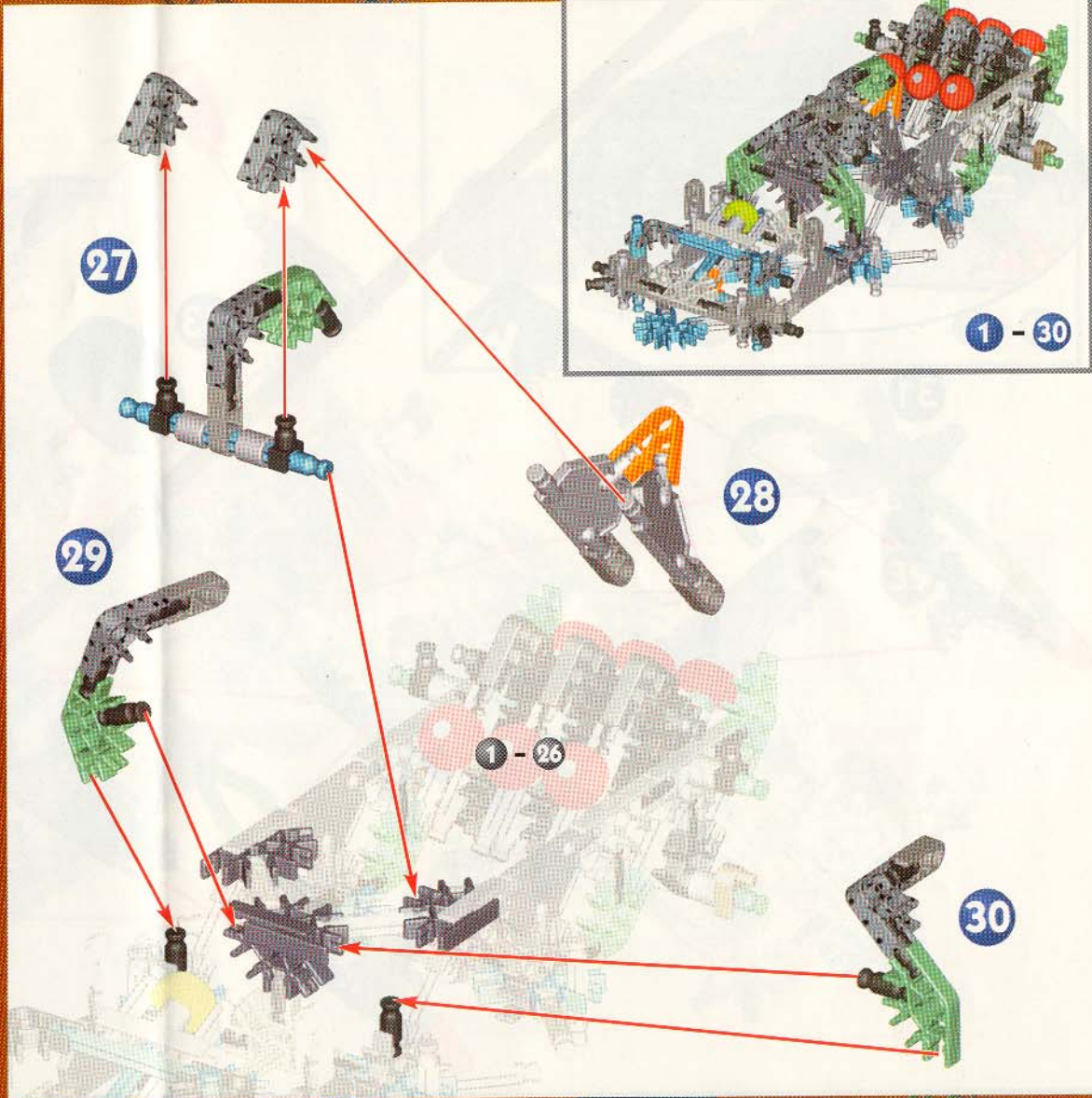
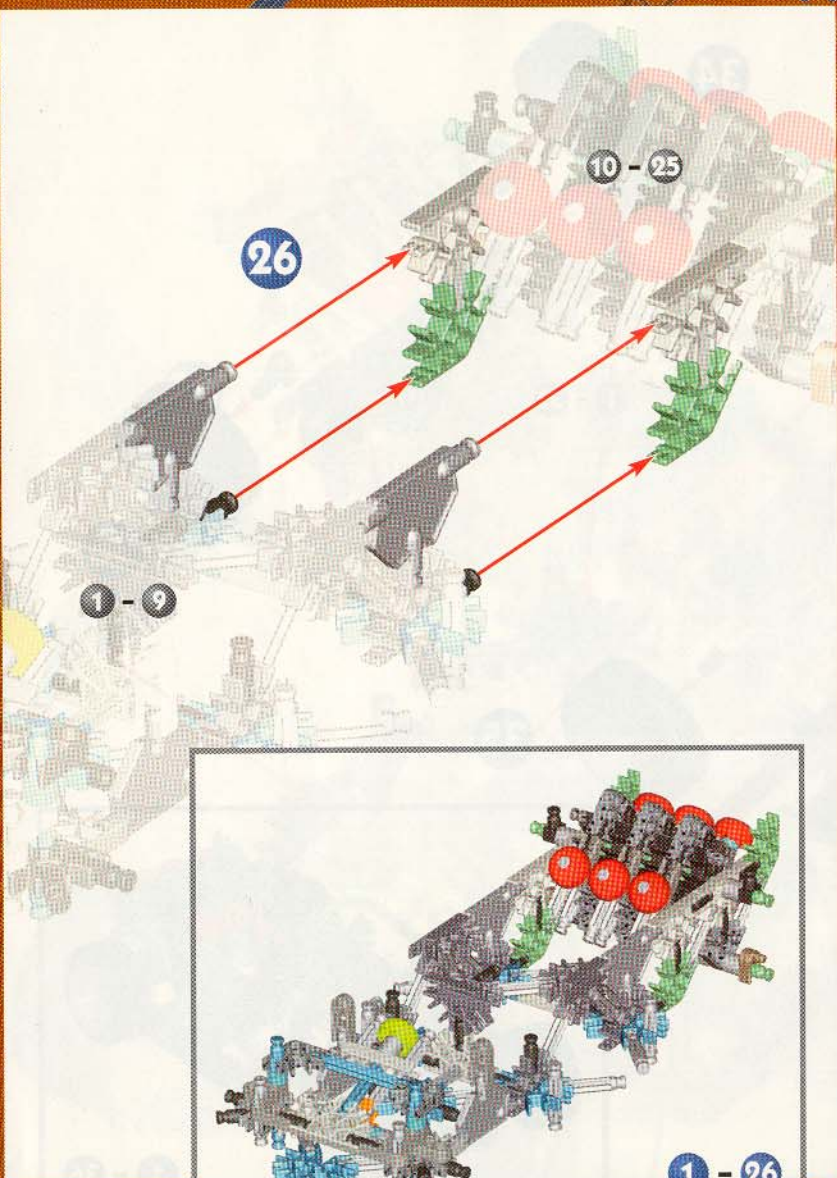

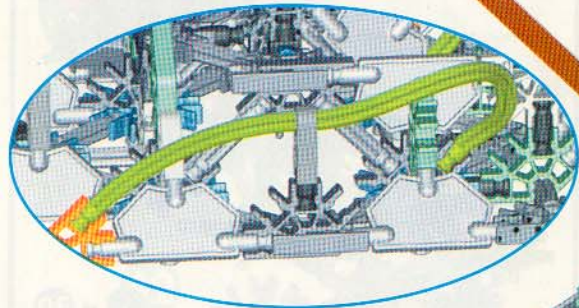

31

33

34

36

35

32

1 - 30

1 - 32

1 - 36

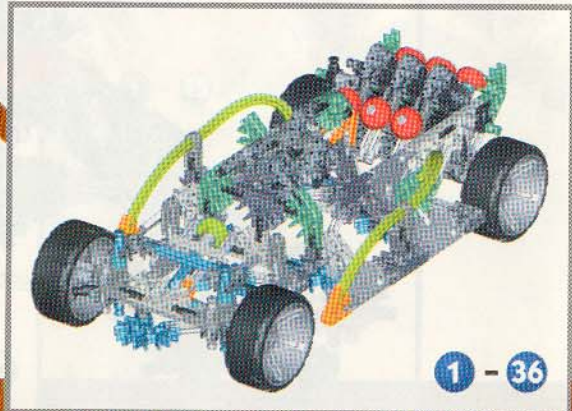

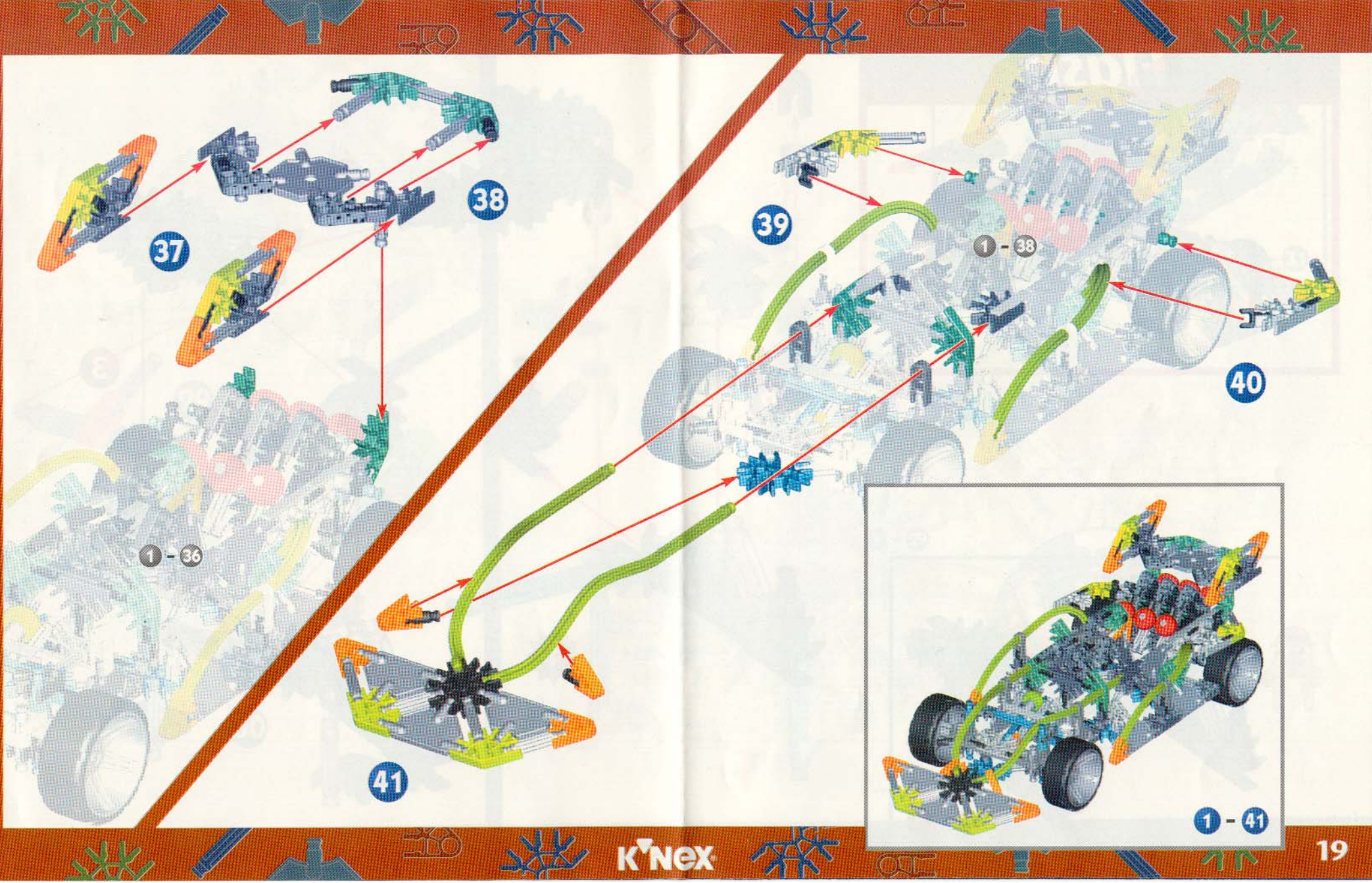

37

38

39

40

41

1 - 41

# Flash

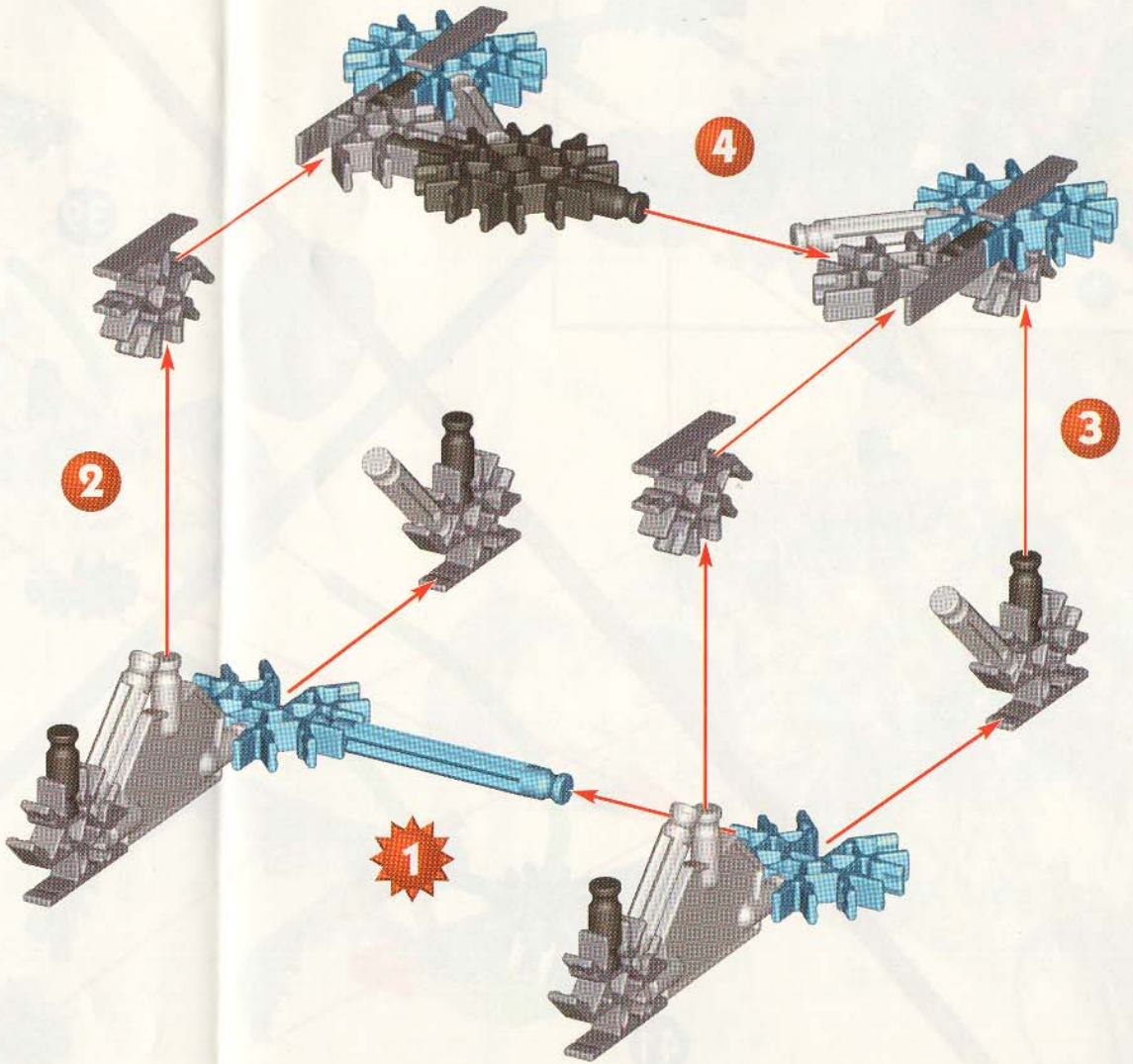
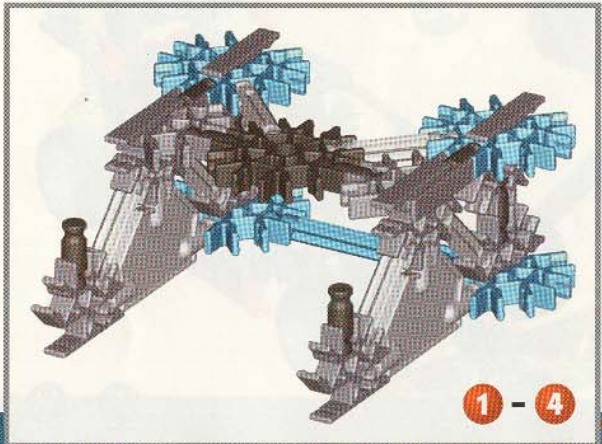
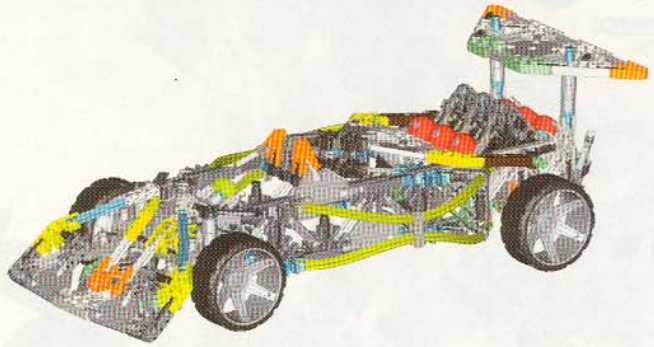

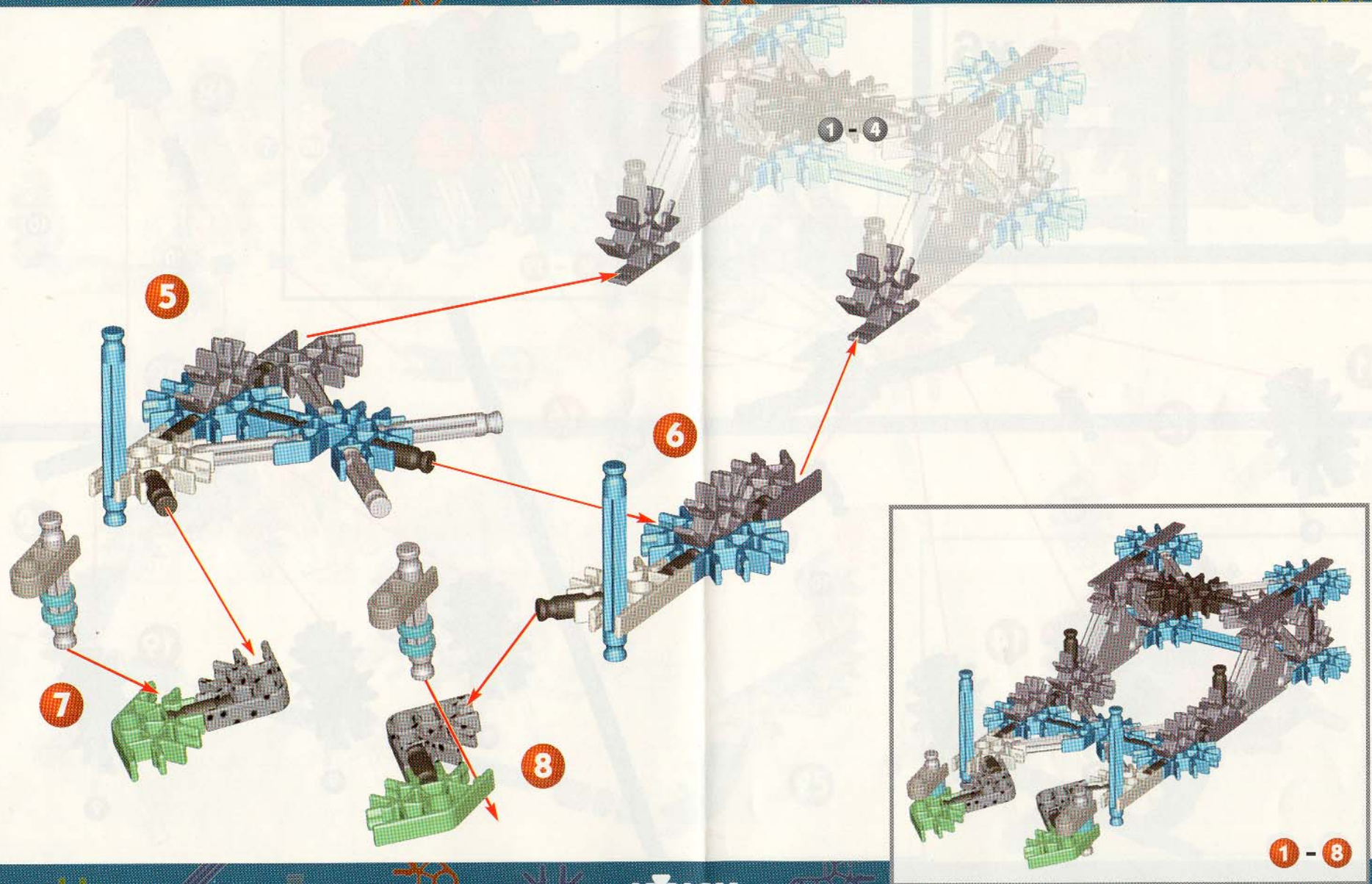

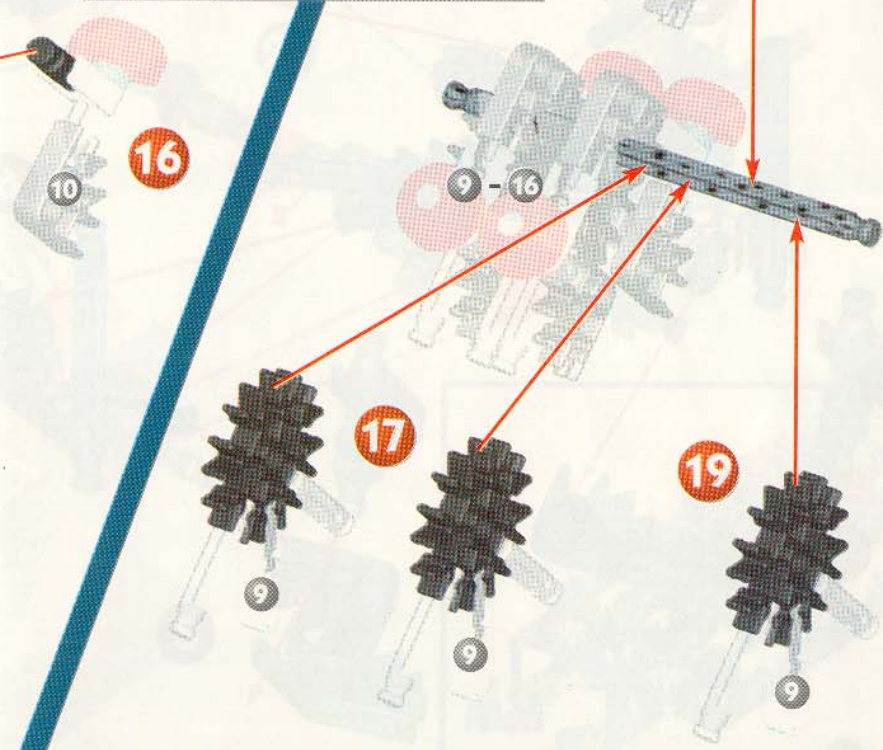
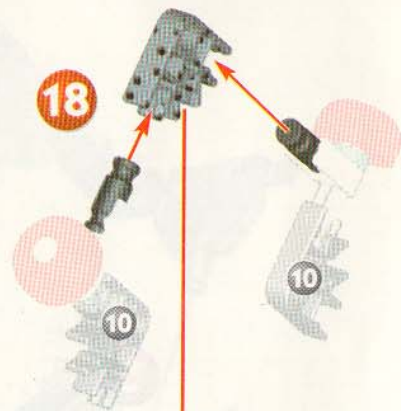
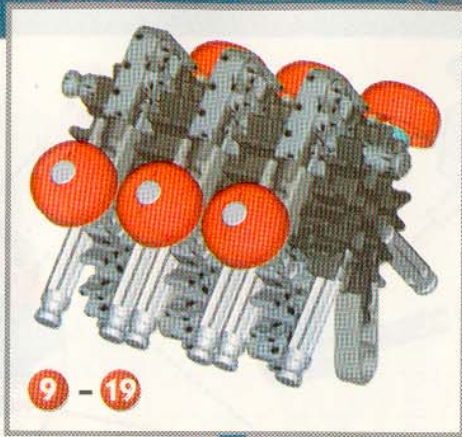
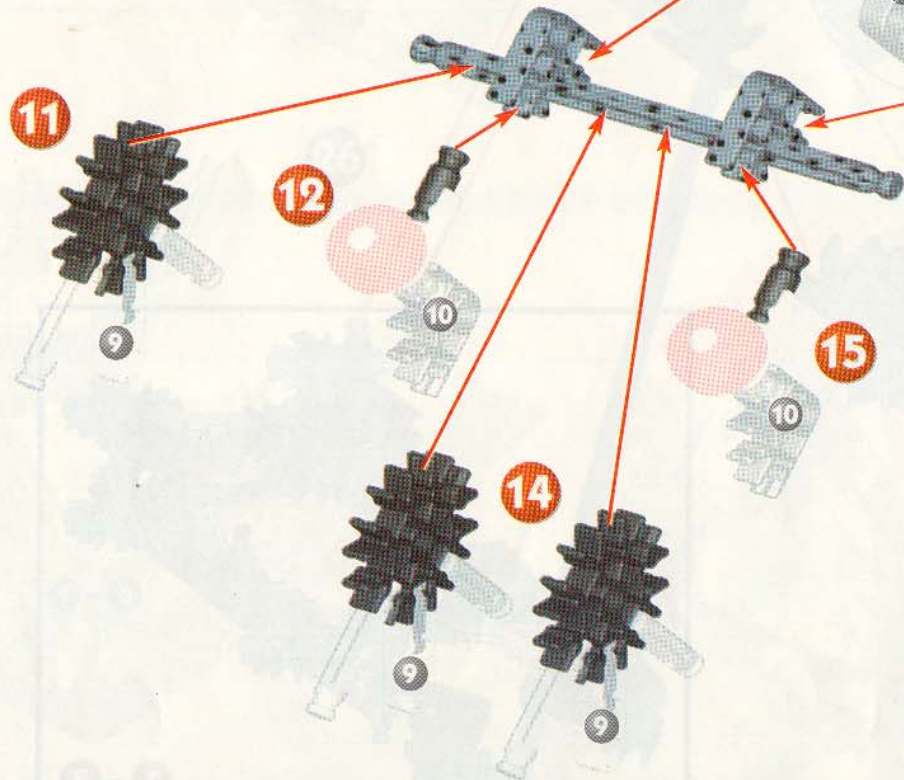
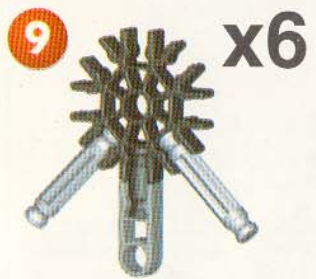

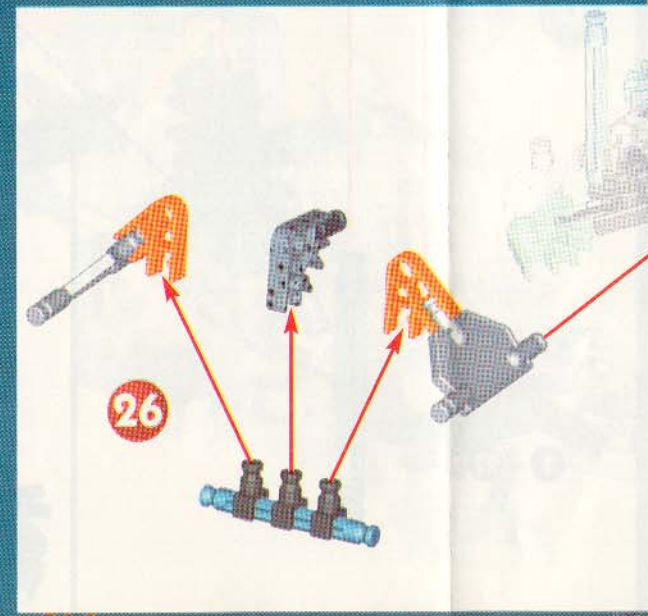
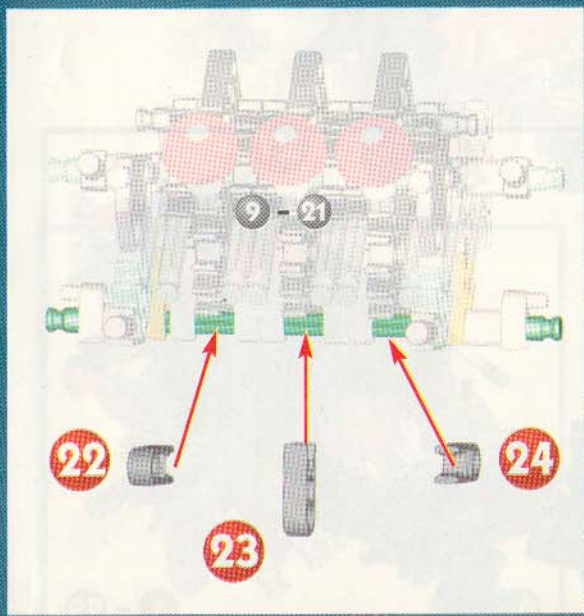
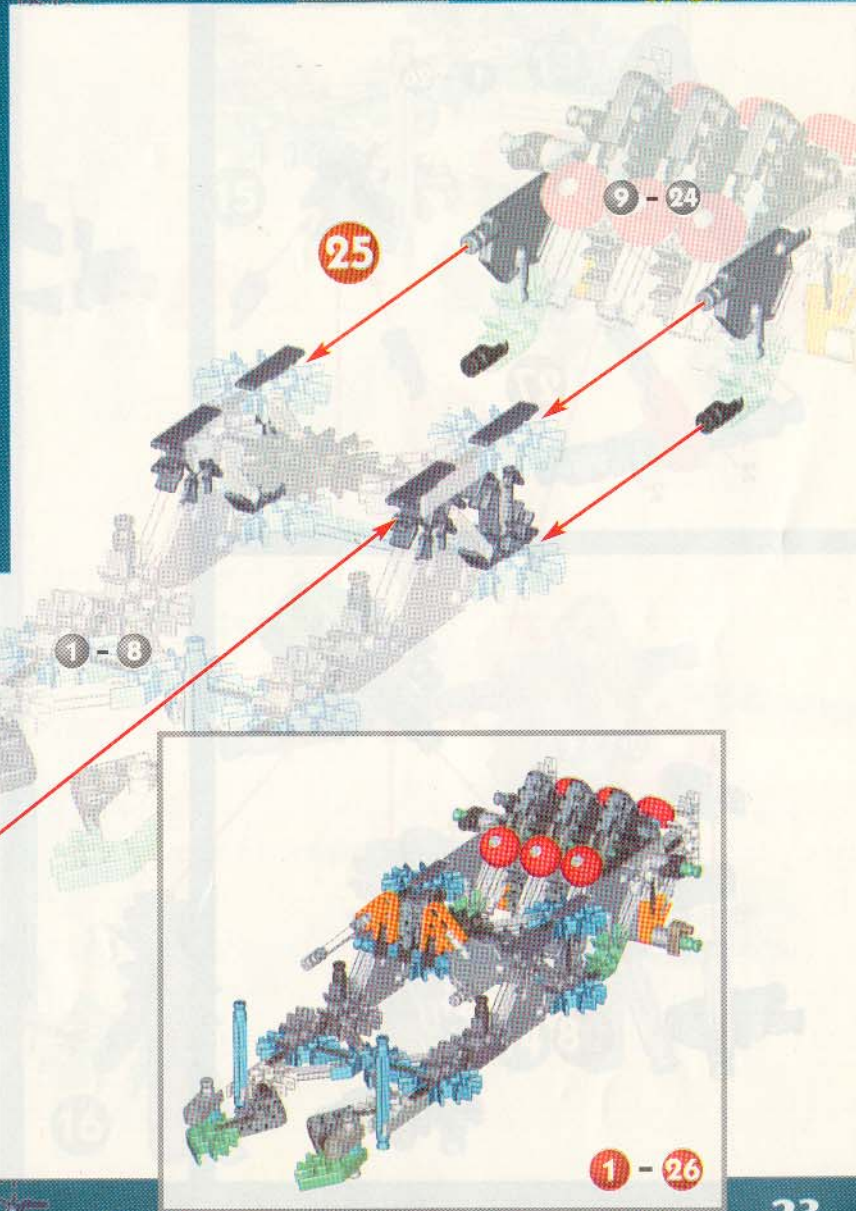
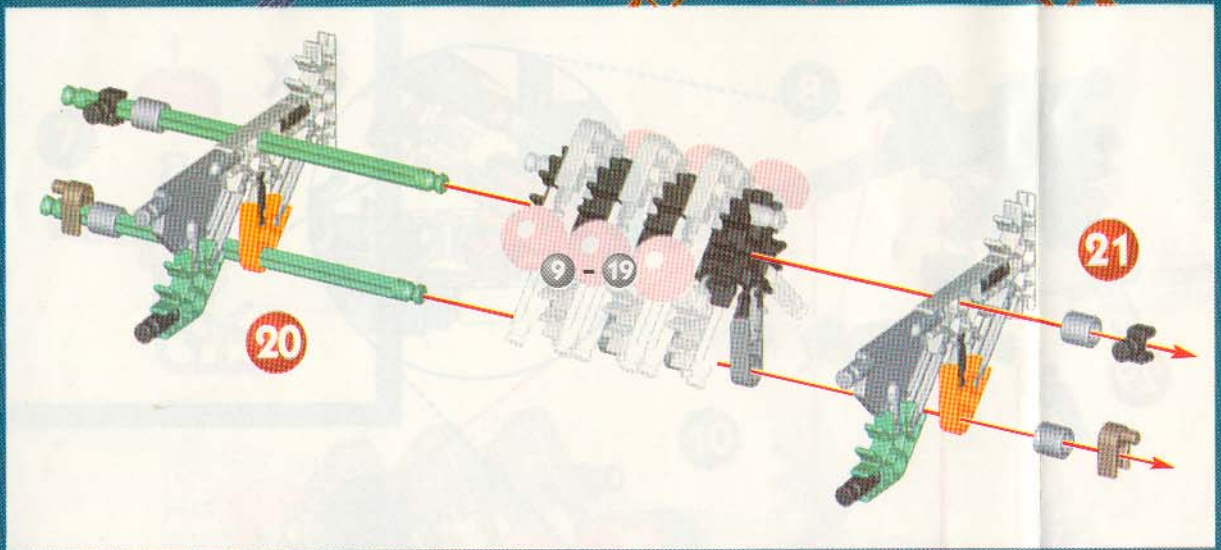

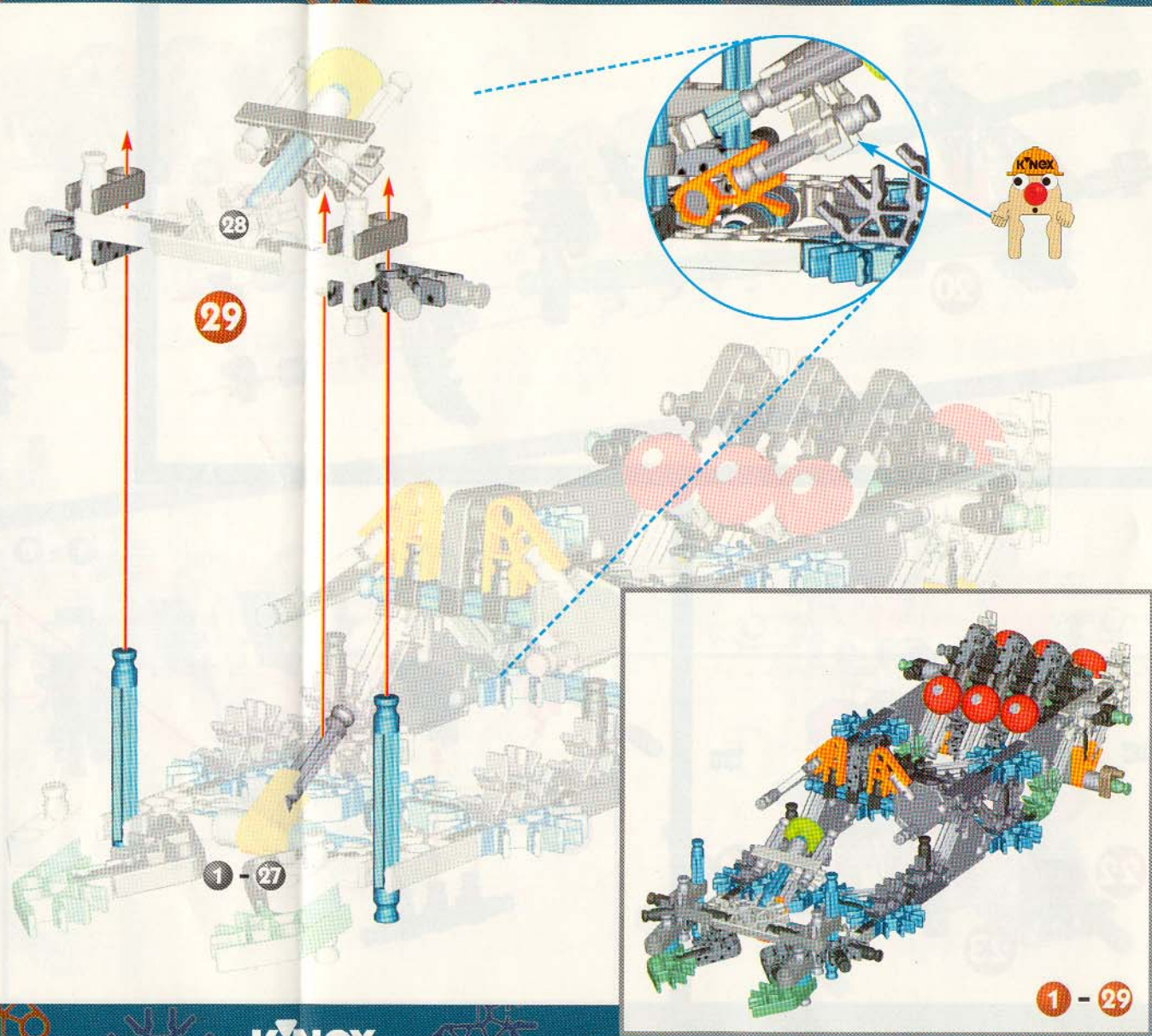
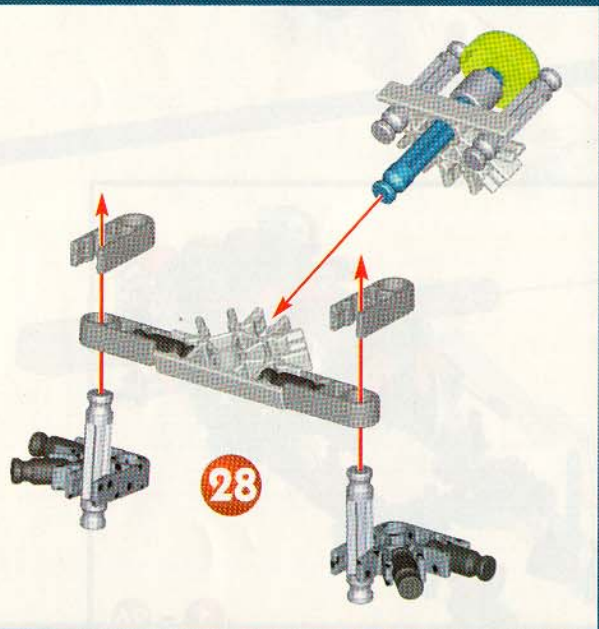
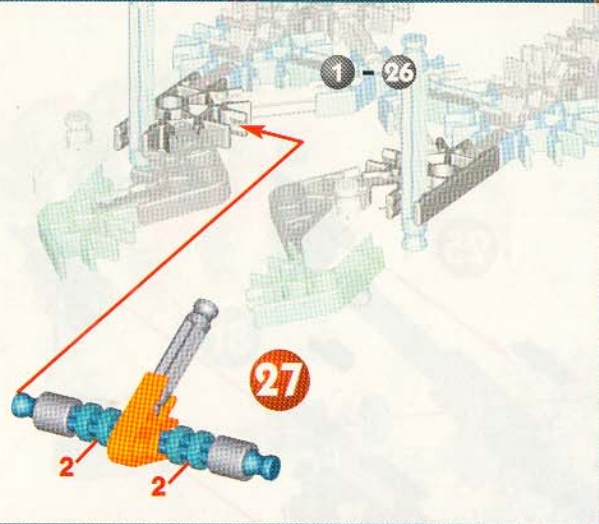



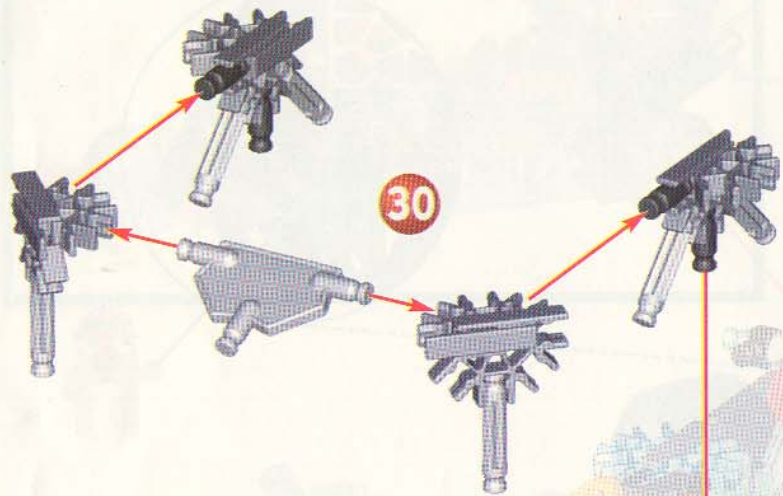

1 - 29

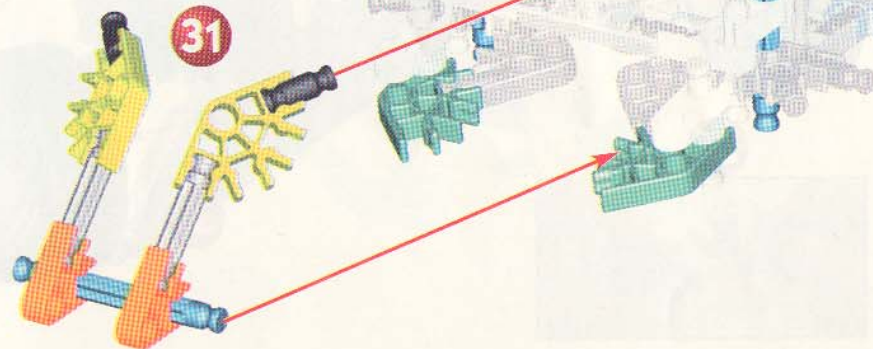
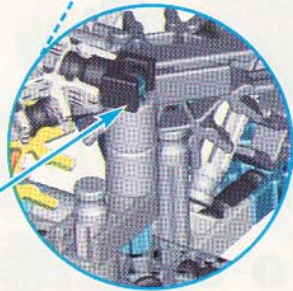
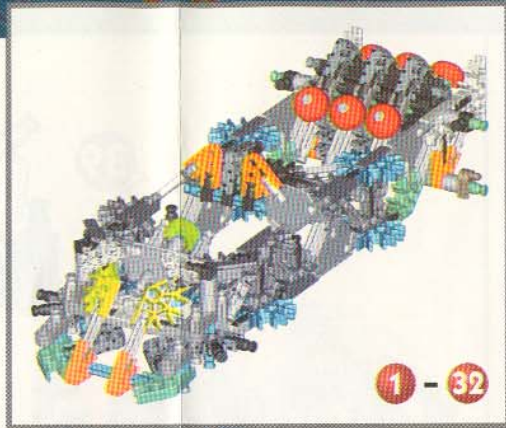

1 - 30

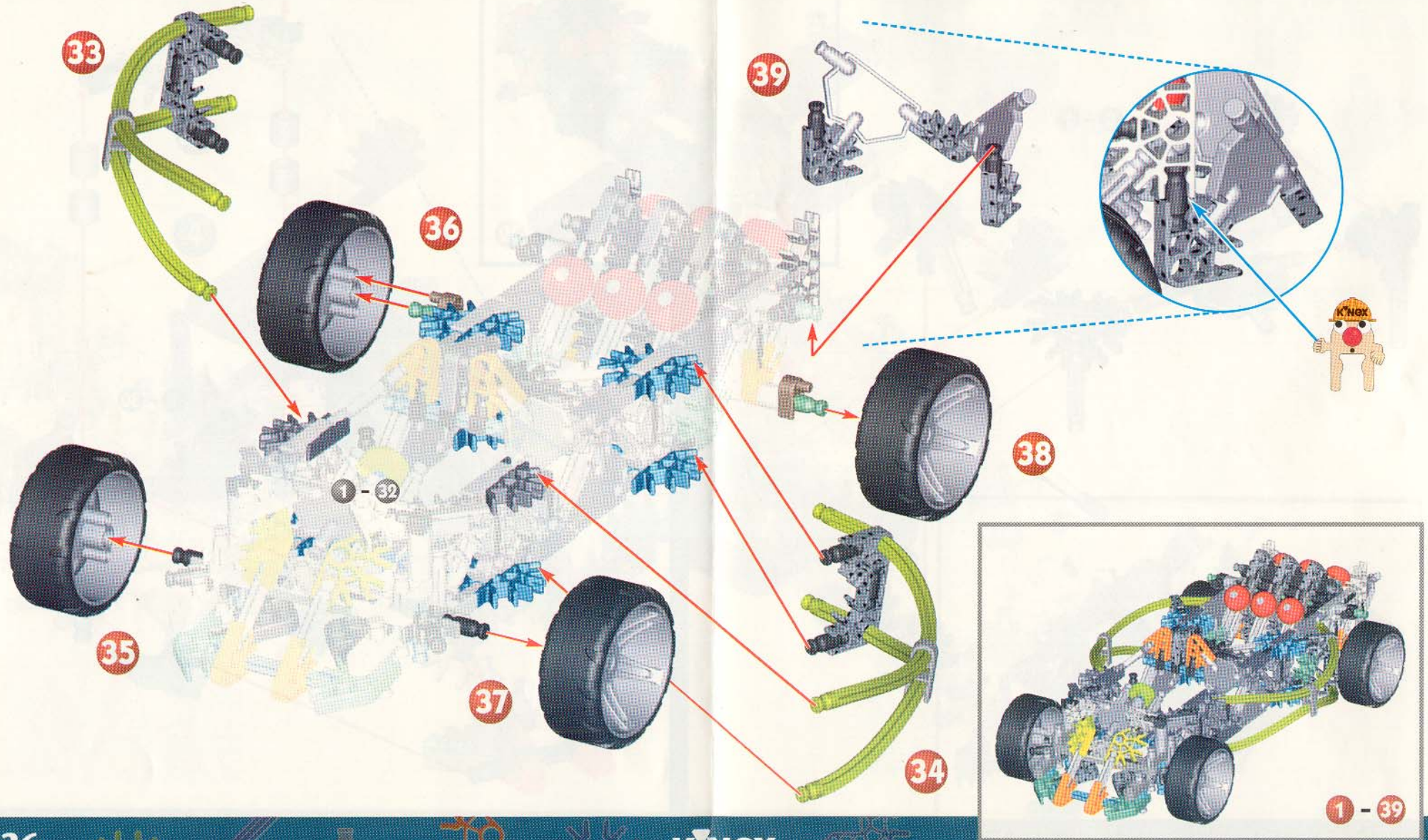

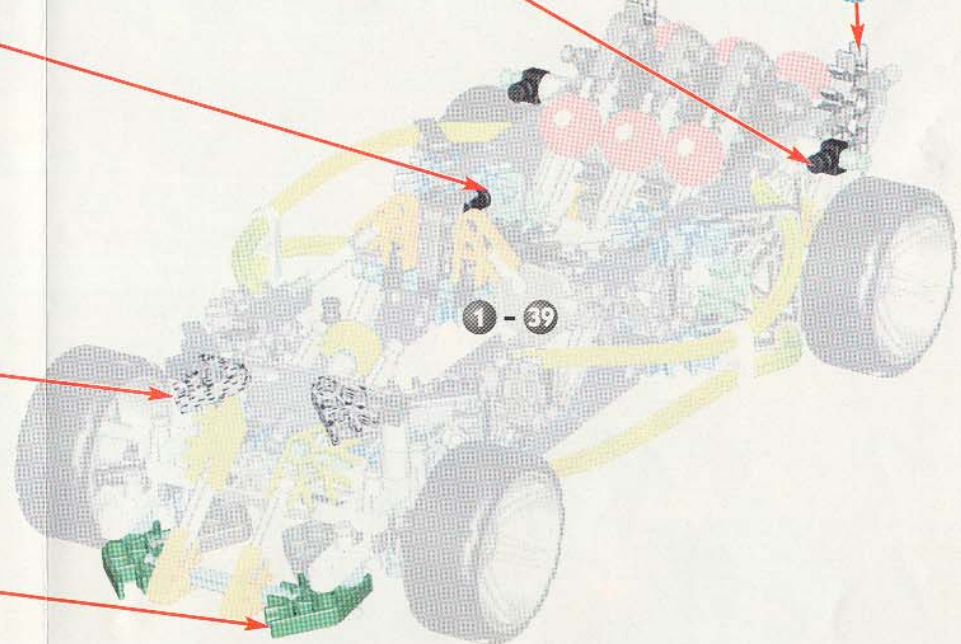
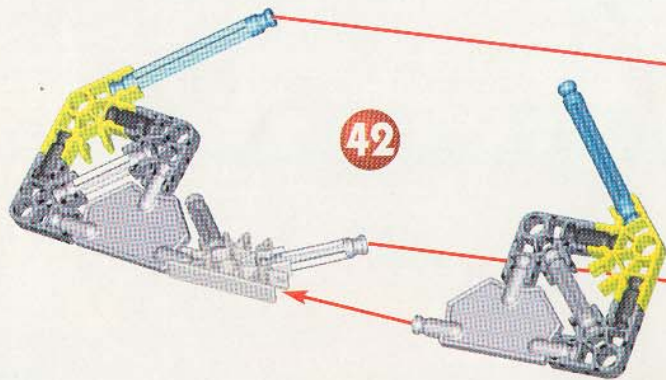
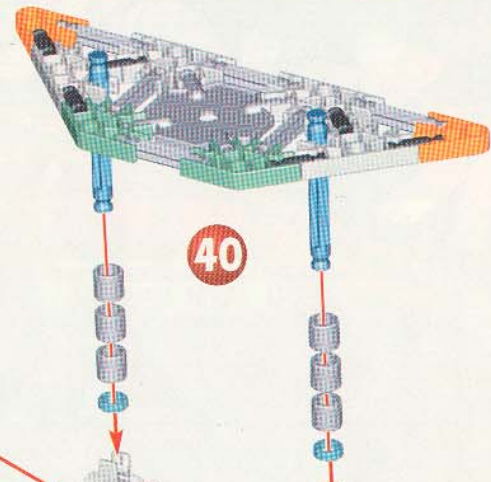
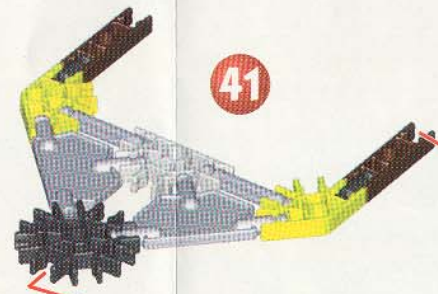

# K'NEX®

COOL MACHINES

## FORMULA RACERS

Also Builds  
**FLASH**



Also Builds  
**TURBO**

Questions? Call us  
at 1-800-KID-KNEX  
(USA/Canada only)  
[www.knex.com](http://www.knex.com)

©2000 K'NEX Industries, Inc.  
P.O. Box 700  
Hatfield, PA 19440-0700



Made in the U.S.A.  
Fabriqué aux États-Unis.

K'NEX is a registered trademark of K'NEX Industries, Inc.  
K'NEX est une marque déposée de K'NEX Industries, Inc.

Manufactured under U.S. Patents/Fabrique sous brevets  
américains: 5,061,219; 5,137,486; 5,199,919; 5,238,438;  
5,346,420; 5,350,331; 5,368,514; 5,421,762; 5,423,707;  
5,427,559; 5,518,435; D383,509; D388,475; D389,003;  
D391,843; D391,921; D392,555. Other U.S. and foreign  
patents pending./Autres brevets américains et étrangers  
en instance.

Colors and product may vary.

Le produit et les couleurs peuvent varier.

El producto y los colores pueden variar.

Conforms to the Requirements of ASTM Standard Consumer  
Safety Specification on Toy Safety, F963-96a./Conforme  
aux spécifications de sécurité du consommateur sur la  
sécurité des jouets de la norme ASTM F963-96a.

94166-V2-7/00