

THE ORIGINAL
LINCOLN LOGS[®]
 COLLECTOR'S EDITION™ BUILDING SET

3+



YOU CAN CREATE THESE OTHER BUILDINGS OR DESIGN YOUR OWN!

¡PUEDES CREAR ESTOS OTROS EDIFICIOS O DISEÑAR LOS TUYOS!

TU PEUX ÉGALEMENT CRÉER D'AUTRES MODÈLES, OU BIEN CONSTRUIS DES CRÉATIONS ISSUES DE TON IMAGINATION !



ALL WOOD PIECES
Just Like You Remember![™]



INCLUDES: 111 LOGS, 30 GREEN SLATS, 6 RED ROOF SUPPORTS, 3 RED CHIMNEYS.
INCLUYE: 111 LEÑOS, 30 LISTONES VERDES, 6 SOPORTES ROJOS PARA EL TECHO, 3 CHIMENEAS ROJAS.
COMPREND : 111 RONDINS, 30 LATTES VERTES, 6 SUPPORTS DE TOIT ROUGES, 3 CHEMINÉES ROUGES.

www.facebook.com/buildknex

CHECK US OUT ON THE WEB!
HTTP://LINCOLNLOGS.KNEX.COM
VENEZ NOUS RENDRE VISITE SUR LE WEB !
¡VISITE NUESTRA PÁGINA EN EL INTERNET!

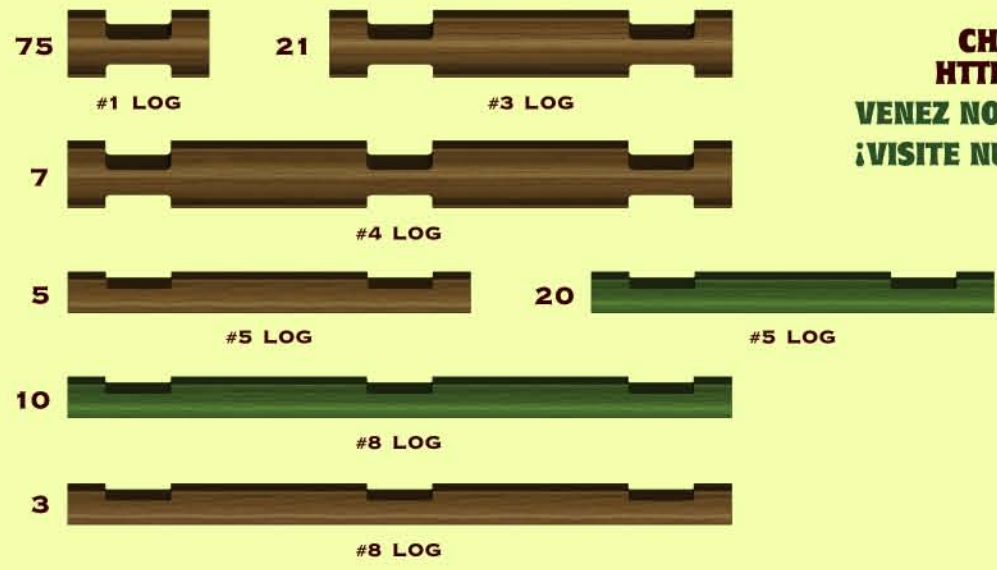

1-800-KID-KNEX
 (usa/canada)
 (états-unis/canada)

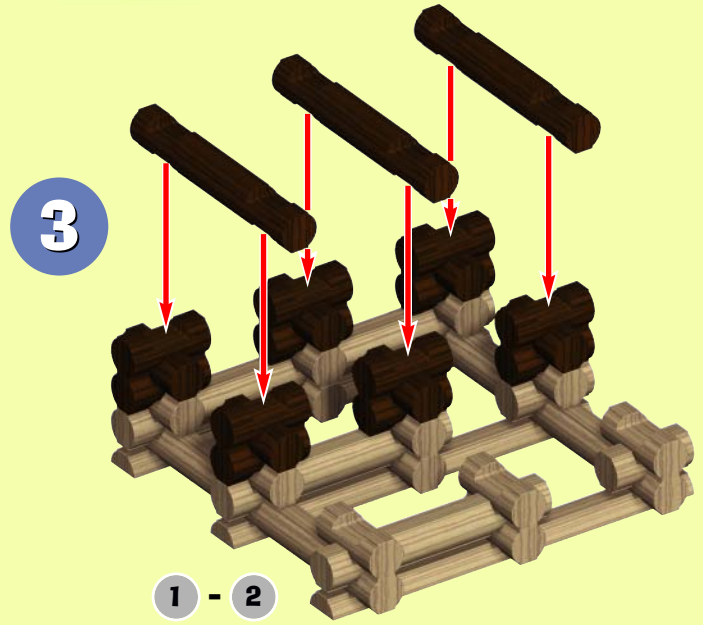
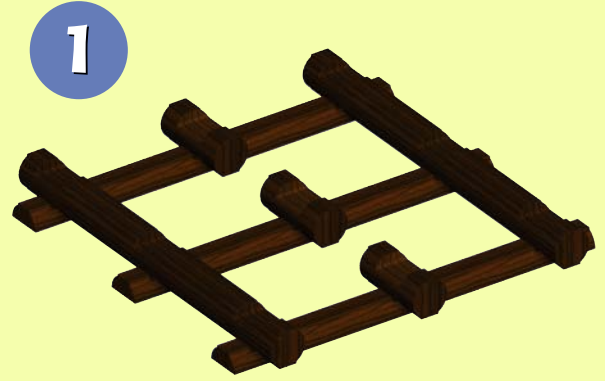

K'NEX
 Limited Partnership Group
 P.O. Box 700
 Hatfield, PA 19440-0700
 Made in China.
 Hecho en China.
 Fabriqué en Chine.
www.knex.com

Product & colors may vary. Most models can be built one at a time. Instructions are included for the model shown on the package front. HASBRO and its logos, Playskool and LINCOLN LOGS are trademarks of HASBRO and are used with permission. ©2011 HASBRO. All Rights Reserved.
 El producto y los colores pueden variar. La mayoría de los modelos se pueden construir uno a la vez. Se incluyen instrucciones para el modelo que se ve en el frente del paquete. HASBRO y su insignia, Playskool y LINCOLN LOGS son marcas registradas de HASBRO y se utilizan con el permiso.
 ©2011 HASBRO. Todos los Derechos Reservados.
 Produits et couleurs peuvent varier. La plupart des modèles ne peuvent être construits que un à un. Les instructions sont incluses pour le modèle figurant sur le devant de la boîte. HASBRO et son logo, Playskool et LINCOLN LOGS sont des marques déposées de HASBRO et sont employés avec la permission.
 ©2011 HASBRO. Tous Droits Réservés.

Licensed By:

TIP FOR PARENTS: Because LINCOLN LOGS pieces are colored and stained in the traditional manner, the dyes can rub off. Use is recommended on surfaces that can be wiped clean. Avoid placing the logs directly on carpet and other absorbent surfaces, which may cause staining.
CONSEJO PARA LOS PADRES: Como las piezas LINCOLN LOGS son pintadas y teñidas en la manera tradicional, las tintas pueden desteñir. Se recomienda usarlas en superficies que se pueden limpiar con un paño húmedo. Evite usar los leños directamente en una alfombra u otras superficies absorbentes, pues las tintas pueden causar manchas.
CONSEIL AUX PARENTS : Les éléments de LINCOLN LOGS étant colorés et teints de manière traditionnelle, les couleurs peuvent déteindre. Il est donc recommandé de poser les éléments sur des surfaces qui peuvent être facilement essuyées. Évitez aussi de placer les bûches directement sur les moquettes, les tapis, et les autres surfaces absorbantes. Elles risqueraient de se tacher.

V1-03/11

00870

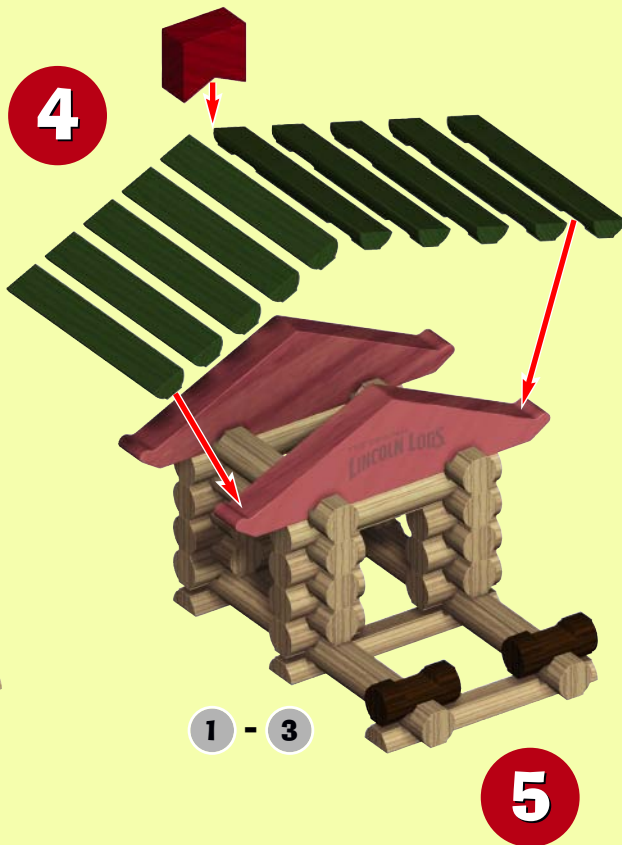
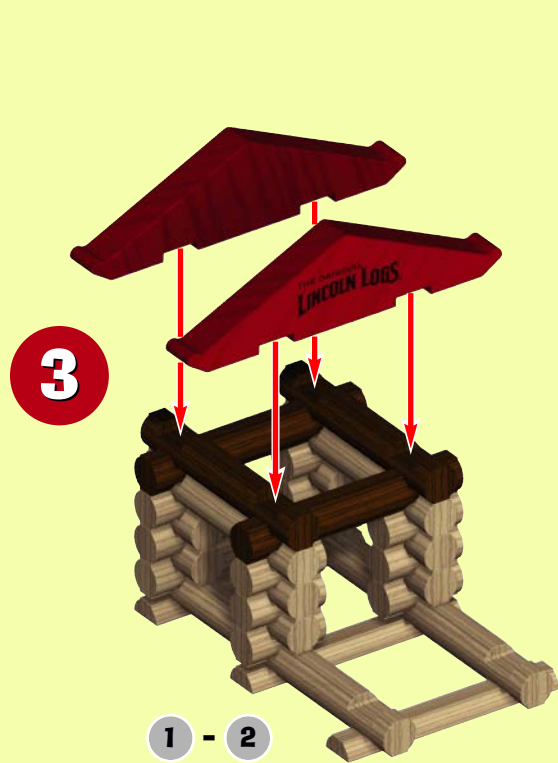
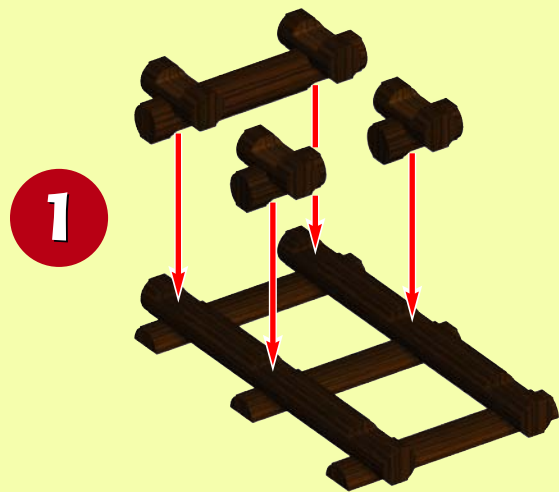
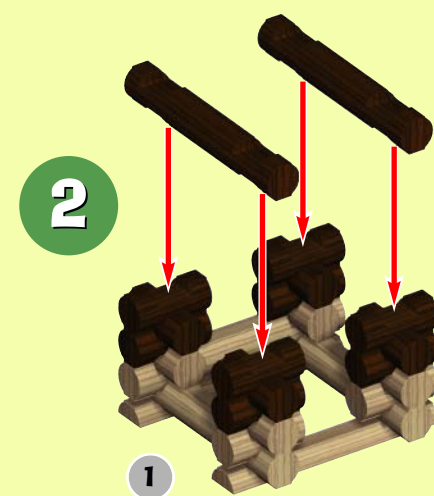
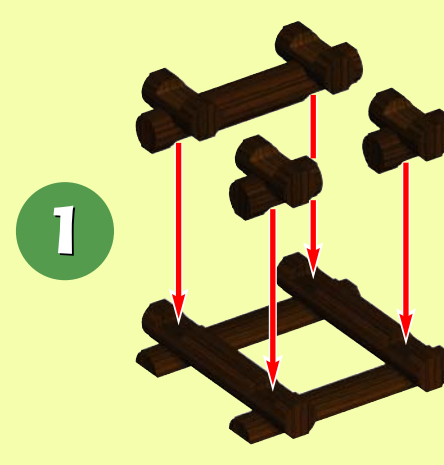
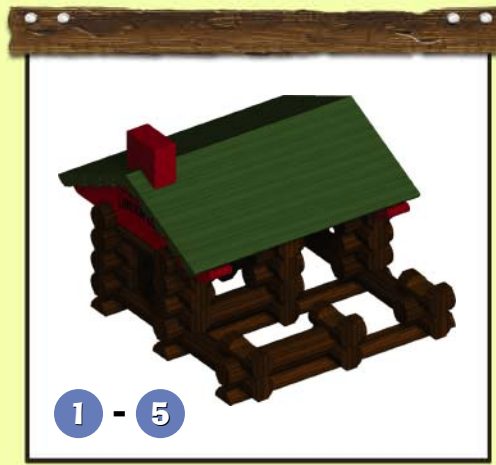
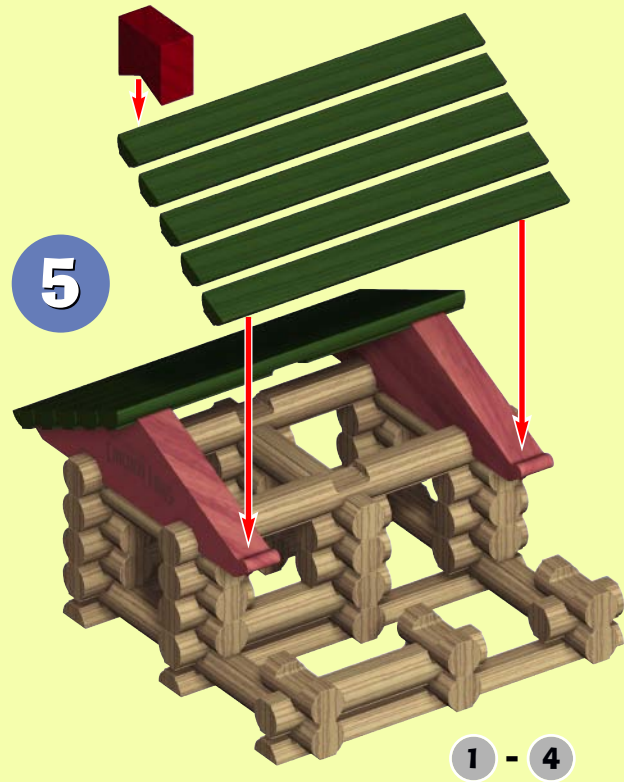
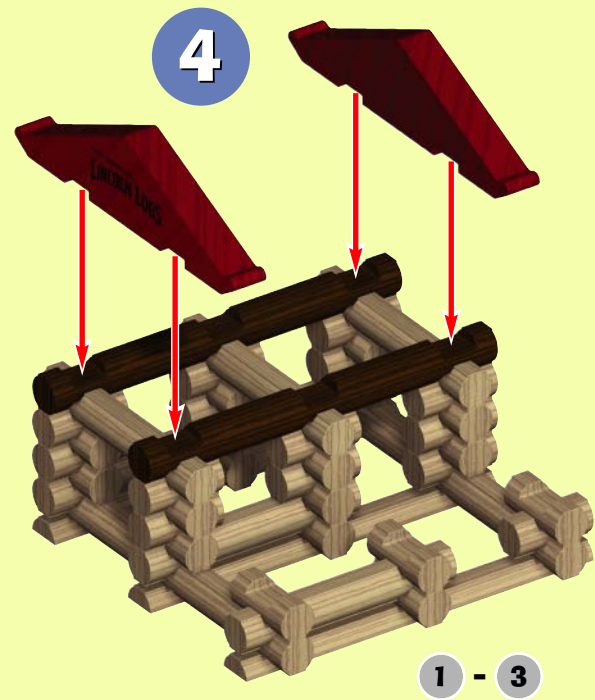

5

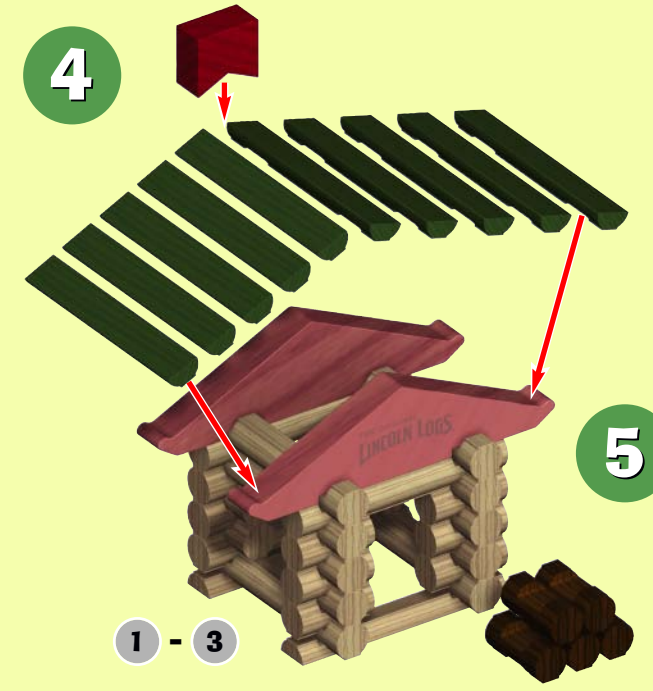
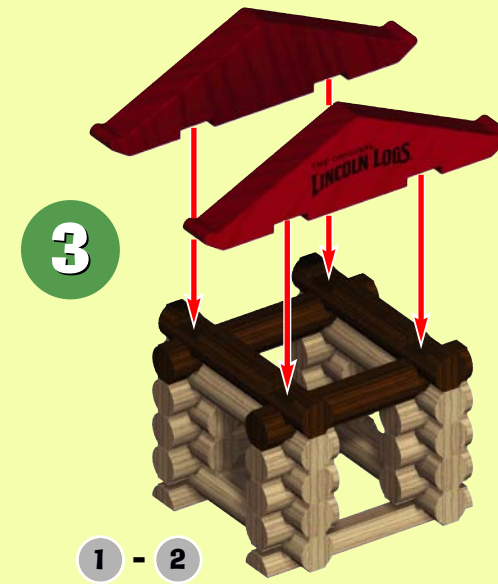

5

