

TIP FOR PARENTS:
Because LINCOLN LOGS pieces are colored and stained in the traditional manner, the dyes can rub off. Use is recommended on surfaces that can be wiped clean. Avoid placing the logs directly on carpet and other absorbent surfaces, which may cause staining.

CONSEIL AUX PARENTS :
Les éléments de LINCOLN LOGS étant colorés et teintés de manière traditionnelle, les couleurs peuvent déteindre. Il est donc recommandé de poser les éléments sur des surfaces qui peuvent être facilement essuyées. Évitez aussi de placer les bûches directement sur les moquettes, les tapis, et les autres surfaces absorbantes. Elles risqueraient de se tacher.

CONSEJO PARA LOS PADRES:
Como las piezas LINCOLN LOGS son pintadas y teñidas en la manera tradicional, las tintas pueden desteñir. Se recomienda usarlas en superficies que se pueden limpiar con un paño húmedo. Evite usar los leños directamente en una alfombra u otras superficies absorbentes, pues las tintas pueden causar manchas.

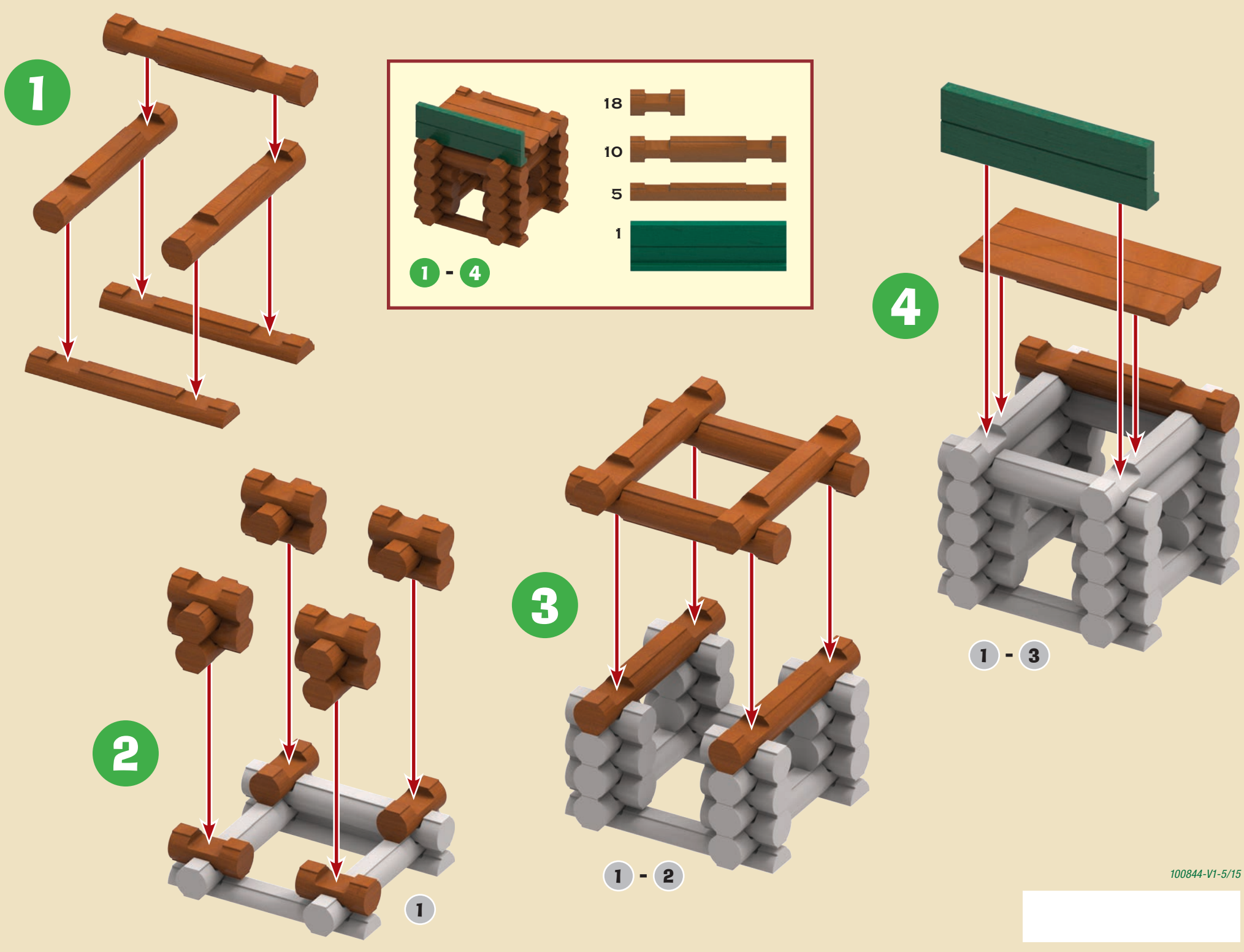

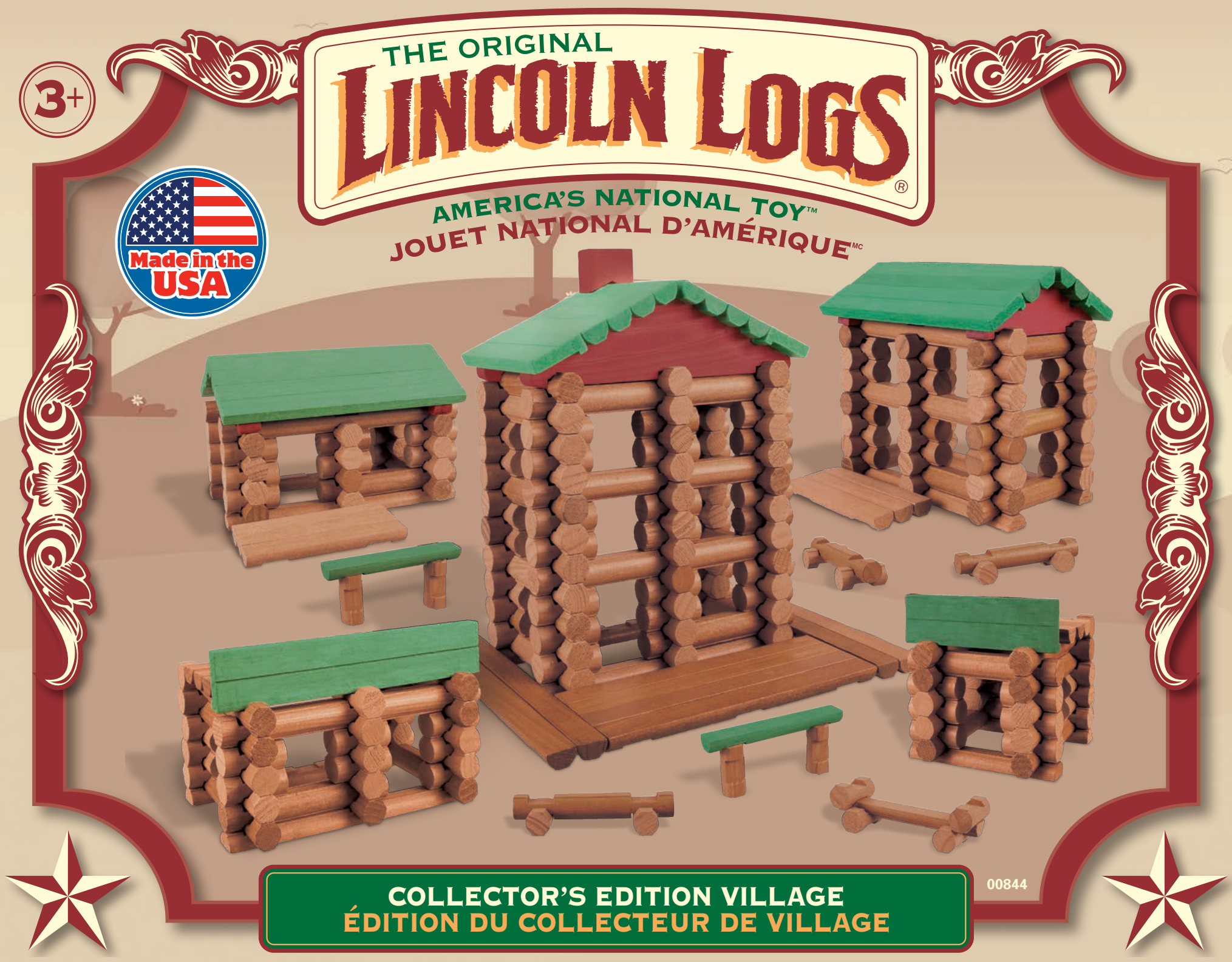
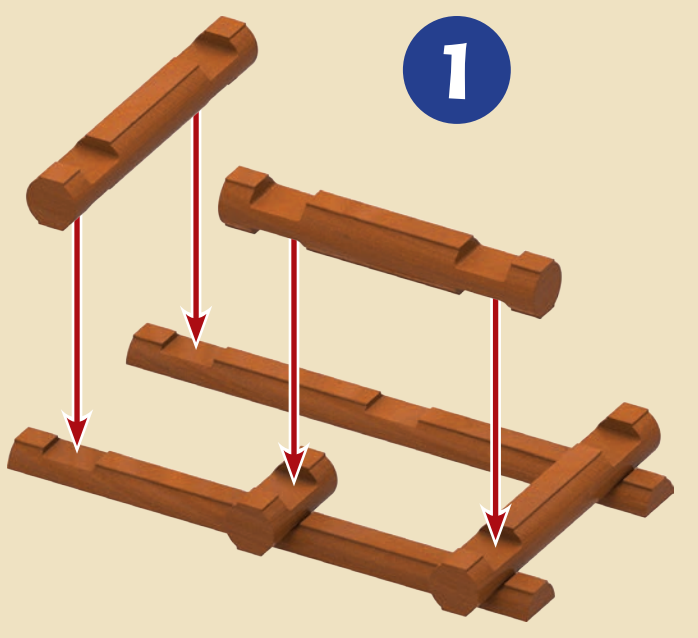

1

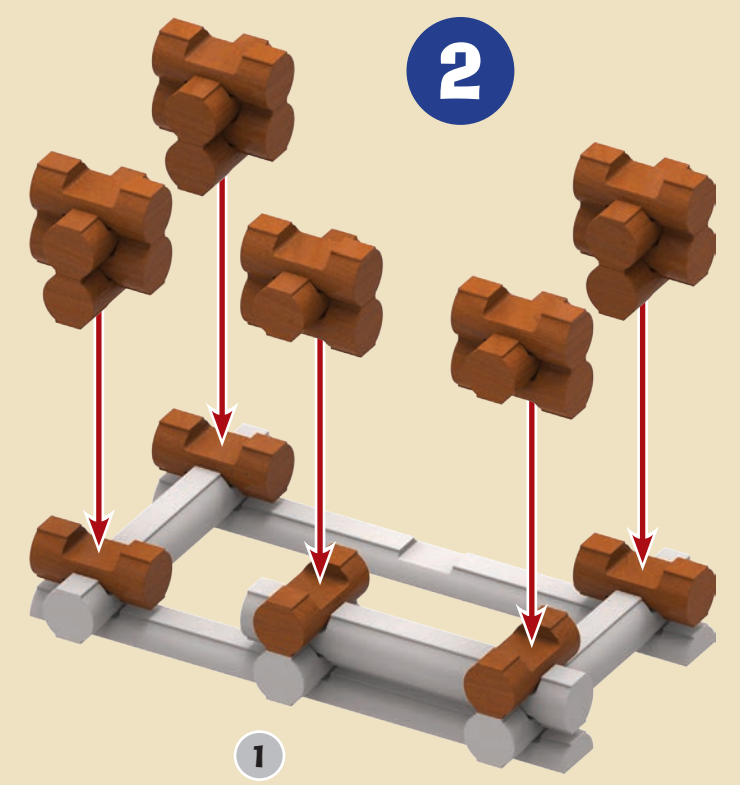

2

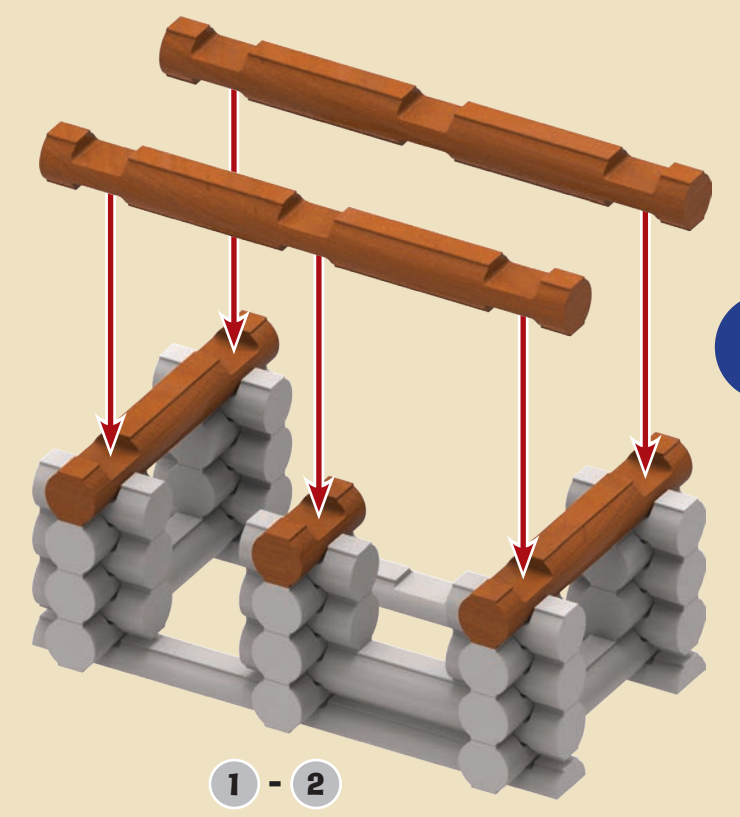

3

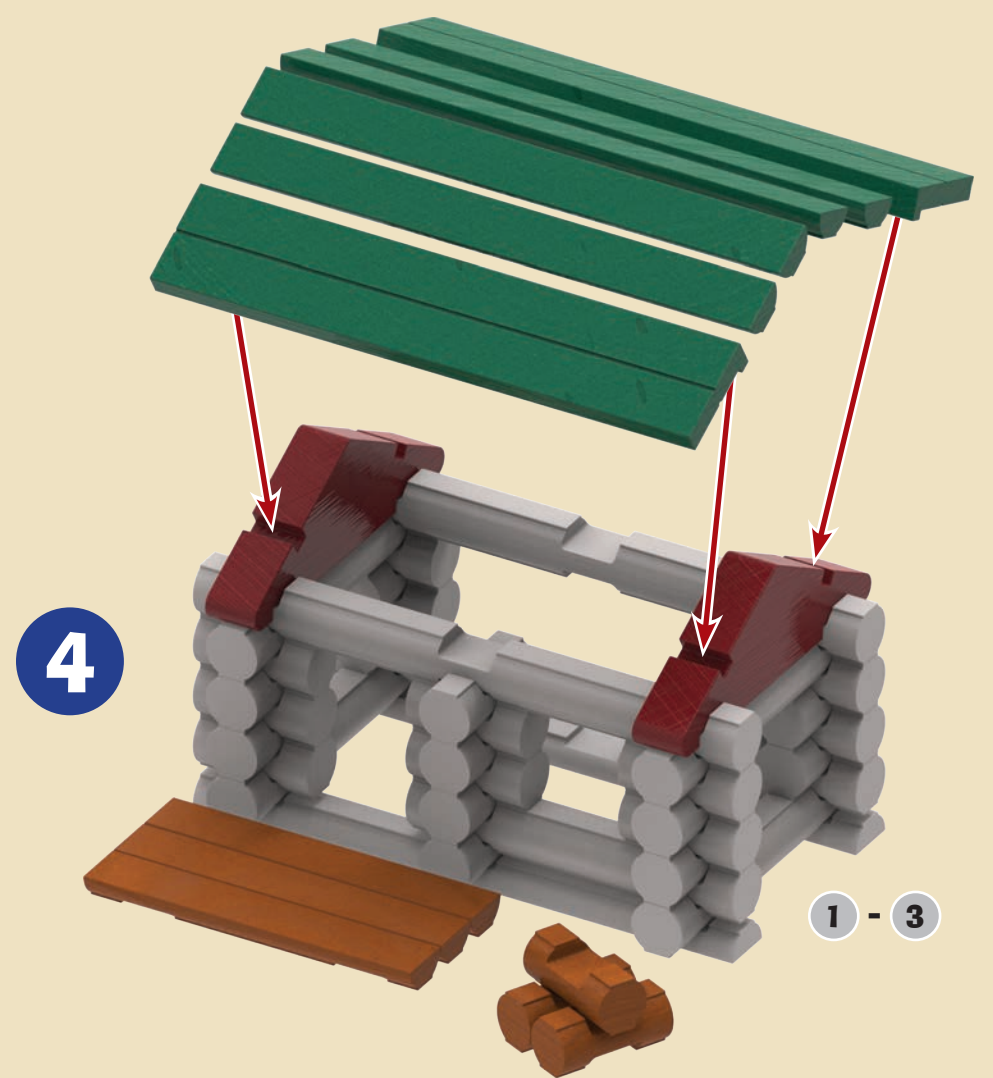

4

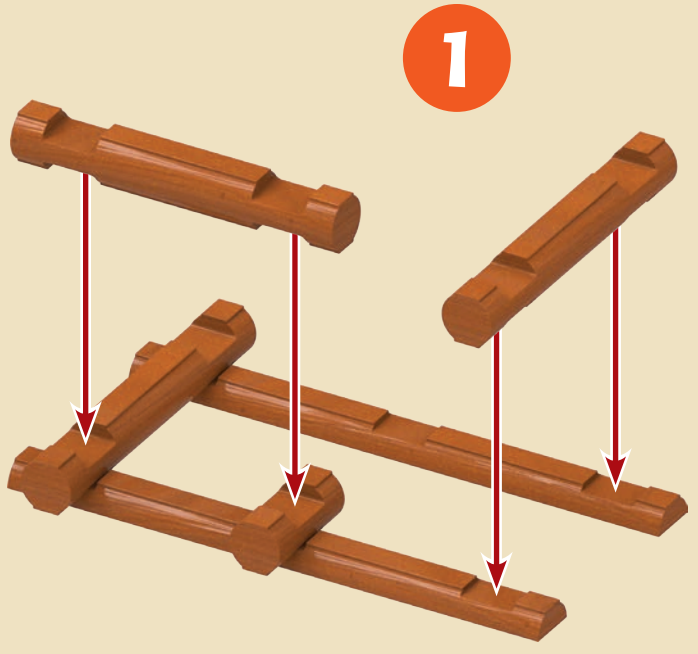
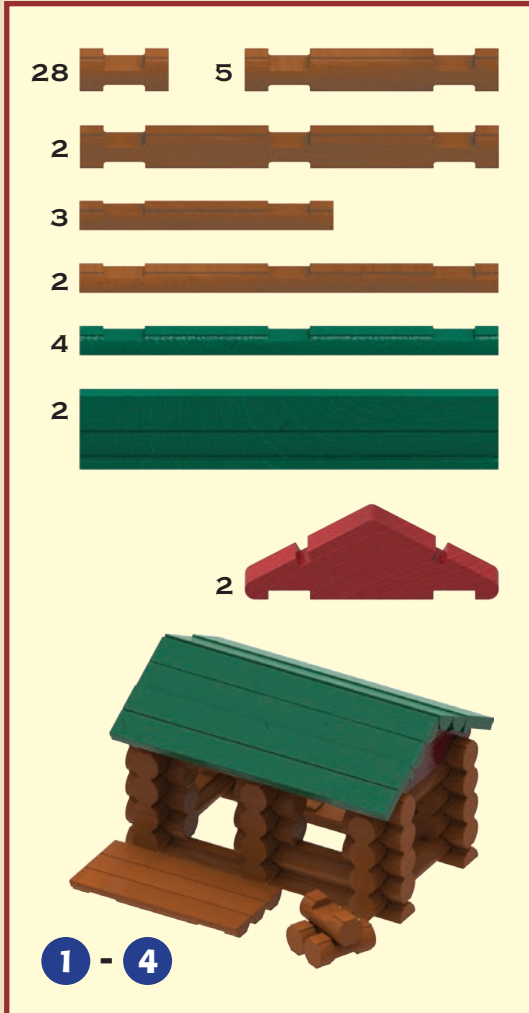

1

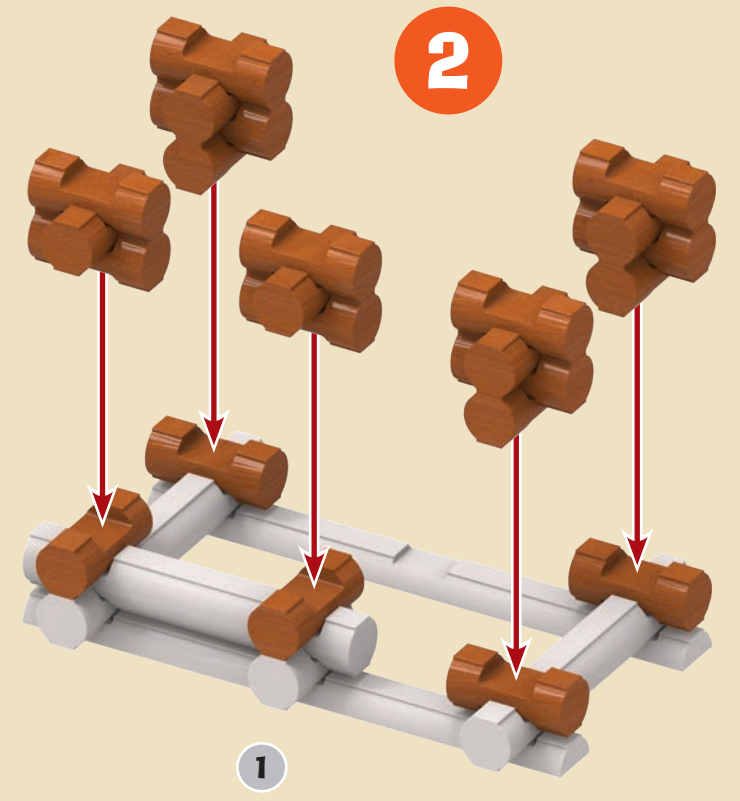

2

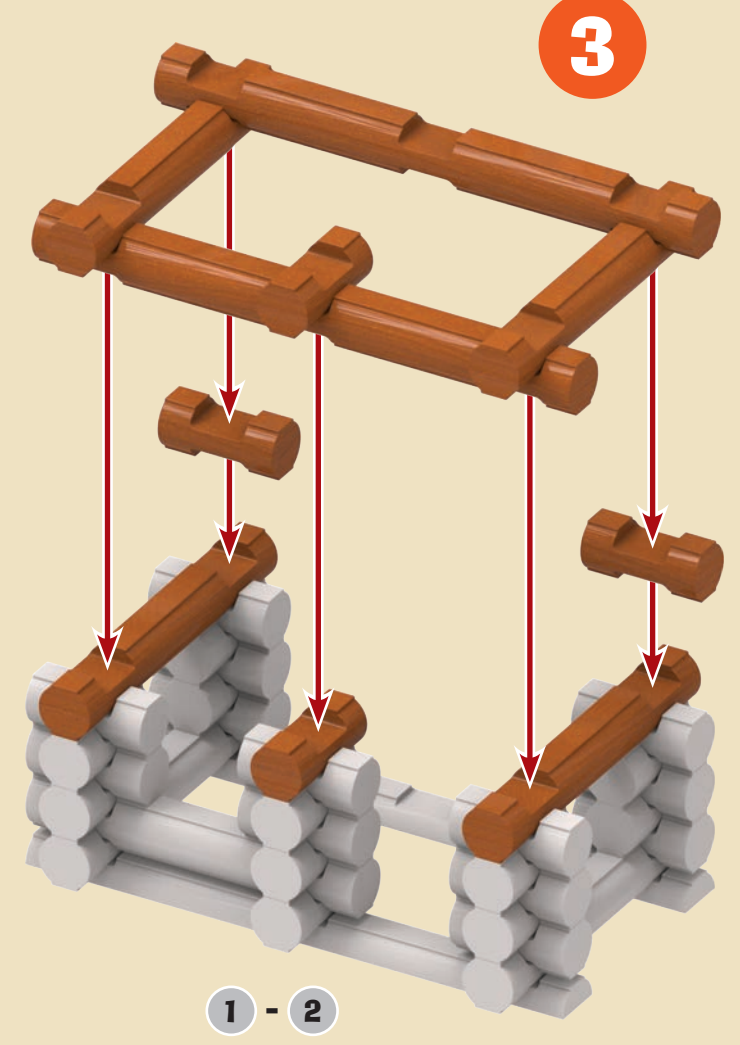

3

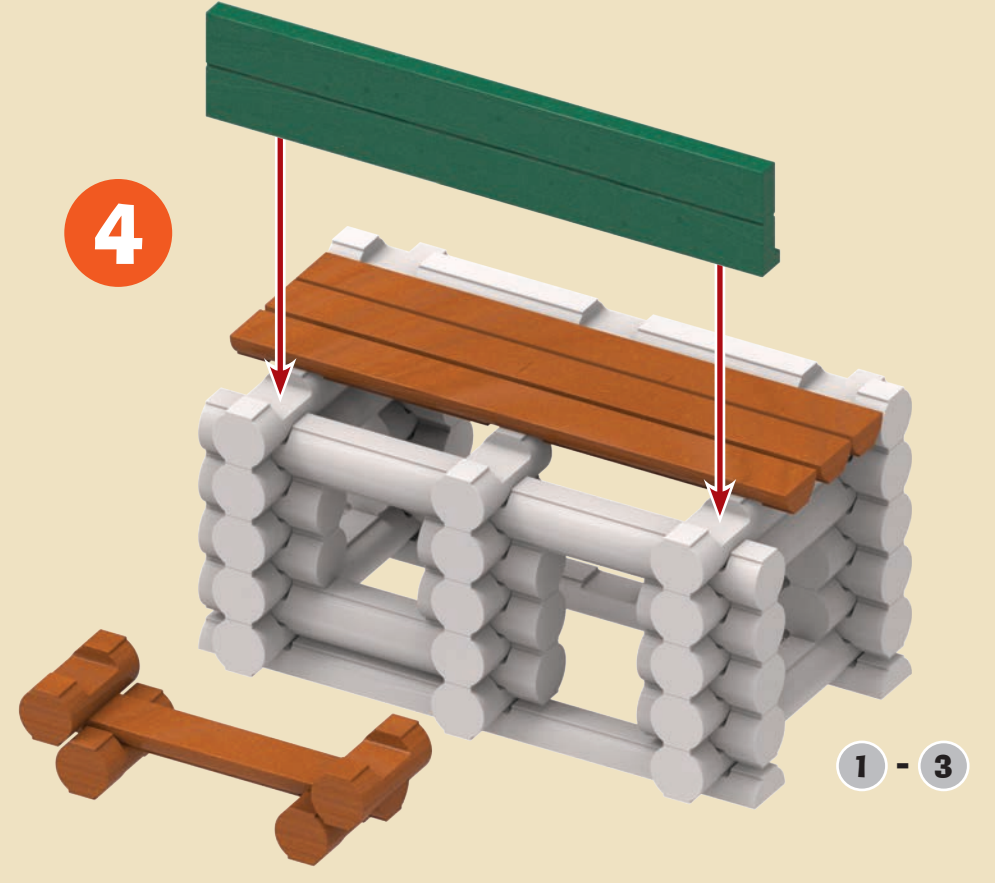

4

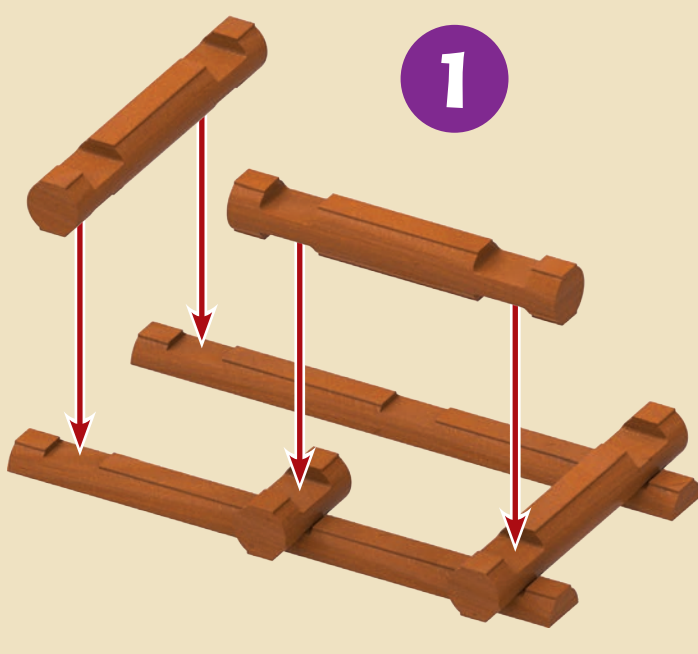
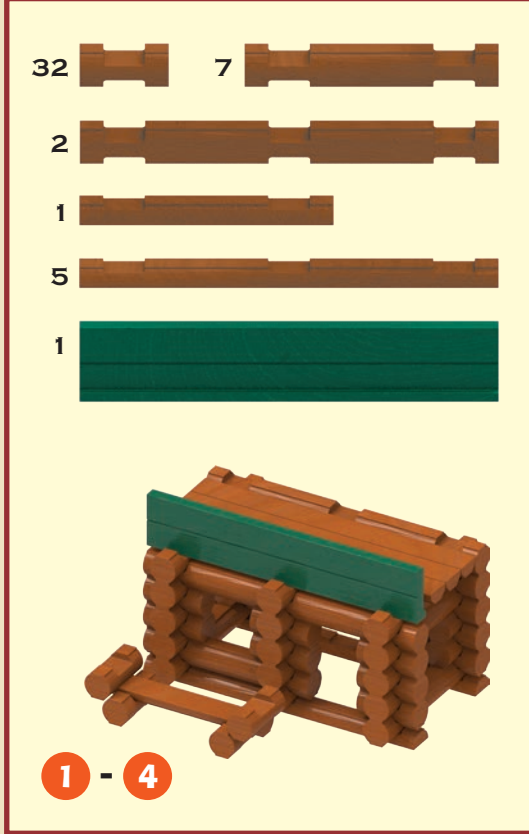

1

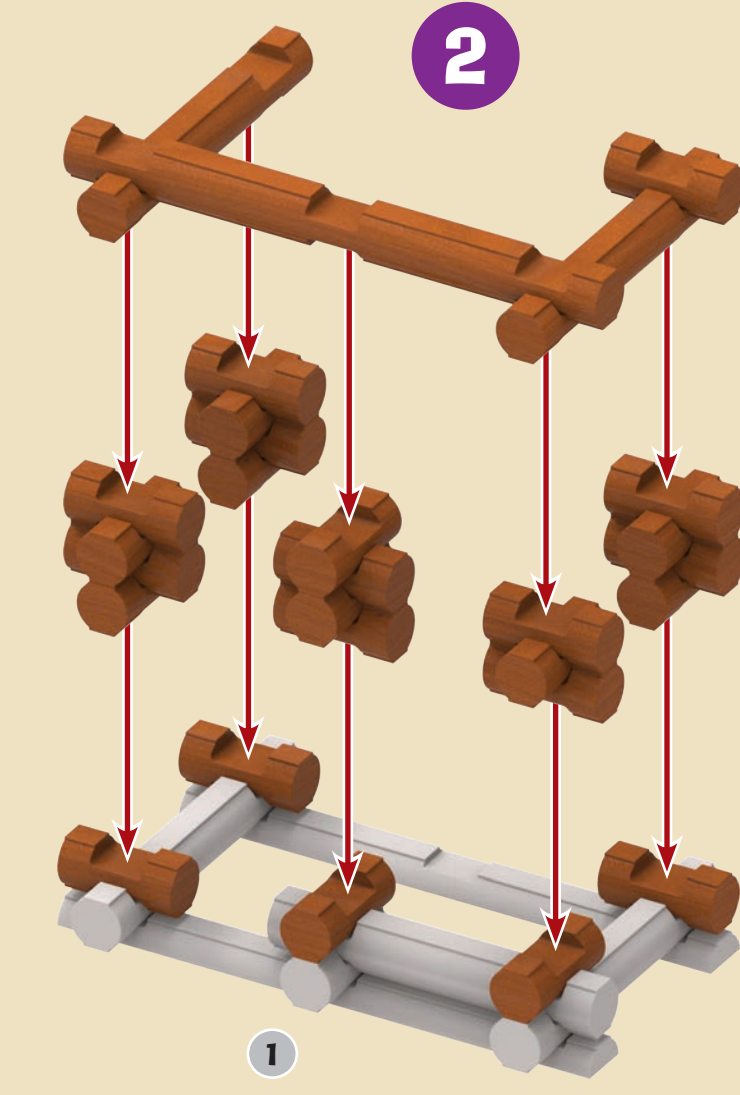

2

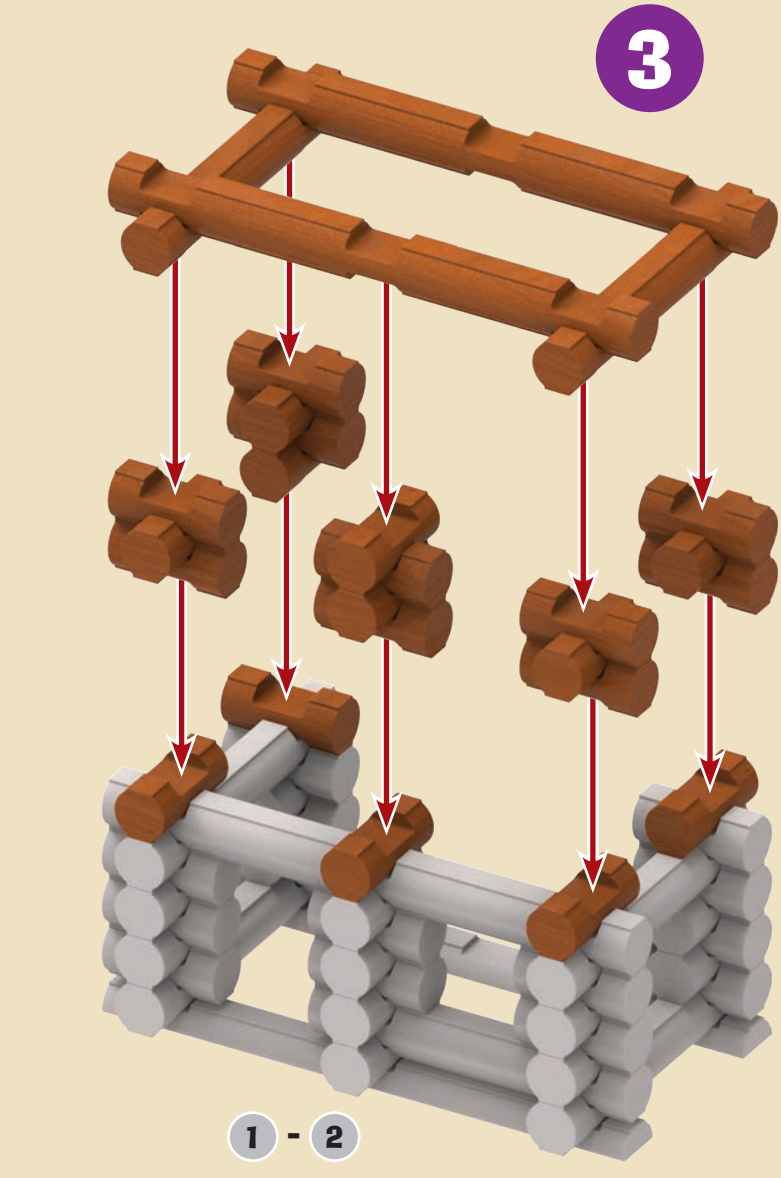

3

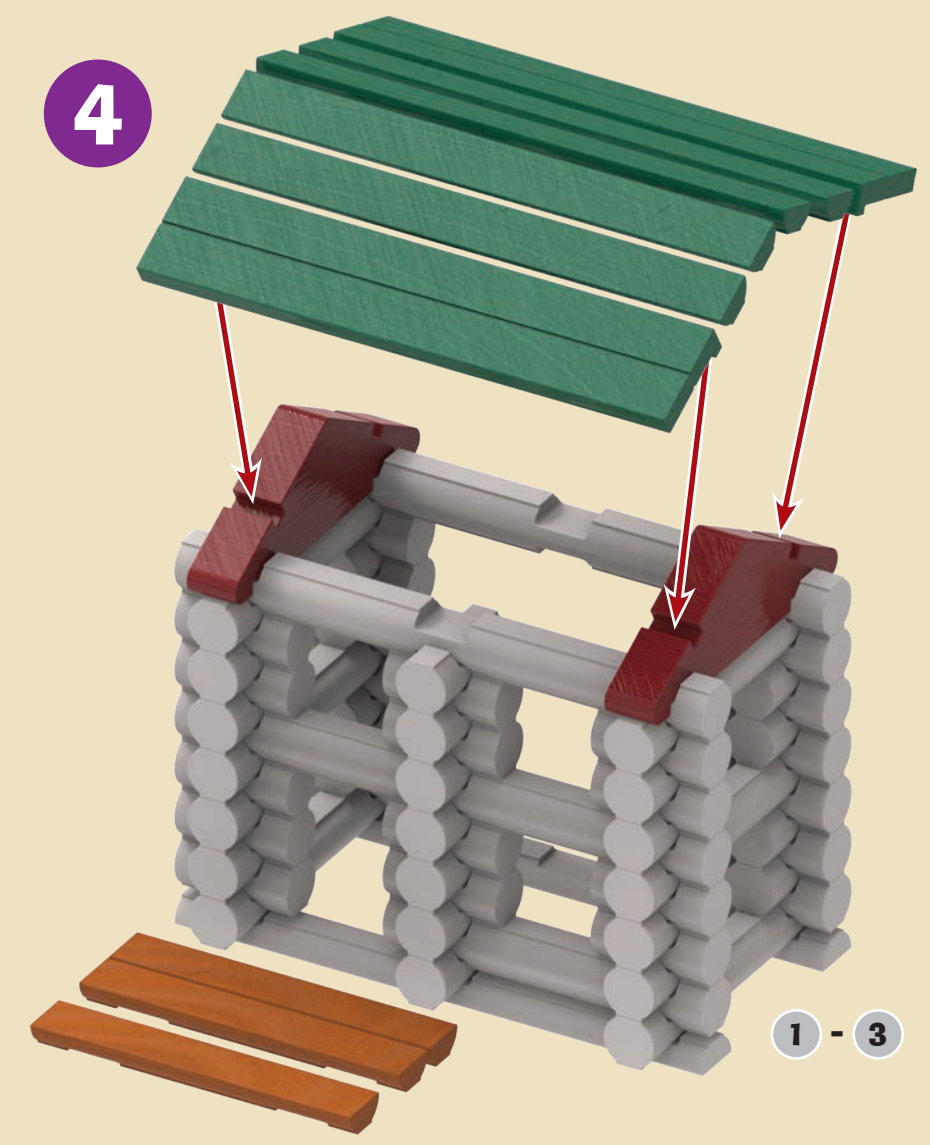

4

