

K'NEX®

Building Worlds Kids Love®

MARIOKART 8™



THWOMP RUINS BUILDING SET JEU DE CONSTRUCTION



6+ 38475

4 x AAA (LR03)
• Not included
• Not included
• No se incluyen
• Nicht enthalten
• Non incluse
• Não estão incluídas
• Niet inbegrepen

* Karts Motorizado
Motorisiertes Karts
Karts motorizzato
Karts motorizzato
Gemotoriseerde Karts

(EN) CAUTION: To Avoid Battery Leakage - Be sure to insert the batteries correctly and always follow the toy and battery manufacturers’ instructions. • Do not mix old and new batteries or alkaline, standard (carbon-zinc) or rechargeable (nickel-cadmium) batteries. Only batteries of the same or equivalent type recommended should be used. • Always remove weak or dead batteries from the product; do not short-circuit supply terminals. • Insert batteries with correct polarity (+/-) as shown. *(page 3)*

Important Tips: Alkaline batteries AAA (LR03) are recommended. • Rechargeable batteries are not recommended. • Remove rechargeable batteries from toy before charging; they must be charged only under adult supervision. • Non-rechargeable batteries must not be recharged. • Keep components free of dust; do not immerse or use in water. • Do not dispose of batteries in a fire; they could leak or explode and cause injury. • Remove all batteries if the toy will not be used for a long period of time.

 The wheellie bin indicates this product cannot be disposed of with household waste due to presence of hazardous substances. To protect human health and environment, check your local authority for recycling advice and facilities (2012/19/EU, Europe only).

CAUTION: Keep hands, face, hair and clothing away from all moving parts.

CAUTION: Rubber bands can cause injury from snap-back, breaking, or loss of control. While assembling models shown in instructions, hold rubber band tightly, and do not overstretch. Use rubber bands only as shown in these instructions. DO NOT USE FRAYED OR TORN RUBBER BANDS. **CAUTION:** Keep rubber bands away from face and eyes.

(FR) ATTENTION : Pour éviter que les piles ne fuient - Veillez à introduire les piles correctement et suivez toujours les instructions des fabricants du jouet et des piles. • Ne mélangez pas des piles usées et des piles neuves ou des piles alcalines, standard (carbone/zinc) ou rechargeables (cadmium-nickel). Il est important de n’utiliser que des piles du même type ou équivalent recommandé. • Retirez toujours les piles faibles ou mortes du produit ; ne faites pas court-circuiter les points d’échange. • Introduisez les piles en respectant la polarité (+/-) comme l’indique le schéma. *(page 3)*

Conseils Importants : Des piles alcalines AAA (LR03) sont recommandées. • Les piles rechargeables ne sont pas recommandées. • Retirez les piles rechargeables du jouet avant de les faire recharger ; elles ne doivent être rechargées que sous la surveillance d’un adulte. • Les piles qui ne sont pas rechargeables ne doivent pas être rechargées. • Gardez les éléments à l’abri de la poussière, ne les plongeaz pas dans l’eau, ne les utilisez pas dans l’eau. • Ne jetez pas les piles dans un feu ; elles risqueraient de fuir ou d’exploser et d’entraîner des blessures. • Retirez toutes les piles si le jouet ne doit pas être utilisé pendant une longue période.

 Le symbole “poubelle à roulettes” indique que ce produit ne peut pas être éliminé avec vos déchets ménagers en raison de la présence de substances dangereuses. Afin de protéger votre santé et l’environnement, renseignez-vous auprès de vos autorités locales afin d’obtenir des conseils sur le recyclage et la localisation des installations adaptées (2012/19/EU, Europe uniquement).

ATTENTION : Garder les mains, le visage, les cheveux et l’habillement à partir de toutes les pièces mobiles.

ATTENTION : Les élastiques peuvent causer des blessures en claquant, en se cassant ou quand on les manipule imprudemment. Tenez fermement l’élastique lors de l’assemblage du modèle en veillant à ne pas trop le tendre. N’utilisez les élastiques que selon les instructions. N’UTILISEZ PAS D’ÉLASTIQUES ÉRAILLÉS OU DÉCHIRÉS. **ATTENTION :** Tenez les élastiques en caoutchouc à l’écart du visage et des yeux.

(ES) PRECAUCIÓN: Para evitar pérdidas en las pilas - Asegúrese de que instala las pilas correctamente y de que siempre sigue las instrucciones del fabricante del juguete y del fabricante de las pilas. • No mezcle pilas viejas con nuevas, ni mezcle pilas alcalinas, estándar (de carbón – cinc) o recargables (de níquel – cadmio). Use sólo pilas del tipo recomendado o equivalentes a éstas. • Siempre retire las pilas muy gastadas o acabadas del producto y no permita que se formen cortocircuitos en los bornes. Inserte las pilas, asegurándose de que la polaridad sea la correcta (+/-), tal como se muestra. *(página 3)*

Importantes Consejos: Se recomiendan pilas alcalinas AAA (LR03). • No se recomiendan las pilas recargables. • Retire las pilas recargables del juguete antes de volverlas a cargar. Las pilas deben ser recargadas sólo bajo la supervisión de un adulto.

• Pilas no recargables no deben ser recargadas. • Mantenga todos los elementos libres de polvo, no los sumerja o use en agua. • No queme las pilas en un fuego, ya que pueden tener pérdidas o explotar, causando lesiones. • Retire todas las pilas del juguete si éste no va a ser usado vpor un largo período de tiempo.

 El contenedor de basura indica que este producto no puede desecharse con la basura doméstica debido a la presencia de sustancias peligrosas. Para proteger la salud humana y el medio ambiente consultar con la agencia local para el consejo y las facilidades de reciclaje (2012/19/EU, solo Europa).

PRECAUCIÓN: Guardar las manos, la cara, el pelo y la ropa lejos de todas las piezas móviles.

PRECAUCIÓN: Las gomas pueden causar daños si se sueltan con fuerza, se rompen o se pierde su control. Al construir los modelos que se muestran en las instrucciones, sujetar bien la goma y no estirarla demasiado. Las gomas deben usarse únicamente como se indica en las instrucciones. NO USAR GOMAS QUE ESTÉN DESGASTADAS NI ASGADAS. **PRECAUCIÓN:** Mantenga las gomas elásticas alejadas de la cara y los ojos.

(DE) VORSICHT: Vermeidung von auslaufenden Batterien - Achten Sie darauf, die Batterien richtig einzulegen. Beachten Sie grundsätzlich die Hinweise von Spielzeug- und Batteriehersteller. • Alte und neue Batterien sowie Alkali-, Standard- (Kohle-Zink) oder wiederaufladbare Batterien (Nickel-Cadmium) nicht miteinander mischen. Es sollten nur Batterien des empfohlenen oder diesem ähnlichen Typs verwendet werden. • Fast oder völlig leere Batterien grundsätzlich aus dem Produkt entfernen; die Anschlussklemmen nicht kurzschließen. • Beim Einlegen der Batterie auf richtige Polarität achten (+/-), wie in der Abbildung. *(seite 3)*

Wichtige Tipps: Wir empfehlen Alkalibatterien AAA (LR03). • Wiederaufladbare Batterien werden nicht empfohlen. • Wiederaufladbare Batterien vor dem Laden aus dem Spielzeug entfernen. Diese dürfen nur unter Aufsicht eines Erwachsenen aufgeladen werden. • Einwegbatterien dürfen nicht wieder aufgeladen werden. • Die einzelnen Teile von Schmutz und Staub fernhalten. Nicht in Wasser tauchen und nicht im Wasser verwenden. • Batterien nicht in offene Flammen werfen; sie könnten auslaufen oder explodieren und zu Verletzungen führen. • Falls das Spielzeug längere Zeit nicht benutzt wird, alle Batterien entfernen.

 Der Abfallbehälter zeigt an, dass dieses Produkt aufgrund von Gefahrstoffen nicht im normalen Hausmüll entsorgt werden kann. Zum Schutz von Gesundheit und Umwelt kontaktiere bitte deine lokale Behörden für Recyclingtipps und –einrichtungen (2012/19/EU, nur Europa).

VORSICHT: Hände, Gesicht, Haar und Kleidung weg von allen beweglichen Teilen halten.

VORSICHT: Gummibänder können Verletzungen hervorrufen, wenn sie reißen, zurückspringen oder wenn sie nicht vorsichtig gehandhabt werden. Halten Sie die Gummibänder während des Zusammenbaus der Modelle fest, ohne sie jedoch zu überdehnen. Verwenden Sie die Gummibänder gemäß den Anweisungen. VERWENDEN SIE NIEMALS AUSGEFRANSTE ODER ZERRISSENE GUMMIBÄNDER. **VORSICHT:** Halten Sie Gummibänder weg von Gesicht und Augen.

(IT) ATTENZIONE: Per evitare perdita dalle batteria - Accertarsi di inserire le batterie correttamente e di seguire sempre le istruzioni del produttore delle batterie e del giocattolo. • Non mettere insieme batterie nuove e vecchie o batteria alcaline, standard (zinco-carbonio) e ricaricabili (nichel-cadmio). Usare soltanto batterie dello stesso tipo o tipo equivalente, come raccomandato. • Togliere sempre le batterie quasi o completamente scariche dal prodotto, non mettere in corto circuito i terminali di alimentazione. • Inserire le batterie con la corretta polarità (+/-) come mostrato. *(pagina 3)*

Suggerimenti Importanti: Si consiglia di usare batterie alcaline AAA (LR03). • Si consiglia di non usare batterie ricaricabili. • Rimuovere le batterie ricaricabili dal giocattolo prima di caricarle: devono essere caricate soltanto sotto la supervisione di un adulto. • Le batterie non ricaricabili non devono essere ricaricate. • Mantenere i componenti privi di polvere, non immergerli e non usarli dentro l’acqua. • Non gettare le batterie nel fuoco in quanto potrebbero perdere o esplodere e causare lesioni. • Rimuovere tutte le batterie se il giocattolo non viene usato per un lungo periodo di tempo.

 Il bidone della spazzatura indica che questo prodotto non si puo buttare via con i rifiuti domestici a causa della presenza di sostanze pericolose. Per proteggere la salute umana e l’ambiente, devi controllare con la tua autorità locale per consigli e impianti di riciclaggio (2012/19/EU, solo in Europa).

ATTENZIONE: Mantenere le mani, il viso, i capelli ed i vestiti a partire da tutti i pezzi mobili.

ATTENZIONE: Elastici può causare lesioni da snap-back, rottura, o perdita di controllo. Durante il montaggio dei modelli indicati nelle istruzioni, tenere ben elastico, e non tirare troppo. Utilizzare Elastici solo come indicato in queste istruzioni. NON USARE SFILACCIATI O STRAPPATI ELASTICI. **ATTENZIONE:** Mantenga gli elastici a partire dal fronte e dagli occhi.

(PT) CUIDADO: Como evitar fugas das pilhas - Certifiquem-se de que introduzem as pilhas correctamente seguindo sempre as instruções do fabricante do brinquedo e das pilhas. • Nunca combinem pilhas usadas com pilhas novas ou pilhas alcalinas, padrão (carvão-zinco) ou pilhas recarregáveis (níquel-cádmio). Devem ser utilizadas apenas pilhas do mesmo tipo ou de tipo equivalente recomendado. • Retirem sempre as baterias fracas ou esgotadas do produto; não provoquem um curto-circuito nos terminais de alimentação. • As pilhas devem ser introduzidas com a polaridade correcta (+/-), conforme mostrado. *(página 3)*

Sugestões Importantes: Recomendamos o uso de pilhas alcalinas AAA (LR03). • Não recomendamos o uso de pilhas recarregáveis. • Devem retirar as pilhas recarregáveis do brinquedo antes de procederem à respectiva recarga; estas pilhas devem ser recarregadas apenas sob supervisão de adultos. • Não se deve tentar carregar pilhas não recarregáveis. • Os componentes devem ser mantidos sem pó; não se devem mergulhar nem usar com água. • Não eliminem as pilhas no fogo; estas podem ter fugas ou explodir, causando lesões. • Retirem todas as pilhas do brinquedo se este não for usado durante um longo período de tempo.

 O caixote do lixo indica que este produto não pode ser descartado junto com o lixo doméstico devido à presença de substâncias perigosas. Para proteger a saúde humana e o meio ambiente verifique a sua autoridade local para reciclagem conselho e instalações (2012/19/EU, somente na Europa).

CUIDADO: Manter as mãos, a cara, o cabelo e a roupa longe de todas as peças moventes.

CUIDADO: As borrachas poderão causar ferimentos ao serem esticadas, ao quebrarem ou ao perderem controlo. Ao montar os modelos mostrados nas instruções, segure bem a borracha e não a estique demasiado. Utilize as borrachas apenas da forma exemplificada nestas instruções. NÃO UTILIZE BORRACHAS CORROÍDAS OU QUEBRADAS. **CUIDADO:** Mantenha as faixas de borracha longe da cara e dos olhos.

(NL) OPGEPAST: Om batterijlekkage te verhinderen - Verzeker je ervan de batterijen correct aan te brengen en volg steeds de instructies van de speelgoed- en batterijenfabrikant. • Meng geen oude en nieuwe batterijen of alkaline, gewone (koolstof-zink) of heroplaadbare (nikkel-cadmium) batterijen. Slechts batterijen van hetzelfde aanbevolen type of een equivalent type dienen gebruikt te worden. • Verwijder altijd zwakke of uitgeputte batterijen uit het product; de toevoeraansluitklemmen niet kortsluiten. • Steek de batterijen erin met de correcte polariteit (+/-) zoals afgebeeld. *(bladzijde 3)*

Belangrijke Tips: Alkalische AAA (LR03) batterijen worden aanbevolen. • Heroplaadbare batterijen worden niet aanbevolen. • Verwijder de heroplaadbare batterijen uit het speelgoed alvorens op te laden; ze moeten uitsluitend worden opgeladen onder toezicht van een volwassene. • Niet-heroplaadbare batterijen mogen niet heropgeladen worden. • Hou de bestanddelen vrij van stof; dompel ze niet of gebruik ze niet in water. • Werp de batterijen niet weg in het vuur; ze zouden kunnen lekken of ontploffen en verwondingen veroorzaken. • Verwijder alle batterijen indien het speelgoed gedurende een lange periode niet zal gebruikt worden.

 Het pictogram van een verrijdbare vuilnisbak geeft weer dat dit product niet samen met het gewone huis-, tuin- en keukenafval mag worden weggegooid, omdat het gevaarlijke substanties bevat. Bescherm gezondheid en milieu en vraag advies aan de plaatselijke afvalverwerking-dienst over hoe en waar u producten kunt recyclen (2012/19/EU, alleen Europa).

OPGEPAST: Houd handen, gezicht, haar en kleding vanaf alle bewegende delen.

OPGEPAST: Gummibånd kan forårsage personskade, hvis de springer tilbage, går i stykker eller springer af. Når modellerne samles efter instruktionerne, skal man holde gummibåndene stramme, men ikke strække dem for meget. Gummibåndene må kun bruges, som anviset. BRUG ALDRIG SLIDTE ELLER BESKADIGEDE GUMMIBÅND. **OPGEPAST:** Houd elastiekjes vanaf gezicht en ogen.

⚠ WARNING: CHOKING HAZARD – Small parts. Not for children under 3 years.
ATTENTION : RISQUE D'ÉTOUFFEMENT – Pièces de petite taille. Ne convient pas aux enfants de moins de 3 ans.

ADVERTENCIA: PELIGRO DE ASFIXIA – Piezas pequeñas. No para niños menores de 3 años.

ACHTUNG: ERSTICKUNGSGEFAHR – Kleinteile. Nicht geeignet für Kinder unter 3 Jahren.

AVVISO: PERICOLO DI SOFFOCARE – Pezzi piccoli parti. Non adatto per bambini sotto di 3 anni.

AVISO: PERIGO DE SUFOCAÇÃO – Peças pequenas. Não se destina a crianças com menos de 3 anos de idade.

WAARSCHUWING: VERSTIKKINGSGEVAAR – Kleine onderdelen. Niet geschikt voor kinderen jonger dan 3 jaar.

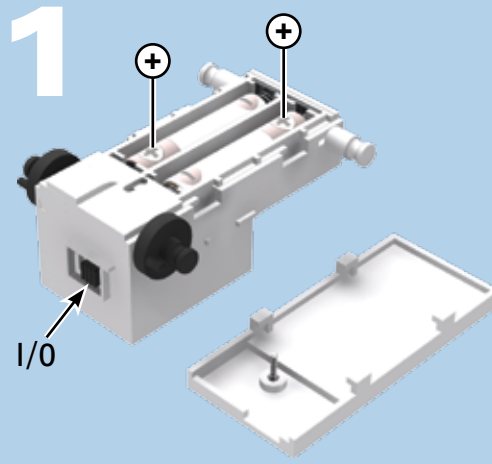

(EN) Apply stickers (D, E, F)
(FR) Apposez des autocollants (D, E, F)
(ES) Aplicar pegatinas (D, E, F)
(DE) Bringe die Aufkleber an (D, E, F)
(IT) Applicare gli adesivi (D, E, F)
(PT) Aplicar adesivos (D, E, F)
(NL) Stickers plakken (D, E, F)

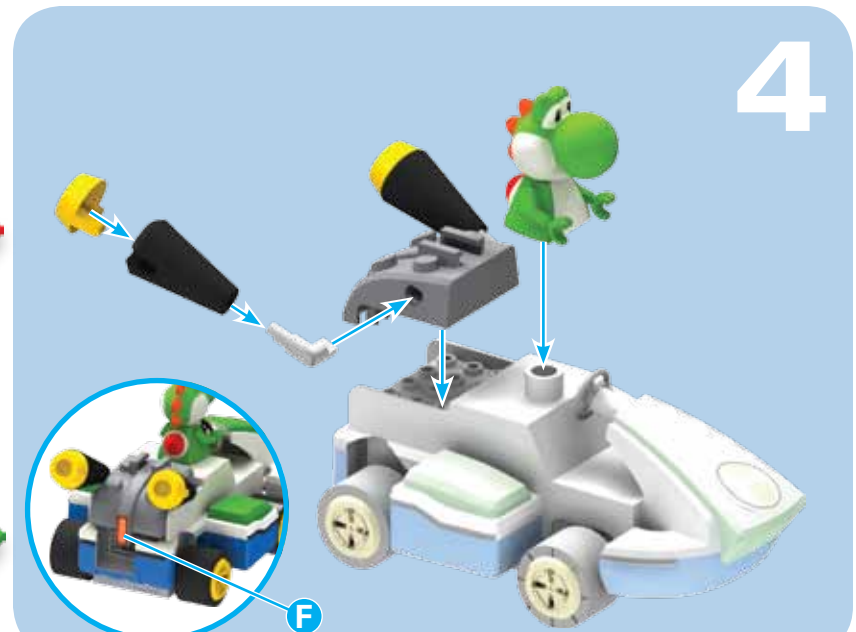
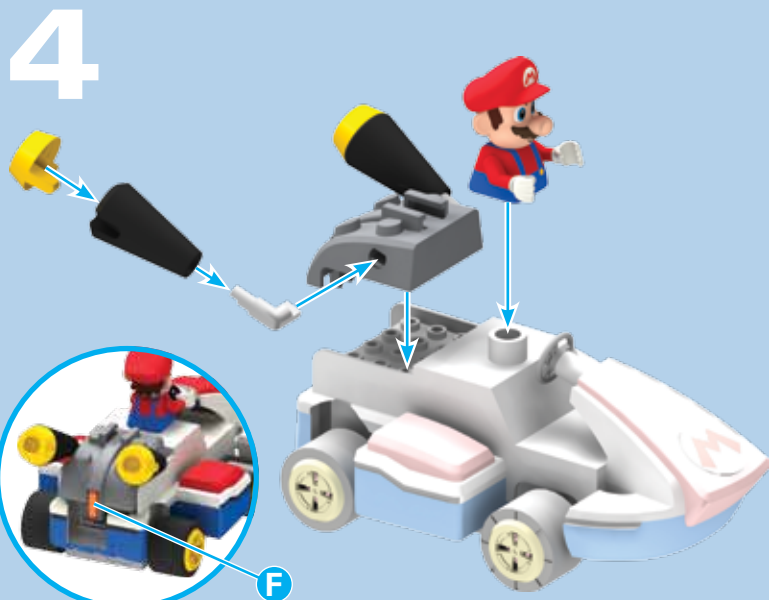
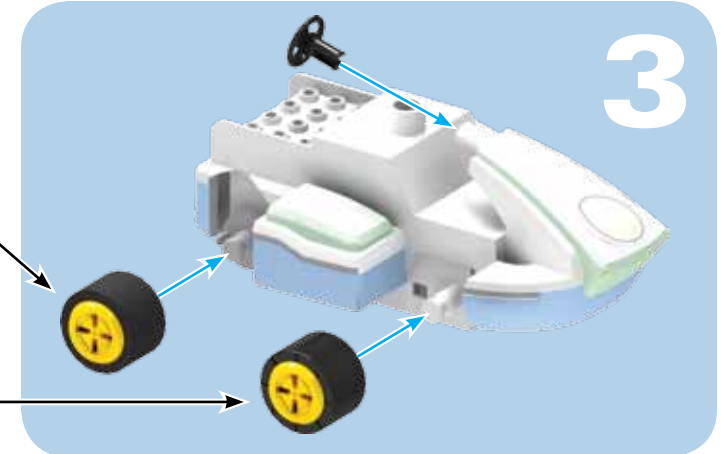
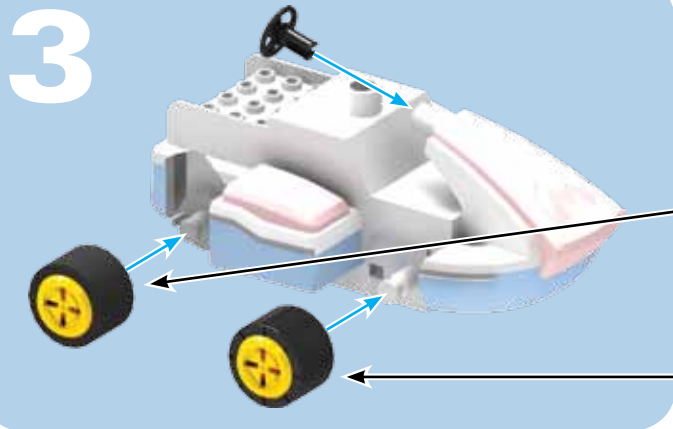
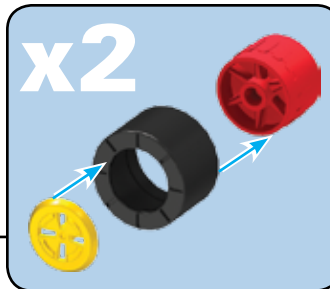
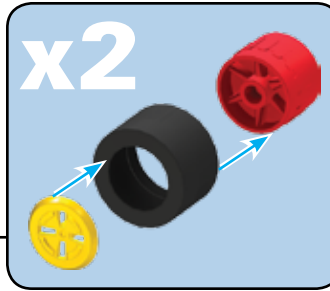
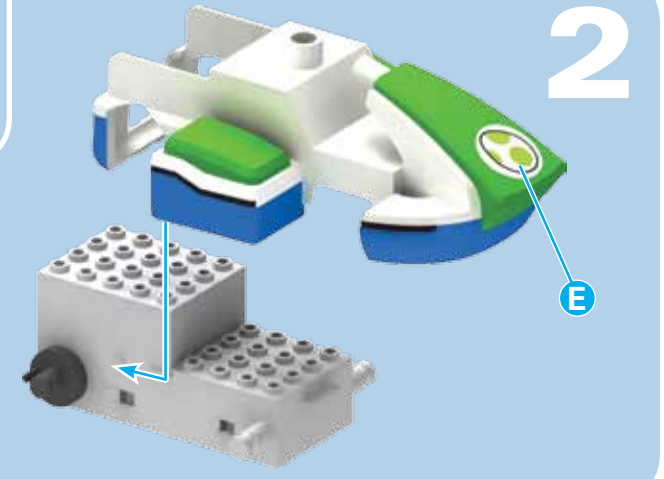
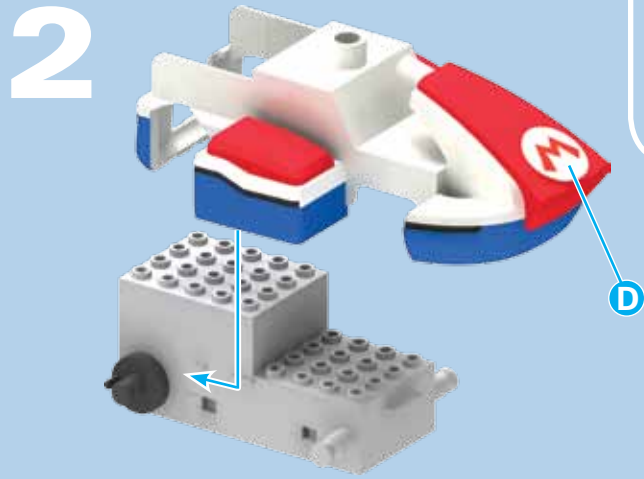

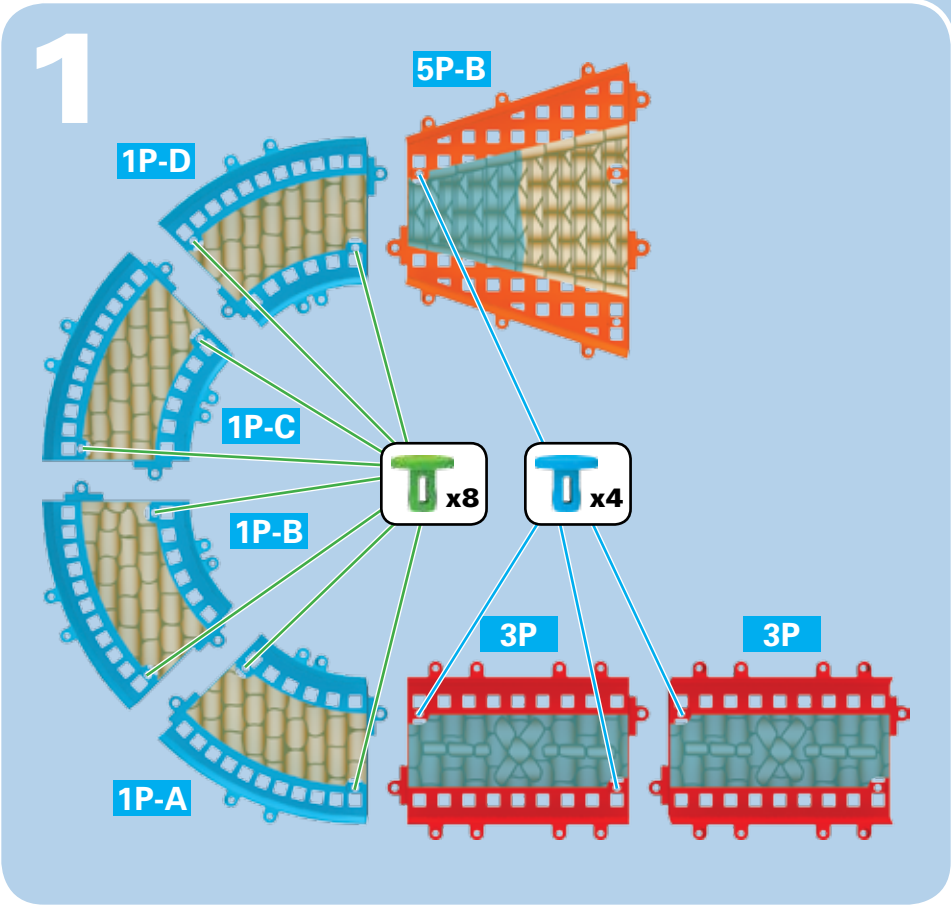
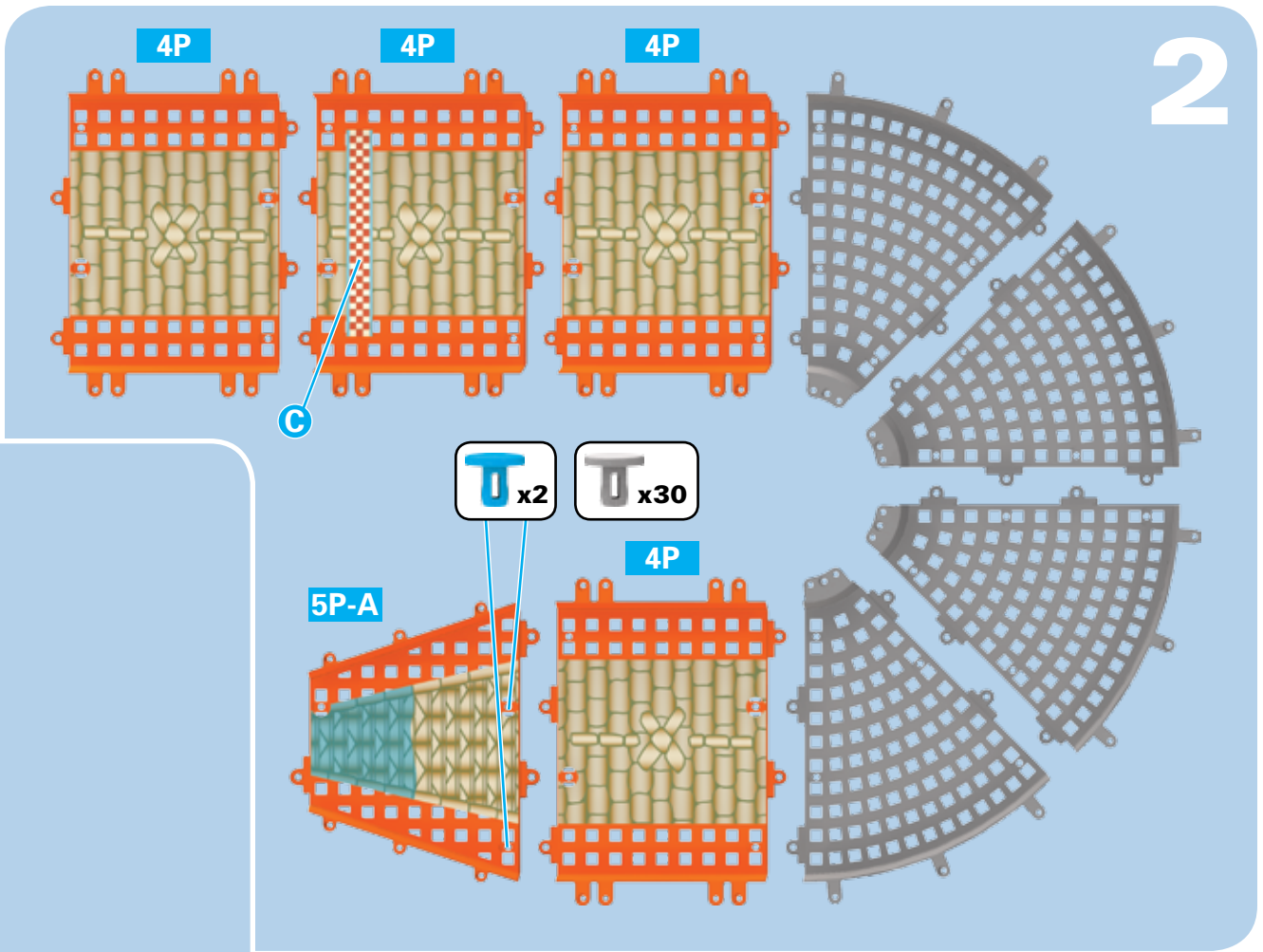
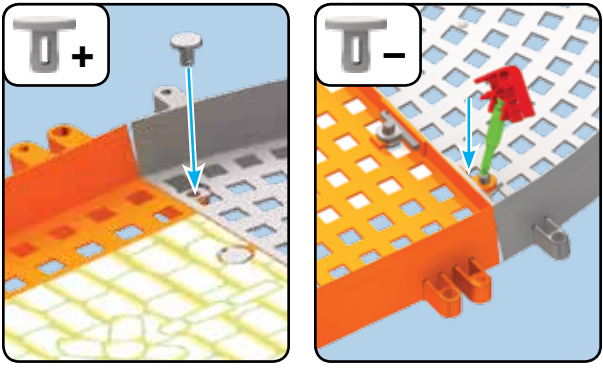

- (EN) Apply stickers
- (FR) Appelez des autocollants
- (ES) Aplicar pegatinas
- (DE) Bringe die Aufkleber an
- (IT) Applicare gli adesivi
- (PT) Aplicar adesivos
- (NL) Stickers plakken

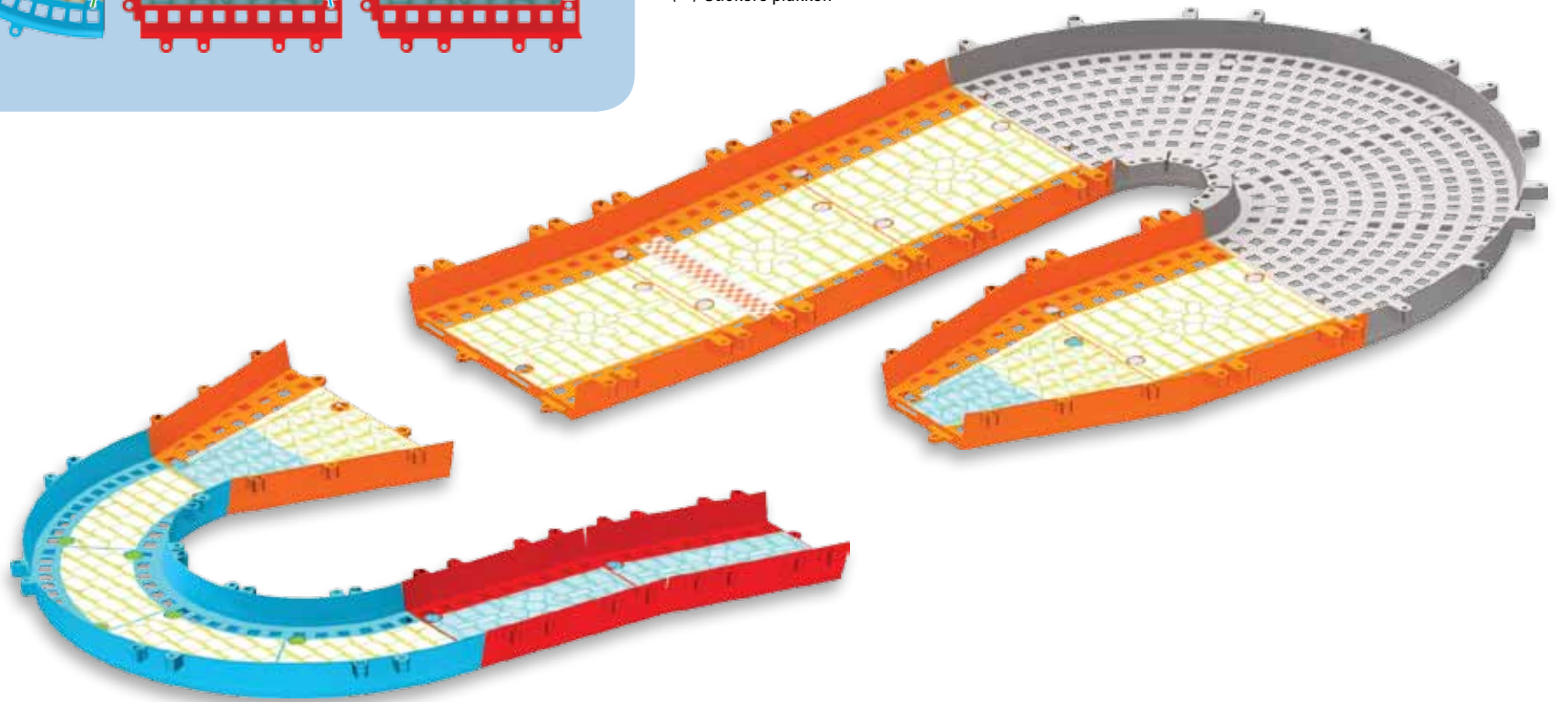

1

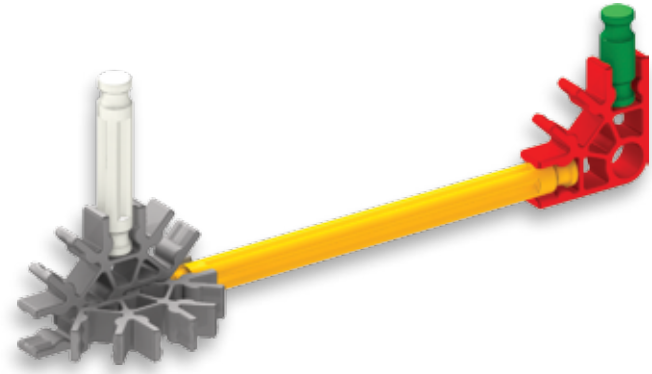
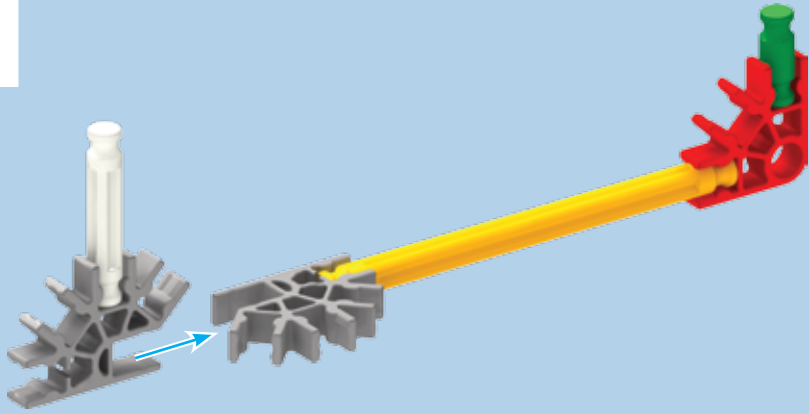

2

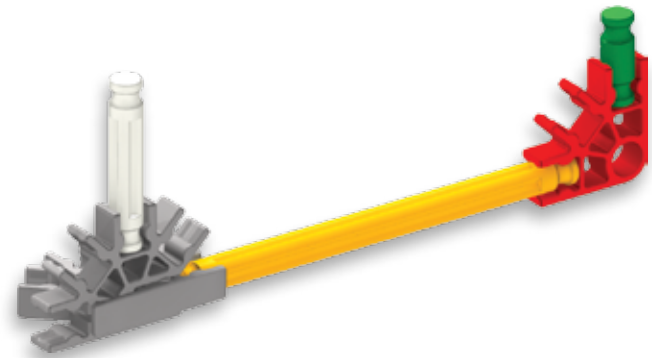
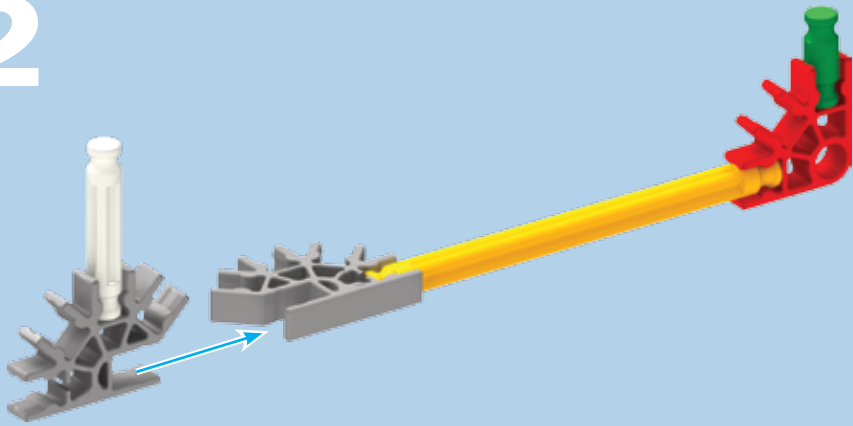

3



4

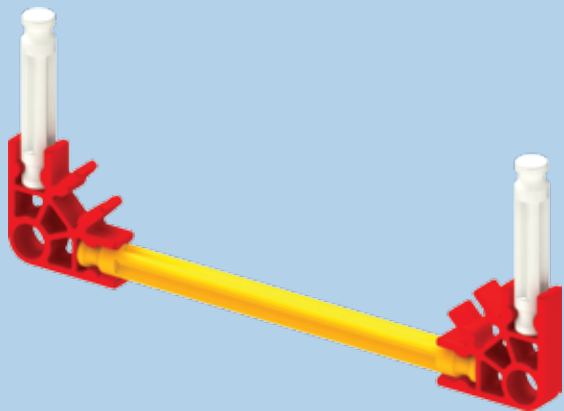

x2

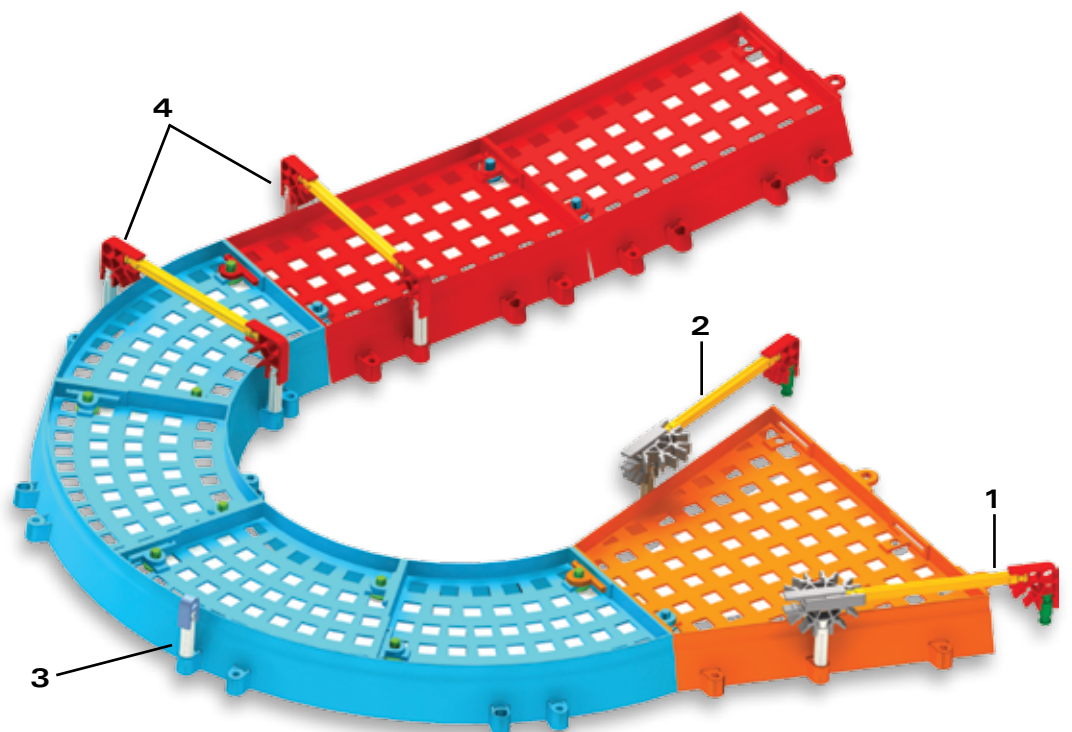

1



x2

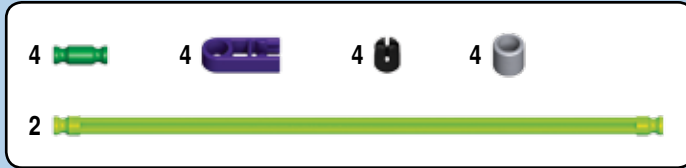

2

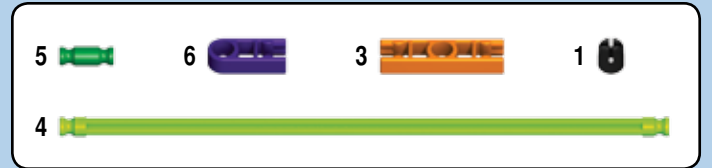

3

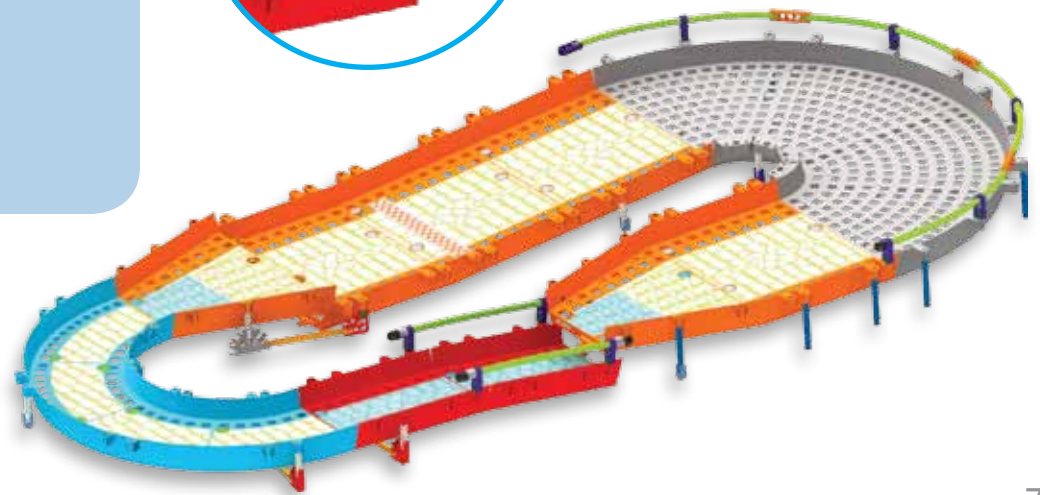
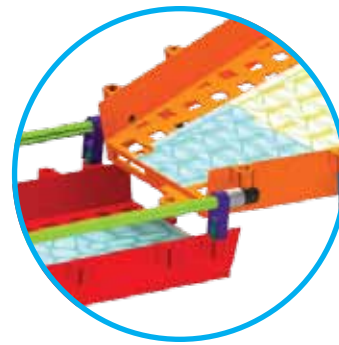
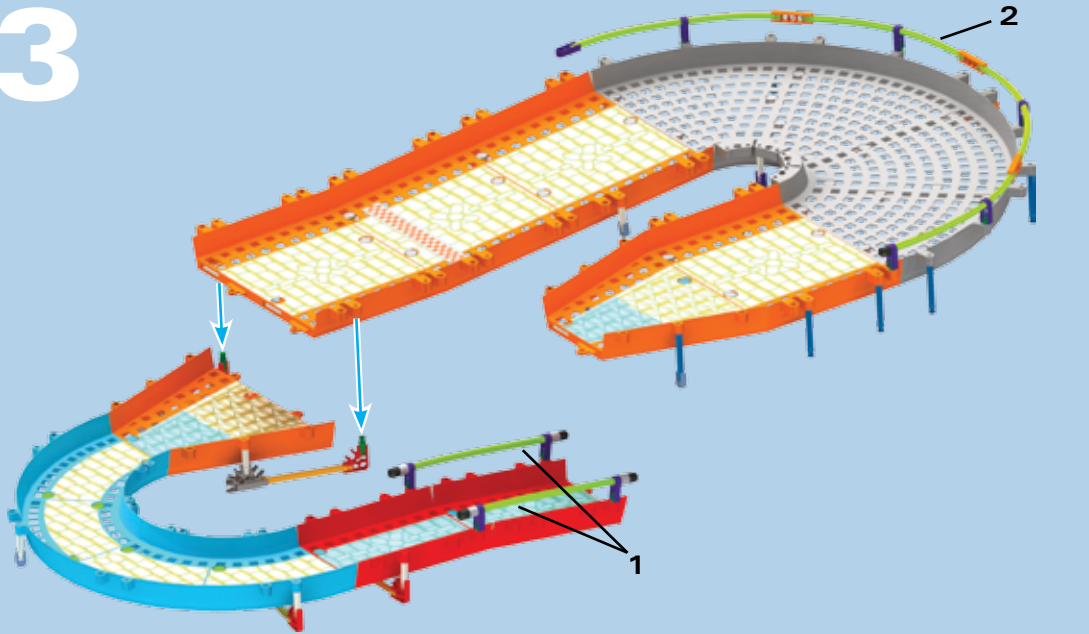

4



A A

5

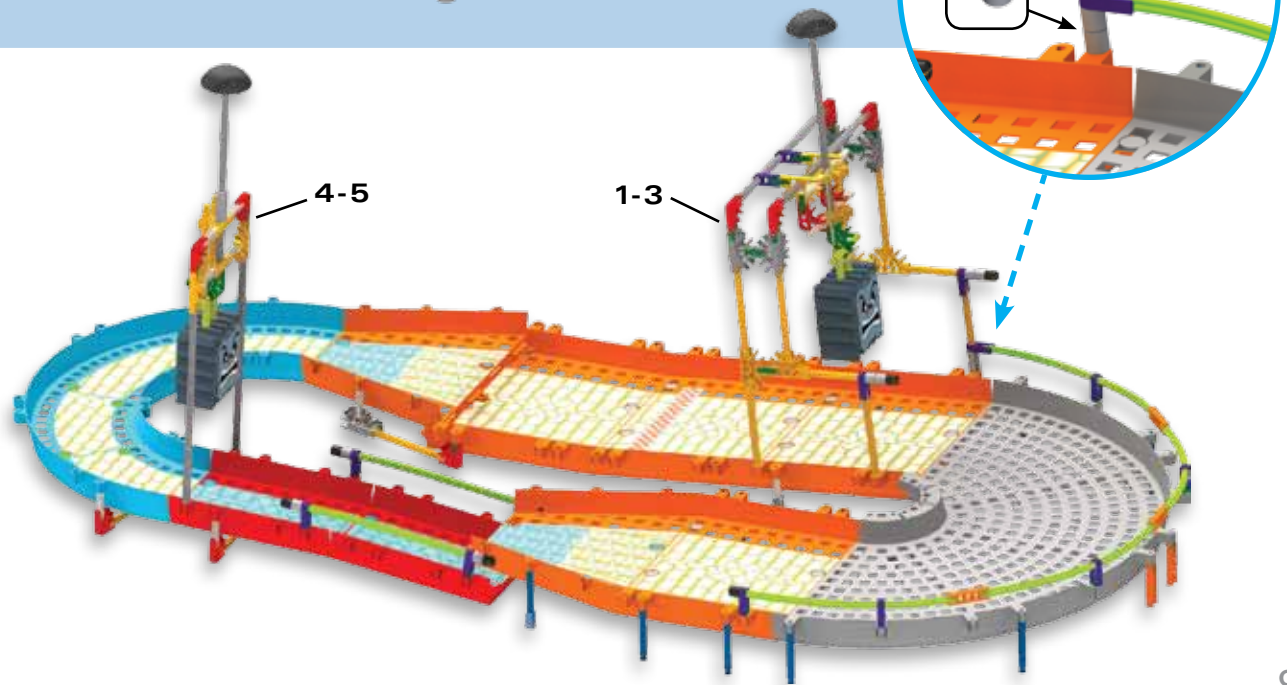
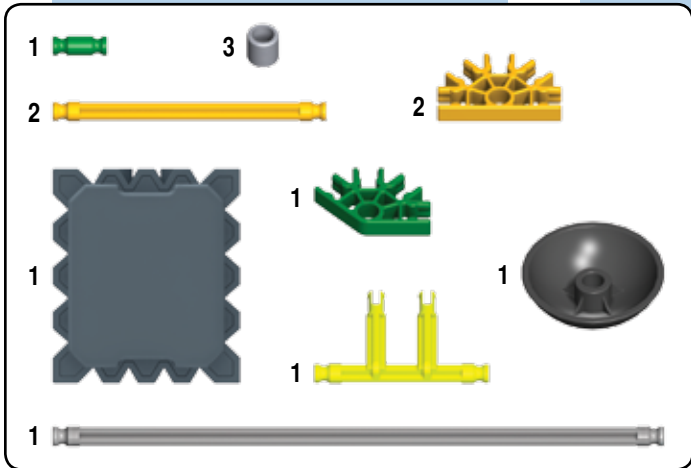
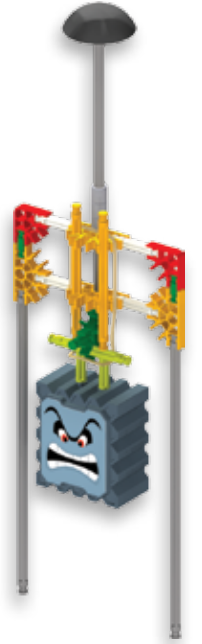
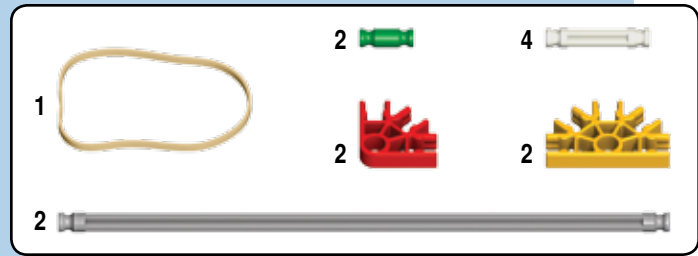
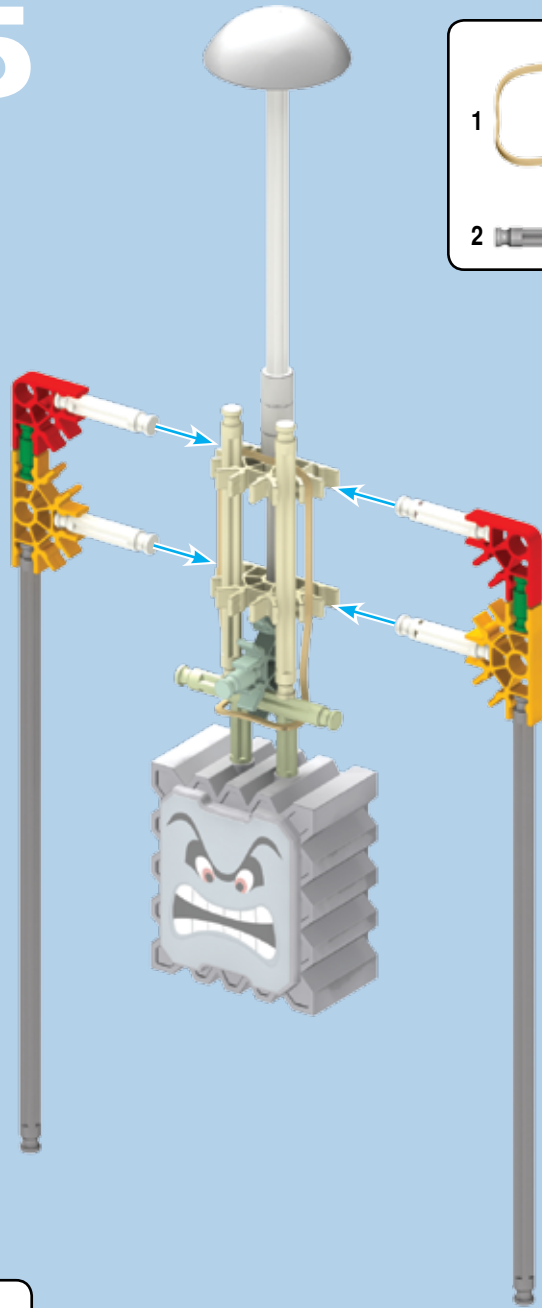

1

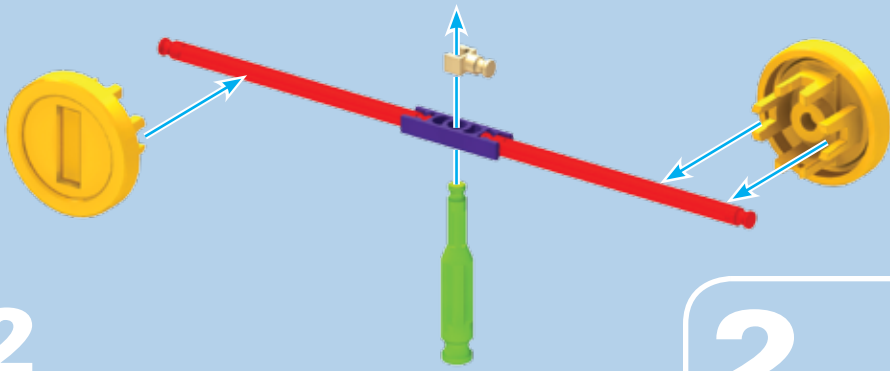

x2

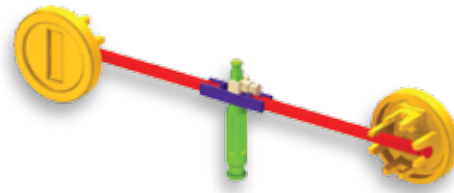

2

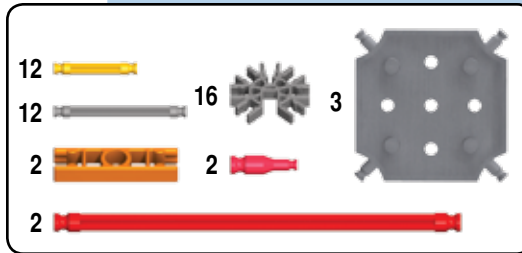
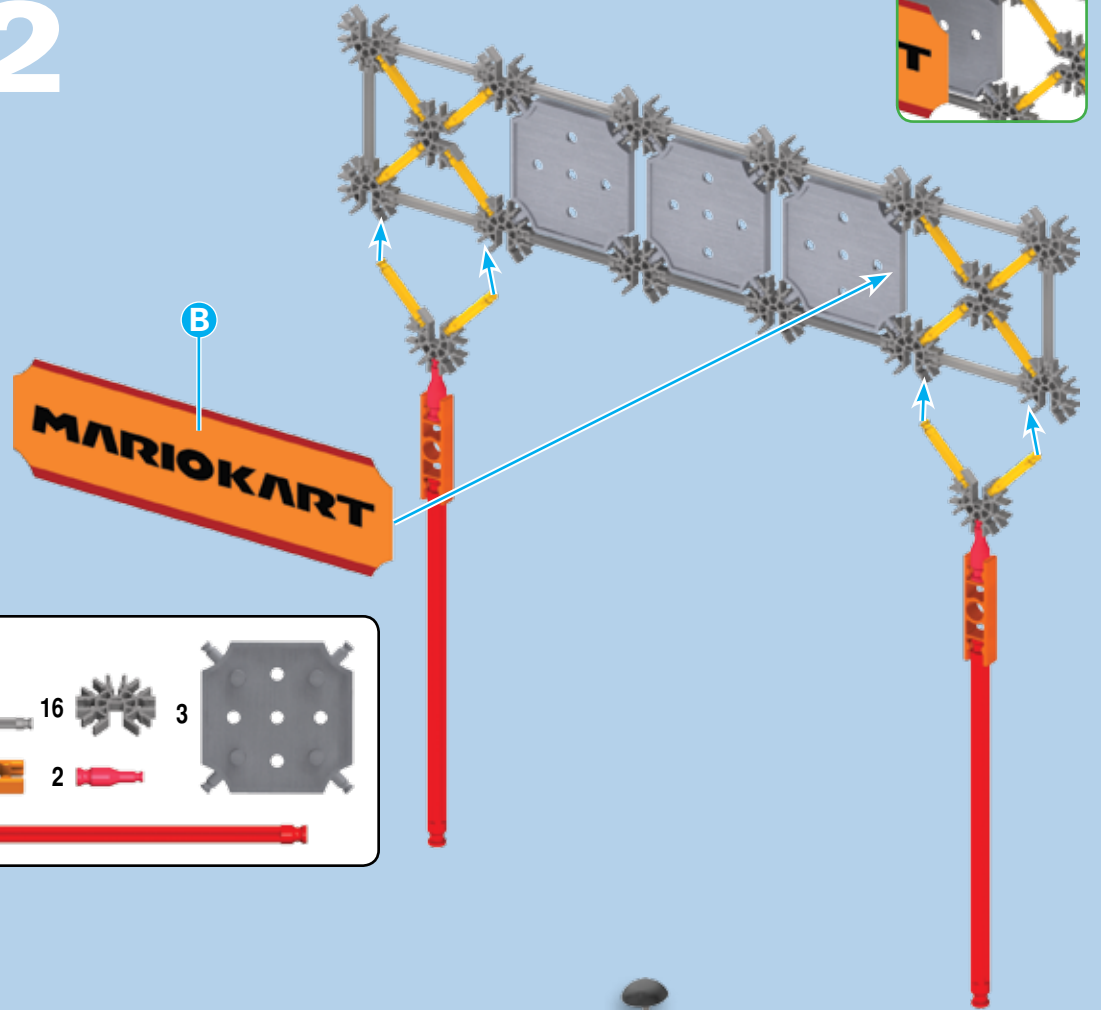

3

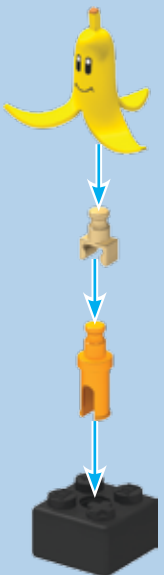

4

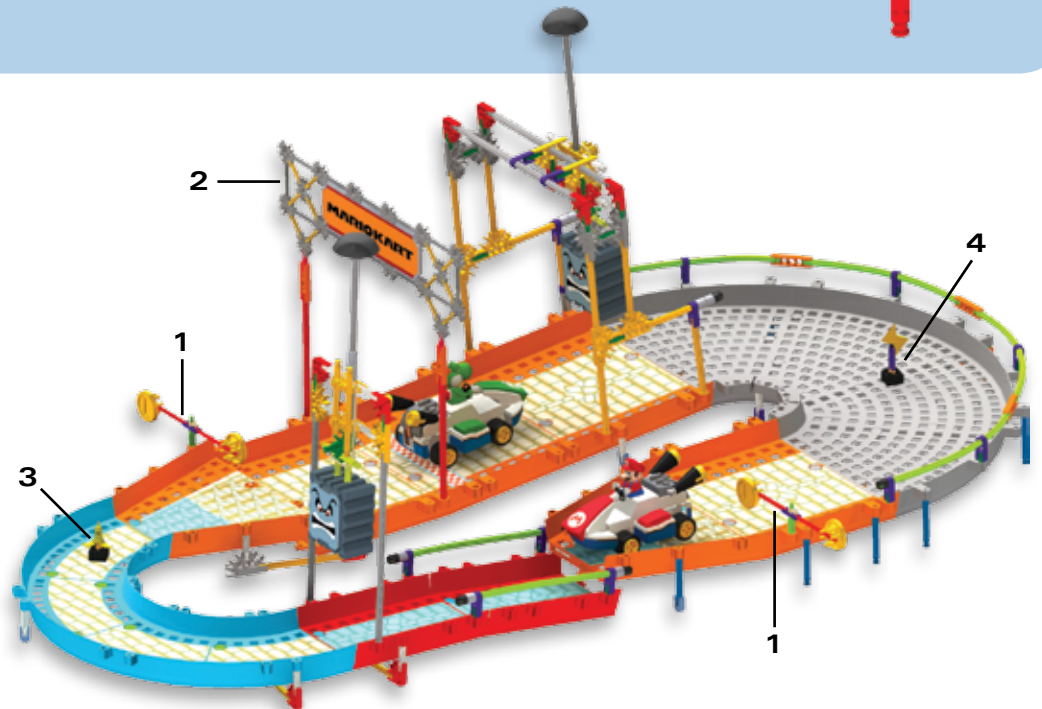

- (EN) **Parts List**
 (FR) **Liste des Pièces**
 (ES) **Lista de piezas**
 (DE) **Teileliste**
 (IT) **Elenco delle parti**
 (PT) **Lista das peças**
 (NL) **Lijst met onderdelen**

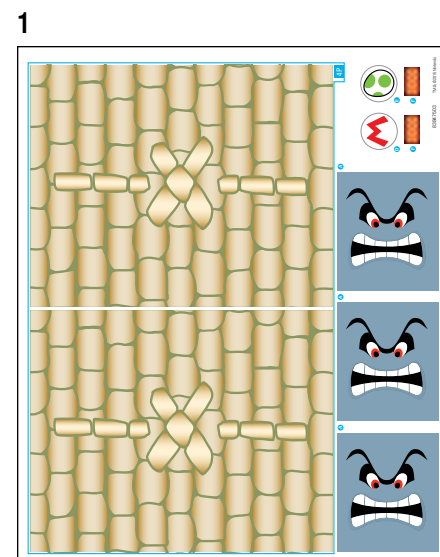
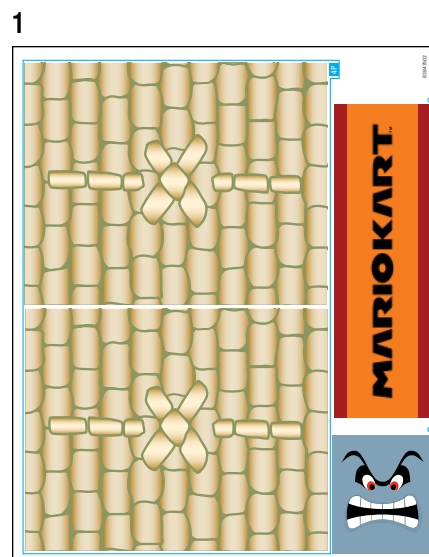
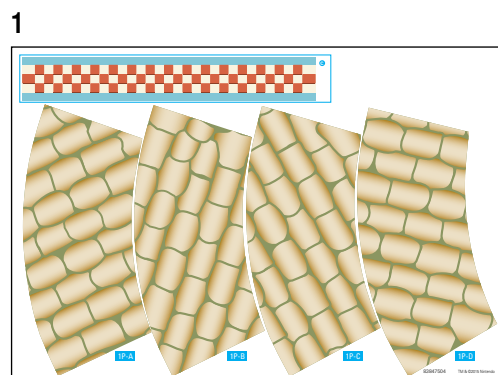
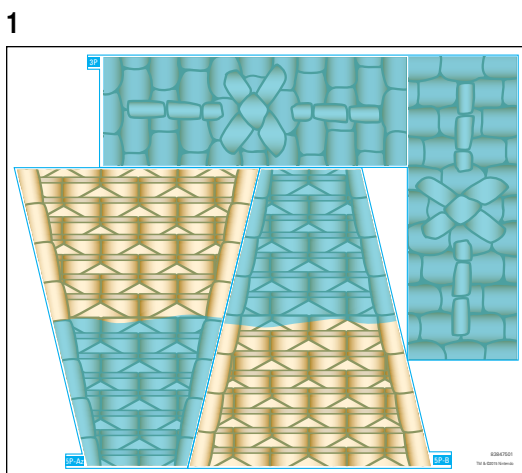
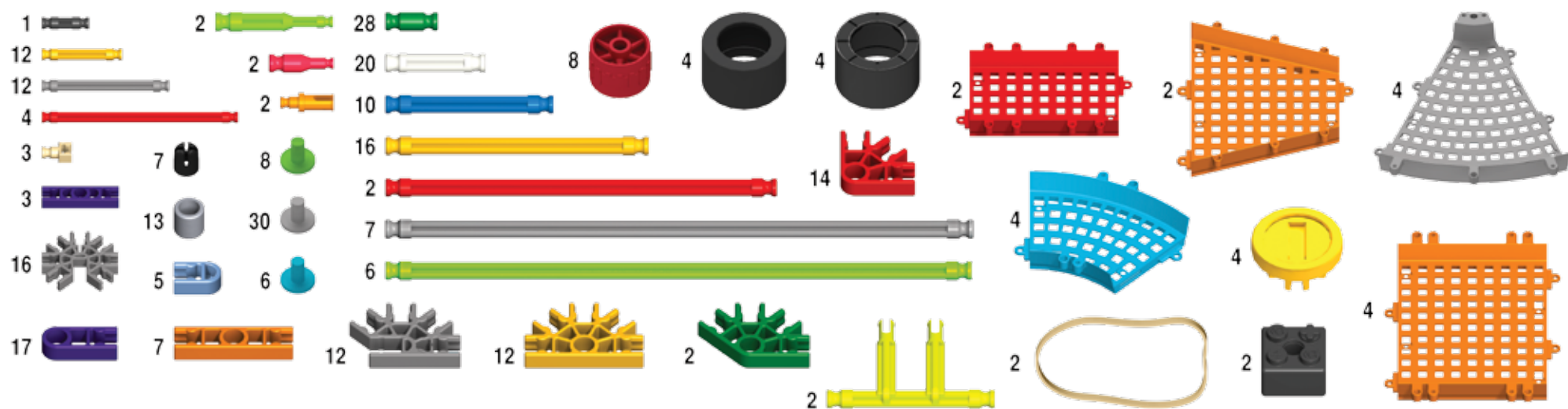
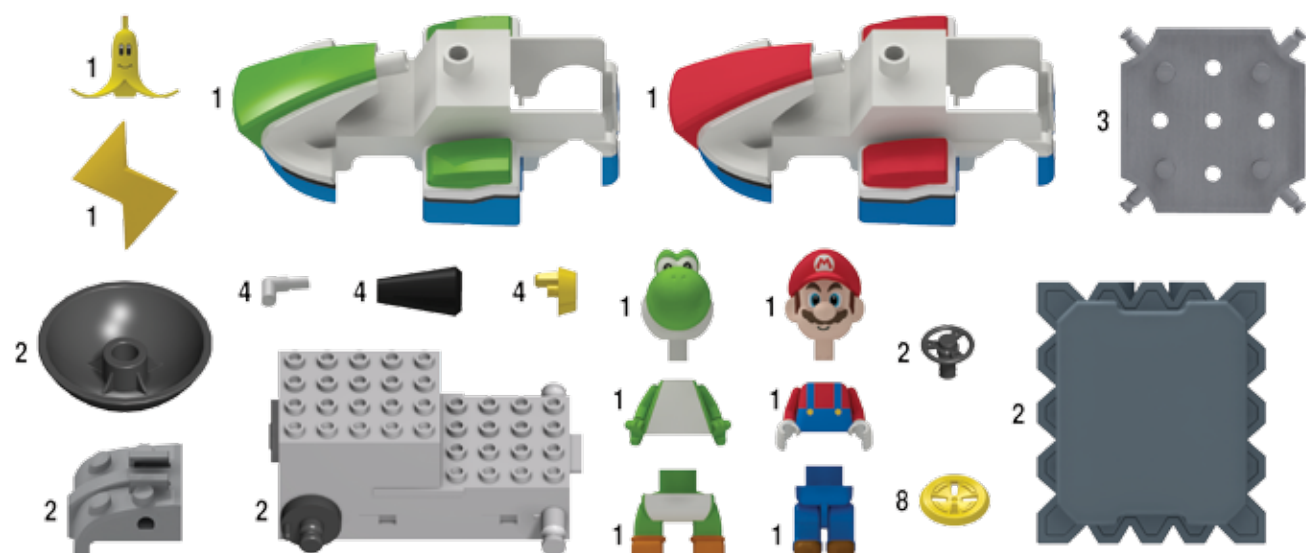

MARIOKART

THWOMP RUINS BUILDING SET JEU DE CONSTRUCTION

 facebook.com/knex

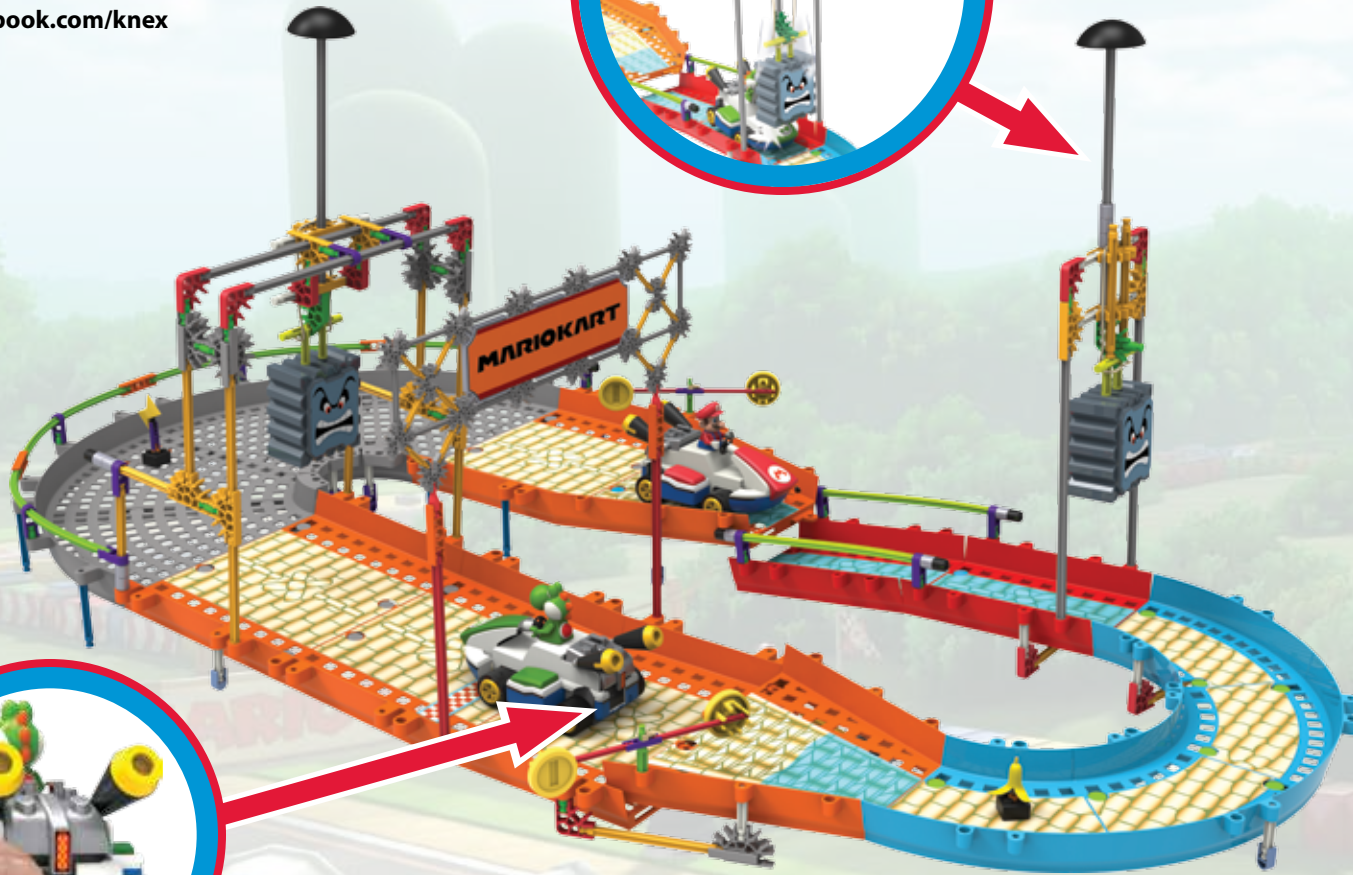
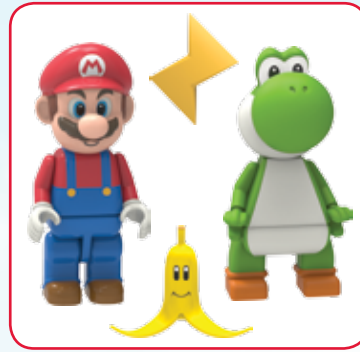

TM & © 2015 Nintendo.

KNEX.COM



Sold separately
Vendus séparément
Se venden por separado
Separat erhältlich
Venduti separatamente
Vendidos separadamente
Afzonderlijk verkrijgbaar

©2015 K'NEX Limited Partnership Group, P.O. Box 700, Hatfield, PA 19440-0700; 1-800-KID-KNEX (USA/Canada/États-Unis/EE.UU.); email@knex.com; knex.com.
K'NEX UK Ltd., P.O. Box 3083, Reading RG1 9YQ, England. For customers outside the USA/Canada please contact your local distributor at www.knex.com/distributors
(FR) Pour les clients en dehors du Canada et des États-Unis, veuillez contacter votre distributeur local que vous pouvez trouver sur www.knex.com/distributors
(ES) El cliente que no vive en EE.UU./Canadá se pone en contacto con el distribuidor local. Encuentre la información para el distribuidor local en www.knex.com/distributors

(EN) K'NEX and Building Worlds Kids Love are registered trademarks of K'NEX Limited Partnership Group.

(FR) K'NEX et Building Worlds Kids Love sont des marques déposées de K'NEX Limited Partnership Group.

(ES) K'NEX y Building Worlds Kids Love son marcas registradas de K'NEX Limited Partnership Group.

- Identifies Genuine K'NEX Bricks.
- Identifie que ce sont d'authentiques briques K'NEX.
- Identifica los ladrillos genuinos de K'NEX.
- Identifiziert echte K'NEX-Bausteine.
- Edentifica i veri blocchi K'NEX.
- Identifica que são cubos genuinos da K'NEX.
- Identificeert K'NEX bakstenen voor.



(EN) Product & colors may vary.
(FR) Le produit et ses couleurs peuvent varier.
(ES) El producto y los colores pueden variar.
(DE) Produkte und Farben können abweichen.
(IT) Prodotti e colori possono differire.
(PT) O produto e as cores podem variar.
(NL) Product en kleuren kunnen variëren.

13847501-V1-06/15

