

43753 Alternate Build



exercise bike

Invention: Exercise Bike



1

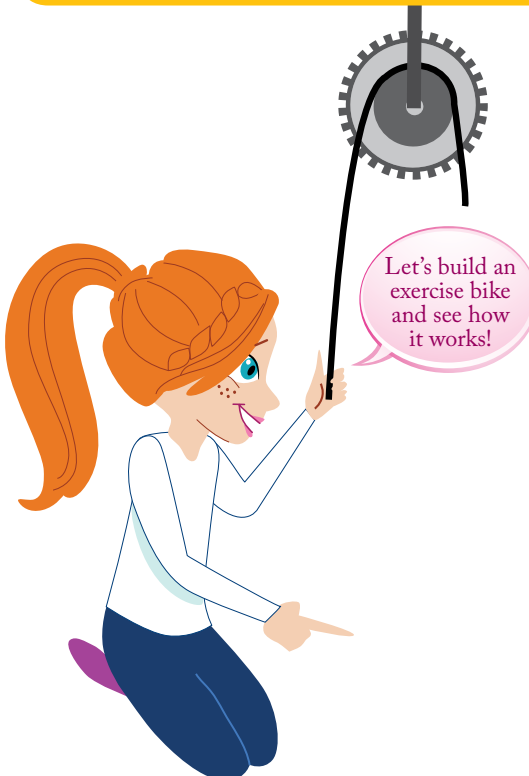
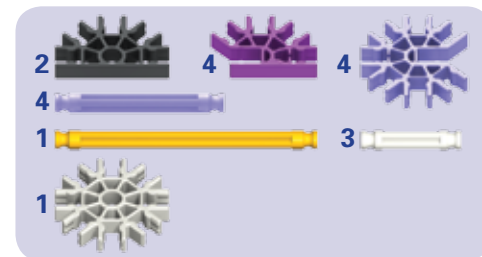
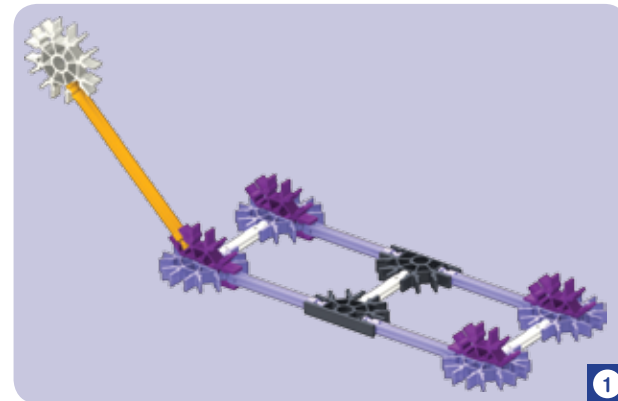
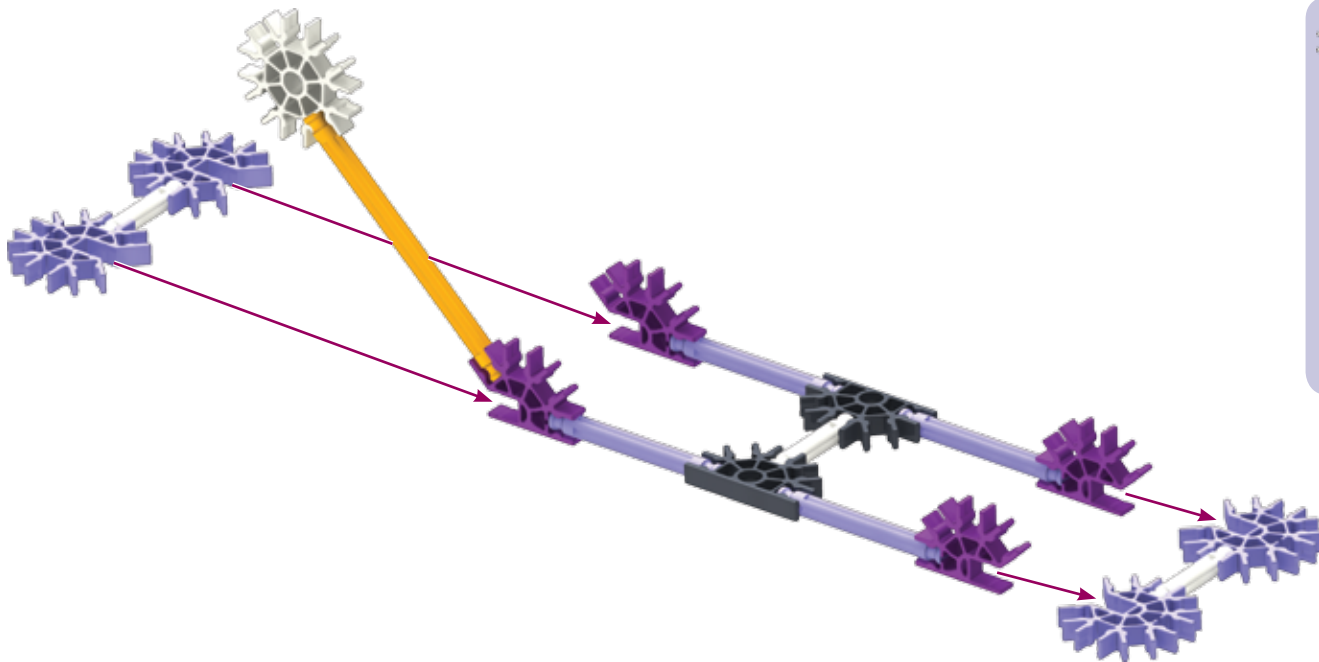

2

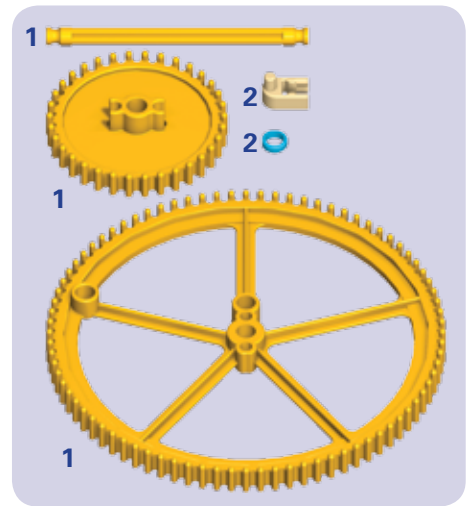
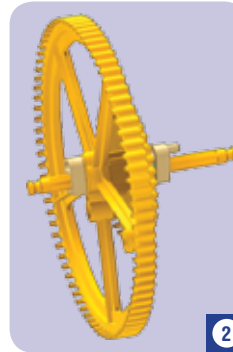
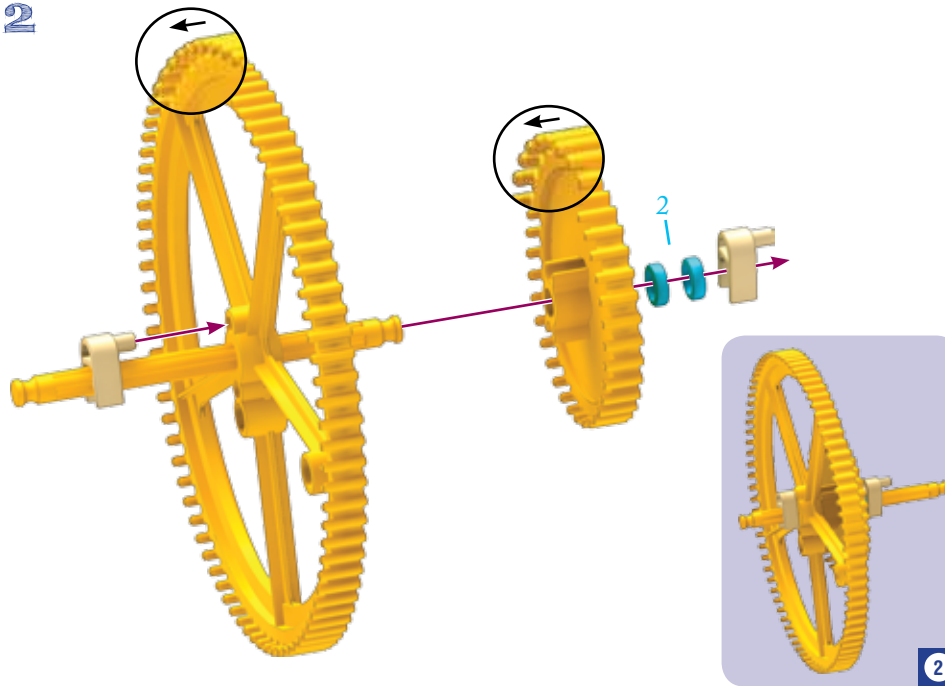

3

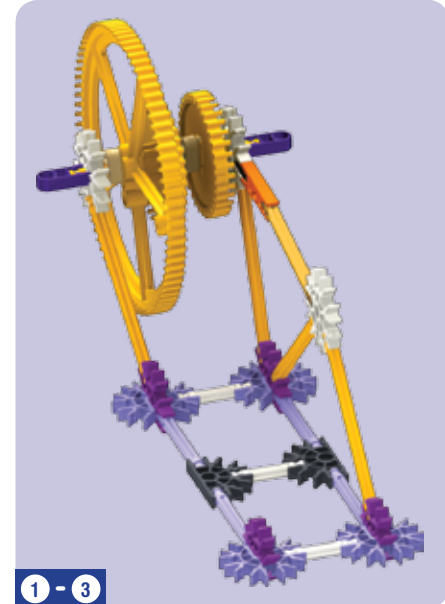
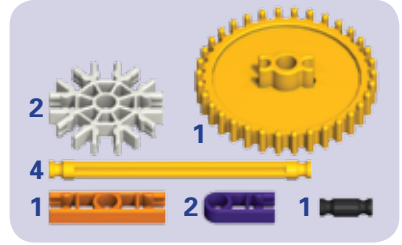
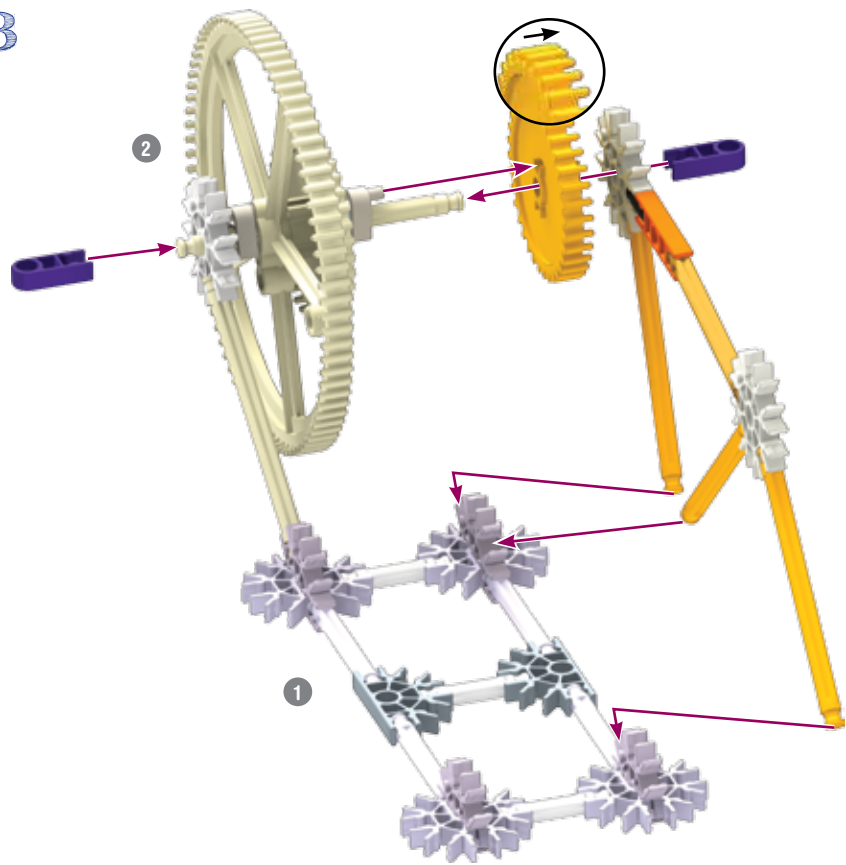

4

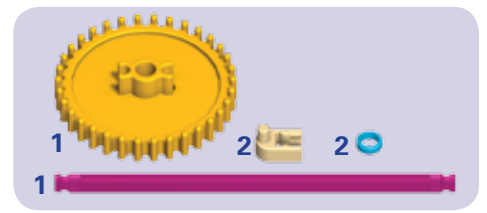
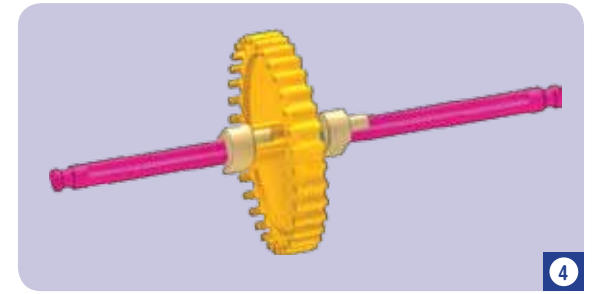
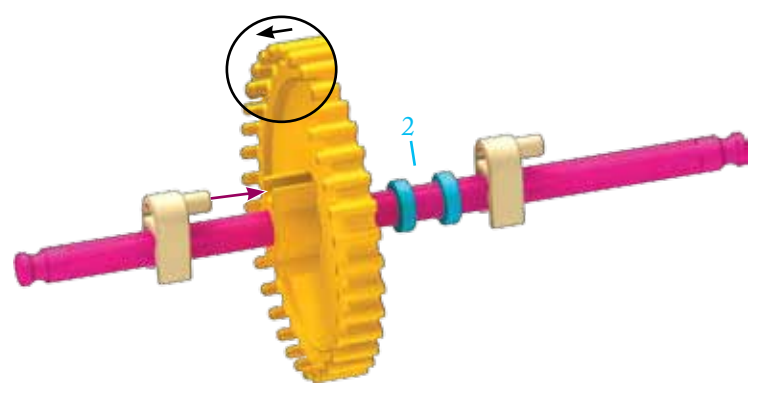

6

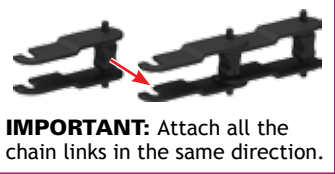

7

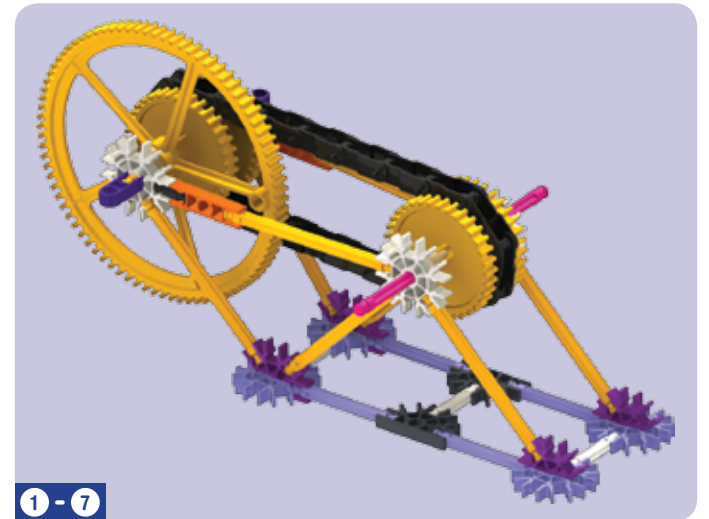
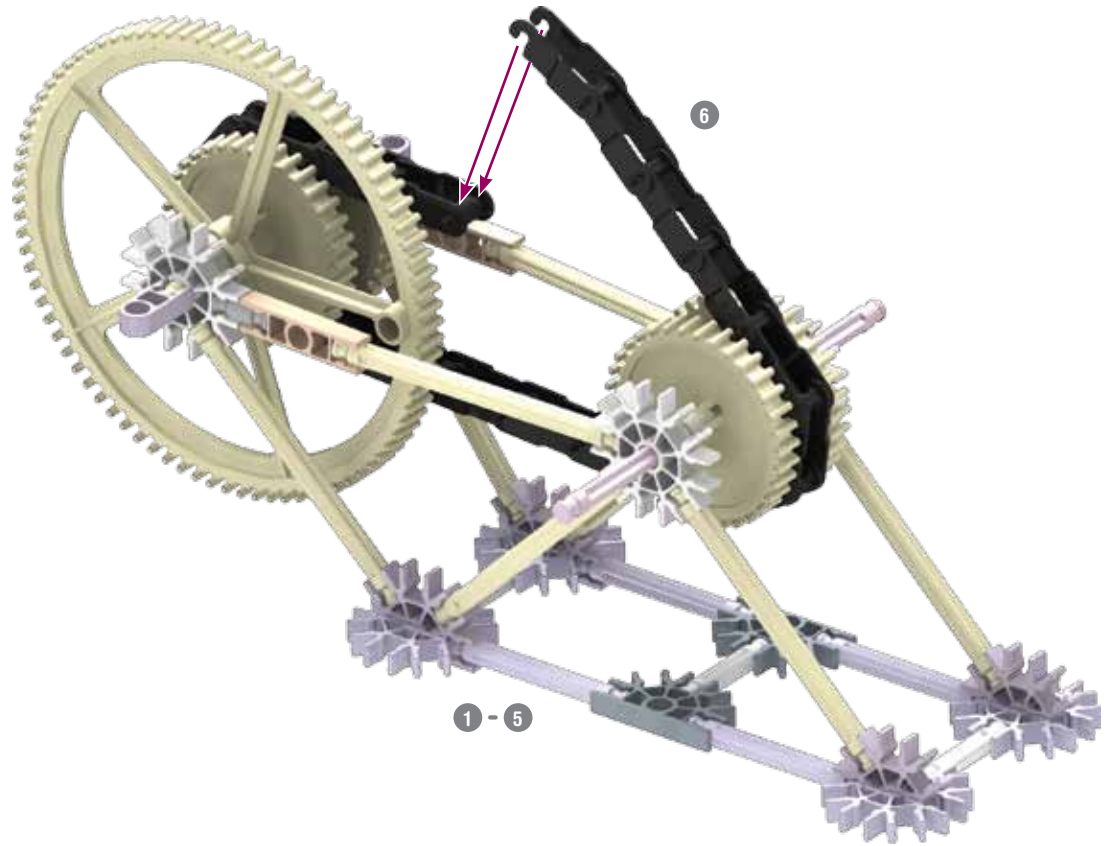

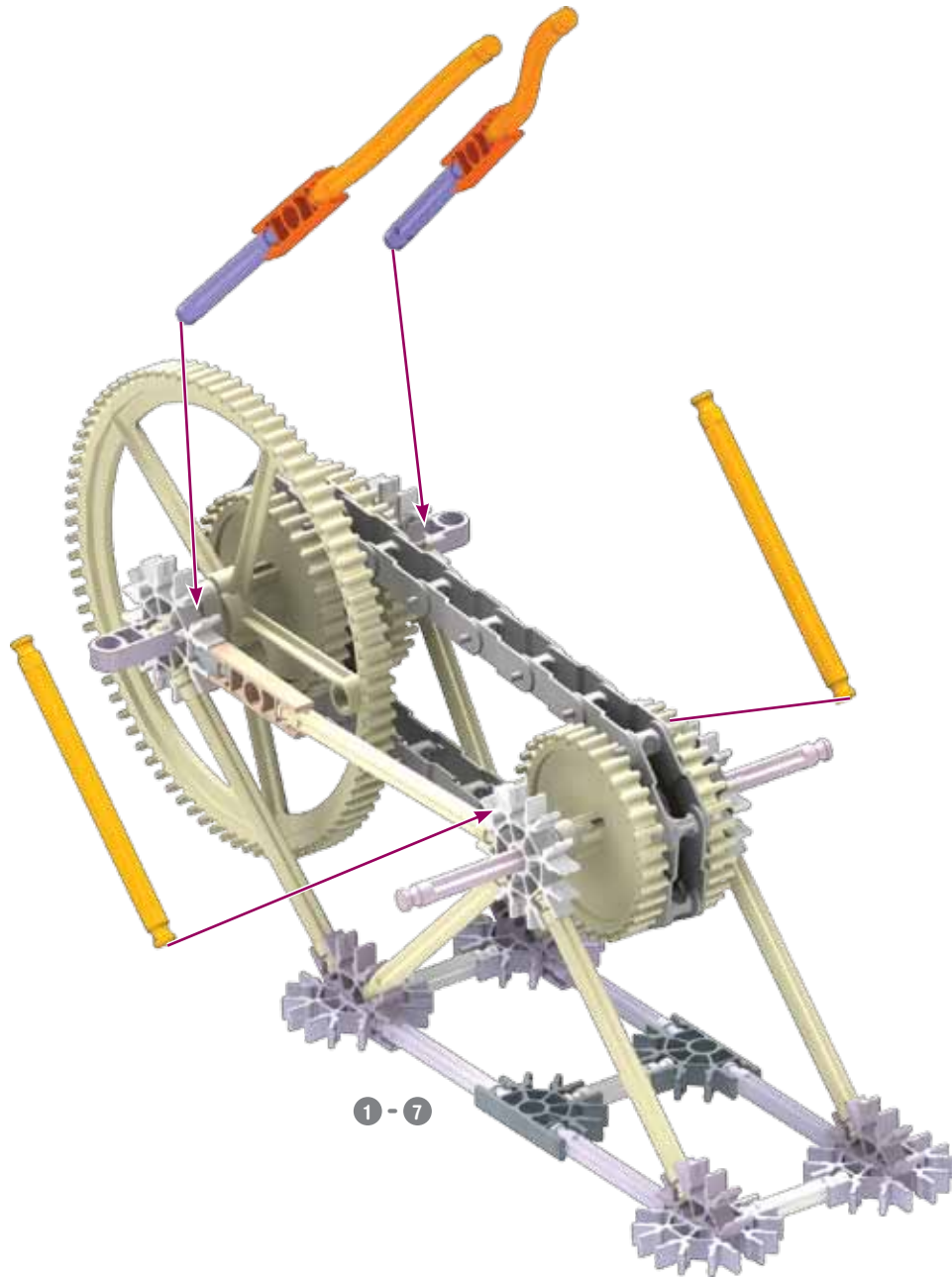

- 2
- 2
- 2
- 2

9

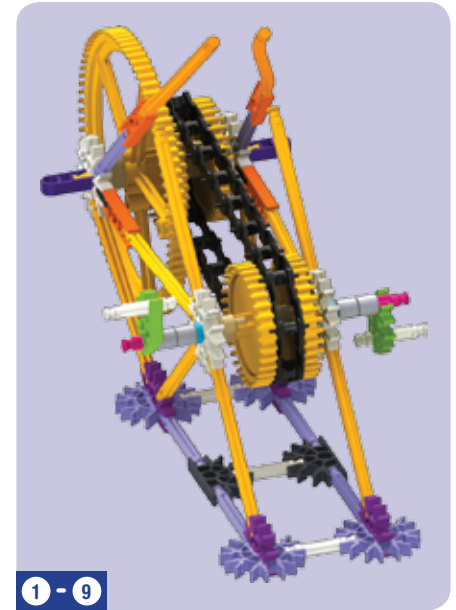
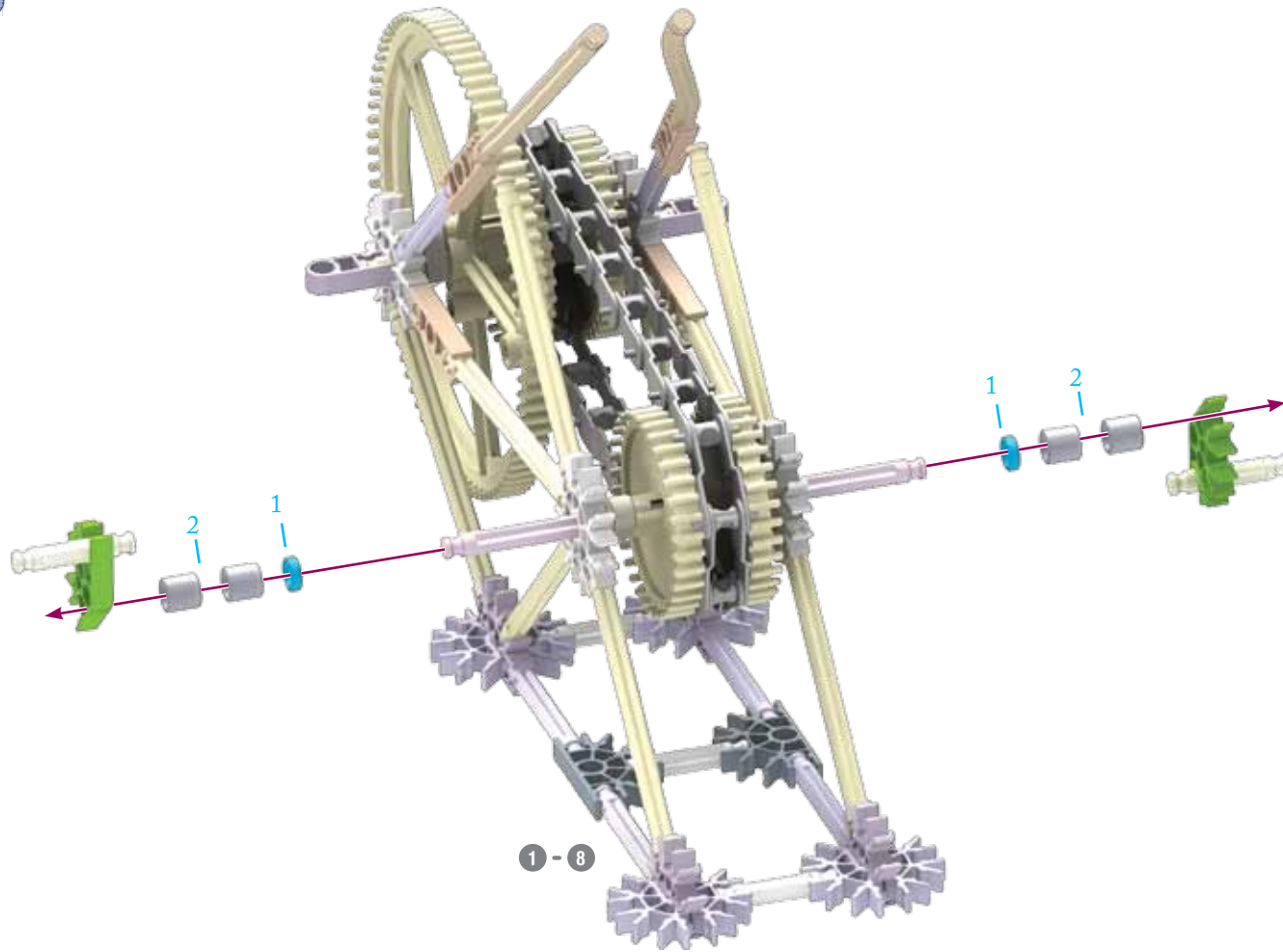

10

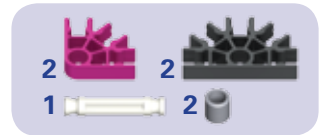
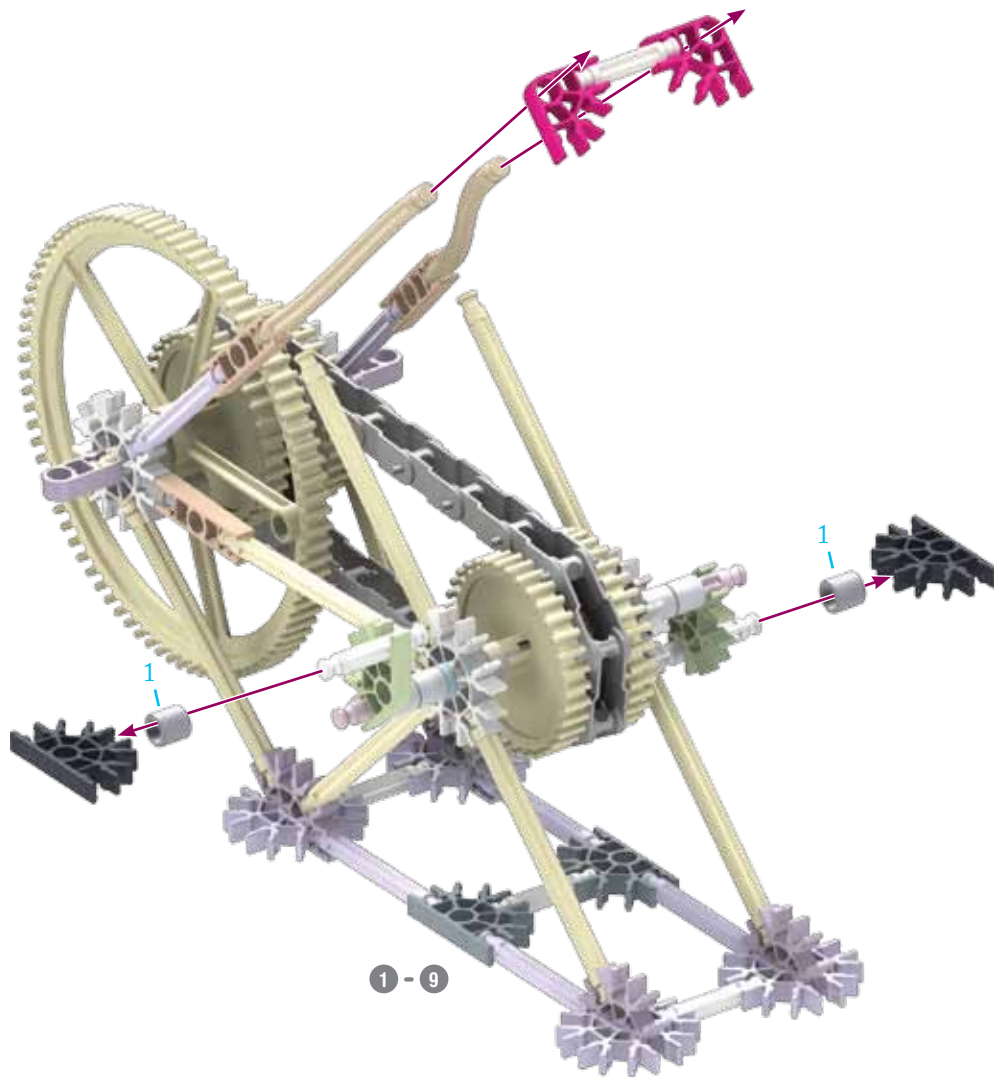

11

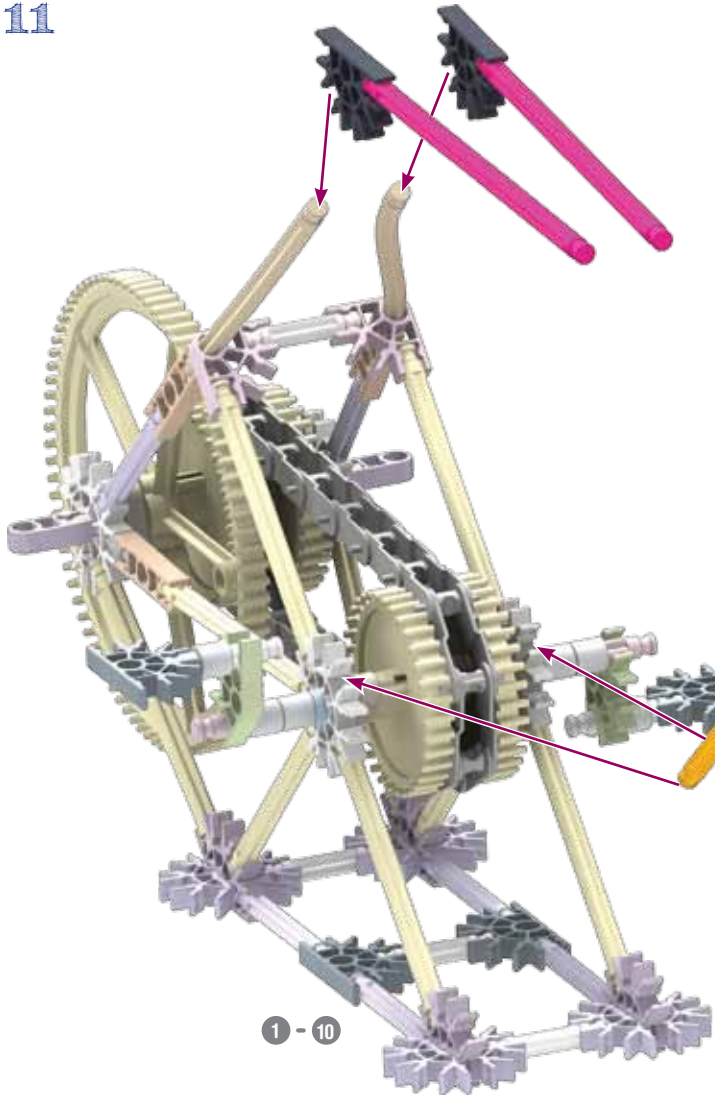

1 - 10

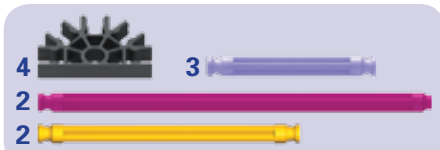

1 - 11

12

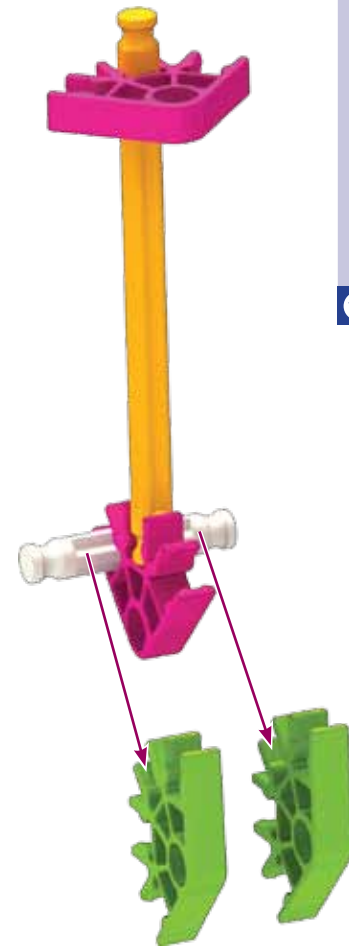

12

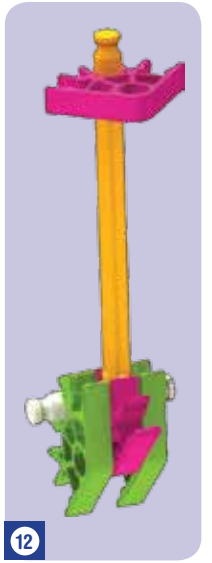

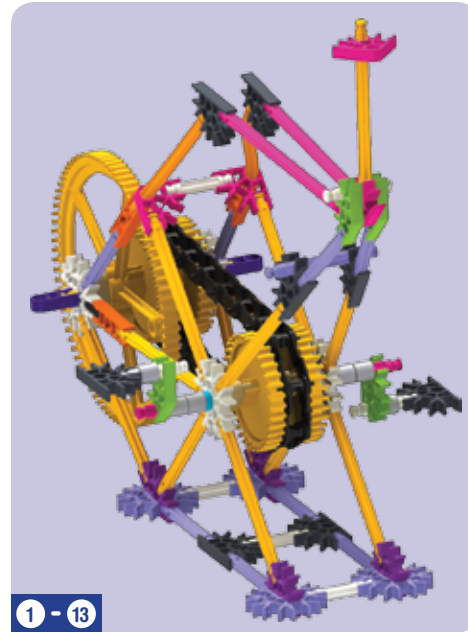
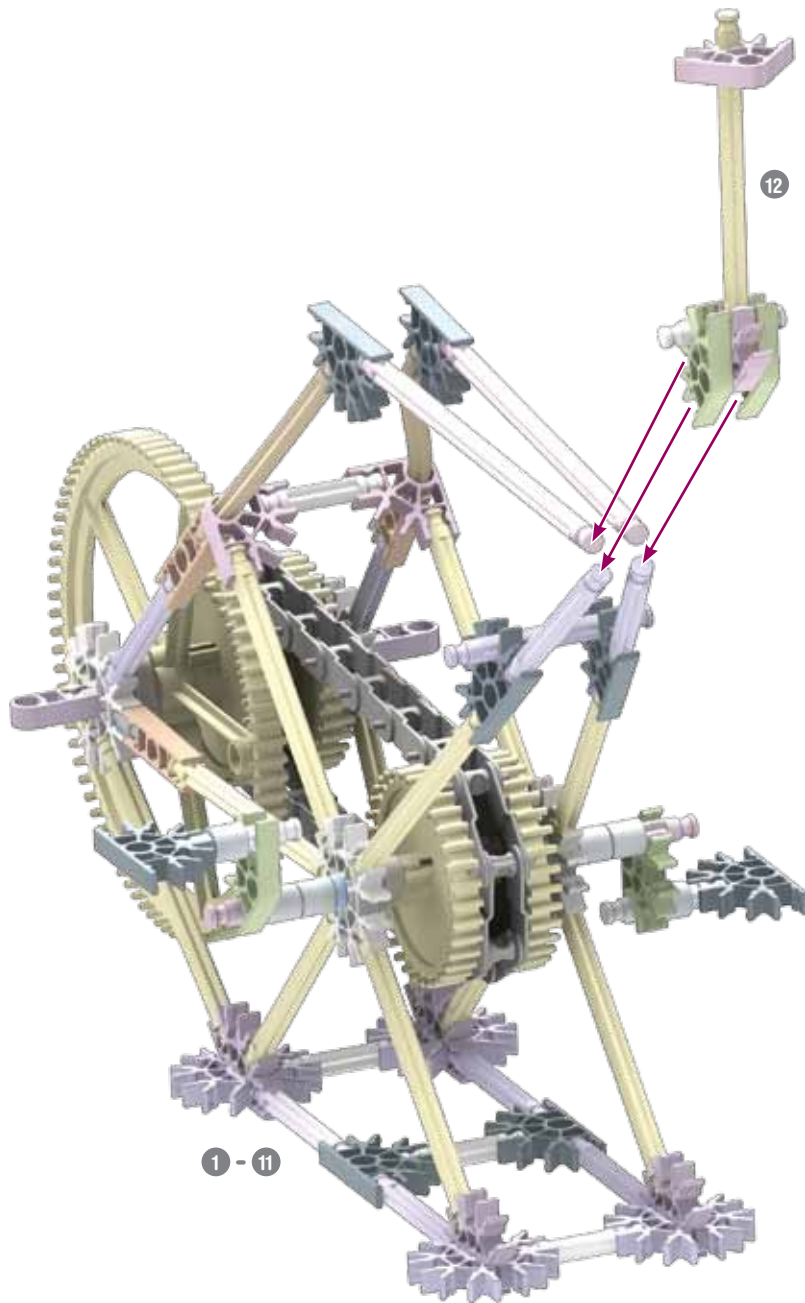

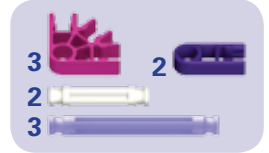
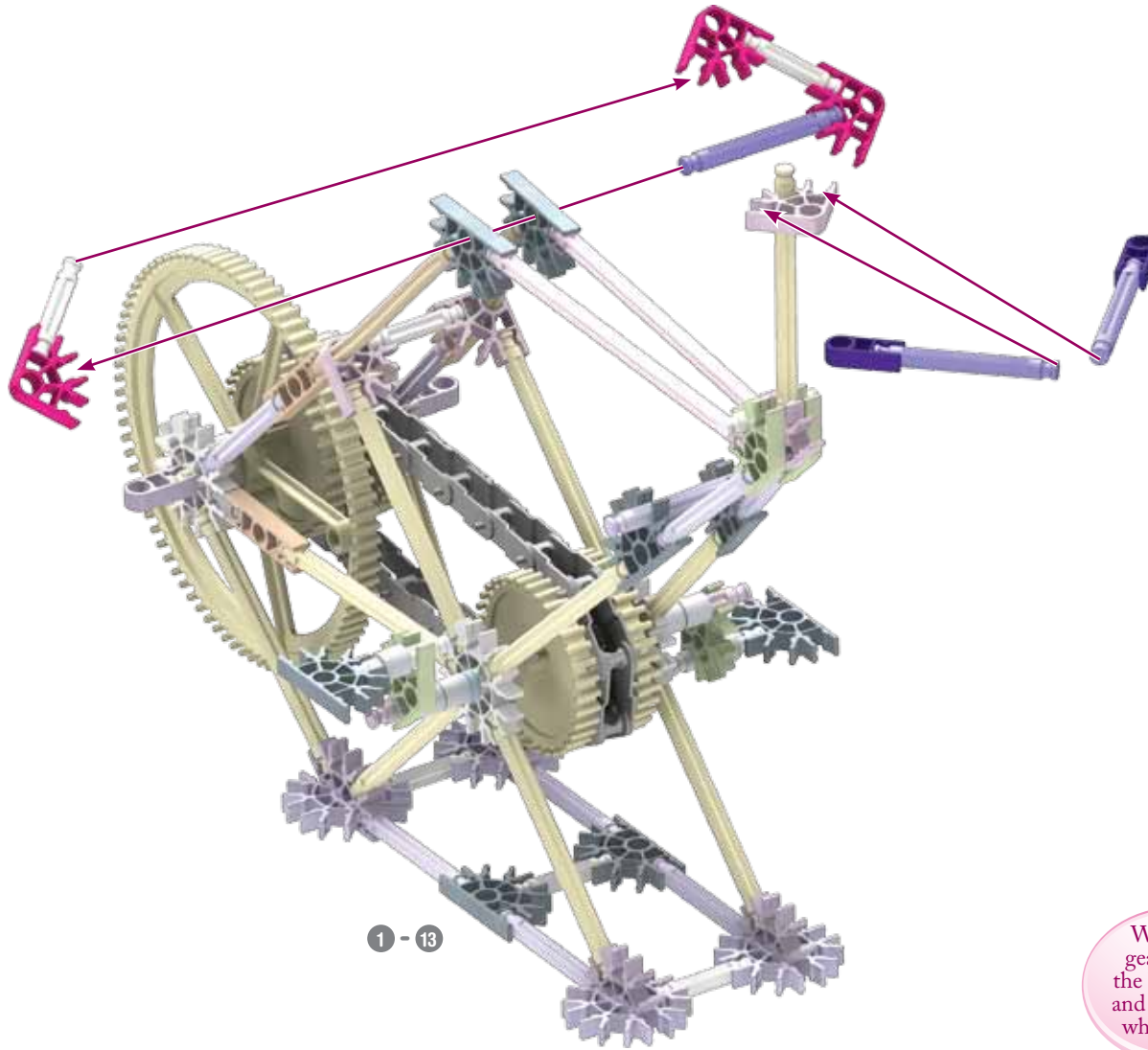

Wow! The gear rotates the bike chain and makes the wheels spin!

