

43553 Alternate Build

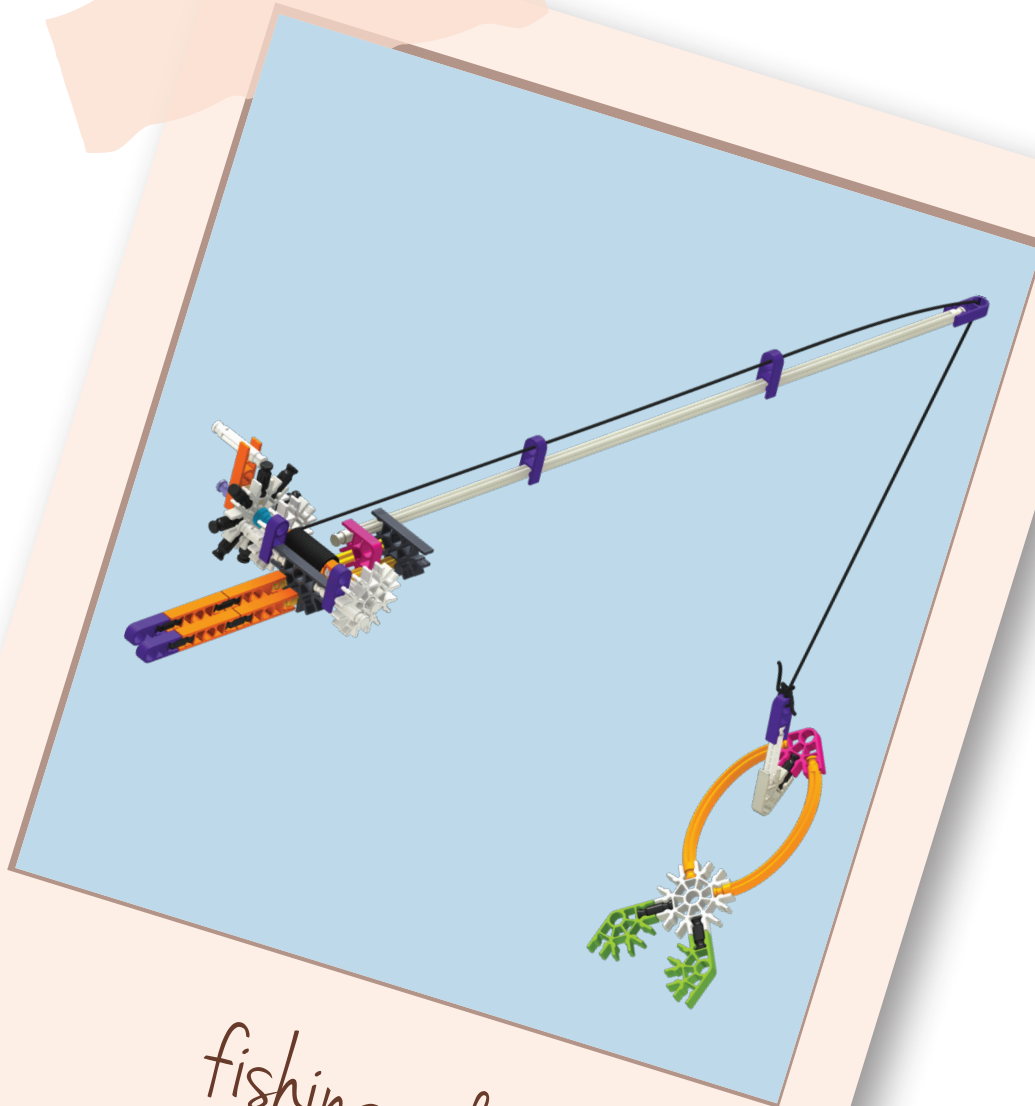

fishing pole

Invention: Fishing Pole

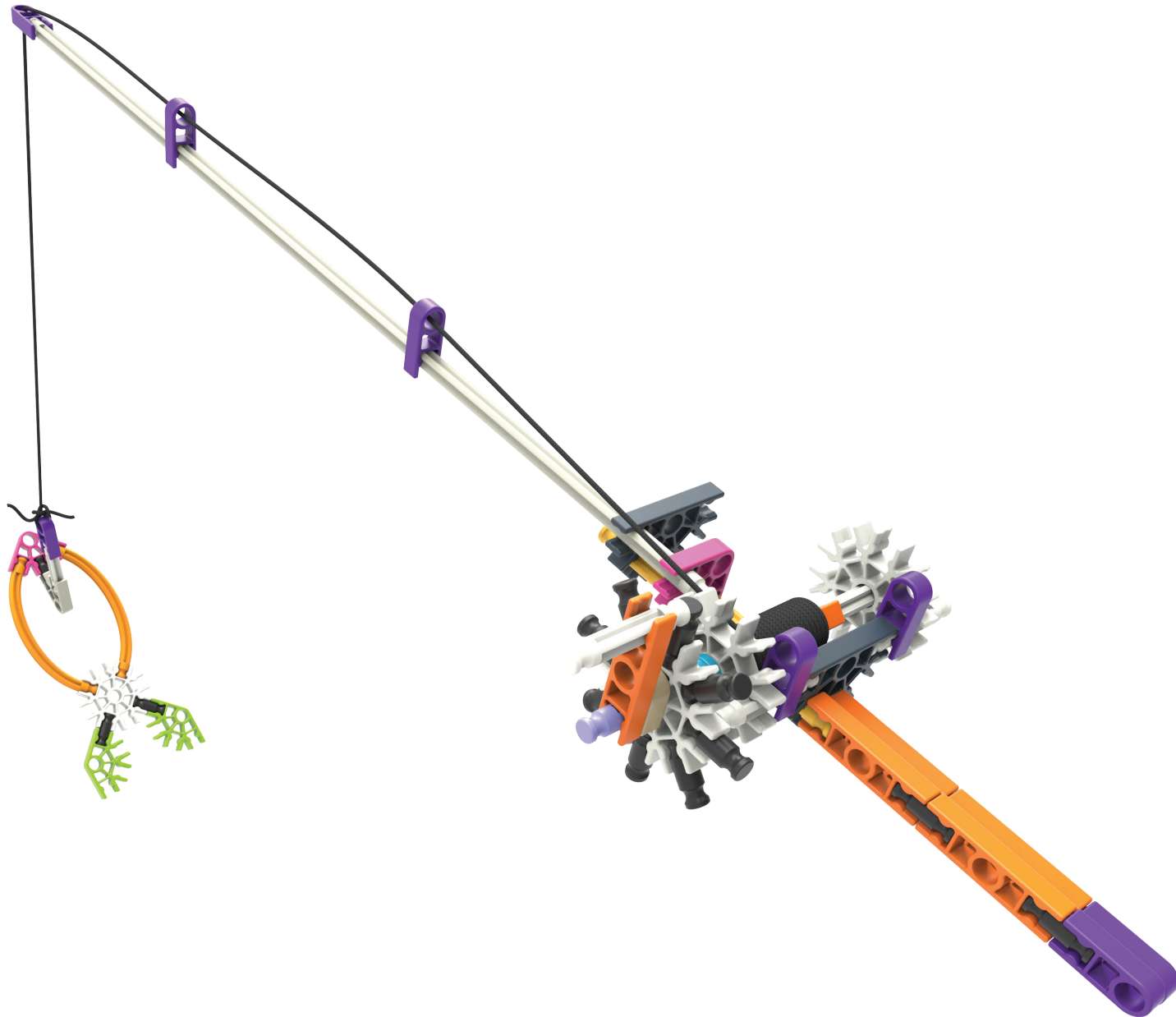

1

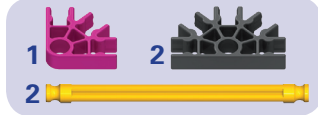
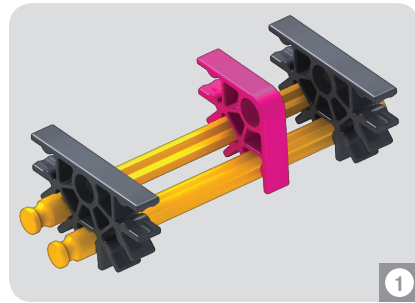
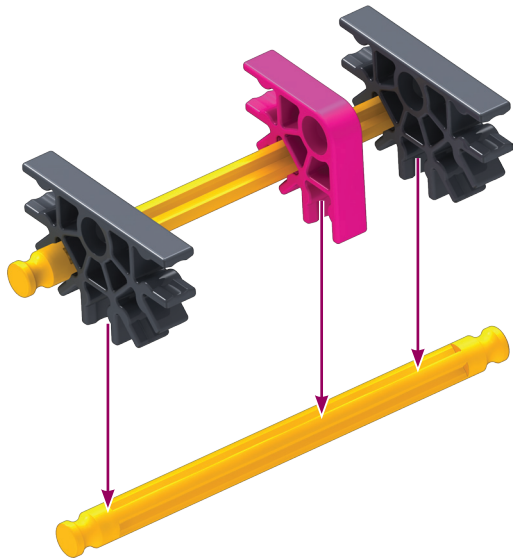

2

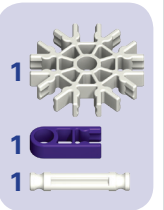
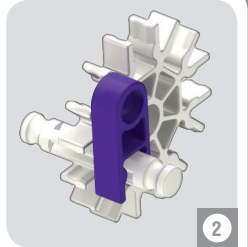
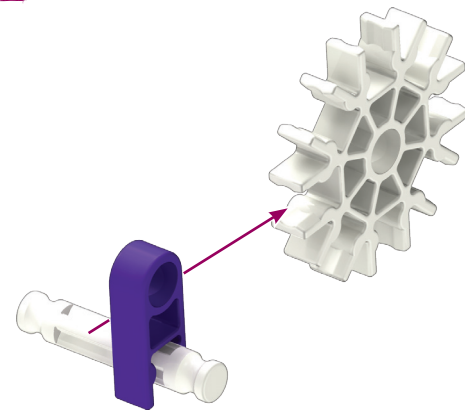

3

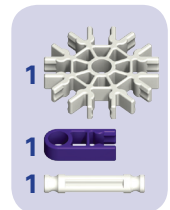
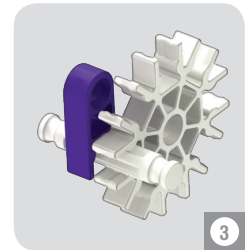
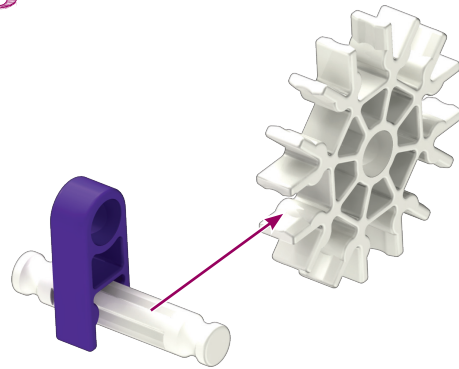

Let's build a fishing pole and see how it works!

4

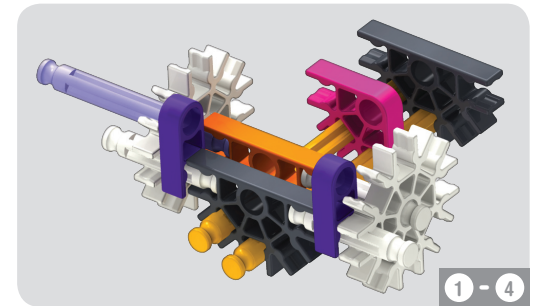
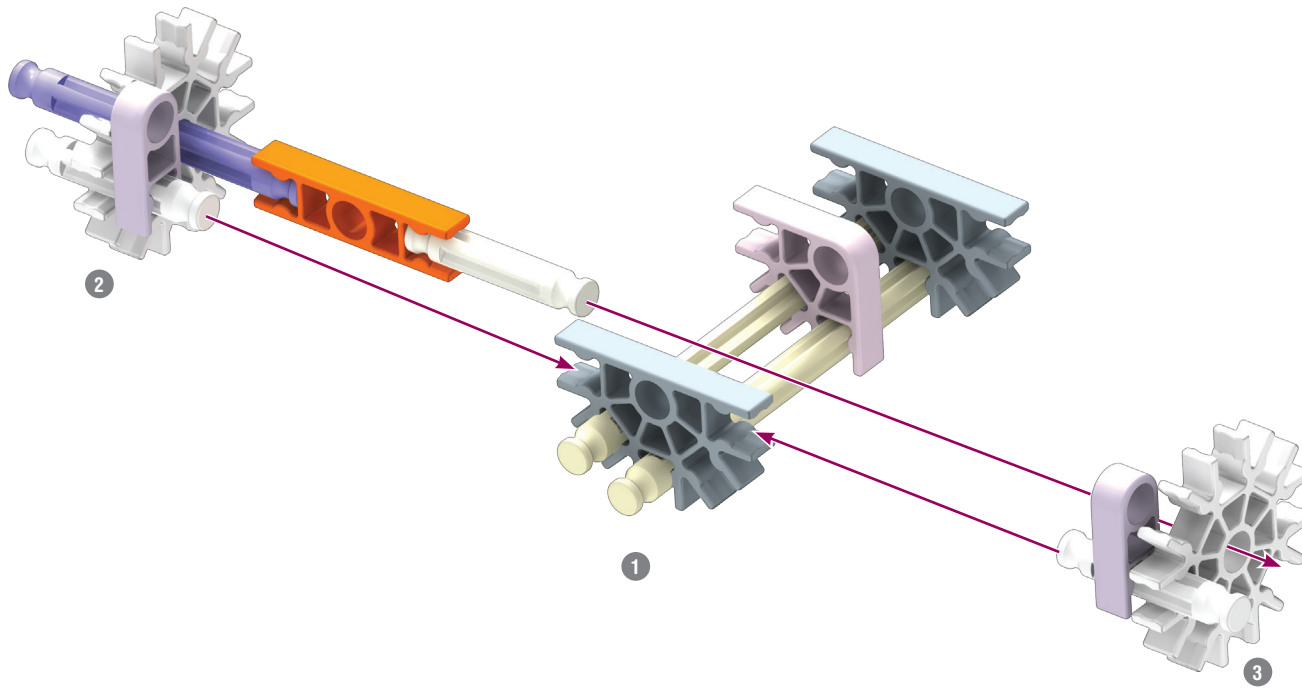

- 1
- 1
- 1

5

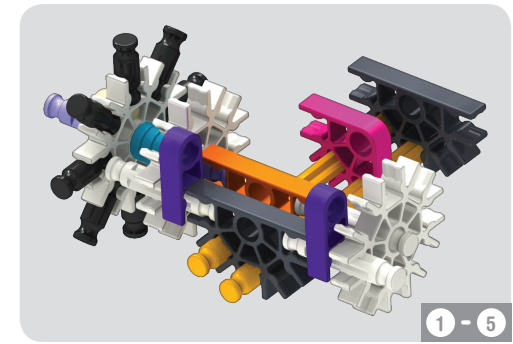
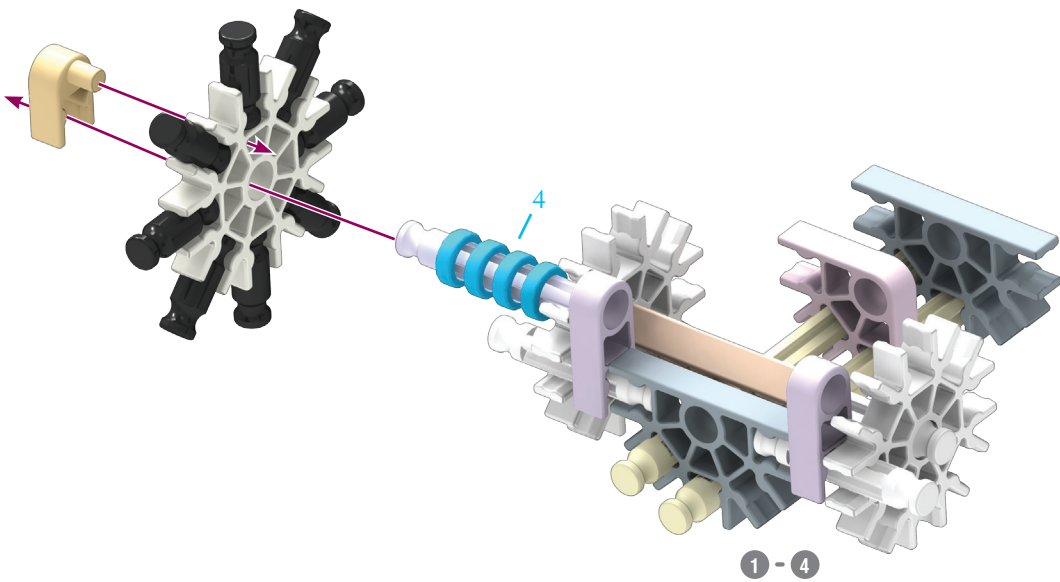

- 1
- 1
- 8
- 4

6

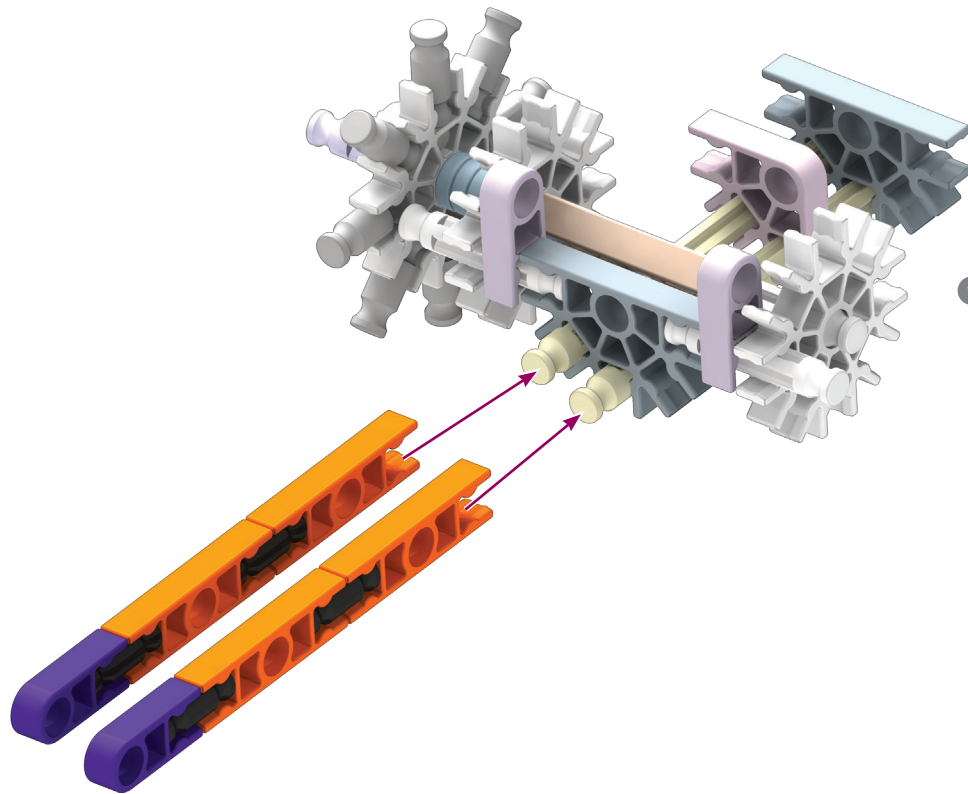

1 - 5

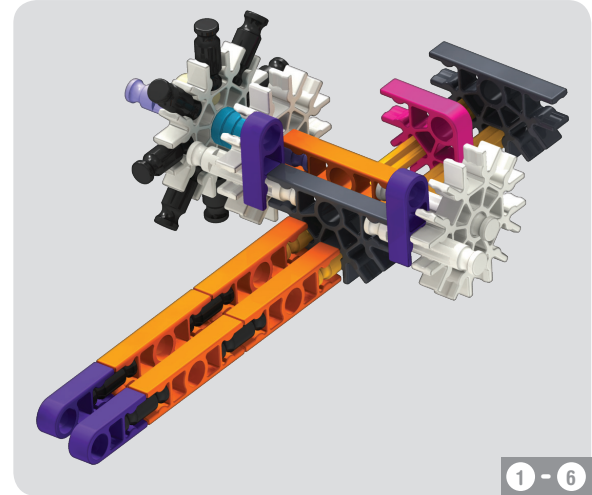

1 - 6

- 4 
- 4  2 

7

This part of the fishing pole can rotate to snap the rods in easier.

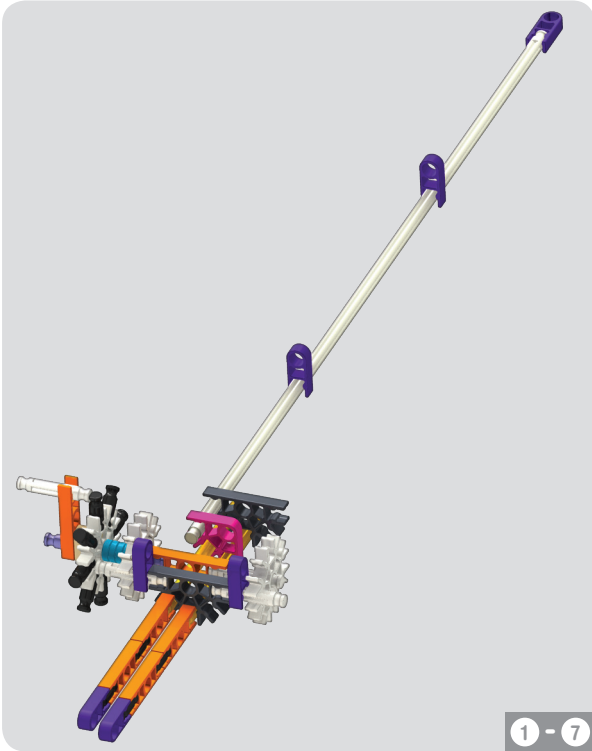
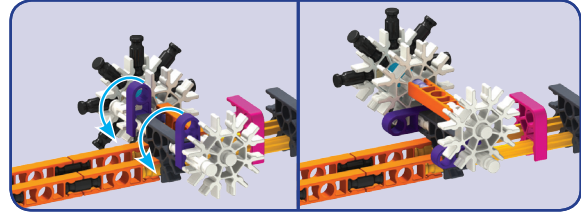

1 - 6

1 - 7

- 1
- 1
- 3
- 1

8



8

- 1
- 2
- 1
- 1
- 1
- 2
- 1
- 3



Great job!
Now we can go
fishing with our
friend Marissa!

Thanks Audrey
and Emily! We
can head out on
my Dad's boat!



9

