

Mini Ball Machine

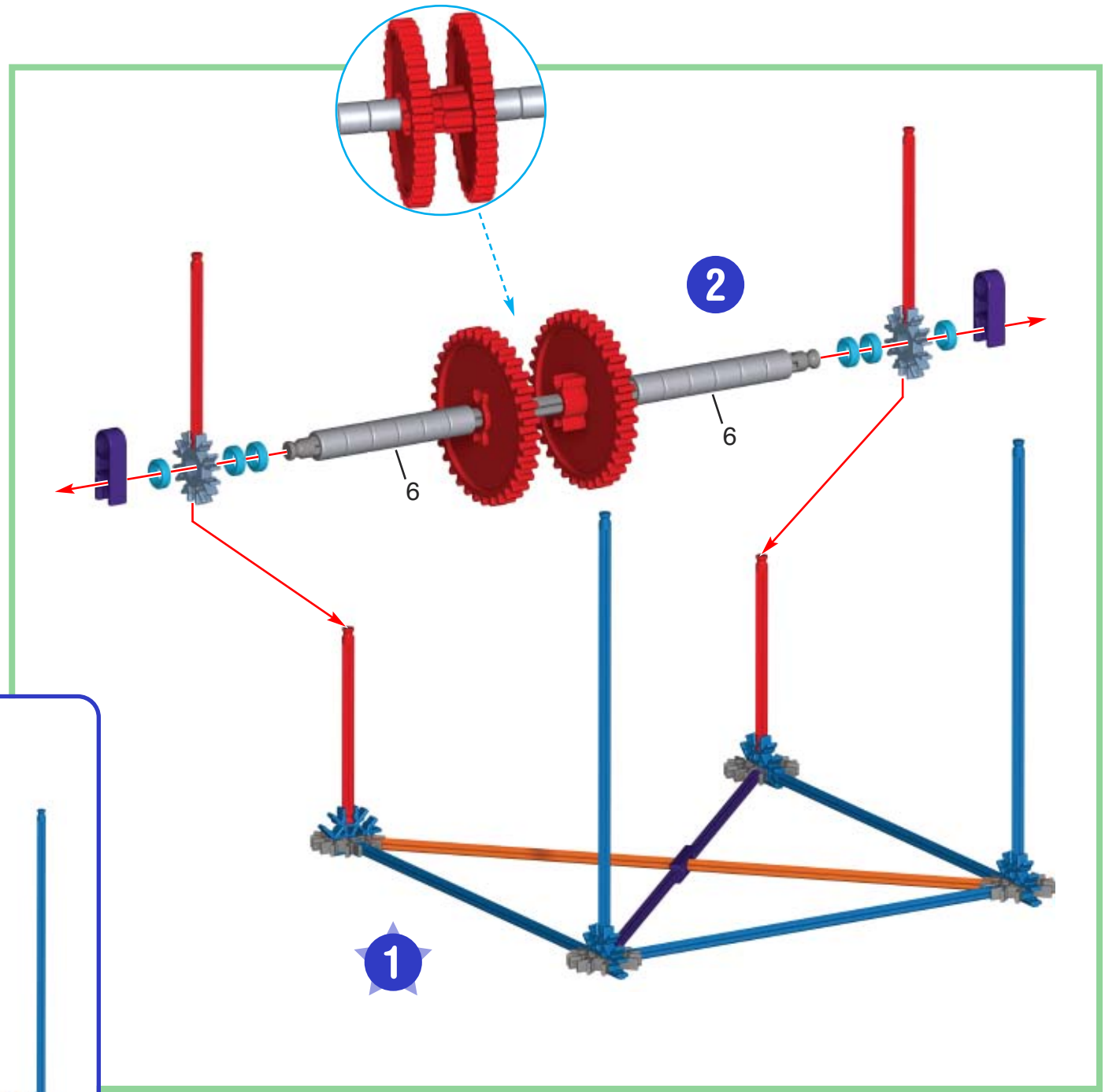

3

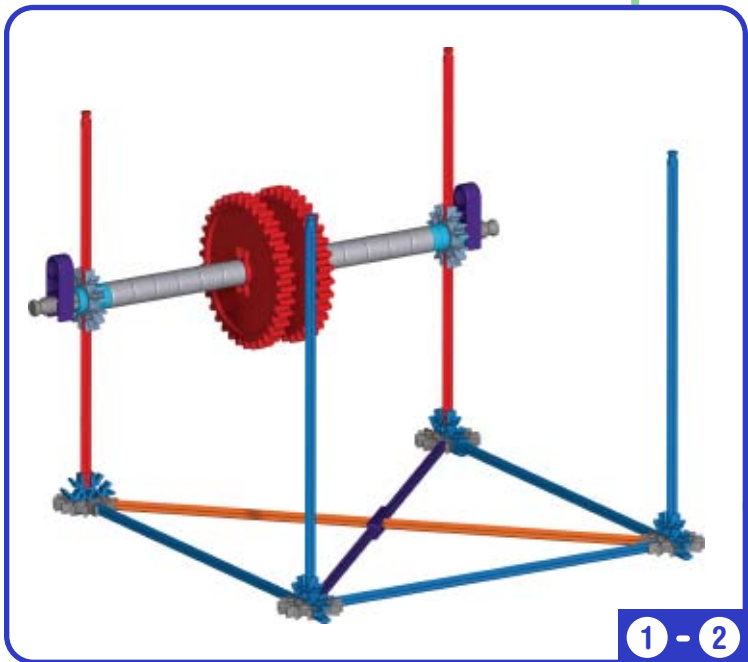
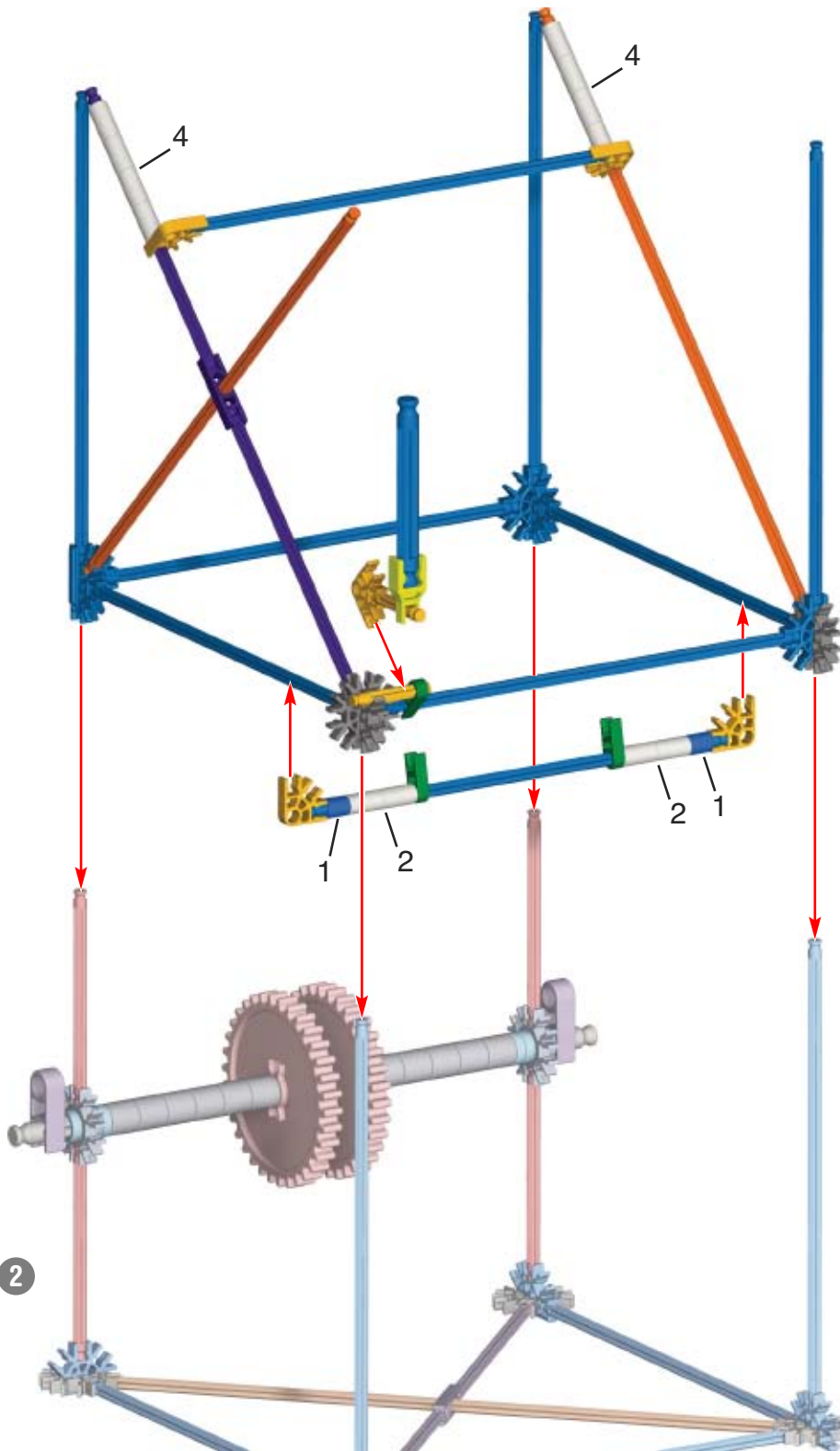

1 - 2

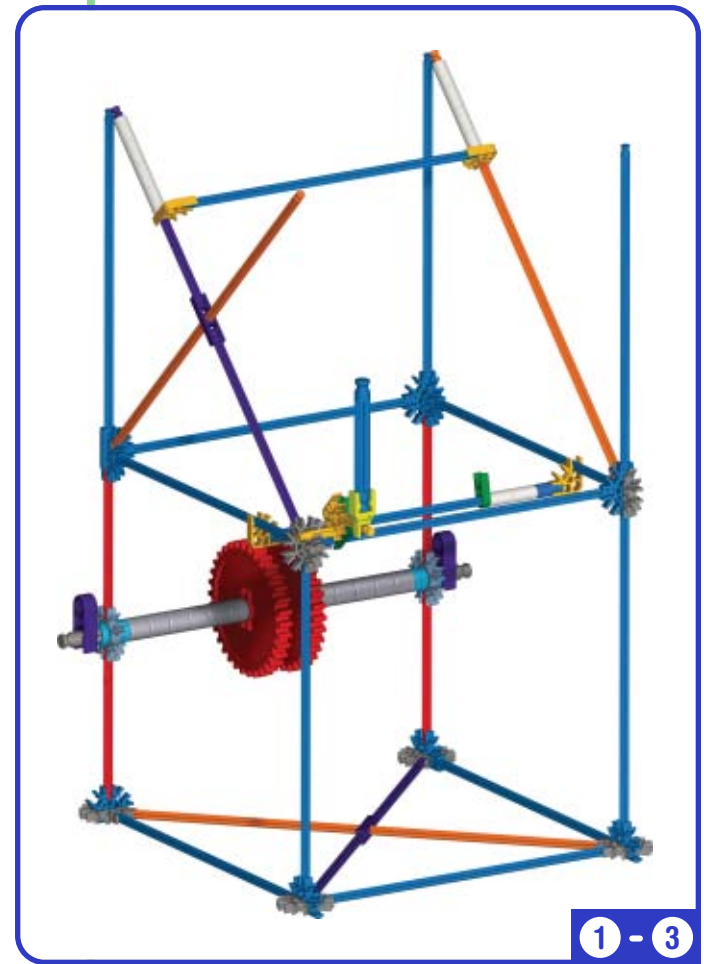

1 - 3

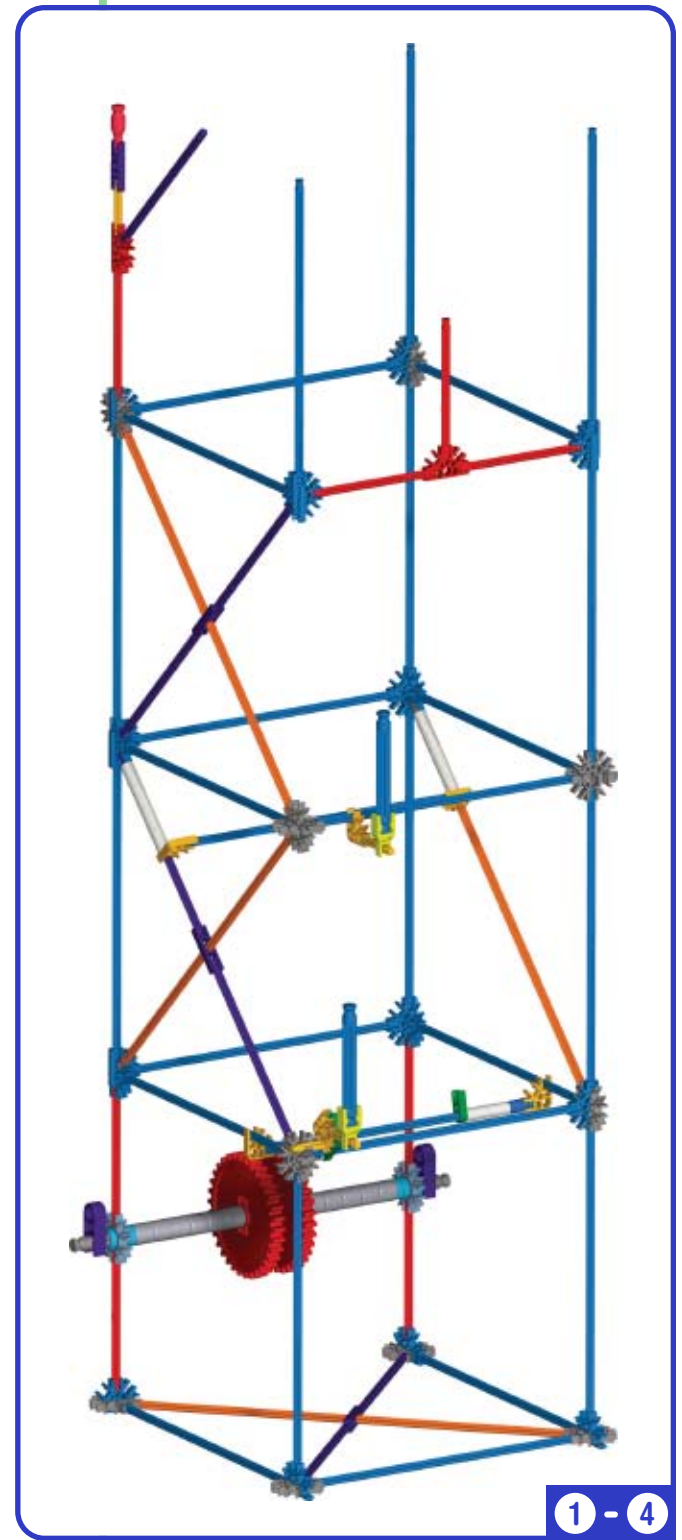
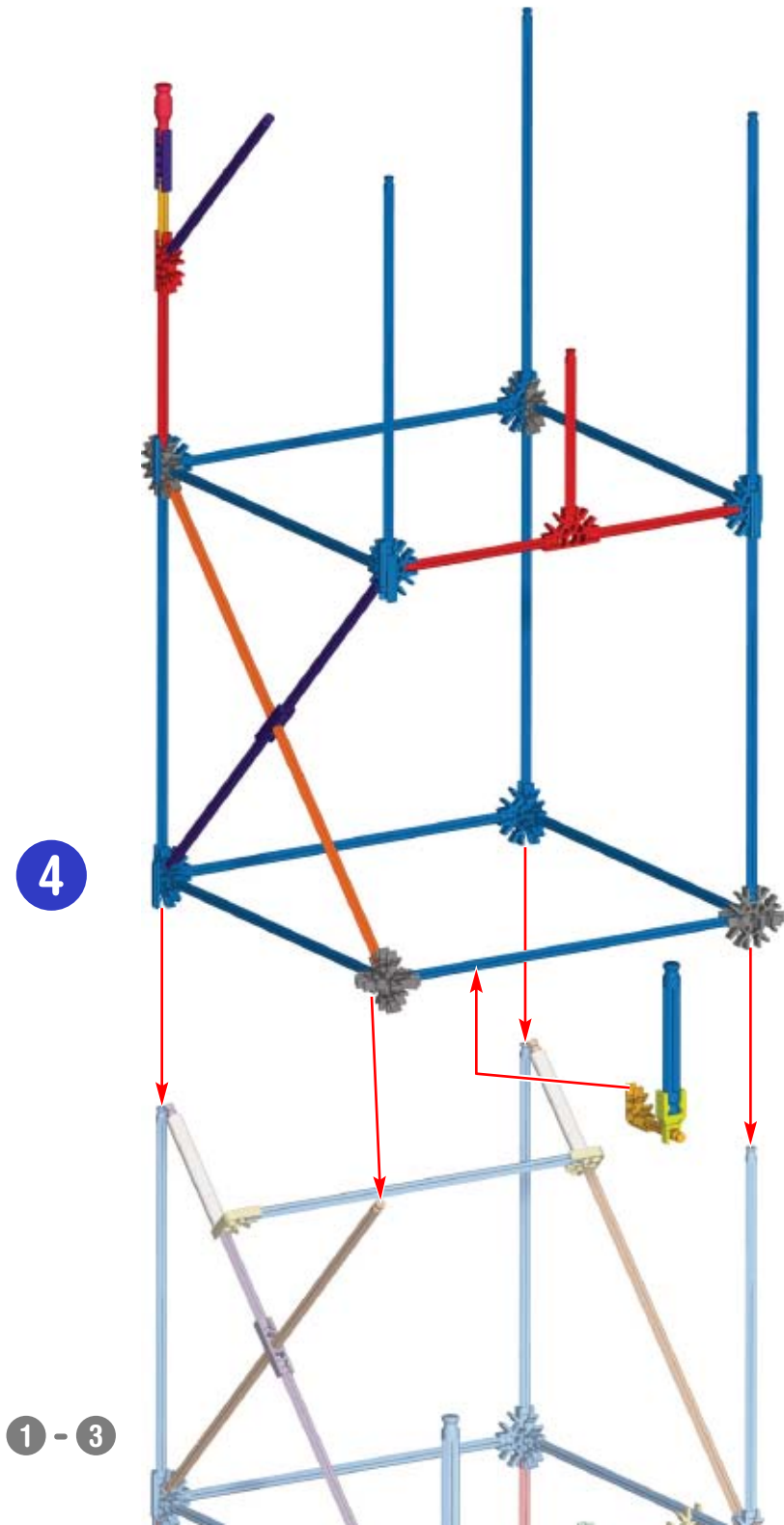



x6

6

5

1 - 4

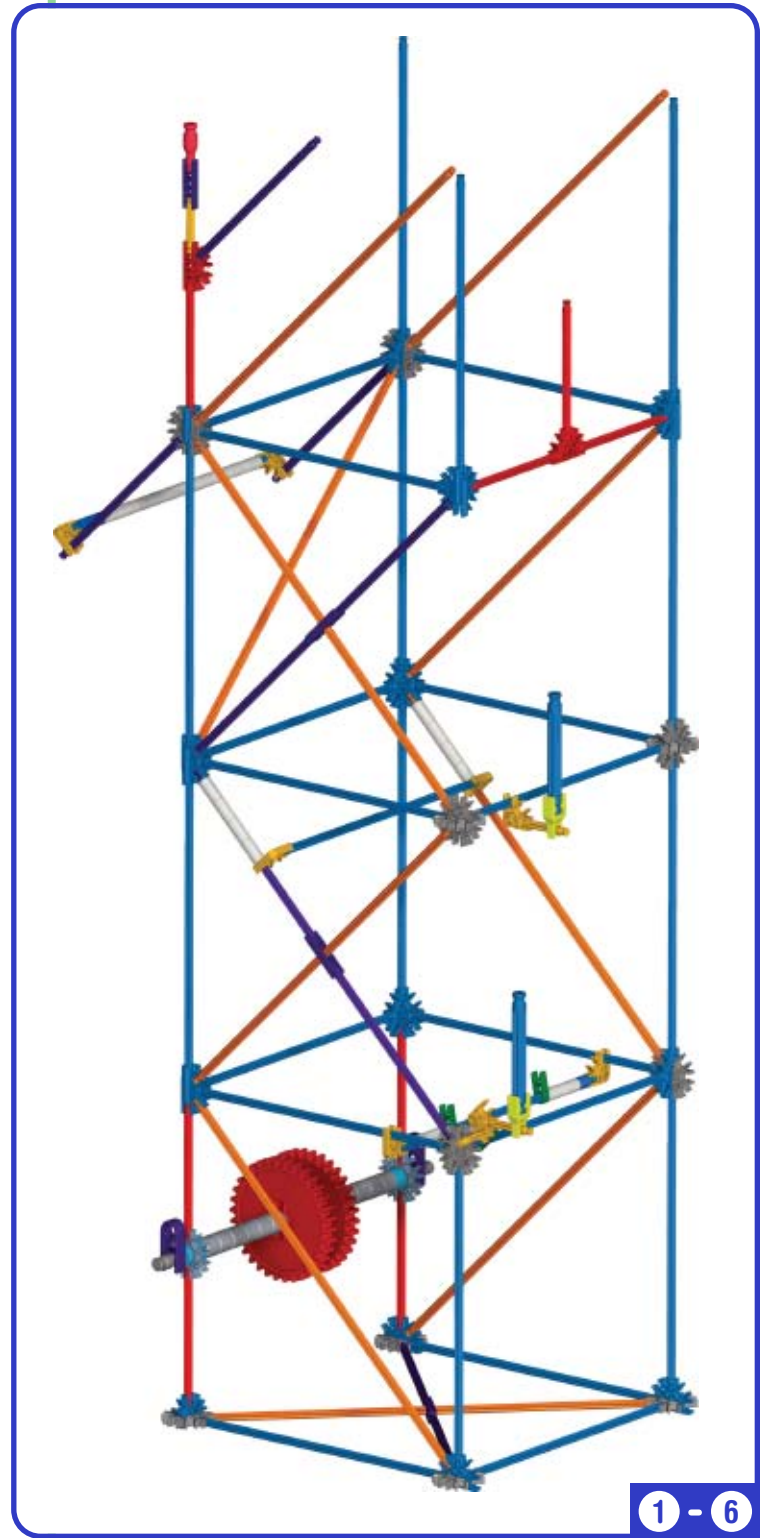

1 - 6

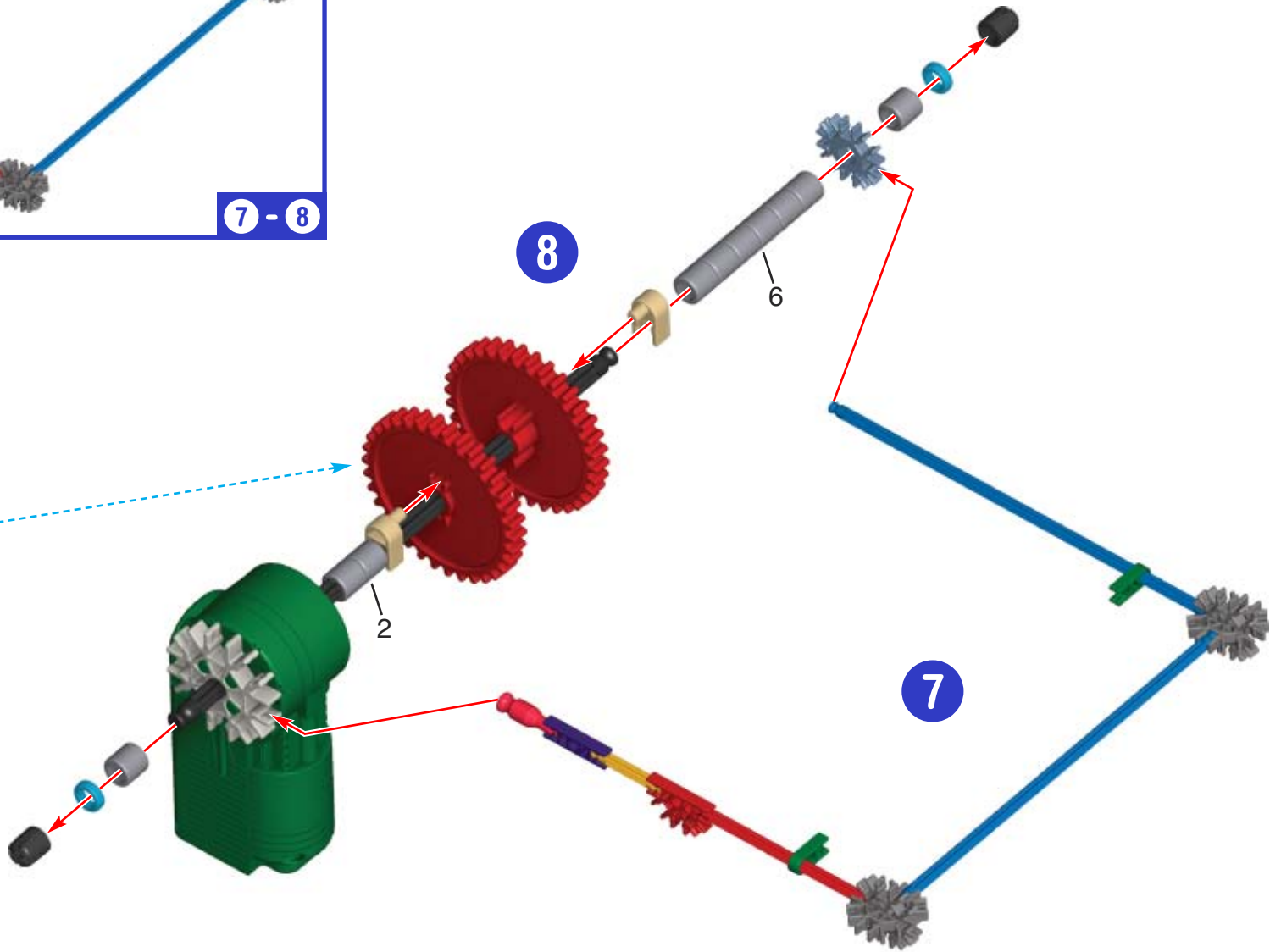
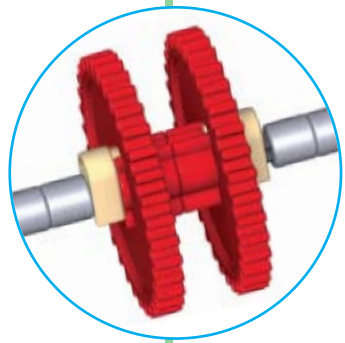
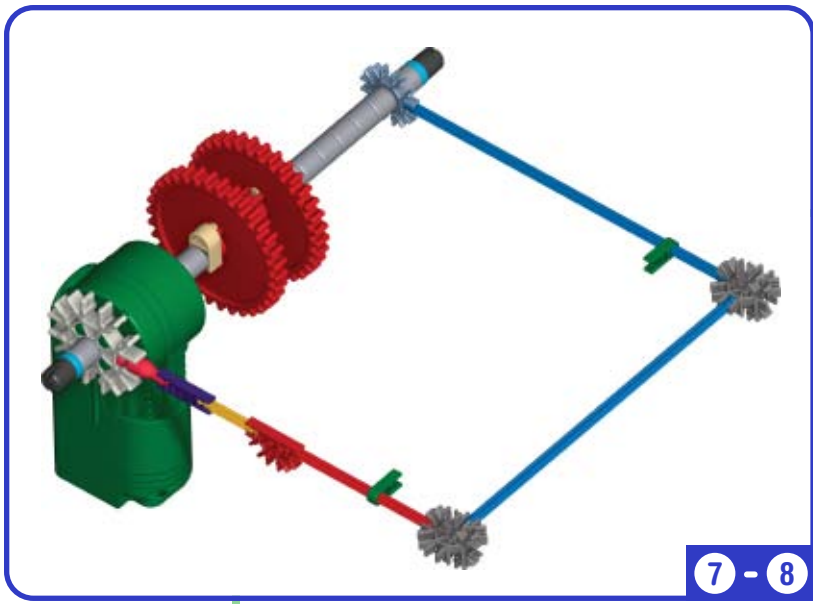

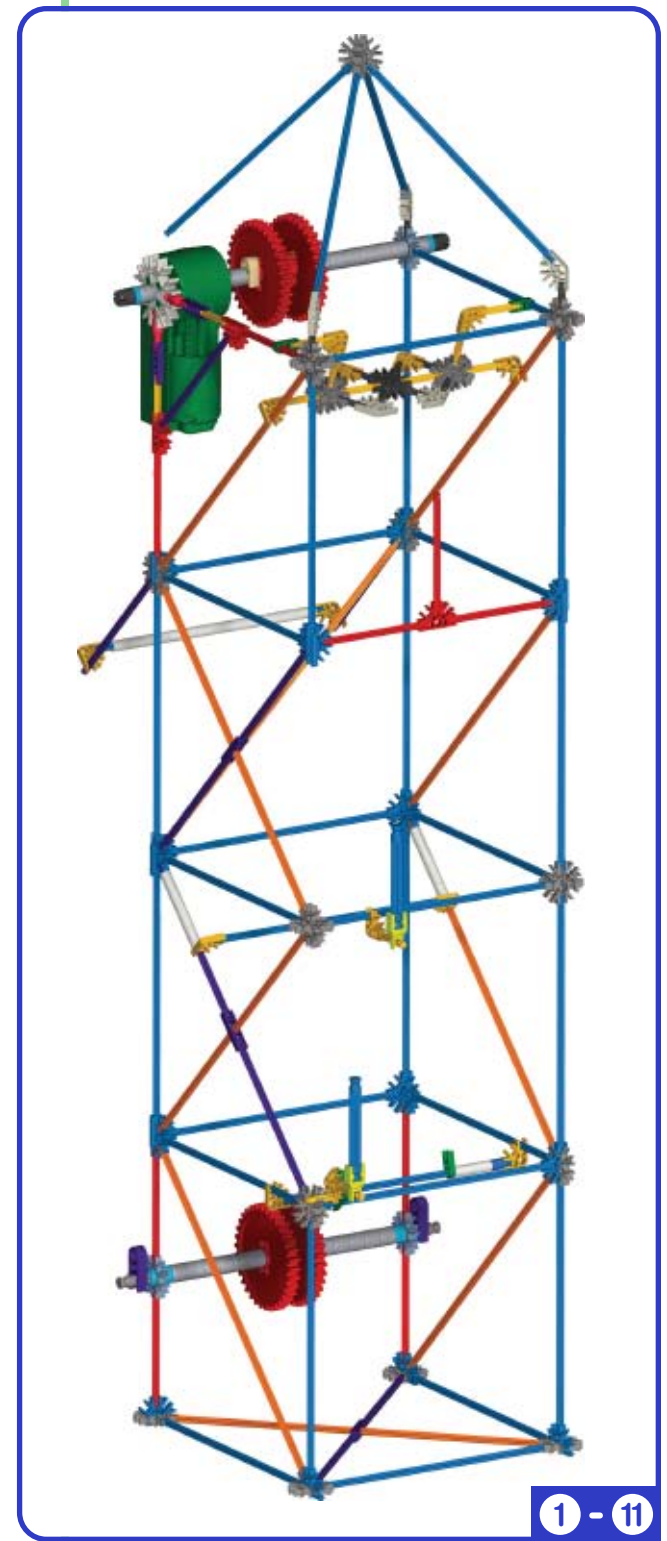
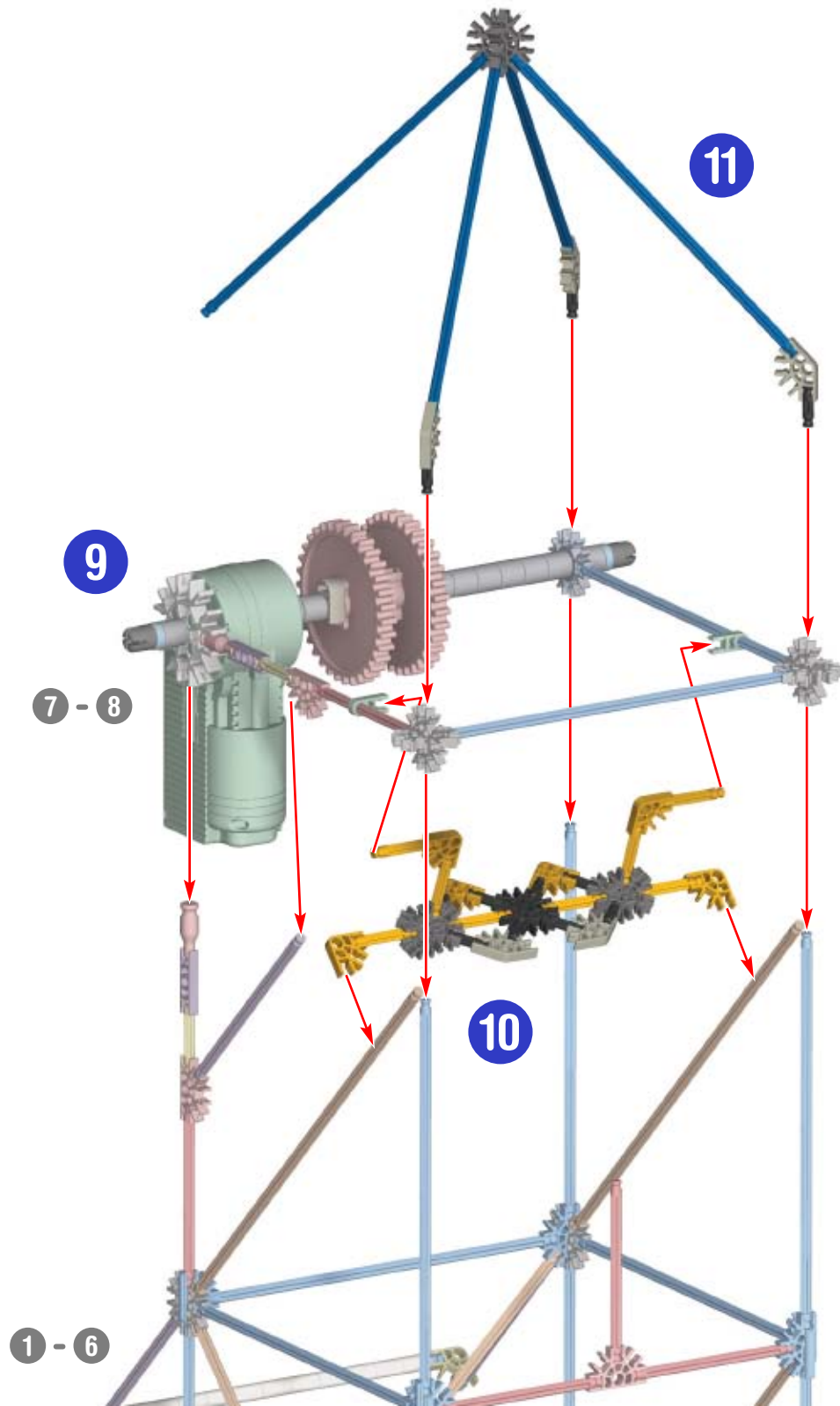

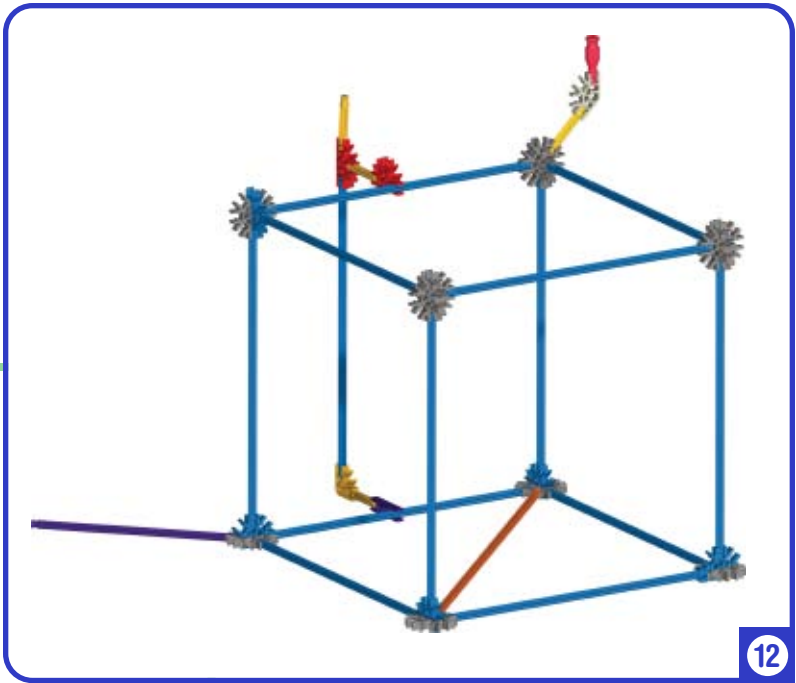
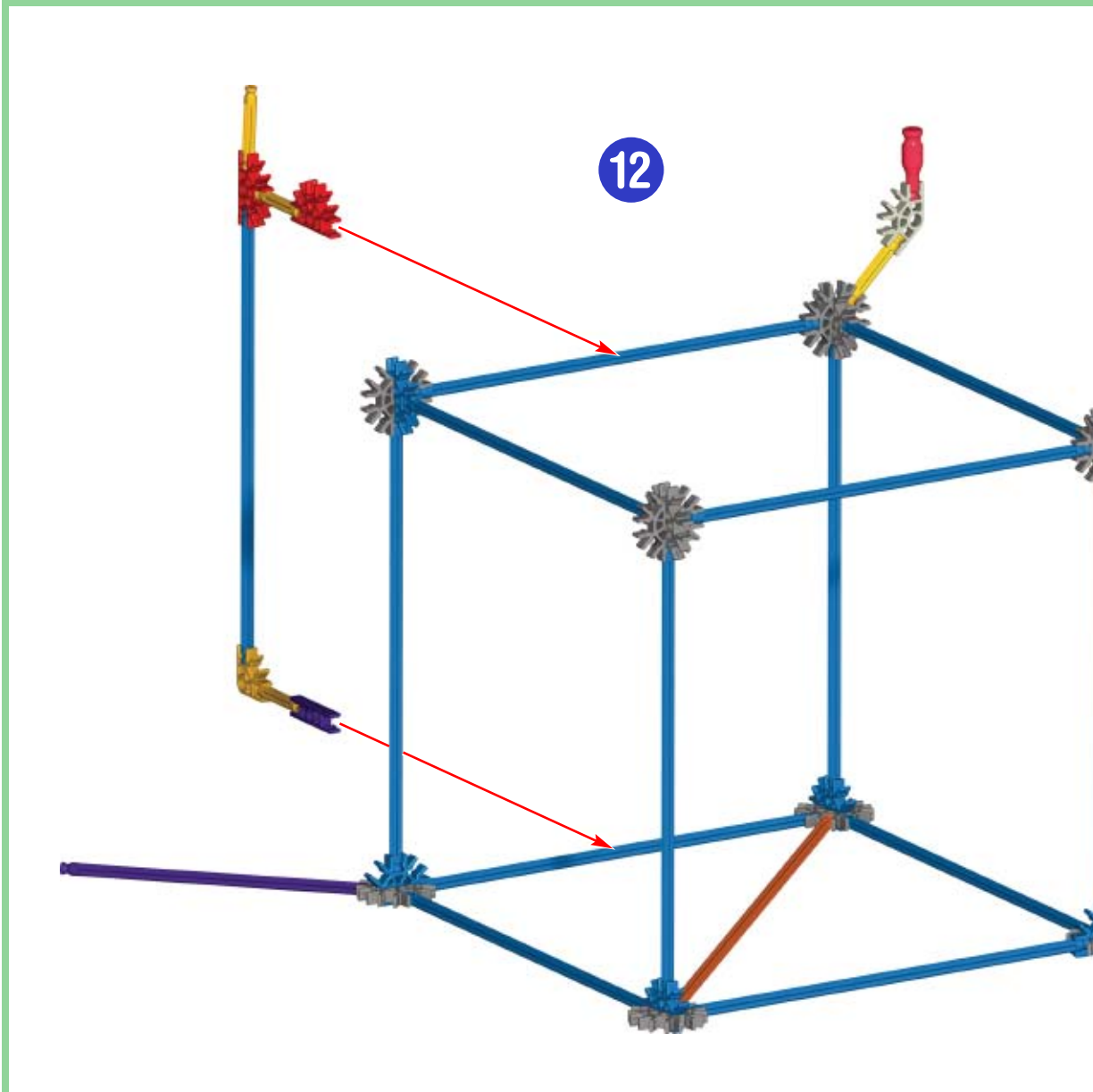

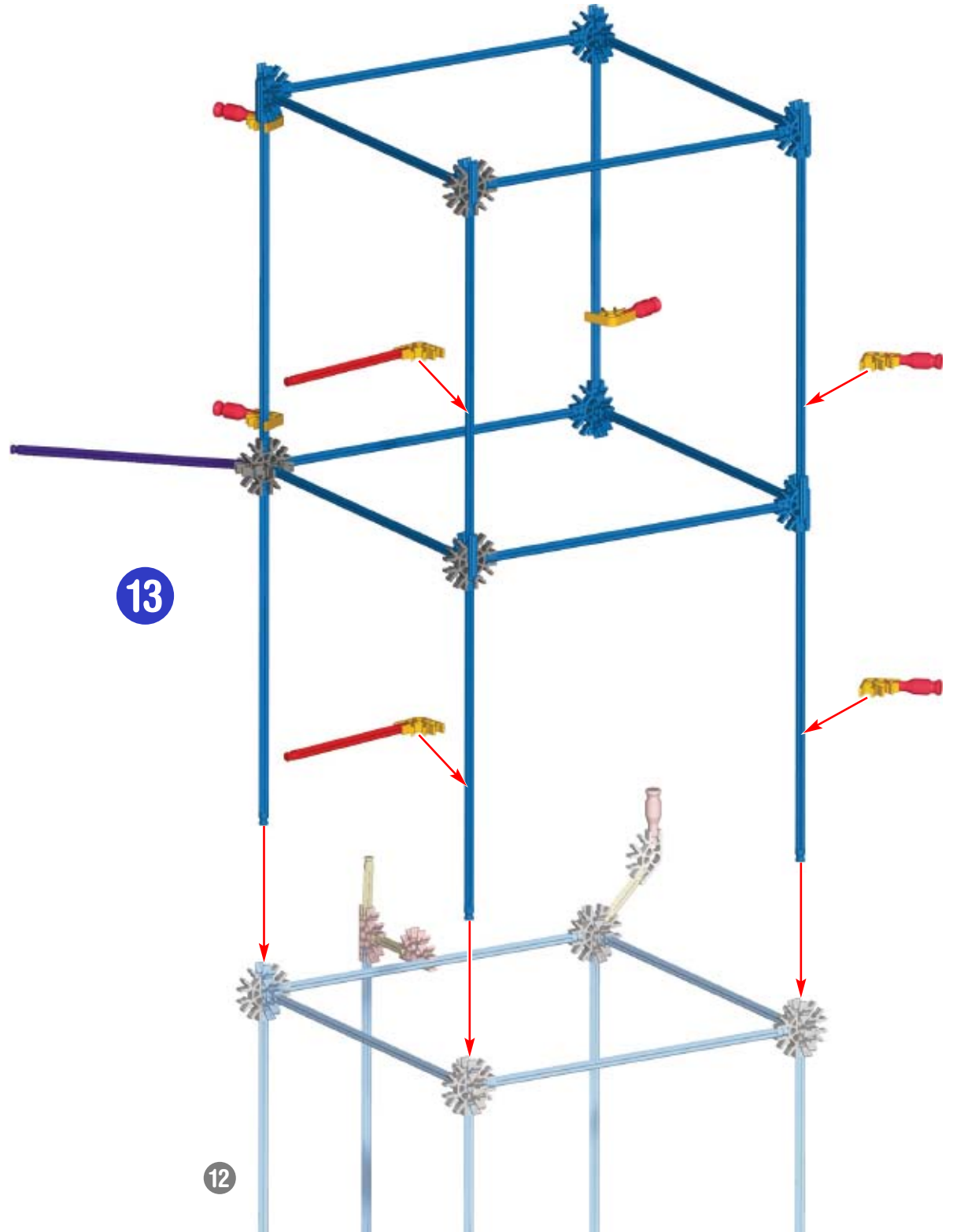
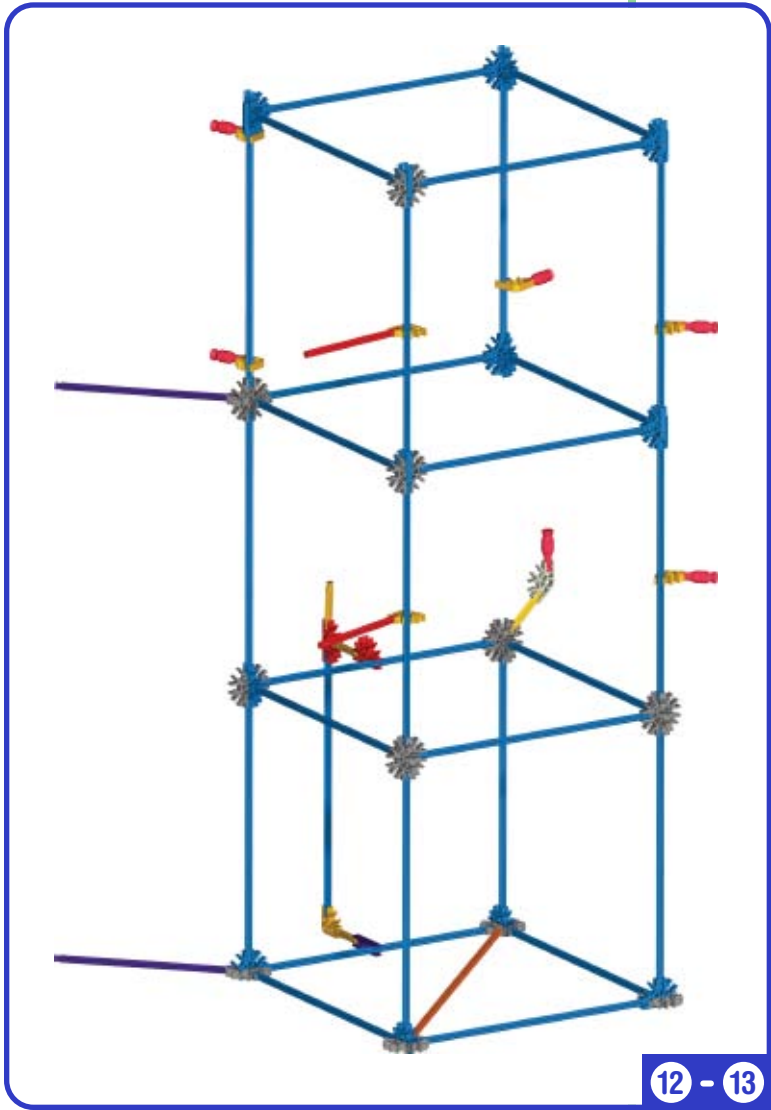

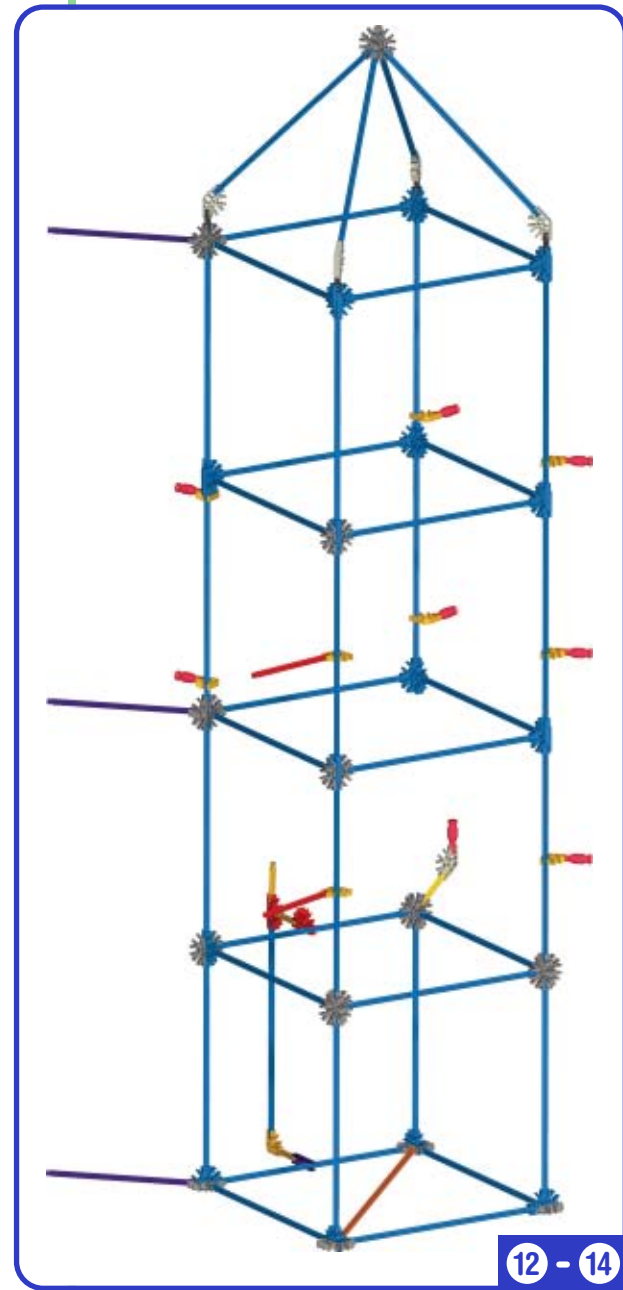
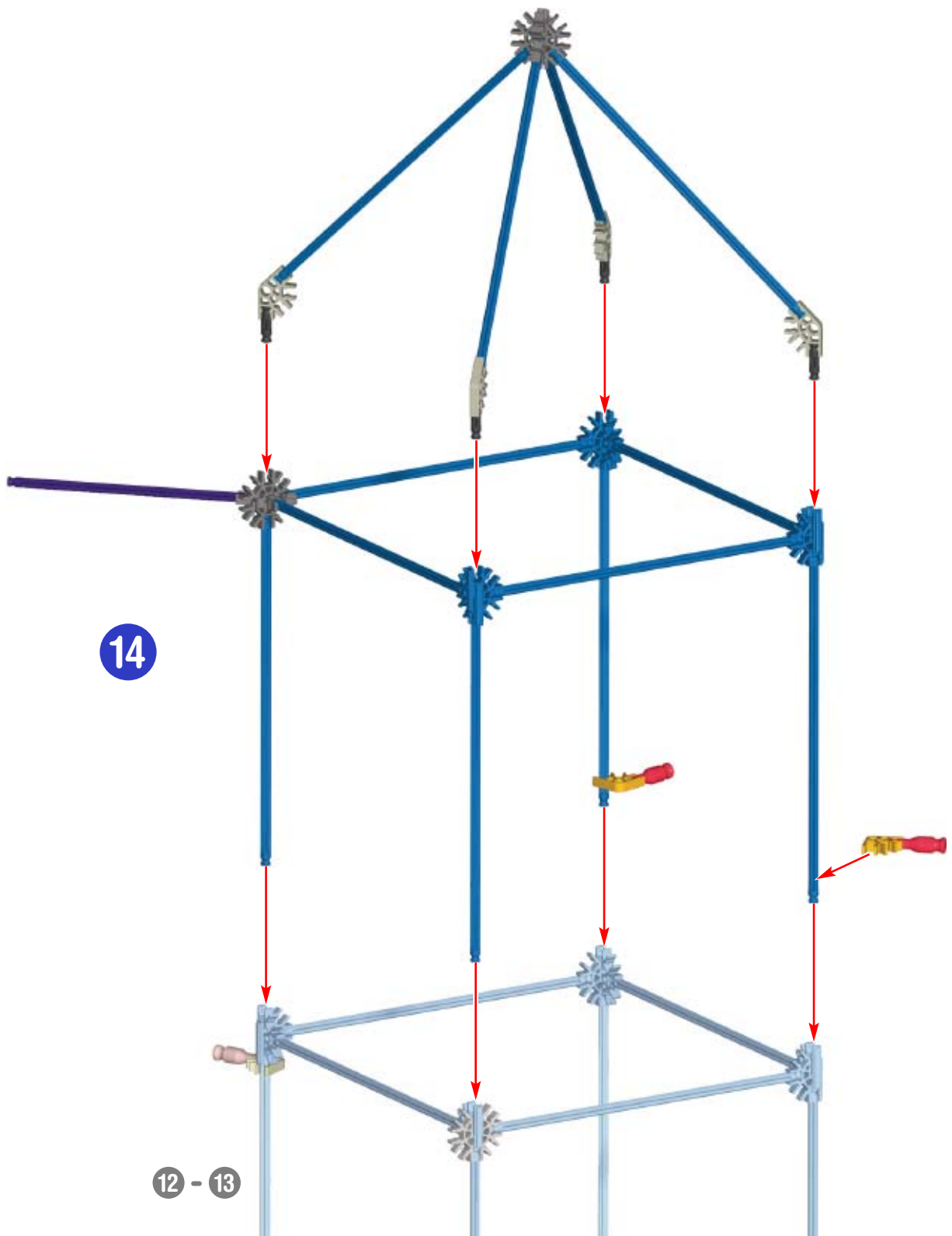

— x8

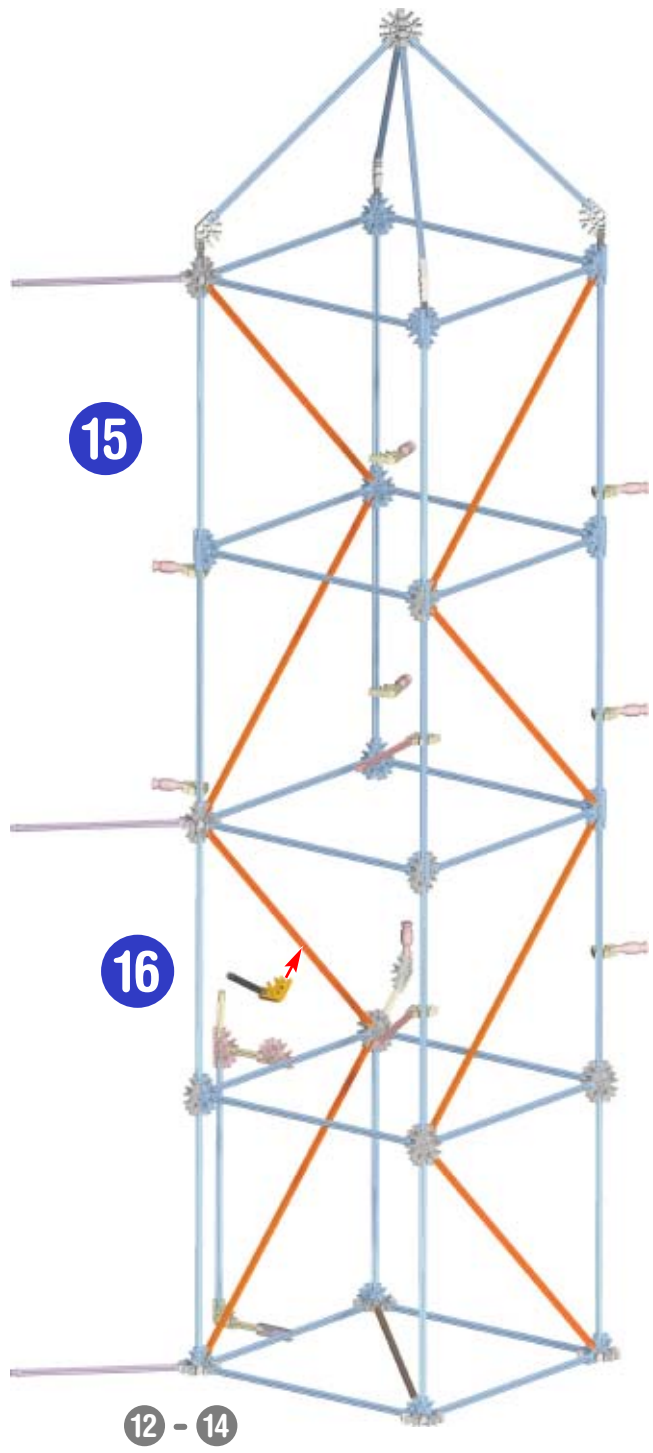

— x8

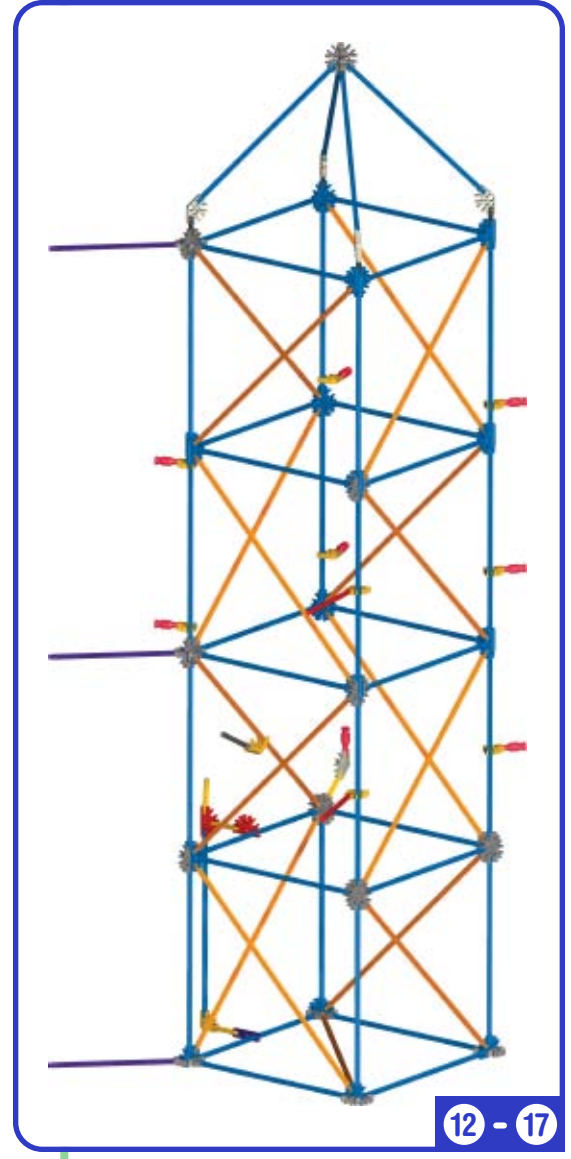
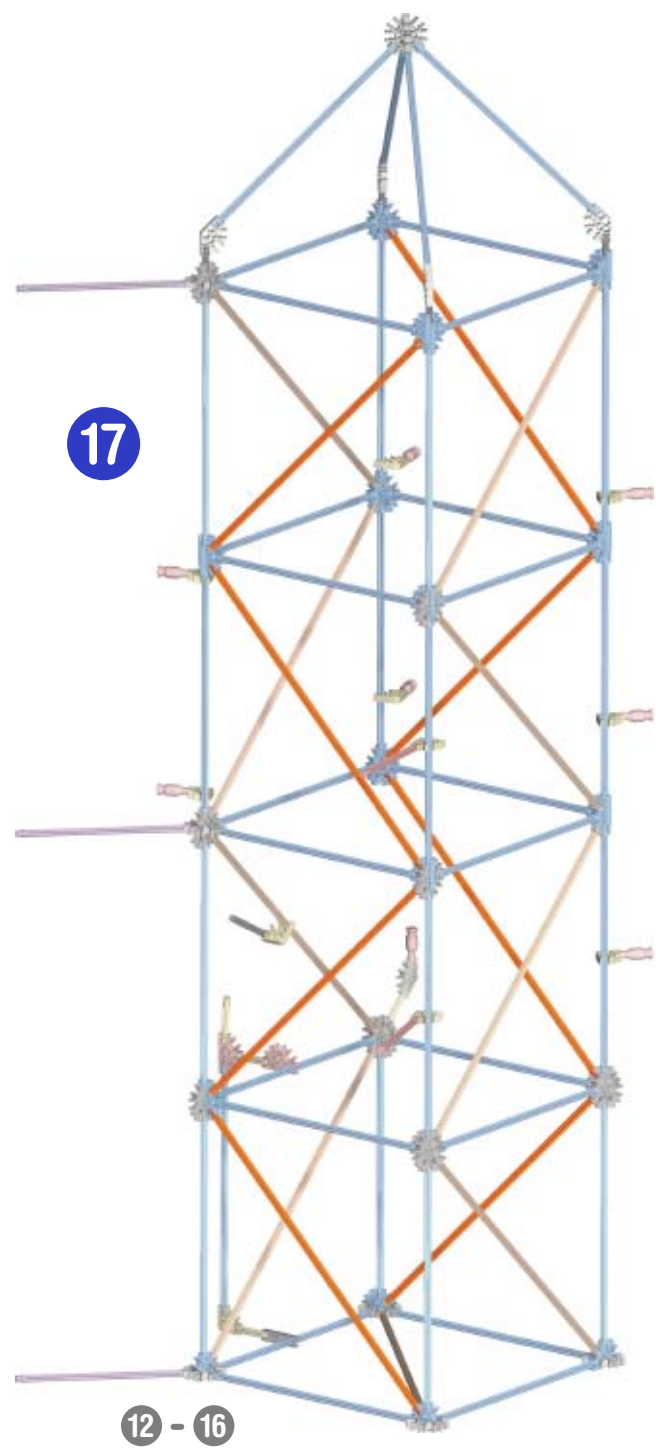

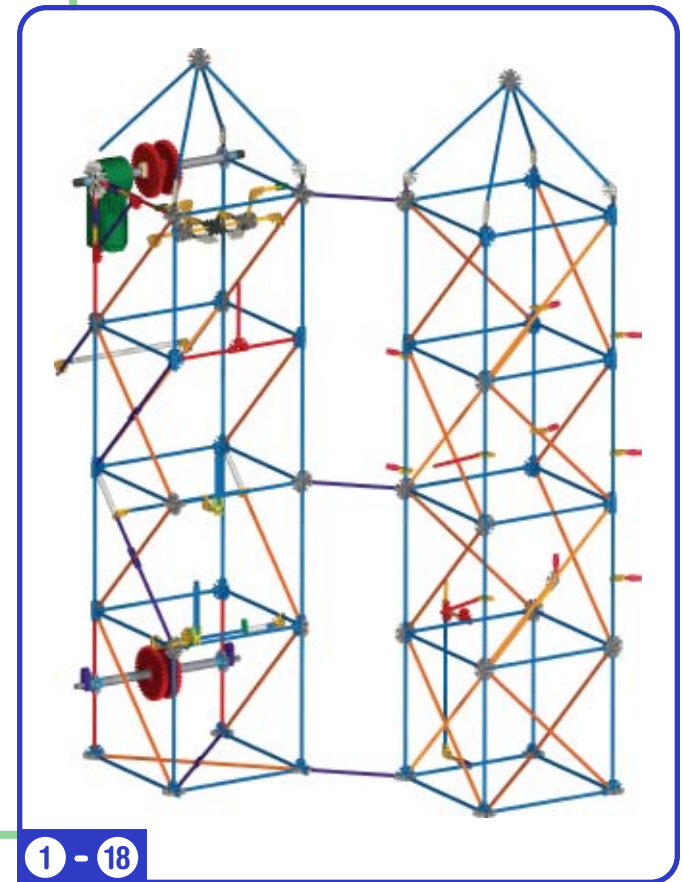
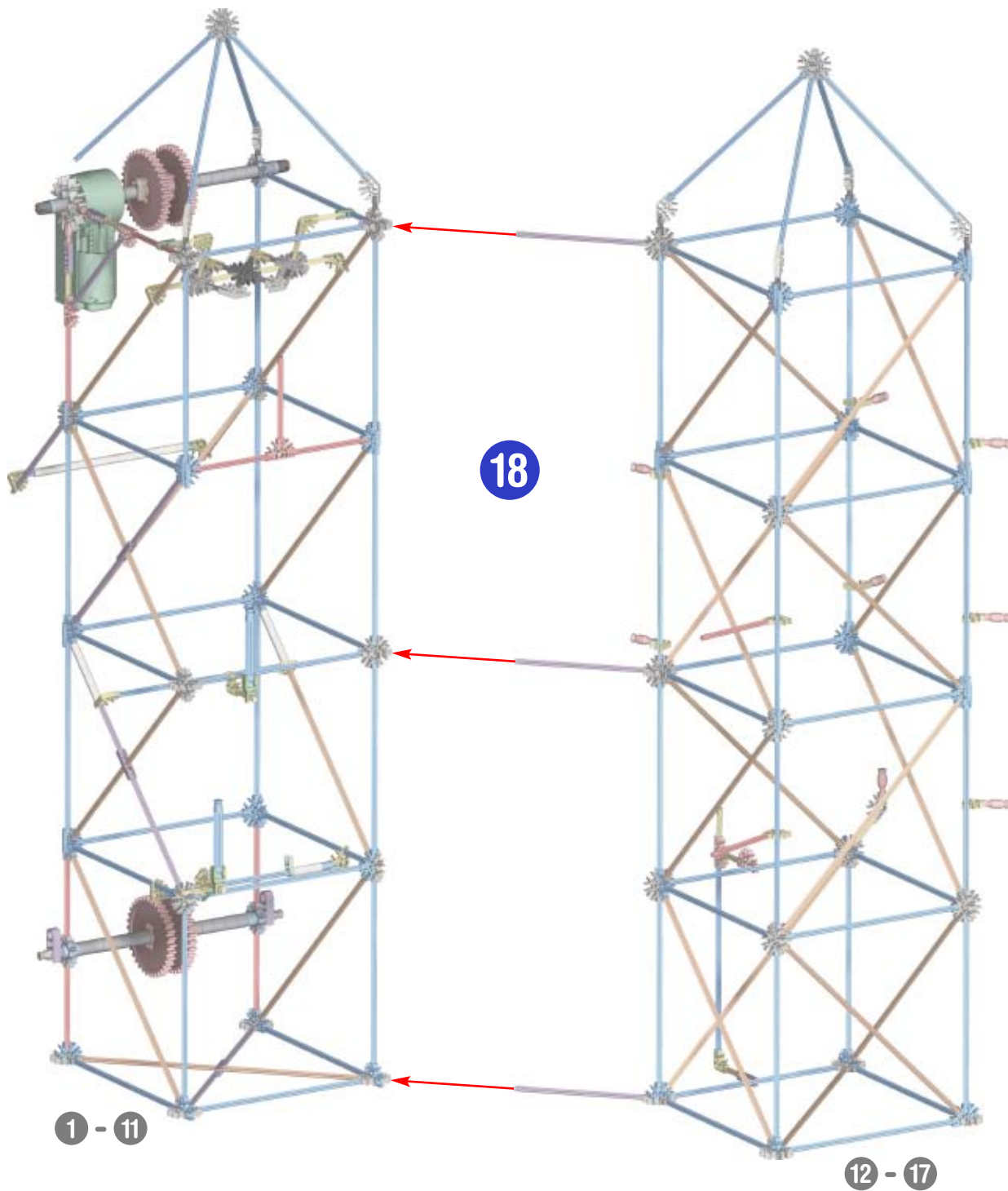

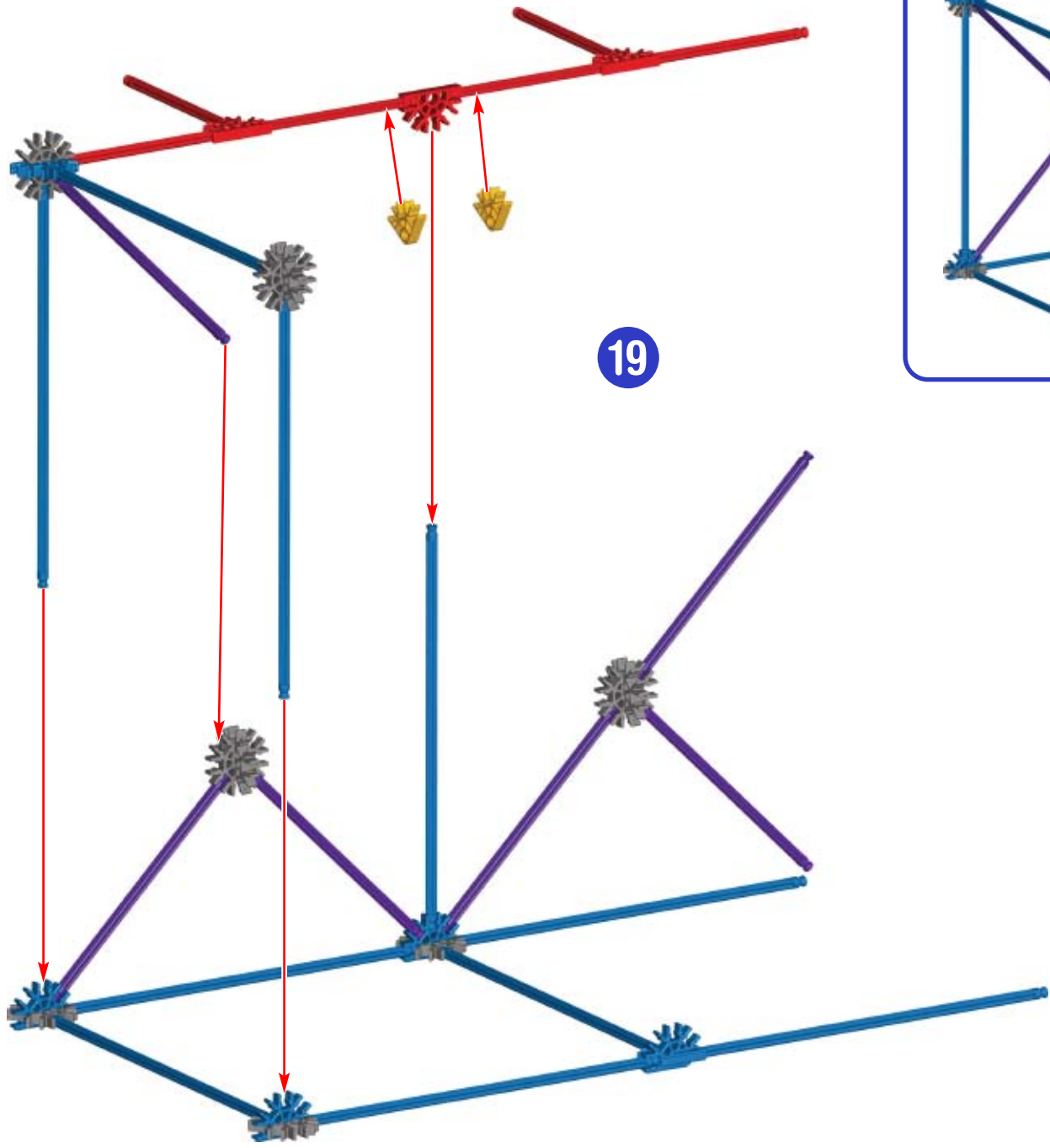

19

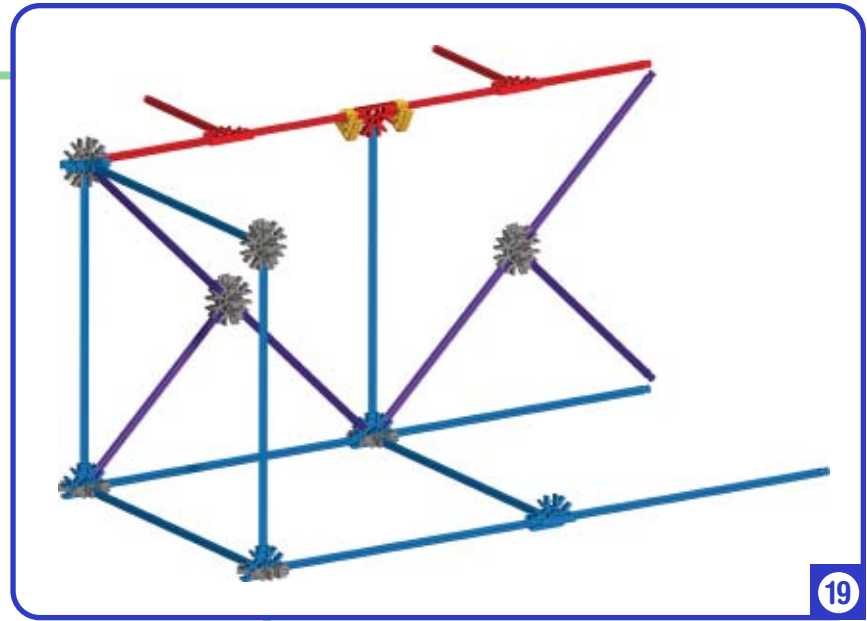

19

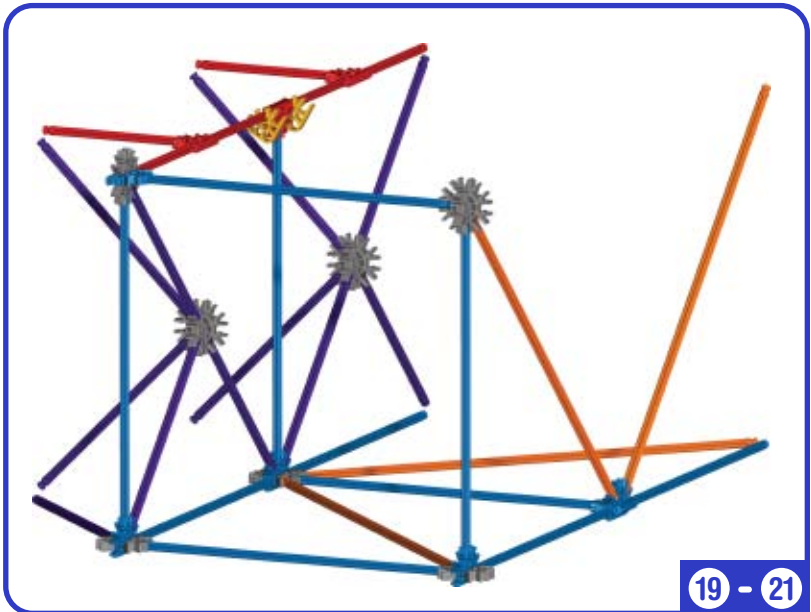
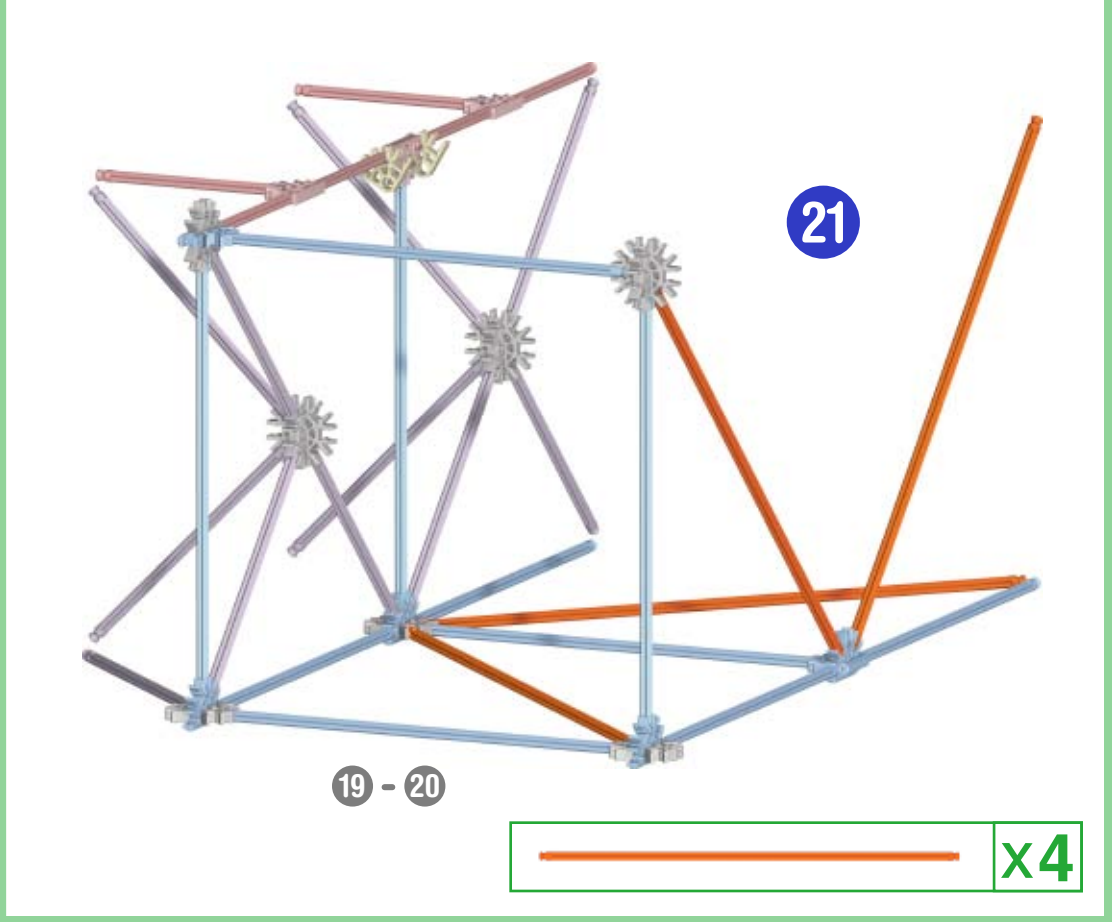
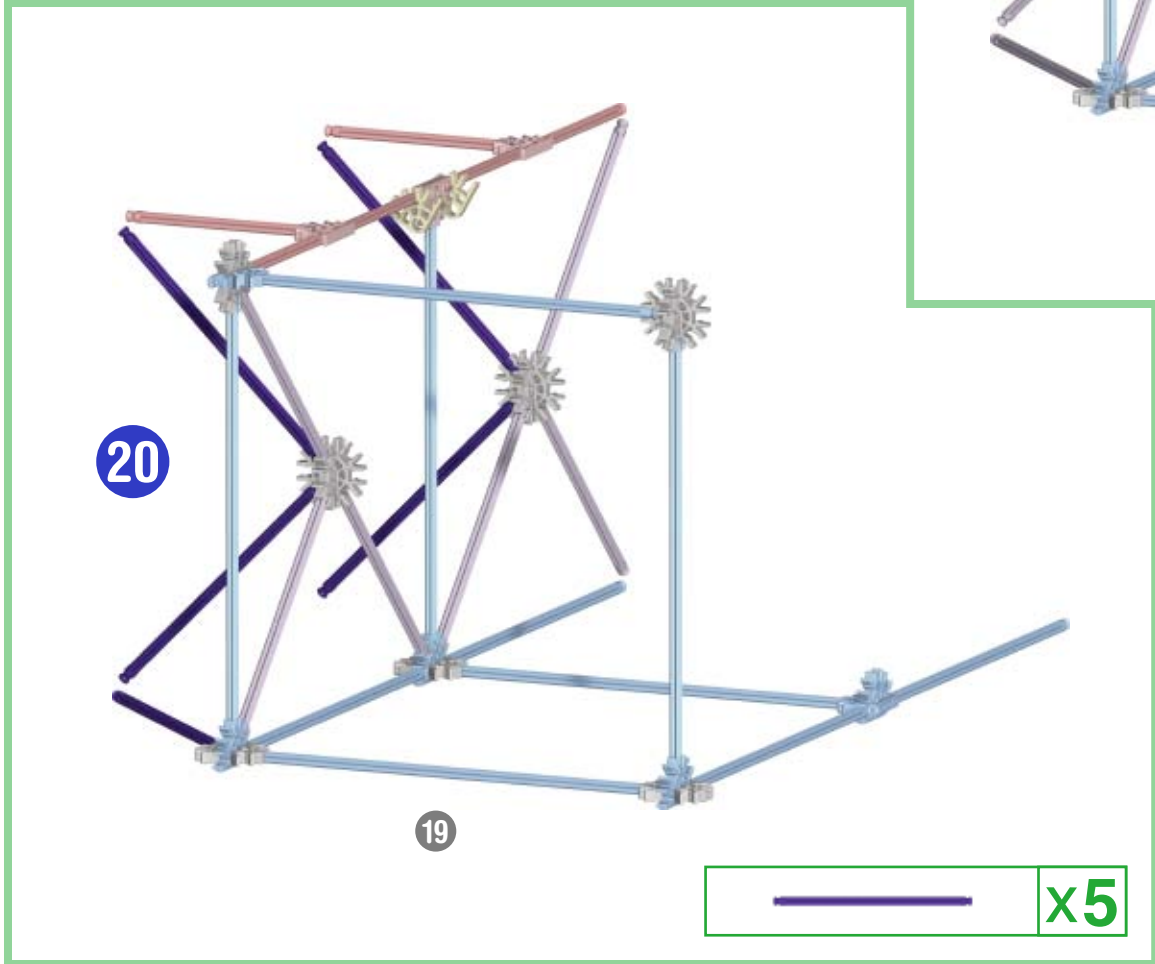

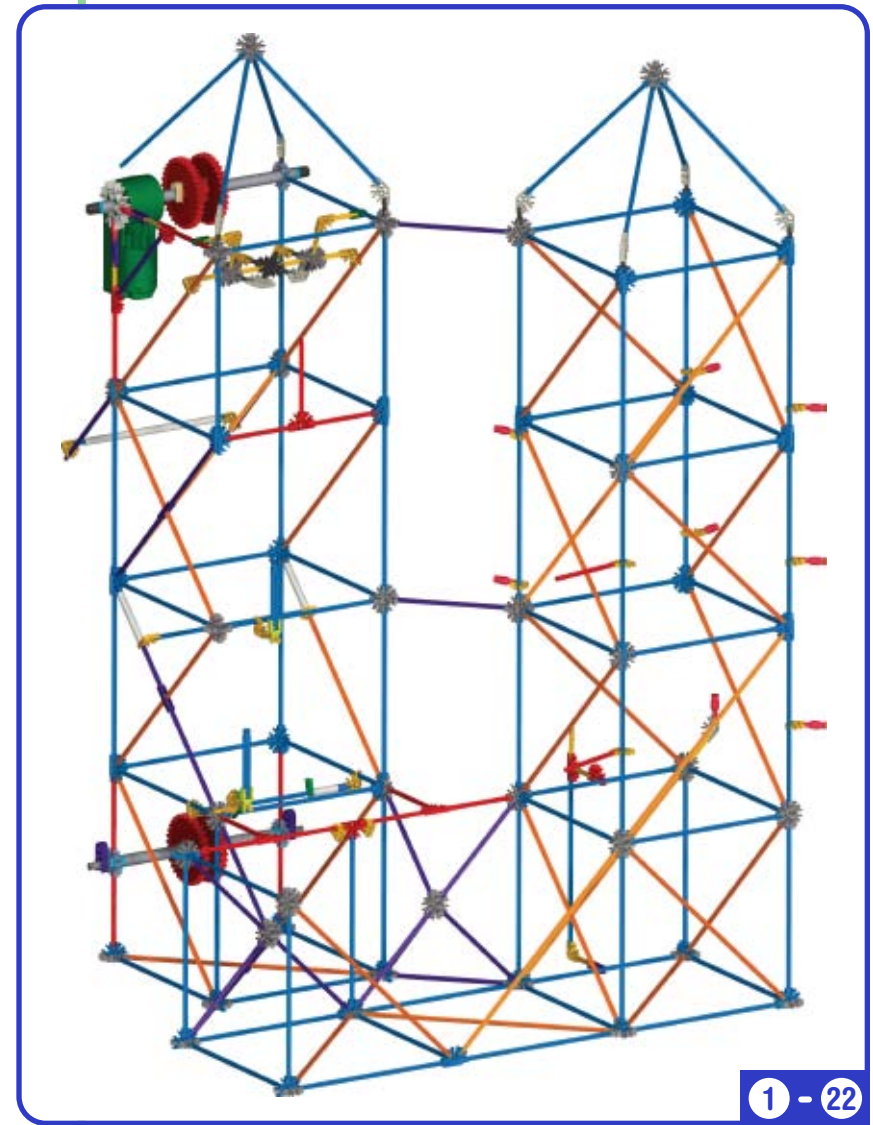
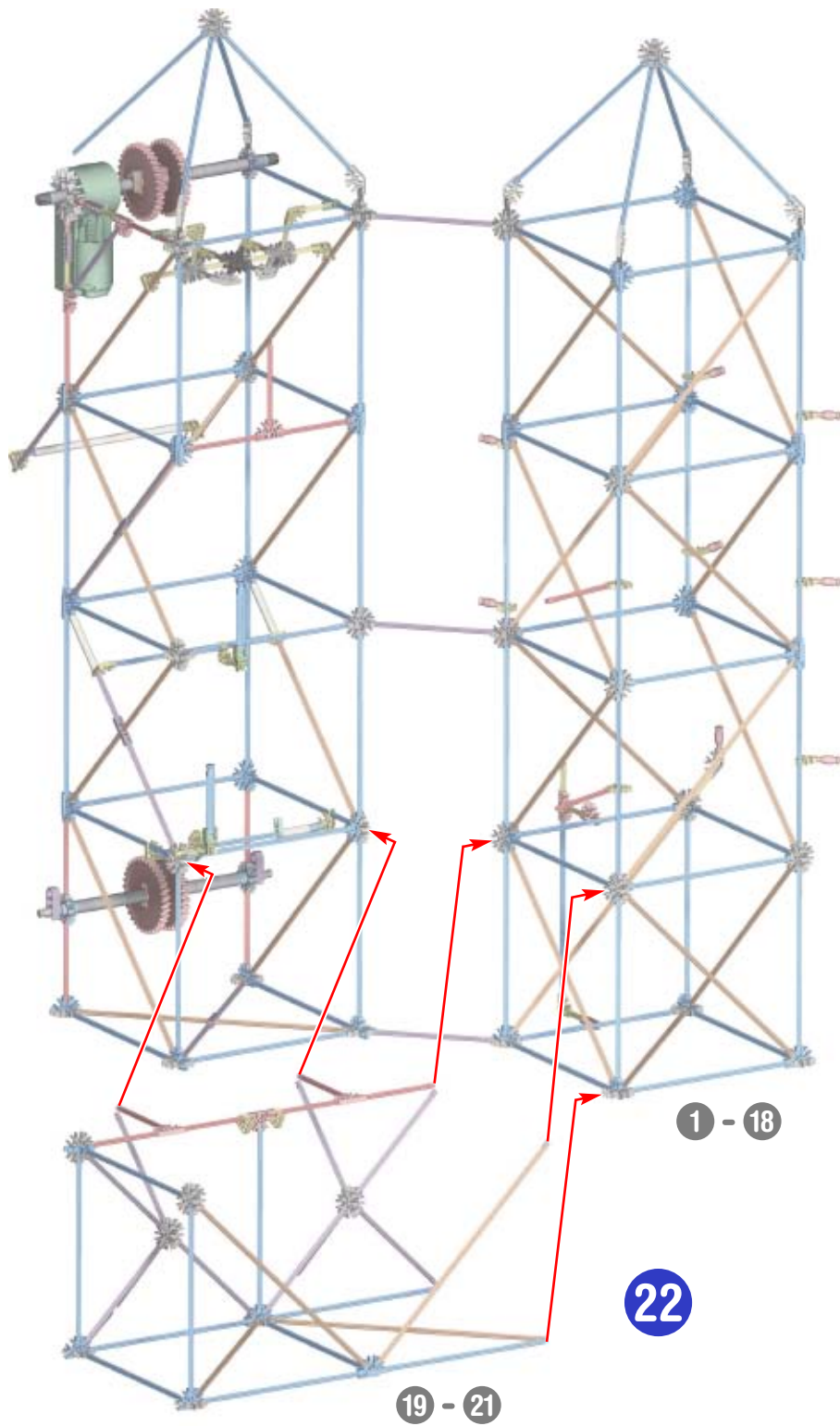

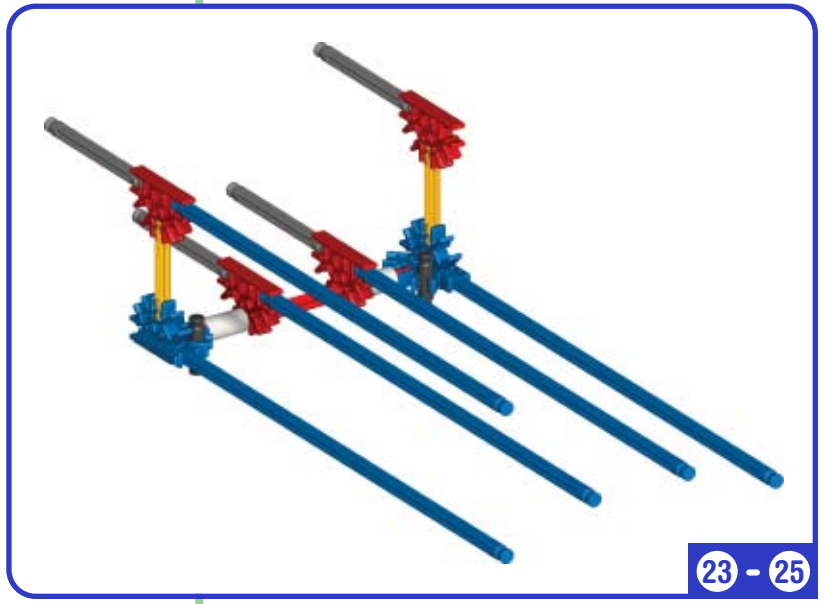
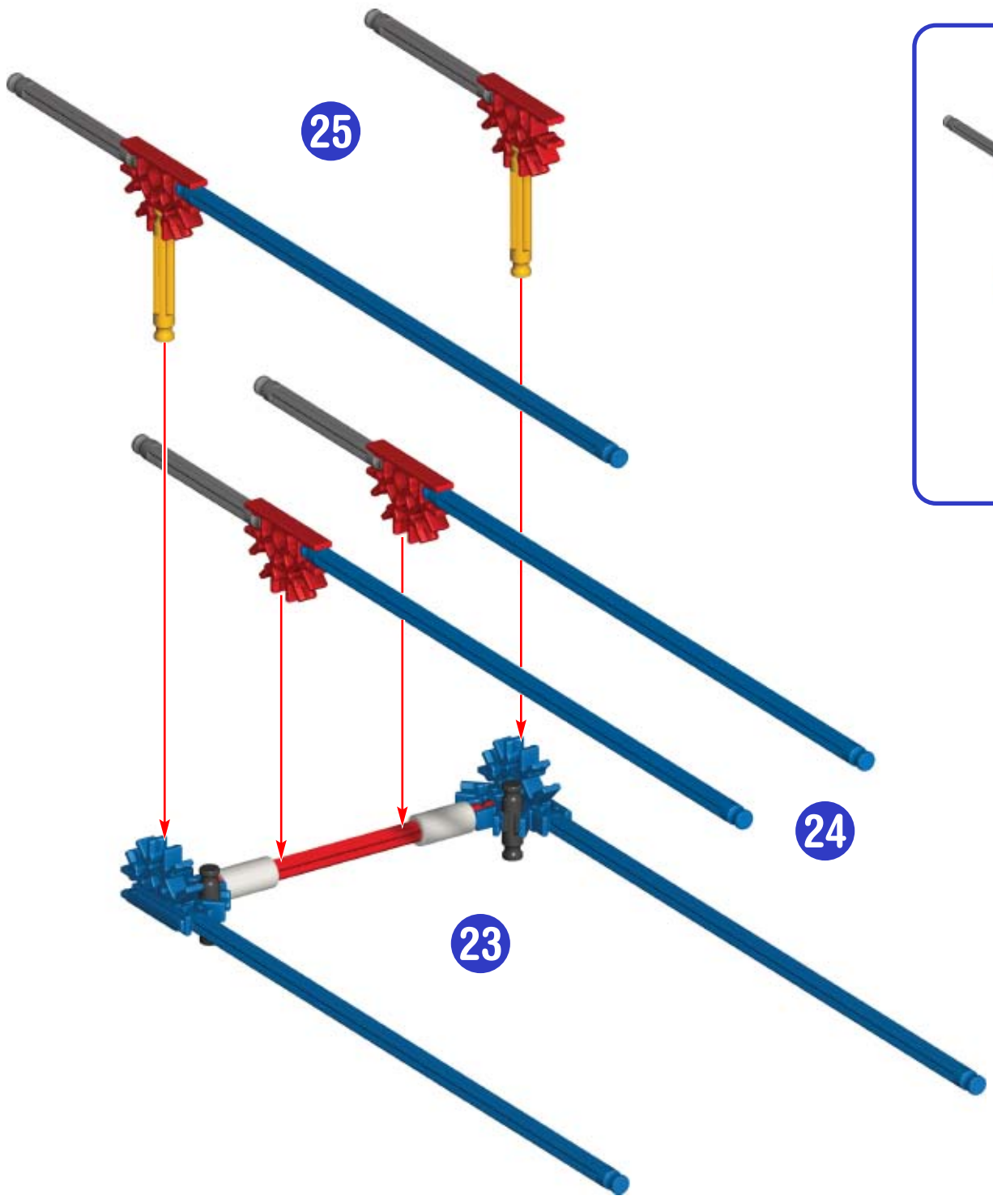

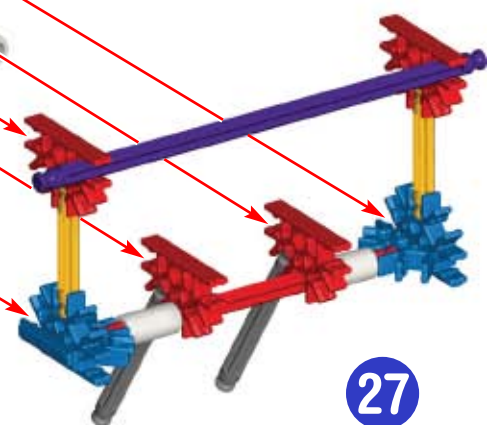
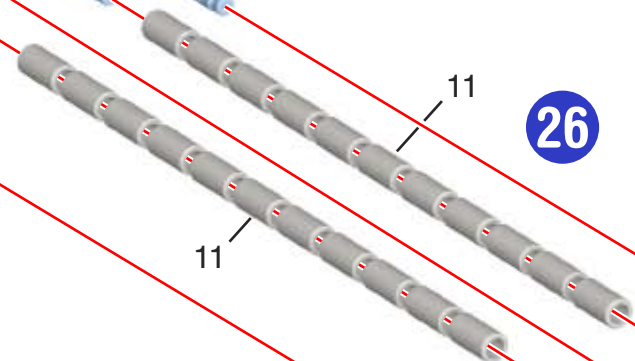
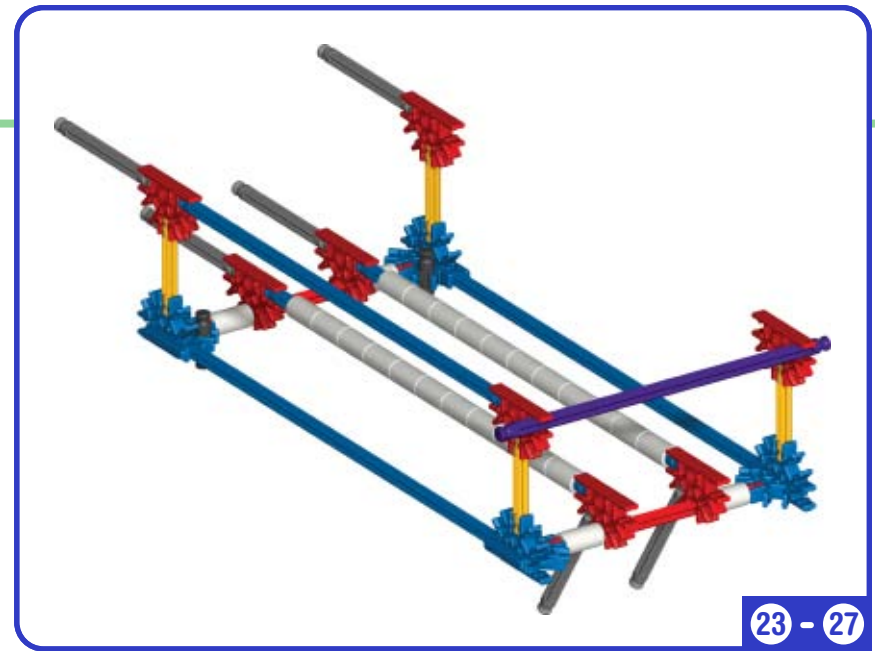
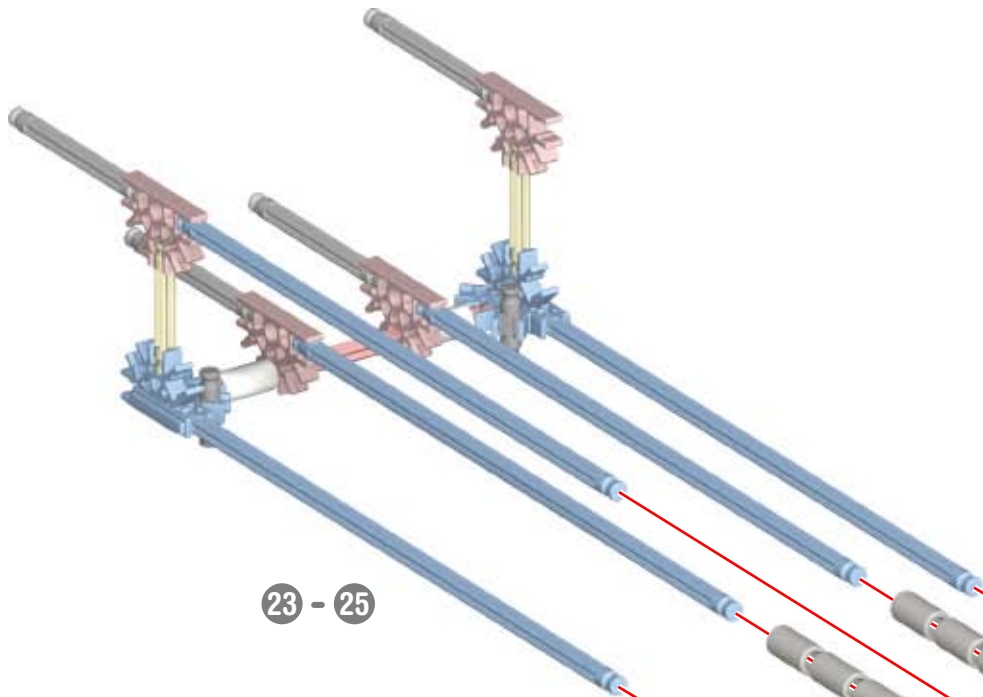

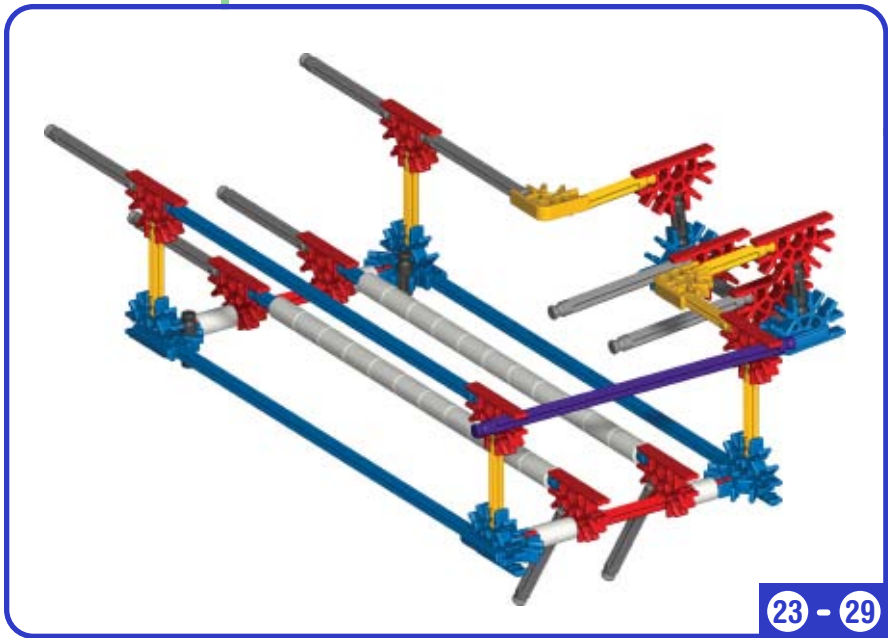
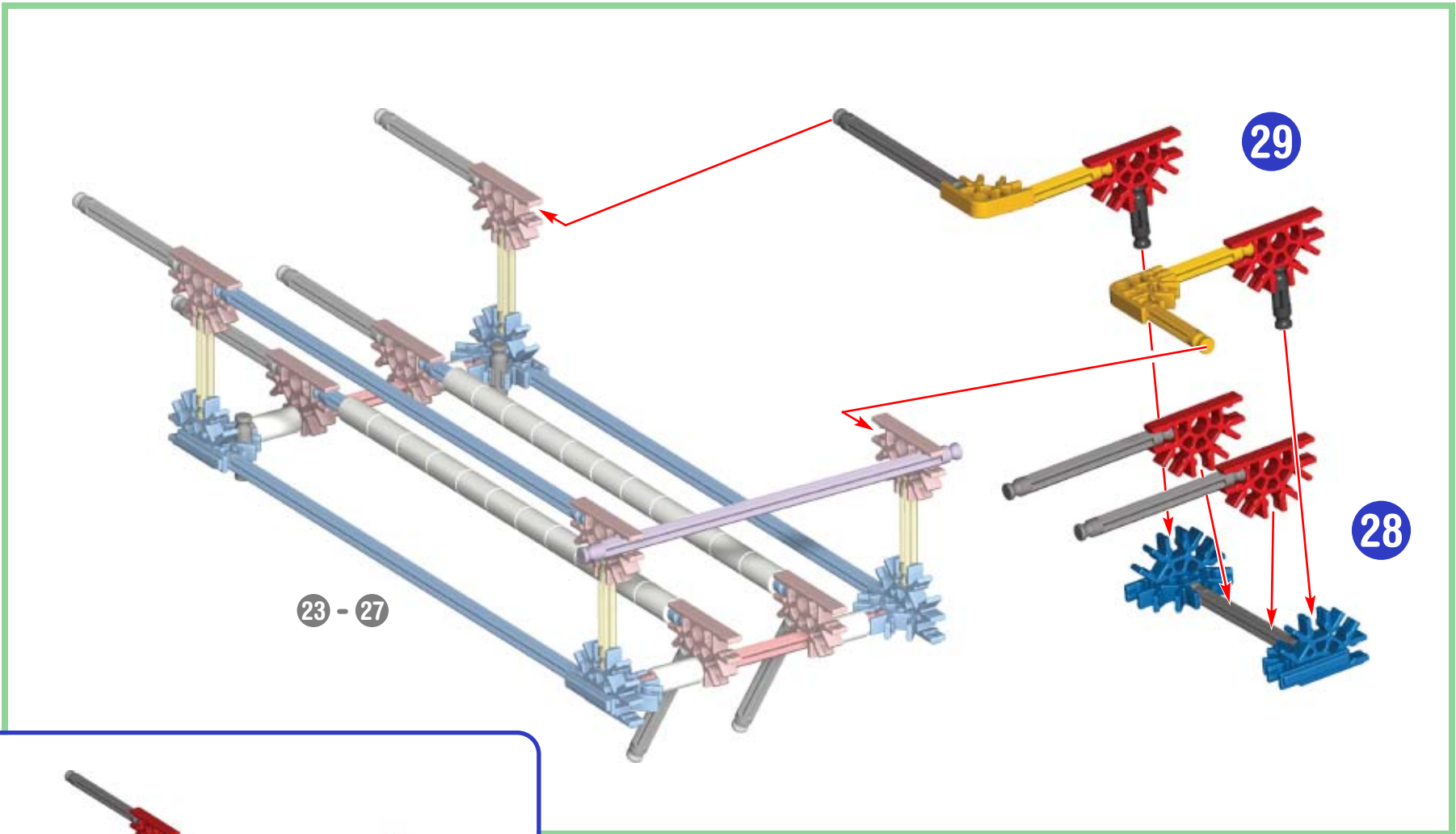

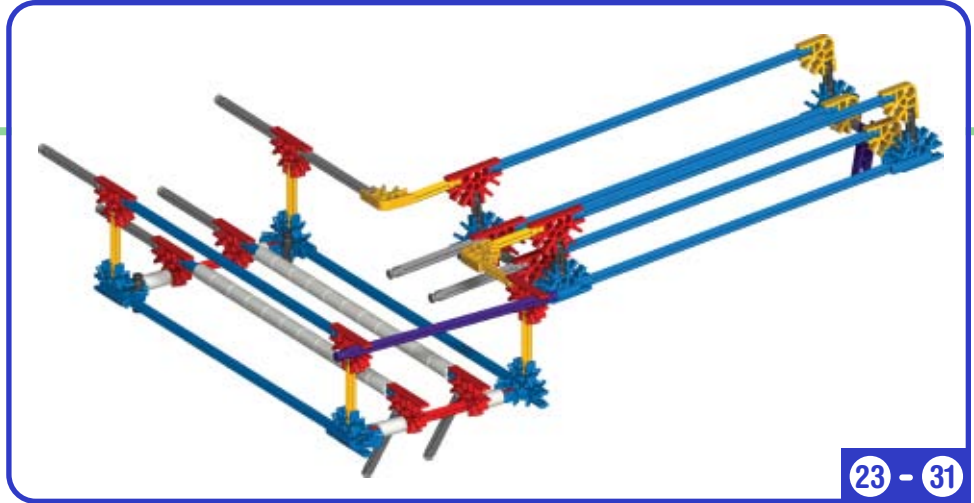
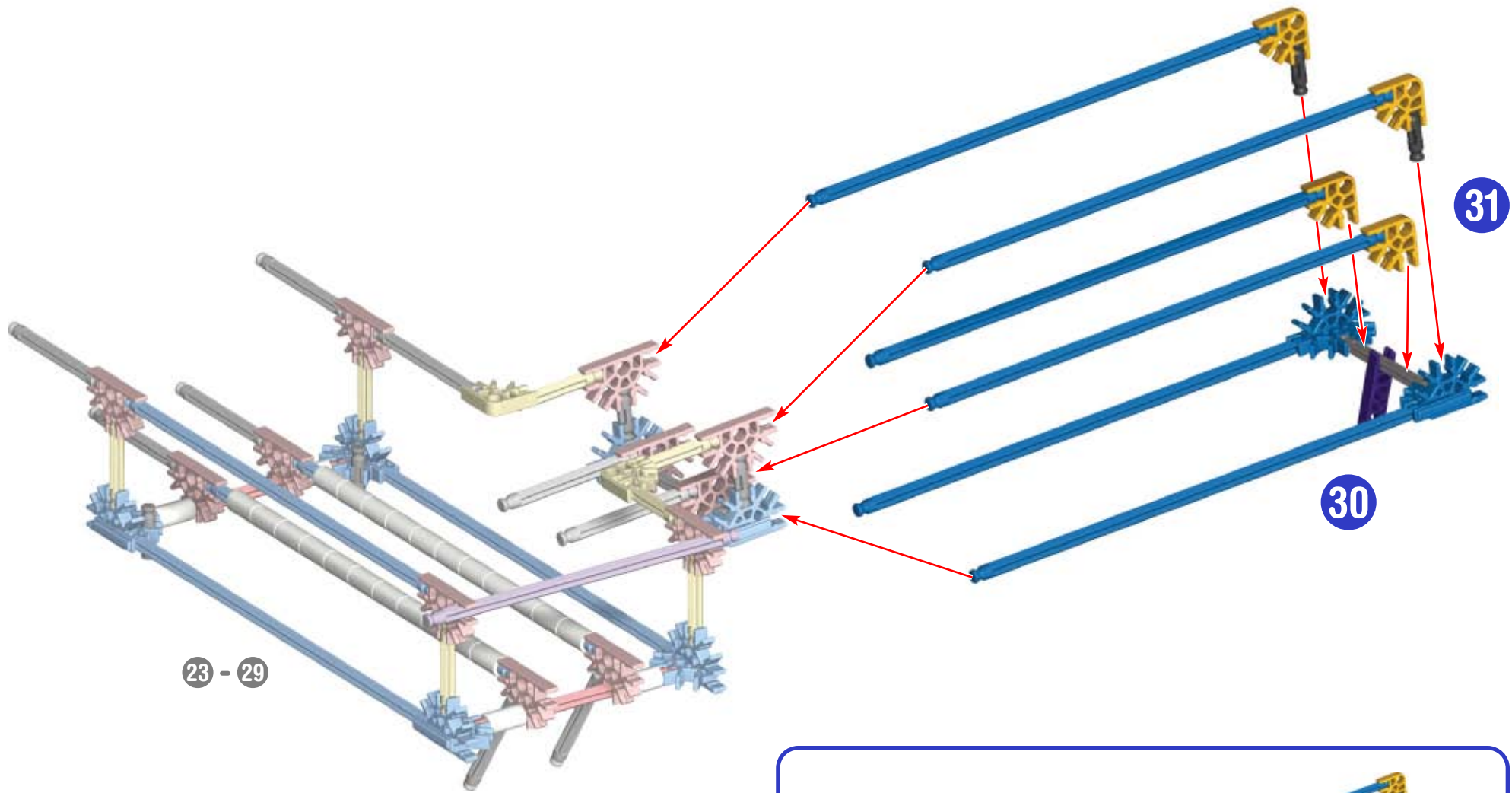

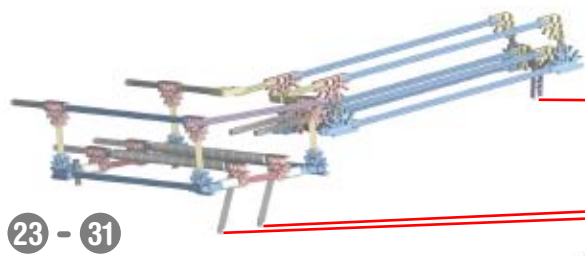
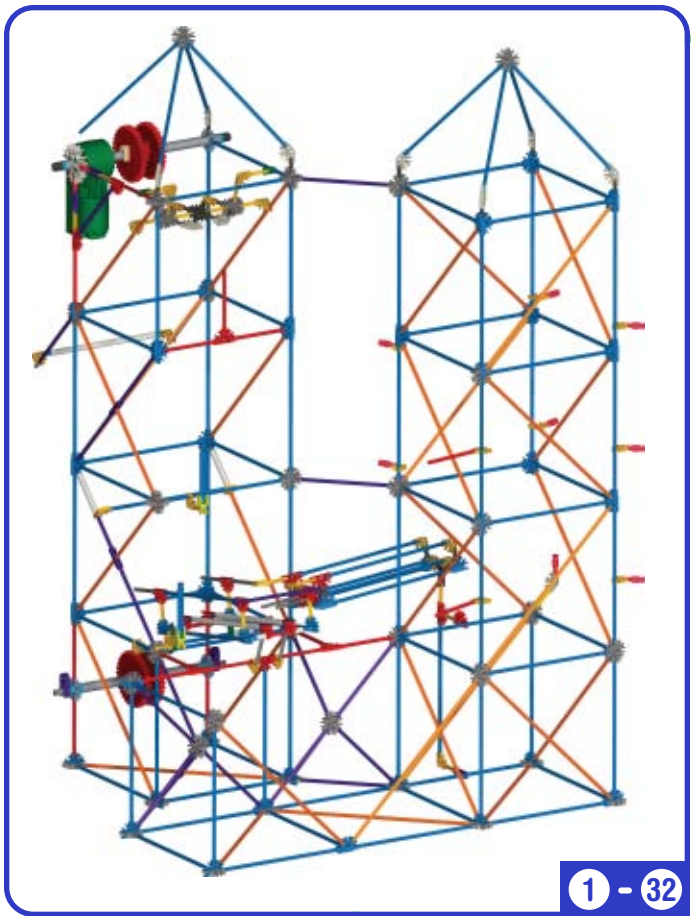

32

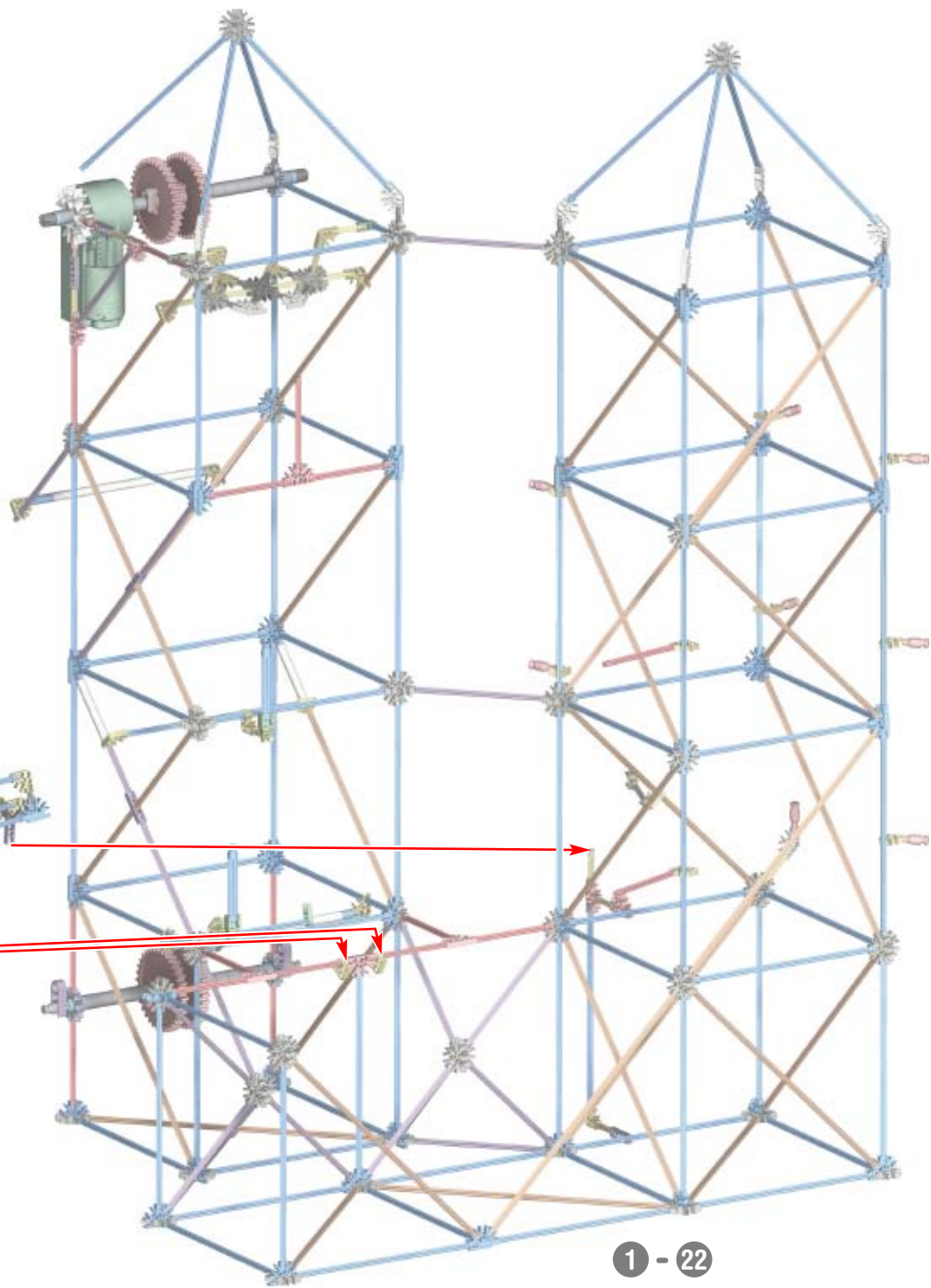

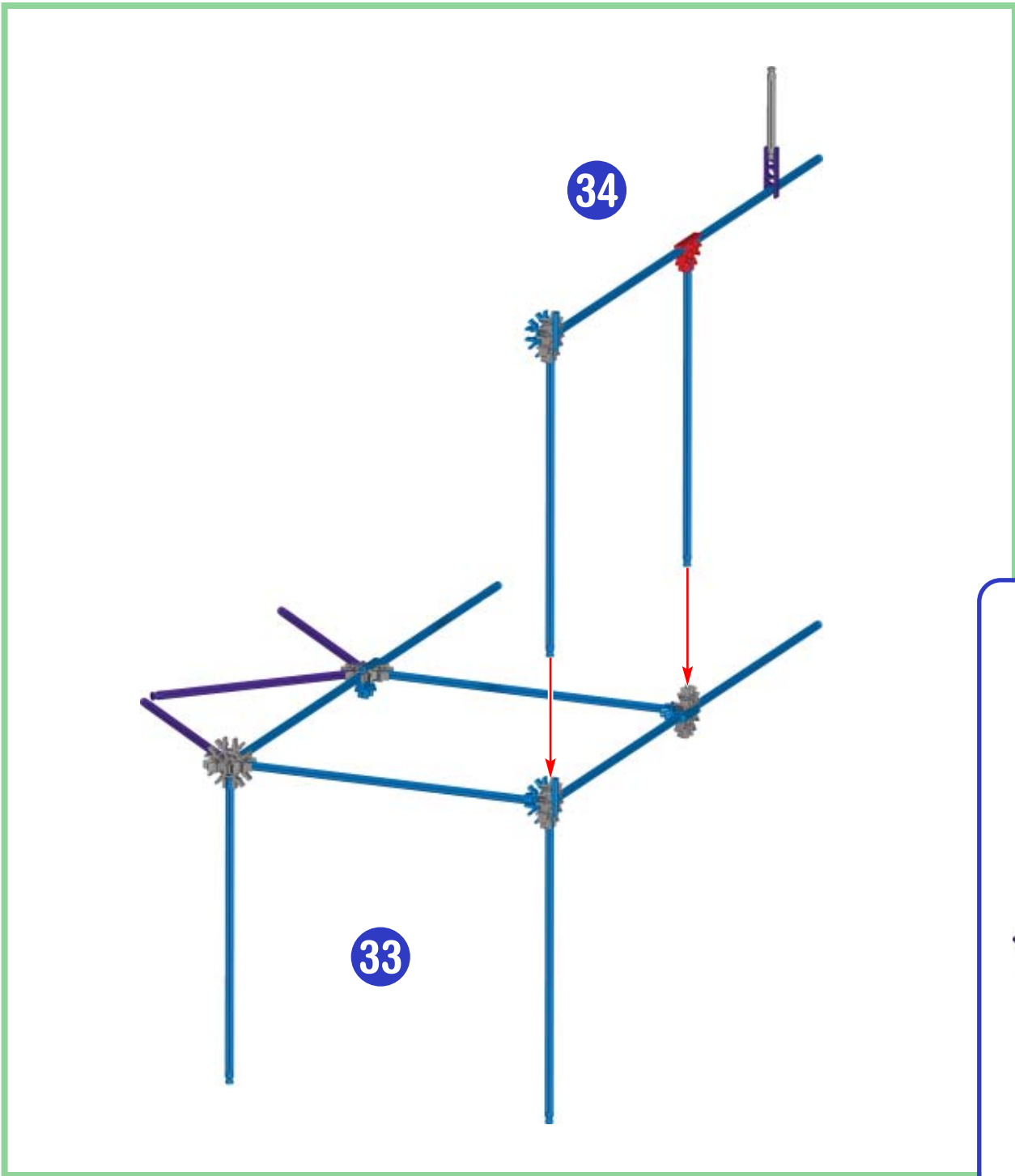

34

33

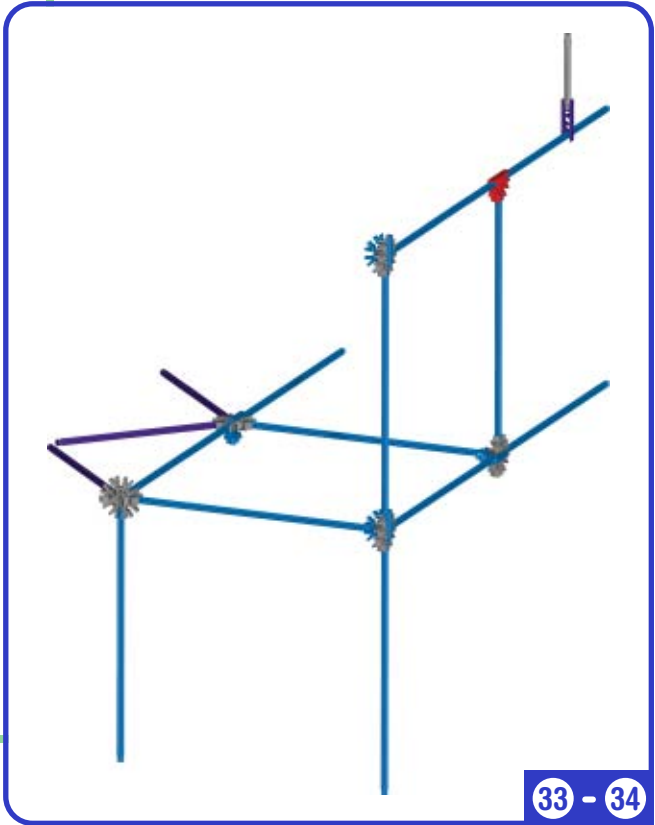

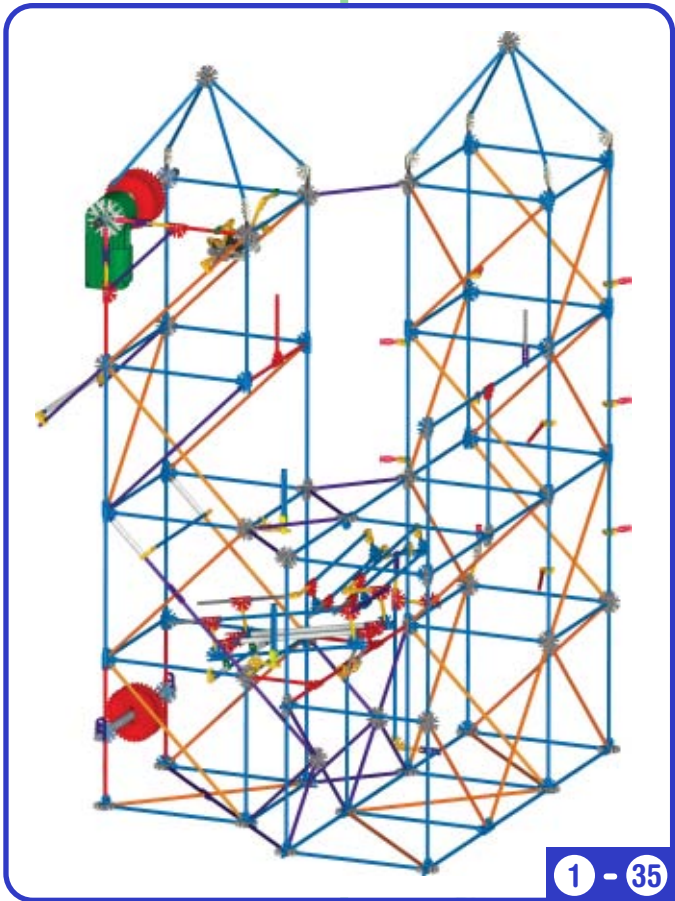

1 - 35

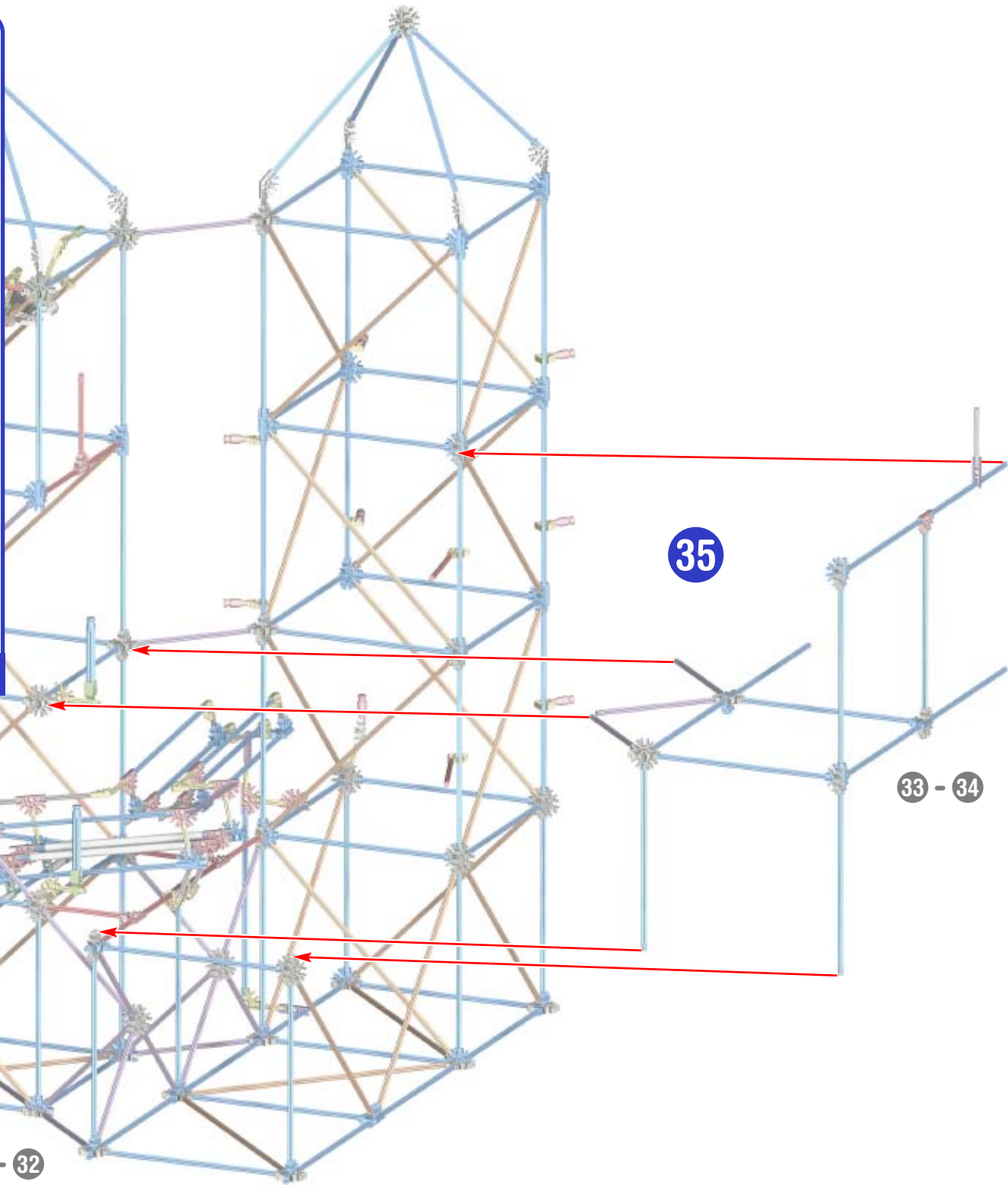

35

33 - 34

1 - 32

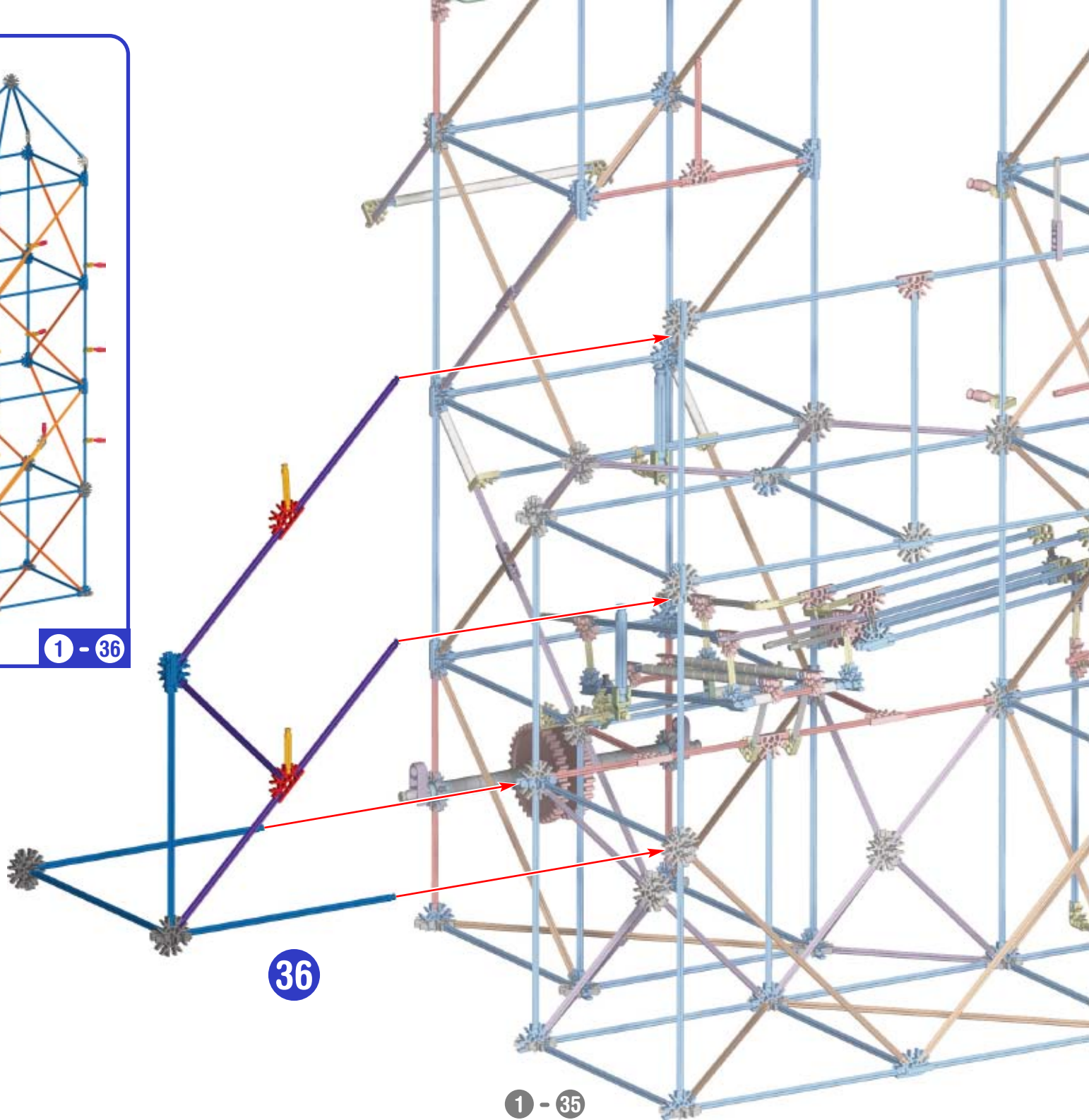
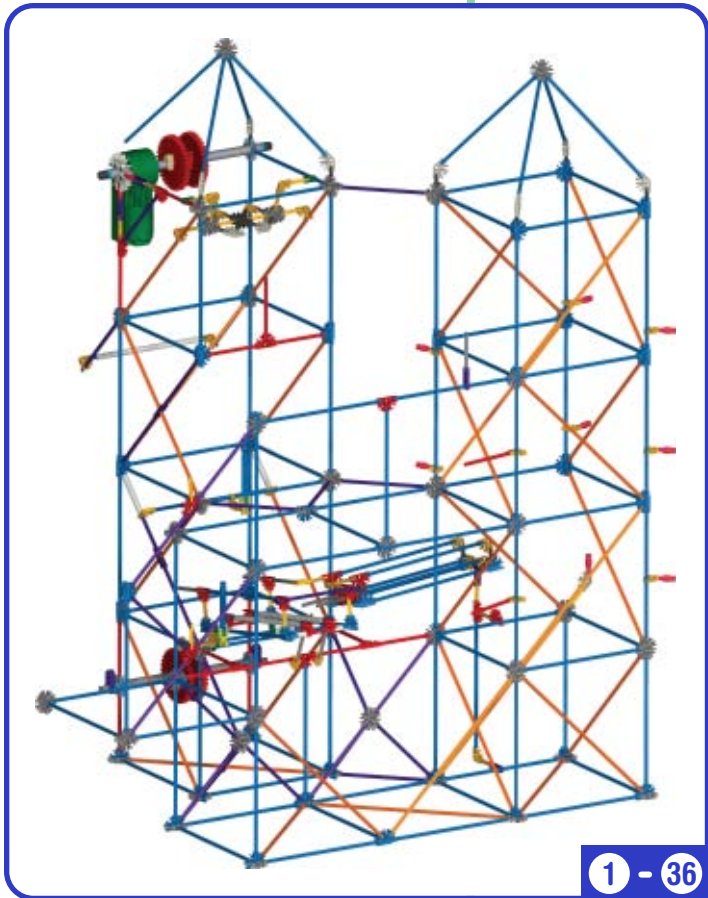

37

1 - 36

x6

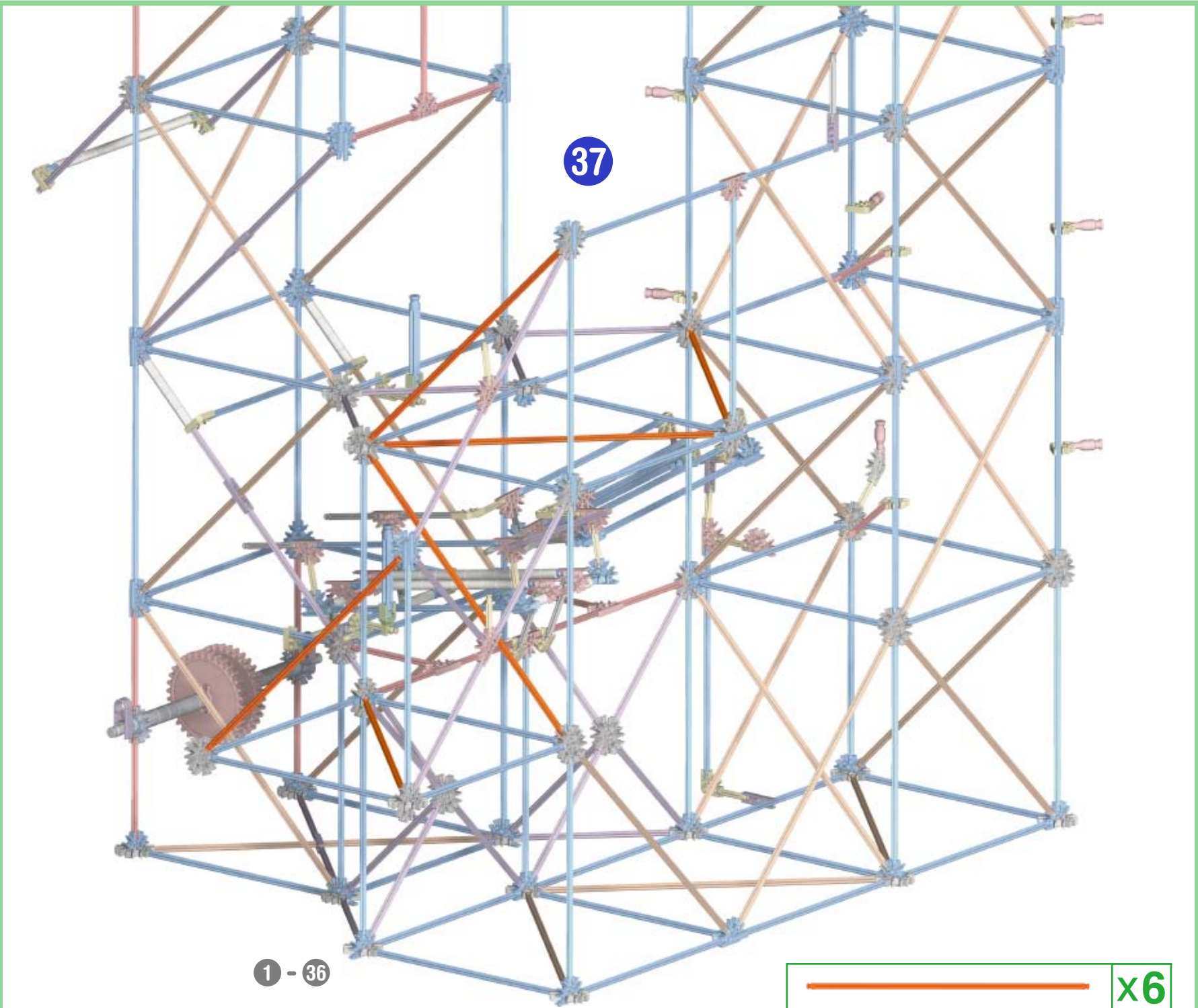

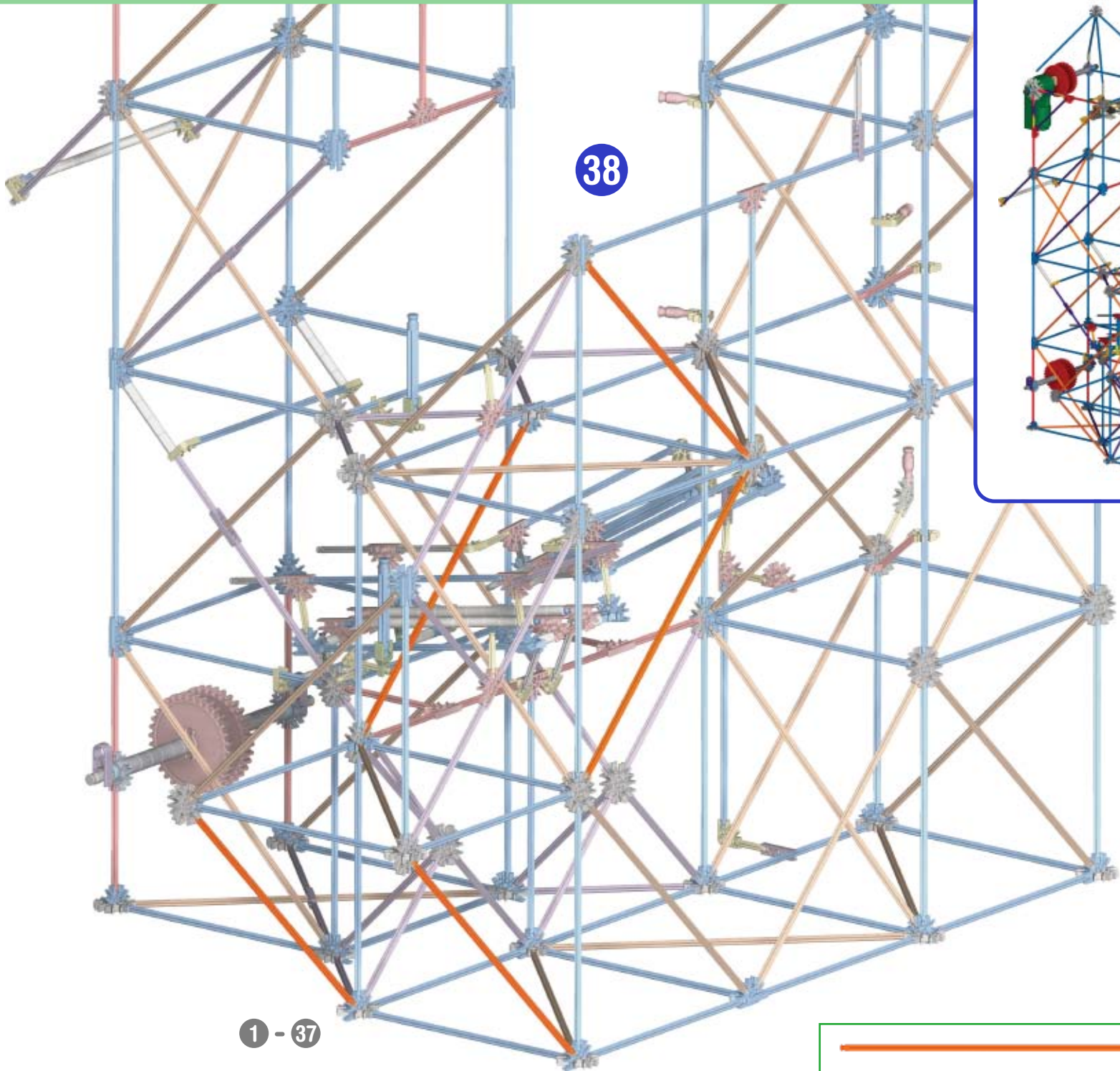

38

1 - 37

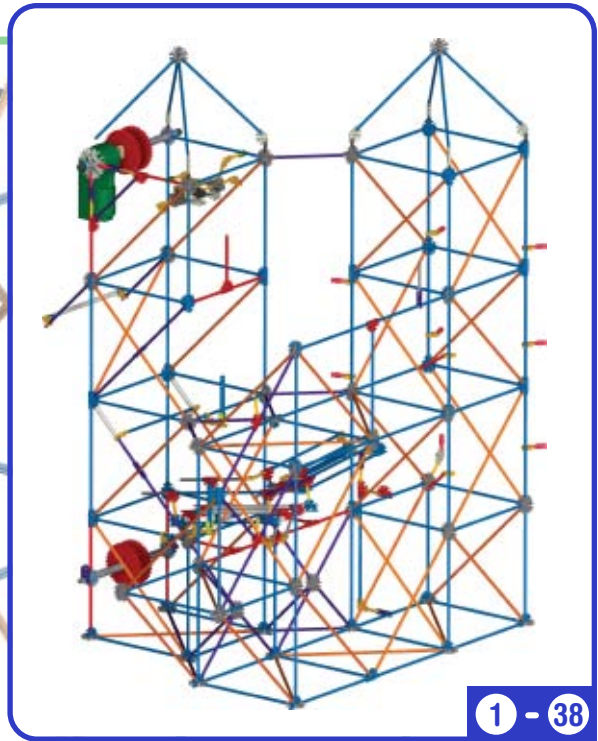

1 - 38



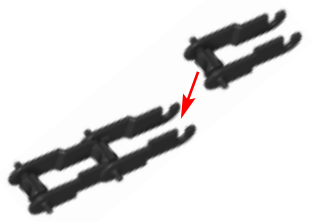

IMPORTANT:
Attach all the chain links
in the same direction.

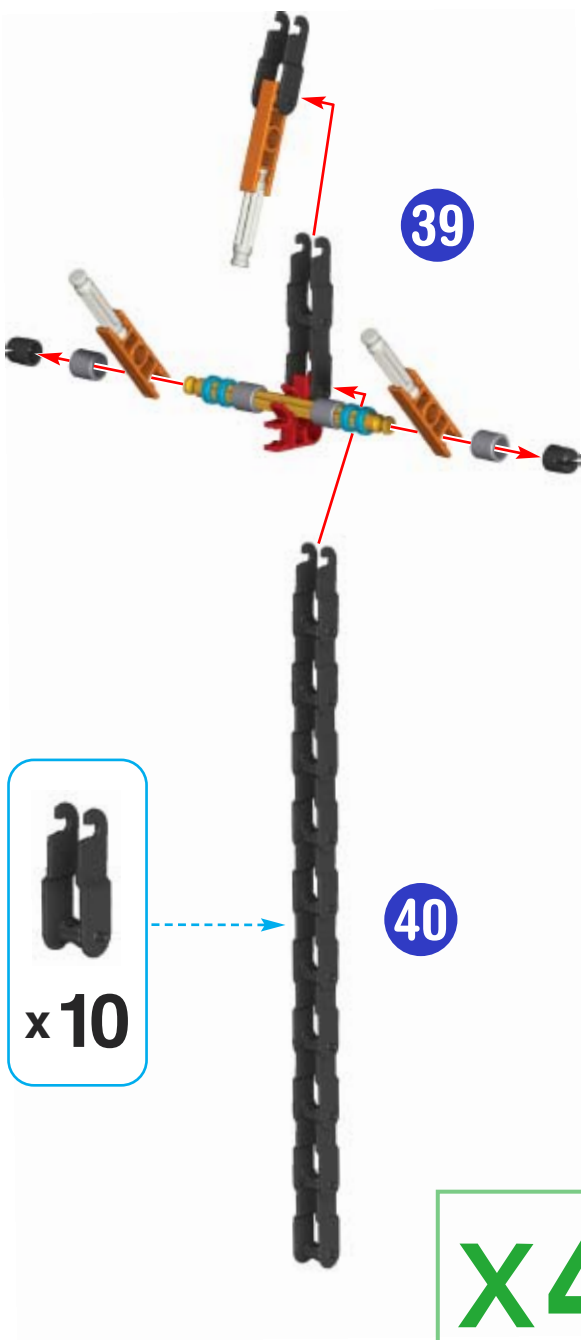

39

40

x 10

x 4

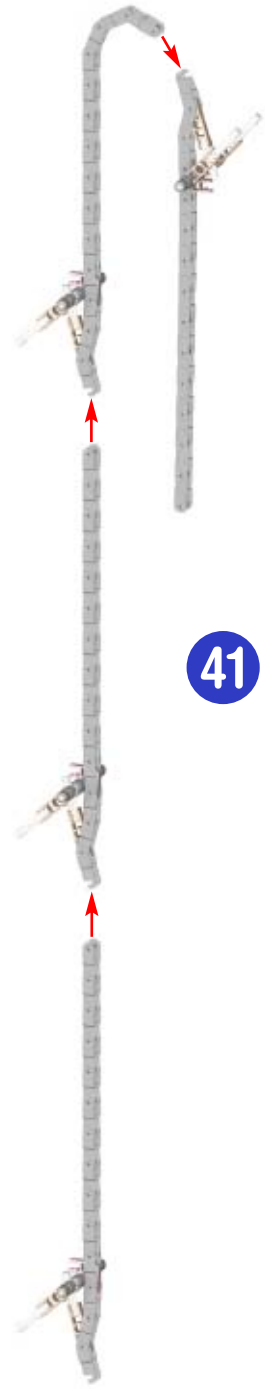

41

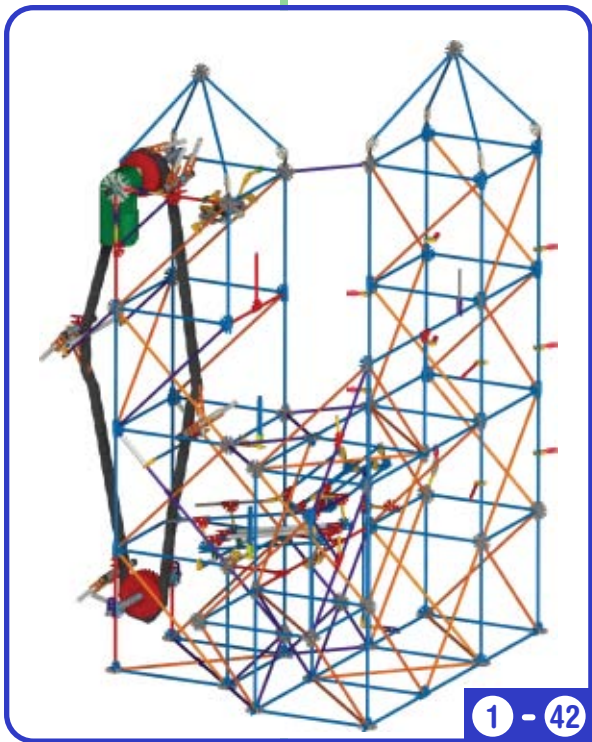

39 - 41

42

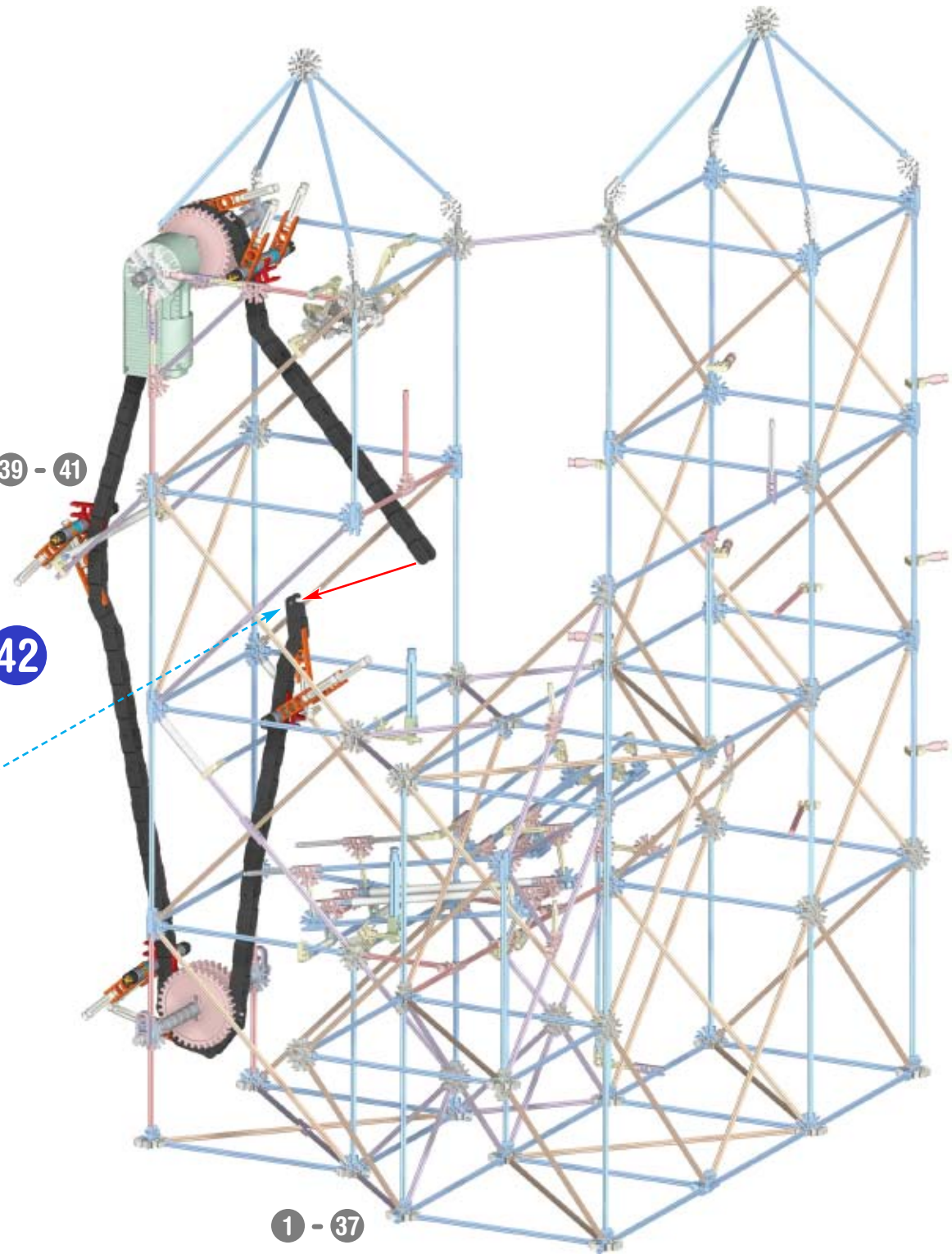

IMPORTANT:
Make sure the
chain faces in
this direction.

1 - 37

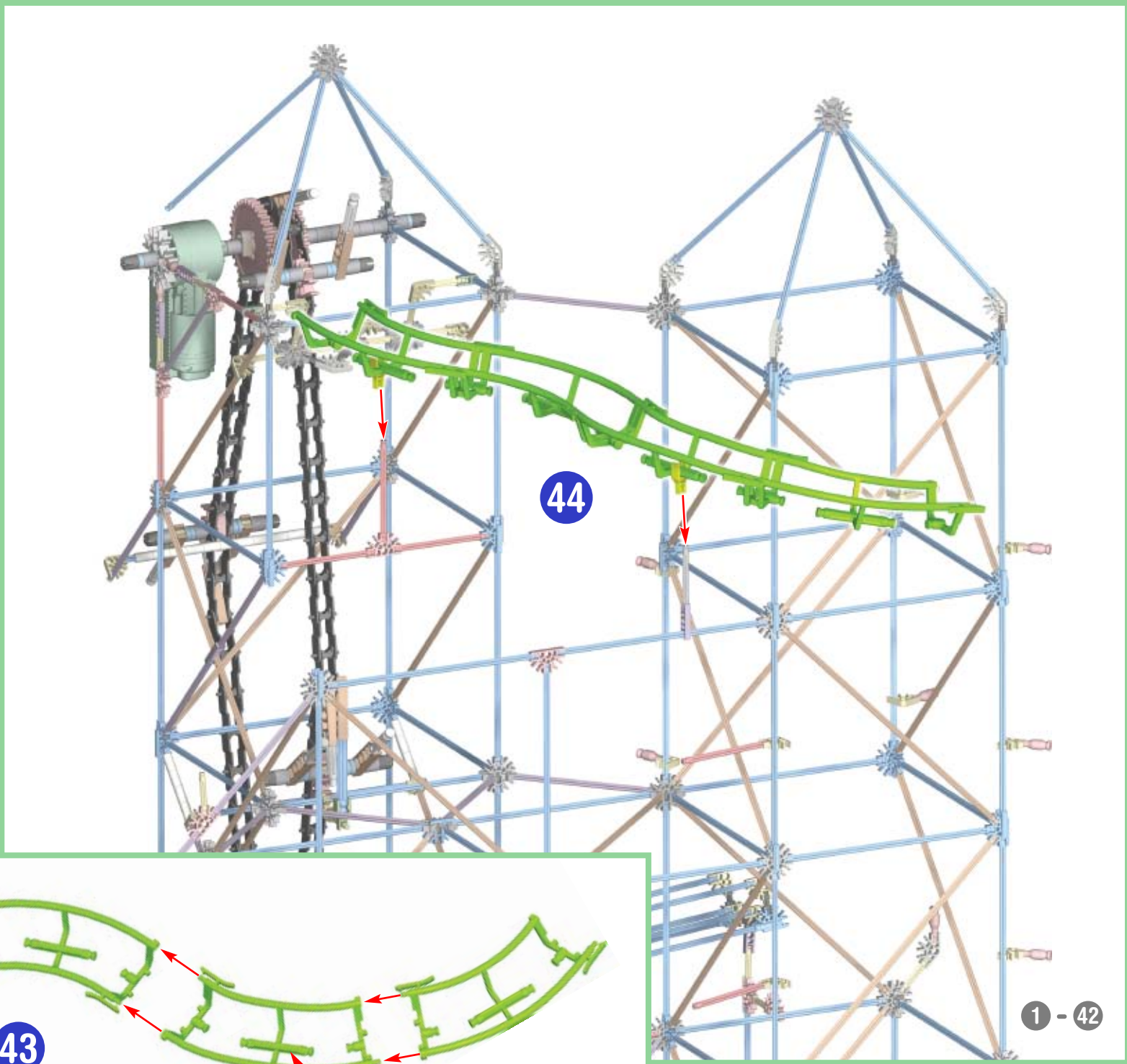
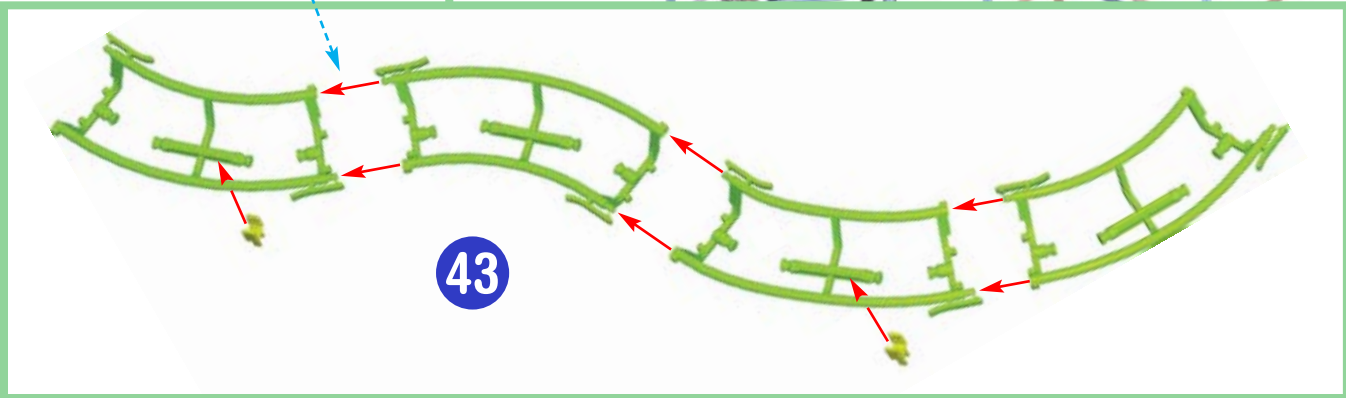
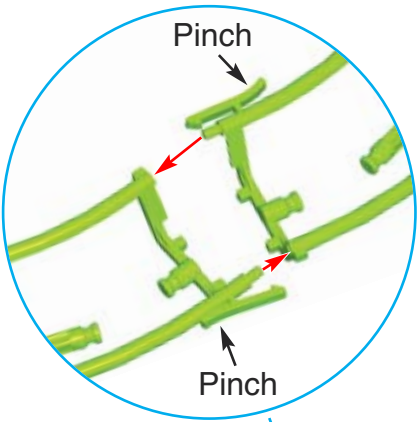

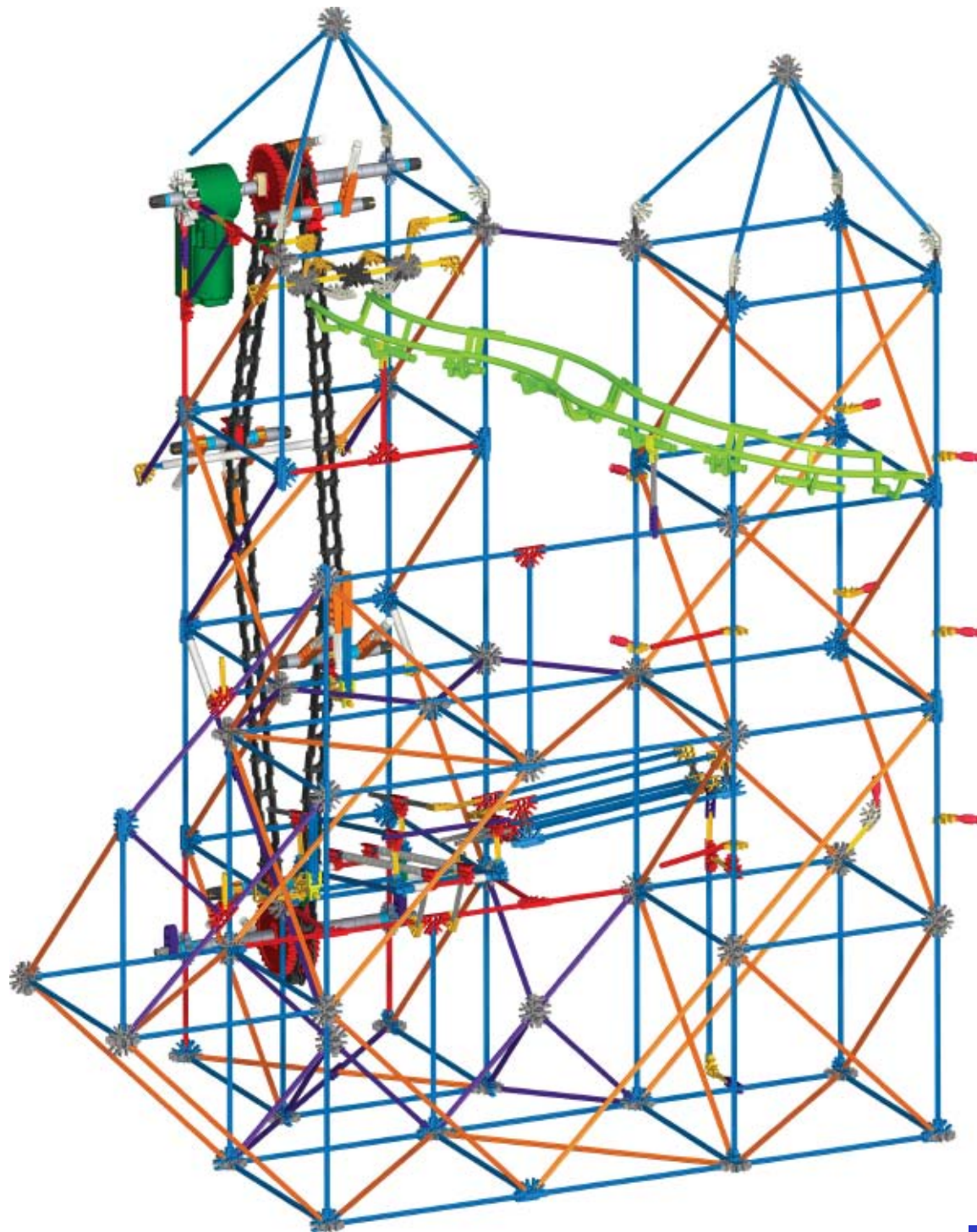

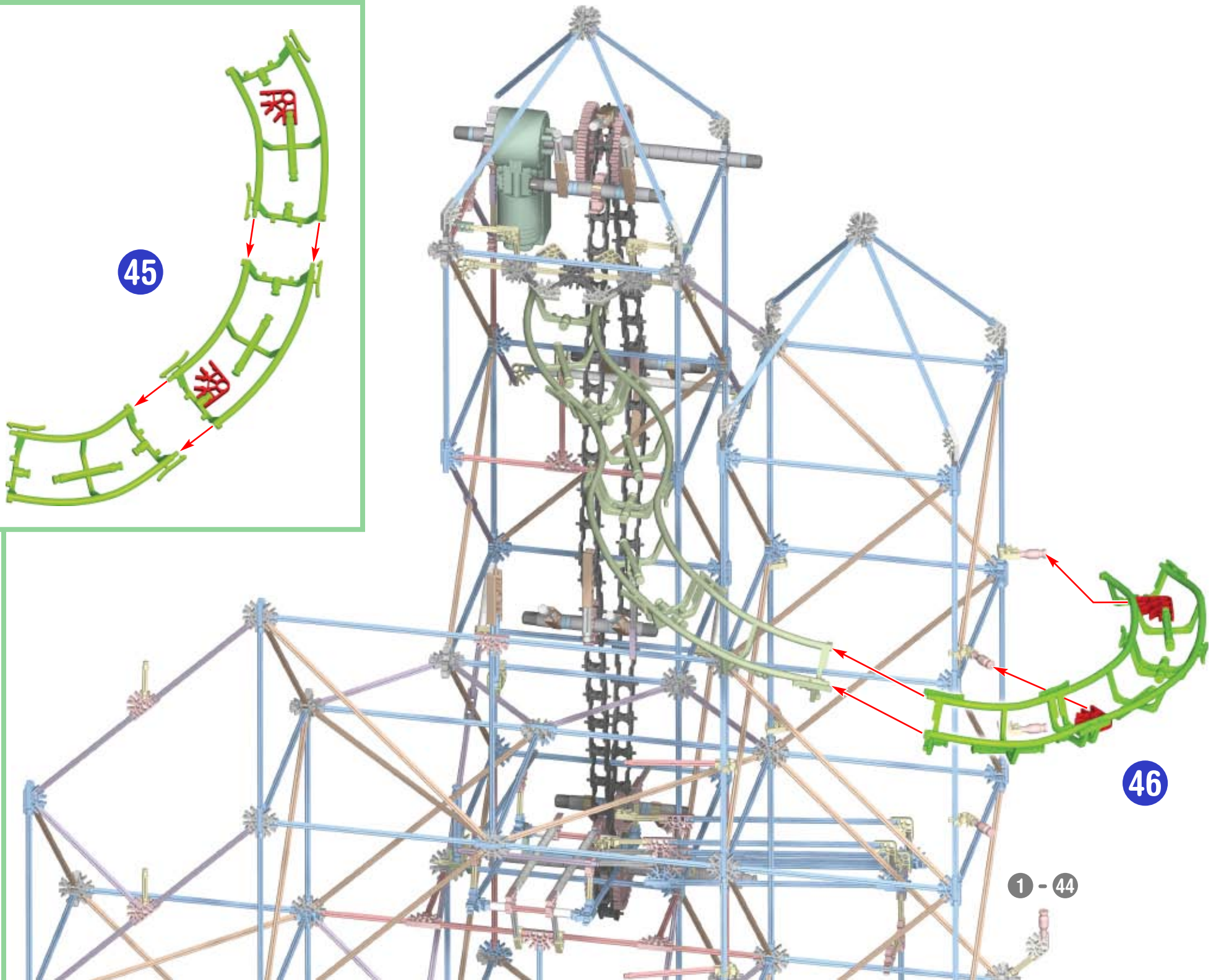
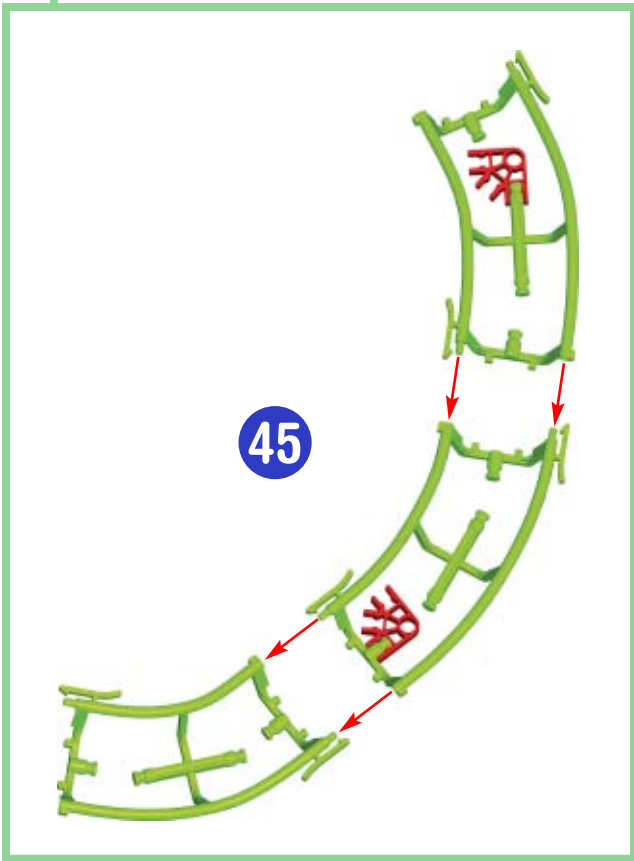

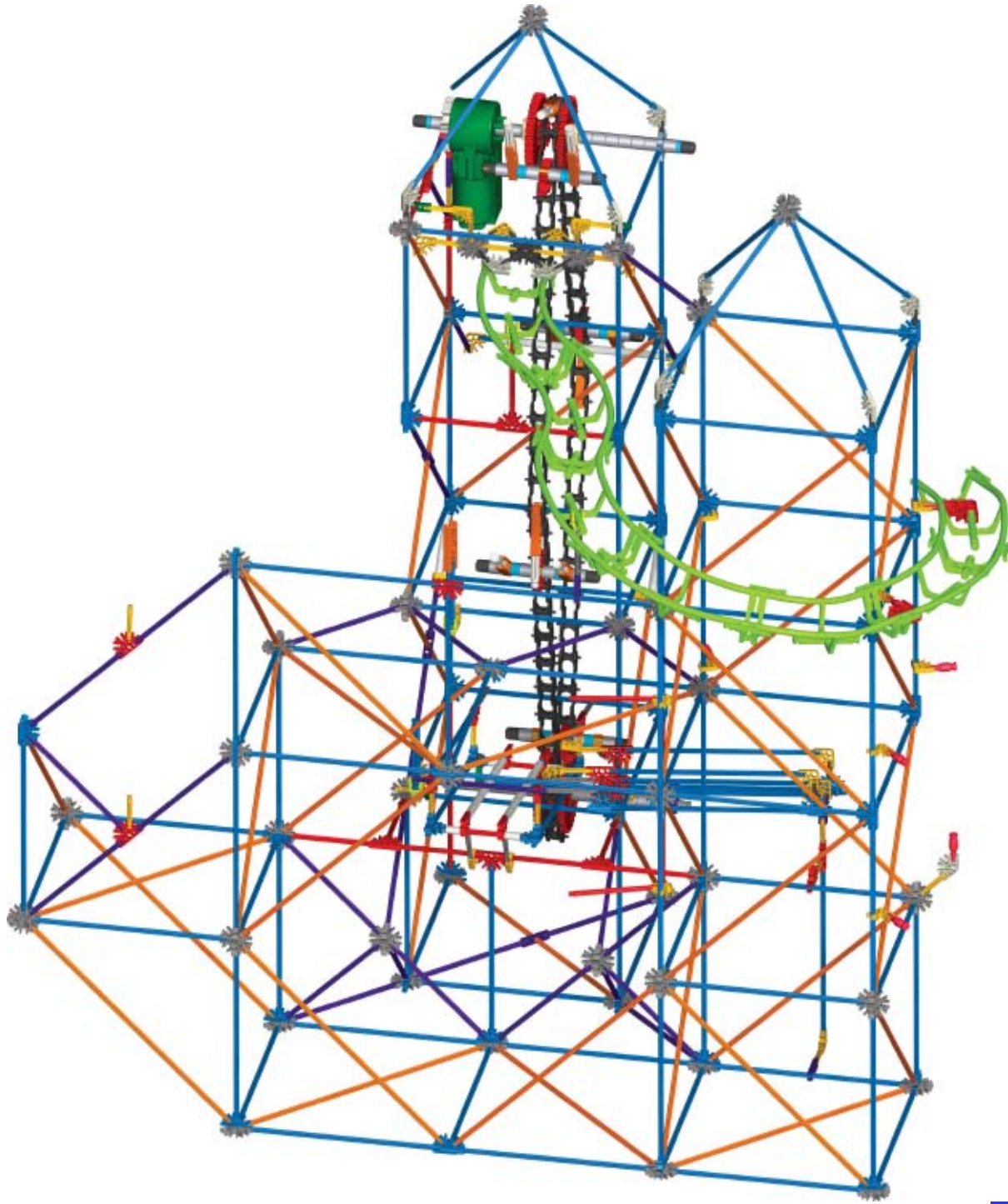

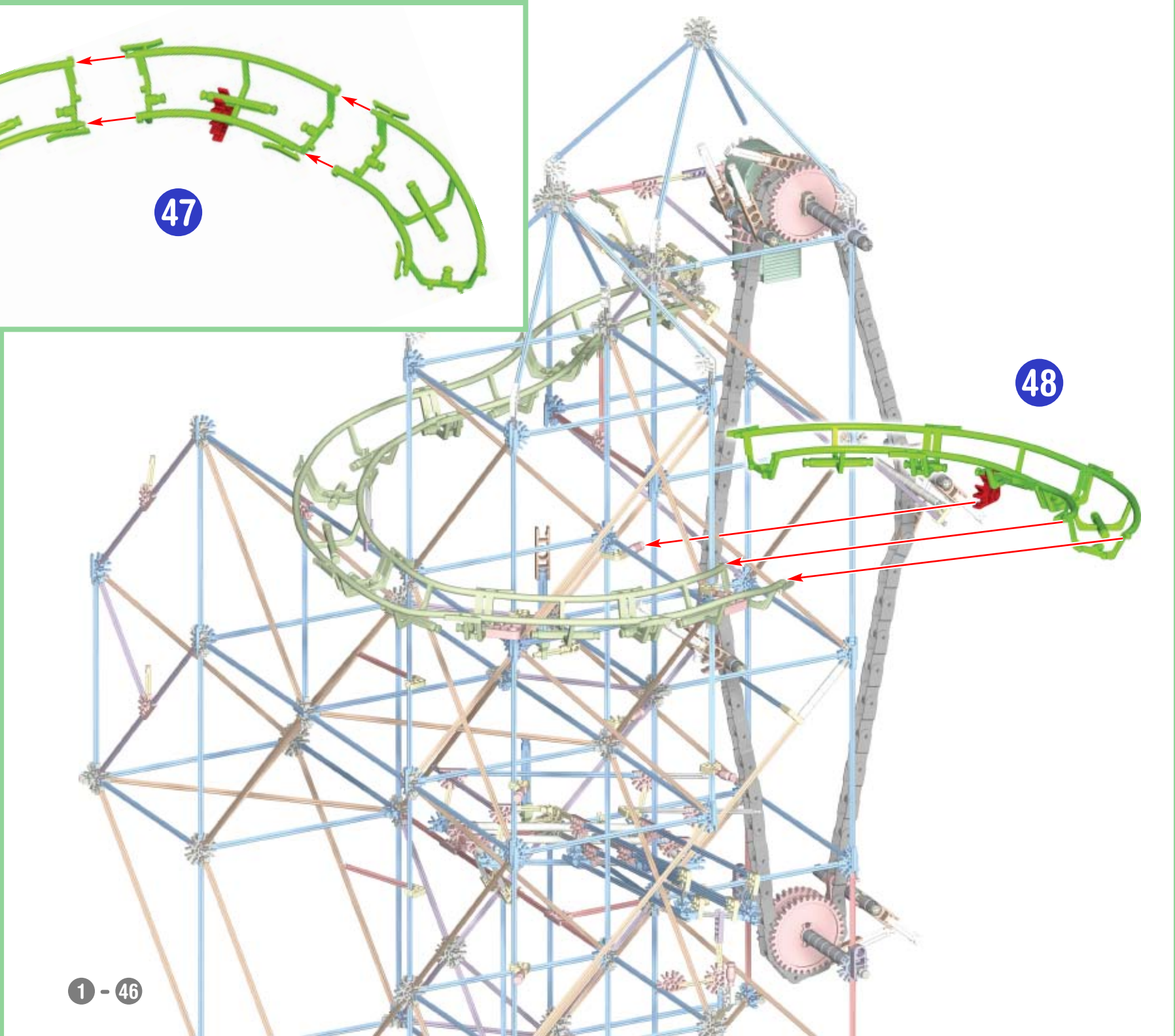
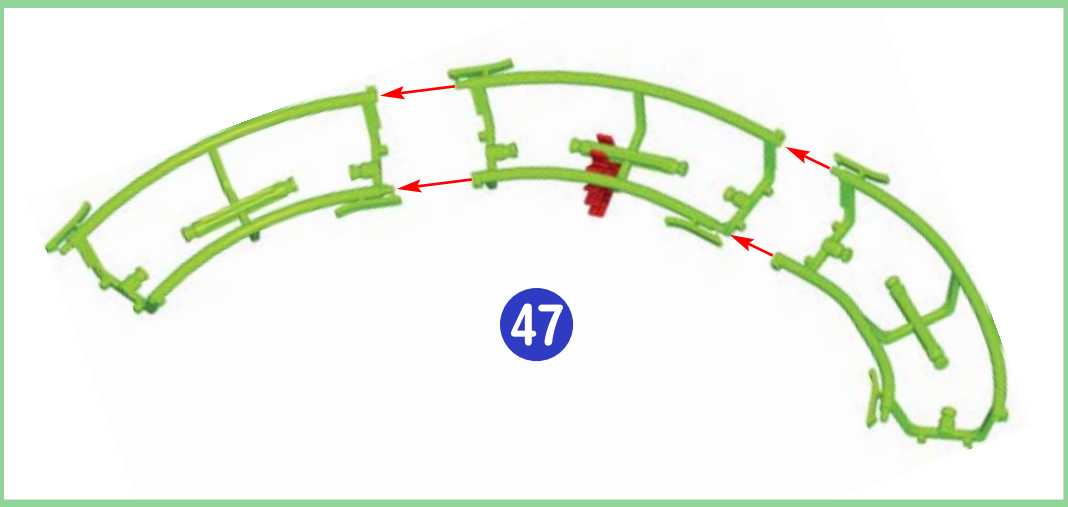

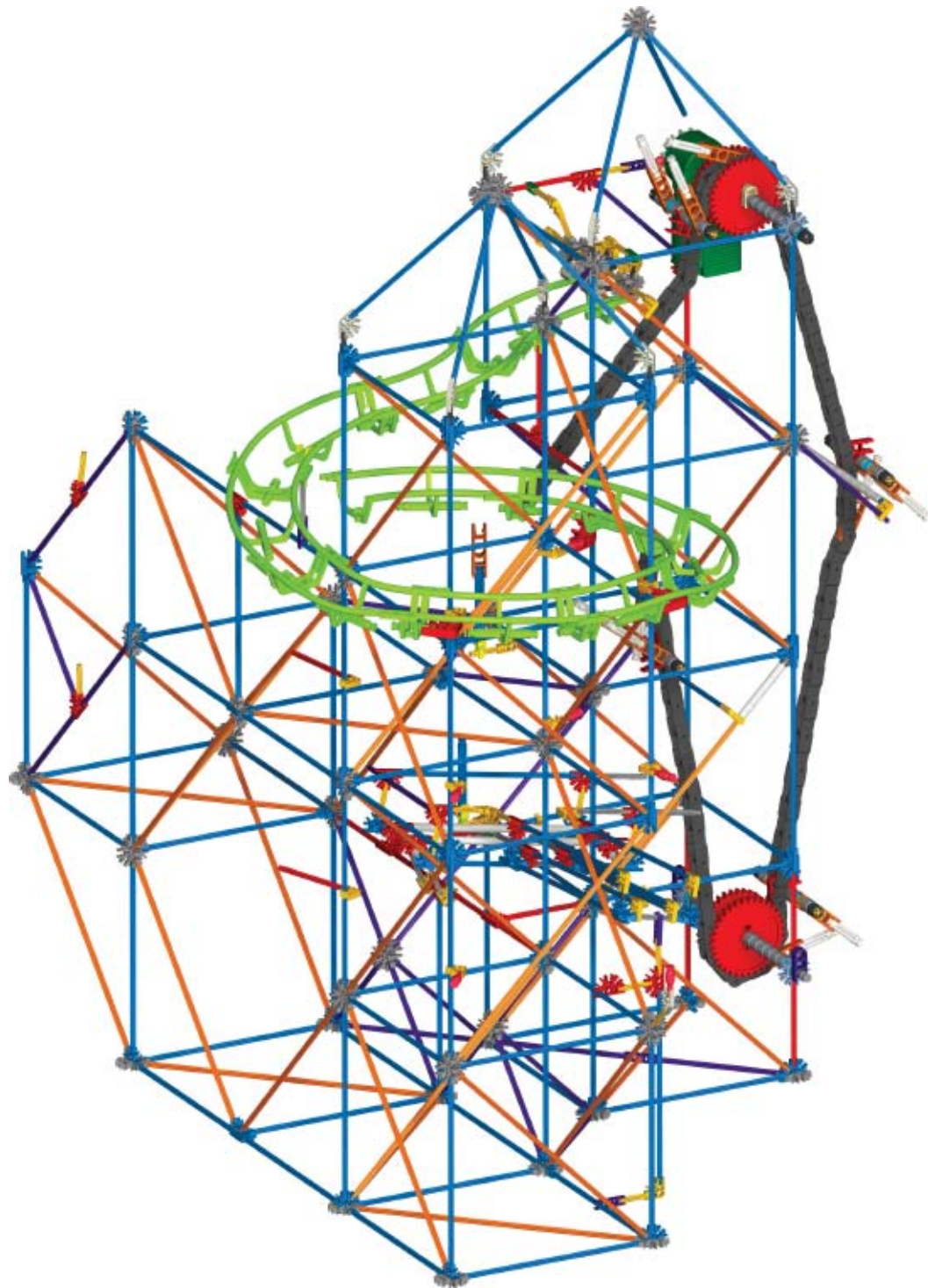

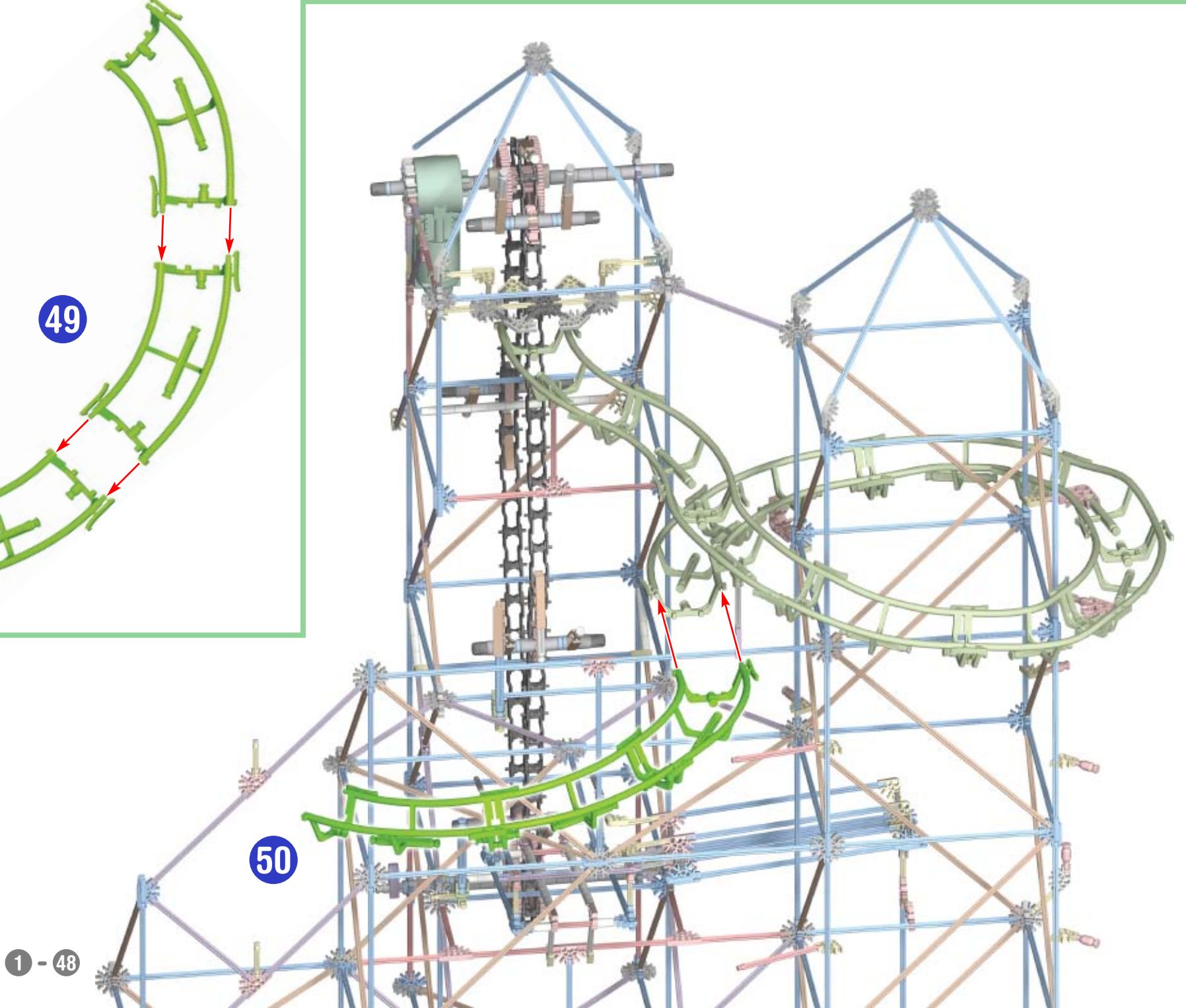
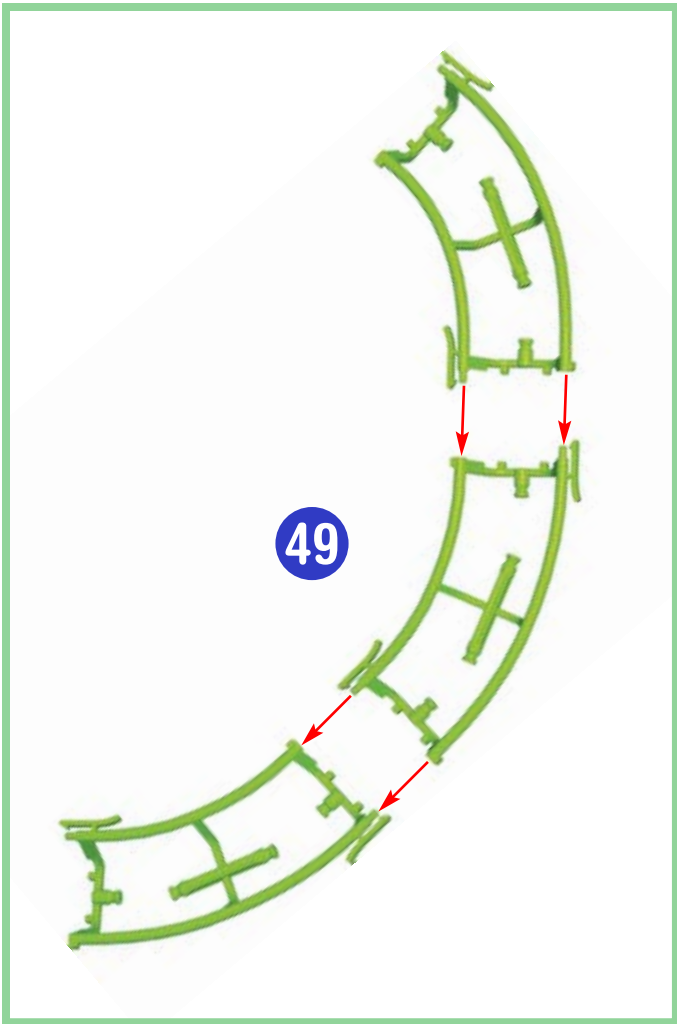

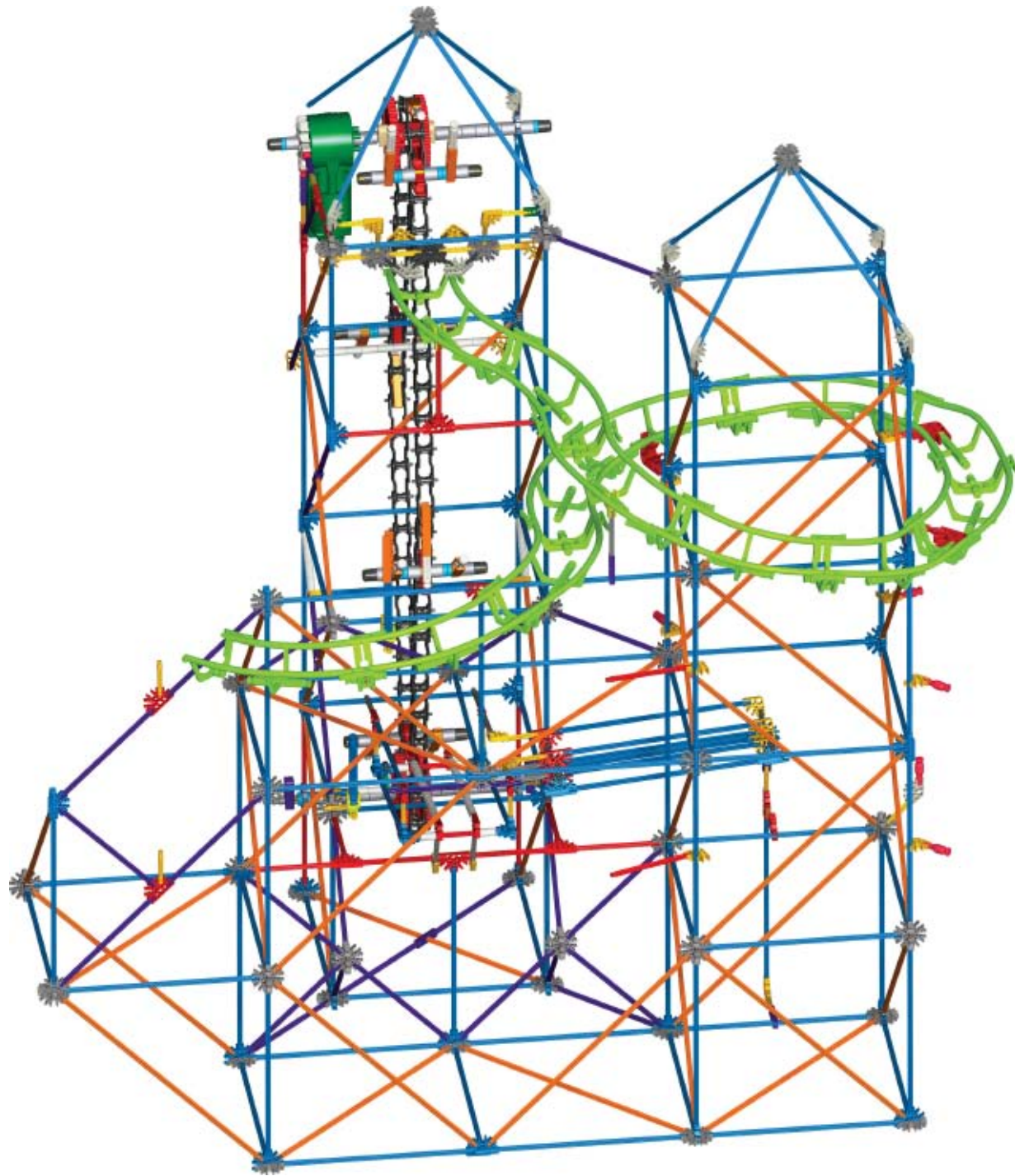

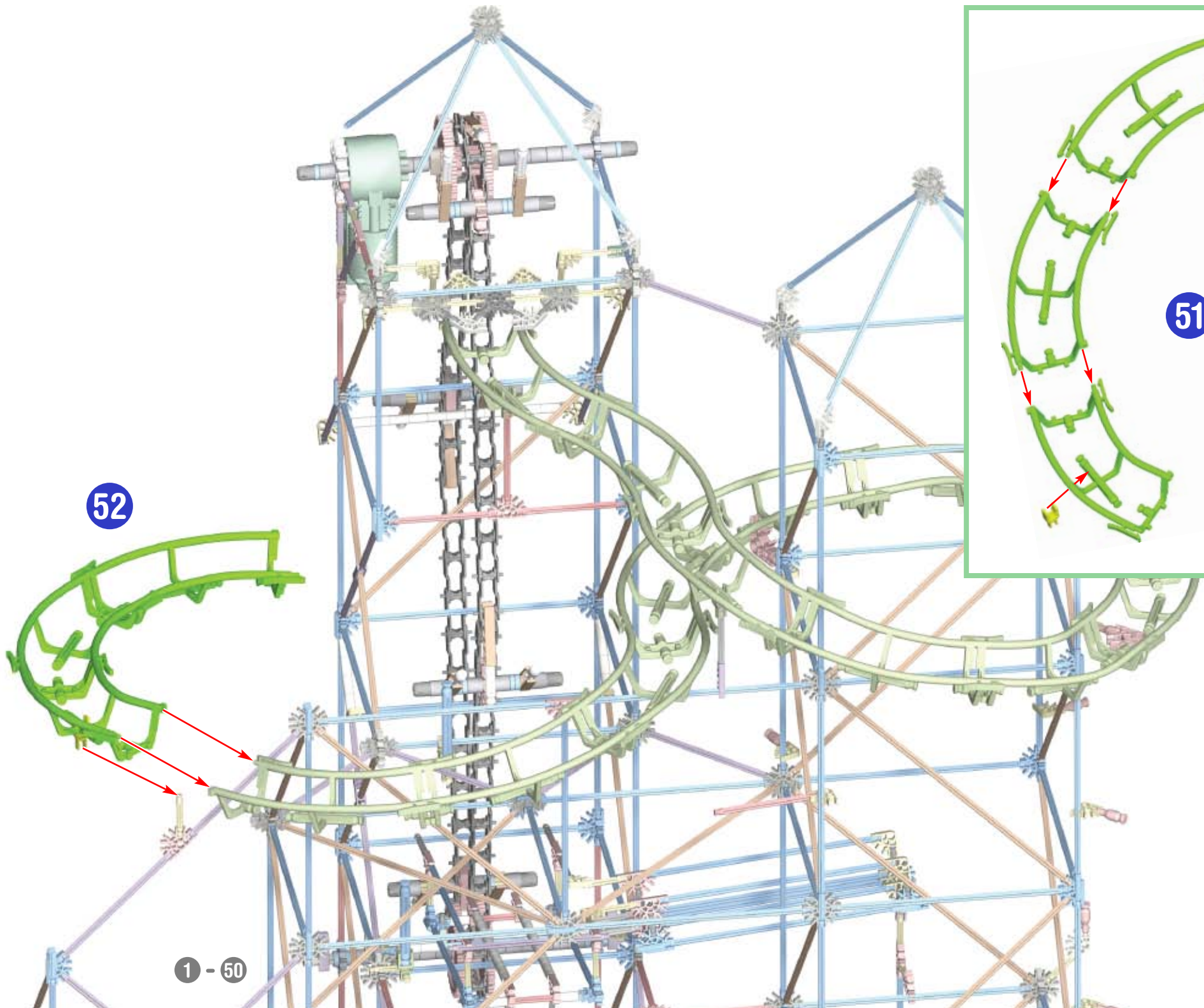

52

1 - 50

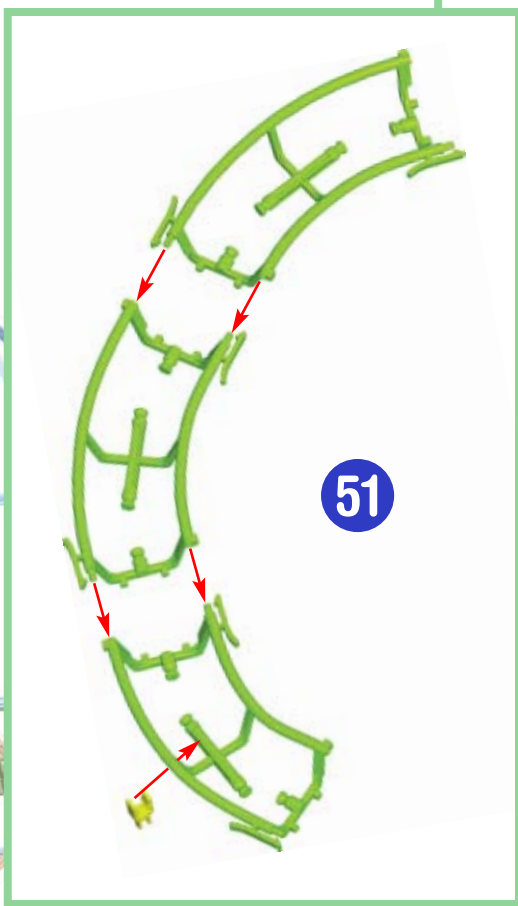

51

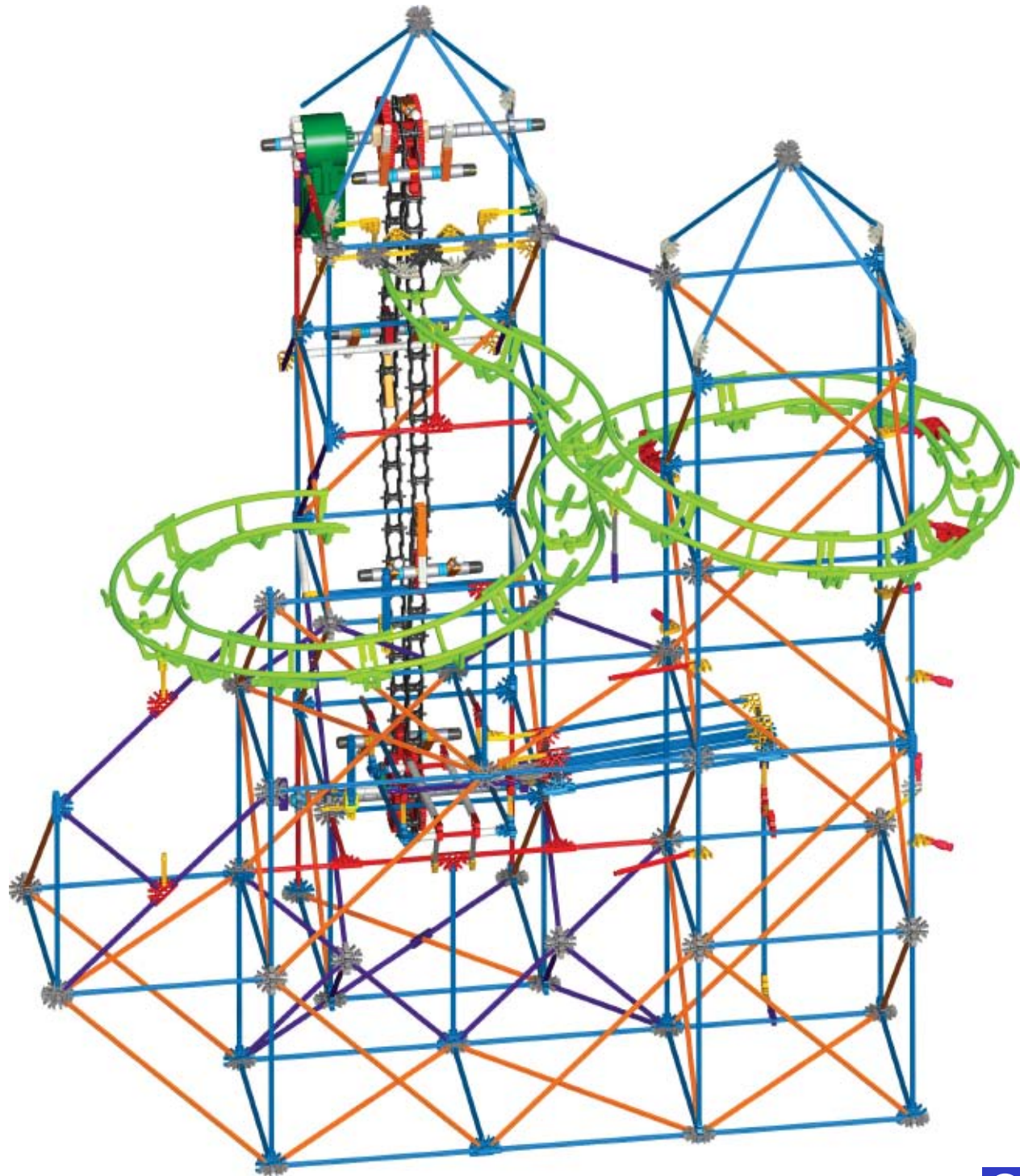

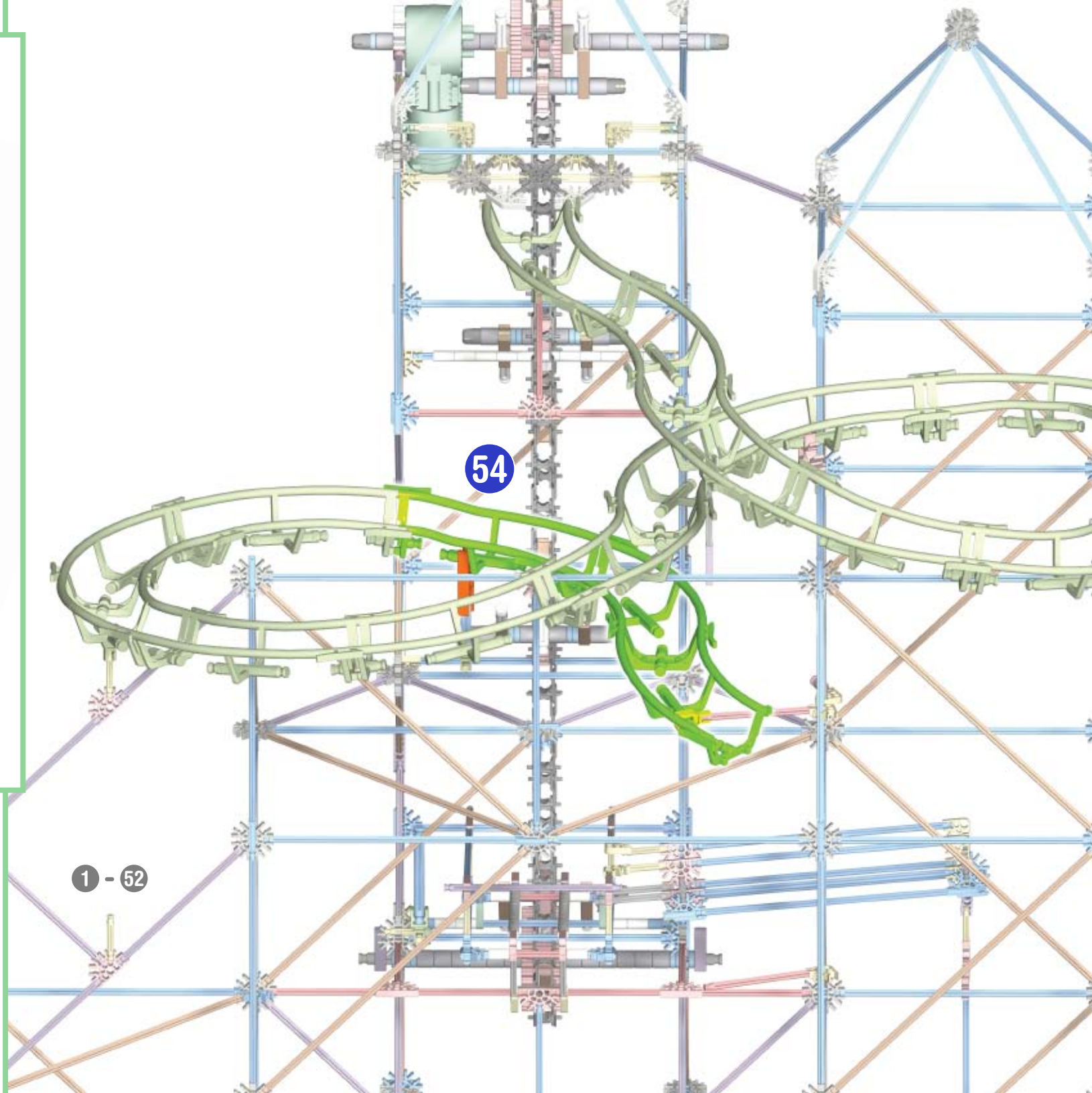
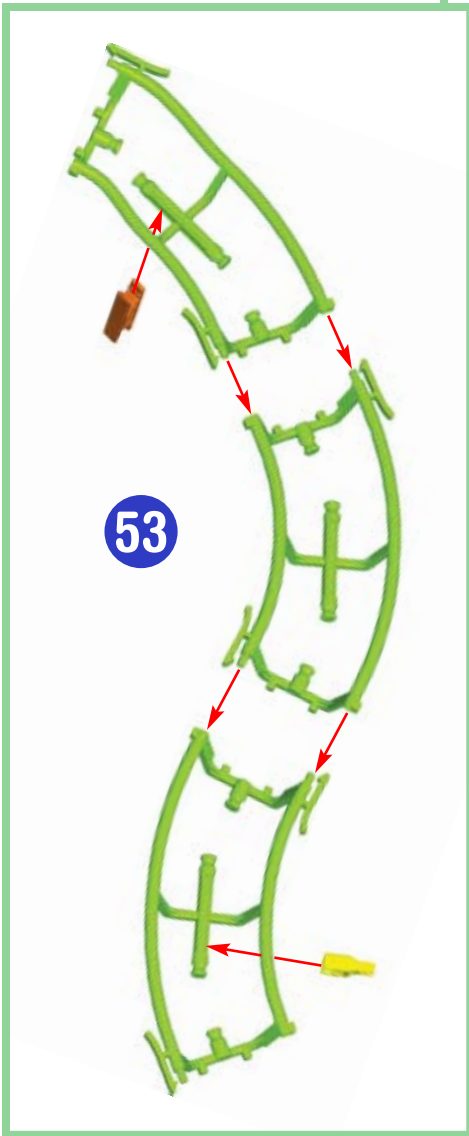

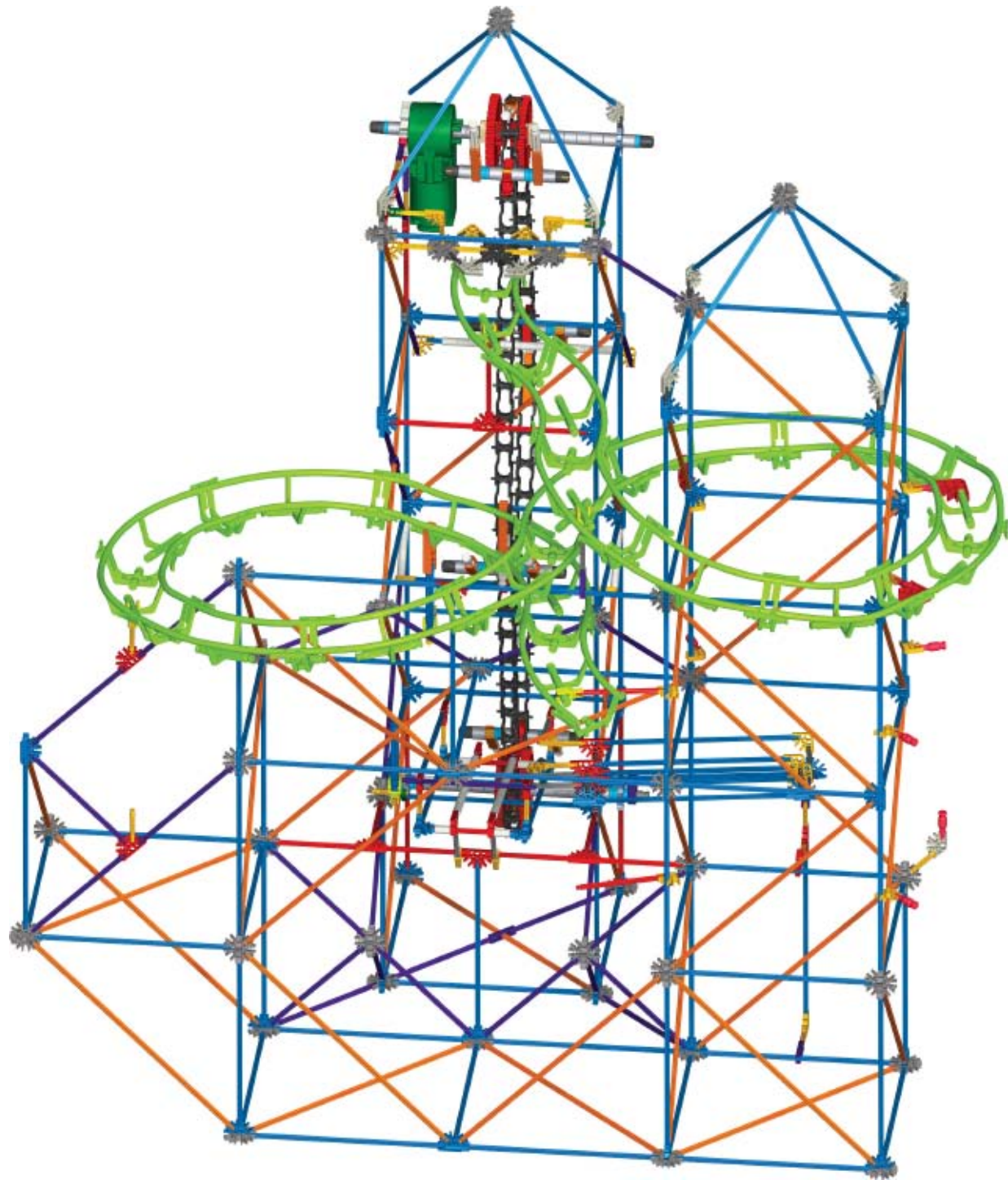

55

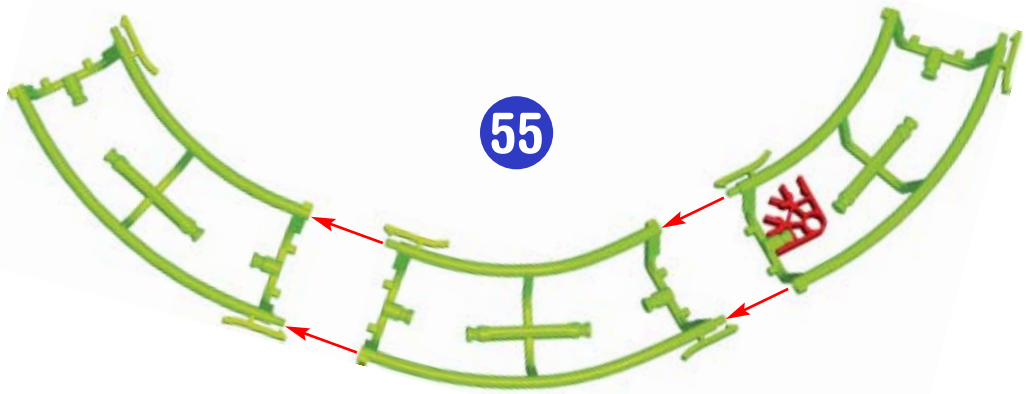

56

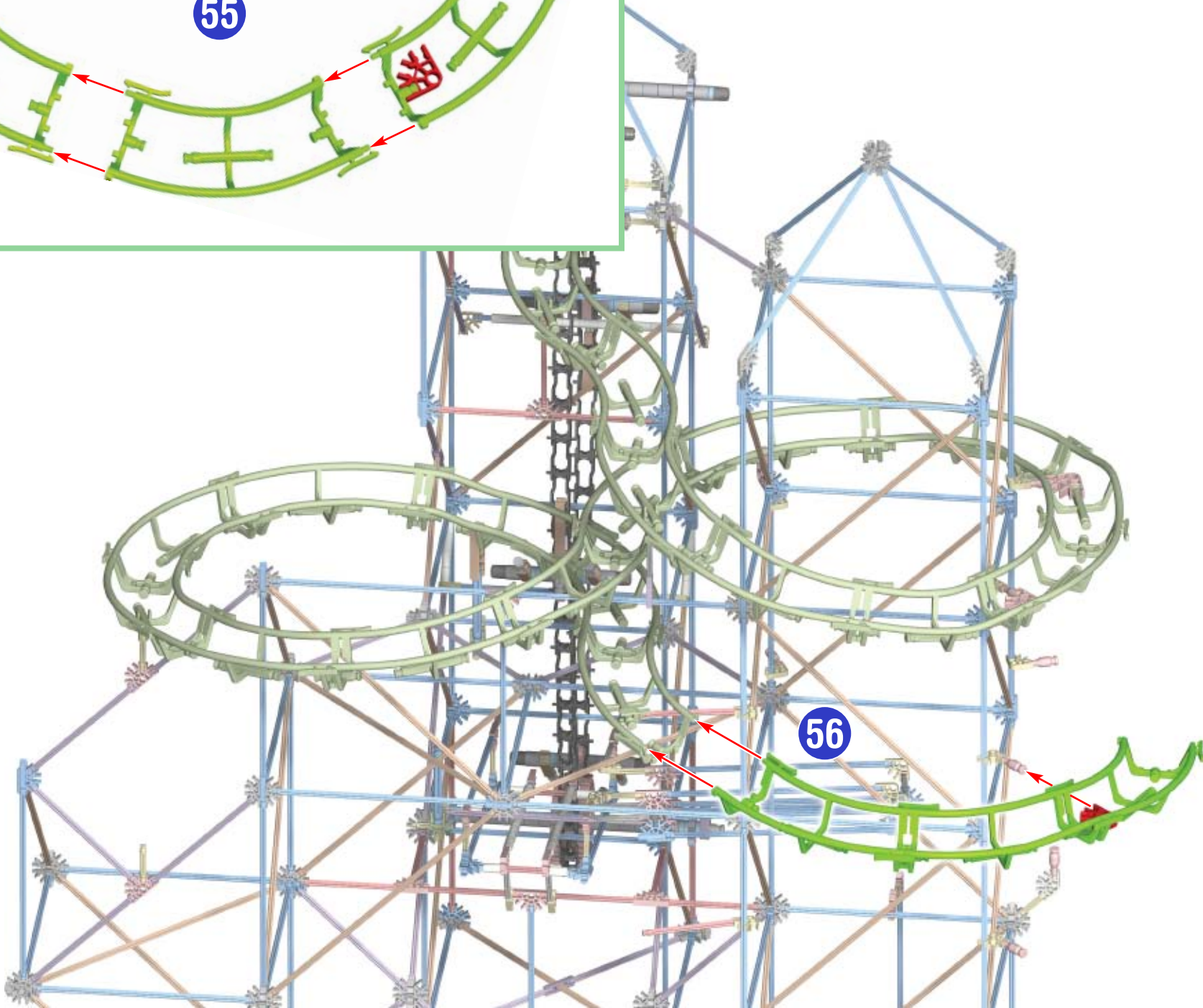

1 - 54

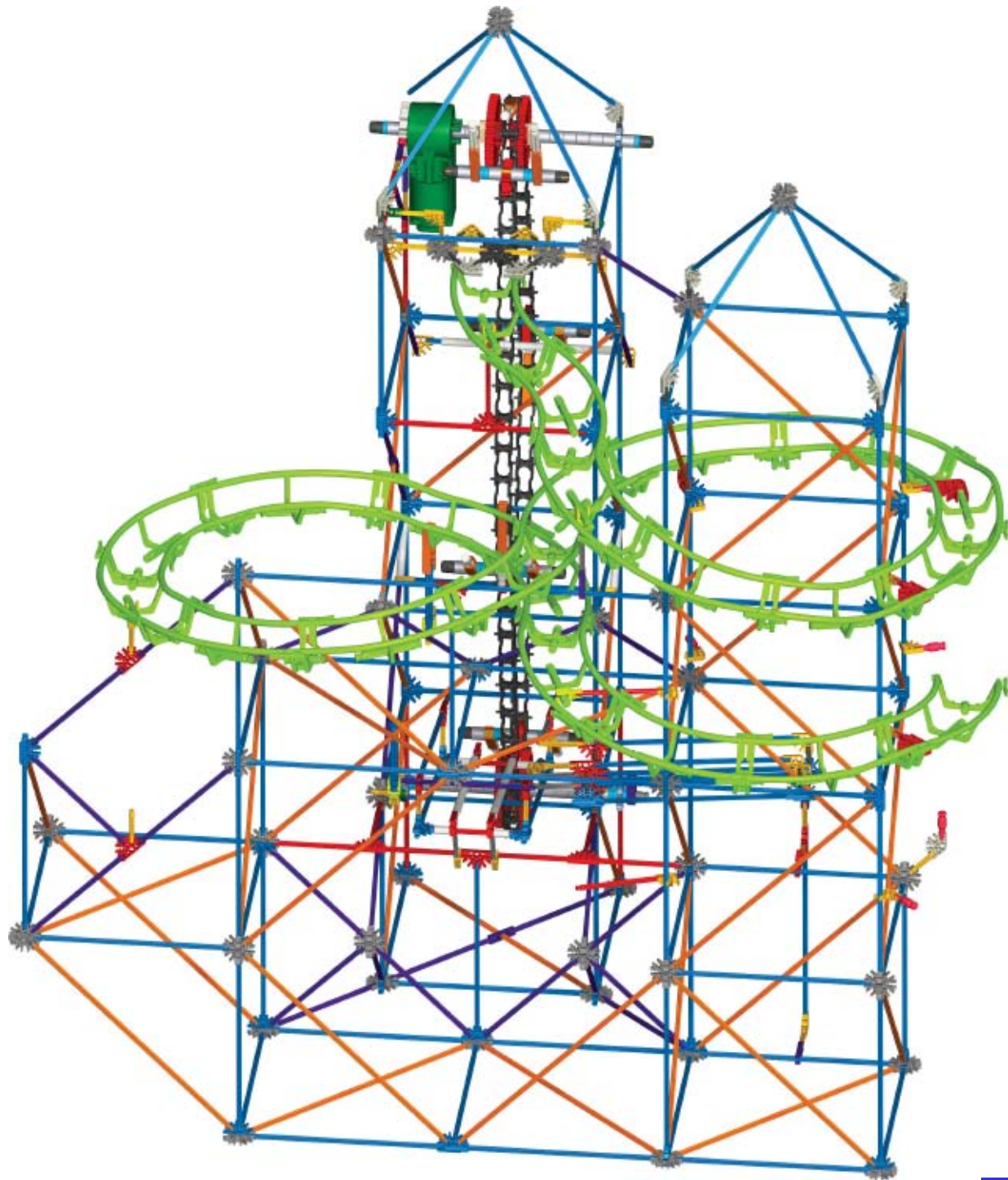

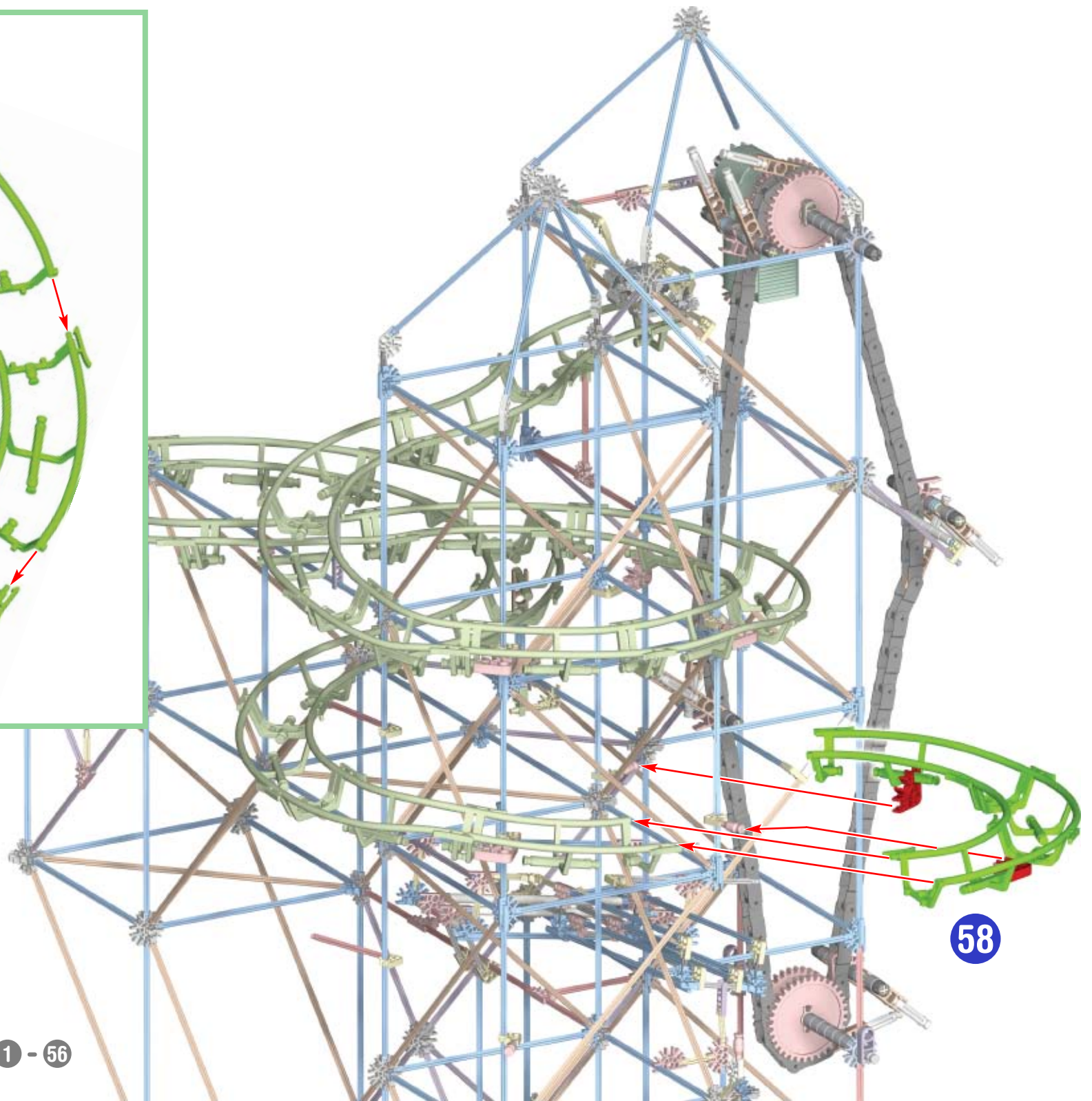
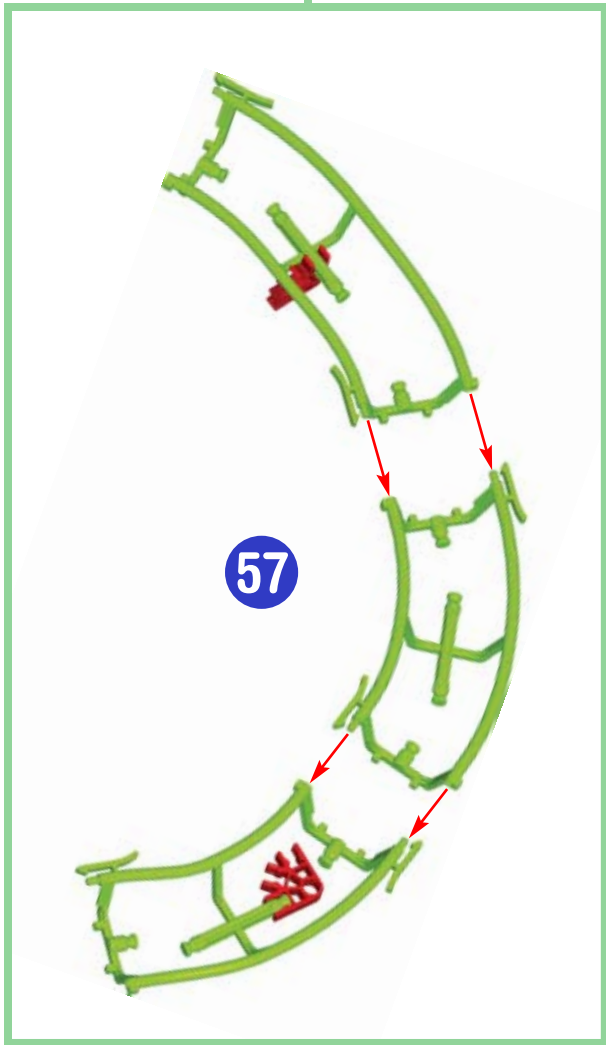

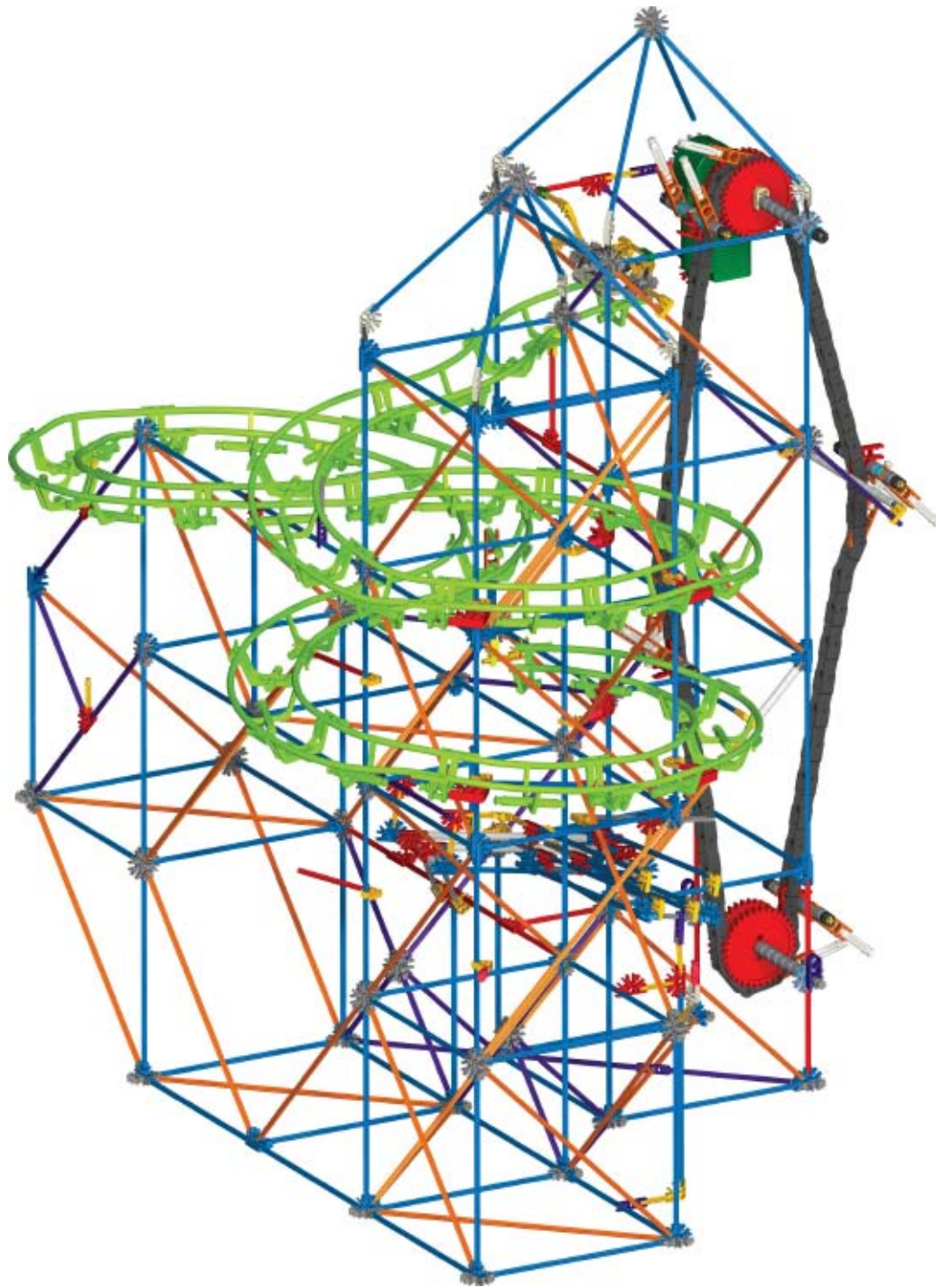

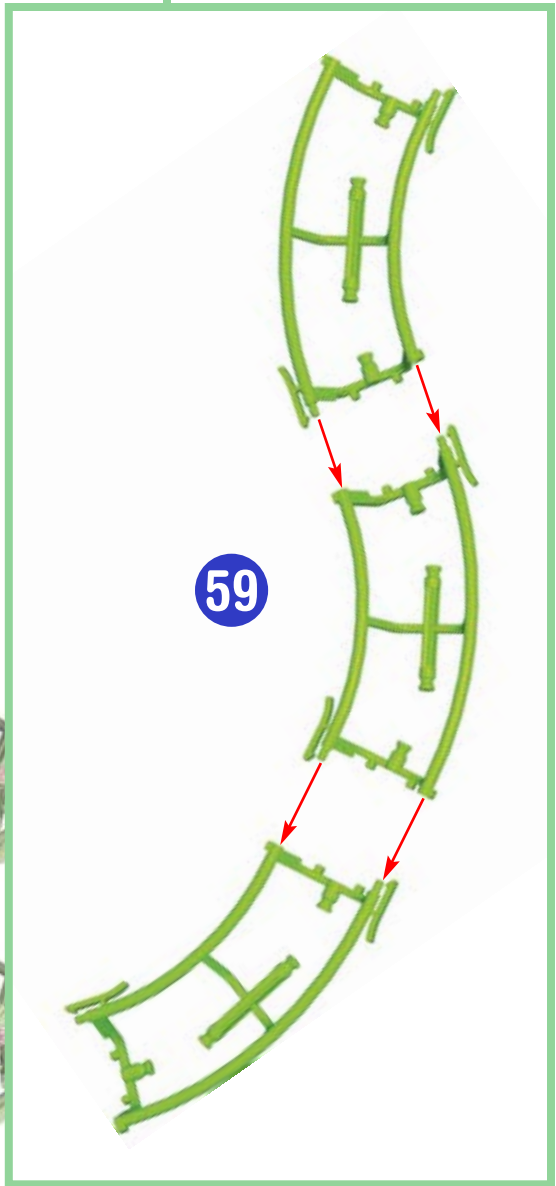
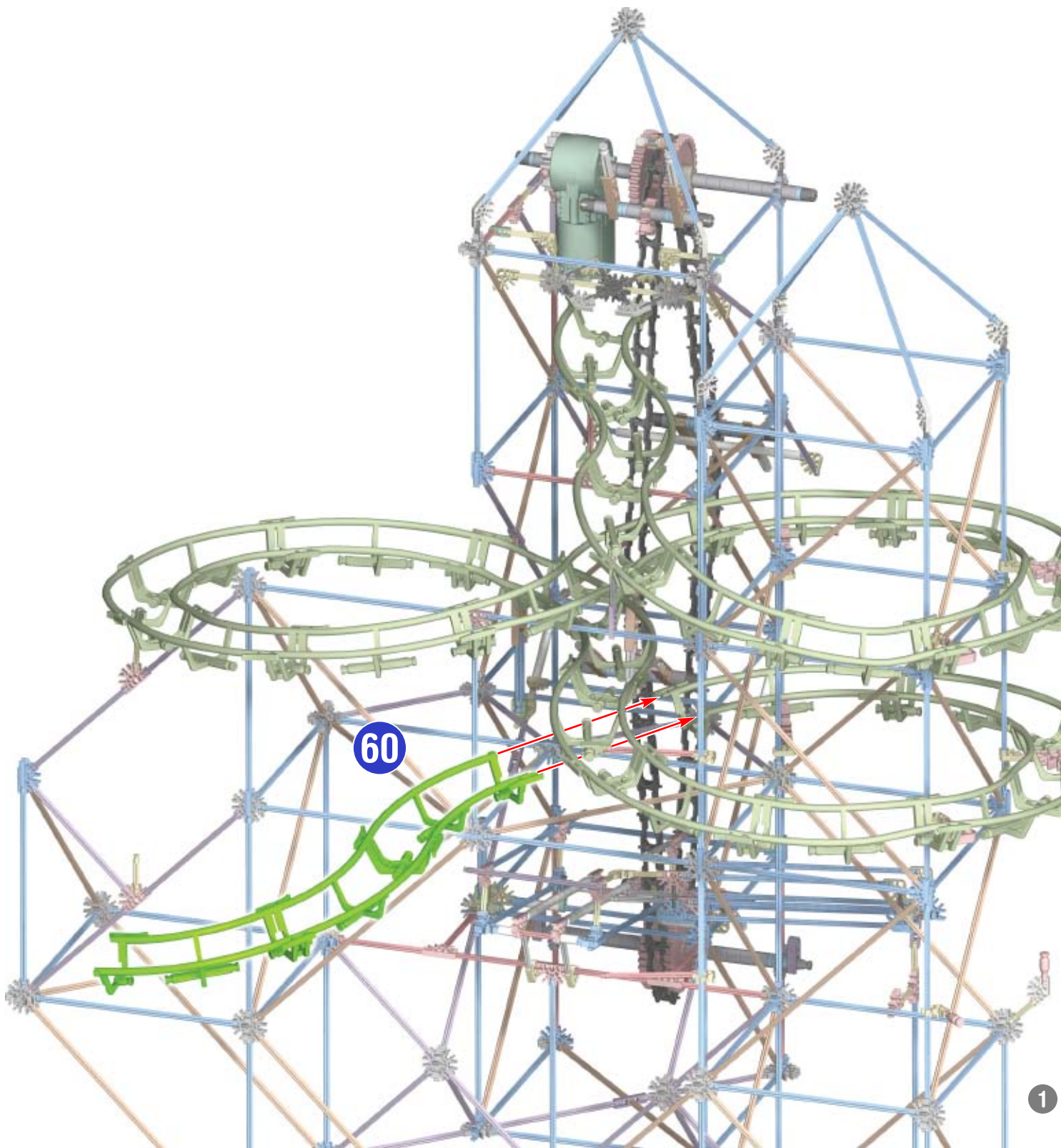

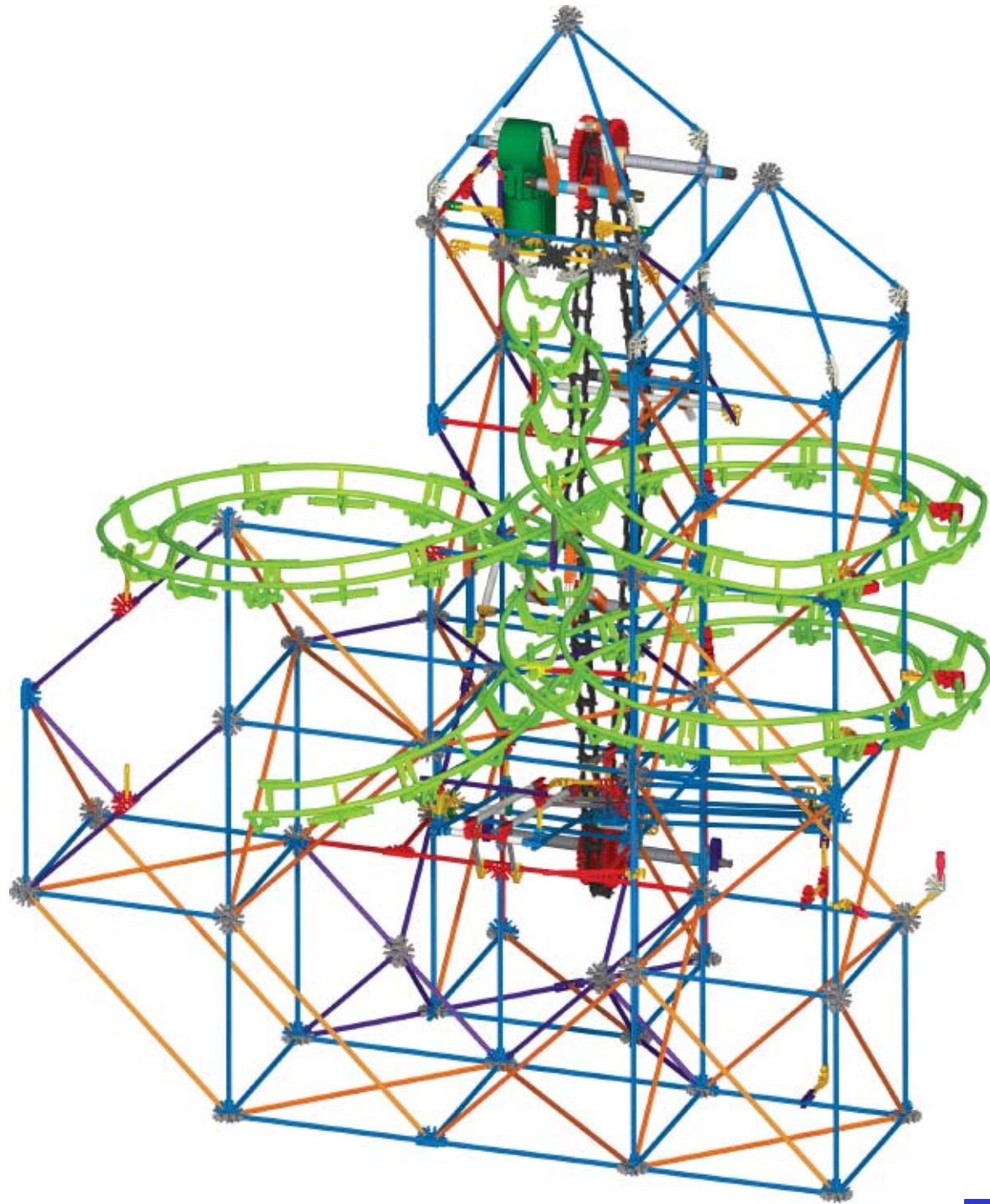

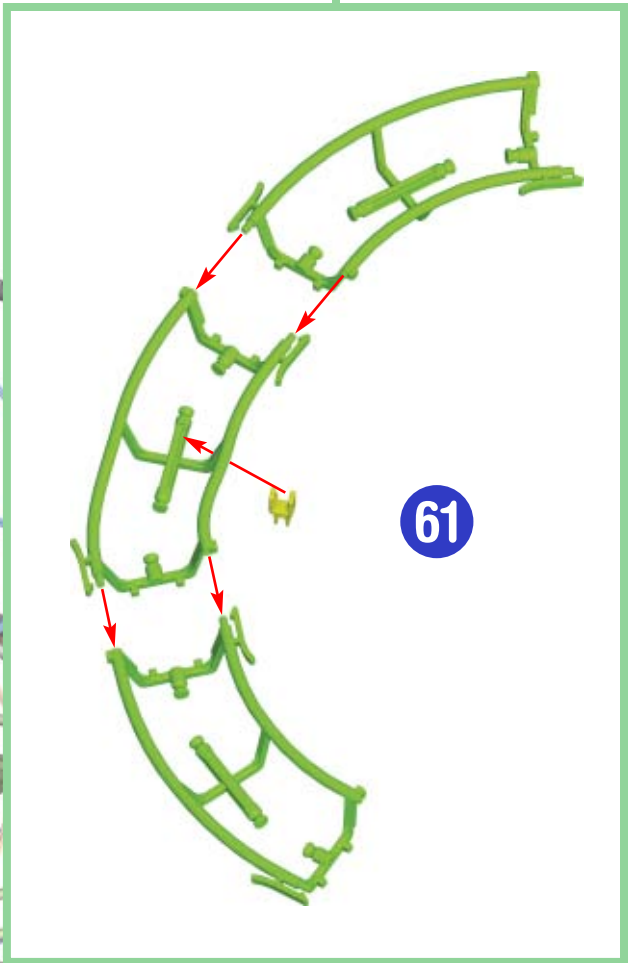
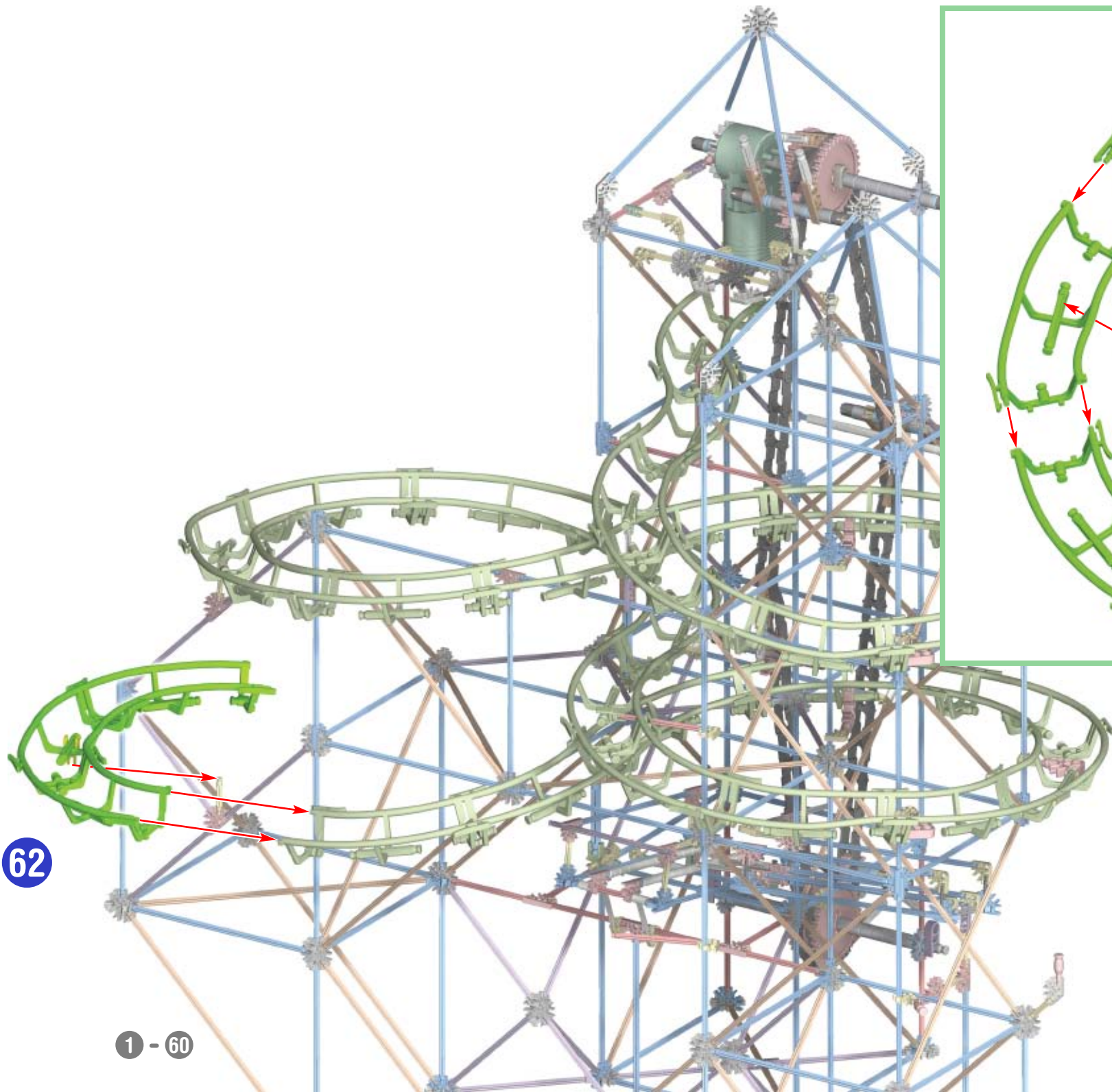

62

61

1 - 60

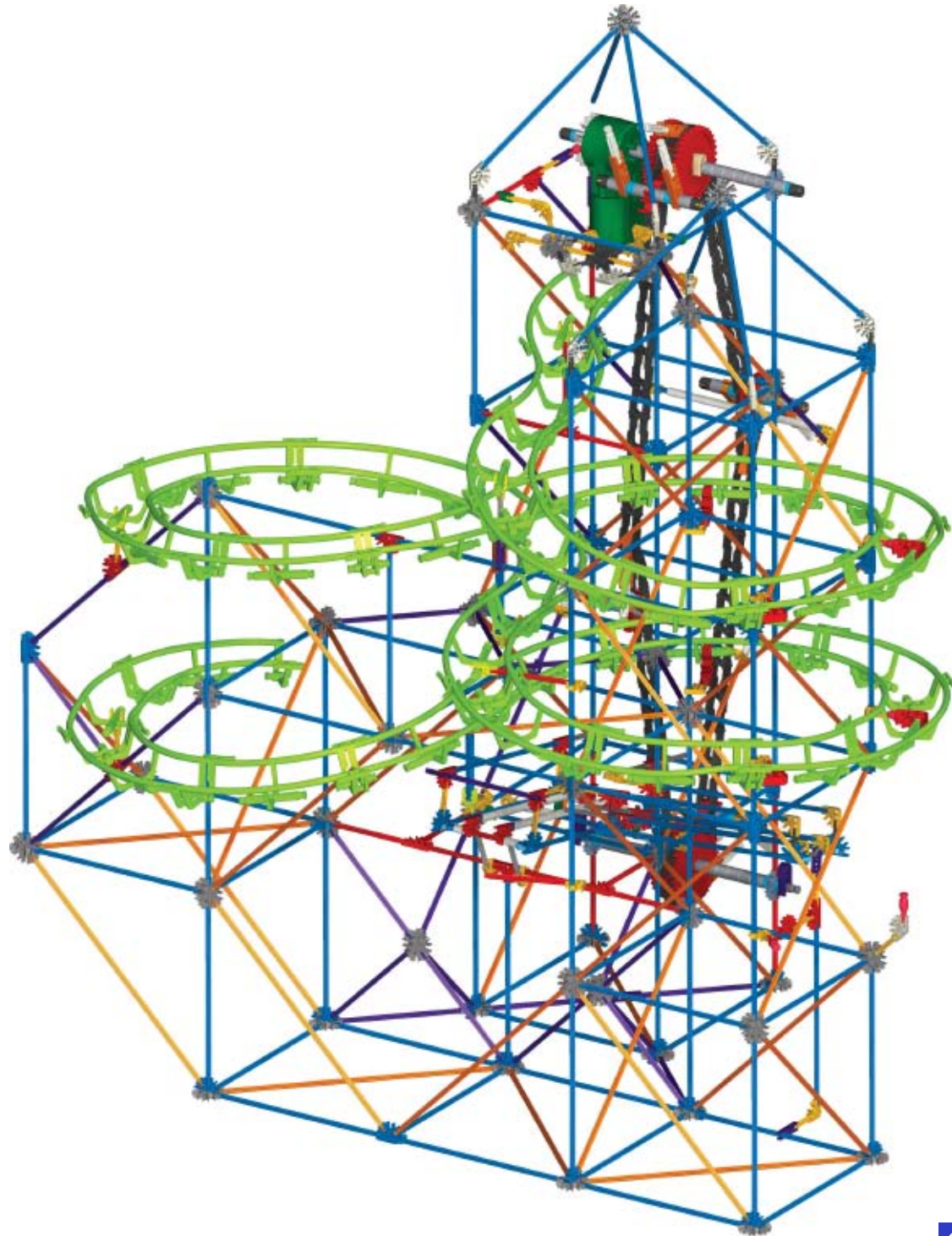

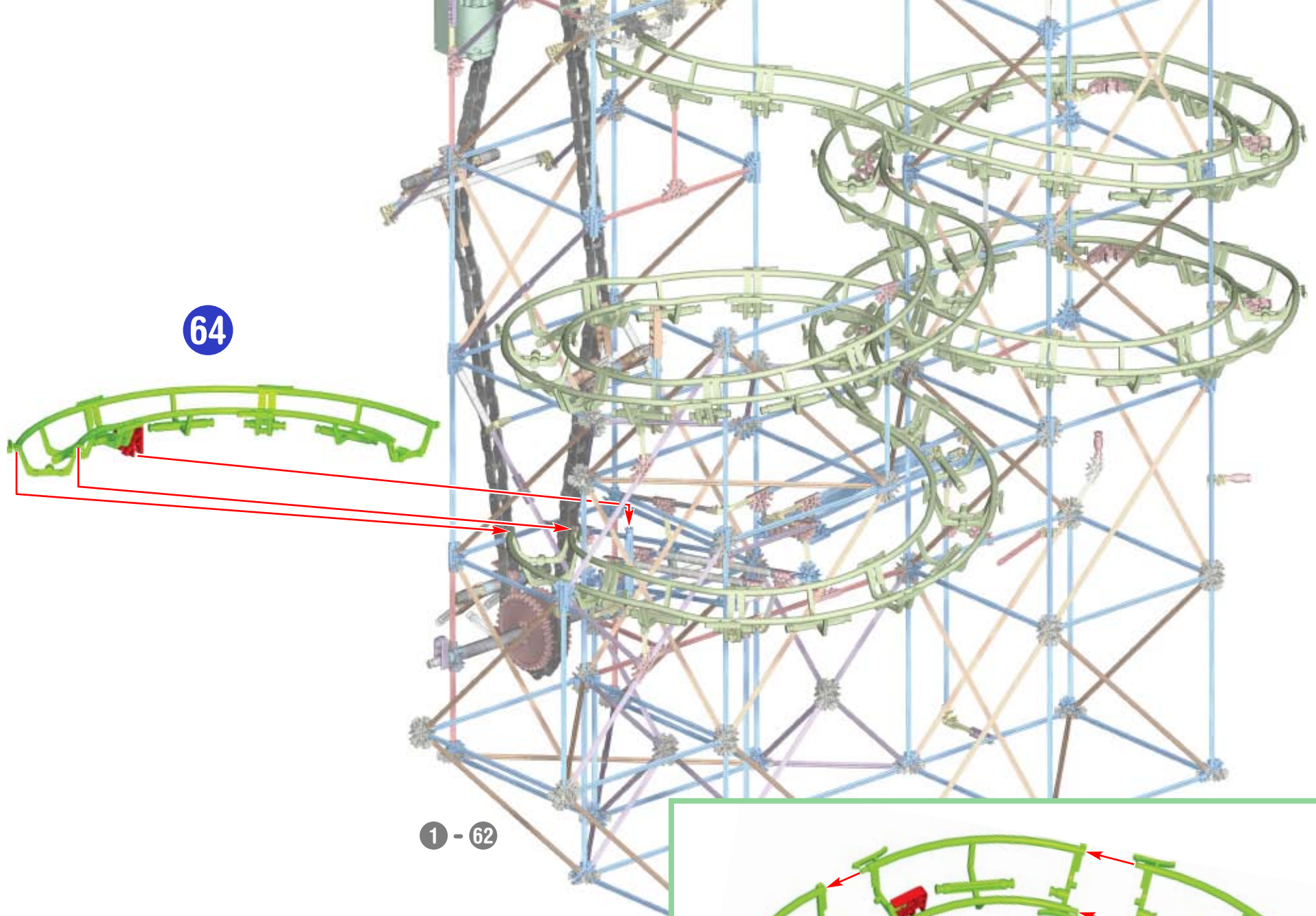

64

1 - 62

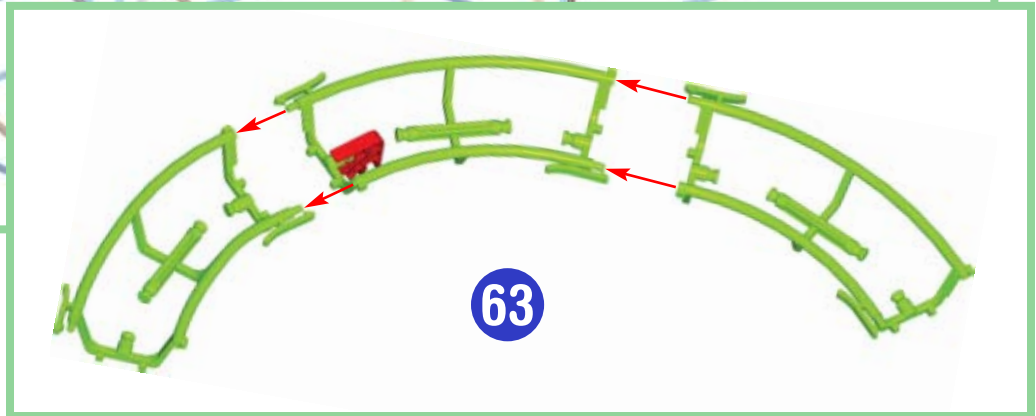

63

