



36073

K'NEX

WARNING: CHOKING HAZARD - SMALL PARTS. Not for children under 3 years.
ADVERTENCIA: PELIGRO DE ASFIXIA - PIEZAS PEQUEÑAS. No para niños menores de 3 años.
AVERTISSEMENT: DANGER D'ÉTOUFFEMENT - Pièces de petite taille. Ne convient pas aux enfants de moins de 3 ans.
WARNHINWEIS: ERSTICKUNGSGEFAHR - KLEINTEILE. Nicht geeignet für Kinder unter 3 Jahren.
AVVERTENZA: PERICOLO DI SOFFOCAMENTO - CONTIENE PICCOLE PARTI. Non adatto per bambini al di sotto di 3 anni.
AVISO: PERIGO DE SUFOCACÃO - PEÇAS PEQUENAS. Não se destina a crianças com menos de 3 anos de idade.
WAARSCHUWING: VERSTIKKINGSGEVAAR - KLEINE ONDERDELEN. Niet geschikt voor kinderen onder 3.

© 2011 K'NEX Limited Partnership Group
 P.O. Box 700
 Hatfield, PA 19440-0700
 136073-V1-06/11

CE TOMY S040 3SA England

1-800-KID-K'NEX (USA/Etats-Unis/Canada) - email@k'nex.com - http://www.k'nex.com/distributors - K'NEX is a registered trademark of K'NEX Limited Partnership Group. Product & colors may vary. Standard K'NEX parts made in the U.S.A. Special components made in China. (ES) K'NEX es una marca registrada de K'NEX Limited Partnership Group. El producto y los colores pueden variar. Piezas estándar de K'NEX hechas en EE.UU. Componentes especiales hechos en China. (FR) K'NEX est une marque déposée de K'NEX Limited Partnership Group. Produits et couleurs peuvent varier. Pièces K'NEX courantes fabriquées aux Etats-Unis. Éléments spéciaux fabriqués en Chine.

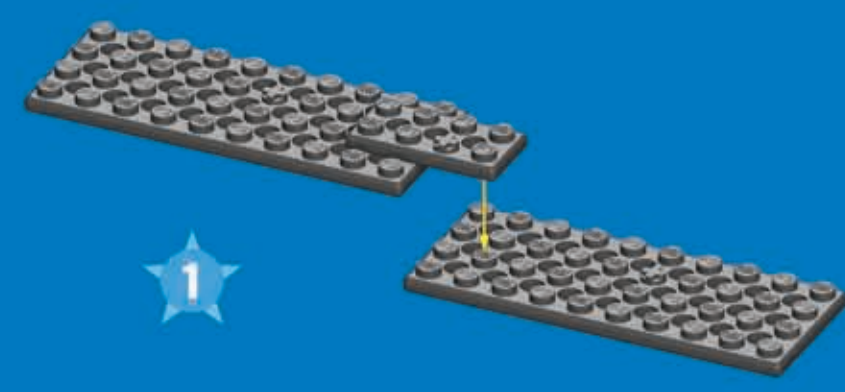

1

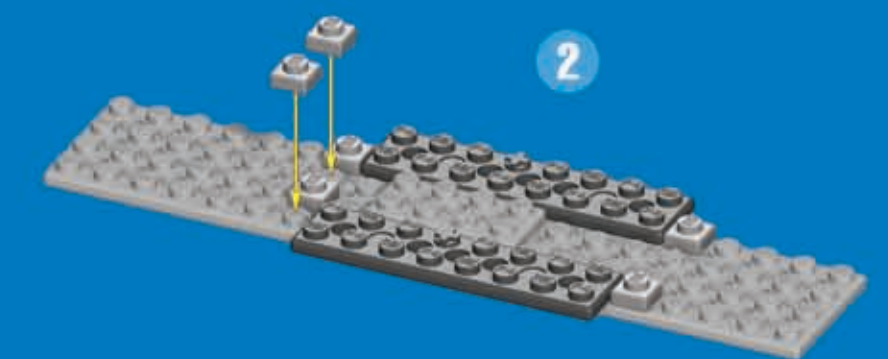

2

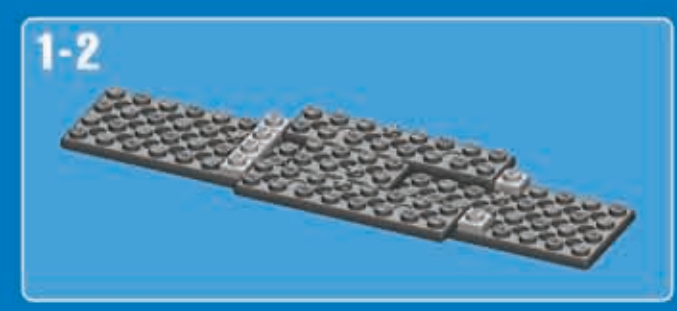

1-2

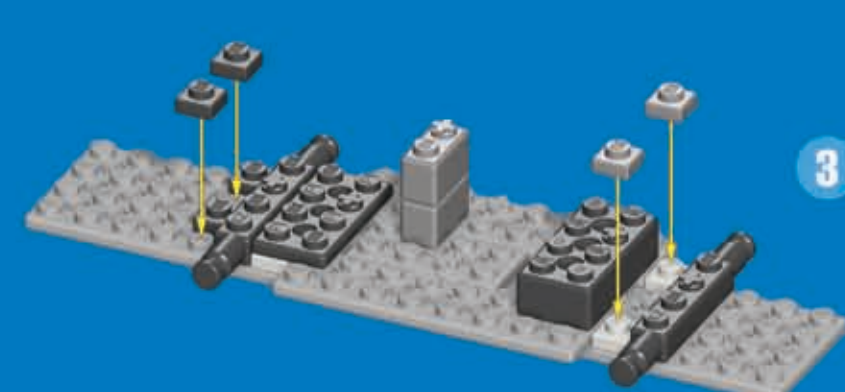

3

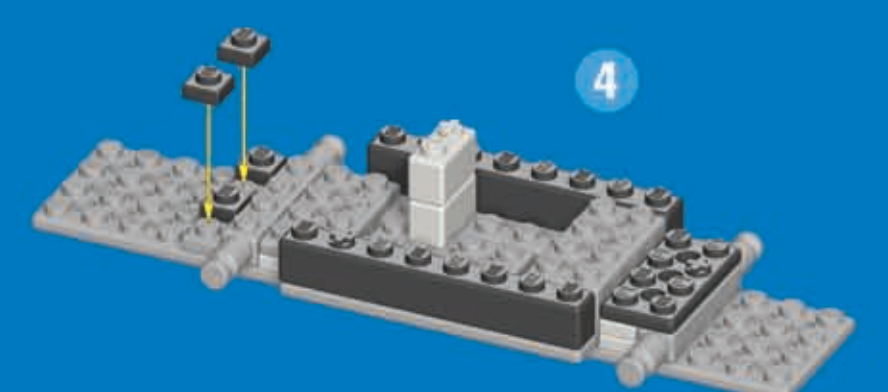

4



1-4

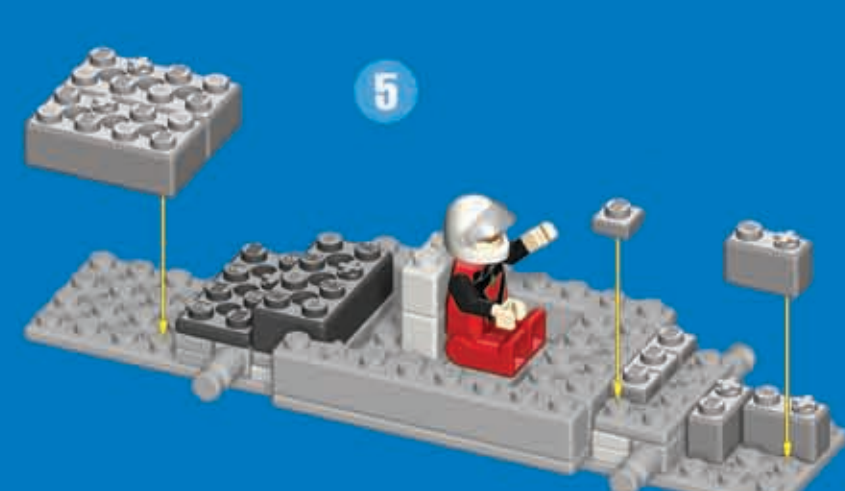

5

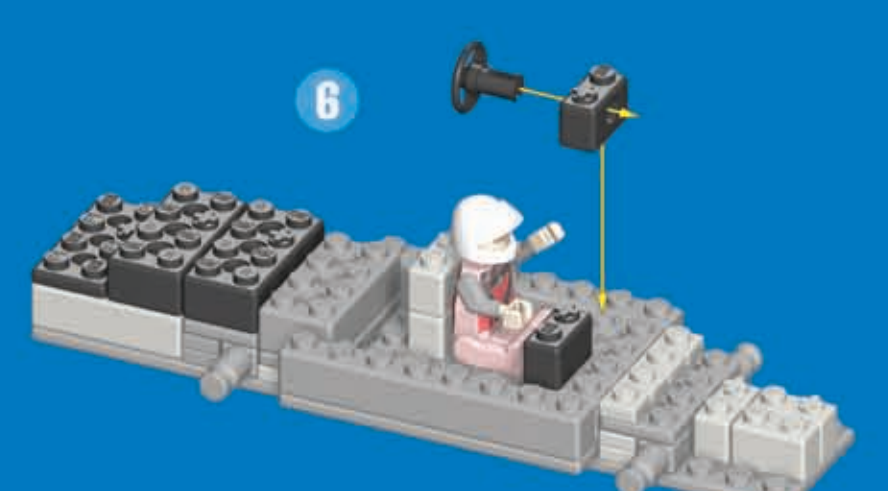

6



1-6

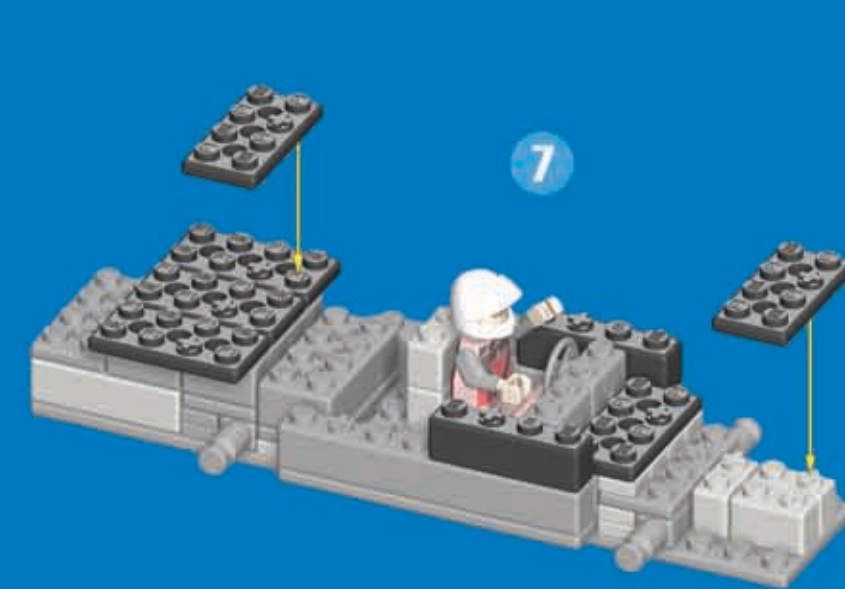

7

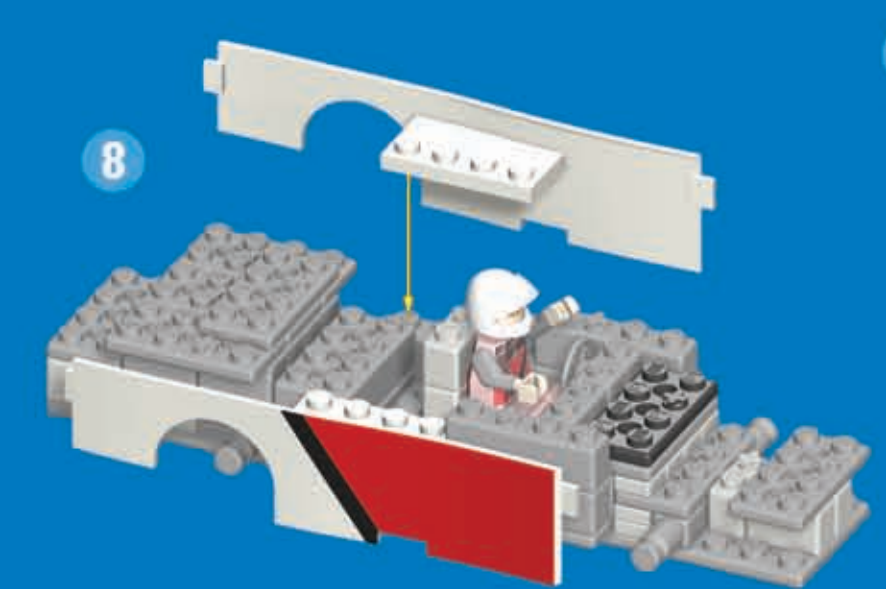

8

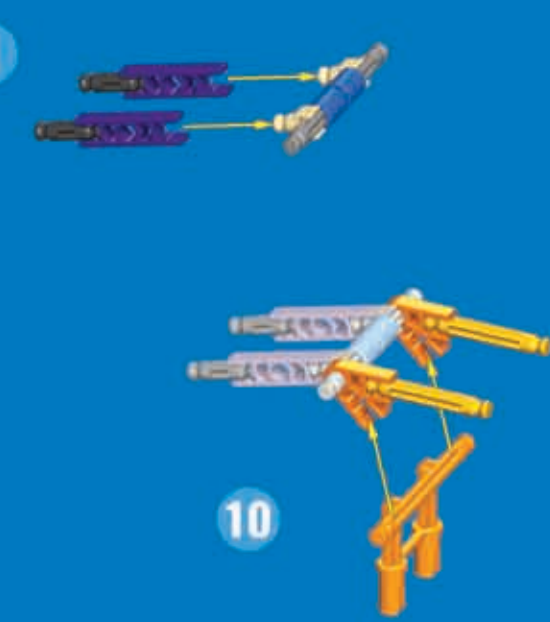

9

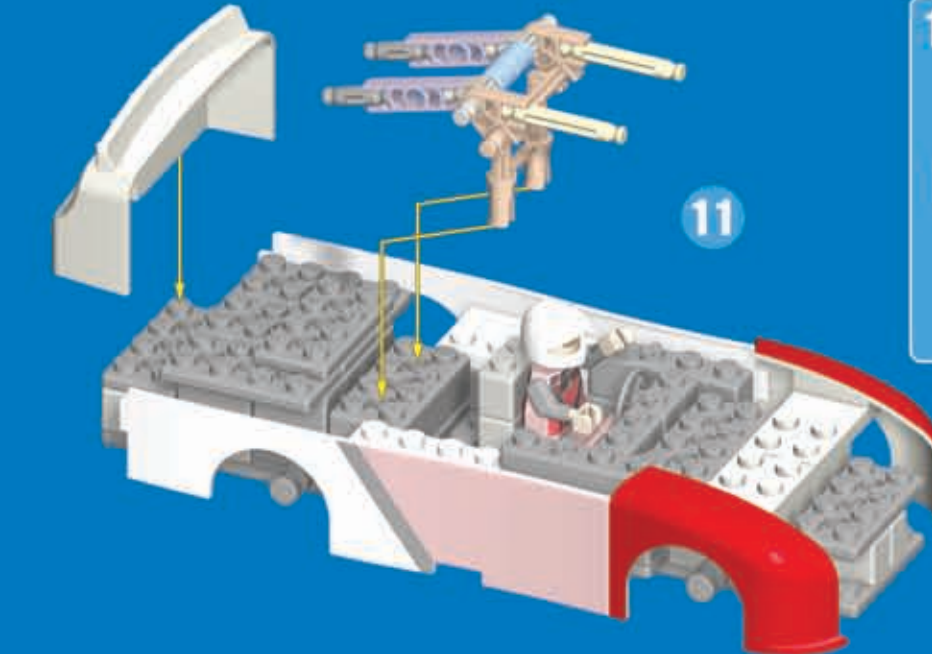

11

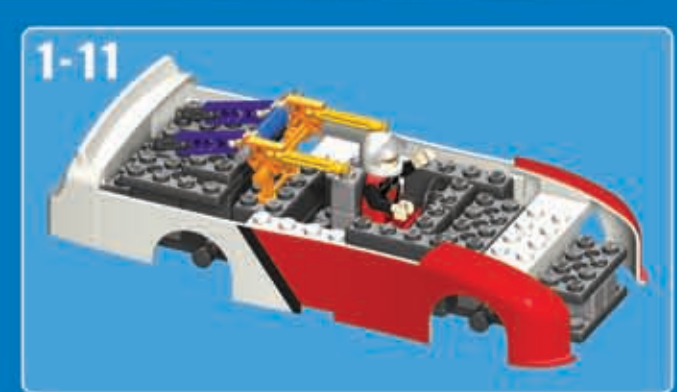

1-11

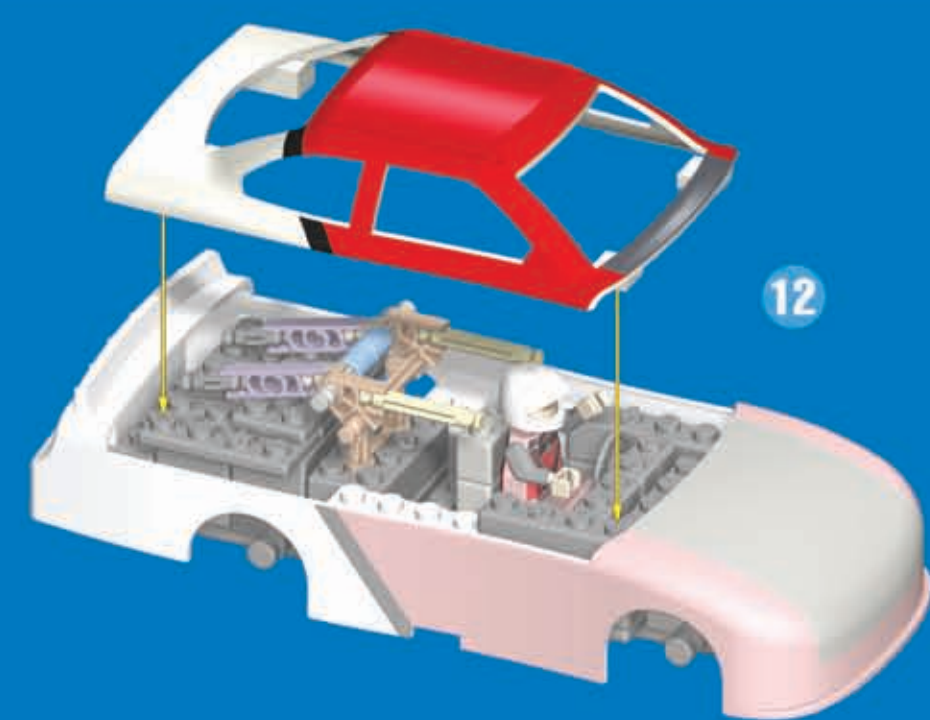

12



13



1-13

Collect all of these NASCAR® Building Sets by K'NEX!
 ¡Recoja todos de estos NASCAR® juguetes de construcción por K'NEX!
 Rassemblez tous ces ensembles de construction de NASCAR® par K'NEX!

Sold separately. Some sets may not be available in all markets.
 Vendus séparément. Certains produits ne sont pas disponibles pour tous les marchés.
 Se venden por separado. Algunos productos no pueden estar disponibles en todos los mercados.

The name, likeness and signature of Scott Stecker and the likeness of the #22 Canadian Tire Dodge Charger are used with the permission of 22 Racing and Scott Stecker. NASCAR® is a registered trademark of the National Association for Stock Car Auto Racing, Inc.

Le nom, la similitude et la signature de Scott Stecker et la similitude du #22 Canadian Tire Dodge Charger sont employés avec la permission de 22 Racing. NASCAR® est une marque déposée de National Association for Stock Car Auto Racing, Inc.

El nombre, la semejanza y la firma de Scott Stecker y la semejanza del #22 Canadian Tire Dodge Charger se utilizan con el permiso del Scott Stecker y 22 Racing. NASCAR® es una marca registrada de National Association for Stock Car Auto Racing, Inc.

Identifies Genuine K'NEX Bricks.
 Identifica los ladrillos genuinos de K'NEX.
 Identifie que ce sont d'authentiques briques K'NEX.
 Identifiziert echte K'NEX-Bausteine.
 Edentifica i veri blocchi K'NEX.
 Identifica que são cubos genuínos da K'NEX.
 Identificeert K'NEX bakstenen voor.

22



Follow these pictures when you are ready to put the stickers on the car.

Utilisez ces graphiques quand vous êtes prêts à appuyer sur ces designs sur votre modèle.

Use estos cuadros cuando usted está listo a presionar estos diseños a los lados del modelo.



Parts List.
Liste des pièces.
Lista de piezas.

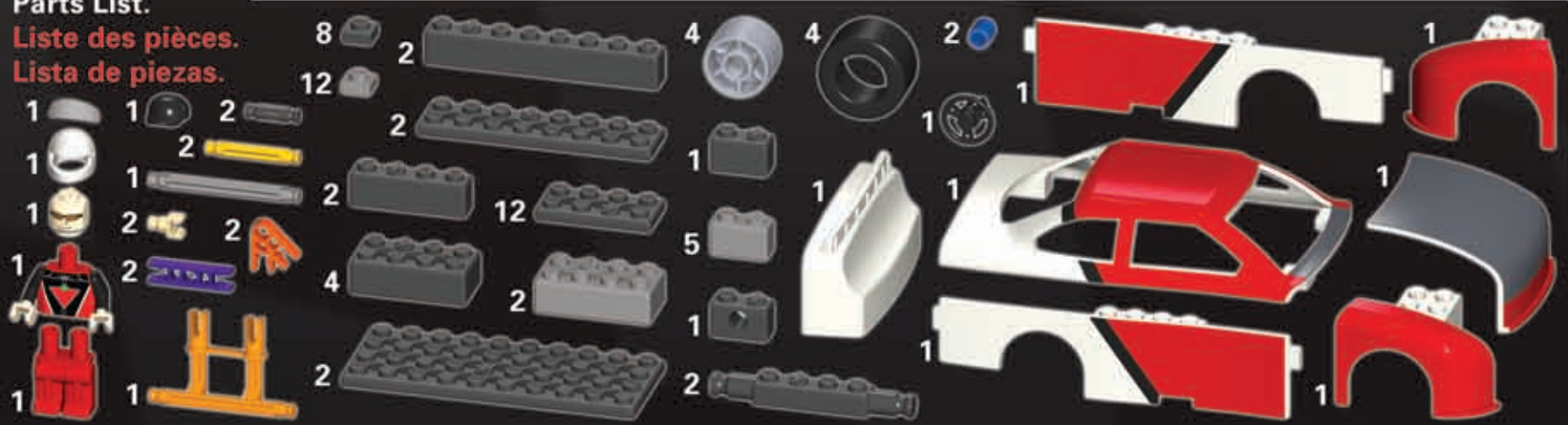

KNEX.COM

For building help, updates to instructions or other great building ideas log on to www.knex.com/racing.

Pour l'aide, les mises à jour aux instructions ou à d'autres jouets vont à www.knex.com/racing.

Para la ayuda, las actualizaciones a instrucciones u otros juguetes van a www.knex.com/racing.

